

COMPANY PROFILE



D.H.C.

DAE HAN CONTROL CO., LTD.

ADDRESS : 39, GADAL 1-RO, GANGSEO-GU, BUSAN, KOREA

T E L : +82-51-974-1221

F A X : +82-51-955-6041

HOMEPAGE : www.dhcv.co.kr

E - MAIL : dhc@dhcv.co.kr

Index

*DAEHAN CONTROL
CO.,LTD.*

- 01. ABOUT DHC
- 02. PRODUCTION & BUSINESS SCOPE
- 03. PROJECT MANAGEMENT
- 04. DESIGN & DEVELOPMENT
- 05. MANUFACTURING & QUALITY
- 06. PRODUCTS FOR VARIOUS APPLICATION
- 07. LIST OF CERTIFICATES
- 08. SUB-CONTRACTORS
- 09. INSTALLATION AT SITE
- 10. SUPPLY RECORDS
(DOMESTIC/OVERSEAS)





CHAPTER 01.

ABOUT DAEHAN CONTROL CO., LTD.

DAEHAN CONTROL CO., LTD.

01 ABOUT DAEHAN CONTROL CO., LTD.

Chapter.

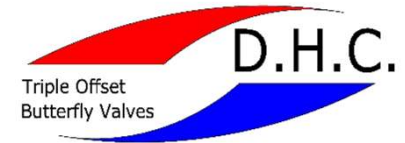

• 1995 Established DAEHAN CONTROL.

• 1998 - Started manufacturing Triple Offset Butterfly and Check Valves.

• 2000 - Incorporated the Company, DAEHAN CONTROL Co., Ltd.
- ISO9001
Quality Management System Approved

• 2002 - Started Producing Special Valves.

• 2005 - Registered Vendor List on KEPCO / POSCO / KHNP.

• 2006 - Moved into Current Address at #1207-13, Jisa-Dong, Gangseo-Gu, Busan

• 2007 - Registered Vendor List on POSCO
- Fire Safety Test Certificate Approved

• 2008 - CE Certificate Approved

• 2009 - Patent for Gate valve and Aqua seal valve
- VENDOR APPROVAL : PETRONAS
The America Water Resources Co.

• 2010 - ISO14001
Environmental Management System Approved

• 2012 - Registered Vendor to HDEC, GS con.

• 2013 - Fire Test Certificate Approved

• 2014 - NSF 61 Approved
- API 609, API 6D Approved

• 2015 - Registered Vendor to HYUNDAI STEEL,
National Iranian Oil Company (NIOC)
- ISO18001
OHS Management System Approved

• 2016 - Moved to New DHC Factory.
#39, Gadal 1-Ro, Gangseo-Gu, Busan, Korea

• 2017 - Registered Vendor to ADGAS / MHPS / KOSPO / KOWEPO / KOMIPO / EWP / KOSEP

01 ABOUT DHC – VENDOR REGISTRATION

Chapter.

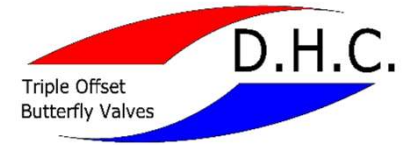

KOREA SOUTH-EAST POWER



KDHC



KOREA SOUTHERN POWER



National Iranian Oil Company



PETRONAS



KEPCO KPS



DOOSAN HEAVY IND.



HANJIN HEAVY IND.



San Diego County Water Authority



Santa Clara Valley Water District



GS E&C



POSCO E&C



HYUNDAI E&C



PDVSA



MHPS



SK E&C



SAMSUNG ENG.



HYUNDAI STEEL



Saudi Aramco Total Refining & Petrochemical



ADGAS

01 ABOUT DHC – COMPANY INFORMATION

Chapter.

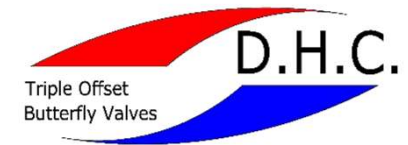

a) Factory Size : 6,855 m²

Head Office and Factory

6,855 m²

b) Personnel : Total 38 Persons

C.E.O

1 person

General Administration Dept.

3 persons

Sales & MKT Dept.

Domestic

4 persons

Overseas

3 persons

Production Dept.

Production

15 persons

Procurement

3 persons

Engineering Dept.

Design & R&D

4 persons

QC & QA Dept.

Inspection & Quality Control

5 persons

01 ABOUT DHC – ORGANIZATION

Chapter.

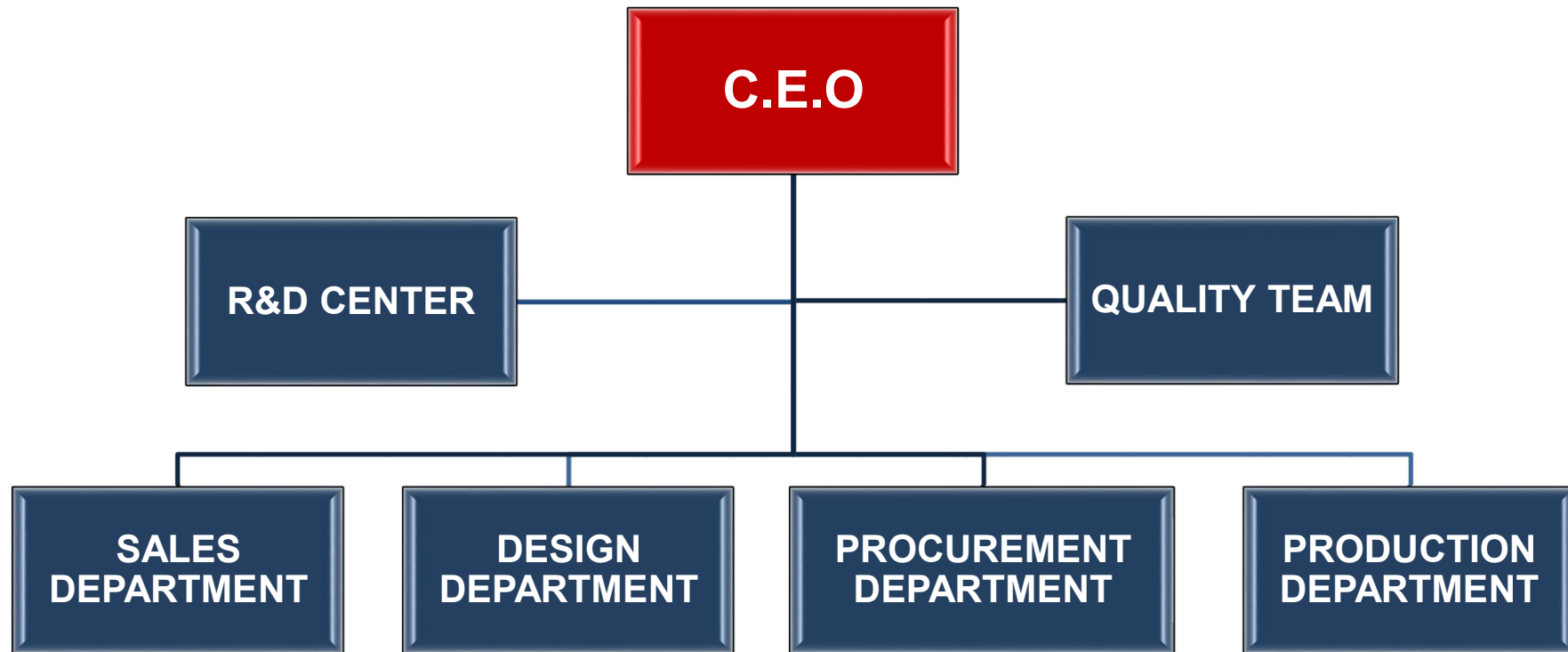
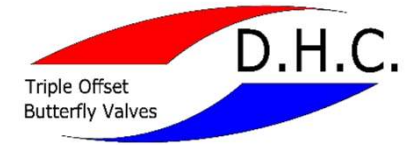

01 ABOUT DHC – WORKFLOW

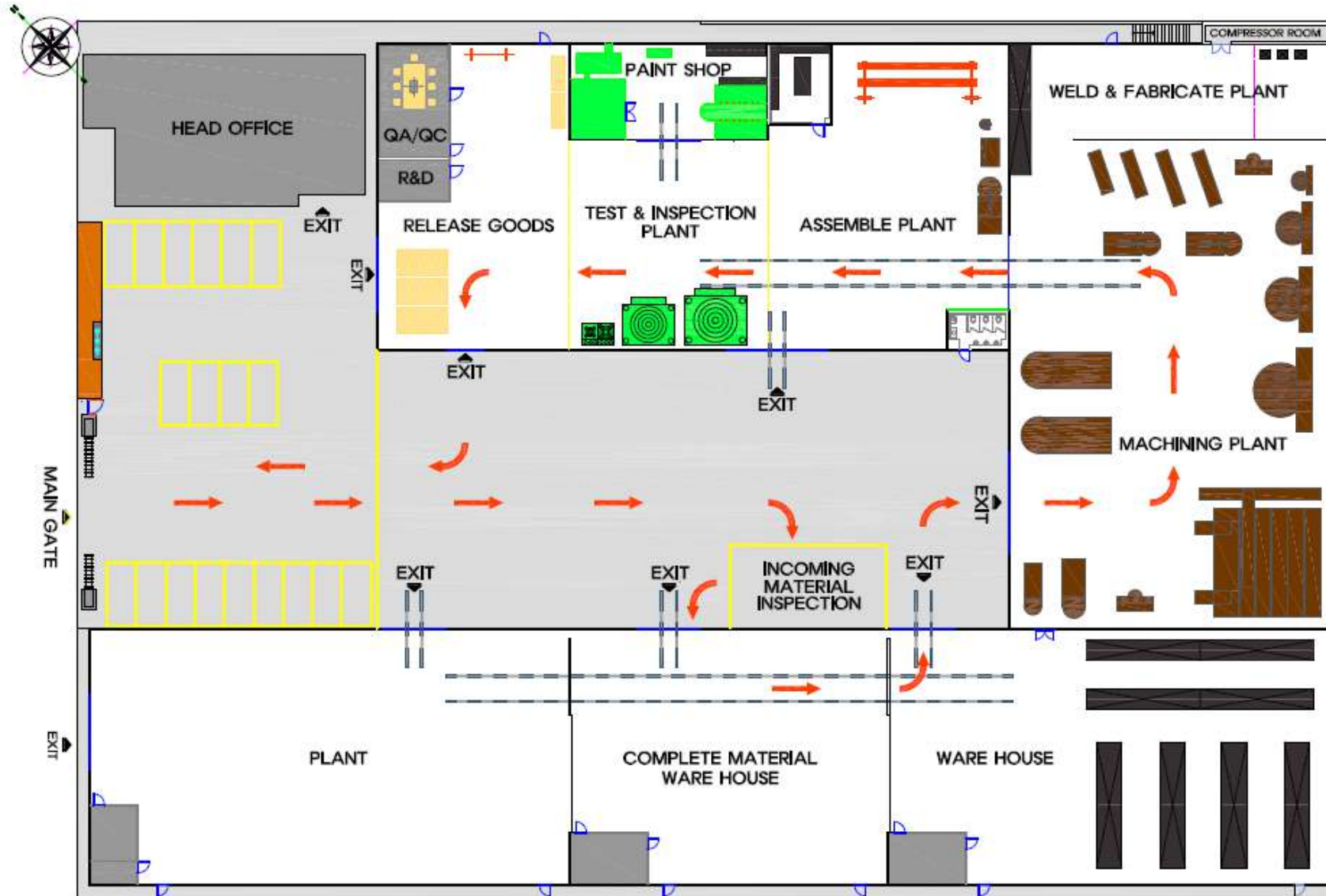

01 ABOUT DHC – STRENGTH OF D.H.C

Chapter.

< SMALL BUT STRONG! >

SPEED

We can meet customer's required delivery date based on quick decision.

EXPERIENCE

We have a wealth of experience in this industry.

CUSTOMIZE

We can supply products for customers with special needs.







CHAPTER 02.
PRODUCTION AND BUSINESS SCOPE

DAEHAN CONTROL CO., LTD.

02 PRODUCTION & BUSINESS SCOPE

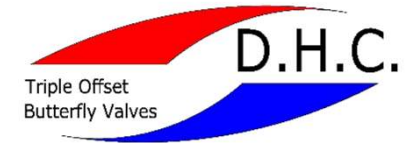
Chapter.





ITEM	SCOPE	
	SIZE	RATING
 TRIPLE OFFSET BFV	DN50 TO DN 3,000	150LB TO 2500 LB
 HI-PERFORMANCE BFV	DN50 TO DN 3,400	150LB TO 600 LB
 WATER WORKS BFV	DN150 TO DN 4,000	150LB TO 300 LB, AWWA CL.B~F
MATERIAL	BODY&DISC : DUCTILE / CARBON STEEL / STAINLESS STEEL / (Ni) BRONZE / ALLOY STEEL etc. SEAT : EPDM, NBR, PTFE, R-PTFE, PCTFE, METAL SEAT, STELLITE, ALLOY etc.	

BUTTERFLY

02 PRODUCTION & BUSINESS SCOPE

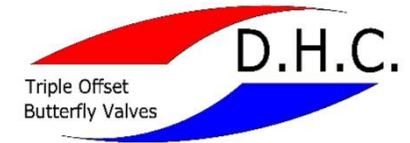
Chapter.

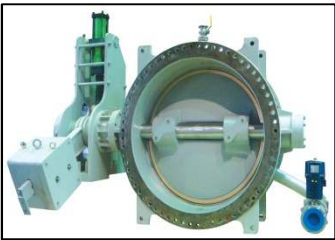

ITEM	SCOPE	
	SIZE	RATING
CHECK V/V  NON-SLAM / NRV	DN150 TO DN 2,500	150LB TO 1500 LB
HIGH & LOW TEMP. V/V BUTTERFLY, BALL, GATE Etc.  CRYOGENIC VALVE	DN150 TO DN 1,200	150LB TO 600 LB UP TO -196 °C
 HIGH TEMP. BFV	DN50 TO DN 3,000	150LB TO 600 LB UP TO 850°C

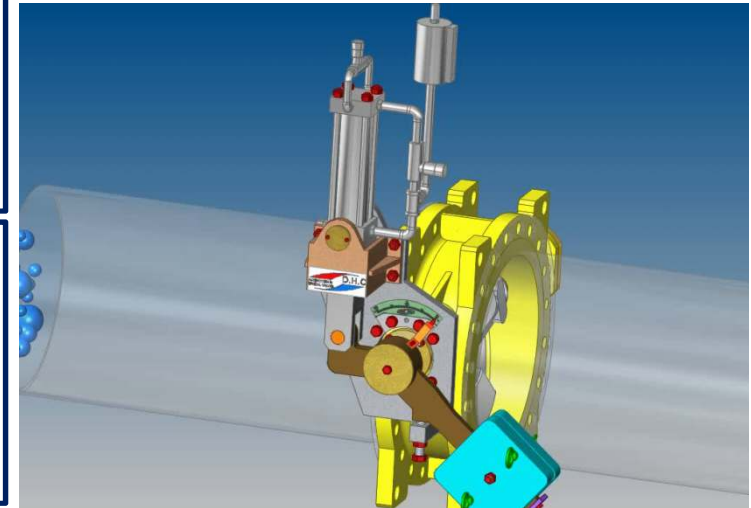



Operation of NSCV

02 PRODUCTION & BUSINESS SCOPE

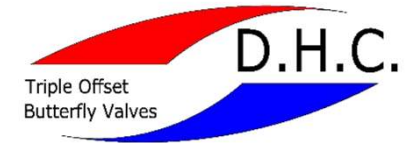
Chapter.



ITEM	SCOPE	
	SIZE	RATING
 WATER SEAL VALVE	DN200 TO DN 3,000	ANSI, JIS, KS, DIN, Etc.
 CONTROL VALVE	UP TO DN900	ANSI, JIS, KS, DIN, Etc.
 SNORT VALVE	UP TO DN3,000	ANSI, JIS, KS, DIN, Etc.

SPECIAL VALVE



Operation of water seal valve.



CHAPTER 03.

PROJECT MANAGEMENT & CONTROL DOCUMENTS

DAEHAN CONTROL CO., LTD.

03 PROJECT MANAGEMENT & CONTROL DOCUMENTS

Chapter.

DHC has **our unique ERP and documentation control program.**

All documents and process are sharing via this program to all relevant staff.

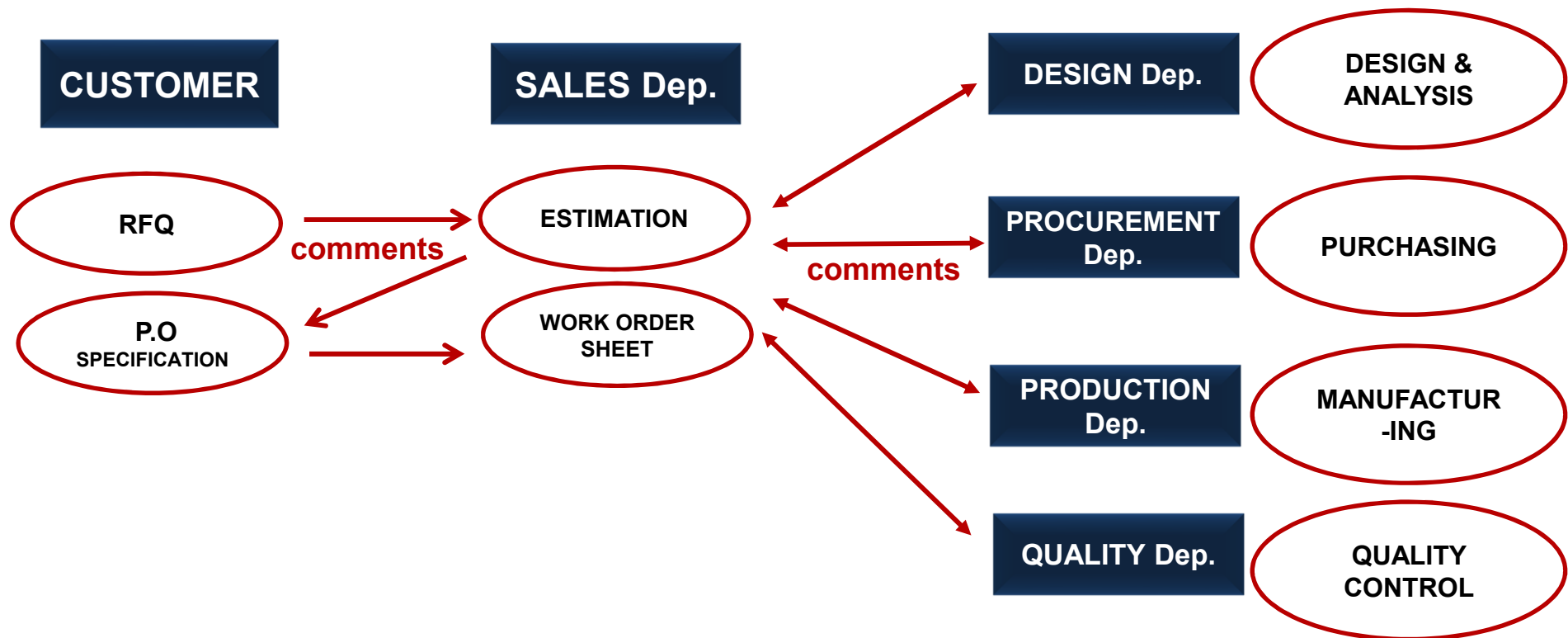

03 PROJECT MANAGEMENT & CONTROL DOCUMENTS

Chapter.

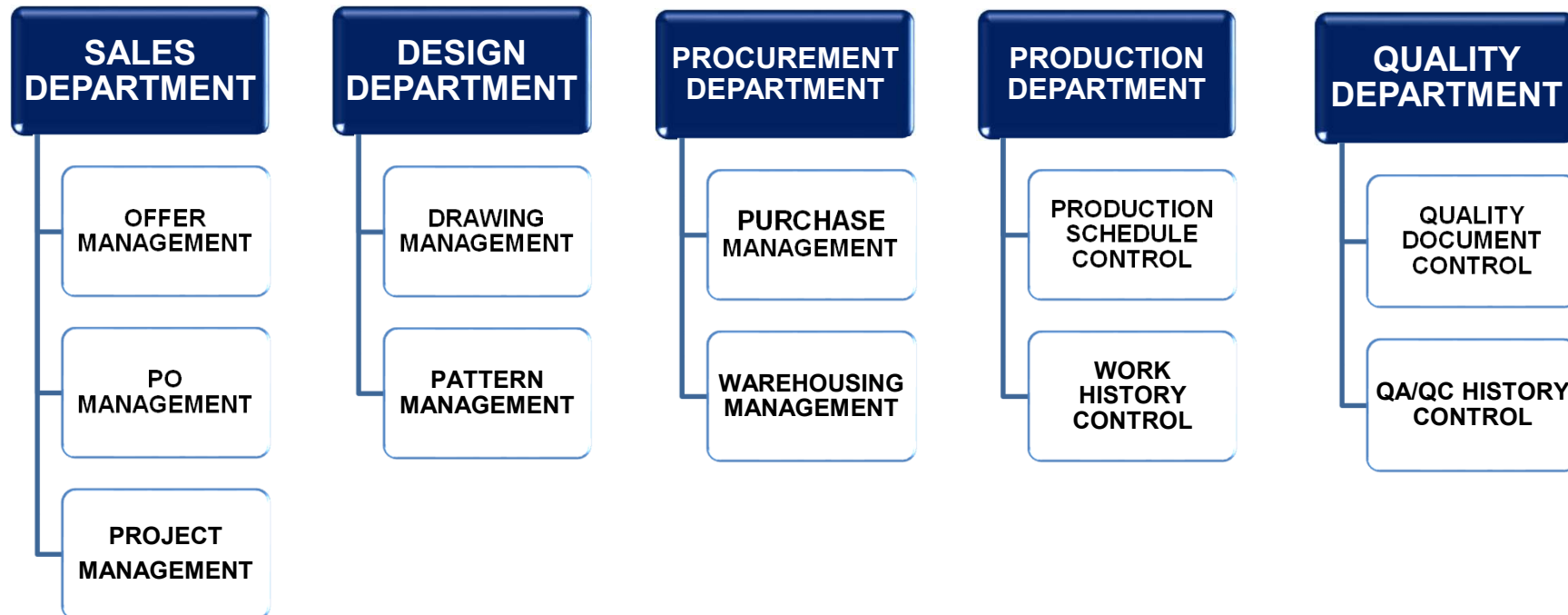



CHAPTER 04.
DESIGN & DEVELOPMENT

DAEHAN CONTROL CO., LTD.

04 DESIGN & DEVELOPMENT

Chapter.



► DESIGN DEPARTMENT

Our Design department is equipped with **the latest AutoCAD** design software for **2-D drafting and 3-D modeling**.

Structural calculations, finite element analysis (FEA), dynamic analysis and product validation are also done with advanced software when appropriate.

Special valves are developed to suit customer requirements. These designs are created by a team of engineers experienced in the valve design technology.

04 DESIGN & DEVELOPMENT

Chapter.

► DESIGN and Verification for Butterfly Valve. – FEMAP with Nastran

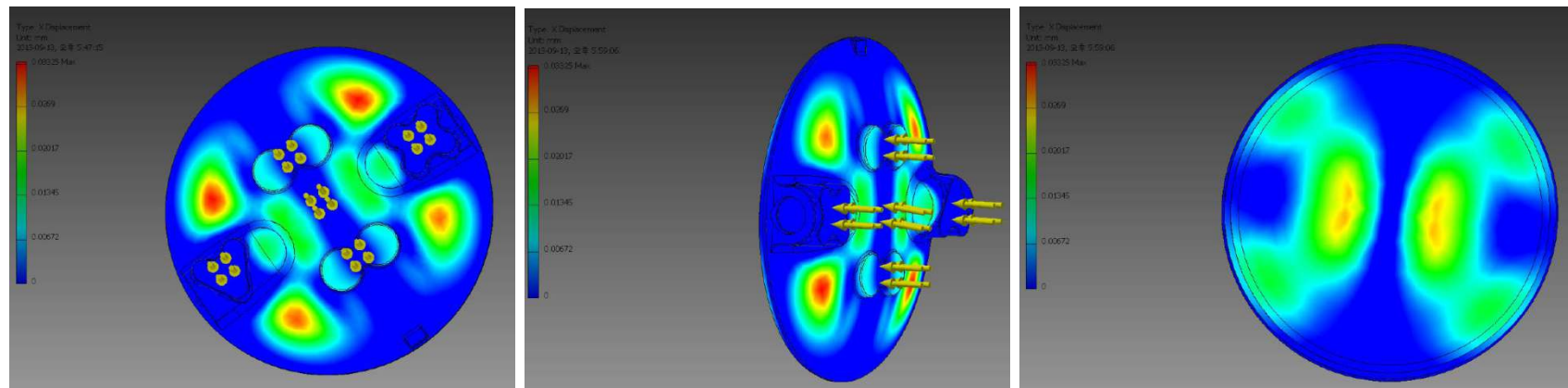
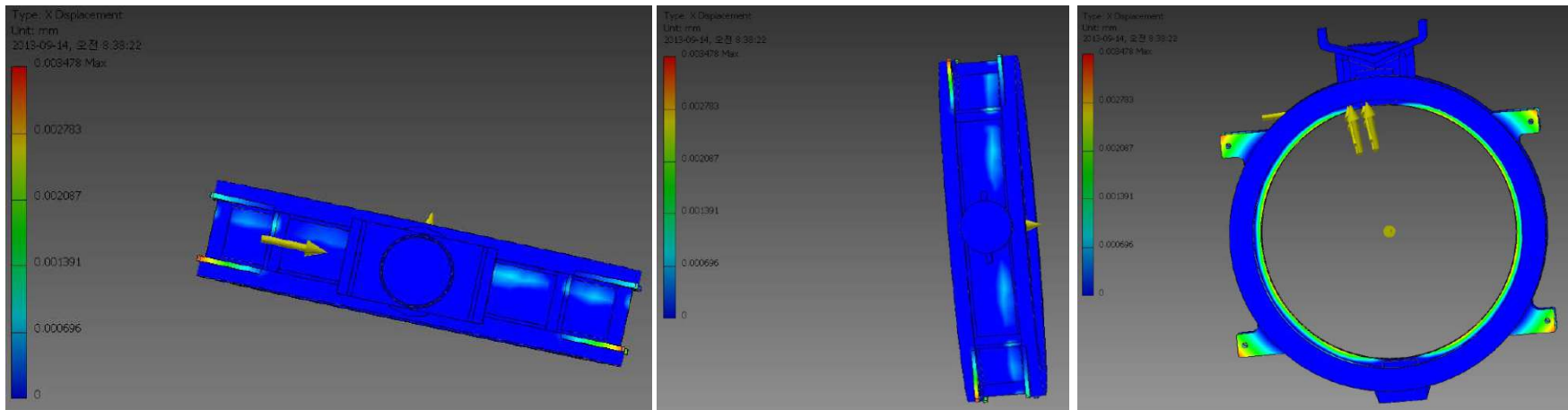

PN40 – 114" FEA Data

04 DESIGN & DEVELOPMENT

Chapter.

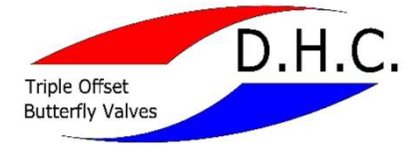

▶ 3D Modeling for High Temp. Gate Valve – FEMAP with Nastran

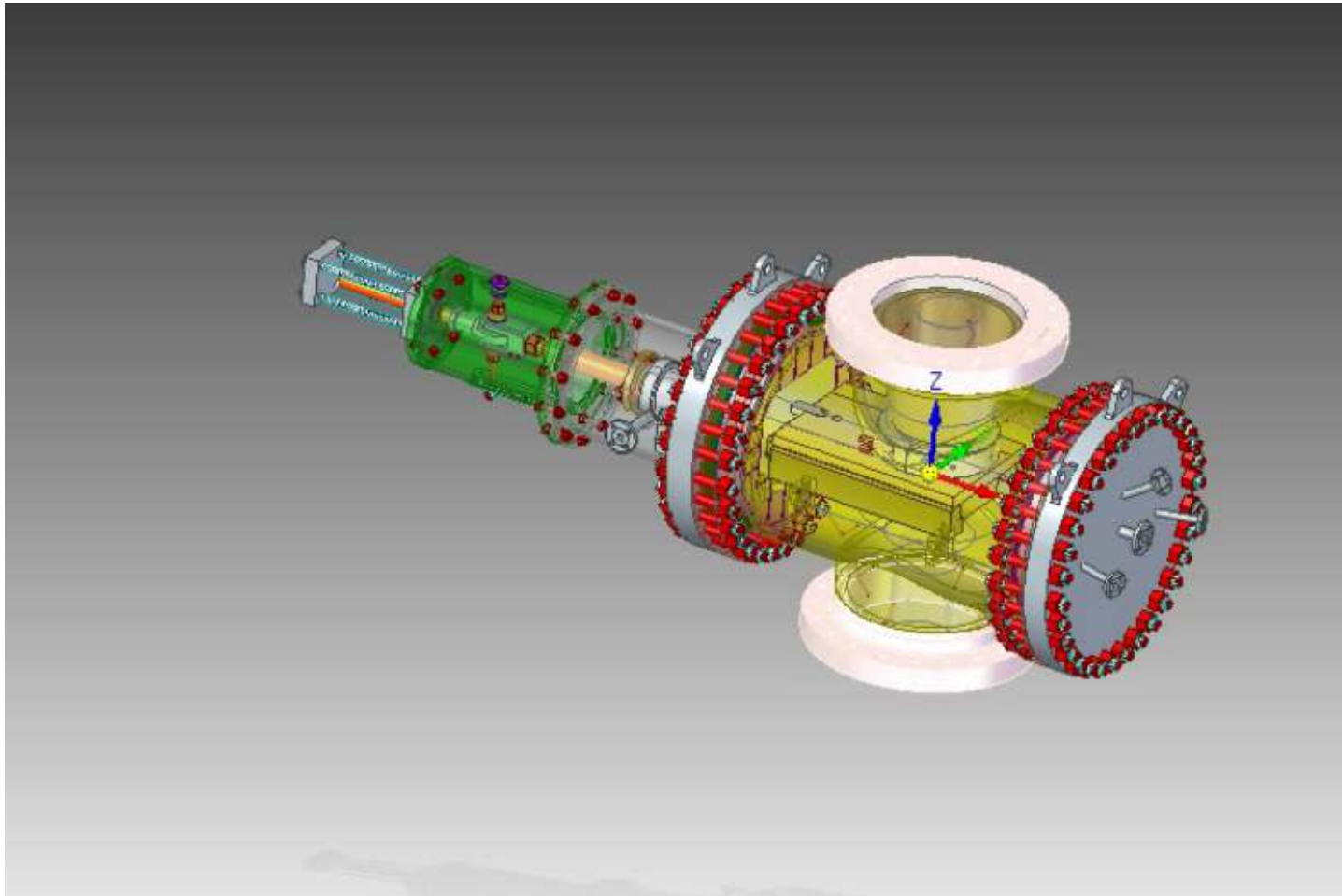



CHAPTER 05.
MANUFACTURING & QUALITY

DAEHAN CONTROL CO., LTD.

05 MANUFACTURING & QUALITY

Chapter.

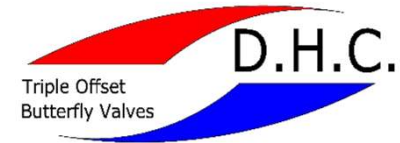

▶ MANUFACTURING

Our manufacturing plant is located in industrial city of Busan, south Korea **close to Busan airport & seaport.**

The nearest international airport is Busan, and by road, the journey from Busan airport to the plant **takes around half an hour.**

The facility is designed for **high volume production** and equipped with CNC machines, VTLs, automated welding machines, non-compression test stands and a modern paint shop.

DHC has the capability to design and manufacture the **high quality special valves** to meet the customer requirements.

05 MANUFACTURING & QUALITY

Chapter.

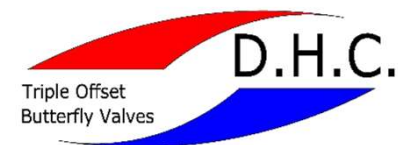

ITEM	NAME	Q'TY	SIZE	YEAR	REMARK
1	Turning Machine	1	Φ4400	5	Turning for Big Sized Valve and Flange
2		1	Φ2300	7	
3		1	Φ1600	10	
4		1	Φ1000	5	
5	LATHE Machine	1	460*1000L	10	Components machining and spiral processing
6		2	580*1500L	5	
7		1	580*2000L	7	
8	CNC Lathe	1	6"	5	
9	Boring Machine	2	130T	6	Boring for Valve body and Disc
10		1	100T	6	
11		1	80T	5	

05 MANUFACTURING & QUALITY

Chapter.



ITEM	NAME	Q'TY	SIZE	YEAR	REMARK
12	Radial Drilling	2	1600	7	CNC Drilling for flange
13		1	2000	1	
14		1	560	7	
15	Drill Master	1	5000*5000	6	Drilling for flanges
16	Milling Machine	1	Size No.3	7	Milling for valve parts
17	Vertical Slotter Machine	1	50T	5	Machining for key slot
18	Horizontal Slotter Machine	1	50T	9	Key Machine
19	Hydro Test	1	2000 X 200 bar	1	Hydro Test
20		1	50A ~ 600A	10	
21	Cycle Test	1	Ø600	6	Cycle Test
22	Hydro Power unit	1	Ø150 X 250 bar	6	

05 MANUFACTURING & QUALITY

Chapter.

▶ Hydraulic test equipment

Our hydraulic pressure test equipment can test up to DN3,400 and 400Bar.

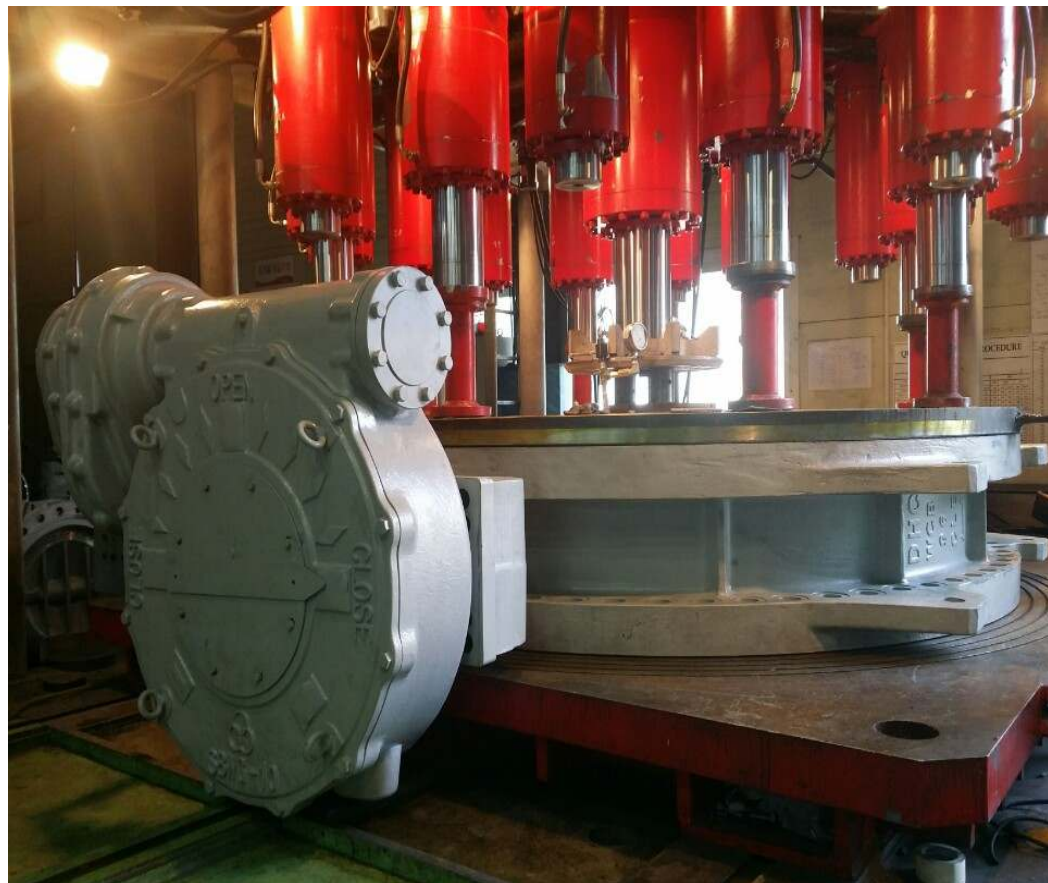

05 MANUFACTURING & QUALITY

Chapter.



► Inspection Equipment

ITEM	NAME	Q'TY	CAPACITY	YEAR	REMARKS
1	Pressure Gauge	10	0~0.1 – 0~7Mpa	5	Testing for Body Pressure and Disk Leakage
		5	0~10 – 0~50Mpa	5	
		1	0~100Mpa	5	
2	Micro chronometer	5	0~25 – 75~100mm	5	Testing for Electronic Operation
		3	100~125 – 150~300mm	5	
3	Torque Wrench	1	3.923~11.768Nm	4	
		1	9.807~49.033Nm	4	
		5	29.42~137.29Nm Etc.	4	
4	Calipers, inside/outside	13	0~150 – 0~300mm	4	Gauging Length
		5	0~600 – 0~2000mm	5	
5	Calipers, bar type	1	100~2100mm	4	
6	Outside Micrometers	1	0~25mm	3	Gauging Diameter of Valve
		1	25~50mm	3	

05 MANUFACTURING & QUALITY

Chapter.

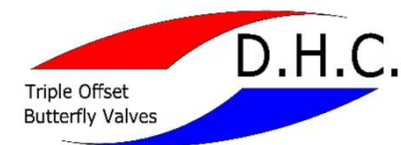

ITEM	NAME	Q'TY	CAPACITY	YEAR	REMARKS
7	Thickness tester	1	-	5	Gauging Thickness
8	Cylinder / bore Gauge	1	50~100mm	3	Gauging Inside Diameter
		1	160~250mm	3	
9	Thread plug gauge	1	1 ¼" – 8UN	5	
10	Pressure transmitter	1	0~30Mpa	4	
11	Leep hardness Tester	1	-	5	
12	DC holiday tester	1	5 Kv	5	
13	Temperature Indicator	2	-	1	
14	Gas Analyzer	1	-	2	
15	Flow Meter	1	1~5L	3	
		1	1~10L	3	
		1	30~330L	3	
16	Height gauge	1	0~600mm	2	

05 MANUFACTURING & QUALITY

Chapter.



▶ OPERATING TEST ◀



▶ DIMENSION TEST ◀



▶ MATERIAL TEST ◀

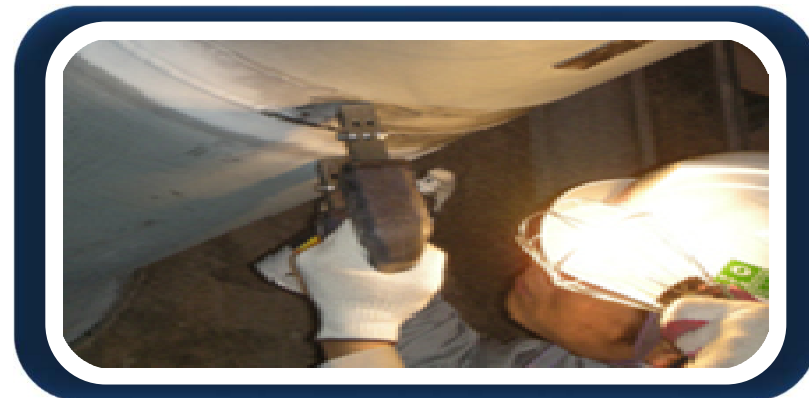

▶ NON – DESTRUCTIVE TEST ◀

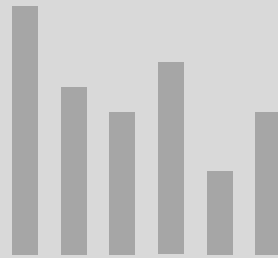

CHAPTER 06.

PRODUCTS FOR VARIOUS APPLICATION

DAEHAN CONTROL CO., LTD.

06 DHC VALVES FOR POWER PLANT

Chapter.



TRIPLE OFFSET BFV 60"
PNEUMATIC ACTUATOR
QUICK OPEN/CLOSE : 1.6 sec.
DESIGN PRESSURE : 9.5 kg/cm²
DESIGN TEMPERATURE : 334°C



HI-PERFORMANCE BFV 96"
RUBBER LINED
MOTOR OPERATION
AWWA C207 CL.D
DESIGN PRESSURE : 10 BAR



NON RETURN CHECK VALVE 78"
COUNTER WEIGHT & HYD. ACT.
EMERGENCY SHUT-OFF
#250 – 78" / FLUID : WATER

REFERENCE



NORTE II COMBINED CYCLE POWER PLANT PJT in MEXICO

ALUM TULCEA CCPP Power PLANT in ROMANIA

SEJONG/POCHEON/YANGJU COMBINED HEAT&POWER PLANT.

06 DHC VALVES FOR STEEL MILL.

Chapter.

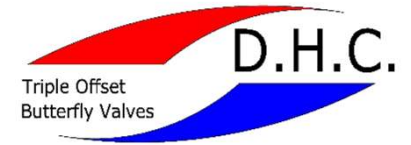

TRIPLE OFFSET BFV 78"
APPLICATION : COG/BFG
MOTOR OP. ZERO LEAKAGE



WATER SEAL VALVE 1500A
APPLICATION : COG/BFG/LDG

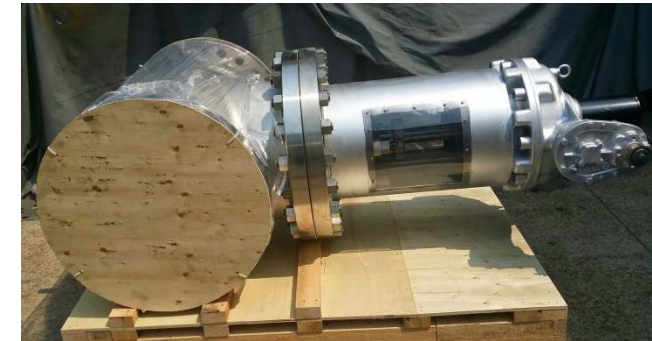

GLOBE VALVE
APPLICATION : O2
30K 450A / OIL FREE

REFERENCE



HYUNDAI STEEL INTEGRATED STEEL MILL .

POSCO STEEL INTEGRATED STEEL MILL / POSCO BRAZIL CSP / POSCO INDONESIA

KOBE STEEL BAHRAIN INTEGRATED STEEL MILL

06 DHC VALVES FOR STEEL MILL.

Chapter.



GOGGLE VALVE 3400A

- SUPPLY TO HYUNDAI STEEL
- FUNCTION : Isolation of highly toxic gas line
 - MEDIA : BFG, COG, Flue gas, Mixed gas

REFERENCE



HYUNDAI STEEL INTEGRATED STEEL MILL .

06 DHC VALVES FOR REFINERY/OIL&GAS

Chapter.



CONTROL BUTTERFLY VALVE
ALGERIA SKIDDA PJT
PNEUMATIC ACTUATOR



GATE & GLOBE VALVE
MANUAL OPERATION



SK PDH PJT - 78inch Butterfly valve
DESIGN TEMP. : 704°C
OPERATING TEMP. : 625°C
FLUID : REGENERATION GAS

REFERENCE



SKIDDA REFINERY PROJECT IN ALGERIA
SK GAS ULSAN PDH PJT

06 DHC VALVES FOR WATER TREATMENT

Chapter.

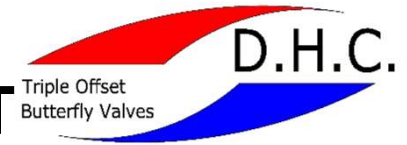

Anti-Cavitation BUTTERFLY VALVE

Ni-Albronz BODY AND Monel Trim
PNEUMATIC Control.



PN 40 114" BUTTERFLY VALVE

Cutzamaia Raw Water Pumping station
in Mexico
FLANGE DRILLING : AWWA C207 CL.E
FLUID : RAW WATER



High Performance BUTTERFLY VALVE

Hydraulic Operated for Submerged
Water application.

REFERENCE



South Feather Water & Power

EASTERN MUNICIPAL WATER DISTRICT – Vail Lake Project

06 DHC VALVES FOR OTHERS

Chapter.



CONTROL GLOBE VALVE

- CUSTOMER : DHI
- FUNCTION : TURBINE CONTROL SYSTEM (DOOPEX-1 PROJCT)
- SIZE : 600LB 10"



SNORT VALVE

- CUSTOMER : HYUNDAI
- FUNCTION : FLOW CONTROL
- MEDIA : BFG, COG, FLUE GAS, MIXED GAS



CONTROL BUTTERFLY VALVE

- CUSTOMER : PENDULUM
- DESIGN : FULL PTFE LINED
- MEDIA : ACID

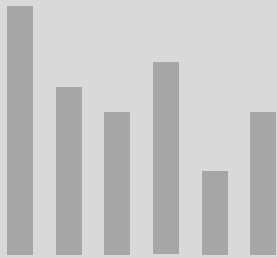

CHAPTER 07.

LIST OF CERTIFICATES

DAEHAN CONTROL CO., LTD.

07 LIST OF CERTIFICATE

Chapter.



► QUALITY

The quality management system of the plant has been certified to comply with **ISO 9001:2008.**

The QMS, designed and implemented to ensures that all products **meet international standards as well as customer specifications.**

DHC committed to total customer satisfaction and deliver products that comply with all relevant codes and standards and meet customer expectations

Quality of raw materials and components are assured using a **stringent vendor selection and management system.**

Castings are procured only from selected sources, our inspectors are **monitoring the process and casting quality.**

07 LIST OF CERTIFICATE

Chapter.

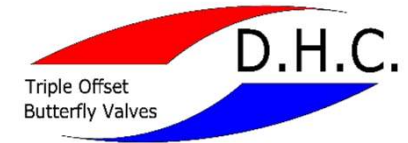

DATE	CERT FORM	MODEL&SIZE	REMARK
2000 – JAN	KAB	BUTTERFLY, CHECK, GATE, PLUG, BALL VALVE	ISO 9001: 2008 KS Q 9001: 2009
2006 – NOV	KIPO	A disc seat valve with a double intercepting of pressure that one body seat was applied	20-0431984
2007 – SEP	CEOC	BUTTERFLY, CHECK VALVE	CE 3444/3/2007-1 CE 3444/3/2007-2
2009 – JAN	KIPO	DOUBLE DISC TYPE AQUA PLUG VALVE	10-0880363
2009 – FEB	KIPO	LOW TORQUE WEDGED OS&Y BB GATE VALVE	10-0887291
2009 – MAR	KIPO	AQUA PLUG VALVE	10-0892073
2010 - JUNE	KAB	BUTTERFLY VALVE	ISO 14001
2013 – MAY	VELOSI	FIRE SAFETY TYPE BUTTERFLY VALVE	FTC-DHC-20130530- BUTTERFLY 001~045
2013 – JUNE	VELOSI	FIRE SAFETY TYPE BALL	FTC-DHC-20130615-BALL 001~045
2014 – APR	API	BUTTERFLY VALVE	API 609-0079 , 6D-1341
2014 – AUG	NSF international	BUTTERFLY VALVE	NSF 61 / C0298825-01
2015 – OCT	KAB	BUTTERFLY VALVE	ISO 18001

07 LIST OF CERTIFICATE

Chapter.



 	<p>Certificate of Authority to use the Official API Monogram License Number: 609-0079 ORIGINAL</p> <p>The American Petroleum Institute hereby grants to</p> <p style="text-align: center;">DAEHAN CONTROL CO., LTD. 39, Gadal 1-Ro Gangseo-Gu, Busan South Korea</p> <p>the right to use the Official API Monogram™ on manufactured products under the conditions in the official publications of the American Petroleum Institute entitled API Spec Q1™ and API-609 and in accordance with the provisions of the License Agreement.</p> <p>In all cases where the Official API Monogram is applied, the API Monogram shall be used in conjunction with this certificate number: 609-0079</p> <p>The American Petroleum Institute reserves the right to revoke this authorization to use the Official API Monogram for any reason satisfactory to the Board of Directors of the American Petroleum Institute.</p> <p>The scope of this license includes the following: Butterfly Valves - Category B and Butterfly Valves - Category A</p> <p>GMS Exclusions: Servicing</p> <p>Effective Date: SEPTEMBER 22, 2017 Expiration Date: APRIL 4, 2020</p> <p>To verify the authenticity of this license, go to www.api.org/compositelist.</p> <p style="text-align: right;"> <small>Vice President, API Global Industry Services</small></p>
------------------------------------------------------------------------------------------------------------------------------------------------------------------------	-------------------------------------------------------------------------------------------------------------------------------------------------------------------------------------------------------------------------------------------------------------------------------------------------------------------------------------------------------------------------------------------------------------------------------------------------------------------------------------------------------------------------------------------------------------------------------------------------------------------------------------------------------------------------------------------------------------------------------------------------------------------------------------------------------------------------------------------------------------------------------------------------------------------------------------------------------------------------------------------------------------------------------------------------------------------------------------------------------------------------------------------------------------------------------------------------------------------------------------------------------------------------------------------------------------------------------------------------------------------------------------------------------------------------------------------------------------------------------------------------------------------------------------------------------------------------------------

<p style="text-align: center;">NSF International RECOGNIZES Dae Han Control Co., Ltd. Republic of Korea</p> <p style="text-align: center;">AS COMPLYING WITH NSF/ANSI 61 AND ALL APPLICABLE REQUIREMENTS. PRODUCTS APPEARING IN THE NSF OFFICIAL LISTING ARE AUTHORIZED TO BEAR THE NSF MARK.</p> <p style="text-align: center;">    </p> <p style="text-align: center;"><small>This certificate is the property of NSF International and must be returned upon request. For the most current and complete information, please access NSF's website (www.nsf.org).</small></p> <p style="text-align: center;"> <small>August 6, 2014 Certificate CS176082 - 01</small>  <small>David Parkiss General Manager, Water Systems</small> </p>

 	<p>Certificate of Authority to use the Official API Monogram License Number: 6D-1341 ORIGINAL</p> <p>The American Petroleum Institute hereby grants to</p> <p style="text-align: center;">DAEHAN CONTROL CO., LTD. 39, Gadal 1-Ro Gangseo-Gu, Busan South Korea</p> <p>the right to use the Official API Monogram™ on manufactured products under the conditions in the official publications of the American Petroleum Institute entitled API Spec Q1™ and API-6D and in accordance with the provisions of the License Agreement.</p> <p>In all cases where the Official API Monogram is applied, the API Monogram shall be used in conjunction with this certificate number: 6D-1341</p> <p>The American Petroleum Institute reserves the right to revoke this authorization to use the Official API Monogram for any reason satisfactory to the Board of Directors of the American Petroleum Institute.</p> <p>The scope of this license includes the following: Ball Valves</p> <p>GMS Exclusions: Servicing</p> <p>Effective Date: SEPTEMBER 22, 2017 Expiration Date: APRIL 4, 2020</p> <p>To verify the authenticity of this license, go to www.api.org/compositelist.</p> <p style="text-align: right;"> <small>Vice President, API Global Industry Services</small></p>
---------------------------------------------------------------------------------------------------------------------------------------------------------------------------	--------------------------------------------------------------------------------------------------------------------------------------------------------------------------------------------------------------------------------------------------------------------------------------------------------------------------------------------------------------------------------------------------------------------------------------------------------------------------------------------------------------------------------------------------------------------------------------------------------------------------------------------------------------------------------------------------------------------------------------------------------------------------------------------------------------------------------------------------------------------------------------------------------------------------------------------------------------------------------------------------------------------------------------------------------------------------------------------------------------------------------------------------------------------------------------------------------------------------------------------------------------------------------------------------------------------------------------------------------------------------------------------------------------------------------------------------------------------------------------------------------------------------------

<p style="text-align: center;">NSF International RECOGNIZES Dae Han Control Co., Ltd. Facility: Busan, Republic of Korea</p> <p style="text-align: center;">AS COMPLYING WITH NSF/ANSI 61 AND ALL APPLICABLE REQUIREMENTS. PRODUCTS APPEARING IN THE NSF OFFICIAL LISTING ARE AUTHORIZED TO BEAR THE NSF MARK.</p> <p style="text-align: center;">    </p> <p style="text-align: center;"><small>This certificate is the property of NSF International and must be returned upon request. For the most current and complete information, please access NSF's website (www.nsf.org).</small></p> <p style="text-align: center;"> <small>August 6, 2014 Certificate CS176083 - 01</small>  <small>David Parkiss General Manager, Water Systems</small> </p>



API 609 / 6D

NSF 61

07 LIST OF CERTIFICATE

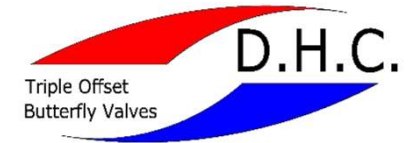
Chapter.



VELOSI INTERNATIONAL KOREA

THE WORLDWIDE INSPECTION, EXPEDITING AND PROCUREMENT SPECIALISTS

FIRE TEST CERTIFICATE

Certification No. : FTC-DHC-20130530-BUTTERFLY001
Ref. Test Report No. : DHC-BFV-001

This is to certify that the below materials have been inspected by Velosi Korea and found to be satisfactory in the Fire Test in accordance with API 607, sixth edition / EN ISO 10497 : 2010(E).

Manufacturer : **DAE HAN CONTROL CO., LTD.**
Location : 1207-13, BUSAN SCIENCE INDUSTRIAL COMPLEX, JISA-DONG, KANGSEO-GU, BUSAN, KOREA
Location of Test : TEST SHOP OF DAE HAN CONTROL CO., LTD.

1. Description of Test Valve :

Valve Model No.	DHC-BD1MR-PS-F-ACT-50
Type of Test Valve	High Performance Butterfly Valve
Description of Test Valve	Body, Disc, VITON Seat, Flange, MOV
Valve Size (NPS)	2"
Pressure Rating (ANSI Class)	150#
Valve Body Material	ASTM A216-WCB
Valve Seat Material	VITON + METAL
Seat Configuration	Bi-directional Service
Valve Weight	28 kg
Drawing No.	DHC-BD1MR-130327-001
Date of Test	May 01, 2013

2. Qualified Range of Valve :

Qualified Sizes (NPS)	2" and below, 2-1/2", 3", 4"
Qualified Pressure Ratings (ANSI Class)	#150, #300
Qualified Valve Material	Ferritic

This certificate is issued in accordance with API 607, 6th edition / EN ISO 10497 : 2010(E), based on the result of test report on above mentioned test valve. For detailed report of tested valve, see the Appendix 1 Fire Test Report of this certificate. The additional valve qualification shall be limited on the valves according to para. 7 requirements.





Velosi International - Korea
Date : 30th of May 2013



Hee-Hyun, Kim
President

FIRE SAFETY (BUTTERFLY VALVE)

VELOSI INTERNATIONAL KOREA

THE WORLDWIDE INSPECTION, EXPEDITING AND PROCUREMENT SPECIALISTS

FIRE TEST CERTIFICATE

Certification No. : FTC-DHC-20130615-BALL001
Ref. Test Report No. : DHC-BV-001

This is to certify that the below materials have been inspected by Velosi Korea and found to be satisfactory in the Fire Test in accordance with API 607, sixth edition / EN ISO 10497 : 2010(E).

Manufacturer : **DAE HAN CONTROL CO., LTD.**
Location : 1207-13, BUSAN SCIENCE INDUSTRIAL COMPLEX, JISA-DONG, KANGSEO-GU, BUSAN, KOREA
Location of Test : TEST SHOP OF DAE HAN CONTROL CO., LTD.

1. Description of Test Valve :

Valve Model No.	DHC-BaT1MR-PS-F-ACT-50
Type of Test Valve	Flange Type Ball Valve
Description of Test Valve	2pcs Body, VITON Seat, Flange, MOV
Valve Size (NPS)	2"
Pressure Rating (ANSI Class)	150#
Valve Body Material	ASTM A216-WCB
Valve Seat Material	VITON + METAL
Seat Configuration	Symmetric, Bi-directional Service
Valve Weight	18 kg
Drawing No.	DHC-BaT1MR-130327-001
Date of Test	May 16, 2013

2. Qualified Range of Valve :

Qualified Sizes (NPS)	2" and below, 2-1/2", 3", 4"
Qualified Pressure Ratings (ANSI Class)	#150, #300
Qualified Valve Material	Ferritic

This certificate is issued in accordance with API 607, 6th edition / EN ISO 10497 : 2010(E), based on the result of test report on above mentioned test valve. For detailed report of tested valve, see the Appendix 1 Fire Test Report of this certificate. The additional valve qualification shall be limited on the valves according to para. 7 requirements.



Velosi International - Korea
Date : 15th of June 2013



Hee-Hyun, Kim
President

FIRE SAFETY (BALL VALVE)

07 LIST OF CERTIFICATE

Chapter.

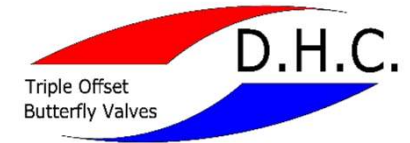

CE 3444/3/2007-1

CE 3444/3/2007-2



OHS MANAGEMENT SYSTEM

OHSAS 18001:2007

07 LIST OF CERTIFICATE

Chapter.



QUALITY MANAGEMENT SYSTEM
ISO 9001:2009



ENVIRONMENT MANAGEMENT SYSTEM
ISO 14001:2009

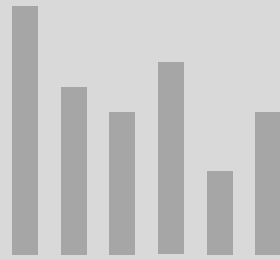

CHAPTER 08.

SUB - CONTRACTORS

DAEHAN CONTROL CO., LTD.

08 SUB - CONTRACTORS

Chapter.

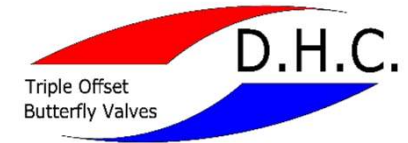

Company	Established	Product(Material)	Capacity	Certificates
Juwon Special Steel co., ltd.	MAY 9, 1997	Carbon steel Alloy steel Stainless steel Duplex Monel Hastelloy	*Factory 1:100 ton *Factory 2:450 ton	ISO 9001:2000 PED(97/23/EC)TUV-Approval Loyd's-WPS&POQ-Approval ABS-WPS&POQ-Approval BV-WPS-Approval
Daeshin metal	MAR 3, 1987	Carbon steel Alloy steel Stainless steel Duplex, Monel Hastelloy	*Factory 1:400 ton	ISO 9001:2000 Loyd's-WPS&POQ-Approval ABS-WPS&POQ-Approval BV-WPS-Approval
Shin Dae Ryuck Alloy Metal	JAN 1, 2002	B148 C95200~C95800 ALBC1~ALBC4 HBSC1~HBSC4 BC1~BC7	*Factory 1:300 ton	ISO 9001:2000
Jin Young Casting	APR 1, 1987	Cast Iron Cast Gray Iron	*Factory 1:500 ton	GL-WPS&POQ-Approval Loyd's-WPS&POQ-Approval DNV-WPS&POQ-Approval ABS-WPS&POQ-Approval BV-WPS-Approval

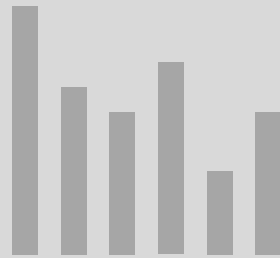

CHAPTER 09.

INSTALLATION AT SITE

DAEHAN CONTROL CO., LTD.

09 INSTALLATION AT SITE

Chapter.

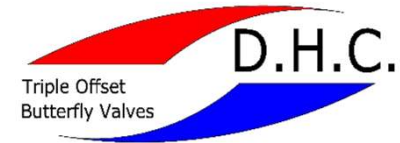

► PROJECT MANAGEMENT

We have a dedicated project management team to ensure the execution of the order on time to meet customer's project schedules.

Our project management team has extensive experience in managing the projects.

They have successfully demonstrated their capabilities to the client's satisfaction by executing the orders within the committed delivery schedules on various projects :

**IEUA RP-1 OUTFALL RELOCATION,
RAINBOW MUNICIPAL WATER DISTRICT,
SAN FRANCISCO PUBLIC UTILITY COMMISSION,
PACIFIC GAS AND ELECTRIC POTTER VALLEY POWERHOUSE,
ABU DHABI AIR PORT EXPANSION PROJECT IN UAE. ETC..**

09 INSTALLATION AT SITE

Chapter.



IEUA RP-1 OUTFALL RELOCATION



RAINBOW MUNICIPAL WATER DISTRICT

09 INSTALLATION AT SITE

Chapter.

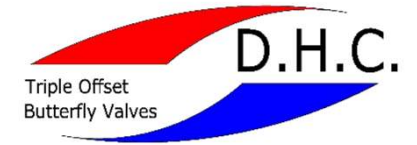

**KOBE STEEL IN BAHRAIN
MOV BUTTERFLY VALVE**



**HYUNDAI STEEL BLAST FURNANCE & COG PHASE III
FABRICATED TYPE BUTTERFLY VALVE**



09 INSTALLATION AT SITE

Chapter.

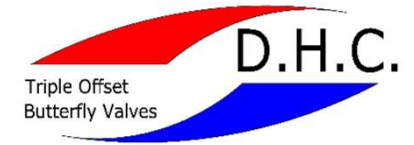

San Francisco Public Utility Commission
Class 250 60" Rubber seat Butterfly



Pacific Gas and Electric Potter Valley Powerhouse
Class 150 60" Triple offset Butterfly

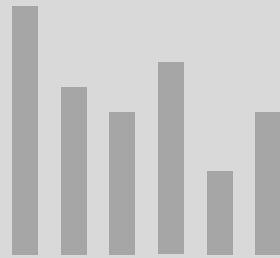

CHAPTER 10.

SUPPLY RECORDS (DOMESTIC/OVERSEAS)







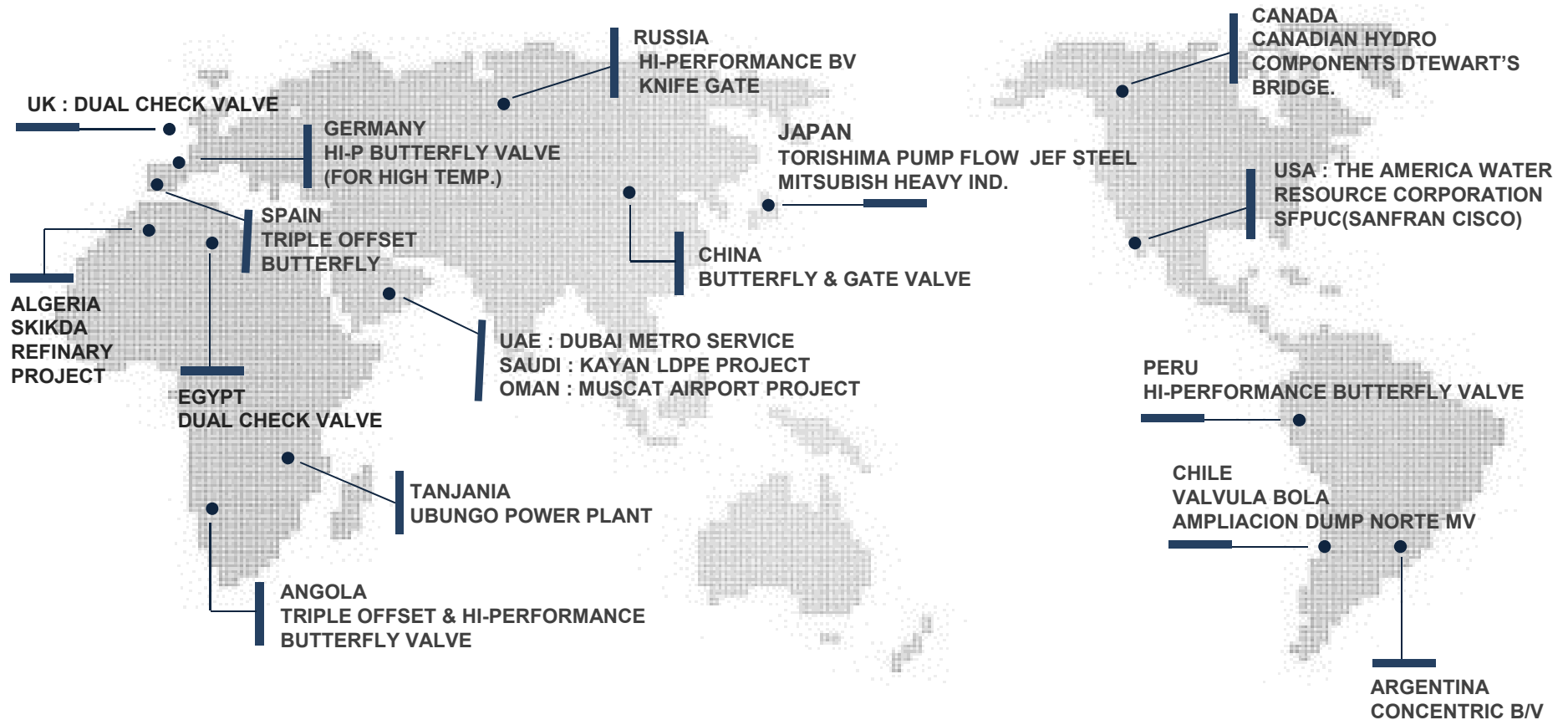

DAEHAN CONTROL CO., LTD.











10 SUPPLY RECORDS







Chapter.





















MAIN SUPPLY RECORDS << DOMESTIC >> Daehan Control Co.,Ltd







End User or CUSTOMER	Material	Description	Class	Size	Q'ty	Delivery	PROJECT & REMARKS	INDUSTRY
 KOREA WESTERN POWER	A126 CL.B	CON BFV WF ACT.	#150	8", 14"	12	2017	KOREA WESTERN POWER	POWER PLANT
		TRI BFV WF ACT.		14"	5			
 SPPC	WCB	TRI BFV FLN BARE	#300	18"	2	2017	KOREA SHIN PYEONGTAEK 3	NATURAL GAS PLANT
 K.A.E.R.I	CF8	HI-P BFV WF BARE	#300	6", 12"	13	2017	STELLA #2 PJT	KOREA ATOMIC ENERGY RESEARCH INSTITUTE
		TRI BFV WF BARE		12"	9			
 KOMIPO	CF8	TRI BFV LUG G/O	#300	8"	16	2017	JEJU COMBINED ENERGY PJT	POWER PLANT
	A240 Ty.304	BUTTERFLY DAMPER FLN G/O		12"	8			
 POSCO E&C	SS400	HI-P BFV FLN PNE ACT.	10K	1200A	3	2017	COG HEATING EQUIP	GWANGYANG POSCO
	SCPH2	HI-P BFV WF PNE ACT.		200A	3			
	FCD450	HI-P BFV WF G/O		250A	2			
	SCPH2	HI-P BFV WF G/O		200A	2			
	SCPH2	GLOBE VALVE FLN H/W(RF)	20K	100A	1			
	SCPH2	GLOBE VALVE FLN H/W(RF)		50A	3			
 SK E&C	CF8	DUAL PLATE CHECK VALVE	#150	6"	3	2017	GWANGYANG LNG Power Plant	POWER PLANT
 POSCO E&C	SS400	DAMPER FLN G/O	#150	36", 24", 16"	9	2017	POHANG SRF PJT	STEEL MILL PLANT
	WCB			12", 8", 4"	17	2017	POHANG SRF PJT	
 HHIC	A572 Gr.50	NON SLAM CHECK VALVE	#150	350A, 450A	3	2017	MAGOK COMBINED ENERGY PJT	POWER PLANT







End User or CUSTOMER	Material	Description	Class	Size	Q'ty	Delivery	PROJECT & REMARKS	INDUSTRY
 HANJIN HEAVY I&C	SCPH2	SWING CHECK VALVE	10K	450A	1	2017	MAGOK COMBINED ENERGY PJT	POWER PLANT
 LOTTE E&C	WCB	NON SLAM CHECK VALVE RF	#150	12" ~ 16"	6	2017	NAEPO NEW TOWN COMBINED HEAT & POWER PLANT PJT	POWER PLANT
 HANJIN HEAVY I&C	516 Gr.70	HI-P BFV BW G/O	#150	8" ~ 32"	20	2017	MAGOK COMBINED ENERGY PJT	POWER PLANT
 POSCO E&C	[WCB/CF8]	CON BFV WF [ACT/LEVER]	#150	2 1/2" ~ 12"	104	2017	MASINLOC POWER PLANT EXPANSION PJT	POWER PLANT
 GS POWER	WCB	NON SLAM CHECK VALVE	CL.D #150	24", 48"	4	2017	ANYANG COMBINED HEAT & POWER PLANT	POWER PLANT
 DOOSAN HEAVY I&C	WCB+STL#6	NON SLAM CHECK VALVE	#150, #300	22" ~ 26"	16	2017	HWASUNG/DONGTAN 2 COMBINED HEAT & POWER PLANT	POWER PLANT
 POSCO PLANTEC	FCD450	HI-P BFV [WF/LUG] G/O	10K, 20K	450A~800A	19	2016	POSCO POHANG 3 BLAST FURNACE	STEEL MILL PLANT
	SCPH2	NON SLAM CHECK VALVE FLN	10K, 20K	400A~750A	14	2016		
 SK E&C	CF8	TRI BFV FLN G/O TRI BFV LUG G/O	#300	14", 18"	2	2016	FCC FLEXIBILITY PJT	REFINERY
 POSCO E&C	A536	CON BFV [WF/FLN] M/O	#150	6", 10", 26"	12	2016	YEONGNAM NATURAL GAS POWER PLANT	POWER PLANT
	WCB	CON BFV LUG M/O	#150	20"	4			
	WCB	3-WAY BFV LUG P/O	#150	20"X16"	1			
	[CF8 / WCB]	GATE VALVE BW	#150	3", 8"	1			
	A536+R.L	HI-P BFV FLN M/O	#150	96"	2			
 DOOSAN HEAVY I&C	A536	CON BFV FLN M/O	#150	40"	4	2016	YEONGDONG HEAT POWER PLANT	POWER PLANT
		CON BFV [WF/LUG] L/O	#150	3", 4"	6			





End User or CUSTOMER	Material	Description	Class	Size	Q'ty	Delivery	PROJECT & REMARKS	INDUSTRY
 HYUNDAI STEEL	SS400	INLET BUTTERFLY VALVE	DN2000		1	2016	DANGJIN Steel Mill Plant	STEEL MILL PLANT
	SS400	INLET / OUTLET GOGGLE VALVE	DN2000 / DN3400		2			
	SS400	CLEAS GAS ISOLATION GOGGLE VALVE MOV	DN3400 0.15/0.4Kg/cm ² (NOMINAL PRESSPRE)		1			
 HANJIN HEAVY I&C	WCB	NON SLAM CHECK VALVE	#150	12", 22"	4	2016	OHSUNG COMBINED CYCLE POWER PLANT	POWER PLANT
 POSCO	WCB	NON SLAM CHECK VALVE BW TYPE HYD CYL.	#150	6" ~ 18"	15	2016	CHUNCHEON COMMUNITY ENERGY SYSTEM PJT	STEEL MILL PLANT
 DOOSAN HEAVY I&C	WC6	LOW PRESSURE [STOP VAVLE/CONTROL VALVE]	#150	18"	4	2016	HWASUNG/DONGTAN COMBINED HEAT & POWER PLANT	POWER PLANT
		MAIN EXTRACTION [STOP VAVLE/CONTROL VALVE]	#150	56"	4			
	WC6	LOW PRESSURE [STOP VAVLE/CONTROL VALVE]	#150	24"	4	2016	SEOUL COMBINED HEAT & POWER PLANT	
		MAIN EXTRACTION [STOP VAVLE/CONTROL VALVE]	#150	56"	4			
 POSCO ENERGY	A536+R.L	HI-P BUTTERFLY VALVE FLANGE TYPE	AWWA C207 CL.B	78", 108"	5	2013~2016	INCHEON COMBINED CYCLE POWER PLANT UNIT 5~9	POWER PLANT
	A536+R.L / WCB	HI-P BUTTERFLY VALVE LUG / FLANGE TYPE	150LB	14" ~ 92"	6			
	A536+R.L	NON RETURN CHECK VALVE	150LB	68"	7			
 HYUNDAI E&C	WCB / F304 / A105+STELLITE	METAL SEATED BALL VALVE [FLN / SW TYPE]	#150 ~ #600	1" TO 4"	1000	2014 ~ 2016	SAMCHEOK GREEN POWER	POWER PLANT
	WCB	TRIPLE OFFSET BUTTERFLY VALVE MANUIAL	150LB	28"	12			
 한국지역난방공사 KOREA DISTRICT HEATING CORP.	WCB	NON-SLAM CHECK VALVE HYD CYL.	#150	20"	3	2015	BUCHEON-SOSA BOOSTER PUMP STATION	BOOSTER PUMP STATION
	WCB	NON-SLAM CHECK VALVE HYD CYL.	#150	18"	5	2015	BAEGOT BOOSTER PUMP STATION	BOOSTER PUMP STATION

End User or CUSTOMER	Material	Description	Class	Size	Q'ty	Delivery	PROJECT & REMARKS	INDUSTRY
 POSCO E&C	SCPH2	BALL VALVE RF [MANUAL / PNE.]	10K, 20K	100A, 150A	6	2015	POHANG POSCO	STEEL MILL PLANT
 HYUNDAI STEEL	SM400B	Pressure Relife V/V FF HYD CYL.	10K	400A	1	2015	DANG-JIN Steel MILL Plant	STEEL MILL PLANT
	SS400	COG SHUT-OFF V/V FF HYD CYL.	PN10	DN1000	1			
	SS400	BUTTERFLY DAMPER MANUAL	5K	1000A	1			
 DOOSAN DHI	A105 + STELLITE	GLOBE VALVE SW H/W	#600	1" ~ 2"	42	2015	TAEAN #9,10 PJT	POWER PLANT
 POSCO	ANCOR	MOV GATE V/V	PN2.5	DN1400 DN1200	4	2015	POHANG Hwasung FACILITY 3,4TH MAUN BLOWER COG	STEEL MILL PLANT
	A216WCB	NON SLAM CHECK VALVE HYD CYL.	10K, 20K	400A ~ 700A	6	2015	MRO PART	
 Hanwha HANHWA	CF8M	TRIPLE BUTTERFLY VALVE FLANGE TYPE WITH PNEUMATIC	#150	6"	2	2015	NARO SPACE CENTER	AERO SPACE
		CRYOGENIC CONTROL BUTTERFLY VALVE WITH PNEUMATIC OP'		8"	2			
 SK 에너지 SK ENERGY	CF8C	TRI BFV FLN RTJ PNE.	MAKER STD	78"	1	2015	SK GAS ULSAN PDH PJT	CHEMICAL PLANT
	[LCB/CF8/CF8C]	TRI BFV LUG / FLANGE [PNE. / M/O / BARE]	#150 #300 USER SPEC	2" ~ 78" (CRYOGENIC)	29			
	WCB	HI-P BFV LUG BARE	#150 / #300	24" ~ 48"	5			
	A516-70	SWING CHECK VALVE DOUBLE HYD CYL.	#175	66"	2			
 HYOSUNG ULSAN HYOSUNG	CF8M	TRIPLE BUTTERFLY VALVE WF TYPE	#150	3" ~ 10"	3	2015	POK-1 PLANT PROJECT	CHEMICAL PLANT
 POSCO ENERGY POSCO E.	A536 + R.L	HI-PERFORMANCE BFV	CL.B	78" 108"	4	2014	POSCO ENERGY POWER PLANT #5,6	POWER PLANT
 한화테크엠 HANHWA Tech M	CF8M + PCTFE	CRYOGENIC PNEUMATIC CONTROL BUTTERFLY VALVE	#1500 RTJ	1" ~ 4"	3	2014	NARO SPACE CENTER FLUID : LIQUID OXYGEN TEMP. : 90K(-183°C)	AERO SPACE

















End User or CUSTOMER	Material	Description	Class	Size	Q'ty	Delivery	PROJECT & REMARKS	INDUSTRY
 DOOSAN DHI	A105 + STELLITE	GLOBE VALVE SW H/W	#600	0.75" ~ 2"	45	2014	TAEAN #9,10 PJT	POWER PLANT
 HYUNDAI STEEL	SCS13	BALL VALVE	20K	25A, 40A	249	2014	DANGJIN Steel Mill Plant	STEEL MILL PLANT
	FCD450	MOV WATER SEAL	JIS 5K	1000A	1			
 한국수력원자력 대안발전본부	A395	CONCENTRIC BUTTERFLY VALVE WAFER PNE.	#150	34"	6	2014	TAEAN #5,6 ARP	POWER PLANT
 HYUNDAI HYUNDAI E&C	SCS13A	GLOBE VALVE FLANGE TYPE	30K	350A 450A	4	2014	HYUNDAI STEEL PH.3	STEEL MILL PLANT
 DOOSAN DHI	WC6	NON-CHECK FLN [HYD OP' / PNE.]	150LB	16", 48"	4	2014	HANAM COMBINED HEAT & POWER PLANT PJT	POWER PLANT
		TRIPLE BFV FLN HYD OP'	150LB	16", 48"	4			
 한국지역난방공사 KOREA DISTRICT HEATING CORP	WCB	NON-SLAM CHECK VALVE HYD CYL.	#150	14"	3	2014	GWANGMYEONG BOOSTER PUMP STATION	WATER TREATMENT
	SCPH2	HI-PERFORMANCE BUTTERFLY VALVE WAFER/FLANGE TYPE	10K	350A ~ 800A	30	2014	MAPO-BOOSTER PUMP STATION	BOOSTER PUMP STATION
 GS 네오텍 GS NEOTEK	WCB	NON-SLAM CHECK VALVE	#150	20" ~ 24"	7	2014	ANSAN URBAN DEVELOPMENT PJT	CITY DEVELOPMENT
 한국지역난방공사 KOREA DISTRICT HEATING CORP	A105 + STELLITE	MOV GATE VALVE	150LB, 600LB	1", 2"	4	2014	ULSAN CAPP PROJECT	POWER PLANT
	WCB + STELLITE			4", 8"	3			
 POSCO	SCPH2	GATE VALVE FLANGE TYPE	5K	900A	2	2014	POHANG STEEL MILL PLANT	STEEL MILL PLANT
	SCS13	5-WAY BALL VALVE	10K	65A	1		POSCO FINEX PROJECT	
	A182 F304	BALL VALVE RF	#150	3/4" ~ 3"	9		POSCO COG PJT	
 SAMGONG	FCD	CONCENTRIC BUTTERFLY VALVE (PNEUMATIC CONTROL)	PN10	50A TO 125A	28	2013	PJT NO: P&O ITEM : VOS Ballast Water Treatment System(N.E.I) Hongqiang Marine Heavy Industry Co., Ltd	MARINE















End User or CUSTOMER	Material	Description	Class	Size	Q'ty	Delivery	PROJECT & REMARKS	INDUSTRY
	A216 WCB	3-WAY BUTTERFLY CONTROL VALVE	150LB	500 * 300A	1	2013	ANSAN COMBINED CYCLE POWER PLANT	POWER PLANT
	A351 CF3M	JACKETED GATE VALVE	PN16	DN400	1	2013	HANHWA CHEMICAL ULSAN 3RD FACTORY	CHEMICAL PLANT
		JACKETED BUTTERFLY VALVE			1			
	WC6	TRIPLE OFFSET BUTTERFLY VALVE	150LB	18", 20"	6	2013	YANGJU COMBINED HEAT & POWER PLANT PJT	POWER PLANT
		NON-CHECK VALVE HYD CYL.	150LB	20", 66"	4		POCHEON STEAM TURBINE PJT	
	A216 WCB	HI-PERFORMANCE & TRIPLE OFFSET BUTTERFLY VALVE	150LB	2"~24"	79	2013	HANHWA ORANGE PROJECT	CHEMICAL PLANT
		PTFE LINED BUTTERFLY VALVE	150LB	6"~24"	14			
	SB400B	TRIPLE OFFSET BUTTERFLY VALVE	JIS 5K	1300A	1	2012	BLAST FURNACE SUB-BLOW-OFF	STEEL MILL PLANT
	SS400	DOUBLE SEAT GLOBE VALVE	JIS 10K	500A	1			
	SCPH2	KNIFE GATE VALVE	PN10	DN500	1			
	FCD450	WATER SEAL	JIS 5K	450A~1200A	21	2012	POHANG LDG GAS / POSCO INDONESIA KRAKATAU / POHANG COMBINED CYCLE POWER PLANT	STEEL MILL PLANT
	A516 Gr.70	HI-PERFORMANCE B/V	150LB	24"~136"	12		POSCO INDONESIA KRAKATAU	
	A516 Gr.70	HI-PERFORMANCE B/V	150LB	120"	4		POHANG COMBINED CYCLE POWER PLANT	POWER PLANT
	SCPH2	NON-SLAM CHECK VALVE	JIS 20K	400~800A	10		POSCO INDONESIA BLAST FURNANCE	STEEL MILL PLANT
	A516 Gr.70	HI-PERFORMANCE B/V	150LB	32"~60"	5	2012	POHANG LDG GAS	STEEL MILL PLANT

















End User or CUSTOMER	Material	Description	Class	Size	Q'ty	Delivery	PROJECT & REMARKS	INDUSTRY
 DHI	A216 WCB	3 WAY BFV VALVE	150LB	30" X 14"	1	2012	SEJONG COMBINED HEAT & POWER PLANT PJT	POWER PLANT
	A216 WCB	TRIPLE OFFSET BUTTERFLY VALVE	150LB	12"	3			
 HDEC	SS400 / H.F	TRIPLE OFFSET BUTTERFLY VALVE	JIS 10K	100A TO 1400A	60	2012	HYUNDAI STEEL COKES AND REFINERY PLANT PH3	STEEL MILL PLANT
	EN-GJS400	PTFE LINED BUTTERFLY VALVE	JIS 10K	100A TO 400A	52			
	SS400 / H.F	NON SLAM CHECK VALVE	JIS 10K	900A, 1000A	6			
	SS400	PLATE VALVE	JIS 10K	2000A	1			
	SCPH11 / STL'	JACKETED PLUG VALVE	JIS 10K	25A TO 150A	75			
 eTEC E&C	A351CF8	TRIPLE OFFSET BUTTERFLY VALVE	150LB	8" , 10",12"	7	2012	TS-7000 PJT	OTHERS
 HYUNDAI HYSCO	[SCS13 / PTFE] [SCPH2 / PTFE]	HI-PERFORMANCE B/V	JIS 10K	80A ~ 500A	64	2012	HYUNDAI HYSCO HEATING FURNANCE	STEEL MILL PLANT
 HANJIN HEAVY I&C	A234WPB	T-STRAINER	150LB	10" TO 28"	12	2012	YANGJU COMMUNITY ENERGY SYSTEM PJT	POWER PLANT
	A216WCB / 13Cr.	NON SLAM CHECK VALVE	150LB	16" TO 26"	9			
	A216WCB / 13Cr.	NON SLAM CHECK VALVE	150LB	12" , 16" , 20"	21	2011	CFBC IN UIJUNGBU CFBC IN NAMYANGJU	
 KAERI	A217 WC9	CONTROL BUTTERFLY VALVE	2500LB	26"	2	2011	PNEMATIC ACTUATION AT 280 BAR TEST	NEWCLEAR LABATORY
PNK INDUSTRY	A216 WCB	HI-PERFROMANCE B/V	JIS20K	50A TO 400A	72	2011	LGD PAJU R&D CENTER.	CHEMICAL PLANT
 POSCO	FCD	CENTRIC DESIGN BUTTERFLY VALVE /	10K	900A , 1000A	34	2011	INTERNAL FULL TEFRON COATING FOR ACID/PNEUMATIC OP'	STEEL MILL PLANT
	A536 65-45-12 + R.L	HI-PERFORMANCE B/V	AWWA C504 CL.B	1950A	1		POSCO POWER CCPP 5&6	



















End User or CUSTOMER	Material	Description	Class	Size	Q'ty	Delivery	PROJECT & REMARKS	INDUSTRY
 SEWOONG	B148 C95800	CONTROL BUTTERFLY VALVE PNEUMATIC CONTROL	PN10	DN1400	2	2011	SWCC PROJECT	WATER TREATMENT
 SK E&C	A216WCB	NON RETURN & CONTROL BUTTERFLY VALVE	150LB	60"	2	2011	OSEONG COMBINED CYCLE POWER PLANT	POWER PLANT
 POSCO	SCPH2	HI-PERFORMANCE B/V	JIS10K	200A TO 450A	12	2011	POSCO MRO	STEEL MILL PLANT
	SCS13	TRIPLE OFFSET B/V	JIS10K , JIS20K	250A TO 500A	36			
	SCS13A / SCPH11	BALL VALVE	JIS10K	100A	3			
 HYOSUNG EBARA	A890 5A	GLOBE & BALL VALVE	900LB	50A TO 100A	20	2010	SMART PROJECT	SEA WATER DESALINATION
		DUO CHECK VALVE	900LB	50A TO 100A	4			
 HYUNDAI E&C	A216 WCB	NON SLAM CHECK VALVE	150LB	450A TO 700A	16	2010	DAEJEON ENERGY PROJECT	POWER PLANT
	A216 WC6	3WAY BALL VALVE	1500LB	6"	1			
	A216 WCB	COMBINED CHECK VALVE	150LB	400A TO 600A	18		KOYANG SAMSUNG ENERGY PROJECT	



















SUPPLY RECORDS << OVERSEAS >> Daehan Control Co.,Ltd

















End User or CUSTOMER	Country	Material	Description	Class	Size	Q'ty	Delivery	PROJECT & REMARKS	INDUSTRY
 TOSYALI	 ALGERIA	SS400	HI-P BFV FLN BARE	#150	30", 40", 54", 60", 72"	8	2017	ALGERIA ARZEW REGION PJT	DRI PLANT
			DAMPER BFV FLN BARE		72"	1			
 TECHNO FLOW	 UAE	A395	HI-P BFV LUG L/O	#150	2.5"	57	2017	ABU DHABI AIRPORT PJT	PUBLIC TRANSPORTATION
					3"	108			
					4"	94			
					6"	43			
			HI-P BFV LUG G/O		8"	8			
10"	8								
 HYUNDAI E&C	 INDONESIA	WCB+STL	TRI BFV FLN [LEVER/GEAR]	#150, #300	6" ~ 30"	48	2017	SARULLA GEOTHERMAL POWER PJT	POWER PLANT
 MIDREX	 ALGERIA	SS400	HI-P BFV FLN BARE	PN6	26" ~ 72"	7	2016	NEW STEEL COMPLEX IN BELLARA	STEEL MILL PLANT
 DWRSC	 USA	CF8M	DOUBLE OFFSET BUTTERFLY VALVE LUG G/O	#150, #300	3" ~ 8"	43	2016	Crafton Hills Pump Station expansion	WATER TREATMENT
 ADGAS	 UAE	CF8M	CRYOGENIC BUTTERFLY VALVE WITH PNEUMATIC ACTUATOR	#150	8"	2	2016	ABU DHABI GAS COMPANY PJT -MRO	OIL&GAS
 PROSERMAT	 INDONESIA	WCB	CONCENTRIC BFV WF	#150	2" ~ 12"	11	2016	JANGKRIK Complex Project	FPU
 SAIPEM	 INDONESIA	WCB	CONCENTRIC BFV WAFER	#150	2" ~ 24"	7	2015 ~2016	JANGKRIK Complex Project	FPU
		C95800	HI-P BFV LUG TYPE	#150	3" ~ 24"	287			
		A890 5A	HI-P BFV WAFER TYPE	#150	32"	1			



















End User or CUSTOMER	Country	Material	Description	Class	Size	Q'ty	Delivery	PROJECT & REMARKS	INDUSTRY
JAPAN MOOG	 JAPAN	WCB+STL	LPSV TRIPLE OFFSET BUTTERFLY VALVE, HYD OP'	#300	18"	14	2015 ~2016	DUKE ENERGY, CANADA PJT / TAIWAN PJT	POWER PLANT
 HYUNDAI ENG	 ALGERIA	WCB[CF8M]	TRIPLE OFFSET BUTTERFLY VALVE WAFER L/O	#150	1.1/2" ~ 6"	39	2014 ~2016	Ain Arnat Combined Cycle Power Plant	POWER PLANT
		WCB	CON BFV WF [LEVER/GEAR]	#150	4" ~ 10"	67			
			HI-PERFORMANCE BFV	#150	16"	9			
		WCB	DUO PLATE CHECK VALVE [WF / FLN]	#150	3" ~ 16"	43			
 PMP	 CANADA	CF8	TRI BFV FLN BARE	#150	42"	1	2015	VG ENGINEERING INC.	WATER TREATMENT
 PETROSAND	 UAE	WCB	CONCENTRIC BFV WF TYPE GAER OP'	#150	12"	2	2015	KADDAS OIL FIELD SERVICES	OIL & GAS
		WCB+R.L	HI-PERFORMANCE BFV WF TYPE GEAR OP'	#150	40" ~ 44"	4			
 GS E&C	 CHINA	SCS13	HI-PERFORMANCE BFV WITH PNEUMATIC OP'	JIS 10K	80A~400A	115	2015	GUANGZHOU D-PROJECT II	ENVIRONMENTAL FACILITY
		SCPH2			80A,125A	2			
		SCS14			250A,300A	6			
 GS E&C	 SAUDI	A240Ty.304[316L]	DAMPER FLN RF PNEUMATIC	CL75 CL175	28",36"	4	2015	Rabigh II Project	POWER PLANT
			HI-P BFV FLN RF [PNEUMATIC / BARE STEM]		44" ~ 84"	8			
		A240Ty.304[316L]	DAMPER FLN RF [L/O, G/O]	#75, #150, #175	4" ~ 68"	23			
 SAMSUNG ENG.	 SAUDI	A395	CONCENTRIC BUTTERFLY VALVE WAFER LUG TYPE LEVER OP'&GEAR OP'	#150	6" ~ 18"	58	2015	 الزاسكو السعودية + Saudi Aramco Saudi Aramco Third Party Cogeneration Project	POWER PLANT





















End User or CUSTOMER	Country	Material	Description	Class	Size	Q'ty	Delivery	PROJECT & REMARKS	INDUSTRY
 ADGAS	 UAE	WCB	TRIPLE BUTTERFLY VALVE FLN TYPE GEAR OP'	#150	30" ~ 36"	2	2015	IGDP EI Expansion Project LNG Tie-In	OIL & GAS
 SDCWA	 USA	WCB	TRIPLE BUTTERFLY VALVE FLN TYPE GEAR OP' (GEAR 2" NUT)	#150	30" ~ 72"	4	2015	Inland Empire Utilities Agency - RP1 Outfall relocation city of Ontario	WATER TREATMENT
 HYUNDAI ENG.	 PAKISTAN	[WCB + PTFE] [CF8M + PTFE]	HI-P BUTTERFLY VALVE WAFFER TYPE	#150, #300	3" ~ 20"	9	2014	PAKISTAN ATTOCK REFINERY UPGRADATION PJT (ATOM PROJECT)	REFINERY
		WCB + STELLITE	SEMI STEAM JACKET BFV WF	#150	10"	2			
PACIFIC GAS & ELECTRIC	 USA	WCB	HI-P BUTTERFLY VALVE FLANGE TYPE GEAR OP	#150	60"	2	2014	Potter Valley Penstock Replacement	WATER TREATMENT
 TECHNO FLOW	 UAE	WCB	HI-P BUTTERFLY VALVE LUG TYPE MANUAL & ELECTRIC ACTUATOR OP'	#150	2,1/2" ~ 5"	1154	2014 ~2015	ABU DHABI AIRPORT PJT	PUBLIC TRANSPORTATION
				#150	6" ~ 48"	910			
 SCVWD	 USA	WCB	TRIPLE&HI-PERFORMANCE BUTTERFLY VALVE	CL.D	60" ~ 66"	3	2014	Rinconada WaterTreatment Plant	WATER TREATMENT
				#150	12" ~ 42"	20			
		WCB	TRIPLE BUTTERFLY VALVE FLANGE TYPE GEAR OP'	#150 #300	8", 12"	11	2014	Carlsbad desalination pipeline	
				C207 CL.E	54" ~96"	7			
 SK E&C	 PANAMA	A536+R.L	HI-P BUTTER FLY VALVE FLANGE TYPE ACTUATOR	#150	60"	12	2014	PACO Coal Fired Power Plant	POWER PLANT
 GS E&C	 CHINA	SCS13	HI-P BUTTERFLY VALVE WAFFER BARE	10K	150A ~ 250A	31	2014	GUANGZHOU D-PROJECT	ENVIRONMENTAL FACILITY
 CONAGUA	 MEXICO	A395+RUBBER SEAT	HI-P BUTTERFLY VALVE FLANGE TYPE	PN40	DN2850	4	2014	CONAGUA Cutzamala Raw Water Pumping Station	WATER TREATMENT



End User or CUSTOMER	Country	Material	Description	Class	Size	Q'ty	Delivery	PROJECT & REMARKS	INDUSTRY
 DOOSAN	 UAE	A105	GLOBE VALVE SW	#600 ~#900	0.5"~1.5"	174	2014 ~2017	BARAKAH NPP TG #1~4 PROJECT	NEWCLEAR POWER PLANT
		F11 CL.2	LIFT CHECK VALVE	#2500	1"	8			
		WCB +STELLITE	SWING CHECK VALVE	#150	4"	8			
		WCB + STELLITE	GATE VALVE	#150	4"	12			
 ANADARKO	 MEXICO	A395	CON BUTTERFLY VALVE WAFFER BARE	#125	24", 42"	56	2012~2014	ANADARKO HEIDELBERG PROJECT	OFF-SHORE
 ALTON International	 INDIA	CF8M+STL(#21)	HI-P BUTTERFLY VALVE FLANGE TYPE RF ACT.	#150	8" ~ 26"	11	2013	CAIRN Energy India Ltd.	OIL & GAS
 TECHNIP	 USA	A395	HI-PERFORMANCE BFV	#125	42"	20	2013	ANADARKO LUCIUS PROJECT	OFF-SHORE
 POSCO E&C	 BRAZIL	SS400 + VITON / WCB / SS400	HI-P BUTTERFLY VALVE	SZ(POSCO) 150LB 300LB	3" TO 120"	135	2014	POSCO Brazil CSP Steel Plant PROJECT	STEEL MILL PLANT
		A536 / WCB	CONCENTRIC BUTTERFLY VALVE WAFFER GEAR	#150	3" TO 40"	347			
		WCB	NON-SLAM CHECK VALVE HYD CYL	300LB	16", 26", 30"	10			
		A182 F304/ WCB / A105	BALL VALVE SW,NPT,FLN	#150,#300	1/2" TO 3"	117			
 SDCWA	 USA	WCB	TRIPLE OFFSET BUTTERFLY VALVE FLANGE TYPE ACT.	#150	54", 72"	2	2013	TWIN OAKS VALLEY WTP improvements	WATER TREATMENT
 DWRSC	 USA	CF8M+PTFE	BALL VALVE FLANGY TYPE GEAR OPERATOR	#300	6",8" 10",12"	10	2013	DWR PROJECT Crafton Hills PS expansion / Citrus PS	WATER TREATMENT
 SCVWD	 USA	WCB	TRIPLE OFFSET BUTTERFLY VALVE	C207 CL.D FF	60", 72"	2	2013	Rinconada WaterTreatment Plant	WATER TREATMENT
 ADGAS	 UAE	CF8M	ON-OFF BUTTERFLY VALVE(Cryogenic)	#150	8"	1	2013	ABU DHABI GAS COMPANY PJT -MRO	OIL & GAS
		A352LCB+STL	ON-OFF BUTTERFLY VALVE FLANGE TYPE ACTUATOR		8", 22"	2			

End User or CUSTOMER	Country	Material	Description	Class	Size	Q'ty	Delivery	PROJECT & REMARKS	INDUSTRY
 GREEN CORE	 PHILIPPINES	A126CL.B+R/L	HI-P BUTTERFLY VALVE FLANGE TYPE RF G/O	USER SPEC	60"	2	2013	Power Plant in Philipines, Suction Valve	POWER PLANT
 HYUNDAI E&C	 UZBEKISTAN	WCB	TRIPLE OFFSET BUTTERFLY VALVE	150LB	2" TO 16"	275	2013	Uzbekistan UGCC PROJECT	GAS & CHEMICAL
 GS E&C	 CHINA	SCPH2	HI-P BUFFERFLY VALVE	JIS 10K	100A TO 450A	70	2013	GUANGZHOU D-PROJECT	ENVIRONMENTAL FACILITY
		SCPH2	TRIPLE BUTTERFLY VALVE	JIS 10K	125A TO 250A	3			
 SAMSUNG ENG	 BAHRAIN	WCB	TRIPLE OFFSET BUTTERFLY VALVE	150LB	2" TO 24"	8	2013	SE2404/MUHARRAQ STP PJT	SEWAGE TREATMENT PLANT
 POSCO PLANTEC	 THAILAND	WCB	NON SLAM CHECK VALVE HYD CYL	150LB	32"	1	2013	Thailand MOC PJT	CHEMICAL PLANT
 SDCWA	 USA	WCB	TRIPLE OFFSET BUTTERFLY MOTOR OP.	300LB	48"	1	2013	AA pipeline turn out	WATER TREATMENT
 RCWD	 USA	WCB	TRIPLE OFFSET BUTTERFLY [GEAR OP. / MOTOR OP.]	150LB	36", 48"	4	2013	Vail Lake Conveyance Dreissena mussel control facilities	WATER TREATMENT
 POSCO	 INDONESIA	SS400+VITON	HI-P BUTTERFLY VALVE FLANGE TYPE ACTUATOR	SZ(POSCO)	1500A ~ 3400A	4	2013	INDONESIA PT. Krakatau Posco PROJECT	STEEL MILL PLANT
		SS400+METAL TOUCH	CONTROL BUTTERFLY DAMPER	10K	600A ~ 1200A	4			
		FCD450 + VITON	WATER SEAL MOTOR OP'	10K	600A ~ 1200A	10			
		A105	GLOBE VALVE ACTUATOR OP	10K	50A	2			
 MEW KUWAIT	 KUWAIT	[WCB+R.L/316L] [CF3M+PTFE]	NON SLAM CHECK VALVE HYD CYL	#150	6" ~ 18"	30	2013	Combined Cycle Power Project CCGT-2	POWER PLANT
		WCB+R.L/316L	GATE VALVE FLANGE TYPE G/O	#150	10" ~ 12"	15			
		[F316L/F316L+ENP]	FLOTING BALL VALVE FLANGE TYPE MANUAL OP	#600	1"	18			

End User or CUSTOMER	Country	Material	Description	Class	Size	Q'ty	Delivery	PROJECT & REMARKS	INDUSTRY
 BOROUGE	 ABU DHABI	WCB+RL	HI-PERFORMANCE BUTTERFLY	150LB	72"	4	2012	SEA WATER BASIN PROJECT	SUB-SEAWATER SUPPLY PIPELINE
 TECHNOFLOW TECHNO FLOW	 UAE	FCD450	HI-PERFORMANCE BFV	150LB	4" TO 18"	22	2012	United States Coast Guard	MARINE
 CEPHAS BFV CEPHAS	 CANADA	A494C W6MC	TRIPLE OFFSET BUTTERFLY	150LB	4"	10	2012	HIGH TEMPERATURE SYSTEM 800°C	JET PLANE
 USA	 USA	WCB	TRIPLE OFFSET BUTTERFLY MOTOR OP.	150LB	60"	1	2012	Bay Division Pipeline, Peninsula Reach 5	WATER TREATMENT
 TORISHIMA PUMP	 JAPAN	A105	BALL VALVE	150LB	1"	14	2012	FLOW CONTROL VALVE AT TORISHIMA R&D CENTER	STEEL MILL PLANT
		WCB	TRIPLE OFFSET BUTTERFLY VALVE ELECTRIC MOTOR OP	300LB	3",12"	2			
 SAMSUNG ENG.	 SAUDI	WCB	HI-PERFORMANCE B/V	150LB	3" TO 28"	272	2012	MA'ADEN ALUMINUM ROLLING MILL PROJECT	ROLLING MILL PLANT
		A536	CONCENTRIC BUTTERFLY	150LB	4" TO 24"	75			
		WCB	TRIPLE OFFSET B/V	150LB	4"	1			
		WCB+R.L	COMBINED CHECK VALVE W/ELECTRIC ACTUATOR	150LB	24"	10			
 JACOBS	 MOROCCO	A126	HI-PERFORMANCE BFV	150LB	6" TO 16"	52	2012	Di-Ammonium Phosphate Plant	CHEMICAL PLANT
		SS UB6	HI-PERFORMANCE BFV	160LB	6" TO 16"	27			
		HASTELOY-C276	SWING CHECK VALVE	300LB	3" TO 8"	15			
		WCB	HI-PERFORMANCE BFV	150LB	8"	4			
 DHI	 SAUDI	F316	BALL VALVE	PN10	15A TO 150A	111	2012	MARAFIQ-YANBU SWTP PJT	SANITARY WASTEWATER TREATMENT PLANT

End User or CUSTOMER	Country	Material	Description	Class	Size	Q'ty	Delivery	PROJECT & REMARKS	INDUSTRY
 SAMSUNG ENG.	 BAHRAIN	WCB	HI-PERFORMANCE B/V	150LB	6" TO 48"	27	2012	SE2404/MUHARRAQ STP PJT	SEWAGE TREATMENT PLANT
		WCB	CONCENTRIC BUTTERFLY	150LB	2" TO 40"	131			
	 MEXICO	WCB	CONCENTRIC BUTTERFLY VALVE	150LB	6" TO 12"	20		NORTE II CCGT POWER PJT.	POWER PLANT
 MODEC	 SINGAPORE	B148 C95800	DUO PLATE CHECK VALVE & GLOBE VALVE	150LB	3" GLOBE 4" CHECK	15	2011	MARINE SYSTEM-ACCOMMODATION FIREWATER RISER LINES	MARINE
 bp	 ANGOLA	B148 C95800	TRIPLE OFFSET BUTTERFLY VALVE, BI-DIRECTION FLOW	150LB	2" to 18"	32	2011	SEA W.SERVICE TO DECK MACH COOLER	OFF-SHORE
		A216 WCB	HI-PERFORMANCE B/F	PN6	DN700	1	2011	EXTENDED STEM FOR 250°C TEMP.	OTHERS
 FENIWA	 GERMANY	A352 LCB	TRIPLE OFFSET BUTTERFLY VALVE	300LB	12" , 20"	10	2011	NACE MR-0103 , wet H2S & Amine-Containing service , Hydrocarbons with H2 and H2S Gas TEMP.385°C~435°C LIFE TIME:5000CYCLES/100,000h	OIL & GAS
		A351 CF8C	HIGH TEMP. TRIPLE OFFSET BUTTERFLY VALVE	300LB	12" , 20"	3	2011		
 PMP	 CANADA	A536	TURBINE ISOLATION BUTTERFLY VALVE, BI-DIRECTION FLOW	AWWA C207	78"	1	2011	CANADIAN HYDRO COMPONENTS DTEWART'S BRIDGE	WATER TREATMENT
 SAMSUNG ENG,	 ALGERIA	A351 CF8	CONCENTRIC DESIGN BUTTERFLY VALVE	150LB	3" to 18"	207	2011	SKIKDA REFINERY PROJECT	REFINERY
		A216 WCB	TRIPLE OFFSET BUTTERFLY VALVE, BI-DIRECTION FLOW	150LB 300LB	8" ~ 28"	81			
 SINOPEC	 SAUDI	WCB	JACKET TYPE METAL BALL VALVE	900LB	3" , 6"	3	2011	SAUDI KAYAN LDPE PROJECT	PETROCHEMICA COMPLEX
CITY & COUNTY OF SAN FRANCISCO	 USA	WCB	BUTTERFLY VALVE & DOUBLE DOOR CHECK VALVE	250LB	12" TO 78"	9	2011	San Joaquin Pipeline #4 Eastern System	WATER TREATMENT
 DOOSAN	 QATAR	A890 5A	CONCENTRIC BUTTERFLY VALVE	150LB	4"	16	2011	QATAR QATALUM PROJECT.	POWER PLANT
	 INDIA	A216WCB	HI-PERFORMANCE B/V	300LB	3" , 4"	16		DOOSAN AT RAIPUR PJT.	

End User or CUSTOMER	Country	Material	Description	Class	Size	Q'ty	Delivery	PROJECT & REMARKS	INDUSTRY
 TECHNOFLOW	 UAE	A536	DOUBLE ECC. B/V	150LB	16"	2	2011	DUBAI MERTO SERWISE FUSION BONDED EXPOXY COAT	PUBLIC TRANSPORTATION
		A536	HI-PERFORMANCE B/F	PN16	12",8"	18	2011		
	 OMAN	A216 WCB	CONCENTRIC HIGH PRESSURE BUTTERFLY VALVE	150LB	3" to 24"	210	2011	MUSCAT AIRPORT PROJECT.	
	 TANZANIA	WCB	ELECTRIC CONTROL 3-WAY BALL VALVE	150LB	10" TO 20"	51	2011	UBUNGO POWER PLANT EXPANSION PROJECT TANZANIA	POWER PLANT
 HYUNDAI E&C	 ROMANIA	A216 WCB	DUO CHECK VALVE	150 LB	16" TO 24"	10	2011	Alum Tulcea Project	POWER PLANT
 STX	 MOROCCO	A126 CLB	DUAL CHECK VALVE	150LB	6" , 8"	6	2011	STX MOROCO JORF PROJECT	MARINE
 TORISHIMA PUMP	 JAPAN	A536	HI-PERFORMANCE B/F	125LB	28", 36"	6	2011	UNITED STEEL COMPANY SLOB DR PLANT PROJECT	STEEL MILL PLANT
 ZURICH CHILE	 CHILE	2205 DUPLEX	METAL SEAT BALL VALVE	600LB	2"	5	2011	HIDRAULIC ACTUATOR W/HIDRAURIC OIL POWER	MINE
 BP	 ANGOLA	B148 C95800	HI-PERFORMANCE B/V	150LB	2.5" TO 22"	26	2010	BP ANGOLA PSVM	FPSO
		B148 C95800	DOUBLE FLAP CHECK VALVE	150LB	18"	6			
 PMP	 CANADA	WCB	TRIPLE OFFSET BUTTERFLY	150LB	60"	1	2010	BAY DIVISION PIPELINE RELIABILITY UPGRADE CITY OF SANFRANCISCO	WATER TREATMENT
	 USA	WCB	TRIPLE OFFSET BUTTERFLY	150LB	16" TO 60"	73	2010	Vail Lake Project Rancho California Water District	
 SAMSUNG ENG.	 ALGERIA	WCB + ST	TRIPLE OFFSET B/V	150LB , 300LB	8" TO 28"	81	2010	SKIKDA REFINERY PROJECT	REFINERY
 TECHNO FLOW	 UAE	DUCTILE	DOUBLE ECC. B/V & HI-PERFORMANCE B/V	150LB / PN16	8" TO 16"	106	2010	DUBAI MERTO SERWISE FUSION BONDED EXPOXY COAT	PUBLIC TRANSPORTATION

End User or CUSTOMER	Country	Material	Description	Class	Size	Q'ty	Delivery	PROJECT & REMARKS	INDUSTRY
 ZURICH-CHILE	 CHILE	ALLOY20	LUGGED BUTTERFLY VALVE	150LB TO 900LB	2.5" TO 40"	749	2010	AMPLIACION DUMP NORTE MV	MINE
		ALLOY20	TRIPLE OFFSET B/V	600LB	8"	33			
		DUPLEX 2205	BALL / HI-PERFORMANCE / DUO CHECK VALVE	150LB , 300LB, 600LB	4" TO 32"	206	2010	VALVULA BOLA	
		A216WCB	HI-PERFORMANCE B/V	150LB / 300LB	4" TO 10"	412	2009	PAPOMONO	

COMPANY PROFILE

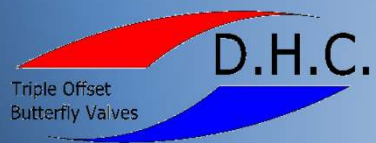

DAE HAN CONTROL CO., LTD.