

DAKOTA OCTAVE MANDOLIN KIT and MANDOCELLO KIT



MUSICMAKER'S KITS, INC
PO Box 2117
Stillwater, MN 55082

651-439-9120
harpkit.com



WOOD PARTS:

DAKOTA OCTAVE MANDOLIN KIT

- A - Neck
- B - Fretboard
- C - Heel Block
- D - Tail Block
- E - 2 Heel Ribs
- F - 2 Side Ribs
- G - 2 Tail Ribs
- H - 4 Corner Blocks
- I - Back Panel
- J - 3 Cross-Braces for Back
- K - 2 Flat Braces for Back
- L - Front (Soundboard)
- M - 10 Braces for Front (Soundboard)
- N - 6 Inner Kerfing Strips
- O - Bridge (with Saddle & 8 pegs)
- P - Bridge Clamp, w/4 machine screws, 2 washers, 2 wing nuts
- Q - Bridge Plate
- R - 4 Clamping Wedges
- S - Spacer Block
- T - 6 Binding Strips, walnut
- U - Heel Cap
- V - Truss Rod Cover (with 3 screws)

HARDWARE:

- W - 48 Inches Fretwire
 - X - 1 White Side Marker Rod 5/64" X 2"
 - Y - 8 Black Geared Tuners w/8 sleeves, 8 washers & 8 tiny screws
 - Z - Double Truss Rod, with allen wrench
 - 8 - Pearl Marking Dots, 1/4" dia.
 - 1 - Heavy Fretwire, 2" long, for #0 fret
 - 1 - Set of 8 Strings
 - 1 - Black Wood Nut
 - 1 - Hex Bolt, 1/4" X 2", with washer
 - 2 - Tiny Nails
 - 1 - Drill Bit, 1/16" for tiny screws
 - 1 - Drill Bit, 5/64" for Side Markers
 - 1 - Drill Bit, 3/16" for bridge
- Assembly Instructions**

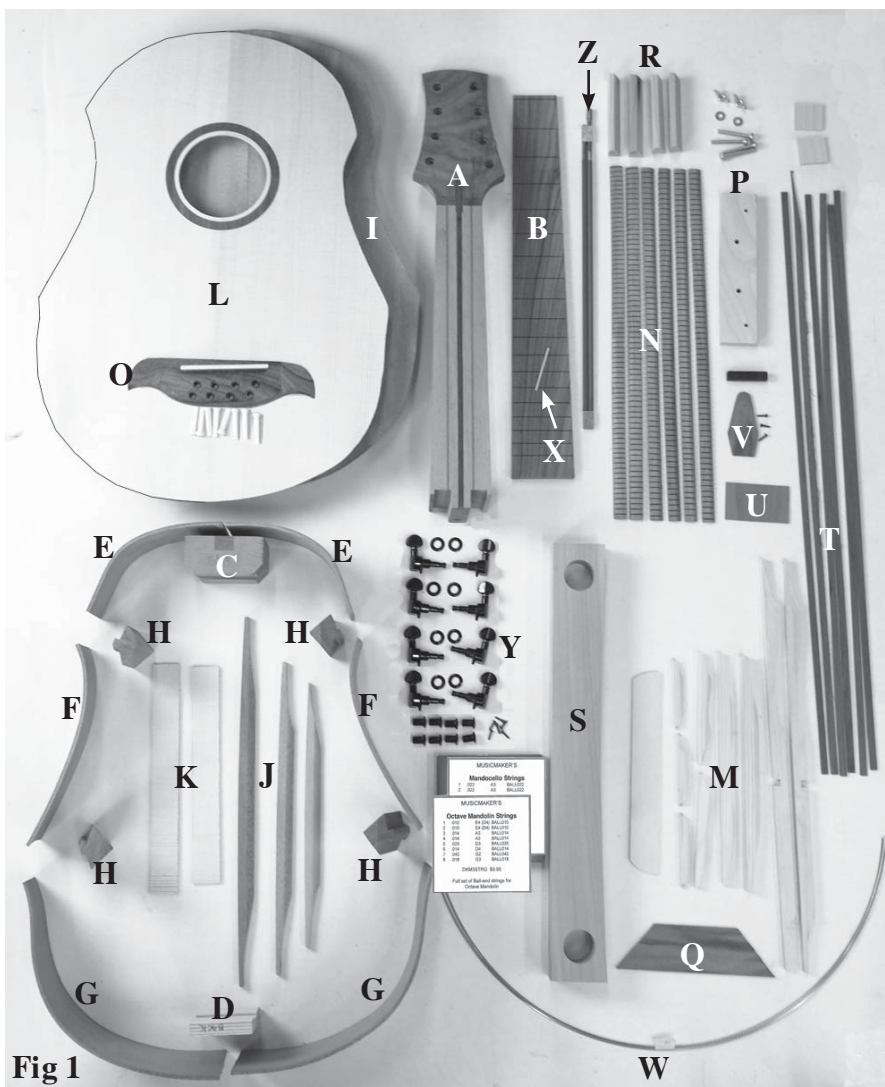

If you have any questions about the assembly of your kit - please visit our online Builder's Forum

www.harppkit.com/forum

A NOTE ABOUT GLUE

We recommend assembling this kit with standard woodworker's glue (such as Elmer's Carpenters Glue or Titebond Wood Glue). Don't use Hotmelt glue, Superglue, 5-minute Epoxy, or the plain white School Glue for assembling the major wood parts -- they are not strong enough for a musical instrument. There is no need to look for any special violin-maker's adhesive. You may, however, see epoxy or superglue recommended occasionally for installing non-wood parts.

Every time you use wood glue on this project, it is wise to have a damp rag handy for cleaning up afterwards. It is always best to scrub away any excess glue that squeezes out of the joints before it dries, especially on the outside of the instrument. Keep your hands and workbench as clean as possible too. Glue smudges will show up vividly on the finished instrument.

ASSEMBLY INSTRUCTIONS

1. CAUTION: PLEASE DO NOT OPEN THE SEALED PLASTIC BAG CONTAINING THE FRONT AND BACK PANELS UNTIL YOU REACH STEP #14. These two parts need to be kept very dry until you glue the braces on them. Check over your kit parts to make sure you find everything listed (see fig. 1 above). Contact us right away if you are missing anything so we can rectify the problem without causing too much delay for you. We also recommend checking off each step in the directions as you finish it. You might be skipping forward to another part of the assembly while waiting for something to dry, and it helps to keep track of where you left off.

GLUING THE BODY FRAME

It is smart to skim through the entire directions before beginning, just to get an overview of the project. You may need to gather more tools or purchase a few optional decorations or accessories to enhance the finished instrument. Now is a good time to make those plans so you can avoid delays later. Here are a few of the small items you'll want to have on hand:

sharp chisel	wire cutter	8 spring clamps	2 long-reach clamps for braces
masking tape (blue)	clothes pins	8 small c-clamps	40 ft bungee cord (3/16" dia)
carpet tape	razor knife	triangle file	router with flush-trim & inlay bits
straight-edge	6" rat tail file	flat mill file	wood filler (mahogany color)

____2. You will find it very helpful to make yourself a perfectly flat work surface out of 3/4" thick plywood or particle board for use as a flat clamping pad under the body of the instrument. If you cut it about 1" larger than the shape of the soundboard, you will be able to easily fit clamps all the way around the perimeter of the instrument (fig 2a).

Another idea that works well is to use a rectangular piece about 22" X 28" (fig 2b) so you can clamp with bungee cords, as shown in steps 21 and 31. We use both types, as you will see in various photos. Just make sure the clamping pads are good and flat.



CAUTION: IT IS POSSIBLE TO ASSEMBLE THE FRAME PARTS UPSIDE DOWN OR BACKWARDS!

____3. Carefully arrange the side pieces, corner blocks, heel block and tail block on your plywood clamping board to see how they fit together (Fig 3).

CAUTION: Orient all parts so the front edges face downward on your flat clamping board. Notice that we have marked each side piece, and heel & tail blocks, indicating the proper orientation.

All front edges are marked "SB" for soundboard, and the back edges are marked "B".

The corner blocks do not have a front or back, but they are numbered C-1 or C-2 to fit the corners with those numbers. Please take the time to study this carefully so your parts will fit properly.

ORIENT ALL PARTS WITH FRONT EDGES FACING DOWN

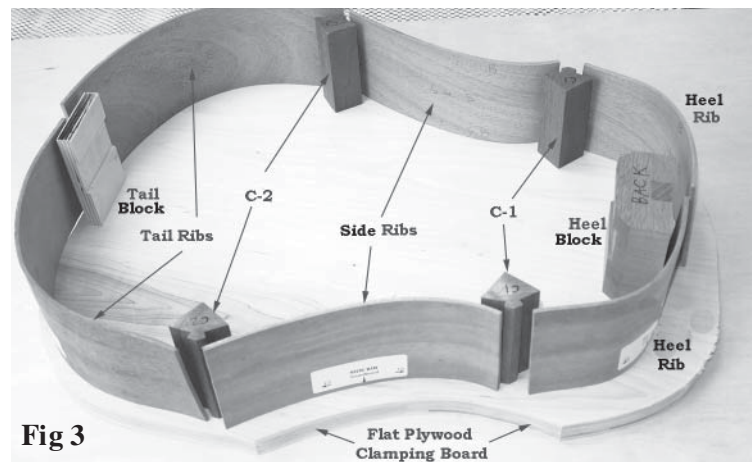

____4. Begin by gluing and clamping the four corner blocks to the two side ribs, taking care to orient them at the correct ends, as printed on the wood (each side rib gets a C1 at one end and a C2 at the other end).

CAUTION: The larger part of the corner blocks will face the inside of the body, as shown in fig 3. Don't glue them to the outside of the sides!

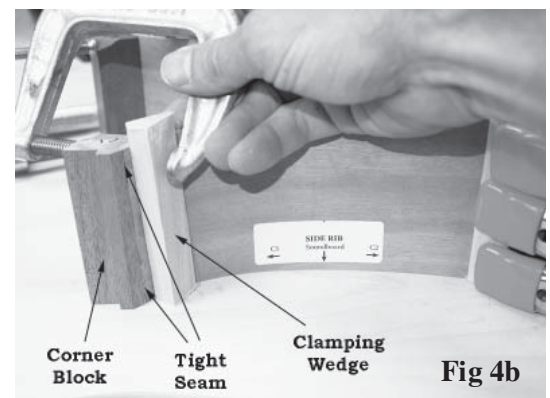
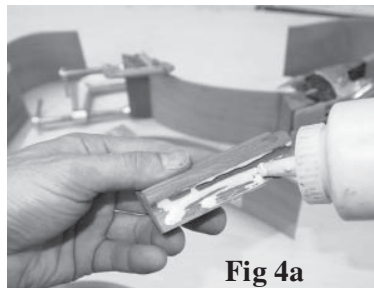

Clamping wedges are provided to help compensate for the angles of the parts, as shown in fig 4b. **HINT:** If you cover the wedges with Scotch tape, they won't get stuck to the other parts when clamped.

Use either spring clamps or small c-clamps for this step (fig 4c), making sure the parts are fully seated together and flat on the edges. Use a wet rag to clean off excess glue that squeezes out. This helps you see the joints clearly, as well as prevent messy glue spots on the instrument.

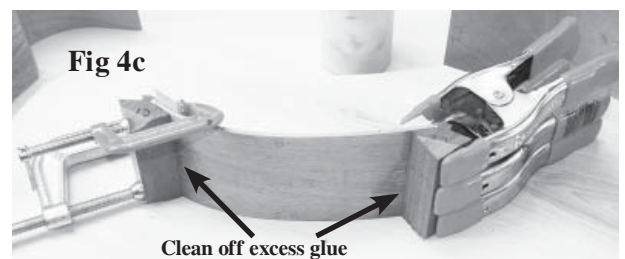

QUESTION

Have you checked to make sure you are still gluing the parts in the correct positions? If you find a corner block glued to the wrong end of a rib, you'll need to correct it now, before proceeding further. You can soften the dried glue by getting the seam wet to allow the parts to be separated without breaking anything. Be patient with this process. It may take 10-20 minutes for water to penetrate far enough into the seam to soften the glue.

____5. While the corner blocks are drying, you can work on the tail end of the body. Use tape to hold the tail ribs together as shown in fig 5a.

Find the center of the tail block and mark it clearly (fig 5b).

Smear glue on the flat face of the tail block (fig 5c) and place it inside the seam, as shown in fig 5d. Find a scrap of wood to use as a clamping pad for the outside of the joint, and add clamps, making sure the block is oriented correctly and nicely centered on the seam (fig 5e).

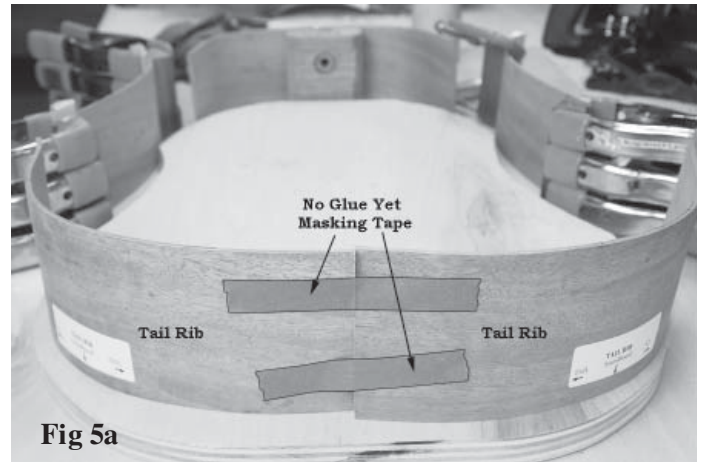
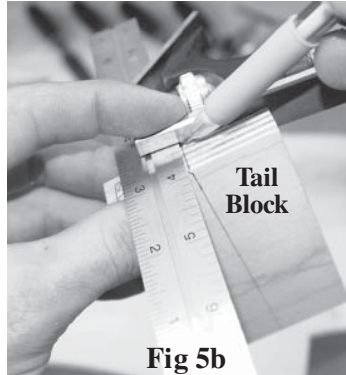

IMPORTANT: Make sure the free ends of the tail ribs can be pushed down to the work surface (fig 5e). If not, then you may have to release the clamps and slide the parts into better alignment.

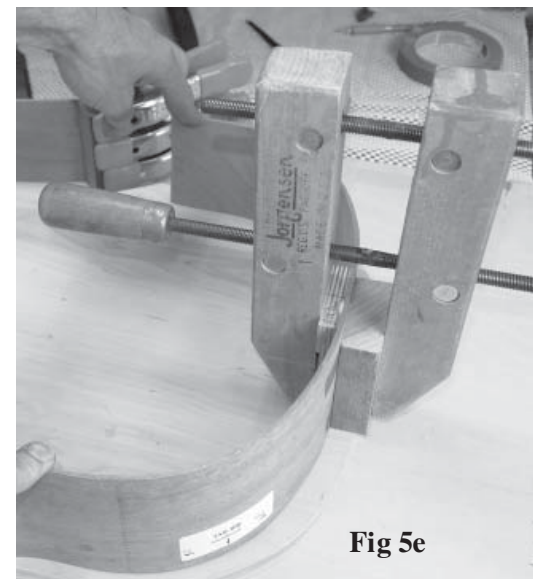
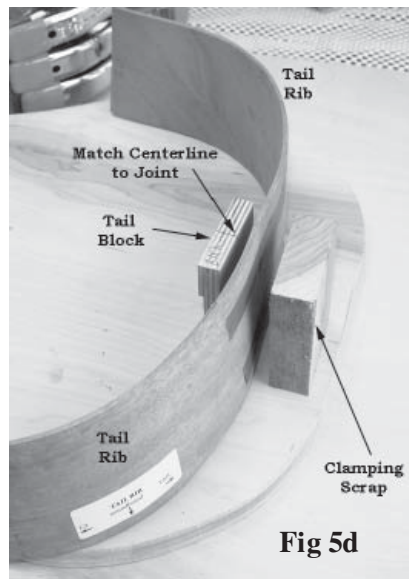
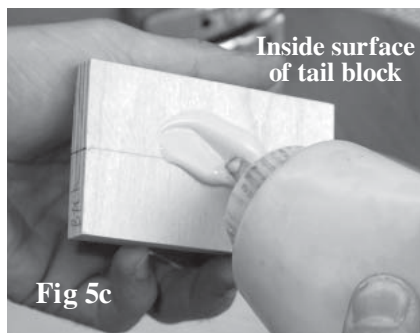

____6. Now you can move to the heel end of the instrument. Mark the center of the heel block, on the end marked "Back" (fig 6a).

Glue this heel block to one heel rib for now, aligning it to the centerline, as shown in fig 6b.

Clean up excess glue with a wet rag, as usual.

IMPORTANT: Leave the other heel rib for later. That will be the last step in closing the frame.

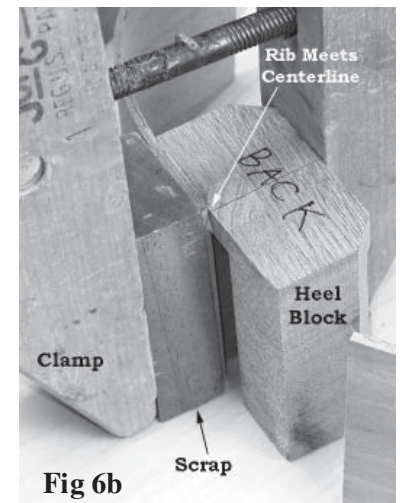
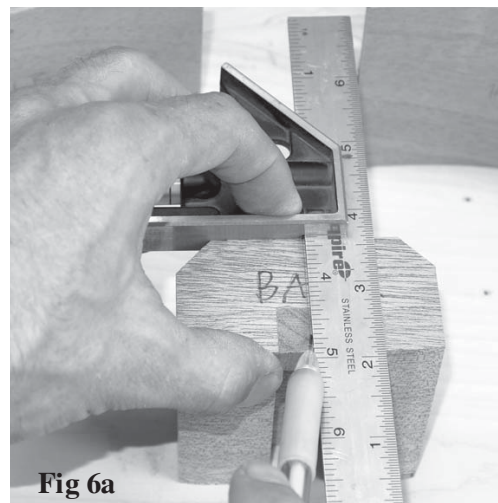

____7. When the corner blocks are dry, you can remove the clamps and glue the C2 blocks to the tail ribs, as shown in fig 7a.

Make sure you can press the C1 corner blocks down against the work surface when the side ribs are clamped to the tail ribs. This ensures a flat frame for gluing the front (soundboard) in place later.

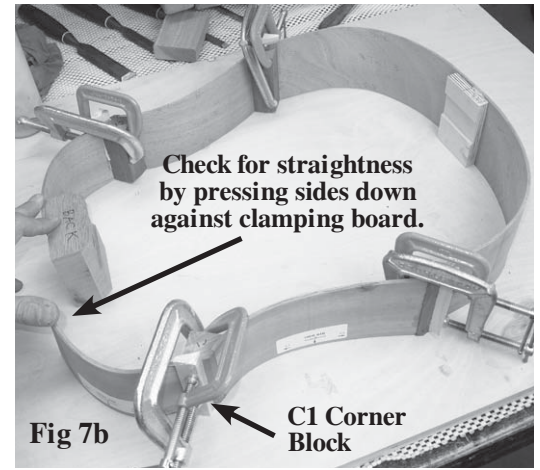
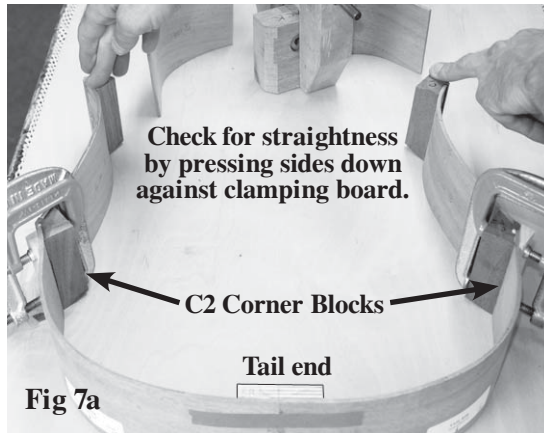

Leave the clamps on these C2 joints while you glue the remaining heel rib to the open C1 corner, as shown in fig 7b. Leave clamps in place for several hours to make sure the glue has cured to full strength.

PAUSE AND DOUBLE-CHECK

Before going further, double-check to make sure your parts are still in the correct positions. Do you see “Back” written on the same edge of all the parts around the frame? If you find something oriented upside-down or backwards, you’ll need to correct it now, before proceeding further. You can soften the dried glue by getting the seam wet to allow the parts to be separated without breaking anything. If the glue is fully cured, it may take 10-20 minutes for water to penetrate far enough into the seam to soften the adhesive.

____8. When the four corner joints have dried fully, use tape to pull the last heel rib into place at the heel block as shown in fig 8a.

Remove the tape so you can apply glue, and then tape the parts together again as you clamp this last joint together permanently (fig 8b).

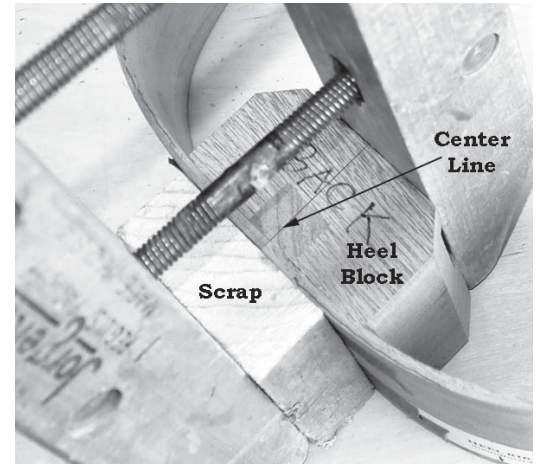
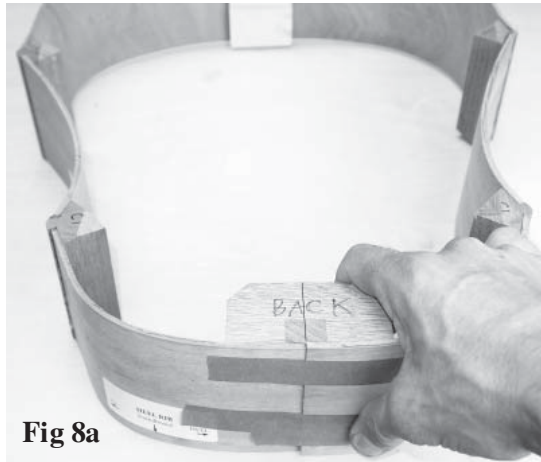

____9. Once the frame is closed and the glue is dry, you can install the long spacer block between the heel and tail blocks as shown in fig 9. This piece will be removed later, but you need it now to hold the frame to the correct size. Note that the ends of the spacer will fit into the pre-cut grooves of the heel and tail blocks. Use a clamp at each end to make sure the heel and tail blocks are held firmly in alignment.

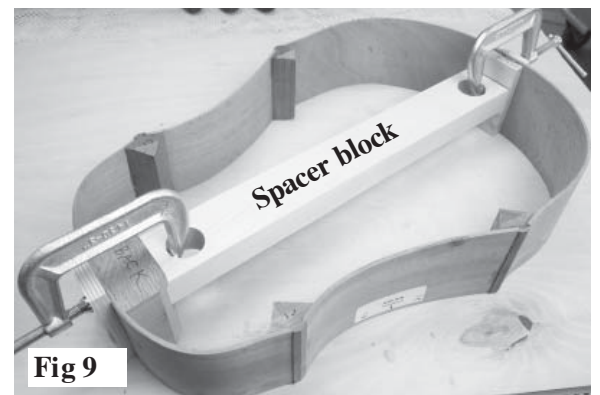

____10. Flip the instrument over (soundboard edge up) so you can fit kerfing inside the frame. Cut a length of kerfing to fit between the corners and blocks inside each rib (fig 10a & 10b). We like to cut these strips a little oversize and then sand them to fit nicely into the corners, as shown in fig 10c and 10d. CAUTION: Be sure to orient the kerfing with the flat side up, level with the top edge of the ribs.



Fig 10a

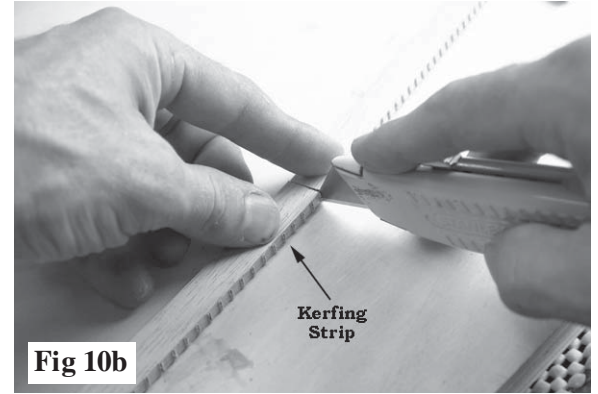

Fig 10b



Fig 10c



Fig 10d

CHECK-POINT: You should be installing the kerfing on the soundboard edge of the frame. You should see "S.B." written on the ribs at this edge of the frame all around.

We use spring-type clothes pins to clamp the kerfing in place (fig 10e), but you may find some other small clamps to pinch the parts together while you glue these kerfing strips in place. If necessary, you can increase the clamping pressure by wrapping rubber bands around the clamps as we have.

Work your way around the soundboard edge of the frame with the kerfing, but don't do the back edge yet -- that will be easier to do later.

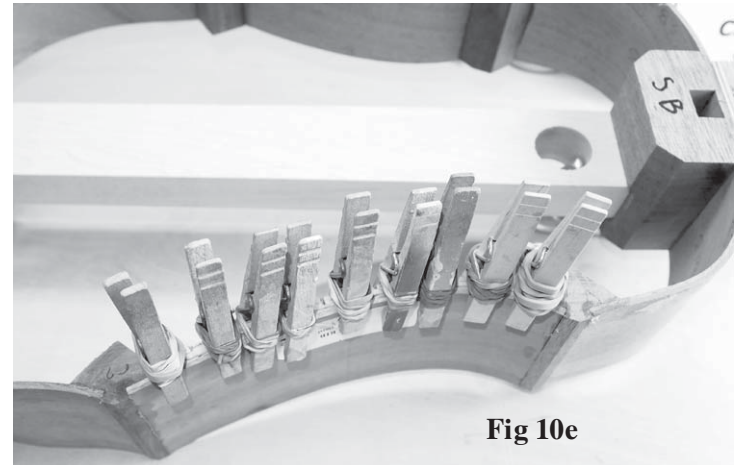

Fig 10e

____11. **OPTIONAL:** You can reduce the weight of your instrument a little by trimming off the large inside corners of the corner blocks, as shown in fig 11a. This step is optional, but it is recommended.

The illustration shows a chisel, but we use a power drum sander to do this job more quickly. You'll want the corners to be trimmed so they blend in with the thickness of the kerfing, as shown in fig 11b.

NOTE: If you decide to leave the corner blocks full size, you should at least bevel the tops of the inside corners by sanding them at an angle so they won't touch the soundboard (fig 11c). This helps prevent cracks in the soundboard later, and allows for a little more vibration in the top.

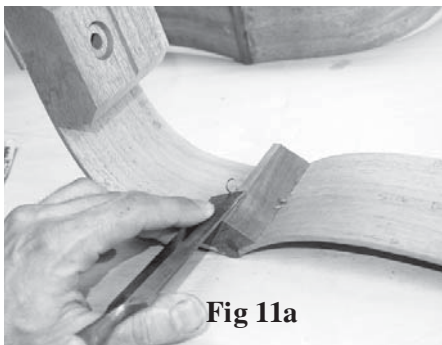

Fig 11a

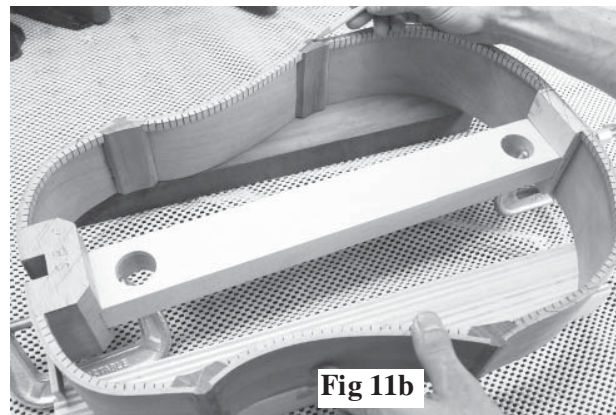

Fig 11b

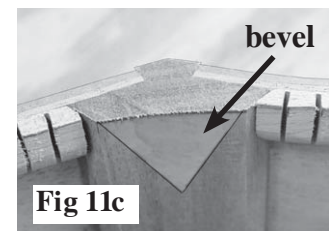

Fig 11c

____12. This is a good time to open up the slot for the tenon in the heel block so it looks like fig 12a below. You could do this by hand with a sharp chisel and/or razor knife, but we use a router with a flush trim bit (fig 12b). The goal is to trim away all rib material that covers the pre-cut slot in the heel block.

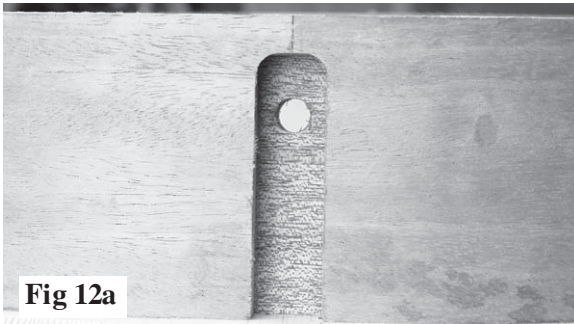

Fig 12a

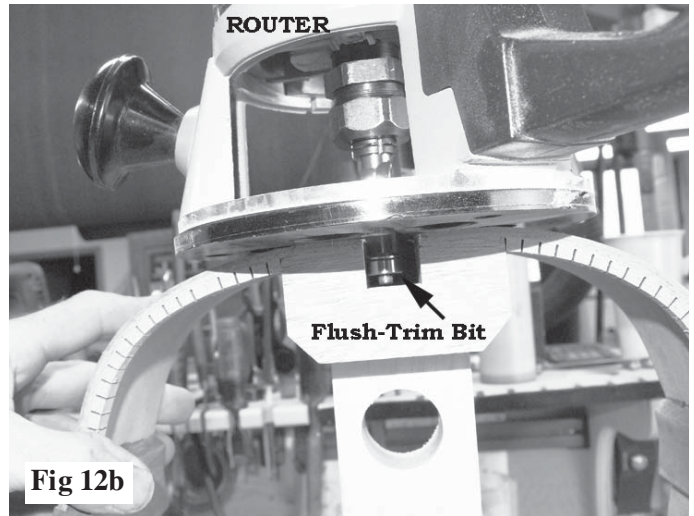

Fig 12b

____13. Make yourself a long sanding block now, using a flat board about 2-3" wide and at least 16" long.

Apply double-stick carpet tape to the flat face of the sanding block, covering the face the full 16" length (fig 13a).

Cut coarse sandpaper (60 grit) to match the width of the board and press the clean side down against the tape (fig 13b). You can add to the length of the sandpaper by pressing a second piece in place at the end of the first.

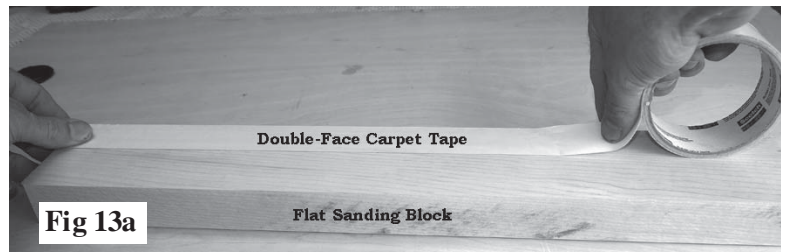

Fig 13a



Fig 13b

Pencil hash-marks on the kerfing around body, as shown in fig 13c.

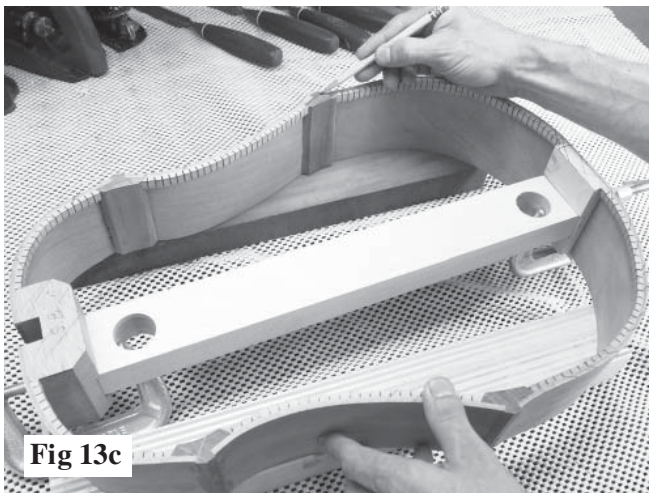

Fig 13c

Then use your flat sander to level the entire front edge of the frame. Keep the sanding block flat by always having both ends resting across the instrument, as shown in fig 13d.

The pencil marks should all be cleaned off by this sanding work. Keep sanding until they are all removed.



Fig 13d

PREPARING THE SOUNDBOARD

____14. Now you can open the sealed bag and begin working on the soundboard. First thing is to outline the inside of the frame on the inside face of the soundboard so you know how to trim the braces.

We have marked the location of most of the braces in pencil, but there are a few things you need to draw. Begin with making a line 4" from the sound hole and perpendicular to the center line, as shown in fig 14a.

Center the frame of the instrument on the centerline of the soundboard, lining up the heel end with your pencil mark (fig 14b).

Then draw a pencil line around the inside of the frame to show where the kerfing touches the soundboard (fig 14c).

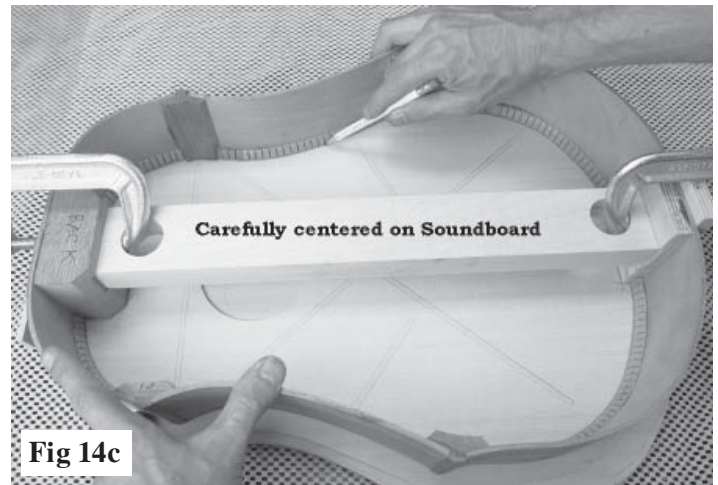
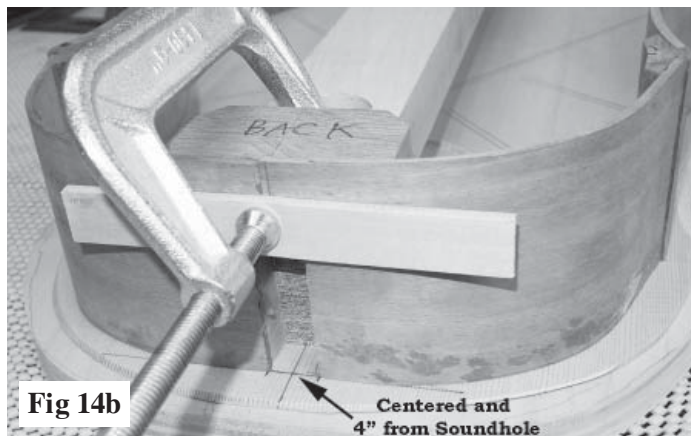
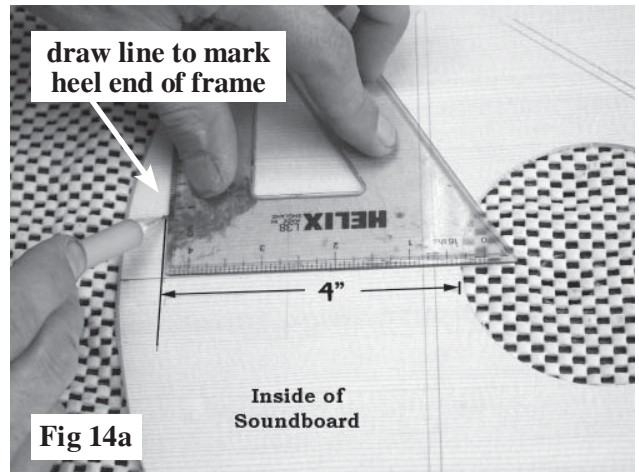

____15. Find the two X braces and connect them together in the middle. Note that there is a wrong orientation for these braces (fig 15a). When properly oriented, the X will match the outline on the soundboard, as shown in fig 15b. Center the X on the soundboard and mark where the ends of the braces cross your outline of the frame.

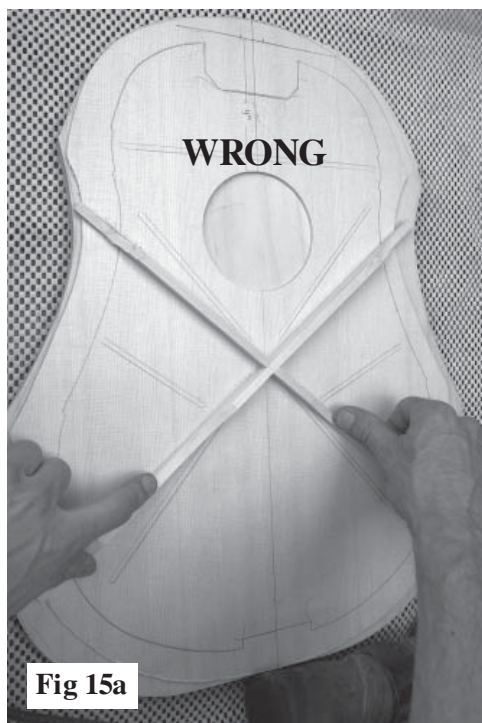

POINT OF INTEREST

Some purists will leave these braces long enough to fit into "pockets" that they cut into the kerfing. This is difficult to do well, but helps prevent a brace from breaking free at one end due to future abuse. We provide bracing long enough to allow you to choose this method if you wish, but it will increase your working time a bit.



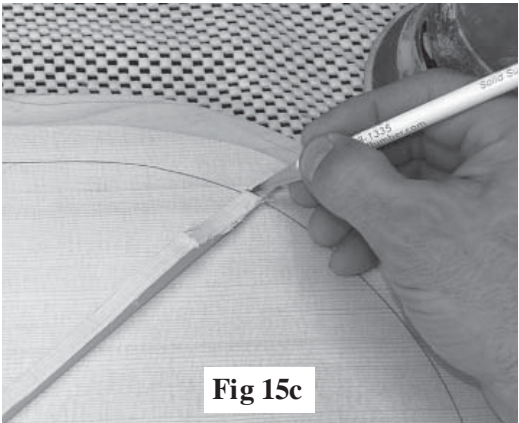

Fig 15c

Mark and trim these braces to the pencil line, as shown in fig 15c and 15d.

(or cut them a little longer if you plan to cut pockets for them in the kerfing)

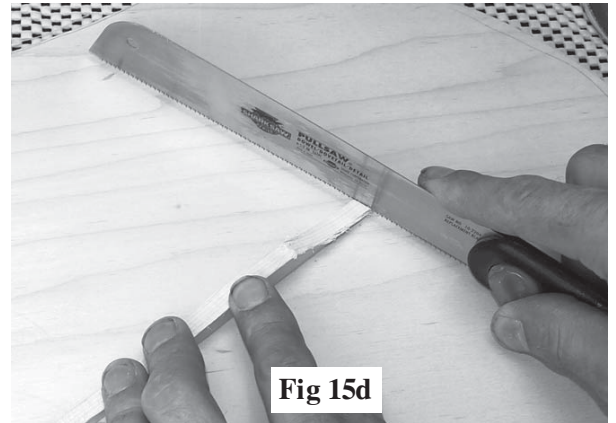

Fig 15d

16. Before gluing the X braces in place, test your clamping system without glue to make sure you have sufficient pressure everywhere. You want even pressure across the full length of the braces. Make sure that the ends will be pressed fully against the soundboard. You don't want these braces to come loose!

When all is ready, glue and clamp them in place to the soundboard, pressing them against your flat clamping board. NOTE: be sure to put glue in the notch where the two braces intersect.

Use the spacer block (or other long scrap) across the soundboard to press the intersection firmly (fig 16).

Wipe off excess glue and leave the clamps in place for 3-4 hours until dry.

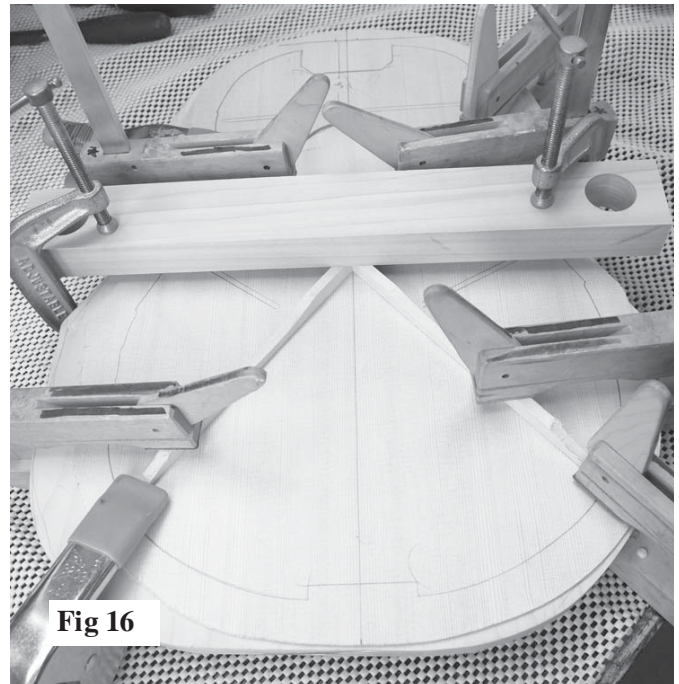

Fig 16

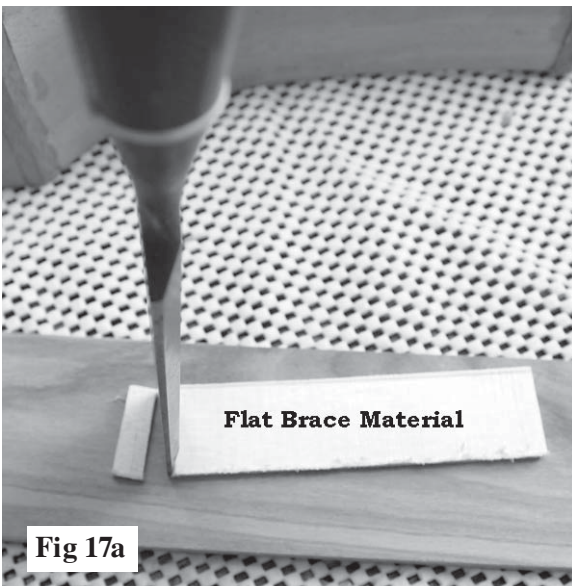

Fig 17a

17. When the braces are dry, use a chisel to clip a 1/4" end of the thin flat back bracing material to use for a patch across the intersection of the X braces, as shown below (fig 17a).

Glue and clamp this patch across the intersection forming a "bridge" to tie the bracing together firmly (fig 17b).

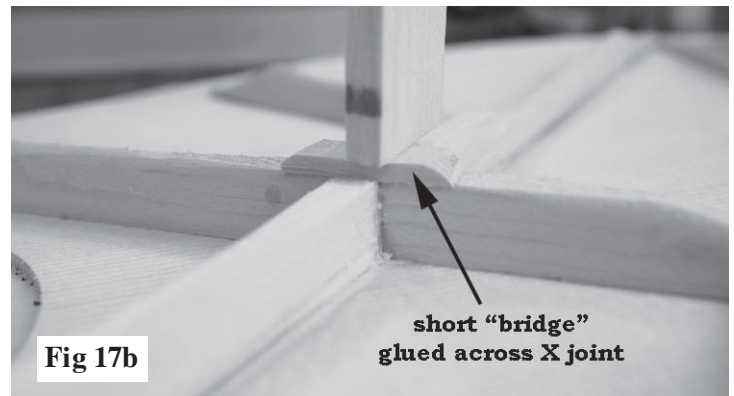
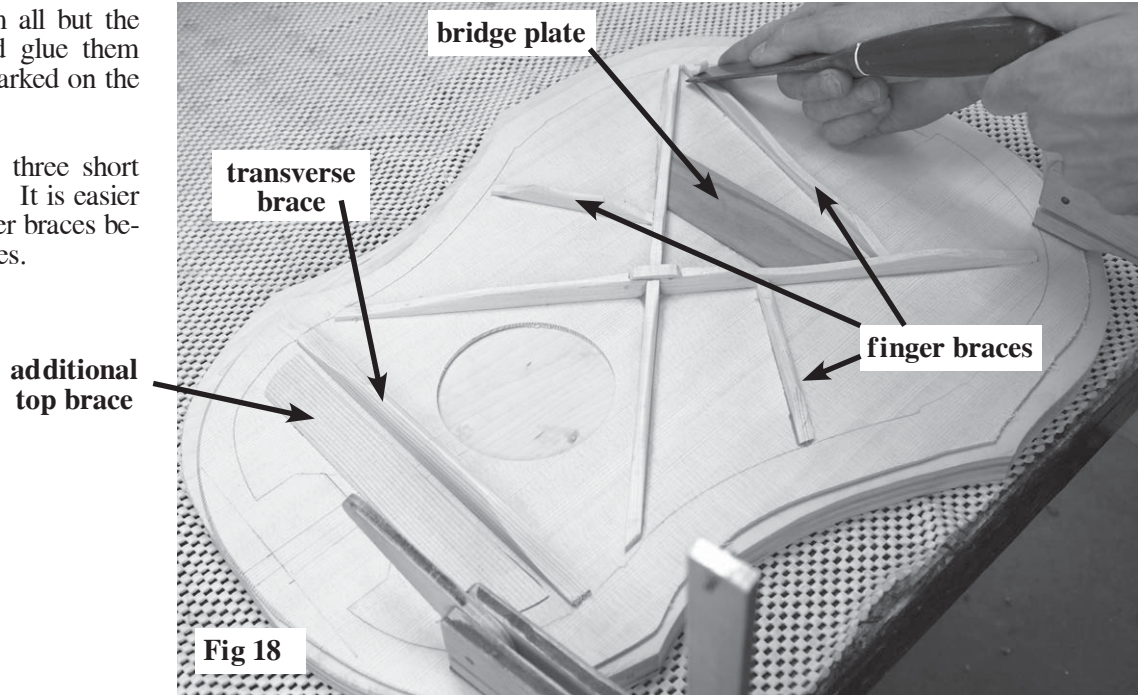

Fig 17b

____18. Mark and trim all but the three shortest braces, and glue them in place where they are marked on the soundboard (fig 18).

NOTE: Hold off on the three short soundhole braces for now. It is easier to shape and sand the larger braces before installing the short ones.



____19. Use a sharp chisel to round over tops of braces and to taper ends to about 1/8" high around the perimeter of the soundboard (fig 19a).

Switch to medium sandpaper (150 grit) to smooth the tops of all braces (fig 19b).

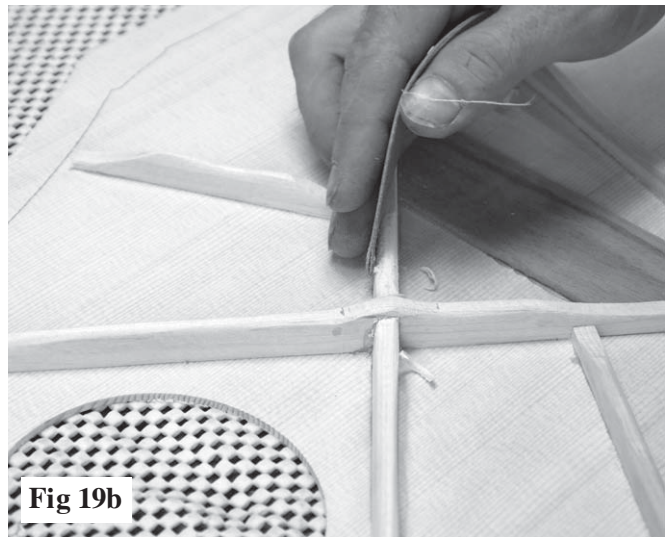
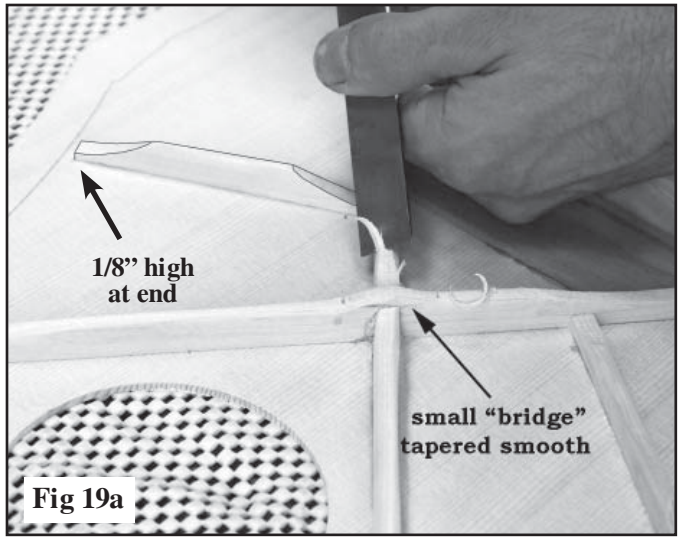

____20. Fit and glue the three shortest braces around soundhole, as shown in fig 20.

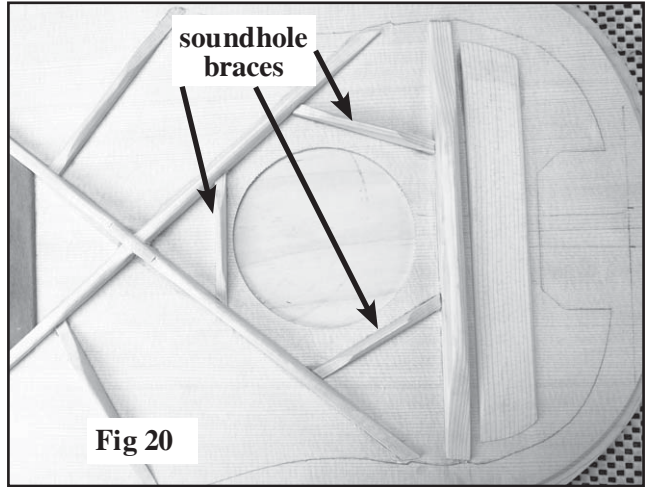

GLUING THE SOUNDBOARD

21. Be sure to keep the spacer block firmly clamped to the frame for this operation! This will help hold the shape of the body as you apply clamps.

Test-fit the frame on top of the soundboard without glue first, to see how the braces fit inside the kerfing. Trim the braces as necessary.

NOTE: If you plan to cut pockets into the kerfing for the ends of the main X braces, this will take some time for trial and error fitting.

Plan out your clamping method and assemble enough clamps (or Bungee cording) to do the job before you begin.

We show two ways to clamp the body down against the soundboard:

20 clamps, as shown in fig 21a, or 20 feet of light bungee cording (available from Musicmakers), as shown in fig 21b.

If using the Bungee cord method, put screws around your flat work surface at an angle, about 2-3" apart, for wrapping the cord. If you didn't make a 22" X 28" clamping board, you can put the screws in the edge of your smaller plywood instead of 4" away from the instrument as shown.

When ready, spread glue all around the edge of the frame (including the kerfing), and put the frame back on the soundboard, making sure there are no obstructions preventing a nice flat fit.

If using Bungee cord, tie a loop at one end, hook it on a nail and work your way cross the instrument in spider web fashion to press the entire frame down firmly against the soundboard (fig 21b).

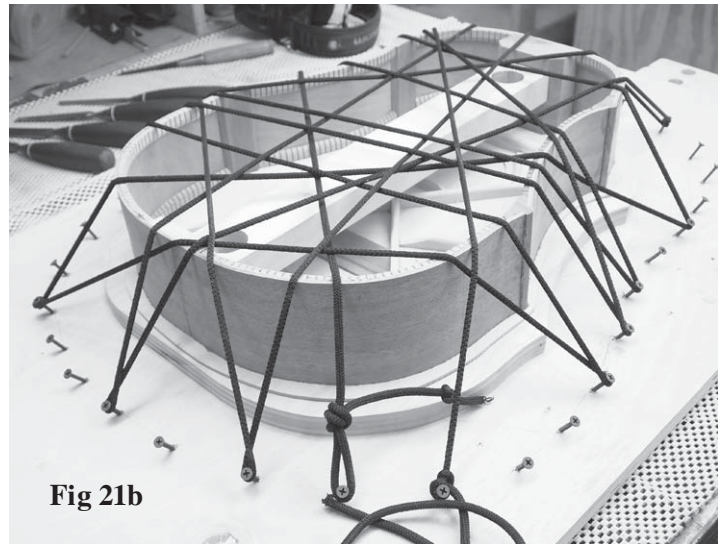
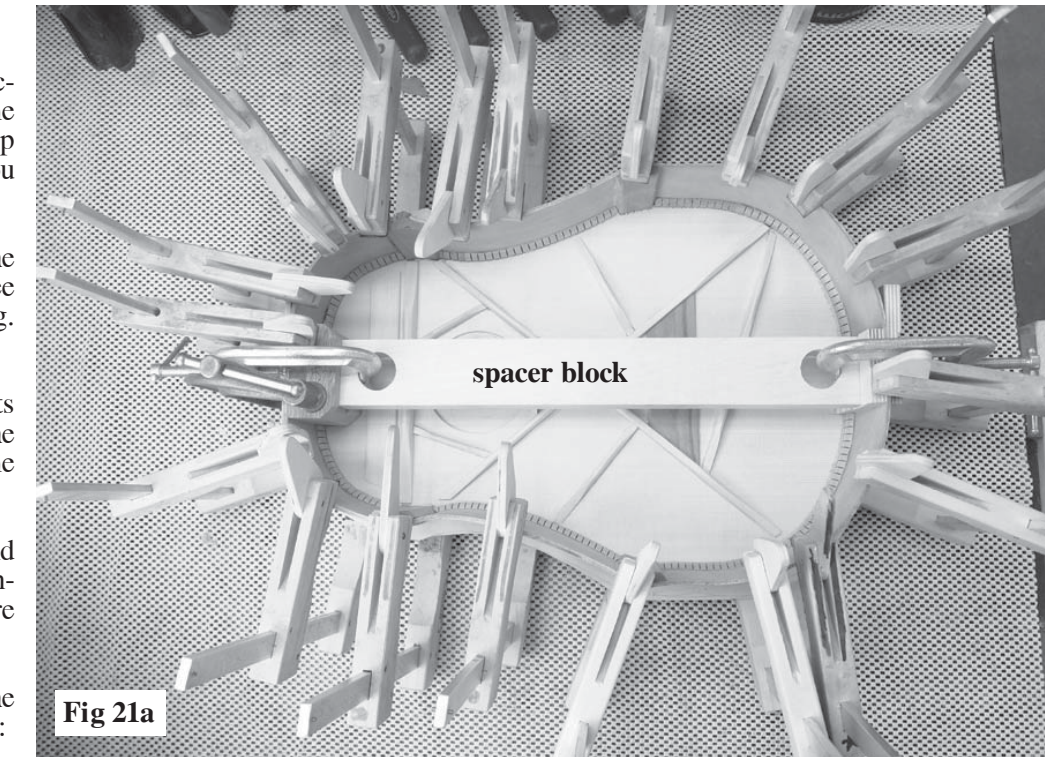

PREPARING THE BACK

22. When the soundboard is dry, remove the clamps and turn the instrument over so you can start working on kerfing for the back edge. Begin by leveling the edges of the ribs and corner blocks, using your long flat sanding block (fig 22).

The goal is to eliminate glue blobs and other irregularities that will interfere with a good fit of the back panel. You'll be sanding more after the kerfing is installed, but you'll use a curved sanding block next time.

HINT: Leave the spacer block in to stabilize the frame as you sand, until you get to the heel and tail blocks. You'll need to remove the clamps in order to sand those areas.



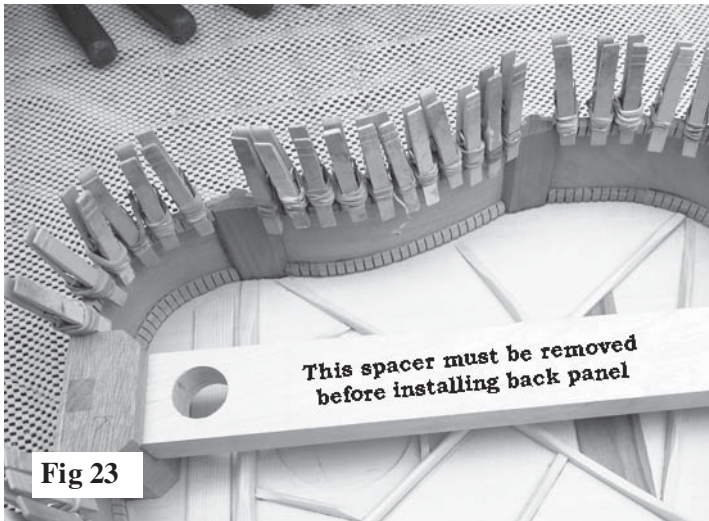

Fig 23

23. Now you need to install kerfing all around the back edge of frame, just as you did on the front edge earlier (fig 23).

CAUTION: Don't sand this kerfing with the flat sanding block. You will make a curved block for this because the back is arched (see step #30).

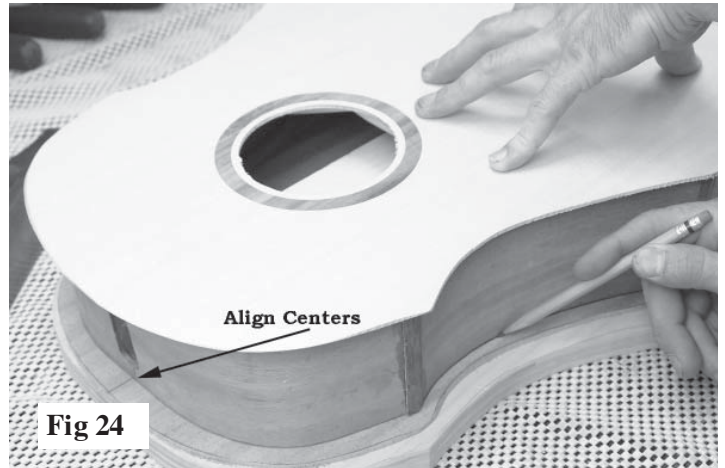

Fig 24

24. Turn the body over onto the inside of the back panel and center it carefully on the centerline. Draw around the outside of the frame with a pencil, as shown in fig 24.

25. Set a compass to match thickness of the back edge with kerfing, as shown in fig 25a.

Then use that setting to draw the inside outline on the back panel, as in fig 25b.

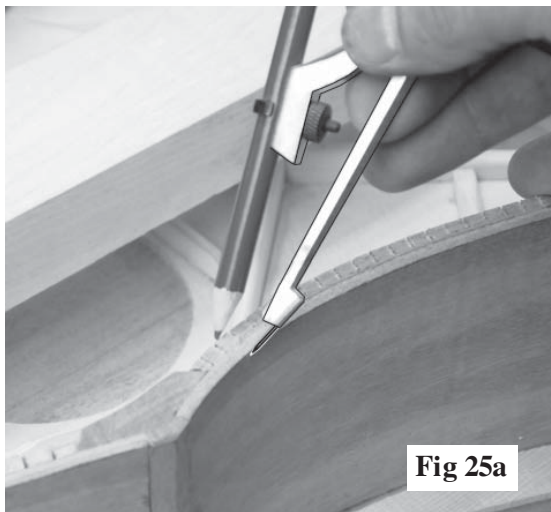

Fig 25a

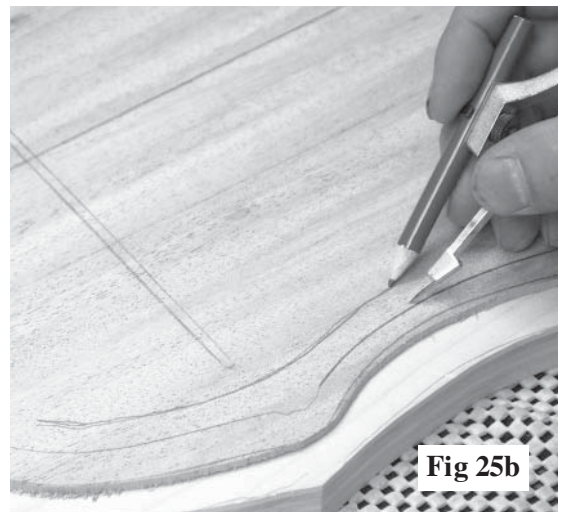

Fig 25b

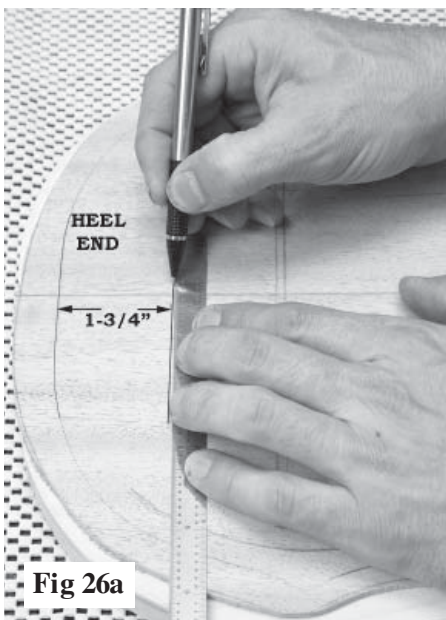

Fig 26a

26. Measure where the heel block and tail block will fit on the back panel.

The heel block extends 1-3/4" (44.5mm) in from the outer edge of the frame, as shown in fig 26a.

The tail block extends just 3/4" (19mm) in from the outer edge at the tail end of the frame, as in fig 26b.

These two lines will help you place the the flat back bracing that goes down the centerline to reinforce the glue seam in the back panel.

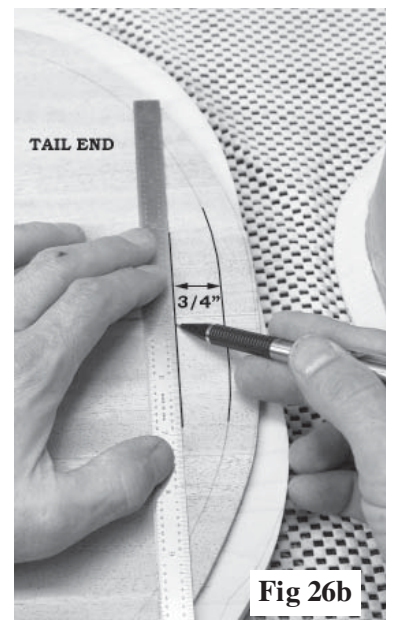

Fig 26b

____ 27. Notice that only one brace is outlined on the back panel, but there are little circles drawn to show the ends of the other two braces. Connect those circles with a straight edge to mark the location of the other two braces, as shown in fig 27a.

Find the three back braces and mark where to trim them so they don't interfere with the back kerfing (step 27b).

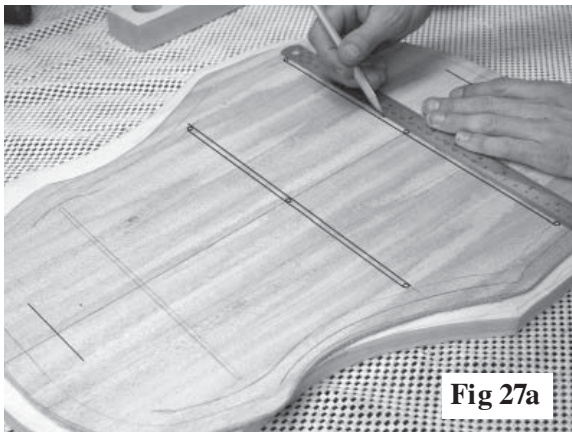

Fig 27a

Trim braces to length (or fit the ends into the back kerfing), as before.

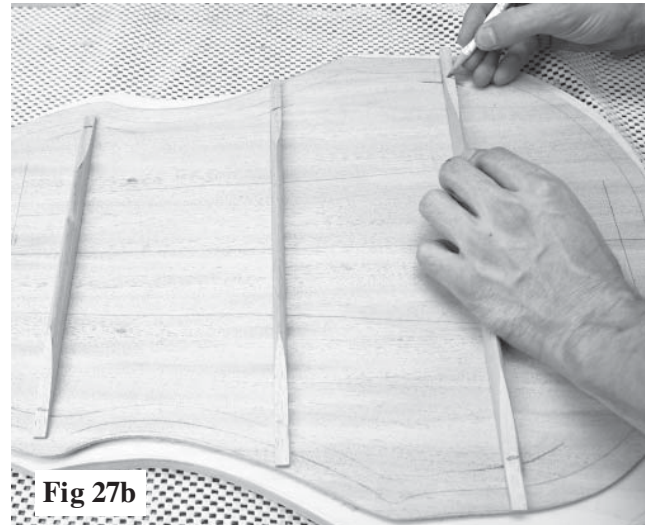

Fig 27b

____ 28. Notice how the underside of the back braces are curved. This curve matches the 15' (4.57m) radius curve on one edge of the spacer block (fig 28a).

This means you can use the spacer block to support the clamping pressure when gluing each brace in place, thus forming an arched back panel.

Make sure you have at least one clamp that will reach to the middle of the brace, as shown in fig 28b.

When ready, glue each brace in place separately, being careful to center it on the centerline over the outline you drew for that brace in the previous step, and supporting it with the curved side of the spacer block underneath.

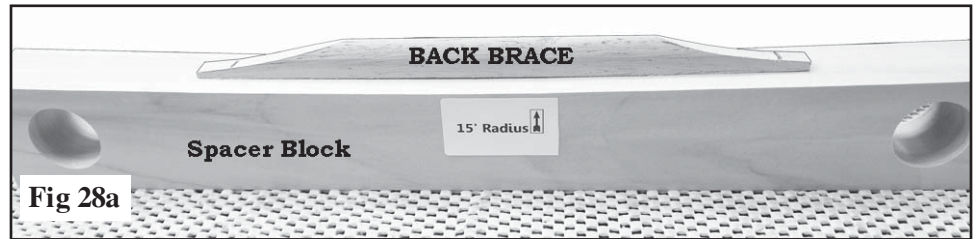

Fig 28a

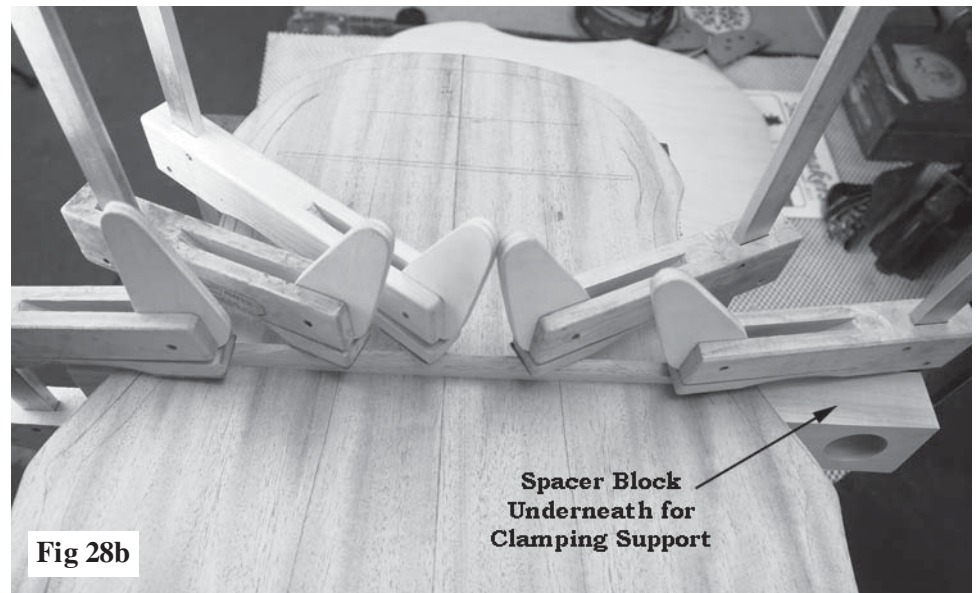

Fig 28b

____ 29. When all three back braces are dry, find the flat back braces and mark and cut them to fit between the other braces, to cover the center seam, as shown in fig 29a.

It is best to sand these parts before gluing them in place. They look best when the top surface is sanded smooth and the top edges are rounded over gently (fig 29b).

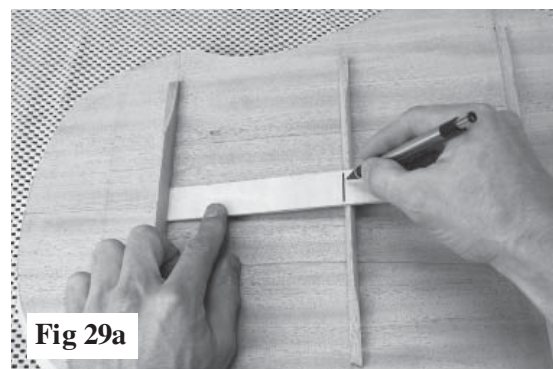

Fig 29a

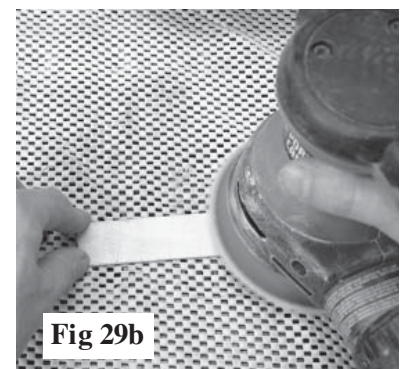

Fig 29b

Balance the back panel on a long flat board beneath the centerline to support this pressure. Use long clamps or weights to press these braces in place with glue (fig 29c). Add scrap wood under the clamps to distribute the pressure evenly over this flexible flat bracing. Notice the end braces are cut just short of the pencil line marking the heel and tail blocks (fig 29d).

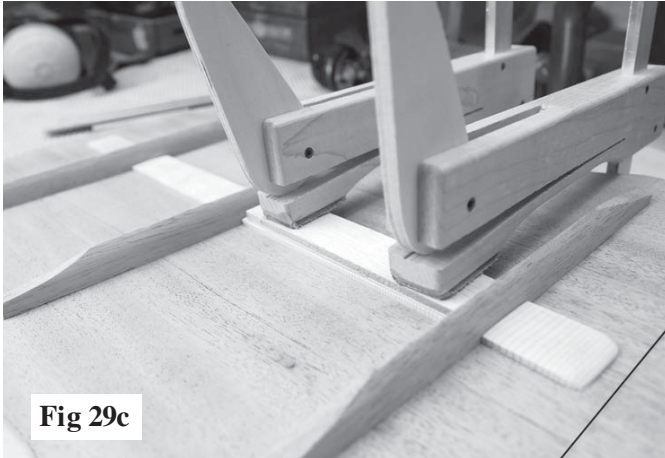

Fig 29c

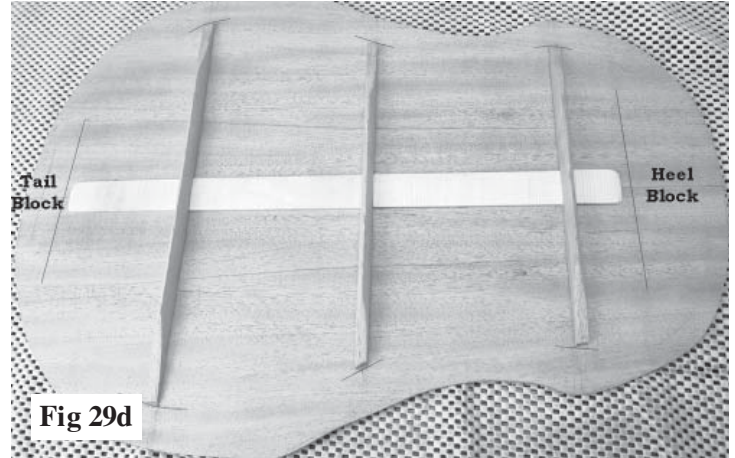

Fig 29d

____ 30. Put double-stick carpet tape on the curved edge of the large spacer block that was holding the frame (fig 30a).



Fig 30a

Then cut strips of coarse (60 grit) sandpaper to fit along the edge and press the paper against the adhesive tape (fig 30b). You may need to butt two strips end-to-end.



Fig 30b

Use this curved sanding block to shape and smooth the back edge of the instrument frame, as shown in fig 30c.

PLEASE NOTE: Keep the sanding block oriented across the frame as shown, perpendicular to the centerline of the body. This is the direction of the curve in the back panel, and it will give you nice firm glue joints around the perimeter of the frame when clamping the back in place.

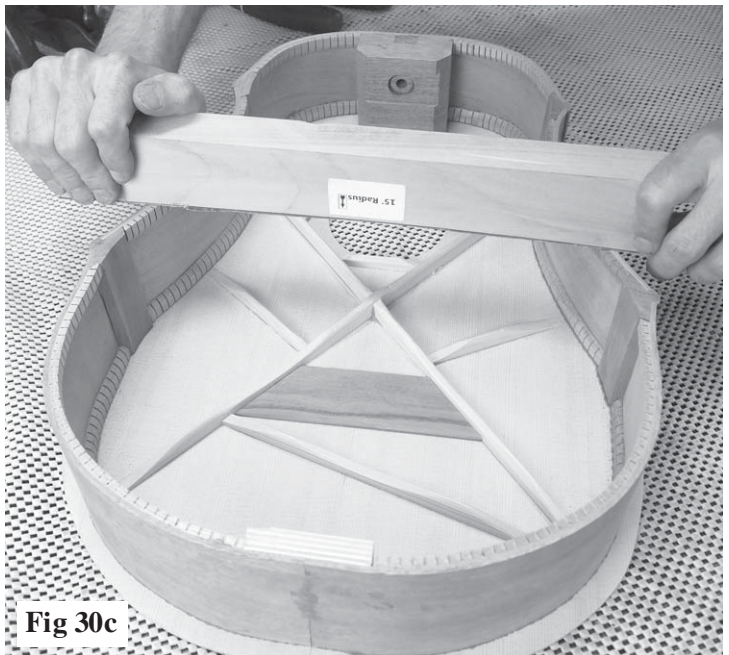

Fig 30c

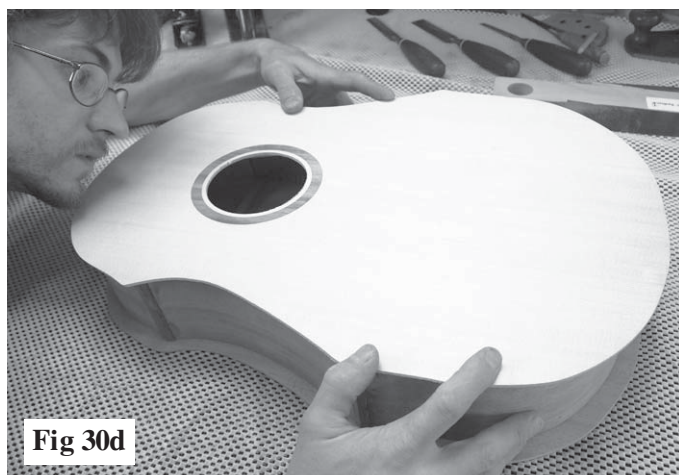

Fig 30d

Turn the frame over on top of the back panel and check carefully to see that the braces do not interfere with the kerfing (fig 30d).

Take your time with this. Trim any braces that are too long to fit inside the frame. If you end up applying clamping pressure to an area where the braces are in the way of the kerfing, you might break something!

____31. Turn the frame back-side-up and arrange it on your work surface. Apply glue to the back edge, all the way around the circumference, including the kerfing, heel, tail, and corner blocks.

Carefully position the back panel on top, nicely centered at each end, and apply clamping pressure. If using individual clamps, we recommend placing clamps at the heel and tail ends first to hold the back on the centerline, then work your way around the circumference with more clamps. Check the seams by looking under the overhang of the back to make sure it is fully pressed down all the way around.

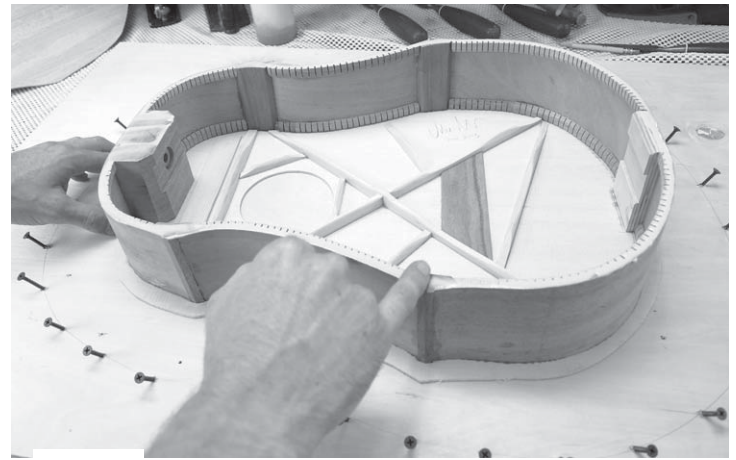

Fig 31a

If using the Bungee cord clamping system, put screws all around the frame, about 4" away from the body, and spaced about 2-3 inches apart, as shown in fig 31a.

Place the back panel carefully centered on the frame and begin pulling Bungee cording across, making sure the back does not slide out of position as you work. We show two 20-ft lengths of Bungee cords, 40 feet (10 m) total, in the photo at right (fig 31b).

Be sure to check around the entire glue seam, looking under the overhang and pressing down to see if there is any section that is not held firmly. Watch for glue squeezing out of the joint -- that's a good sign of sufficient pressure.

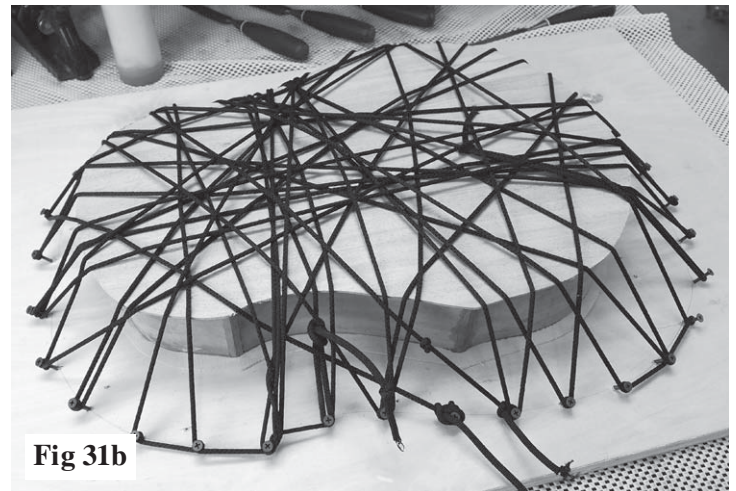

Fig 31b

____32. When dry, trim off the excess overhang of the soundboard and back flush with the outside of the body.

We like using a flush-cutting router bit (fig 32a) for this step. Move the router clockwise around the instrument (this is called "climb cutting") to minimize the chance of chipping the thin spruce top and mahogany back panels (fig 32b).

You can achieve the same results more slowly using a coping saw to cut close to the sides, and then a sanding block to sand it flush.



Fig 32a

flush-cutting
router bit

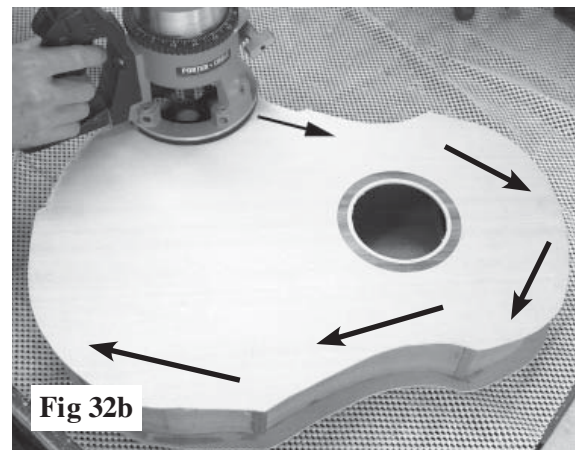

Fig 32b



Fig 32c

The corner blocks protrude a little beyond the sides, so you'll want to sand those flush too. A spindle sander or attachment to a drill press works well for this (fig 32c), but you can also make a curved sanding block using a tin can or other round object to wrap your sandpaper around (fig. 32d). Always watch closely to make sure you don't distort the shape of the corners.

This is an important step for achieving a nice-looking instrument. The corner blocks and sides should meet seamlessly and smoothly.

If you find gaps in the joints, fill them with mahogany colored wood filler, available from most hardware stores. Or make your own paste of mahogany sanding dust and Superglue.

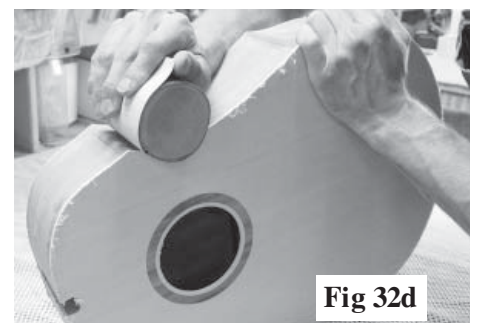

Fig 32d

33. OPTIONAL DECORATING: If you have a router, you can install binding around edges of the soundboard and/or back. This is not a necessary step, but it adds a lot to the appearance of the finished instrument. Use our Inlay Router Bit with the smaller bearing for this operation. Set the depth of cut to match the width of the binding strip, as shown in fig 33a.

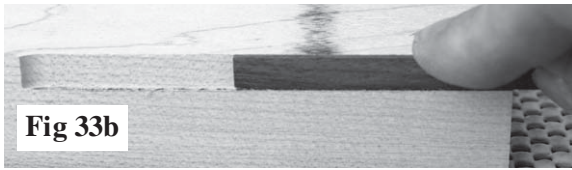

Fig 33b

Make a test cut in a scrap of wood, and check the fit of the binding strip (fig 33b).

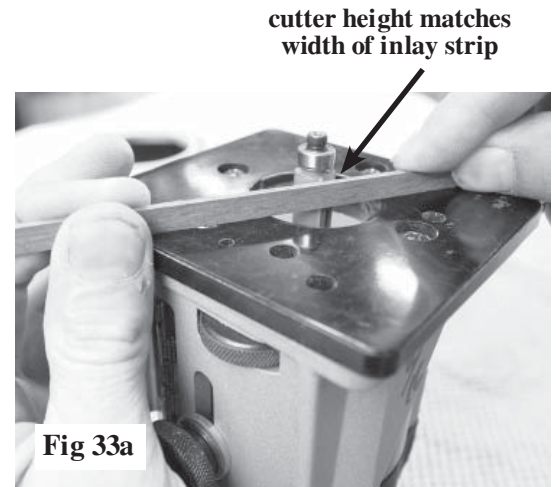

Fig 33a

Be careful not to "fall" into the slot for the tenon

Use the router to cut a ledge all the way around the top and bottom of the instrument for inlay strips, working clockwise around the perimeter, as before (fig 33c). The roller bearing will prevent the router bit from cutting too deeply. You may need to go around the instrument twice, just to make sure the ledges are cut to full depth.

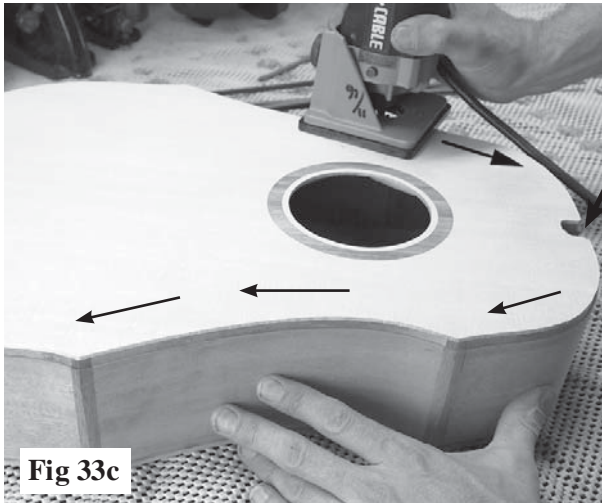

Fig 33c

Wet the wood binding in a tub of warm water for just 1-2 minutes before bending it around the instrument.

Bend one long strip around the tail end of the instrument, holding it in place with a few pieces of tape.

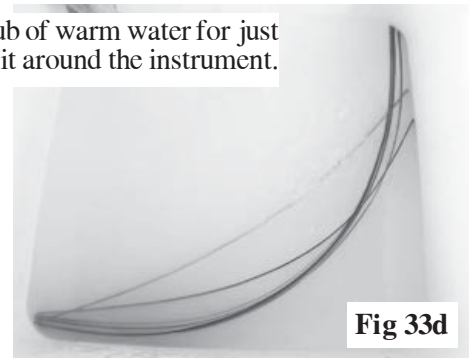

Fig 33d

Mark the length and trim it close with a chisel or razor knife (figs 33e & 33f).

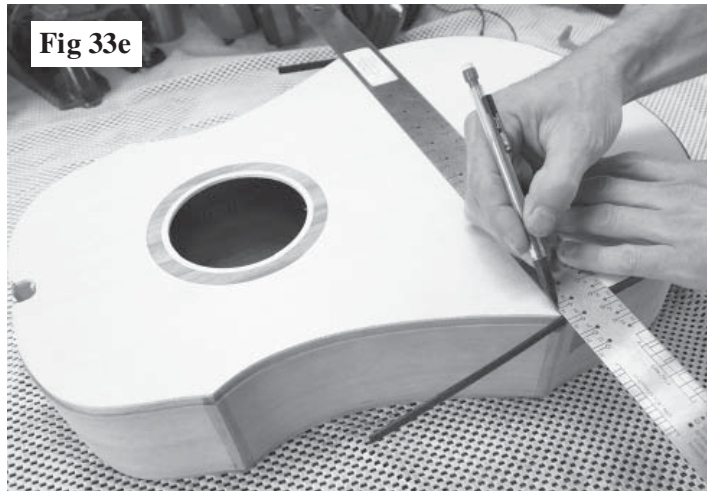
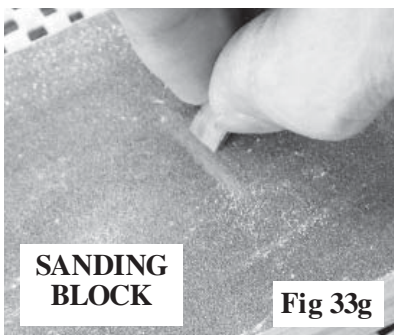

Fig 33e



Fig 33f

Then test-fit again using a sanding block to make small adjustments to the ends until they are just the way you want them (fig 33g). We like to make mitered joints in the binding at each corner block (fig 33h), but that can take some extra time. An easier option is to make "lap" joints instead (fig 33i).



SANDING BLOCK

Fig 33g

For lap joints you would install the first piece a little longer than necessary and trim it off after the glue dries, sanding the end to match the next ledge. Then your next piece can also be longer than needed, so you just trim it off and sand it flush with the outside edge of the first binding piece.

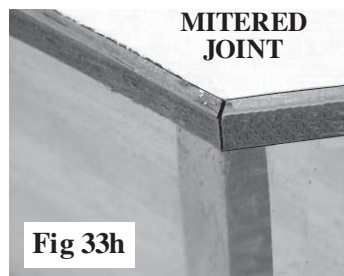

Fig 33h

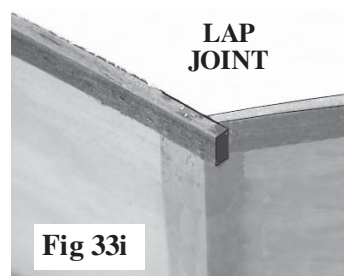

Fig 33i

Once you have planned your joint, you can apply glue to the groove and use lots of masking tape to hold the binding in place until dry (fig 33j). Be sure to pull the binding fully into the slot as you tape it.

HINT: Think of the tape as being somewhat elastic (even though it isn't). That helps you use a pulling action as you install it.

Cut binding to fit the next section of the body (fig 33k). Glue and tape it as before.

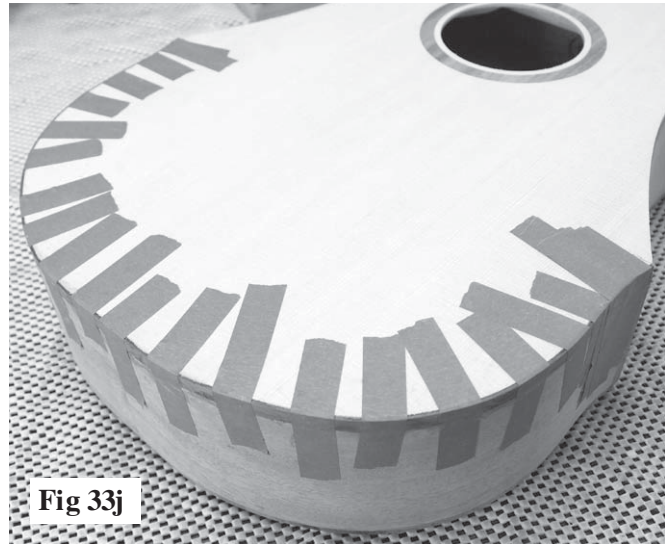

Fig 33j



Fig 33k

When you get to the heel end of the top (soundboard), you can leave the trim a little short because it will be covered (hidden) by the neck and fingerboard (fig 33-l).

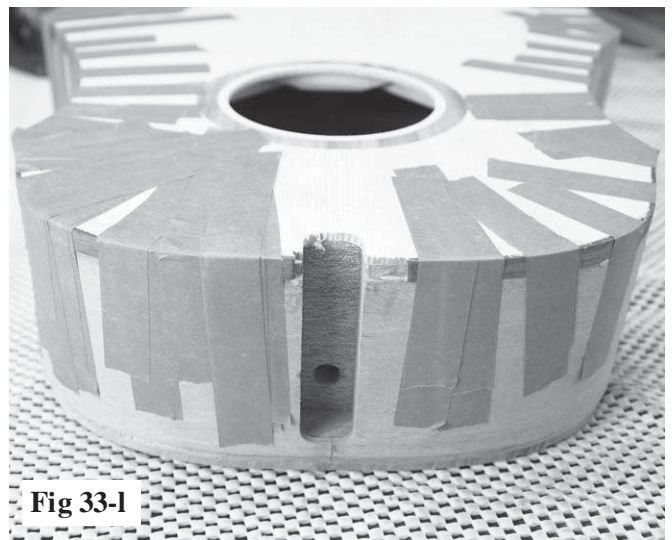

Fig 33-l

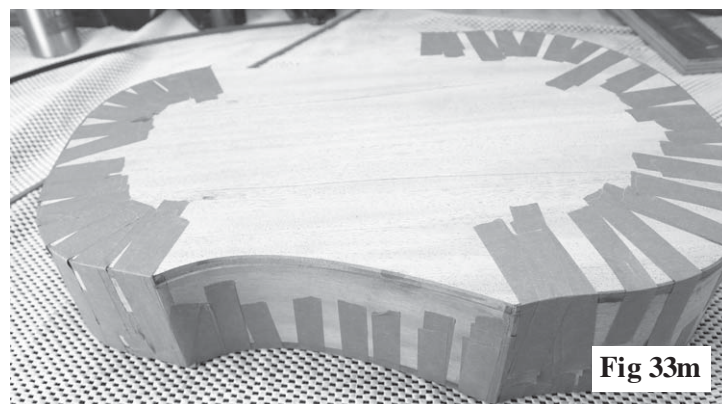

Fig 33m

The back binding is easier to install in a different sequence. It is best to install one long piece of binding for the heel end just as you do for the tail end (fig 33m). Notice that the binding at heel end of the back will not be covered when you install the neck, so you don't want any gaps in the back binding.

Then you can fit the two side bindings in place last around the back side.

Once the binding is installed and dry, remove all the tape, being careful to avoid lifting the grain of the spruce soundboard. **HINT: Pull slowly, and if you see any damage starting, pull in the other direction from the opposite end of the tape.**

When the tape is all off, do some sanding to eliminate all glue residue around the instrument. The tape has a nasty tendency to smear excess glue over wide areas, but it is relatively easy to sand off with medium (100-150 grit) sandpaper.

We even use a hand orbital sander for some of this work (fig 33n), though you need to be careful not to sand too deeply when you use power equipment.

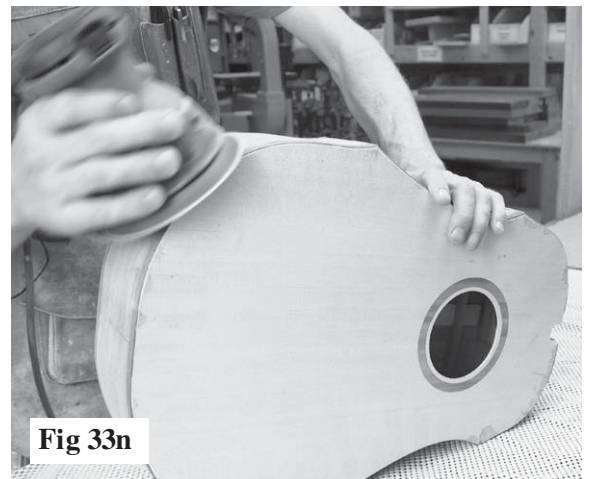

Fig 33n

PREPARING THE FRETBOARD



Fig 34a

34. ANOTHER OPTIONAL STEP: You can trim the width of your fretboard to suit the grip of your left hand. Most production instruments measure about 1-1/2" (38-40mm) wide at the narrow end (by the "nut"), and 2-3/16" (54-55mm) wide at the 12th fret. You'll notice that we supply slightly wider parts in this kit to allow someone to make the neck fit a larger hand.

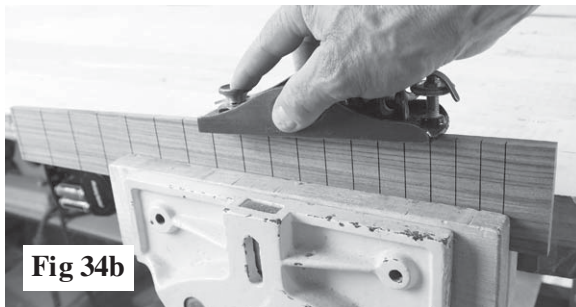

Fig 34b

If you want to trim the width a little bit, be sure to draw a straight line along one or both edges to mark the final desired width (fig 34a). Then you can use a block plane or coarse sanding block to remove the excess material (fig 34b).

35. YET ANOTHER OPTIONAL STEP: You may sand a small radius into the top surface of the fretboard if you wish. Most production steel-string instruments have about a 15" (38cm) radius on top of the fretboard.

This is quite easy to do with either a block plane or a coarse sanding block. Begin by putting double-stick carpet tape at each end of the underside of the fretboard, as shown in fig 35a.



Fig 35a

Stick the fretboard to your work surface and use your block plane or sanding block at a tilted angle to remove some material from each side along the entire length of the fretboard (fig 35b).

Use a pencil on the end of a 15" string to draw the desired arc onto a stiff notecard. Cut on the curved line and check your progress by holding the card against the wood (fig 35c).

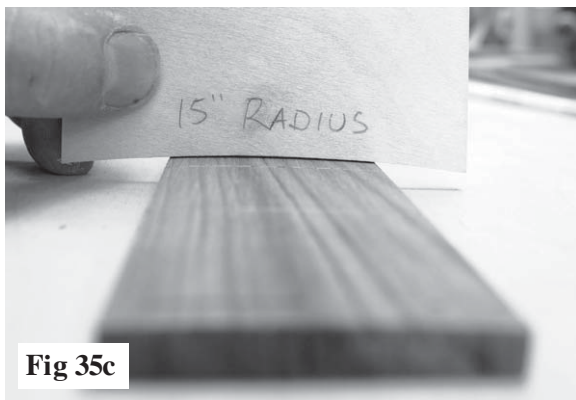

Fig 35c



Fig 35b

POINT OF INTEREST

The fretboard radius can vary from 7.5" to 20", depending on your playing preferences. The tighter radius is more comfortable for the curvature of your hand, but a flatter radius is better for fingerpicking and for bending notes. In fact, classical guitars (nylon strung) have flat fretboards, no radius at all. It is also possible to achieve a compound radius in which the fretboard resembles a slice off a cone. This gives you a tighter radius at the nut and a flatter radius near the body of the instrument. Such a shape actually fits the natural plane of the strings. So you can work your fretboard to suit your playing style.

Hold a straight-edge against the fretboard to make sure the wood is still straight across the top from one end to the other (fig 35d). You don't want any depressions or high spots in the playing surface. Use a coarse sanding block to do the major leveling (fig 35e).

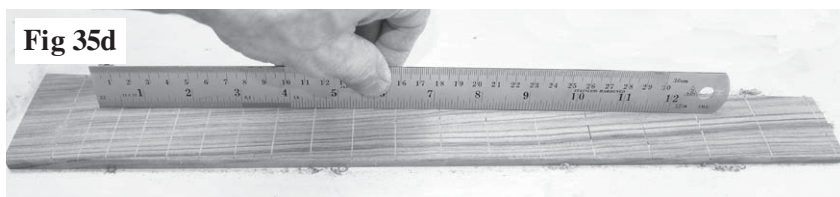

Fig 35d

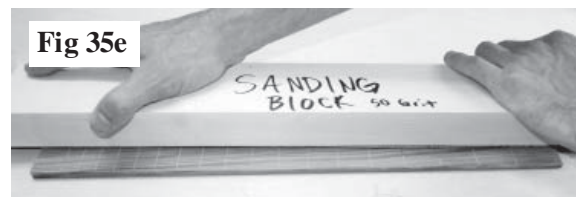
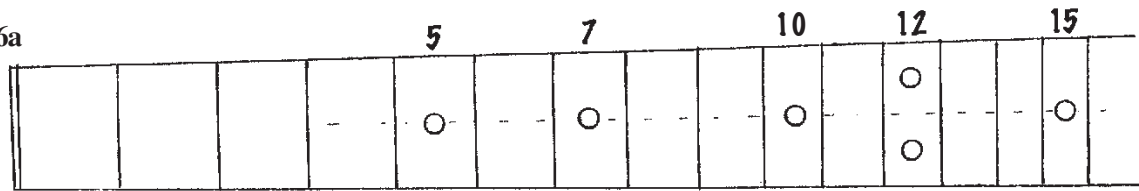

Fig 35e

36. OK, HERE'S ANOTHER OPTIONAL STEP: Many people like the appearance of having pearl inlay dots in certain spaces on the top of the fretboard to guide their playing. We have included white side markers for the fretboard, but you may also purchase 1/4" diameter pearl dots from Musicmaker's if you want to inlay them on the top surface as well. It is common to see from 5 to 7 marking dots located in the spaces shown in fig 36a (numbering the spaces from the narrow end of the board).

Fig 36a



Draw a centerline down the fretboard and use an awl to punchmark the locations of the marking dots, as shown above.

Then use a 1/4" drill bit to bore shallow holes (1/16", or 2mm deep) at each punch (fig 36b).

Glue each dot with a drop of 5-minute epoxy or Superglue (CA adhesive) (fig 36c), and press or tap it down into the hole (fig 36d). A scrap of wood works well to pad the dot (and the surrounding wood) from your hammer. Ideally, you can push it close to level with the top surface, but it is fine to have the dots stand a little higher than the wood. You'll sand them down flush after they dry.

Fig 36b

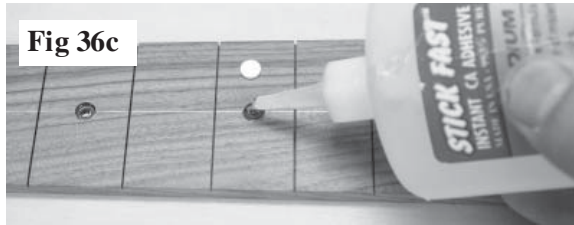
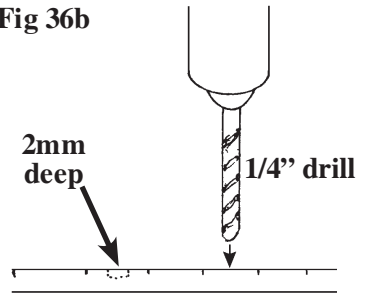

Fig 36c

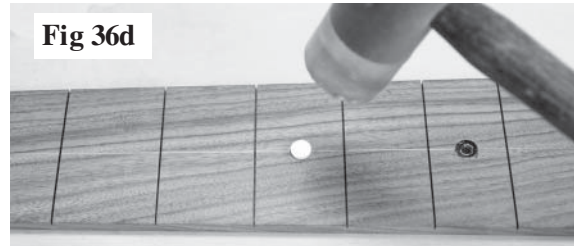

Fig 36d

37. Use your coarse sanding block to level the dots with the wood. Then you can smooth the entire top surface of the fretboard with progressively finer sandpaper in this approximate sequence: 100 grit, 180 grit, 240 grit, 320 grit, 400 grit, and finally 600 grit.

POINT OF INTEREST

This final sanding should leave the fretboard silky smooth, almost as if it were finished and polished. Your fretboard is made from Bolivian Rosewood which has natural oils that seal the pores, so there will be no need to apply a surface finish over the top. Your sanding at this point will give you the final playing surface.

38. Now you are ready to install the frets. **IMPORTANT: Begin by finding the special #0 fret in your parts package. This short piece of fretwire has a little fatter bead than the rest, and it must be placed in the very first slot at the narrow end of the fretboard to hold the strings at the proper height.**

Clip that #0 fret slightly longer than necessary to reach across the narrow end of the board (fig 38a). Notice that the fretwire is shaped with a rounded cap that stays on top of the wood, and a thin tang that will fit tightly down into the pre-cut slot.

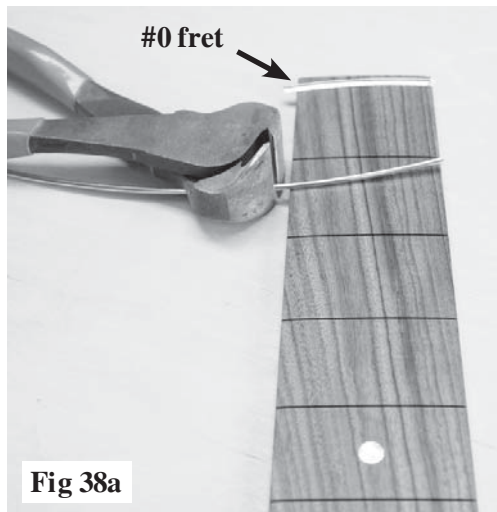

Fig 38a

Use a small hammer to tap one end of the tang into the slot, and work your way across to the other end of the fret, checking to see that it is fully seated along the way. It should go easily, requiring only 4-8 taps for each fret (fig 38b).

Continue the same process with the rest of the fretwire until all of the frets are installed. Double-check carefully, under good lighting, to make sure the frets are fully seated against the wood. Tap them down further as necessary.



Fig 38b

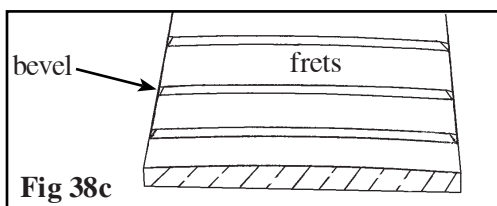

Fig 38c

The ends of the frets need to be sanded flush and smooth with the sides of the fretboard. This goes quickly if you hold the fretboard up against a belt sander, but you can also use a fine flat file or a sanding block with time and some effort. Once the ends are flush with the wood, tip the file (or sandpaper) to bevel the ends of the frets about 45 degrees, as shown here (fig 38c). Check how smooth it feels by running your hand along the edges of the fretboard. Be sure to eliminate all sharp points and roughness.

PREPARING THE NECK

39. Temporarily clamp the fretboard to the neck, carefully centering it and leaving enough flat space at the narrow end to allow for the ebony nut. Use a pencil to outline the fretboard as shown in fig 39a. These lines will be helpful reference points as you do more shaping on the neck to fit your grip.

Remove the temporary clamps and set the fretboard aside while you work on the neck. We like to clamp the neck upside-down and hanging over the edge of our work table, as shown in fig 39b. This allows you free use of both hands for doing some shaping at the heel with a rasp and/or coarse sandpaper.

When the shape looks rounded enough for you, switch to medium (100-grit) sandpaper to smooth out the surface (fig 39c). This area will be difficult to sand when the instrument is assembled, so take the time to do it now.



Fig 39a

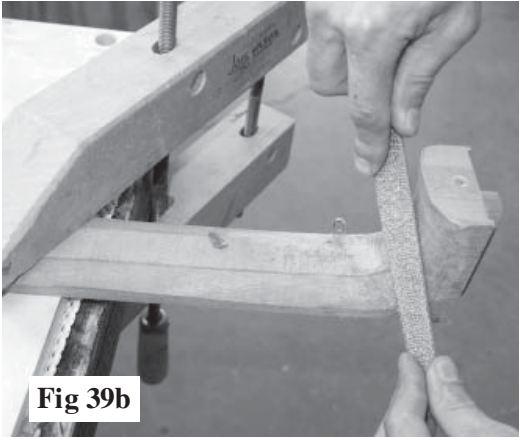

Fig 39b

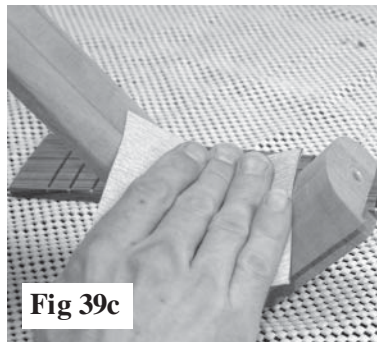

Fig 39c

CAUTION: Be careful not to damage or remove the thin edges at the heel of the neck. You can reduce their width to match your fingerboard, but leave them full height to make it easier to fit the neck to the body.

In these directions, we will refer to the four corners of the heel as A, B, C, & D, as shown in fig 39d, to help you plan your adjustments.

Chamfer the edges of the slot in the heel of the body for the tenon to make sure the sharp corners don't interfere with the tenon fitting all the way into the slot. A chisel or file works well for this task (fig 39e).

Test-fit the neck to the body. If the tenon is too tight for an easy fit, you can file it on one or both sides, as necessary, but try to avoid making it too loose and sloppy in the slot (fig 39f). Check for glue residue in the slot that might interfere with a good fit.

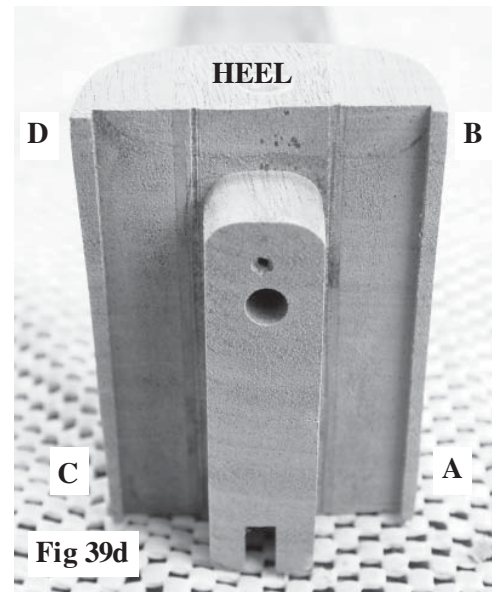

Fig 39d

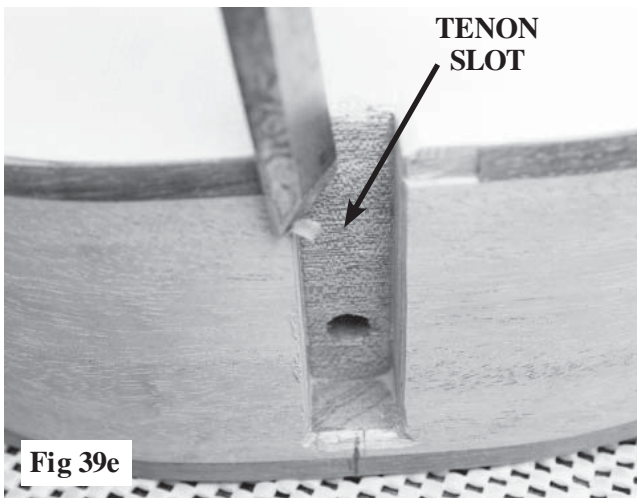

Fig 39e

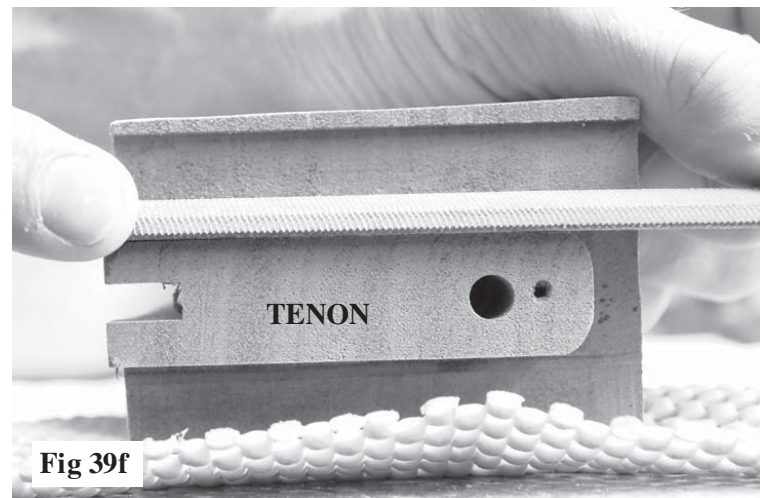

Fig 39f

40. Before doing more fitting of the neck to the body, it is best to use your flat sanding block to make sure the heel end of the body is flat and level (fig 40). Try to keep the sanding block from rocking too much as you work on the end of the body. You should not have to remove much material, but you want to get rid of irregularities in the surface, like glue blobs, bumps, and depressions in the wood.

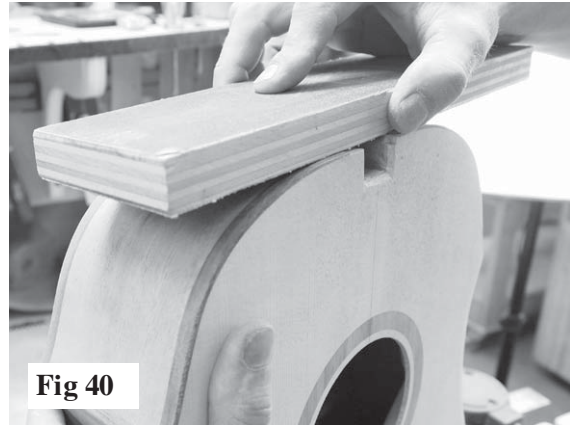

Fig 40

41. Test fit the neck to the body again. Find the bolt and washer for holding the neck to the body, and use a 7/16" socket wrench to draw the parts together from inside the body, as shown at right (figs 41a and 41b).

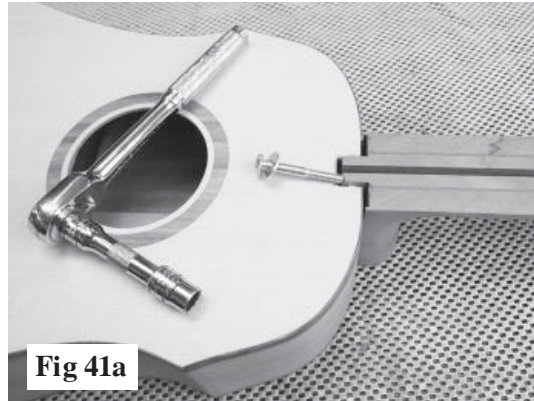

Fig 41a



Fig 41b

HINT: When you assemble the neck to the body, you should be able to slide the neck up or down about 1/16" to get the top of the neck level with the top of the soundboard.

If that isn't quite enough adjustment for your parts, you can remove the neck and use a round file to elongate the hole in the heel block a little bit to allow the bolt to move up or down further (fig 41c). This would be easier than doing a lot of sanding on the top surfaces!

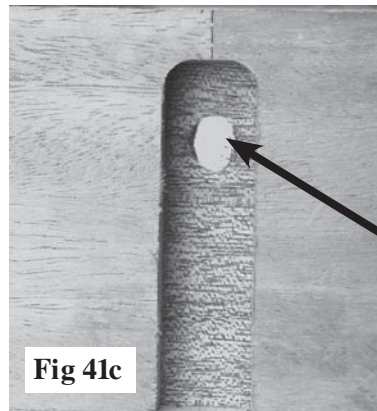

Fig 41c

Elongated hole

Your goal is to have the neck aligned with the centerline of the body (fig 41d), and level with the soundboard. Use a straight-edge to check these details.

Notice (fig 41e) that our neck tilts downward from the plane of the soundboard, leaving a gap under the straight-edge, so we need to adjust the heel to level those parts together.

Your parts will likely be different, so you can adapt these instructions to achieve your goal.

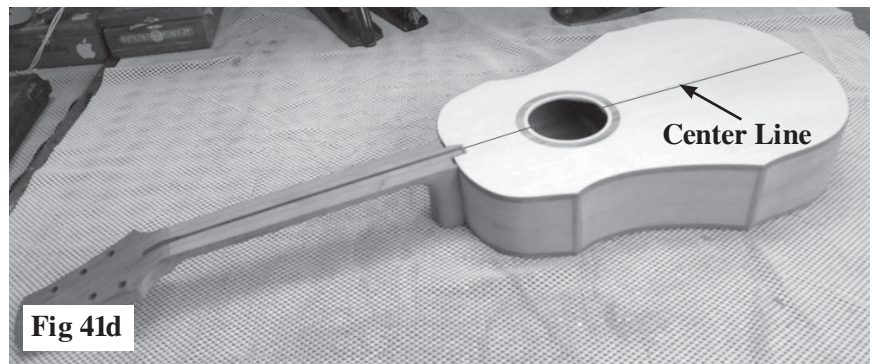

Fig 41d

Center Line

The neck at right (fig 41e) slopes down toward the peghead, so it needs a little adjustment at the heel to raise the peghead end and remove the slope. We want the surface of the neck and soundboard to be level and flat.

In the next step we show how to accomplish this type of adjustment.

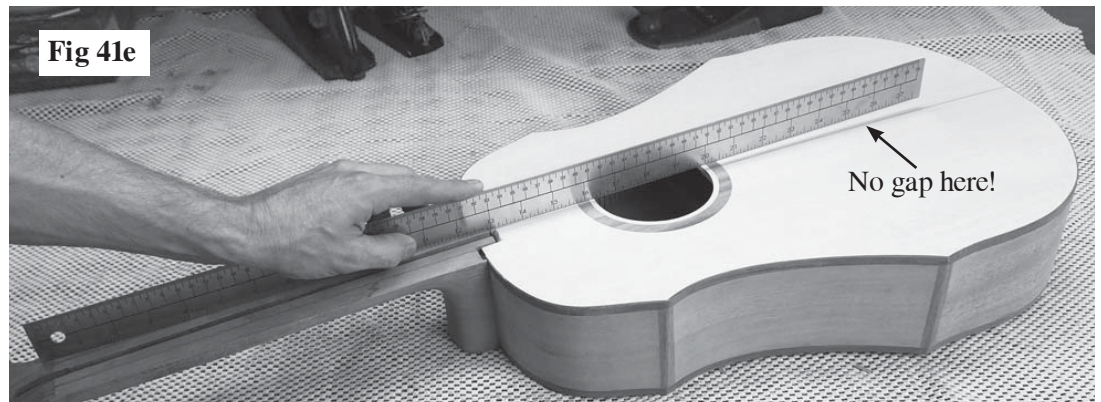

Fig 41e

No gap here!

POINT OF INTEREST

Many luthiers angle the neck down a few degrees from the plane of the soundboard on purpose to help lower the string action, but on this kit, we have sloped the fretboard to accomplish the same result. This makes your kit easier to assemble, with less guess-work. So all you need to worry about is to achieve a level playing field along the top of the instrument from the tail end to the peghead.

____ 42. For our situation shown earlier, we need to carefully shave the thin edges of the heel to slope them slightly lower toward the corners marked A and C, as shown in fig 42a.

We like using a flat sanding block for this careful work, checking the fit frequently to make sure the parts are fitting better and better as we go.

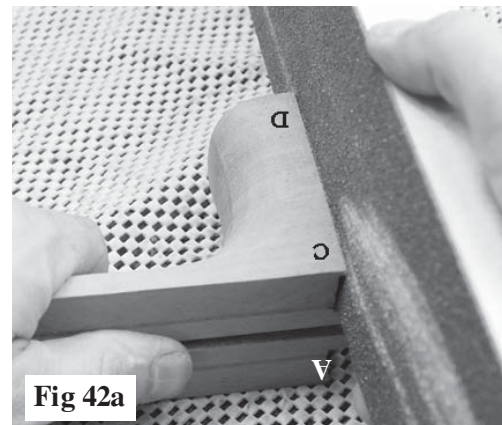

Once the neck is flat with the soundboard, you need to make sure it lines up with the centerline on the body (fig 42b).

Use the bolt to hold the neck in place as you lay a straight-edge down the center of the neck to see how it aligns with the body.

If it is off, sand one side of the heel a little further to straighten the neck. Be sure to keep track of which side needs work! Use your A, B, C, & D marks (fig 42c).

Assemble the parts again and double-check for any unevenness along the top surfaces where the neck meets the body. You will want the fretboard to fit nicely across this seam, so use a sanding block if necessary to remove any irregularities in those surfaces (fig 42d). This should only require light sanding.

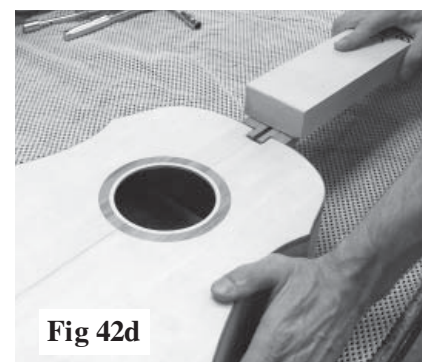
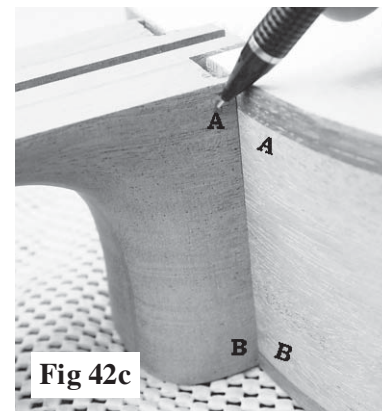
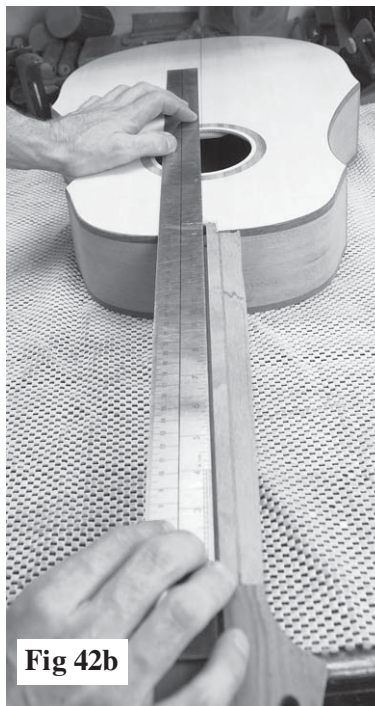

ADDING THE FRETBOARD

____ 43. Now you are ready to glue the fretboard to the neck. Begin by centering the fretboard on the neck, leaving sufficient flat space at the narrow end (near peghead) for the "nut". Pencil the outline of the fretboard so you can easily re-position it in the same spot (fig 43a).

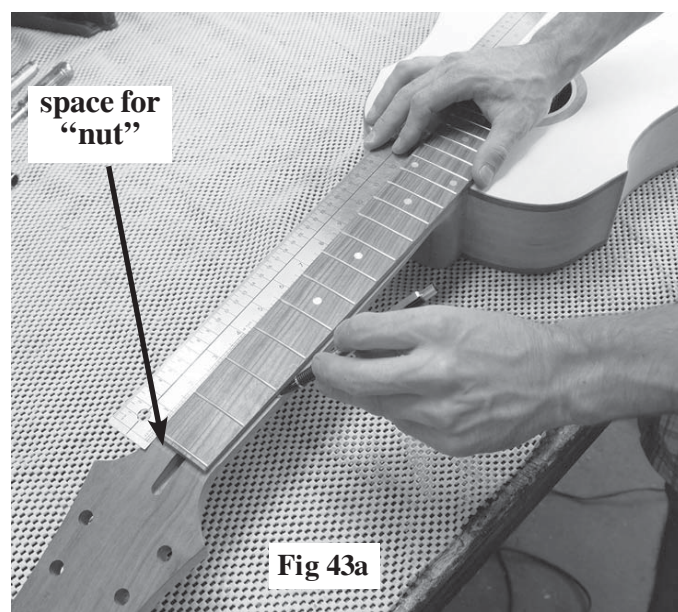

We recommend installing two tiny nails partway into the neck: one near each end, as shown in fig 43b. Clip the nails close to the wood (fig 43c). These studs will help prevent the fretboard from slipping out of position as you glue and clamp it to the neck.

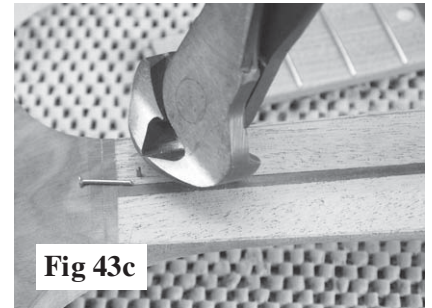

44. Push the truss rod into the slot in the neck, with the barrel nut facing the peghead (fig 44). HINT: We like to orient the truss rod so the adjustment barrel nut rests at the bottom of the slot instead of the top. That is the normal orientation on production instruments.

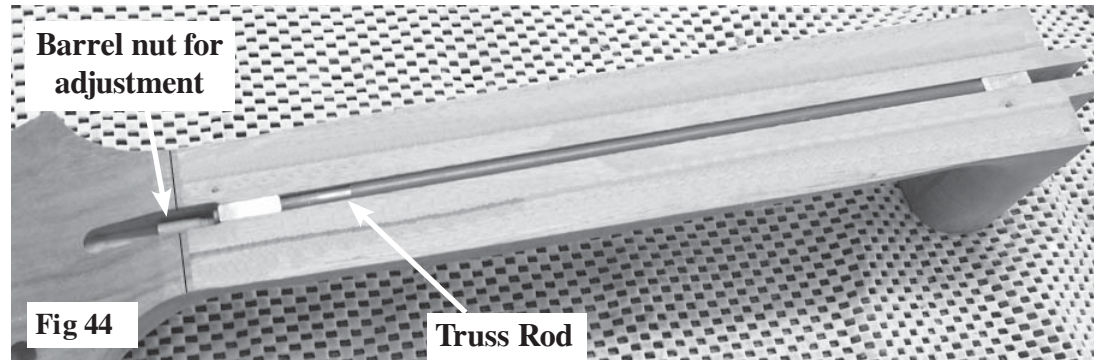

45. Carefully place the fretboard back over the neck, aligning it with your outline, and leaving enough flat space for the “nut” near the peghead, and press the fretboard firmly down against the neck, especially where the tiny nails are located (fig 45a). This will create pin-pricks under the fretboard to keep the parts from sliding out of position during gluing.



Get some clamps and scrapwood ready for clamping the fretboard onto the neck. Look at the following photos to see how we press these parts together.

When ready for gluing and clamping, squirt glue on the neck, as shown in fig. 45b

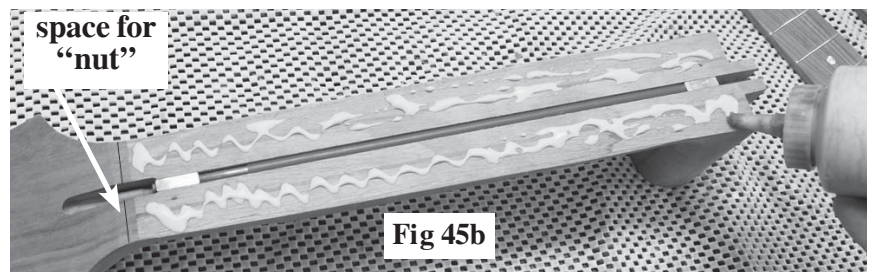

Replace the fretboard on the neck so the tiny nails “fall” into the pin-prick dents made earlier.

Remember to leave enough flat space at the peghead end for the “nut”.

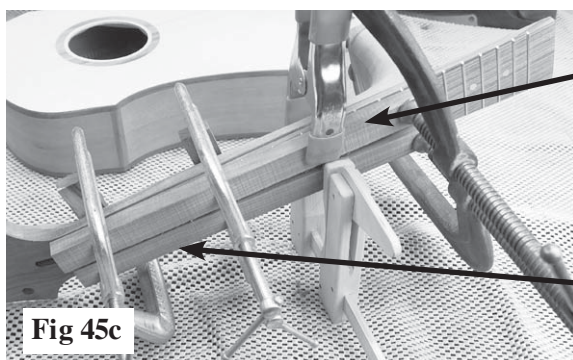

Notice the scrap wood pads under the metal c-clamps. These are important for protecting the instrument wood from dents (figs 45c & 45d).

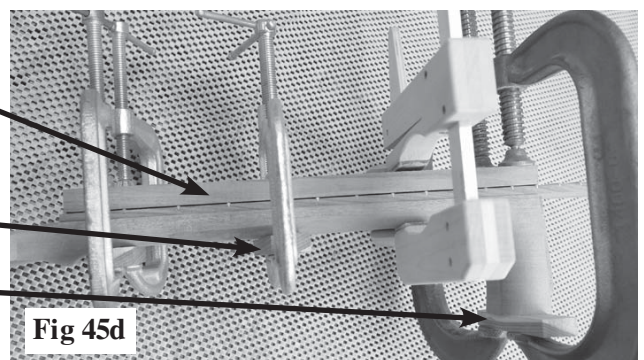

____46. The peghead can be shaped a little further at the end if you want to customize the instrument that way. Just make sure you don't interfere with the fit of the geared tuners by removing too much material. We use a band saw and spindle sander or drum sander for this kind of modification (fig 46a).



Fig 46a

You can also trim the end of the fretboard to fit the sound hole. Bolt the neck back onto the body and use a short pencil stub to outline the edge of the sound hole on the underside of the fretboard, as shown in fig 46b. Use a band saw or coping saw to cut close to the curve (fig 46c), and then a drum sander or curved sanding block to smooth it out to the line, or a little beyond. It is OK to have the fretboard fall 1/8" short of the sound hole. We also like to bevel the curved end, or round over the top edge a little. Just check how it looks on the instrument, and work on it until you like the results.

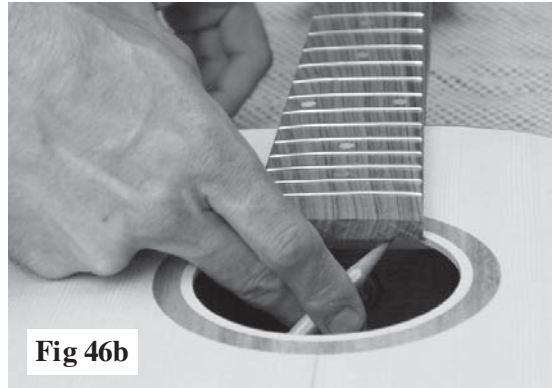

Fig 46b

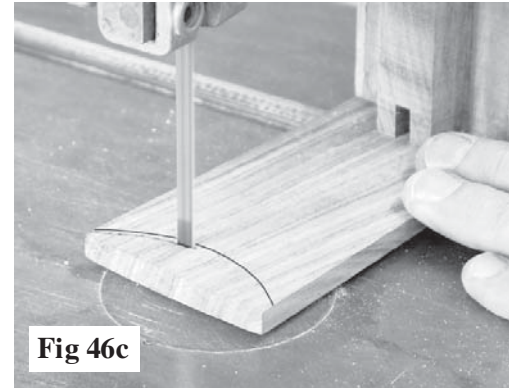

Fig 46c

____47. Now it is time to do final shaping and sanding of the neck and fingerboard assembly. We like to clamp it upside-down at the heel so we have both hands free for filing, sanding, scraping, etc. (fig 47a). The goal is to reduce the thickness until it feels good in your hands for playing. If you don't play a fretted instrument, you might ask a musical friend to help evaluate the neck for comfort.



Fig 47a

Use a rasp for removing material quickly. Then switch to sandpaper to smooth things out and remove the coarse file marks.

Work carefully near the peghead to round things over and smooth out the curves (fig 47b).



Fig 47b

We like to shape the thinnest part of the neck (near the peghead) to about 7/8" (22mm) thick, including the fretboard, and 1-1/2" (38mm) wide.

We also like the back of the neck to be shaped somewhere between a V and a U, so it does not seem "boxy". Here is a drawing of the cross-section we like at about the first space next to the peghead (fig 47c).

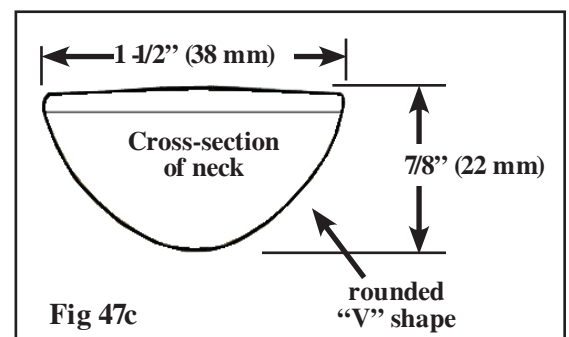

Fig 47c

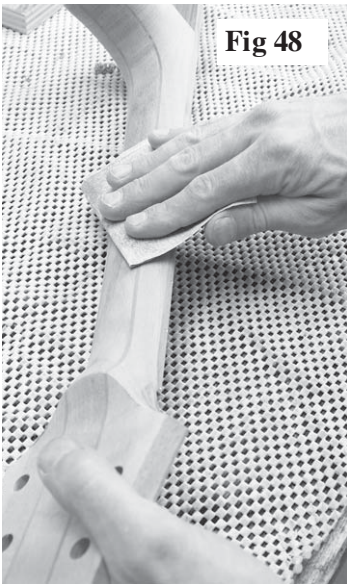

Fig 48

____ 48. When you have the neck shaped to your liking, smooth everything off with medium sandpaper (about 100-150 grit). Check carefully for scratches from your coarser tools, and sand with the grain direction wherever possible (fig 48).

____ 49. **OPTIONAL:** Some players like having side-marking dots on the fretboard for easier reference from the player's perspective. The most common positions are shown in fig 49a.

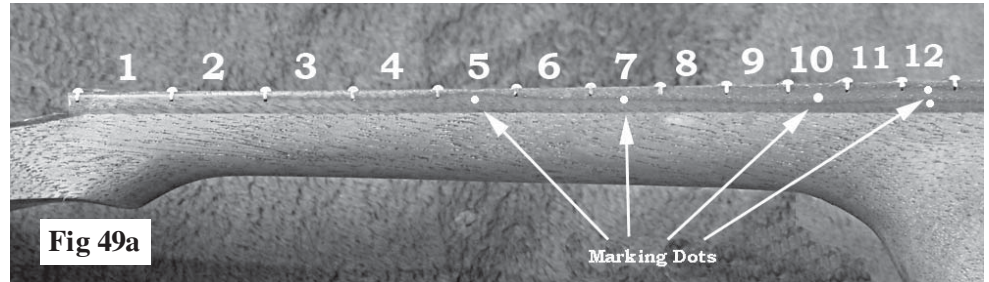

Fig 49a

Use a sharp awl to punch-mark the placement for the marking dots so your drilling will be accurate. Then use the 5/64" drill bit included with this kit for drilling holes about 1/8" deep along the edge, as shown in fig 49b.

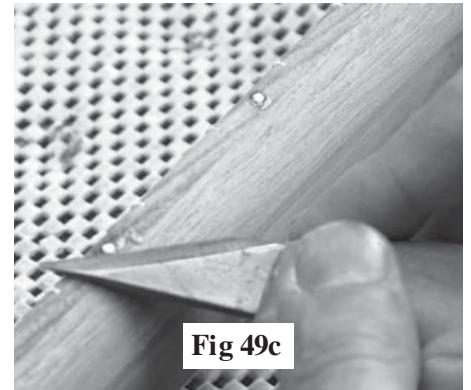

Fig 49c

You don't really need to glue the white stick into the hole if it is a tight fit, but Superglue will work fine if needed. Clip off the excess as you move from hole to hole.

Use a sharp blade or razor knife to trim flush, and follow up with a sanding block to smooth the area (fig 49c).

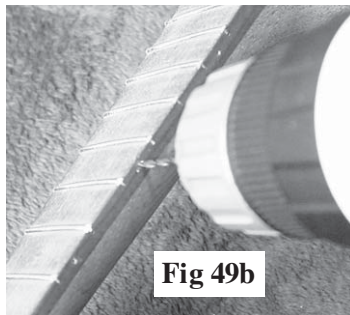

Fig 49b

____ 50. Before you proceed to installing the neck permanently, it is smart to sand the soundboard now when the fretboard is not in the way. Use a sanding block with fine (180-220 grit) sandpaper to smooth especially the area where the fretboard will cover (fig 50).

This is also a good time to use sandpaper to round over the inside edges of the sound hole, just to remove splinters and make it smooth to the touch.

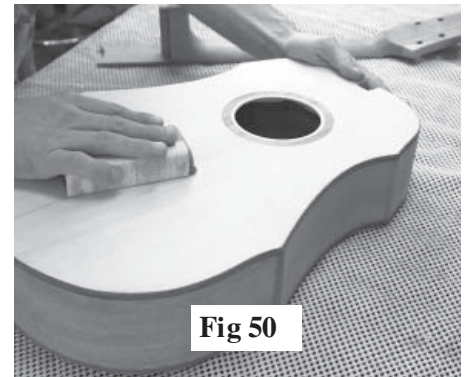

Fig 50

____ 51. Prepare for the gluing operation by having the bolt, wrench, small c-clamp, and a scrap of wood to use as a clamping pad, as shown in fig 51b on the next page. Then you can carefully put glue on just a few places at the heel of the neck and under the fretboard, as shown here in fig 51a. If you overdose here, you'll end up with a lot of messy cleanup, and the extra glue will not make the instrument any stronger.

narrow edges that you fitted earlier

both sides of tenon

near edges of fretboard

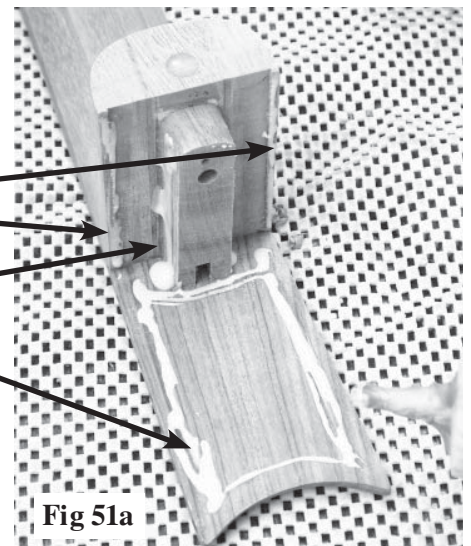

Fig 51a

POINT OF INTEREST

Some luthiers say that gluing just the edges of the the fretboard to the soundboard may help prevent shrinkage and/or stress cracks in the spruce later on. It also facilitates removing the fretboard from the soundboard if repairs are needed.

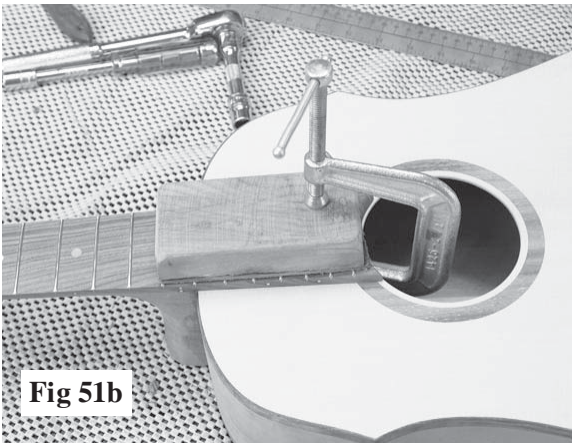

Fig 51b

Quickly slide the neck into place and install the bolt to pull the parts together. Make sure the fretboard is resting flat on the soundboard. Remember that you have a little “wobble room” to slide the neck up or down to get a tight fit.

Add a clamp or two on the fretboard to hold that area. We like to put a scrap wood under the clamp to avoid making dents in the fretboard (fig 51b).

Before the glue dries, use a wet rag to clean up the excess that squeezes out of the joints. Go over the area 2-3 times with a clean wet rag to make sure you don't just smear the glue around.

We like to wrap the rag around a putty knife or thin screwdriver to help clean into the corners (fig 51c). This will save you some frustration later.

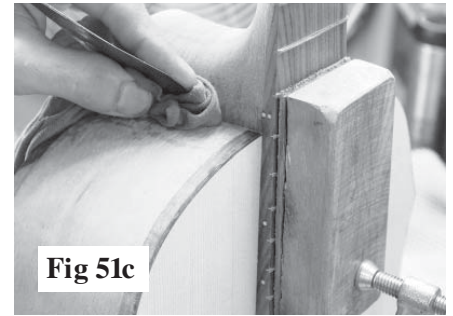

Fig 51c

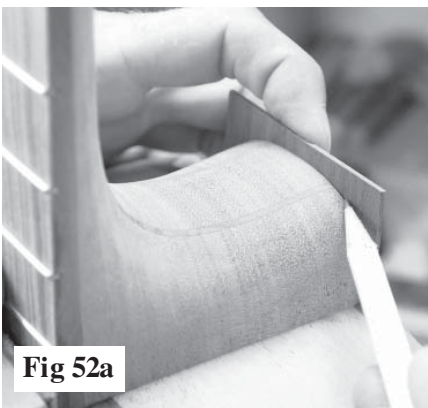

Fig 52a

___ 52. Find the thin walnut heel cap for covering heel of the neck and trim it a little over-size before gluing it in place (fig 52a).

You'll want to fit the edge that meets the body nicely (fig 52b). Use sandpaper to smooth it off and fit it against the end of the instrument.

The other edges can hang over the heel for trimming off after the glue dries.

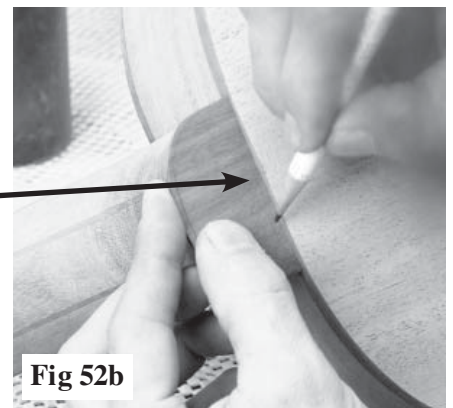

Fig 52b



Fig 52c

When ready, add glue to the heel cap and hold it securely in place with tape while you get a clamp ready to press it firmly (52c & 52d).

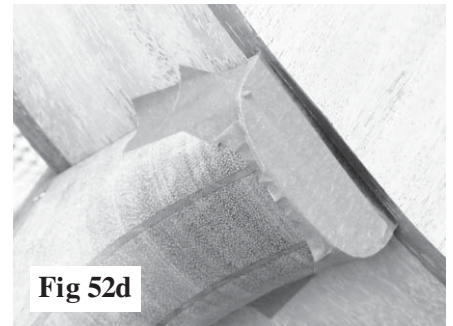

Fig 52d

Be sure to pad the clamp area so you don't dent the instrument (fig 52e).

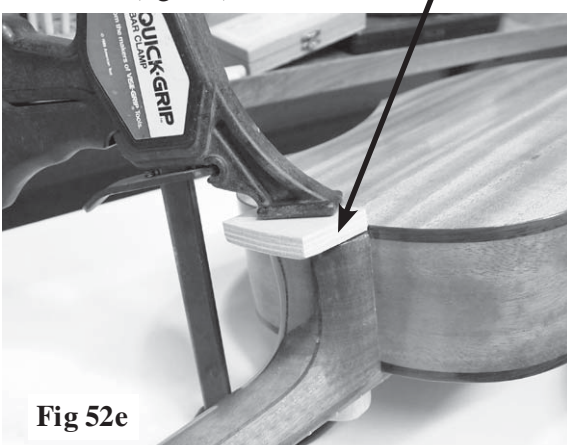

Fig 52e

INSTALLING THE BRIDGE

___53. Now that the neck is in place permanently, you can find the proper location for the bridge and install that on the soundboard. Begin by measuring 24-1/2" from the #0 fret at the narrow end of the fretboard and placing a piece of masking tape lightly on the soundboard at that location (fig 53a).

Then hold a straight-edge along each side of the fretboard and mark the masking tape where the straight-edge crosses it, as shown .

Find the center between those two marks so you can center the bridge to align with the fretboard (fig 53b).

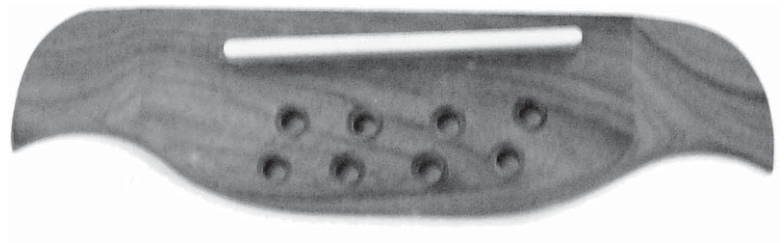
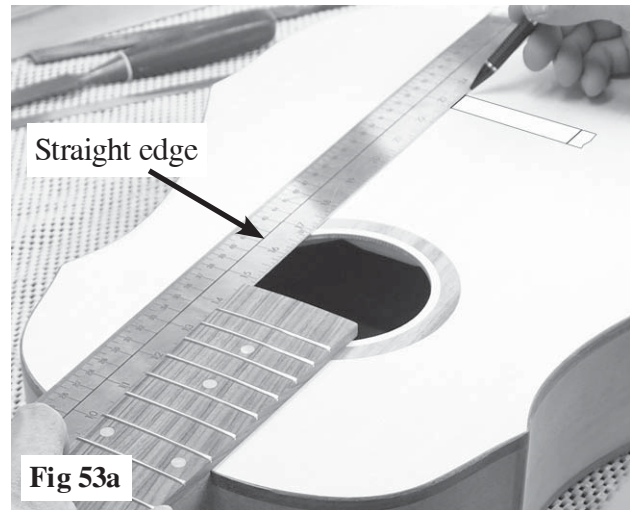
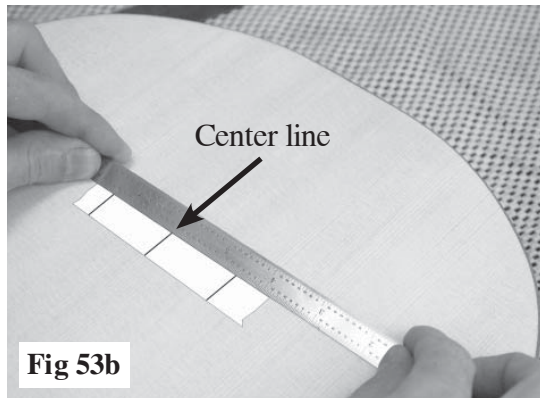

___55. When you are ready to install the bridge, carefully measure 24-5/8" (625.5mm) from the center of the #0 fret to the center of the bass end of the saddle slot on the bridge. Notice that the saddle is angled on the bridge. The bridge itself should be aligned with the front edge perpendicular to the center line of the instrument, so the bass end of the saddle will be a little further toward the tail end than the treble end of the saddle. It should look just like the drawing below (fig 55a).

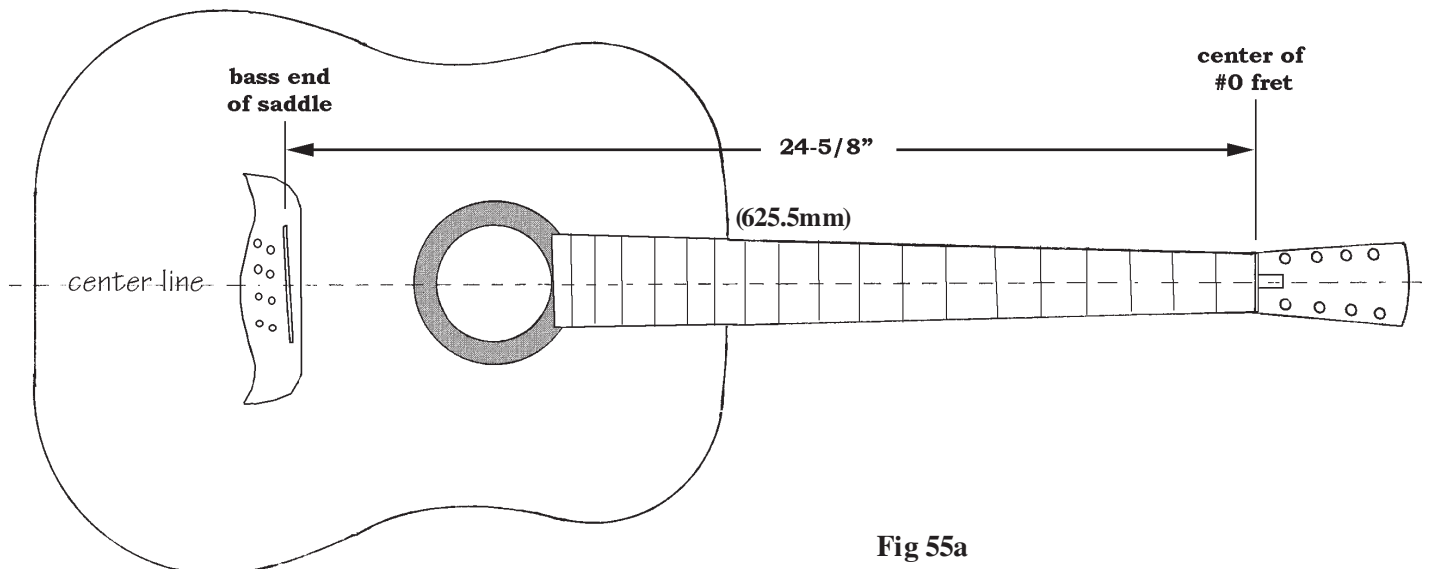

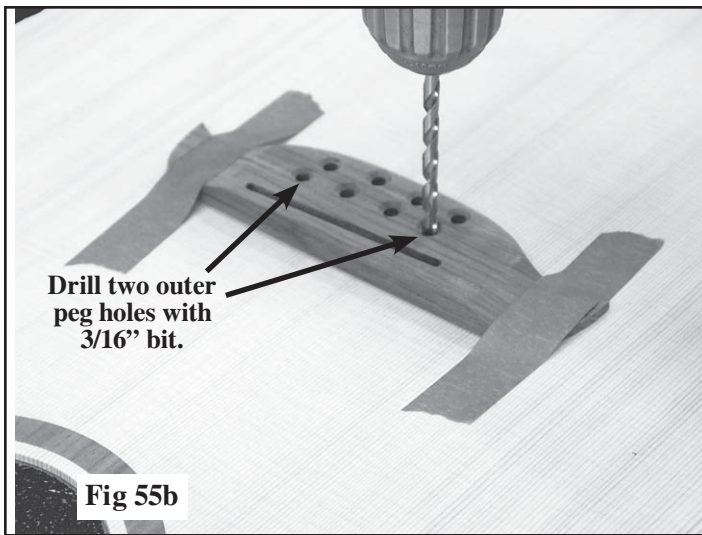

When you determine the correct place for the bridge, use masking tape to hold it in place while you drill just the outer two peg holes with a 3/16" bit, as shown in fig 55b. Don't risk trying to drill all six holes now - the bridge may slip out of position.

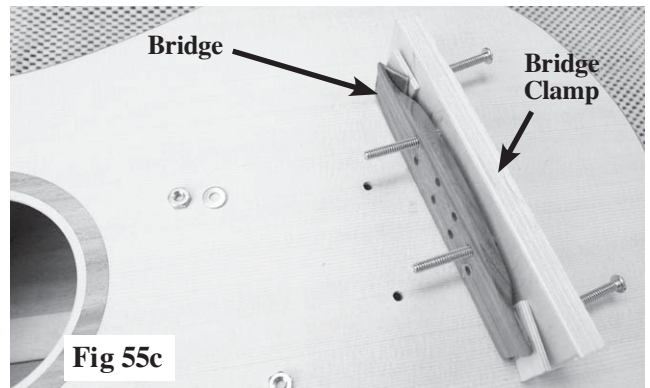

Assemble the bridge clamp to the bridge as in fig 55c, with the machine screws lightly installed. Test-fit the assembly into the two holes you just drilled in the soundboard, to make sure everything fits well. **IMPORTANT: the bridge can be installed backwards!** Be careful to make sure the flat edge closest to the saddle slot is facing the soundhole.

When ready, spread glue on the underside of the bridge and push it down into place with the two screws going through the soundboard. Reach into the soundhole with one hand to install the washers and wing-nuts on each screw. Then use a Phillips screwdriver to tighten the two inner screws on the bridge clamp (fig 55d). You should see some glue squeezing out around the bridge from this pressure.

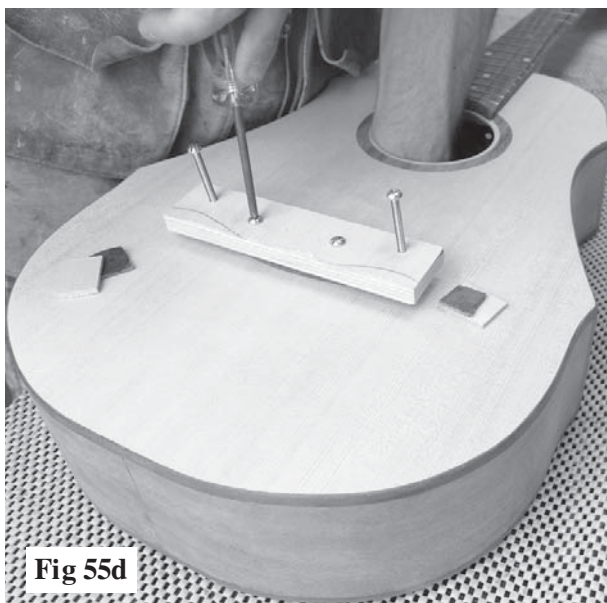

Make sure to slide a scrap of wood under each of the end screws to protect the "wings" of the bridge as you screw pressure onto them (fig 55e). We actually use a thin wood scrap with a piece of thick leather or fabric underneath, to prevent scratching or denting the bridge.

Carefully clean up excess glue with a damp rag, making several passes to scrub away all glue residue.

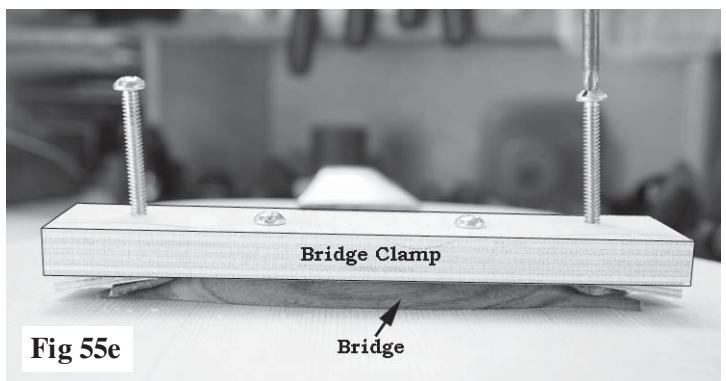

____56. We like to use a flat mill file to level the tops of the frets, as shown in fig 56a. You can use a regular mill file from the hardware store for this job. We use epoxy glue to adhere the file to a thick block of wood, creating a nice handle.

File until all the frets are slightly touched by the action. That's when you know they are all the same height.



If you ended up flattening the tops of some frets significantly with the big file, you'll want to round them over again by knocking off the sharp corners with a small triangle file or needle file (fig 56b). Be sure to protect the surface of the fretboard with some tape when doing this work so you don't scratch the wood you so carefully sanded earlier.

Sometimes a string will buzz at a certain fret because the neighboring fret is a little higher, and sometimes because of a flat spot on the top of the fret. Your leveling work should prevent the first problem, and this light filing should correct the second one.

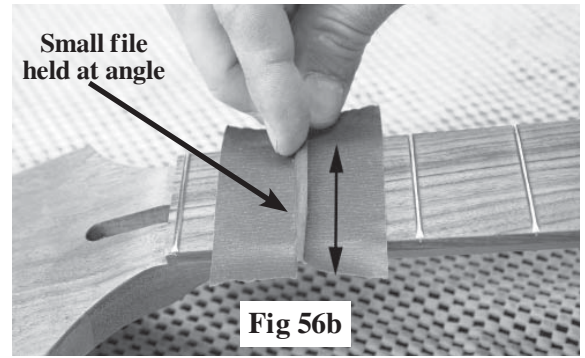

Follow up with sanding the tops of the frets as shown in fig 56c. Just wrap your hand with medium sandpaper (180 grit) and drag the edge of your hand across the frets in both directions to smooth all the filing marks from the earlier steps.

Switch to fine sandpaper (220 grit or higher) if you want to polish the frets nicely.

The fretwire is relatively soft metal, so your handwork here will make a nice difference in smooth playability.

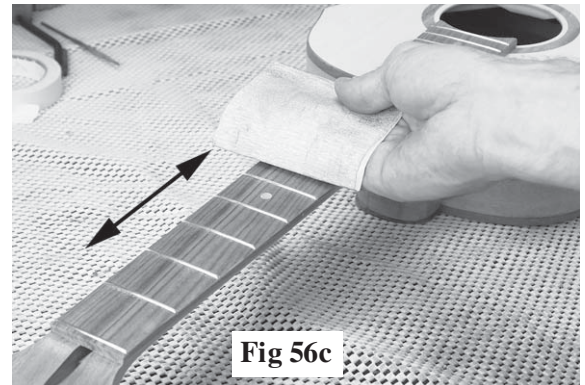

___57. Before applying finish to your instrument, you'll want to seal off the playing surface of the fretboard with masking tape, as shown in figs 57a and 57b below. You don't want to put varnish on this surface because it can become gummy over time from your fingers. You can oil it lightly (linseed oil) after the rest of the instrument is finished, but we just leave the playing surface unfinished. Rosewood has enough natural oils to resist moisture on its own.

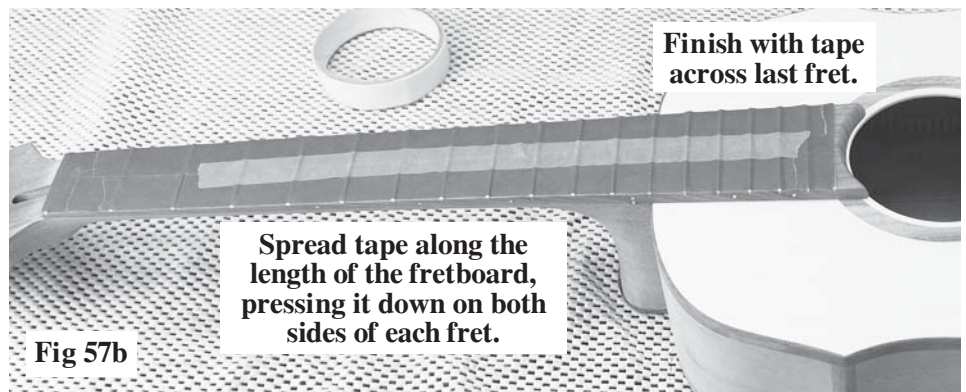
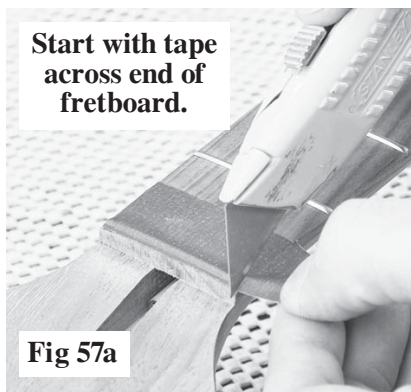

___58. Find the little truss rod cover plate and sand one side to prepare it for finish. We like to taper the flat end a little so it will fit up against the nut nicely when you screw it to the peghead.

Don't install the cover plate until the end. Just set it out for finishing.

Whew! You are just about ready for finishing. But before you get to that, we highly recommend that you relax and check over the entire instrument closely to see if you can find any more glue smudges or dings that might need a little attention. It is much easier to correct that sort of thing before the finish is applied.

Also check for gaps in the glue joints. You can use mahogany colored wood filler from the hardware to fill those gaps, pressing the paste in with a putty knife or flat screwdriver blade. Sand the filled area after it dries to remove any excess paste.



Sand about 10 degree angle at this end to fit up against nut.

APPLYING THE FINISH

Use a clean cloth to wipe off any sanding dust from the wood. Some people buy tack cloth for this purpose, but we just use a clean rag.

Another option is to wet the rag with denatured alcohol (from the hardware store) for cleaning the wood more fully. Alcohol does not raise the grain like water does, and it evaporates quickly, leaving no spots. But this trick is not a necessary step -- just kind of fun to do. The alcohol will give you a preview of the beautiful depth and color of the wood.

Now you are ready to apply the finish. Here are some recommendations:

STAIN -- STAINS are coloring agents and should only be used if you dislike the natural color of the wood. We generally discourage people from trying to stain this project because the natural wood grain is so beautiful with a simple clear finish. It is difficult to mask off the soundboard, for instance, and just stain the sides and back of the body because the stain tends to “bleed” under the masking tape. If you are a novice at finishing, or facing a deadline for completion, we especially recommend avoiding stain.

OIL -- An oil finish (such as Watco Danish Oil) will give your wood a low luster appearance, bringing out the natural color of the grain, but it tends to soak into the wood and appear dry and “thirsty” after awhile. The principal advantage of an oil finish is that it can be applied and wiped dry immediately, allowing you to proceed to installing hardware (and strings) right away. The disadvantage of oil is that it usually does not give much surface protection or sheen, unless you know how to polish out many coats of gun stock oil.

POLYURETHANE -- Any polyurethane will work fine on this project, but we like the solvent-based ones better than water-borne versions. One of our favorites is a wipe-on satin Gel Topcoat polyurethane that comes with our Instrument Finishing Kit. The advantages of this finish are its simple application (no drips or runs), durability, and deep, soft luster.

LACQUER -- Many professional instrument makers still use nitro-cellulose lacquer for their finish. The most readily available lacquer is called Deft Clear Wood Finish (semi-gloss). If you choose this product, it is best to purchase a can of liquid Deft to brush on as a sealer coat first, and then use an aerosol can of the same product to spray the final coats. The advantage of this finish is its quick drying time, but the disadvantage is the strong odor and toxic lacquer fumes. **CAUTION:** Lacquer finish may smear some painted decorations or blister some types of decorative decals. If you plan to add paints or decals to your instrument, it would be better to finish with polyurethane instead of lacquer.

So choose your weapon and proceed with finishing all the wood parts except the top of the fretboard. Plan on applying at least three coats of finish. If you don't use our Gel Topcoat, be sure to follow the directions on the can.

Don't forget to finish the truss rod cover too!

INSTALLING HARDWARE AND STRINGS

____ 59. When the finish is dry, and you are happy with the results, you can begin installing the last few pieces. The first item is the African Blackwood nut that gets glued at the end of the fretboard, as shown at right (fig 59a).

It is easiest to trim and shape it before gluing it in place. It should stand just a little higher than the #0 fret. We like to slope the top down toward the peghead as shown in fig 59b.

When you have the nut trimmed and shaped, use Superglue or 5-minute epoxy to glue it in place.

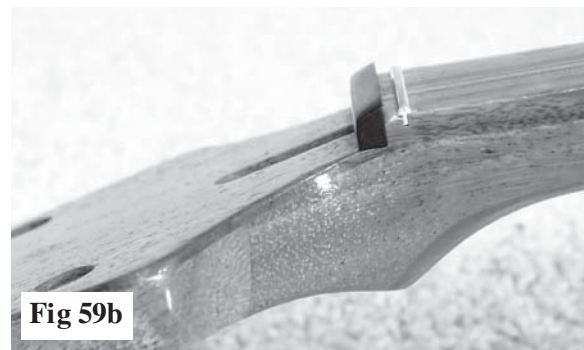
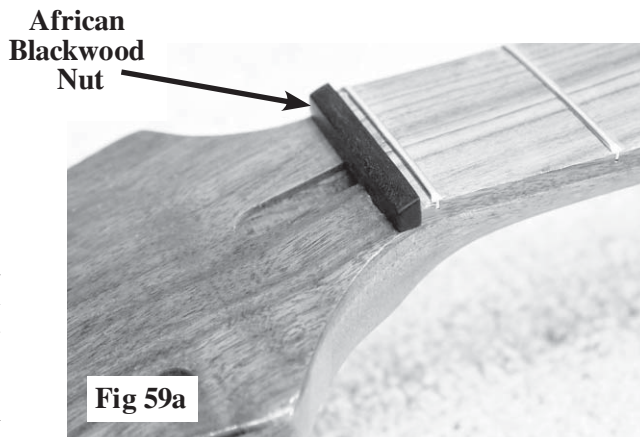

___60. The nut needs to be notched for spacing the strings evenly across the width. We like to leave at least 1/8" (3mm) space at each end of the nut before the first and last notches. Then we try to space the other 6 notches as shown in Fig 60a, using a metric ruler.

The exact spacing for your instrument will depend on the overall width of the fretboard at the nut. If you have about 38 mm total width, as shown, then you can put the first and last notches 3mm from each side, and space the rest of them according to the measurements at right.

Use tape to hold your ruler still on the fretboard, and another piece of tape on the nut for drawing your notch positions.

If you don't have the same width on your instrument neck, then make slight adjustments to the spacing between pairs of strings. Notice that the heavier pairs need slightly wider spacing than the lighter strings.

- 1st at 3mm
- 2nd at 6mm
- 3rd at 11mm
- 4th at 14mm
- 5th at 20mm
- 6th at 23.5mm
- 7th at 30mm
- 8th at 34mm

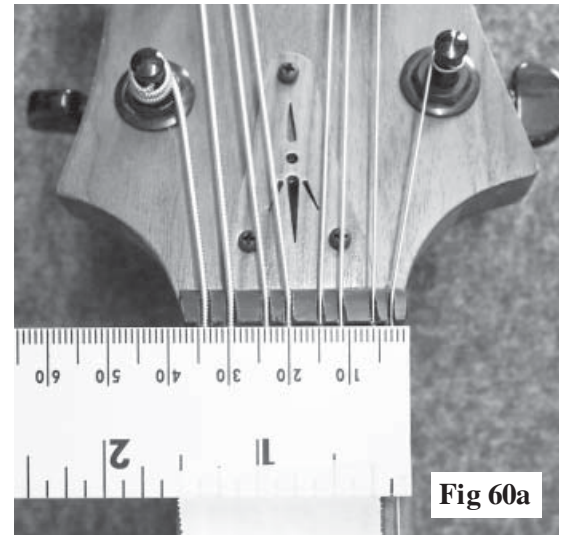

Fig 60a

Once you have your notches marked evenly across the nut, you need to cut slots for the strings at each position. Since the strings vary in thickness, you should make sure your slots will accommodate them all. An experienced luthier will keep a set of nut files in different sizes so he can cut each slot for each particular string, but that is not necessary on this kit.

You can cut these notches using a very small "V" shaped needle file or triangle file. You just need to file them deep enough to make sure the strings will rest firmly on the #0 fret. You'll need to angle the file downward toward the peghead, and avoid cutting into the #0 fret, as shown in fig 60b. We like to cover the peghead with thin cardboard to protect it from being scraped accidentally by the file.



Fig 60b

POINT OF INTEREST

Normally, the notches in the nut would have to be filed to a specific depth to support the strings at the right height above the frets. For this kit, however, the #0 fret holds the strings at the correct height, and the notches only serve to separate the strings evenly across the width. This saves you some headache and guesswork at the end of the project.

___61. Press the geared tuners into the peghead from the back side (fig 61a). If they are a bit tight, you can clean the inside of the holes a little with a rat-tail file to make them easier to press in. Orient the handles so they look evenly spaced and straight.

Then flip the peghead over and insert the threaded sleeves and washers. Use a 7/16" nut driver or small adjustable wrench to tighten the sleeves firmly (fig 61b).

Pre-drill for the tiny screws with the 1/16" drill bit provided (fig 61c). Then install the screws using a #1 size Phillips screwdriver.

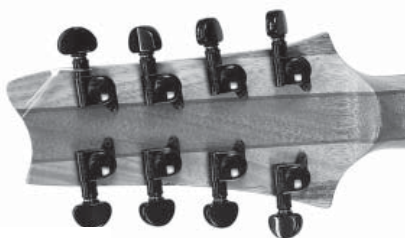

Fig 61a

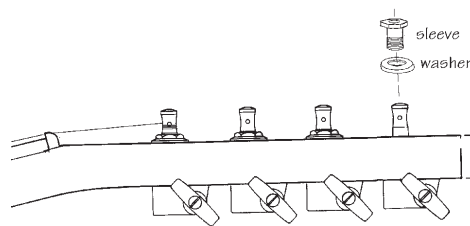

Fig 61b

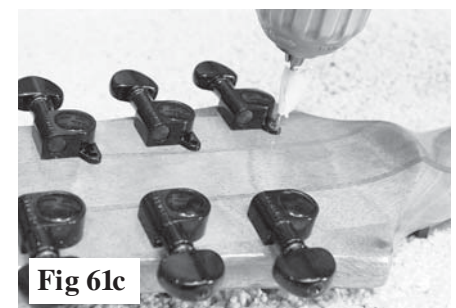

Fig 61c

62. Before covering the truss rod slot, find the Allen wrench provided and tighten the nut finger-tight for now, just to keep it from rattling (fig 62a). You may need to adjust it one way or the other later to correct a bow in the neck. Then center the truss rod cover over the opening and hold it in place with masking tape while you drill 1/16" pilot holes into the peghead for the tiny screws (fig 62b). Then you can install the three tiny screws that hold the cover in place.



Fig 62a

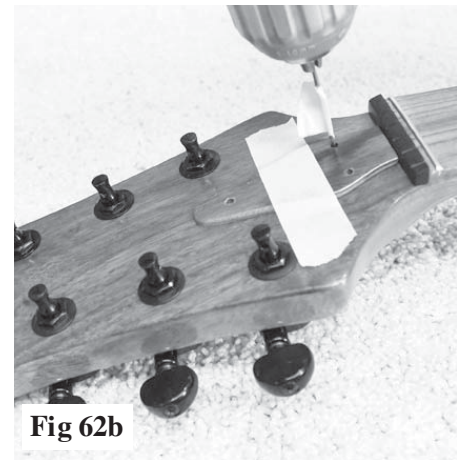

Fig 62b

63. Drill through the remaining holes in the bridge with the 3/16" bit provided. These holes need to be slightly tapered to accept the bridge pegs. A cheap and simple way to do that is to use a small (6") rat-tail file (fig 63). You can chuck it into your hand drill and spin it in reverse as you push it gently into the hole. Be careful not to file too far -- it is best to fit the pegs fairly snugly.

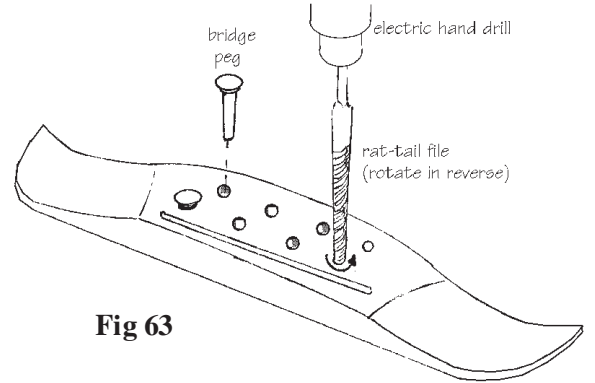

Fig 63

64. Test-fit the first string on the instrument, pushing the "ball end" into the first hole in the bridge, followed by the bridge peg (fig 64a). Note that the pegs have a hollow side of the shaft large enough to accommodate the thick string.

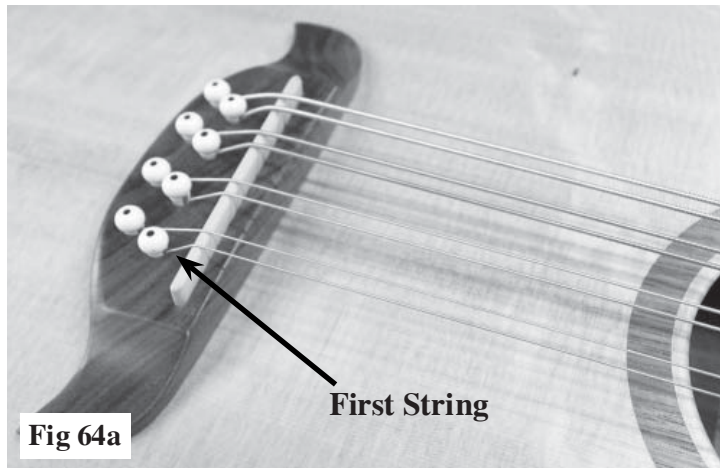

Fig 64a

HINT: The ball on the end of the string is meant to be deflected to one side of the peg inside the instrument, as shown in fig 64b. This prevents the string from pulling out along with the peg when you tune the string up to full tension.

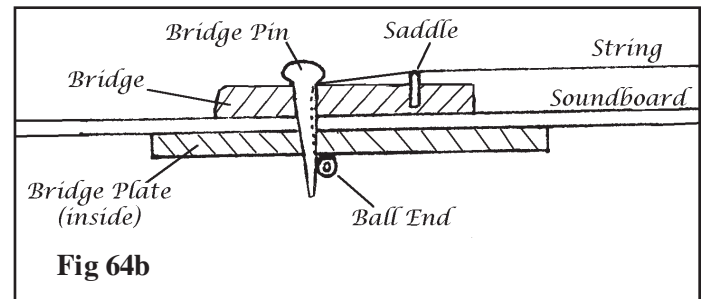

Fig 64b

65. Stretch the string across the instrument to the peghead and attach it to the first tuning post. Turn the gear so the string wraps to the inside of the post, as shown on next page. Be careful not to over-tighten -- it is best to pluck the string and let it ring as you tighten the tuning gear. This first string is the highest note on the instrument: A3 just below Middle C for the Mandocello, or E4 just above Middle C for the Octave Mandolin.

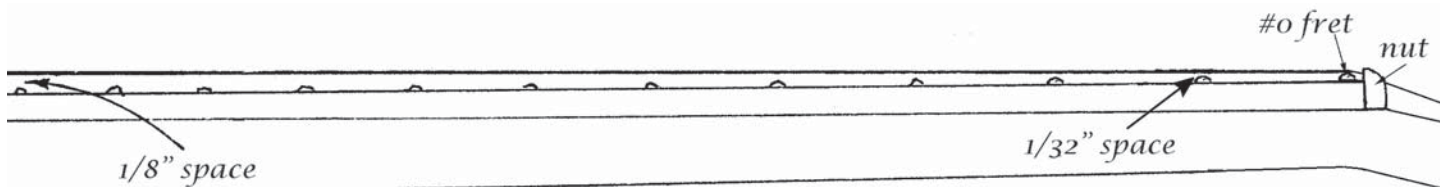

Fig 65

When the first string is up to pitch, check how it lies over the frets of the playing surface. You should not need to worry about the height at the first fret near the peghead, unless you didn't file the notches in the nut deep enough to allow the string to rest on top of the #0 fret. Correct that detail now if needed (fig 65).

Check the space under the string at the 12th fret, near the joint with the body. That should not be more than about 1/8" for the instrument to be easy to play. Here are some things to check for correcting the string height if necessary:

a) Sight down the length of the fretboard to see if it is still flat. If you see a significant bend in the middle, then you'll need to adjust the truss rod. CAUTION: Remember that you have a double-action truss rod. Turning it one way will correct the bend in the neck, but turning it the other way will increase the bend. So be careful to watch which way your adjustment is affecting the neck. DO NOT FORCE THE TRUSS ROD NUT! Some people have broken the nut right off the rod by torquing it too much. Contact us if you need assistance.

b) If the fretboard is pretty straight, and the string is still too high above the 12th fret, then you need to shave the saddle a little lower at the bridge. Loosen the string so you can remove the saddle. We like to draw a pencil line near the bottom of the saddle to guide our sanding process (fig 65b). You can sand the bottom of the saddle with a coarse sanding block, checking to make sure the bottom edge stays parallel with your pencil line. You don't need to sand all the way to the line -- just use it as a reference point. Note that sanding a certain amount off the saddle will reduce the string height by half of that amount at the 12th fret (midpoint). Replace the saddle in the bridge again and tighten the string to test the gap at the 12th fret.

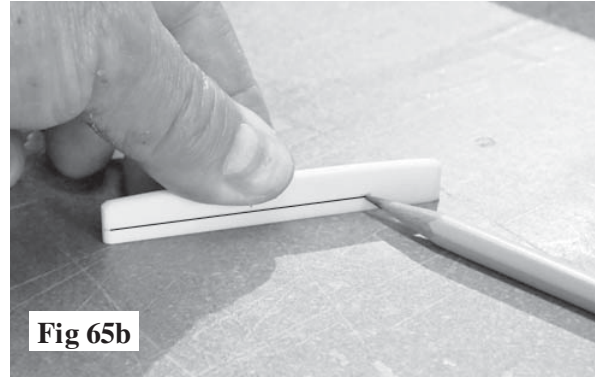

Fig 65b

c) If, on the other hand, the string is too low over the 12th fret, you may need to shim the saddle a little higher. You can clip a section of excess string to lay in the slot under the saddle.

Once you have the first string hanging the right height above the strings, you can install the rest of the strings as shown in the photos below. Notice that the strings wrap around to the inside of all the tuning gear posts on the peghead. This is a helpful detail to keep the strings from pulling sideways and jumping out of the notches in the nut.

Tune the instrument according to the string set you are installing, making either a Mandocello or an Octave Mandolin. The instrument can be strung for either format, and you can convert from one to the other in the future by simply changing the strings and the tuning.

OCTAVE MANDOLIN TUNING

MANDOCELLO TUNING

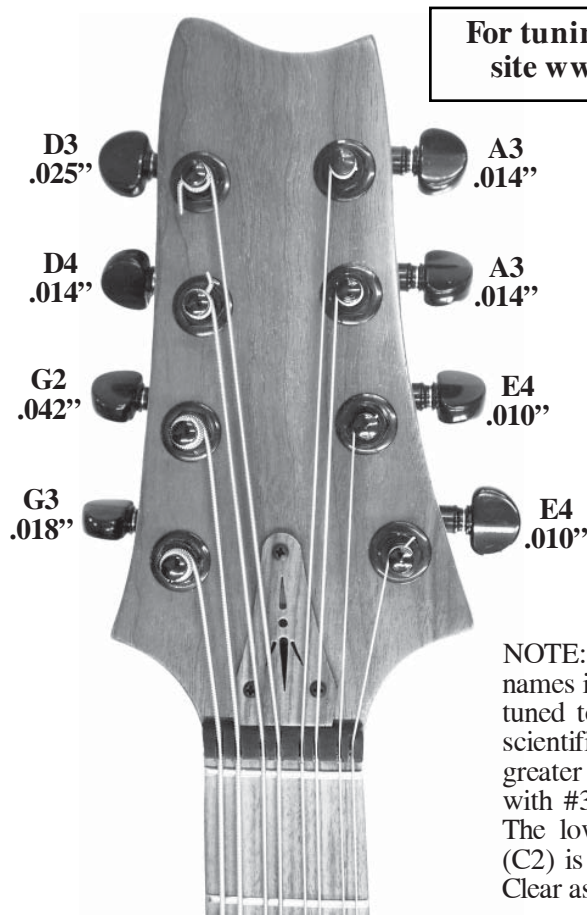

For tuning assistance, go to our web site www.harokit.com/freetuner

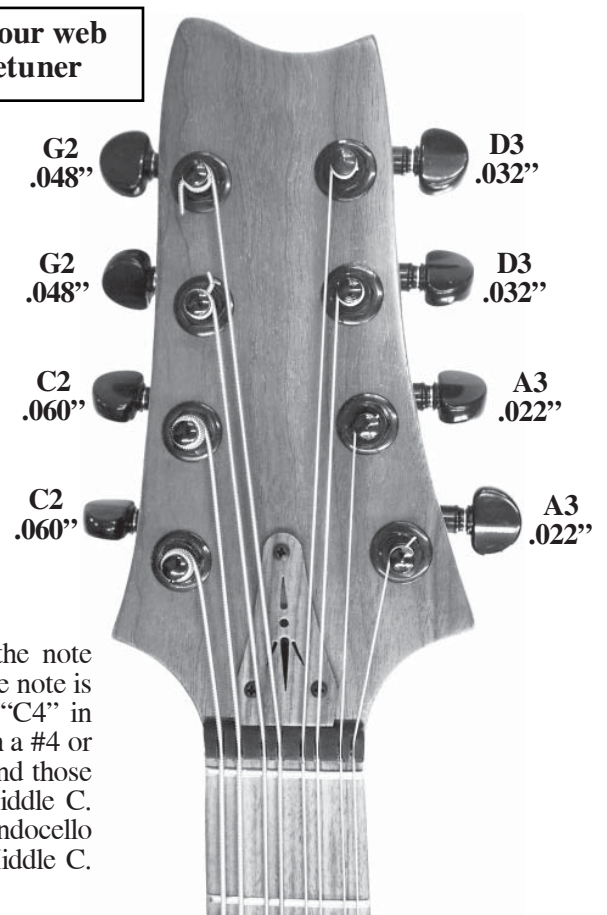

NOTE: The numbers after the note names indicate what octave the note is tuned to. Middle C is called "C4" in scientific circles, so notes with a #4 or greater are above Middle C, and those with #3 or less are below Middle C. The lowest note on the Mandocello (C2) is two octaves below Middle C. Clear as mud?

FINE ADJUSTMENTS AND TROUBLESHOOTING

_____66. There may still be some fine adjustments needed to make your instrument work its best. Test each string by plucking it with one hand while you press it down at each playing position (fret) along the neck. Here is what to check for:

a). If the string is difficult to push all the way to the fretboard, it is too high. If the neck has bent forward because of the string tension, you will use the truss rod to counteract that. Loosen the strings before adjusting the truss rod, and be careful not to break the nut of the truss rod! This is a double-action rod, so turning one way will bend the neck forward and the other way will bend it backward.

b). If the neck is straight but the strings are still too high, remove the saddle from the bridge and sand the bottom so it does not stand so tall. Sanding 1/8" off the saddle will lower the strings by 1/16" at the 12th fret, near the middle of the instrument.

c). If a string buzzes when plucked in the OPEN POSITION ONLY (when not held down to a fret), then the notch in the NUT is probably not deep enough to allow the string to rest firmly on the #0 fret. File that notch a little deeper.

d). If your strings buzz and rattle in general as you play, sight down the fretboard first. Some seasonal changes may cause it to bend backward. Adjust the truss rod to allow the strings to pull the neck forward. You may also shim up the saddle in the bridge to raise the strings a little higher.

e). If a string rattles or buzzes at just one or two positions (frets), or if you discover that two or three frets all give the same pitch, then look for a fret that stands up higher than its neighbors. You will need to either tap that fret down fully into its slot in the fretboard or use a flat mill file to level the tops of the frets some more. Just loosen the strings, lift them out of the grooves in the nut, and hold them along either side of the fingerboard as you work the file lengthwise along the tops of those frets that are high. You can easily see which frets are the highest, as they are the ones that receive the most filing.

ACCESSORIES AVAILABLE FOR OCTAVE MANDOLIN & MANDOCELLO

Musicmaker's finishing kit

Plastic pick-guard

Spare set of 8 steel strings (your choice)

Guitar strap with 2 mounting buttons

Gig Bag

Electronic Tuner (chromatic) to aid in accurate tuning

Piezo Pickup for amplification

Call us toll-free (1-800-432-5487) or check our web site (www.harokit.com) for pricing and availability.

INSTALLING OPTIONAL ACCESSORIES

___66. If you want to install a strap on your instrument, place one mounting button centered at the tail end of the body, and the other button at the heel, as shown in fig 66.

NOTE: The screw should be located about 1-1/2" from the bottom of the heel so as to avoid interfering with the bolt inside the heel.

Be sure to drill a pilot hole for the mounting screws -- otherwise you might crack the wood in the heel! If the screw is difficult to turn into the wood, then your pilot hole is too small for the screw.

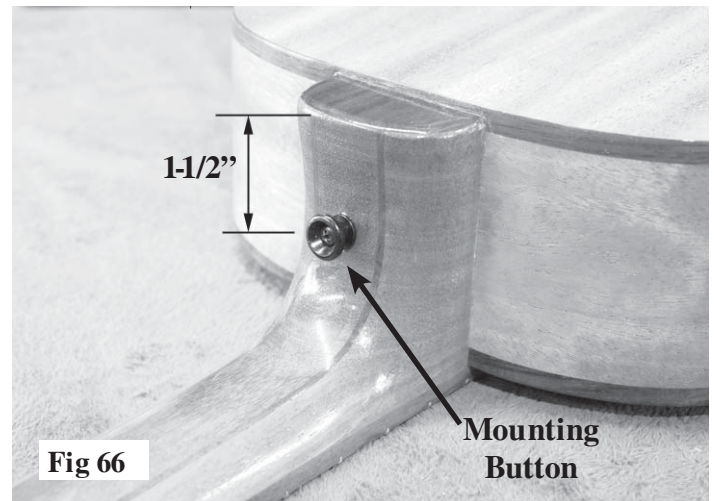

___67. You can add a pick guard around the soundhole to protect the finish from damage from strumming with a flatpick (fig 67). This standard shaped guard fits around the inlaid ring very nicely, and it is simple to install -- just peel and stick.



___68. If you'd like to amplify your instrument, one nice option is to install a piezo pickup inside, with a jack at the tail end that serves the double purpose of a strap button and output jack. We offer either single-sensor or double-sensor piezo pickups at Musicmaker's, and they are excellent quality for a reasonable price.

Installing a piezo pickup involves drilling a 1/2" diameter hole through the tail end of the body for the jack. You will also need to remove the strings so you can reach one hand into the soundhole to place the sensors against the inside of the soundboard. The adhesive for the sensors is included with the pickup. The most effective locations for the sensors is shown in the drawings below (fig 68a and 68b).

