



Ohio Department of Natural Resources Division of Water Fact Sheet

Fact Sheet 94-32

Dam Safety: Concrete Repair Techniques

Concrete is an inexpensive, durable, strong and basic building material often used in dams for core walls, spillways, stilling basins, control towers, and slope protection. However, poor workmanship, construction procedures, and construction materials may cause imperfections that later require repair. Any long-term deterioration or damage to concrete structures caused by flowing water, ice, or other natural forces must be corrected. Neglecting to perform periodic maintenance and repairs to concrete structures as they occur could result in failure of the structure from either a structural or hydraulic standpoint. This in turn may threaten the continued safe operation and use of the dam.

Considerations

Floor or wall movement, extensive cracking, improper alignments, settlement, joint displacement, and extensive undermining are signs of major structural problems. In situations where concrete replacement solutions are required to repair deteriorated concrete, it is recommended that a registered professional engineer be retained to perform an inspection to assess the concrete's overall condition, and determine the extent of any structural damage and necessary remedial measures.

Typically, it is found that drainage systems are needed to relieve excessive water pressures under floors and behind walls. In addition, reinforcing steel must also be properly designed to handle tension zones and shear and bending forces in structural concrete produced by any external loading (including the weight of the structure). Therefore, the finished product in any concrete repair procedure should consist of a structure that is durable and able to withstand the effects of service conditions such as weathering, chemical action, and wear. Because of their complex nature, major structural repairs that require professional advice are not addressed here.

Repair Methods

Before any type of concrete repair is attempted, it is essential that all factors governing the deterioration or failure of the concrete structure are identified. This is required so that the appropriate remedial measures can be undertaken in the repair design to help correct the problem and prevent it from occurring in the future. The following techniques require expert and experienced assistance for the best results. The particular method of repair will depend on the size of the job and the type of repair required.

1. **The Dry-Pack Method:** The dry-pack method can be used on small holes in new concrete which have a depth equal to or greater than the surface diameter. Preparation of a dry-pack mix typically consists of about 1 part portland cement and 2 1/2 parts sand to be mixed with water. You then add enough water to produce a mortar that will stick together. Once the desired consistency is reached, the mortar is ready to be packed into the hole using thin layers.
2. **Concrete Replacement:** Concrete replacement is required when one-half to one square foot areas or larger extend entirely through the concrete sections or where the depth of damaged concrete exceeds 6 inches. When this occurs, normal concrete placement methods should be used. Repair will be more effective if tied in with existing reinforcing steel (rebar). This type of repair will require the assistance of a professional engineer experienced in concrete construction.
3. **Replacement of Unformed Concrete:** The replacement of damaged or deteriorated areas in horizontal slabs involves no special procedures other than those used in good construction practices for placement of new slabs. Repair work can be bonded to old concrete by use of a bond coat made of equal amounts of sand and cement. It should have the consistency of whipped cream and should be applied immediately ahead of concrete placement so that it will not set or dry out. Latex emulsions with portland cement and epoxy resins are also used as bonding coats.
4. **Preplaced Aggregate Concrete:** This special commercial technique has been used for massive repairs, particularly for underwater repairs of piers and abutments. The process consists of the following procedures: 1) Removing the deteriorated concrete, 2) forming the sections to be repaired, 3) prepacking the repair area with coarse aggregate, and 4) pressure grouting the voids between the aggregate particles with a cement or sand-cement mortar.
5. **Synthetic Patches:** One of the most recent developments in concrete repair has been the use of synthetic materials for bonding and patching. Epoxy-resin compounds are used extensively because of their high bonding properties and great strength. In applying epoxy-resin patching

Continued on back!

mortars, a bonding coat of the epoxy resin is thoroughly brushed onto the base of the old concrete. The mortar is then immediately applied and troweled to the elevation of the surrounding material.

Before attempting to repair a deteriorated concrete surface, all unsound concrete should be removed by sawing or chipping and the patch area thoroughly cleaned. A sawed edge is superior to a chipped edge, and sawing is generally less costly than mechanical chipping. Before concrete is ordered for placing, adequate inspection should be performed to ensure that (1) foundations are properly prepared and ready to receive the concrete, (2) construction joints are clean and free from defective concrete, (3) forms are grout-tight, amply strong, and set to their true alignment and grade, (4) all reinforcement steel and embedded parts are clean, in their correct position, and securely held in place, and (5) adequate concrete delivery equipment and facilities are on the job, ready to go, and capable of completing the placement without addition unplanned construction.

Concrete Use Guidelines

In addition to its strength characteristics, concrete must also have the properties of workability and durability. Workability can be defined as the ease with which a given set of materials can be mixed into concrete and subsequently handled, transported, and placed with a minimal loss of homogeneity. The degree of workability required for proper placement and consolidation of concrete is governed by the dimensions and shape of the structure and by the spacing and size of the reinforcement. The concrete, when properly placed, will be free of segregation, and its mortar is intimately in contact with the coarse aggregate, the reinforcement, and/or any other embedded parts or surfaces within the concrete. Separation of coarse aggregate from the mortar should be minimized by avoiding or controlling the lateral movement of concrete during handling and placing operations. The concrete should be deposited as nearly as practicable in its final position. Placing methods that cause the concrete to flow in the forms should be avoided. The concrete should be placed in horizontal layers, and each layer should be thoroughly vibrated to obtain proper compaction.

All concrete repairs must be adequately moist-cured to be effective. The bond strength of new concrete to old concrete develops much more slowly, and the tendency to shrink and loosen is reduced by a long moist-curing period.

In general, the concrete repair procedures discussed above should be considered on a relative basis and in terms of the quality of concrete that one wishes to achieve for their particular construction purpose. In addition to being adequately designed, a structure must also be properly constructed with concrete that is strong enough to carry the design loads, durable enough to withstand the forces associated with weathering, and yet economical, not only in first cost, but in terms of its ultimate service. It should be emphasized that major structural repairs to concrete should not be attempted by the owner or persons not experienced in concrete repairs. A qualified professional engineer experienced in concrete construction should be obtained for the design of large scale repair projects.

Crack Repair

The two main objectives when repairing cracks in concrete are structural bonding and stopping water flow. For a structural bond, epoxy injection can be used. This process can be very expensive since a skilled contractor is needed for proper installation. The epoxy is injected into the concrete under pressure, welding the cracks to form a monolithic structure. This method of repair should not be considered if the crack is still active (moving). For a watertight seal, a urethane sealant can be used. This repair technique does not form a structural bond; however, it can be used on cracks that are still active. Cracks should be opened using a concrete saw or hand tool prior to placing the sealant. A minimum opening of $\frac{1}{4}$ inch is recommended since small openings are hard to fill. Urethane sealants can be reapplied since they are flexible materials and will adhere to older applications. As previously noted, all of the factors causing cracking must be identified and addressed before repairing the concrete to prevent the reoccurrence of cracks.

Any other questions, comments concerns, or fact sheet requests, should be directed to the Division of Water at the following address:

Ohio Department of Natural Resources
Division of Water
Dam Safety Engineering Program
1939 Fountain Square, Building E-3
Columbus, Ohio 43224-1336
(614) 265-6731 (Voice) (614) 447-9503 (Fax)
<http://www.dnr.state.oh.us/odnr/water/>



Bob Taft *Governor* • Samuel W. Speck *Director* • James R. Morris, P.E. *Chief*



Ohio Department of Natural Resources Division of Water Fact Sheet

Fact Sheet 95-38

Dam Safety: Design and Maintenance of Trashracks for Pipe and Riser Spillways

The principal spillway for dams in the State of Ohio can be one of several designs. The proper operation of these spillways is an important part of maintaining the overall safety of the dam. Pipe and riser, drop inlet, and slant pipe spillways are susceptible to obstruction and damage by floating debris such as leaves, branches, and logs. One device used to ensure that these spillways operate correctly is a trashrack. Trashracks are designed to keep trash and other debris from entering the spillway and causing damage.

Common problems

Trashracks usually become plugged because the openings are too small or the head loss at the inlet causes material and sediment to settle out and accumulate. Small openings will cause debris such as twigs and leaves to accumulate on the trashrack bars. This buildup will cause progressively larger debris to accumulate against the trashrack bars. Ultimately, this will result in the complete blockage of the spillway inlet.

Pipe and riser spillways can also become blocked by a build up of debris in the spillway. This type of blockage occurs when no trashrack is in place, or if the openings are too large.

In many spillway systems, the size of the outlet conduit is smaller than the size of the inlet. Therefore, it is incorrect to assume that debris which passes through the inlet will not obstruct the flow through the outlet. Large debris, such as logs and tree limbs, can become lodged in the transitions in the spillway. This reduces the capacity of the spillway and could cause damage. An obstructed outlet pipe can be a major problem because removal of large debris from inside the spillway can be very difficult.

A partially blocked spillway reduces the capacity of the spillway and may also create a higher than normal pool level. The combination of these two factors can dramatically reduce the discharge/storage capacity of the dam. A reduction in the discharge/storage capacity of a dam increases the likelihood that the dam will be overtopped during a severe storm event. Overtopping for even a short period of time can cause damage to the embankment and possibly failure of the dam. If the dam has an emergency spillway, a blocked principal spillway will cause more frequent flows in the emergency spillway. Since emergency spillways are usually grass lined channels designed for infrequent flows of short duration, serious damage is likely to result.

Trashrack design

A well-designed trashrack will stop large debris that could plug the conduit but allow unrestricted passage of water and smaller debris.

The larger the outlet conduit, the larger the trashrack opening should be. In the design of a trashrack the openings should be sized so that they measure one-half the nominal dimension of the outlet conduit.

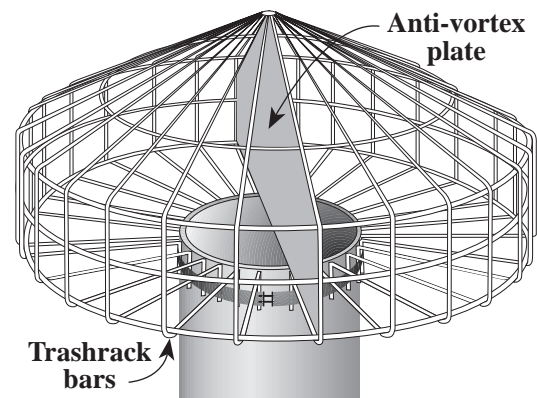

For example, if the outlet pipe is 18 inches in diameter, the trashrack openings should be the effective equivalent of 9 inches by 9 inches; if the outlet conduit is 3 feet by 5 feet, the trashrack openings should be the effective equivalent of 18 inches by 18 inches. This rule applies up to a maximum trashrack opening of two feet by two feet. For an outlet conduit with a nominal dimension of 12 inches or less, the trashrack openings should be at least 6 inches by 6 inches. This prevents large debris from passing through the inlet and blocking the outlet conduit while allowing smaller debris (leave, sticks, etc.) to flush through the spillway system. Another important design criteria is that the trashrack should be securely fastened to the inlet. The connection must be strong enough to withstand the hydrostatic and dynamic forces exerted on the trashrack during periods of high flow.

Fish protection

Many owners are concerned about losing fish through trashracks that have large openings. If this is a concern, a metal plate surrounding the riser or drop inlet which extends above and below the normal pool level should be installed. See Figure on back of sheet. On the bottom of the plate, a metal screen should be attached and connected to the riser pipe. The solid plate at the water level will prevent the fish and floating debris from passing over the crest of the riser. The underwater screen will keep the fish from moving under the metal plate and through the spillway. The underwater screen will not become blocked because most of the debris floats on the water surface. If this design is used, the area between the inside of the cylinder and the outside of the riser must be equal to or greater than the area inside the riser.

Continued on back!

Anti-vortex devices

An anti-vortex device can easily be incorporated into most trashrack designs. A common anti-vortex device is a flat metal plate which is placed on edge and attached to the inlet of the spillway. See Figure below. The capacity of the spillway will be increased by equipping the trashrack with an anti-vortex plate. The anti-vortex plate increases capacity by preventing the formation of a flow inhibiting vortex during periods of high flow.

Basic Anti-vortex Plate Design

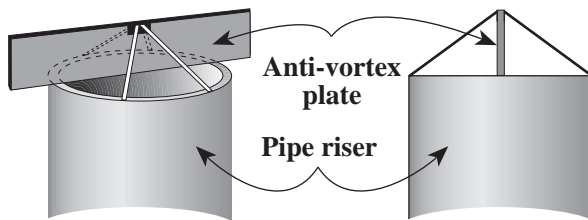

Maintenance

Maintenance should include periodic checks of the trashrack for rusted and broken sections and repairing as needed. Trashracks should be checked frequently during and after storm events to ensure they are functioning properly and to remove accumulated debris. Extreme caution should be used when attempting to remove accumulated debris during periods of high flow.

Conclusion

The benefits of a properly designed and maintained trashrack include the following:

1. Efficient use of the existing spillway system that will maintain the design discharge/storage capacity of the dam and prevent overtopping.
2. Prevention of costly maintenance items such as the removal of debris from the spillway, repair or replacement of damaged spillway components, and the repair of erosion in emergency spillway.
3. A reduction in the amount of fish lost through the spillway system if a fish screen is used.

Any questions, comments, concerns, or fact sheet requests should be directed to the Division of Water at the following address:

Ohio Department of Natural Resources
Division of Water Dam Safety Engineering Program
1939 Fountain Square Drive, Building E-3
Columbus, OH 43224-1336
Voice: (614) 265-6731 Fax: (614) 447-9503
<http://www.dnr.state.oh.us/odnr/water>

Trash Rack Design With Fish Protector Screen

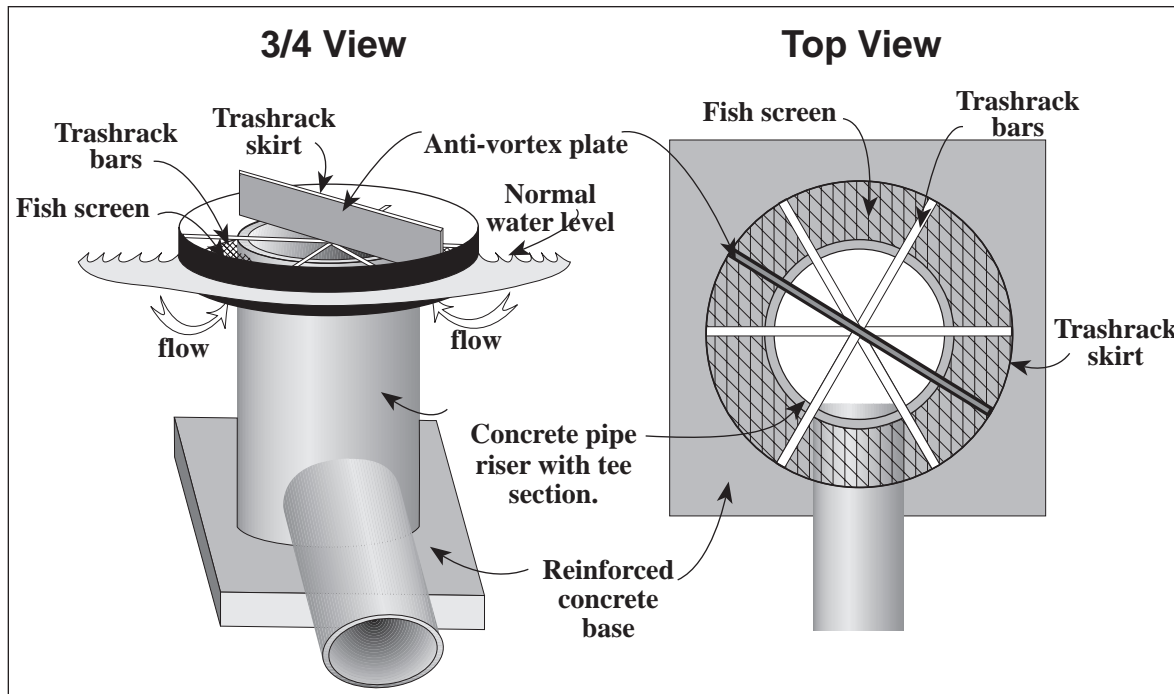

Bob Taft Governor • Samuel W. Speck Director • James R. Morris, P.E. Chief

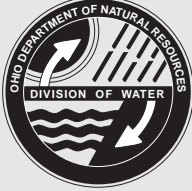

Ohio Department of Natural Resources Division of Water Fact Sheet

Fact Sheet 94-30

Dam Safety: Earth Dam Failures

Owners of dams and operating and maintenance personnel must be knowledgeable of the potential problems which can lead to failure of a dam. These people regularly view the structure and, therefore, need to be able to recognize potential problems so that failure can be avoided. If a problem is noted early enough, an engineer experienced in dam design, construction, and inspection can be contacted to recommend corrective measures, and such measures can be implemented.

IF THERE IS ANY QUESTION AS TO THE SERIOUSNESS OF AN OBSERVATION, AN ENGINEER EXPERIENCED WITH DAMS SHOULD BE CONTACTED.

Acting promptly may avoid possible dam failure and the resulting catastrophic effect on downstream areas. Engineers from the Division of Water, Engineering Group of the Department of Natural Resources are available at any time to inspect a dam if a serious problem is detected or if failure may be imminent. Contact the division at the following address and telephone number:

Ohio Department of Natural Resources
Division of Water, Engineering Group
1939 Fountain Square, Building E-3
Columbus, Ohio 43224

In an emergency, call 614/265-6731 or 614/265-7006.

Since only superficial inspections of a dam can usually be made, it is imperative that owners and maintenance personnel be aware of the prominent types of failure and their telltale signs. Earth dam failures can be grouped into three general categories: overtopping failures, seepage failures, and structural failures. A brief discussion of each type follows.

Overtopping Failures

Overtopping failures result from the erosive action of water on the embankment. Erosion is due to uncon-

trolled flow of water over, around, and adjacent to the dam. Earth embankments are not designed to be overtopped and therefore are particularly susceptible to erosion. Once erosion has begun during overtopping, it is almost impossible to stop. A well vegetated earth embankment may withstand limited overtopping if its top is level and water flows over the top and down the face as an evenly distributed sheet without becoming concentrated. The owner should closely monitor the reservoir pool level during severe storms.

Seepage Failures

All earth dams have seepage resulting from water percolating slowly through the dam and its foundation. Seepage must, however, be controlled in both velocity and quantity. If uncontrolled, it can progressively erode soil from the embankment or its foundation, resulting in rapid failure of the dam. Erosion of the soil begins at the downstream side of the embankment, either in the dam proper or the foundation, progressively works toward the reservoir, and eventually develops a "pipe" or direct conduit to the reservoir. This phenomenon is known as "piping." Piping action can be recognized by an increased seepage flow rate, the discharge of muddy or discolored water, sinkholes on or near the embankment, and a whirlpool in the reservoir. Once a whirlpool (eddy) is observed on the reservoir surface, complete failure of the dam will probably follow in a matter of minutes. As with overtopping, fully developed piping is virtually impossible to control and will likely cause failure.

Seepage can cause slope failure by creating high pressures in the soil pores or by saturating the slope. The pressure of seepage within an embankment is difficult to determine without proper instrumentation. A slope which becomes saturated and develops slides may be showing signs of excessive seepage pressure.

Structural Failures

Structural failures can occur in either the embankment or the appurtenances. Structural failure of a

Continued on back!

spillway, lake drain, or other appurtenance may lead to failure of the embankment. Cracking, settlement, and slides are the more common signs of structural failure of embankments. Large cracks in either an appurtenance or the embankment, major settlement, and major slides will require emergency measures to ensure safety, especially if these problems occur suddenly. If this type of situation occurs, the lake level should be lowered, the appropriate state and local authorities notified, and professional advice sought. If the observer is uncertain as to the seriousness of the problem, the Division of Water should be contacted immediately.

The three types of failure previously described are often interrelated in a complex manner. For example, uncontrolled seepage may weaken the soil and lead to a structural failure. A structural failure may shorten the seepage path and lead to a piping failure. Surface

erosion may result in structural failure.

Minor defects such as cracks in the embankment may be the first visual sign of a major problem which could lead to failure of the structure. The seriousness of all deficiencies should be evaluated by someone experienced in dam design and construction. A qualified professional engineer can recommend appropriate permanent remedial measures.

Any other questions, comments concerns, or fact sheet requests, should be directed to the Division of Water at the following address:

Ohio Department of Natural Resources
Division of Water

Dam Safety Engineering Program
1939 Fountain Square, Building E-3
Columbus, Ohio 43224-1336

(614) 265-6731 (Voice) (614) 447-9503 (Fax)
<http://www.dnr.state.oh.us/odnr/water/>





Ohio Department of Natural Resources Division of Water Fact Sheet

Fact Sheet 99-53

Dam Safety: Embankment Instabilities

The dam embankment and any appurtenant dikes must safely contain the reservoir during normal and flood conditions. Cracks, slides, and depressions are signs of embankment instability and should indicate to the owner that maintenance or repair work may be required. When one of these conditions is detected, the owner must retain an experienced professional engineer to determine the cause of the instability. A rapidly changing condition or the sudden development of a large crack, slide, or depression indicates a very serious problem, and the Dam Safety Engineering Program should be contacted immediately. A professional engineer must investigate these types of embankment stability problems because a so-called “home remedy” may cause greater and more serious damage to the embankment and eventually result in unneeded expenditures for unsuccessful repairs.

Cracks

Short, isolated cracks are commonly due to drying and shrinkage of the embankment surface and are not usually significant. They are usually less than 1 inch wide, propagate in various directions, and occur especially where the embankment lacks a healthy grass cover. Larger (wider than 1 inch), well-defined cracks may indicate a more serious problem. There are generally two types of these cracks: longitudinal and transverse. Longitudinal cracks extend parallel to the crest of the embankment and may indicate the early stages of a slide on either the upstream or downstream slope of the embankment. They can create problems by allowing runoff to enter the cracks and saturate the embankment which in turn can cause instability of the embankment. Transverse cracks extend perpendicular to the crest and can indicate differential settlement within the embankment. Such cracks provide avenues for seepage through the dam and could quickly lead to piping, a severe seepage problem that will likely cause the dam to fail.

If the owner finds small cracks during inspection of the dam, he/she should document the observations, and seal the cracks to prevent runoff from saturating the embankment. The documentation should consist of detailed notes (including the location, length, approximate elevation, and crack width), photographs, sketches, and pos-

sibly monitoring stakes. The crack must then be monitored during future inspections. If the crack becomes longer or wider, a more serious problem such as a slide may be developing. Large cracks indicate serious stability problems. If one is detected, the owner should contact the Dam Safety Engineering Program and/or retain an engineer to investigate the crack and prepare plans and specifications for repairs. When muddy flow discharges from a crack, the dam may be close to failure. The emergency action plan should be initiated immediately and the Dam Safety Engineering Program contacted.

Slides

A slide in an embankment or in natural soil or rock is a mass movement of material. Some typical characteristics of a slide are an arc-shaped crack or scarp along the top and a bulge along the bottom of the slide (see drawing). Slides may develop because of poor soil com-

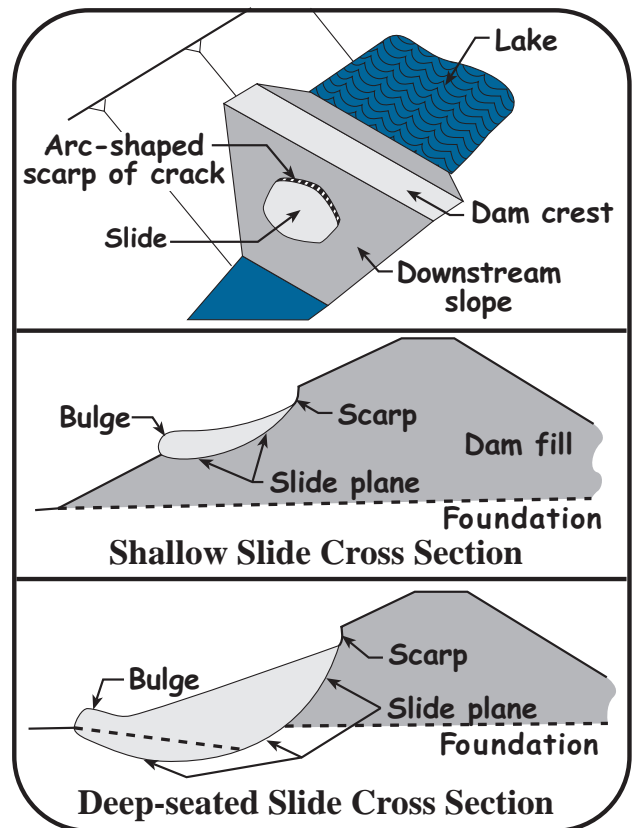

Continued on back!

paction, the gradient of the slope being too steep for the embankment material, seepage, sudden drawdown of the lake level, undercutting of the embankment toe, or saturation and weakening of the embankment or foundation.

Slides can be divided into two main groups: shallow and deep-seated. Shallow slides generally affect the top 2 to 3 feet of the embankment surface. Shallow slides are generally not threatening to the immediate safety of the dam and often result from wave erosion, collapsed rodent burrows, or saturated top soil. Deep-seated slides are serious, immediate threats to the safety of a dam. They can extend several feet below the surface of the embankment, even below the foundation. A massive slide can initiate the catastrophic failure of a dam. Deep-seated slides are the result of serious problems within the embankment.

Small slides can be repaired by removing the vegetation and any unsuitable fill from the area, compacting suitable fill and adding topsoil to make the embankment uniform, and establishing a healthy grass cover. If a shallow or deep-seated slide is discovered, the Dam Safety Engineering Program should be contacted and an engineer retained to investigate the slide. Plans and specifications may need to be prepared for its repair depending on the findings of the investigation.

Depressions

Depressions are sunken areas of the abutment, toe area, or embankment surface. They may be created during construction, or may be caused by decay of buried organic materials, thawing of frozen embankment material, internal erosion of the embankment, or settlement (consolidation) of the embankment or its foundation. To a certain degree, minor depressions are common and do not necessarily indicate a serious problem. (An embankment with several minor depressions may be described as hummocky.) However, larger depressions may indicate serious problems such as weak foundation materials, poor compaction of the embankment during construction, or internal erosion of the embankment fill.

Depressions can create low areas along the crest, cracks through the embankment, structural damage to spillways or other appurtenant structures, damage to internal drainage systems, or general instability of the embankment. They can also inhibit maintenance of the dam and make detection of stability or seepage problems difficult.

The owner should monitor depressions during the regular inspection of the dam. All observations should be documented with detailed notes, photographs, and sketches. Minor depressions can be repaired by removing the vegetation and any unsuitable fill from the area, adding fill and then topsoil to make the embankment uniform, and finally establishing a healthy grass cover. An engineer should be retained to investigate large depressions or settlement areas. Plans and specifications may need to be prepared for its repair depending on the findings of the investigation.

Importance of Inspection

Stability problems can threaten the safety of the dam and the safety of people and property downstream. Therefore, stability problems must be detected and repaired in a timely manner. The entire embankment should be routinely and closely inspected for cracks, slides, and depressions. To do this thoroughly, proper vegetation must be regularly maintained on the embankment. Improper or overgrown vegetation can inhibit visual inspection and maintenance of the dam. Accurate inspection records are also needed to detect stability problems. These records can help determine if a condition is new, slowly changing, or rapidly changing. A rapidly changing condition or the sudden development of a large crack, slide, or depression indicates a very serious problem, and the Dam Safety Engineering Program must be contacted immediately.

Any other questions, comments concerns, or fact sheet requests, should be directed to the Division of Water at the following address:

Ohio Department of Natural Resources
Division of Water
Dam Safety Engineering Program
1939 Fountain Square, Building E-3
Columbus, Ohio 43224-1336
(614) 265-6731 (Voice) (614) 447-9503 (Fax)
<http://www.dnr.state.oh.us/odnr/water/>



Bob Taft Governor • Samuel W. Speck Director • James R. Morris, P.E. Chief

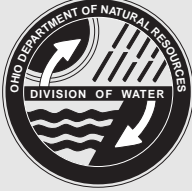

Ohio Department of Natural Resources Division of Water Fact Sheet

Fact Sheet 99-54

Dam Safety: Ground Cover

The establishment and control of proper vegetation are an important part of dam maintenance. Properly maintained vegetation can help prevent erosion of embankment and earth channel surfaces, and aid in the control of groundhogs and muskrats. The uncontrolled growth of vegetation can damage embankments and concrete structures and make close inspection difficult.

Grass vegetation is an effective and inexpensive way to prevent erosion of embankment surfaces. If properly maintained, it also enhances the appearance of the dam and provides a surface that can be easily inspected. Roots and stems tend to trap fine sand and soil particles, forming an erosion-resistant layer once the plants are well established. Grass vegetation may not be effective in areas of concentrated runoff, such as at the contact of the embankment and abutments, or in areas subjected to wave action.

Common Problems

Bare Areas

Bare areas on an embankment are void of protective cover (e.g. grass, asphalt, riprap etc.). They are more susceptible to erosion which can lead to localized stability problems such as small slides and sloughs. Bare areas must be repaired by establishing a proper grass cover or by installing other protective cover. If using grass, the topsoil must be prepared with fertilizer and then scarified before sowing seed. Types of grass vegetation that have been used on dams in Ohio are bluegrass, fescue, ryegrass, alfalfa, clover, and redtop. One suggested seed mixture is 30% Kentucky Bluegrass, 60% Kentucky 31 Fescue, and 10% Perennial Ryegrass. Once the seed is sown, the area should be mulched and watered regularly.

Erosion

Embankment slopes are normally designed and constructed so that the surface drainage will be spread out in a thin layer as "sheet flow" over the grass cover. When the sod is in poor condition or flow is concentrated at one or more locations, the resulting erosion will leave rills and gullies in the embankment slope. The erosion will cause loss of material and make maintenance of the embankment difficult. Prompt repair of the erosion is

required to prevent more serious damage to the embankment. If erosion gullies are extensive, a registered professional engineer may be required to design a more rigid repair such as riprap or concrete. Minor rills and gullies can be repaired by filling them with compacted cohesive material. Topsoil should be a minimum of 4 inches deep. The area should then be seeded and mulched. Not only should the eroded areas be repaired, but the cause of the erosion should be addressed to prevent a continued maintenance problem.

Footpaths

Paths from animal and pedestrian traffic are problems common to many embankments. If a path has become established, vegetation in this area will not provide adequate protection and a more durable cover will be required unless the traffic is eliminated. Gravel, asphalt, and concrete have been used effectively to cover footpaths. Embedding railroad ties or other treated wood beams into an embankment slope to form steps is one of the most successful and inexpensive methods used to provide a protected pathway.

Vehicle Ruts

Vehicle ruts can also be a problem on the embankment. Vehicular traffic on the dam should be discouraged especially during wet conditions except when necessary. Water collected in ruts may cause localized saturation, thereby weakening the embankment. Vehicles can also severely damage the vegetation on embankments. Worn areas could lead to erosion and more serious problems. Ruts that develop in the crest should be repaired by grading to direct all surface drainage into the impoundment. Bare and eroded areas should be repaired using the methods mentioned in the above sections. Constructed barriers such as fences and gates are effective ways to limit access of vehicles.

Improper Vegetation

Crown vetch, a perennial plant with small pink flowers, has been used on some dams in Ohio but is not recommended (see Figure 1). It hides the embankment surface, preventing early detection of cracks and erosion. It is not effective in preventing erosion.

Continued on back!



Figure 1: Crown Vetch
(Source: <http://www.vg.com>)

Vines and woody vegetation such as trees and brush also hide the embankment surface preventing early detection of cracks and erosion. Tall vegetation also provides a habitat for burrowing animals. All improper vegetation must be removed from the entire embankment surface. Any residual roots that are larger than 3 inches in diameter must be removed. All roots should be removed down to a depth of at least 6 inches and replaced with a compacted clay material; then 4 inches of topsoil should be placed on the disturbed areas of the slope. Finally, these areas must be seeded and mulched to establish a proper grass cover.

Maintenance

Embankments, areas adjacent to spillway structures, vegetated channels, and other areas associated with a dam require continual maintenance of the vegetal cover. Removal of improper vegetation is necessary for the proper maintenance of a dam, dike or levee. All embankment slopes and vegetated earth spillways should be mowed at least twice a year. Reasons for proper maintenance of the vegetal cover include unobstructed viewing during inspection, maintenance of a non-erodible surface, discouragement of burrowing animal habitation, and aesthetics.

Common methods for control of vegetation include the use of weed trimmers or power brush-cutters and mowers. Chemical spraying to kill small trees and brush is acceptable if precautions are taken to protect the local environment. Some chemical spraying may require proper training prior to application. Additional information can be found on the Trees and Brush Fact Sheet.

Any other questions, comments concerns, or fact sheet requests, should be directed to the Division of Water at the following address:

Ohio Department of Natural Resources
Division of Water
Dam Safety Engineering Program
1939 Fountain Square, Building E-3
Columbus, Ohio 43224-1336
(614) 265-6731 (Voice) (614) 447-9503 (Fax)
<http://www.dnr.state.oh.us/odnr/water/>



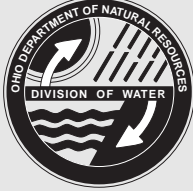

Ohio Department of Natural Resources Division of Water Fact Sheet

Fact Sheet 94-33

Dam Safety: Inspection of Concrete Structures

Dams, dikes, and levees must not be thought of as part of the natural landscape, but as man-made structures which must be designed, inspected, operated, and maintained accordingly. Routine maintenance and inspection of dams and appurtenant facilities should be an ongoing process to ensure that structural failures do not occur which can threaten the overall safety of the dam. The information provided in this fact sheet pertains entirely to the inspection of concrete structures used at dams. The intention is to help dam owners become more aware of common problems that are typically encountered with concrete so that they can more readily address the seriousness of a particular condition whenever it arises.

Structural Inspections

Concrete surfaces should be visually examined for spalling and deterioration due to weathering, unusual or extreme stresses, alkali or other chemical attack, erosion, cavitation, vandalism, and other destructive forces. Structural problems are indicated by cracking, exposure of reinforcing bars, large areas of broken-out concrete, misalignment at joints, undermining and settlement in the structure. Rust stains that are noted on the concrete may indicate that internal corrosion and deterioration of reinforcement steel is occurring. Spillway floor slabs and upstream slope protection slabs should be checked for erosion of underlying base material otherwise known as undermining. Concrete walls and tower structures should be examined to determine if settlement and misalignment of construction joints has occurred.

What to Look For

Concrete structures can exhibit many different types of cracking. Deep, wide cracking is due to stresses which are primarily caused by shrinkage and structural loads. Minor or hairline surface cracking is caused by weathering and the quality of the concrete that was applied. The results of this minor cracking can be the eventual loss of concrete, which exposes reinforcing steel and accelerates deterioration. Generally, minor surface cracking does not affect the structural integrity and performance of the concrete structure.

Cracks through concrete surfaces exposed to flowing water may lead to the erosion or piping of embankment or foundation soils from around and/or under the concrete structure. In this case, the cracks are not the result of a problem but are the detrimental condition which leads to piping and erosion. Seepage at the discharge end of a spillway or outlet structure may indicate leakage of water through a crack. Proper underdrainage for open channel spillways with structural concrete floors is necessary to control this leakage. Flows from underdrain outlets and pressure relief holes should also be observed and measured. Cloudy flows may indicate that piping is occurring beneath or adjacent to the concrete structure. This could be detrimental to the foundation support.

Concrete surfaces adjacent to contraction joints and subject to flowing water are of special concern especially in chute slabs. The adjacent slabs must be flush or the downstream one slightly lower to prevent erosion of the concrete and to prevent water from being directed into the joint during high velocity flow. All weep holes should be checked for the accumulation of silt and granular deposits at their outlets. These deposits may obstruct flow or indicate loss of support material behind the concrete surfaces. Tapping the concrete surface with a hammer or some other device will help locate voids if they are present as well as give an indication of the condition and soundness of the concrete. Weep holes in the concrete are used to allow free drainage and relieve excessive hydrostatic pressures from building up underneath the structure. Excessive hydrostatic pressures underneath the concrete could cause it to heave or crack which increases the potential for accelerated deterioration and undermining. Periodic monitoring of the weep hole drains should be performed and documented on a regular and routine basis to ensure that they are functioning as designed.

Structural cracking of concrete is usually identified by long, single or multiple diagonal cracks with accompanying displacements and misalignment. Cracks extending across concrete slabs which line open channel spillways or provide upstream slope wave protec-

Continued on back!

tion can indicate a loss of foundation support resulting from settlement, piping, undermining, or erosion of foundation soils. Piping and erosion of foundation soils are the result of inadequate underdrainage and/or cutoff walls. Items to consider when evaluating a suspected structural crack are the concrete thickness, the size and location of the reinforcing steel, the type of foundation, and the drainage provision for the structure.

Inspection of intake structures, trashracks, upstream conduits, and stilling basin concrete surfaces that are below the water surface is not readily feasible during a regularly scheduled inspection. Typically, stilling basins require the most regular monitoring and major maintenance because they are holding ponds for rock and debris, which can cause extensive damage to the concrete surfaces during the dissipation of flowing water. Therefore, special inspections of these features should be performed at least once every five years by either dewatering the structure or when operating conditions permit. Investigation of these features using experienced divers is also an alternative.

Preparing for an Inspection

Before an inspection of the dam's concrete facilities is performed, it is recommended that a checklist be developed that includes all the different components of the spillway and/or outlet works. The checklist should also include a space for logging any specific observations about the structure and the state of its condition. Photographs provide invaluable records of changing conditions. A rapidly changing condition may indicate a very serious problem. If there are any questions as to the seriousness of an observation the Dam Safety Engineering Program, or a registered professional engineer experienced with dams, should be contacted.

Any other questions, comments concerns, or fact sheet requests, should be directed to the Division of Water at the following address:

Ohio Department of Natural Resources
Division of Water
Dam Safety Engineering Program
1939 Fountain Square, Building E-3
Columbus, Ohio 43224-1336
(614) 265-6731 (Voice) (614) 447-9503 (Fax)
<http://www.dnr.state.oh.us/odnr/water/>

**In an emergency, call
(614) 265-6731 or (614) 799-9538**





Ohio Department of Natural Resources Division of Water Fact Sheet

Fact Sheet 93-26

Dam Safety: Lake Drains

A lake drain is a device to permit draining a reservoir, lake or pond. Division of Water Administrative Rule 1501:21-13-06 requires that all Class I, Class II and Class III dams include a lake drain.

Types of Drains

Common types of drains include the following:

- ◆ A valve located in the spillway riser.
- ◆ A conduit through the dam with a valve at either the upstream or downstream end of the conduit.
- ◆ A siphon system (Often used to retrofit existing dams).
- ◆ A gate, valve or stoplogs located in a drain control tower.

Uses of Drains

The following situations make up the primary uses of lake drains:

Emergencies: Should serious problems ever occur to threaten the immediate safety of the dam, drains may be used to lower the lake level to reduce the likelihood of dam failure. Examples of such emergencies are as follows: clogging of the spillway pipe which may lead to high lake levels and eventually dam overtopping, development of slides or cracks in the dam, severe seepage through the dam which may lead to a piping failure of the dam, and partial or total collapse of the spillway system.

Maintenance: Some repair items around the lake and dam can only be completed or are much easier to perform with a lower than normal lake level. Some examples are: slope protection repair, spillway repairs, repair and/or installation of docks and other structures along the shoreline, and dredging the lake.

Winter Drawdown: Some dam owners prefer to lower the lake level during the winter months to reduce ice damage to structures along the shoreline and to provide additional flood storage for upcoming spring rains. Several repair items are often performed during this winter drawdown period. Periodic fluctuations in the lake level also discourage muskrat and beaver habitation along the shoreline. Muskrat burrows in earthen dams can lead to costly repairs.

Common Maintenance Problems

Common problems often associated with the maintenance and operation of lake drains include the following:

- ◆ Deteriorated and bent control stems and stem guides.
- ◆ Deteriorated and separated conduit joints.
- ◆ Leaky and rusted control valves and sluice gates.
- ◆ Deteriorated ladders in control towers.
- ◆ Deteriorated control towers.
- ◆ Clogging of the drain conduit inlet with sediment and debris.
- ◆ Inaccessibility of the control mechanism to operate the drain.
- ◆ Seepage along the drain conduit.
- ◆ Erosion and undermining of the conduit discharge area because the conduit outlets significantly above the elevation of the streambed.
- ◆ Vandalism.
- ◆ Development of slides along the upstream slope of the dam and the shoreline caused by lowering the lake level too quickly.

Operation and Maintenance Tips

- A. All gates, valves, stems and other mechanisms should be lubricated according to the manufacturer's specifications. If you do not have a copy of the specifications and the manufacturing company can not be determined, then a local valve distributor may be able to provide assistance.
- B. The lake drain should be operated at least twice a year to prevent the inlet from clogging with sediment and debris, and to keep all movable parts working easily. Most manufacturers recommend that gates and valves be operated at least four times per year. Frequent operation will help to ensure that the drain will be operable when it is needed. All valves and gates should be fully opened and closed at least twice to help flush out debris and to obtain a proper seal. If the gate gets stuck in a partially opened position, gradually work the

Continued on back!

gate in each direction until it becomes fully operational. Do not apply excessive torque as this could bend or break the control stem, or damage the valve or gate seat. With the drain fully open, inspect the outlet area for flow amounts, leaks, erosion and anything unusual.

- C. All visible portions of the lake drain system should be inspected at least annually, preferably during the periodic operation of the drain. Look for and make note of any cracks, rusted and deteriorated parts, leaks, bent control stems, separated conduit joints or unusual observations.
- D. A properly designed lake drain should include a headwall near the outlet of the drain conduit to prevent undermining of the conduit during periods of flow. A headwall can be easily retro-fitted to an existing conduit if undermining is a problem at an existing dam. A properly designed layer of rock riprap or other slope protection will help reduce erosion in the lake drain outlet area.
- E. Drain control valves and gates should always be placed upstream of the centerline of the dam. This allows the drain conduit to remain depressurized except during use, therefore reducing the likelihood of seepage through the conduit joints and saturation of the surrounding earth fill.
- F. For accessibility ease, the drain control platform should be located on shore or be provided with a bridge or other structure. This becomes very important during emergency situations if high pool levels exist.
- G. Vandalism can be a problem at any dam. If a lake drain is operated by a crank, wheel or other similar mechanism, locking with a chain or other device, or off-site storage may be beneficial. Fences or other such installations may also help to ward off vandals.
- H. The recommended rate of lake drawdown is one foot or less per week, except in emergencies. Fast drawdown causes a build-up of hydrostatic pressures in the upstream slope of the dam which can lead to slope failure. Lowering the water level slowly allows these pressures to dissipate.

Monitoring

Monitoring of the lake drain system is necessary to detect problems and should be performed at least twice a year or more frequently if problems develop. Proper ventilation and confined space precautions must be considered when entering a lake drain vault or outlet pipe. Items to be considered when monitoring a lake drain system include the stem, valve, outlet pipe and related appurtenances. Monitoring for surface deterioration (rust), ease of operation, and leakage is important to maintain a working lake drain system. If the stem or valve appears to be inoperable because of deterioration or if the operability of the lake drain system is in question, because the valve does not completely close (seal) and allows an excessive amount of leakage, then a registered professional engineer or manufacturer's representative should be contacted. Photographs along with written records of the monitoring items performed provide invaluable information. For further information on evaluating the condition of the lake drain system see the "Spillway Conduit System Problems", "Problems with Metal Materials", "Problems with Plastic (Polymer) Materials", and "Problems with Concrete Materials" fact sheets.

Conclusion

An operable lake drain accomplishes the following:

1. Makes for a safer dam by providing a method to lower the lake level in an emergency situation.
2. Allows the dam owner to have greater control of the lake level for maintenance, winter drawdown and emergency situations.
3. Meets the requirements of the Ohio Dam Safety Laws.

Any other questions, comments concerns, or fact sheet requests, should be directed to the Division of Water at the following address:

Ohio Department of Natural Resources
Division of Water
Dam Safety Engineering Program
1939 Fountain Square, Building E-3
Columbus, Ohio 43224-1336
(614) 265-6731 (Voice) (614) 447-9503 (Fax)
<http://www.dnr.state.oh.us/odnr/water/>



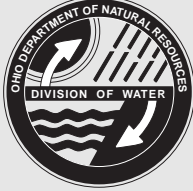

Ohio Department of Natural Resources Division of Water Fact Sheet

Fact Sheet 98-49

Dam Safety: Open Channel Spillways (Earth and Rock)

Open channels are often used as the emergency spillway and sometimes as the principal spillway for dams. A principal spillway is used to pass normal inflows, and an emergency spillway is designed to operate only during large flood events, usually after the capacity of the principal spillway has been exceeded. For dams with pipe conduit principal spillways, an open channel emergency spillway is almost always required as a backup in case the pipe becomes clogged. Open channels are usually located in natural ground adjacent to the dam and can be vegetated, rock-lined, or cut in rock.

Design

Flow through an emergency spillway does not necessarily indicate a problem with the dam, but high velocity flows can cause severe erosion and result in a permanently lowered lake level if not repaired. Proper design of an open channel spillway will include provisions for minimizing any potential erosion. One way to minimize erosion is to design a flatter channel slope to reduce the velocity of the flow. Earthen channels can be protected by a good grass cover, an appropriately designed rock cover, concrete or various types of erosion control matting. Rock-lined channels must have adequately sized riprap to resist displacement and contain an appropriate geotextile fabric or granular filter beneath the rock. Guide berms are often required to divert flow through open channels away from the dam to prevent erosion of the embankment fill. If an open channel is used for a principal spillway, it must be rock-lined or cut in rock due to more frequent or constant flows.

Ohio Administrative Code Rule 1501:21-13-04 requires that the frequency of use for an earth (grass-lined) or a rock-lined emergency spillway be less than:

- Once in 50 years for Class I dams;
- Once in 25 years for Class II dams; and
- Once in 10 years for Class III dams.

Maintenance

Maintenance should include, but not be limited to, the following items:

• **Grass-covered channels should be mowed at least twice per year to maintain a good grass cover and to prevent trees, brush and weeds from becoming established.** Poor vegetal cover can result in extensive and rapid erosion when the spillway flows. Repairs can be costly. Reseeding and fertilization may be necessary to maintain a vigorous growth of grass. One suggested seed mixture is 30% Kentucky Bluegrass, 60% Kentucky 31 Fescue, and 10% Perennial Ryegrass.

• **Trees and brush must be removed from the channel.** Tree and brush growth reduces the discharge capacity of the spillway channel. This increases the lake level during large storm events which can lead to overtopping and failure of the dam.

• **Erosion in the channel must be repaired quickly after it occurs.** Erosion can be expected in the spillway channel during high flows, and can also occur as a result of rainfall and runoff, especially in areas of poor grass cover. Terraces or drainage channels may be necessary in large spillway channels where large amounts of rainfall and runoff may concentrate and have high velocities. Erosion of the side slopes may deposit material in the spillway channel, especially where the side slopes meet the channel bottom. In small spillways, this can significantly reduce the discharge capacity. This condition often occurs immediately after construction before vegetation becomes established. In these cases, it may be necessary to reshape the channel to provide the necessary capacity.

• **All obstructions should be kept out of the channel.** Open channel spillways often are used for purposes other than passage of flood flows.

Continued on back!

Among these uses are reservoir access, parking lots, boat ramps, boat storage, pasture and cropland. Permanent structures (buildings, fences, etc.) should not be constructed in these spillways. If fences, bridges or other such structures are absolutely necessary, they should cross the spillway far enough upstream or downstream from the control section so that they do not interfere with the flow. Construction of any structures in or across the channel requires prior approval from the Division of Water.

• **Weathering of rock channels can be a serious problem and is primarily due to freeze/thaw action.** Deterioration due to the effects of sun, wind, rain, chemical action and tree root growth also occurs. Weathered rock is susceptible to erosion and displacement during high flows; therefore, rock channels are often designed with 1 to 3 feet of earth with a grass cover over the rock surface to help insulate the rock from the effects of freeze/thaw action.

Monitoring

Open channel spillways should be monitored for erosion, poor vegetal cover, growth of trees and brush, obstructions, and weathering and displacement of rock. Monitoring should take place on a regular basis and after large flood events. It is important to keep written records of observations. Photographs provide invaluable records of changing conditions. All records should be kept in the operation, maintenance, and inspection manual for the dam.

Any other questions, comments concerns, or fact sheet requests, should be directed to the Division of Water at the following address:

Ohio Department of Natural Resources
Division of Water
Dam Safety Engineering Program
1939 Fountain Square, Building E-3
Columbus, Ohio 43224-1336
(614) 265-6731 (Voice) (614) 447-9503 (Fax)
<http://www.dnr.state.oh.us/odnr/water/>

Downstream View of Open Channel Spillway

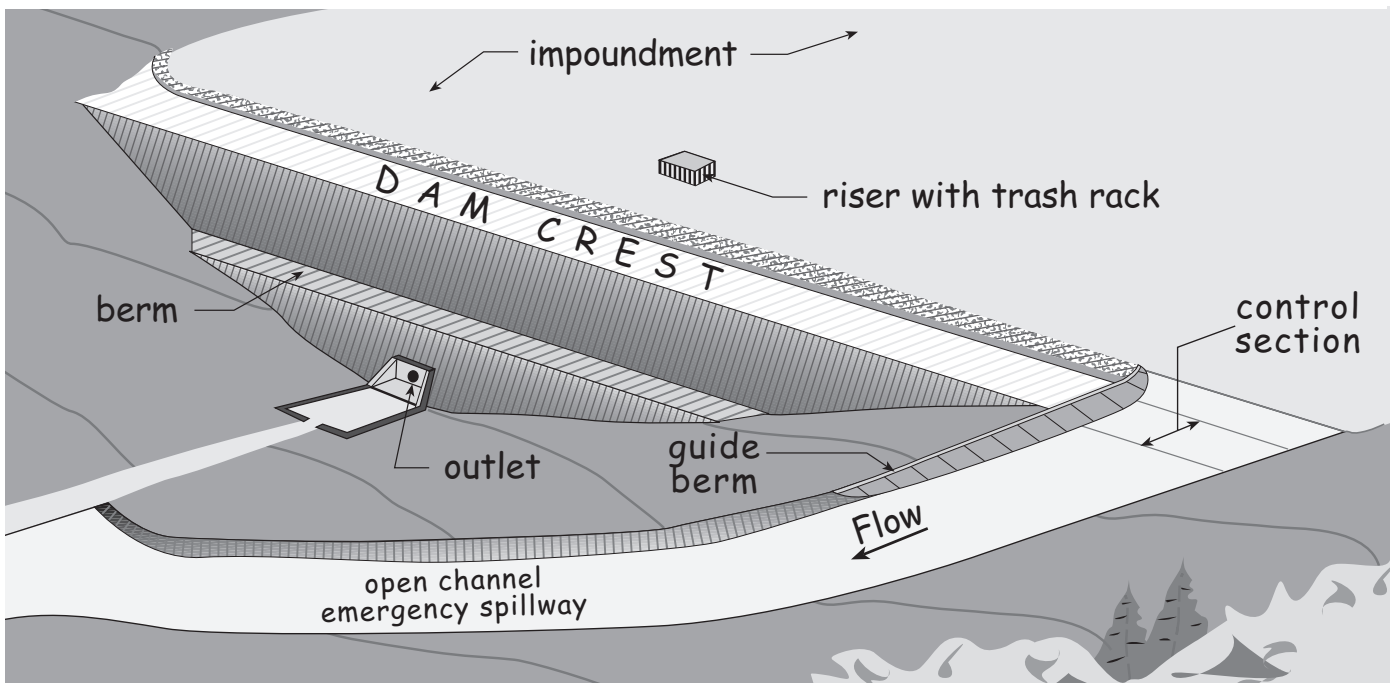

Bob Taft *Governor* • Samuel W. Speck *Director* • James R. Morris, P.E. *Chief*



Ohio Department of Natural Resources Division of Water Fact Sheet

Fact Sheet 99-51

Dam Safety: Outlet Erosion Control Structures (Stilling Basins)

Water moving through the spillway of a dam contains a large amount of energy. This energy can cause erosion at the outlet which can lead to instability of the spillway. Failure to properly design, install, or maintain a stilling basin could lead to problems such as undermining of the spillway and erosion of the outlet channel and/or embankment material. These problems can lead to failure of the spillway and ultimately the dam. A stilling basin provides a means to absorb or dissipate the energy from the spillway discharge and protects the spillway area from erosion and undermining. An outlet erosion control structure such as a headwall/endwall, impact basin, United States Department of the Interior, Bureau of Reclamation Type II or Type III basin, baffled chute, or plunge pool is considered an energy dissipating device. The performance of these structures can be affected by the tailwater elevation. The tailwater elevation is the elevation of the water that is flowing through the natural stream channel downstream during various flow conditions.

A headwall/endwall, impact basin, Type II or Type III basin, and baffled chute are all constructed of concrete. Concrete structures can develop surface defects such as minor cracking, bugholes, honeycombing, and spalling. Concrete structures can have severe structural defects such as exposed rebar, settlement, misalignment and large cracks. Severe defects can indicate structural instability.

Headwall/Endwall

A headwall/endwall located at or close to the end of the discharge conduit will provide support and reduce the potential for undermining. A headwall/endwall is typically constructed of concrete, and it should be founded on bedrock or have an adequate foundation footing to provide support for stability. A headwall/endwall can become displaced if it is not adequately designed and is subject to undermining. Displacement of the headwall/endwall can lead to separation of the spillway conduit at the joints which

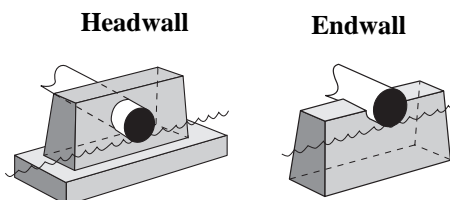

could affect the integrity of the spillway conduit. If a concrete structure develops the structural defects men-

tioned in the opening paragraphs, or if the discharge spillway conduit does not have a headwall/endwall, then a registered professional engineer should be contacted to evaluate the stability of the outlet.

Impact Basin

A concrete impact basin is an energy dissipating device located at the outlet of the spillway in which flow from the discharge conduit strikes a vertical hanging baffle. Discharge is directed upstream in vertical eddies by the horizontal por-

tion of the baffle and by the floor before flowing over the endsill. Energy dissipation occurs as the discharge strikes the baffle, thus, performance is not dependent on tailwater. Most impact basins were de-

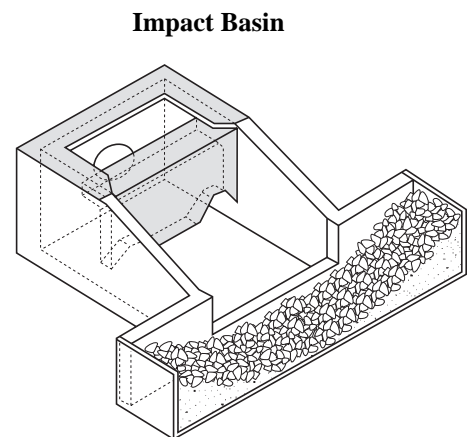

signed by the United States Department of Agriculture, Natural Resources Conservation Service and the United States Department of Interior, Bureau of Reclamation. If any of the severe defects that are referenced in the opening paragraphs are observed, a registered professional engineer should be contacted to evaluate the stability of the outlet.

U.S. Department of Interior, Bureau of Reclamation Type II and Type III Basins

Type II and Type III basins reduce the energy of the flow discharging from the outlet of a spillway and allow the water to exit into the outlet channel at a reduced velocity. Type II energy dissipators contain chute blocks at the upstream end of the basin and a dentated (tooth-like) endsill. Baffle piers are not used in a Type II basin because of the high velocity water entering the basin.

Continued on back!

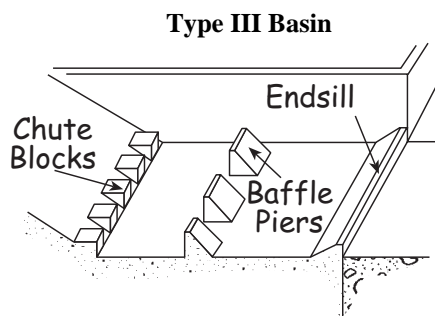

Type III energy dissipators can be used if the entrance velocity of the water is not high. They contain baffle piers which are located on the stilling basin apron downstream of the

chute blocks. Located at the end of both the Type II and Type III basins is an endsill. The endsill may be level or sloped, and its purpose is to create the tailwater which reduces the outflow velocity. If any of the severe defects associated with concrete structures are observed, a registered professional engineer should be contacted to evaluate the stability of the basin.

Baffled Chute

Baffled chutes require no initial tailwater to be effective and are located downstream of the control section. Multiple rows of baffle piers on the chute prevent excessive acceleration of the flow and prevent the damage that occurs from a high discharge velocity. A portion of the baffled chute usually extends below the streambed elevation to prevent undermining of the chute. If any of the severe problems associated with concrete that are referenced in the opening paragraphs are observed, a registered professional engineer should be contacted to evaluate the stability of the outlet.

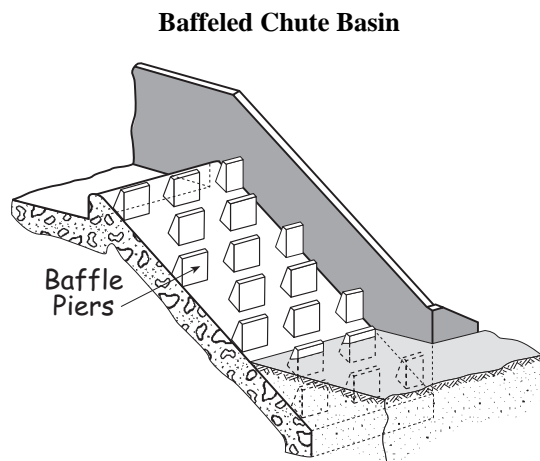

Plunge Pool

A plunge pool is an energy dissipating device located at the outlet of a spillway. Energy is dissipated as the discharge flows into the plunge pool. Plunge pools are commonly lined with rock riprap or other material to prevent excessive erosion of the pool area. Discharge from the plunge pool should be at the natural streambed elevation. Typical problems may include movement of the riprap, loss of fines from the bedding material and

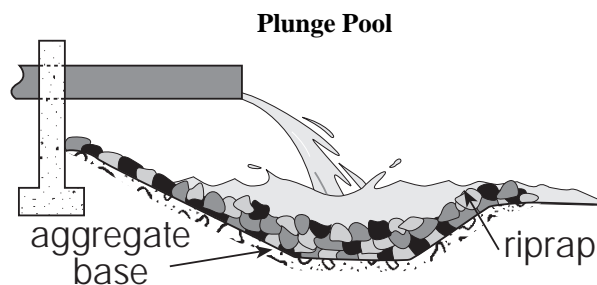

scour beyond the riprap and lining. If scour beneath the outlet conduit develops, the conduit will be left unsupported and separation of the conduit joints and undermining may occur. Separation of the conduit joints and undermining may lead to failure of the spillway and ultimately the dam. A registered professional engineer should be contacted to ensure that the plunge pool is designed properly.

Additional information about related topics can be found on the following fact sheets: "Inspection of Concrete Structures," "Spillway Conduit System Problems," "Open Channel Spillways (Concrete Chutes and Weirs)," and "Problems with Concrete Materials."

Any questions, comments, concerns, or fact sheet requests should be directed to the Division of Water at the following address:

Ohio Department of Natural Resources
 Division of Water Dam Safety Engineering Program
 1939 Fountain Square Drive, Building E-3
 Columbus, OH 43224-1336
 (614) 265-6731 (Voice)
 (614) 447-9503 (Fax)
<http://www.dnr.state.oh.us/odnr/water/>



Bob Taft Governor • Samuel W. Speck Director • James R. Morris, P.E. Chief



Ohio Department of Natural Resources Division of Water Fact Sheet

Fact Sheet 99-56

Dam Safety: Problems with Concrete Materials

Visual inspection of concrete will allow for the detection of distressed or deteriorated areas. Problems with concrete include construction errors, disintegration, scaling, cracking, efflorescence, erosion, spalling, and popouts.

Construction Errors

Errors made during construction such as adding improper amounts of water to the concrete mix, inadequate consolidation, and improper curing can cause distress and deterioration of the concrete. Proper mix design, placement, and curing of the concrete, as well as an experienced contractor are essential to prevent construction errors from occurring. Construction errors can lead to some of the problems discussed later in this fact sheet such as scaling and cracking. Honeycombing and bugholes can be observed after construction.

Honeycombing can be recognized by exposed coarse aggregate on the surface without any mortar covering or surrounding the aggregate particles. The honeycombing may extend deep into the concrete. Honeycombing can be caused by a poorly graded concrete mix, by too large of a coarse aggregate, or by insufficient vibration at the time of placement. Honeycombing will result in further deterioration of the concrete due to freeze-thaw because moisture can easily work its way into the honeycombed areas. Severe honeycombing should be repaired to prevent further deterioration of the concrete surface.

Bugholes is a term used to describe small holes (less than about 0.25 inch in diameter) that are noticeable on the surface of the concrete. Bugholes are generally caused by too much sand in the mix, a mix that is too lean, or excessive amplitude of vibration during placement. Bugholes may cause durability problems with the concrete and should be monitored.

Disintegration and Scaling

Disintegration can be described as the deterioration of the concrete into small fragments and individual aggregates. Scaling is a milder form of disintegration where the surface mortar flakes off. Large areas of crumbling (rotten) concrete, areas of deterioration which are more than about 3 to 4 inches deep (depending on the wall/slab

thickness), and exposed rebar indicate serious concrete deterioration. If not repaired, this type of concrete deterioration may lead to structural instability of the concrete structure. A registered professional engineer must prepare plans and specifications for repair of serious concrete deterioration. For additional information, see the "Concrete Repair Techniques" fact sheet.

Disintegration can be a result of many causes such as freezing and thawing, chemical attack, and poor construction practices. All exposed concrete is subject to freeze-thaw, but the concrete's resistance to weathering is determined by the concrete mix and the age of the concrete. Concrete with the proper amounts of air, water, and cement, and a properly sized aggregate, will be much more durable. In addition, proper drainage is essential in preventing freeze-thaw damage. When critically saturated concrete (when 90% of the pore space in the concrete is filled with water) is exposed to freezing temperatures, the water in the pore spaces within the concrete freezes and expands, damaging the concrete. Repeated cycles of freezing and thawing will result in surface scaling and can lead to disintegration of the concrete. Hydraulic structures are especially susceptible to freeze-thaw damage since they are more likely to be critically saturated. Older structures are also more susceptible to freeze-thaw damage since the concrete was not air entrained. In addition, acidic substances in the surrounding soil and water can cause disintegration of the concrete surface due to a reaction between the acid and the hydrated cement.

Cracks

Cracks in the concrete may be structural or surface cracks. Surface cracks are generally less than a few millimeters wide and deep. These are often called hair-line cracks and may consist of single, thin cracks, or cracks in a craze/map-like pattern. A small number of surface or shrinkage cracks is common and does not usually cause any problems. Surface cracks can be caused by freezing and thawing, poor construction practices, and alkali-aggregate reactivity. Alkali-aggregate reactivity occurs when the aggregate reacts with the cement causing crazing or map cracks. The placement of

Continued on back!

new concrete over old may cause surface cracks to develop. This occurs because the new concrete will shrink as it cures. Surface cracks in the spillway should be monitored and will need to be repaired if they deteriorate further.

Structural cracks in the concrete are usually larger than 0.25 inch in width. They extend deeper into the concrete and may extend all the way through a wall, slab, or other structural member. Structural cracks are often caused by settlement of the fill material supporting the concrete structure, or by loss of the fill support due to erosion. The structural cracks may worsen in severity due to the forces of weathering. A registered professional engineer knowledgeable about dam safety must investigate the cause of structural cracks and prepare plans and specifications for repair of any structural cracks. For additional information, see the "Concrete Repair Techniques" fact sheet.

Efflorescence

A white, crystallized substance, known as efflorescence, may sometimes be noted on concrete surfaces, especially spillway sidewalls. It is usually noted near hairline or thin cracks. Efflorescence is formed by water seeping through the pores or thin cracks in the concrete. When the water evaporates, it leaves behind some minerals that have been leached from the soil, fill, or concrete. Efflorescence is typically not a structural problem. Efflorescence should be monitored because it can indicate the amount of seepage finding its way through thin cracks in the concrete and can signal areas where problems (i.e. inadequate drainage behind the wall or deterioration of concrete) could develop. Also, water seeping through thin cracks in the wall will make the concrete more susceptible to deterioration due to freezing and thawing of the water.

Erosion

Erosion due to abrasion results in a worn concrete surface. It is caused by the rubbing and grinding of aggregate or other debris on the concrete surface of a spillway channel or stilling basin. Minor erosion is not a problem but severe erosion can jeopardize the structural integrity of the concrete. A registered professional engineer must prepare plans and specifications for repair of this type of erosion if it is severe.

Erosion due to cavitation results in a rough, pitted concrete surface. Cavitation is a process in which subat-

mospheric pressures, turbulent flow and impact energy are created and will damage the concrete. If the shape of the upper curve on the ogee spillway is not designed close to its ideal shape, cavitation may occur just below the upper curve, causing erosion. A registered professional engineer must prepare plans and specifications for repair of this type of erosion if the concrete becomes severely pitted which could lead to structural damage or failure of the structure.

Spalling and Popouts

Spalling is the loss of larger pieces or flakes of concrete. It is typically caused by sudden impact of something dropped on the concrete or stress in the concrete that exceeded the design. Spalling may occur on a smaller scale, creating popouts. Popouts are formed as the water in saturated coarse aggregate particles near the surface freezes, expands, and pushes off the top of the aggregate and surrounding mortar to create a shallow conical depression. Popouts are typically not a structural problem. However, if a spall is large and causes structural damage, a registered professional engineer must prepare plans and specifications to repair the spalling.

Inspection and Monitoring

Regular inspection and monitoring is essential to detect problems with concrete materials. Concrete structures should be inspected a minimum of once per year. The inspector should also look at the interior condition of concrete spillway conduit. Proper ventilation and confined space precautions must be considered when entering a conduit. It is important to keep written records of the dimensions and extent of scaling, disintegration, efflorescence, honeycombing, erosion, spalling, popouts, and the length and width of cracks. Structural cracks should be monitored more frequently and repaired if they are a threat to the stability of the structure or dam. Photographs provide invaluable records of changing conditions. A rapidly changing condition may indicate a very serious problem, and the Dam Safety Engineering Program should be contacted immediately. All records should be kept in the operation, maintenance, and inspection manual for the dam.

Any other questions, comments concerns, or fact sheet requests, should be directed to the Division of Water at the following address:

Ohio Department of Natural Resources
Division of Water
Dam Safety Engineering Program
1939 Fountain Square, Building E-3
Columbus, Ohio 43224-1336
(614) 265-6731 (Voice) (614) 447-9503 (Fax)
<http://www.dnr.state.oh.us/odnr/water/>



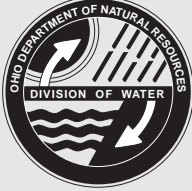

Ohio Department of Natural Resources Division of Water Fact Sheet

Fact Sheet 99-57

Dam Safety: Problems with Metal Materials

Corrosion is a common problem for spillway conduits and other metal appurtenances. Corrosion is the deterioration or breakdown of metal because of a reaction with its environment. Exposure to moisture, acidic conditions, or salt will accelerate the corrosion process. Acid runoff from strip-mined areas will cause rapid corrosion of metal conduits. In these areas, conduits made of less corrodible materials such as concrete or plastic should be used. Soil types also factor into the amount of corrosion. Clayey soils can be more corrosive than sandy soils since they are poorly drained and poorly aerated. Silts are somewhere in between clays and sands. Some examples of metal conduits include ductile iron, smooth steel, and corrugated metal. Corrugated metal pipe is not recommended for use in dams since the service life for corrugated metal is only 25 to 30 years, whereas the life expectancy for dams is much longer. In areas of acidic water, the service life can be much less. Therefore, corrugated metal spillway conduits typically need to be repaired or replaced early in the dam's design life, which can be very expensive.

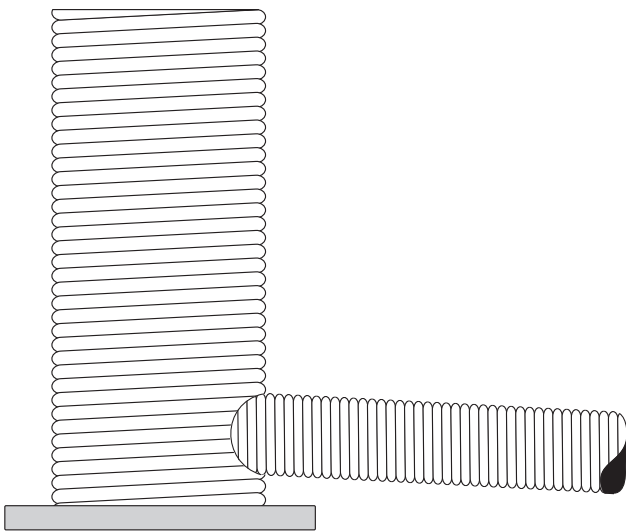

Figure 1 – Example of a corrugated metal pipe and riser spillway.

Conduit coating is an effective way of controlling corrosion of metal conduits if used properly. It is relatively inexpensive and extends the life of the conduit. Some examples of coatings include cement-mortar, epoxy, aluminum, or polyethylene film. Asphalt (bituminous) coatings are not recommended since their service life is usually only one or two years. Coatings must be applied to the conduit prior to installation and protected to ensure that the coating is not scratched off. Coatings applied to conduits in service are generally not very effective because of the difficulty in establishing an adequate bond.

Corrosion can also be controlled or arrested by installing cathodic protection. A metallic anode such as magnesium (or zinc) is buried in the soil and is connected to the metal conduit by wire. Natural voltage current flowing from the magnesium (anode) to the conduit (cathode) will cause the magnesium to corrode and not the conduit. However, sufficient maintenance funds should be allocated for the regular inspection of this active system.

If corrosion is allowed to continue, metal conduits will rust out. The spillway must be repaired before water flows through the rusted out portion of the conduit and erodes the fill material of the embankment. Continued erosion can lead to failure of the dam. Sliplining can be an economical and effective method of permanently restoring deteriorated spillways. During sliplining, a smaller diameter pipe is inserted into the old spillway conduit and then grout is used to fill in the void between the two pipes. If sliplining the spillway is not feasible, the lake may need to be drained and a new spillway must be installed. A registered professional engineer must be retained to develop and submit plans and specifications for any major modifications such as spillway sliplining or replacement.

Corrosion of the metal parts of the operating mechanisms such as lake drain valves and sluice gates can be effectively treated by keeping these parts lubricated and /or painted. If the device has not been operated in several years, a qualified person (i.e. manufacturer's representative or registered professional engineer) should inspect it to determine its

Continued on back!

operability. Caution must be used to prevent the mechanism from breaking. A registered professional engineer may be needed to prepare plans and specifications for repair if the device is determined to be inoperable.

Regular inspection and monitoring is essential to detect any problems with metal materials. Coatings on metal pipes should be inspected for scratched and worn areas. The inspector should also look for corrosion inside the spillway conduit. Proper ventilation and confined space precautions must be considered when entering the spillway conduit system. If using cathodic protection, regular inspections are required to verify that the system is working properly. It is important to keep written records of the amount of surface rust, pitting, and corrosion on any metal surface. Areas of thin metal should be monitored more frequently and repaired or replaced if they rust out. Photographs provide invaluable records of changing conditions. A rapidly changing condition may indicate a very serious problem, and the Dam Safety Engineering Program should be contacted immediately. All records should be kept in the operation, maintenance, and inspection manual for the dam.

Any other questions, comments concerns, or fact sheet requests, should be directed to the Division of Water at the following address:

Ohio Department of Natural Resources
Division of Water
Dam Safety Engineering Program
1939 Fountain Square, Building E-3
Columbus, Ohio 43224-1336
(614) 265-6731 (Voice) (614) 447-9503 (Fax)
<http://www.dnr.state.oh.us/odnr/water/>



Bob Taft *Governor* • Samuel W. Speck *Director* • James R. Morris, P.E. *Chief*



Ohio Department of Natural Resources Division of Water Fact Sheet

Fact Sheet 99-58

Dam Safety: Problems with Plastic (Polymer) Materials

Plastics are often used as spillway and lake drain pipes in dam construction and repair. The most common plastic pipes are high-density polyethylene (HDPE) and polyvinyl chloride (PVC). The advantages of using plastic pipe include excellent abrasion resistance, chemical corrosion resistance, low maintenance, and long life expectancy. Naturally occurring chemicals in soils will not degrade plastic pipe and cause it to rot or corrode. Plastic pipes are also much easier to handle and install compared to heavier concrete and steel pipes.

Plastic pipes are considered flexible, and they get their strength from the material and the surrounding backfill whereas rigid pipes, such as concrete, get their strength from the material and the pipe structure. Backfill around plastic pipes must be properly compacted and in full contact with the pipe. It is important to take special care in the haunch area to prevent the pipe from lifting off the subgrade and disrupting vertical alignment. Symmetric backfilling is also required to prevent the pipe from being out of lateral alignment.

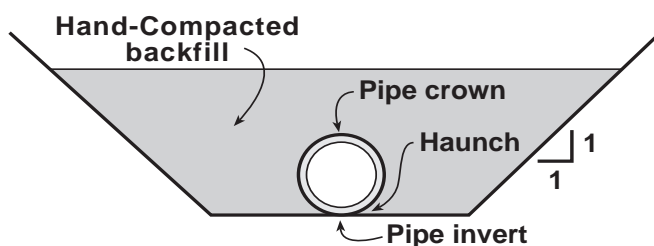

Figure 1 - Cross-section of plastic pipe in trench

When designing a new spillway system, a registered professional engineer will be required to specify the correct type of pressurized plastic pipe that can be used.



Bob Taft Governor • Samuel W. Speck Director • James R. Morris, P.E. Chief

The pipe must be able to withstand the pressures from the weight of the embankment without crushing or buckling. The joints must also be watertight. Not all plastic pipe will meet these requirements.

As with other plastic materials, ultraviolet light degradation can be a problem. Photo-degradation can cause plastic to become brittle and crack. Carbon black is the most effective additive to enhance the photo-degradation resistance of plastic materials. Pipes containing carbon black can be safely stored outside in most climates for many years without damage from ultraviolet exposure. Plastic pipes can be affected by liquid hydrocarbons such as gasoline and oil. If hydrocarbons come in contact with plastic pipe, they will permeate the pipe wall causing swelling and loss of strength. However, if the hydrocarbons are removed, the effects are reversible.

Regular inspection and monitoring is essential to detect any problems with plastic materials. Plastic pipes should be inspected for deformation and cracking. The inspector should also look at the interior condition of the spillway pipe. Proper ventilation and confined space precautions must be considered when entering the spillway pipe system. It is important to keep written records of pipe dimensions to note deformation and the length and width of cracks. Photographs provide invaluable records of changing conditions. A rapidly changing condition may indicate a very serious problem, and the Dam Safety Engineering Program should be contacted immediately. All records should be kept in the operation, maintenance, and inspection manual for the dam.

Any other questions, comments concerns, or fact sheet requests, should be directed to the Division of Water at the following address:

Ohio Department of Natural Resources
Division of Water
Dam Safety Engineering Program
1939 Fountain Square, Building E-3
Columbus, Ohio 43224-1336
(614) 265-6731 (Voice) (614) 447-9503 (Fax)
<http://www.dnr.state.oh.us/odnr/water/>



Ohio Department of Natural Resources Division of Water Fact Sheet

Fact Sheet 94-27

Dam Safety: Rodent Control

Rodents such as the groundhog (woodchuck), muskrat, and beaver are attracted to dams and reservoirs, and can be quite dangerous to the structural integrity and proper performance of the embankment and spillway. Groundhog and muskrat burrows weaken the embankment and can serve as pathways for seepage. Beavers may plug the spillway and raise the pool level. Rodent control is essential in preserving a well-maintained dam.

Groundhog

The groundhog is the largest member of the squirrel family. Its coarse fur is a grizzled grayish brown with a reddish cast. Typical foods include grasses, clover, alfalfa, soybeans, peas, lettuce, and apples. Breeding takes place during early spring (beginning at the age of one year) with an average of four or five young per litter, one litter per year. The average life expectancy is two or three years with a maximum of six years.

Occupied groundhog burrows are easily recognized in the spring due to the groundhog's habit of keeping them "cleaned out." Fresh dirt is generally found at the mouth of active burrows. Half-round mounds, paths leading from the den to nearby fields, and clawed or girdled trees and shrubs also help identify inhabited burrows and dens.

When burrowing into an embankment, groundhogs stay above the phreatic surface (upper surface of seepage or saturation) to stay dry. The burrow is rarely a single tunnel. It is usually forked, with more than one entrance and with several side passages or rooms from 1 to 12 feet long.

Groundhog Control

Control methods should be implemented during early spring when active burrows are easy to find, young groundhogs have not scattered, and there is less likelihood of damage to other wildlife. In later summer, fall, and winter, game animals will scurry into groundhog burrows for brief protection and may even take up permanent abode during the period of groundhog hibernation.

Groundhogs can be controlled by using fumigants or by shooting. Fumigation is the most practical method of controlling groundhogs. Around buildings or other high fire hazard areas, shooting may be preferable. Groundhogs will be discouraged from inhabiting the embankment if the vegetal cover is kept mowed.

Gas cartridges may be purchased at garden supply and hardware stores. Information about the use and availability of gas cartridges may be obtained from county extension offices, or the U.S. Department of Agriculture at the following address:

The USDA
Animal and Plant Health Inspection Service
Wildlife Services
200 North High Street, Room 622
Columbus, Ohio 43215
(614) 469-5681

Muskrat

The muskrat is a stocky rodent with a broad head, short legs, small eyes, and rich dark brown fur. Muskrats are chiefly nocturnal. Their principal food includes stems, roots, bulbs, and foliage of aquatic plants. They also feed on snails, mussels, crustaceans, insects, and fish. Usually three to five litters, averaging six to eight young per litter, are produced each year. Adult muskrats average one foot in length and three pounds in weight. The life expectancy is less than two years, with a maximum of four years. Muskrats can be found wherever there are marshes, swamps, ponds, lakes and streams having calm or very slowly moving water with vegetation in the water and along the banks.

Muskrats make their homes by burrowing into the banks of lakes and streams or by building "houses" of bushes and other plants. Their burrows begin from 6 to 18 inches below the water surface and penetrate the embankment on an upward slant. At distances up to 15 feet from the entrance, a dry chamber is hollowed out above the water level. Once a muskrat den is occupied, a rise in the water level will cause the muskrat to dig farther and higher to excavate a new dry chamber. Damage (and the potential for problems) is compounded where groundhogs or other burrowing animals construct their dens in the embankment opposite muskrat dens.

Continued on back!

Muskrat Control

Barriers to prevent burrowing offer the most practical protection to earthen structures. A properly constructed riprap and filter layer will discourage burrowing. The filter and riprap should extend at least 3 feet below the water line. As the muskrat attempts to construct a burrow, the sand and gravel of the filter layer caves in and thus discourages den building. Heavy wire fencing laid flat against the slope and extending above and below the water line can also be effective. Eliminating or reducing aquatic vegetation along the shoreline will discourage muskrat habitation. Where muskrats have inhabited the area, trapping is usually the most practical method of removing them from a pond.

Eliminating a Burrow

The recommended method of backfilling a burrow in an embankment is mud-packing. This simple, inexpensive method can be accomplished by placing one or two lengths of metal stove or vent pipe in a vertical position over the entrance of the den. Making sure that the pipe connection to the den does not leak, the mud-pack mixture is then poured into the pipe until the burrow and pipe are filled with the earth-water mixture. The pipe is removed and dry earth is tamped into the entrance. The mud-pack is made by adding water to a 90 percent earth and 10 percent cement mixture until a slurry or thin cement consistency is attained. All entrances should be plugged with well-compacted earth and vegetation re-established. Dens should be eliminated without delay because damage from just one hole can lead to failure of a dam or levee.

Beaver

Beaver will try to plug spillways with their cuttings. Routinely removing the cuttings is one way to alleviate the problem. Trapping beaver may be done by the owner during the appropriate season; however, the nearest ODNR, Division of Wildlife, District Office or state game protector should be contacted first.

Hunting and Trapping Regulations

Because hunting and trapping rules change from year to year, ODNR, Division of Wildlife authorities at one of the following offices should be consulted before taking any action.



Wildlife District One
1500 Dublin Road
Columbus 43215
Phone: (614) 644-3925
FAX (614) 644-3931

Wildlife District Two
952 Lima Avenue, Box A
Findlay 45840
Phone: (419) 424-5000
FAX (419) 422-4875

Wildlife District Three
912 Portage Lakes Drive
Akron 44319
Phone: (330) 644-2293
FAX (330) 644-8403

Wildlife District Four
360 E. State Street
Athens 45701
Phone: (740) 594-2211
FAX (740) 592-1626

Wildlife District Five
1076 Old Springfield Pike
Xenia 45385
Phone: (937) 372-9261
FAX (937) 376-3011

In Sandusky
305 East Shoreline Drive
Sandusky 44870
Phone: (419) 625-8062
FAX (419) 625-6272

In Fairport Harbor
Phone: (440) 352-6100
FAX (440) 350-0250

Any other questions, comments concerns, or fact sheet requests, should be directed to the Division of Water at the following address:

Ohio Department of Natural Resources
Division of Water
Dam Safety Engineering Program
1939 Fountain Square, Building E-3
Columbus, Ohio 43224-1336
(614) 265-6731 (Voice) (614) 447-9503 (Fax)
<http://www.dnr.state.oh.us/odnr/water/>

Rodent Burrow Damage

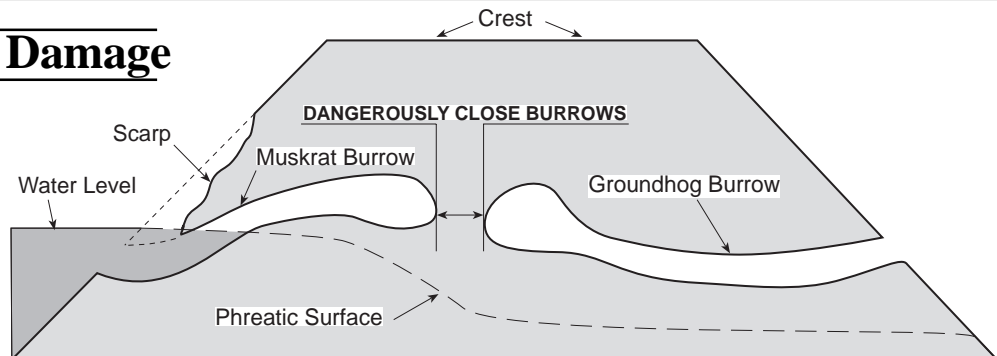

Bob Taft Governor • Samuel W. Speck Director • James R. Morris, P.E. Chief



Ohio Department of Natural Resources Division of Water Fact Sheet

Fact Sheet 94-31

Dam Safety: Seepage Through Earthen Dams

Contrary to popular opinion, wet areas down stream from dams are not usually natural springs, but seepage areas. Even if natural springs exist, they should be treated with suspicion and carefully observed. Flows from ground-water springs in existence prior to the reservoir would probably increase due to the pressure caused by the pool of water behind the dam.

All dams have some seepage as the impounded water seeks paths of least resistance through the dam and its foundation. Seepage must, however, be controlled to prevent erosion of the embankment or foundation or damage to concrete structures.

Detection

Seepage can emerge anywhere on the downstream face, beyond the toe, or on the downstream abutments at elevations below normal pool. Seepage may vary in appearance from a "soft," wet area to a flowing "spring." It may show up first as an area where the vegetation is lush and darker green. Cattails, reeds, mosses, and other marsh vegetation often become established in a seepage area. Another indication of seepage is the presence of rust-colored iron bacteria. Due to their nature, the bacteria are found more often where water is discharging from the ground than in surface water. Seepage can make inspection and maintenance difficult. It can also saturate and weaken portions of the embankment and foundation, making the embankment susceptible to earth slides.

If the seepage forces are large enough, soil will be eroded from the foundation and be deposited in the shape of a cone around the outlet. If these "boils" appear, professional advice should be sought immediately. Seepage flow which is muddy and carrying sediment (soil particles) is evidence of "piping," and will cause failure of the dam. Piping can occur along a spillway and other conduits through the embankment, and these areas should be closely inspected. Sinkholes

may develop on the surface of the embankment as internal erosion takes place. A whirlpool in the lake surface may follow and then likely a rapid and complete failure of the dam. Emergency procedures, including downstream evacuation, should be implemented if this condition is noted.

Seepage can also develop behind or beneath concrete structures such as chute spillways or headwalls. If the concrete structure does not have a means such as weep holes or relief drains to relieve the water pressure, the concrete structure may heave, rotate, or crack. The effects of the freezing and thawing can amplify these problems. It should be noted that the water pressure behind or beneath structures may also be due to infiltration of surface water or spillway discharge.

A continuous or sudden drop in the normal lake level is another indication that seepage is occurring. In this case, one or more locations of flowing water are usually noted downstream from the dam. This condition, in itself, may not be a serious problem, but will require frequent and close monitoring and professional assistance.

Control

The need for seepage control will depend on the quantity, content, and location of the seepage. Reducing the quantity of seepage that occurs after construction is difficult and expensive. It is not usually attempted unless the seepage has lowered the pool level or is endangering the embankment or appurtenant structures. Typical methods used to control the quantity of seepage are grouting or installation of an upstream blanket. Of these methods, grouting is probably the least effective and is most applicable to leakage zones in bedrock, abutments, and foundations. These methods must be designed and constructed under the supervision of a professional engineer experienced with dams.

Continued on back!

Controlling the content of the seepage or preventing seepage flow from removing soil particles is extremely important. Modern design practice incorporates this control into the embankment through the use of cut-offs, internal filters, and adequate drainage provisions. Control at points of seepage exit can be accomplished after construction by installation of toe drains, relief wells, or inverted filters.

Weep holes and relief drains can be installed to relieve water pressure or drain seepage from behind or beneath concrete structures. These systems must be designed to prevent migration of soil particles but still allow the seepage to drain freely. The owner must retain a professional engineer to design toe drains, relief wells, inverted filters, weep holes, or relief holes.

Monitoring

Regular monitoring is essential to detect seepage and prevent dam failure. Knowledge of the dam's history is important to determine whether the seepage condition is in a steady or changing state. It is important to keep written records of points of seepage exit, quantity and content of flow, size of wet area, and type of vegetation for later comparison. Photographs provide invaluable records of seepage.

All records should be kept in the operation, maintenance, and inspection manual for the dam. The inspector should always look for increases in flow and evidence of flow carrying soil particles, which would

indicate that a more serious problem is developing. Instrumentation can also be used to monitor seepage. V-notch weirs can be used to measure flow rates, and piezometers may be used to determine the saturation level (phreatic surface) within the embankment.

Regular surveillance and maintenance of internal embankment and foundation drainage outlets is also required. The rate and content of flow from each pipe outlet for toe drains, relief wells, weep holes, and relief drains should be monitored and documented regularly. Normal maintenance consists of removing all obstructions from the pipe to allow for free drainage of water from the pipe. Typical obstructions include debris, gravel, sediment, and rodent nests. Water should not be permitted to submerge the pipe outlets for extended periods of time. This will inhibit inspection and maintenance of the drains and may cause them to clog.

Any other questions, comments concerns, or fact sheet requests, should be directed to the Division of Water at the following address:

Ohio Department of Natural Resources
Division of Water
Dam Safety Engineering Program
1939 Fountain Square, Building E-3
Columbus, Ohio 43224-1336
(614) 265-6731 (Voice) (614) 447-9503 (Fax)
<http://www.dnr.state.oh.us/odnr/water/>



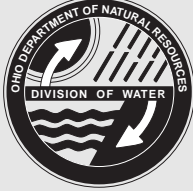

Ohio Department of Natural Resources Division of Water Fact Sheet

Fact Sheet 99-55

Dam Safety: Spillway Conduit System Problems

Many dams have conduit systems that serve as principal spillways. These conduit systems are required to carry normal stream and small flood flows safely past the embankment throughout the life of the structure. Conduits through embankments are difficult to construct properly and can be extremely dangerous to the embankment if problems develop after construction. Conduits are usually difficult to repair because of their location within the embankment. Also, replacing conduits requires extensive excavation. In order to avoid difficult and costly repairs, particular attention should be directed to maintaining these structures. The most common problem noted with spillway conduit systems is undermining of the conduit. This condition typically results from water leaking through pipe joints, seepage along the conduit or inadequate energy dissipation at the conduit outlet. The typical causes of seepage and water leaking through pipe joints include any one or a combination of the following factors: loss of joint material, separated joints, misalignment, differential settlement, conduit deterioration, and pipe deformation. Problems in any of these areas may lead to failure of the spillway system and possibly dam failure.

Undermining

Undermining is the removal of foundation material surrounding a conduit system. Any low areas or unexplained settlement of the earthfill in line with the conduit may indicate that undermining has occurred within the embankment. As erosion continues, undermining of a conduit can lead to displacement and collapse of the pipe sections and cause sloughing, sliding or other forms of instability in the embankment. As the embankment is weakened, a complete failure of the conduit system and, eventually the dam may occur.

Seepage along the conduit from the reservoir can occur as a result of poor compaction around the conduit. If seepage control devices have not been installed, the seepage may remove foundation material from around the conduit and eventually lead to undermining.

In addition, undermining can occur as the result of erosion due to inadequate energy dissipation or inadequate erosion protection at the outlet. This undermining can be visually observed at the outlet of a pipe system and can extend well into the embankment. In this case, undermining can lead to other conduit problems such as misalignment, separated joints and pipe deterioration. An extensive discussion on outlet erosion control as it relates to undermining of the pipe outlet can be found in the "Outlet Erosion Control Structures" fact sheet.

Installation of seepage control devices is required as a preventative measure to control seepage along the conduit and undermining. Regular monitoring of conduit systems must include visual observation and notation of any undermining or any precursors. These precursors usually include pipe deformation, misalignment and differential settlement, pipe deterioration, separated joints and loss of joint material.

Pipe deformation

Pipe deformations are typically caused by external loads that are applied on a pipe such as the weight of the embankment or heavy equipment. Collapse of the pipe can cause failure of the joints and allow erosion of the supporting fill. This may lead to undermining and settlement. Pipe deformation may reduce or eliminate spillway capacity. Pipe deformation must be monitored on a regular basis to ensure that no further deformation is occurring, that pipe joints are intact and that no undermining or settlement is occurring.

Separated joints and loss of joint material: Joint Deterioration

Conduit systems usually have construction and/or section joints. In almost every situation, the joints will have a water stop, mechanical seal and/or chemical seal to prevent leakage of water through the joint. Separation and deterioration can destroy the watertight integrity of the joint. Joint deterioration can result from weathering, excessive seepage, erosion or corrosion. Separation at a joint may be the result of a more serious condition such

Continued on back!

as foundation settlement, undermining, structural damage or structural instability. Deterioration at joints includes loss of gasket material, loss of joint sealant and spalling around the edges of joints. Separation of joints and loss of joint material allow seepage through the pipe. This can erode the fill underneath and along the conduit causing undermining, which can lead to the displacement of the pipe sections. Separated pipe joints can be detected by inspecting the interior of the conduit. A regular monitoring program is needed to determine the rate and severity of joint deterioration. Joint separations should be monitored to determine if movement is continuing.

Conduit Deterioration

Deterioration of conduit material is normally due to the forces of nature such as wetting and drying, freezing and thawing, oxidation, decay, ultra-violet light, cavitation and the erosive forces of water. Deterioration of pipe materials and joints can lead to seepage through and along the conduit and eventually failure of conduit systems. Additional information on deterioration can be found on the "Problems with Concrete Materials", "Problems with Metal Materials", and "Problems with Plastic (Polymer) Materials" fact sheets.

Differential Settlement

Removal or consolidation of foundation material from around the conduit can cause differential settlement. Inadequate compaction immediately next to the conduit system during construction would compound the problem. Differential settlement can ultimately lead to undermining of the conduit system. Differential settlement should be monitored with routine inspections and documentation of observations.

Misalignment

Alignment deviations can be an indication of movement, which may or may not be in excess of design tolerances. Proper alignment is important to the structural integrity of conduit systems. Misalignment can be the direct result of internal seepage flows that have removed soil particles or dissolved soluble rock. Misalignment can also result from poor construction practices, collapse of deteriorated conduits, decay of organic material in the dam, seismic events or normal settlement

due to consolidation of embankment or foundation materials. Excessive misalignment may result in other problems such as cracks, depressions, slides on the embankment, joint separation and seepage. Both the vertical and horizontal alignment of the conduit should be monitored on a regular basis.

Monitoring and Repair

Frequent inspection is necessary to ensure that the pipe system is functioning properly. All conduits should be inspected thoroughly once a year. Conduits that are 24 inches or more in diameter can be entered and visually inspected with proper ventilation and confined space precautions. Small inaccessible conduits may be monitored with video cameras. The conduits should be inspected for misalignment, separated joints, loss of joint material, deformations, leaks, differential settlement and undermining. Problems with conduits occur most often at joints, and special attention should be given to them during the inspection. The joint should be checked for separation caused by misalignment or settlement and loss of joint-filler material. The outlet should be checked for signs of water seeping along the exterior surface of the conduit. Generally, this is noted by water flowing from under the conduit and/or the lack of foundation material directly beneath the conduit. The embankment surface should be monitored for depressions or sinkholes. Depressions or sinkholes on the embankment surface above the spillway conduit system develop when the underlying material is eroded and displaced. Photographs along with written records of the monitoring items performed provide invaluable information.

Effective repair of the internal surface or joint of a conduit is difficult and should not be attempted without careful planning and proper professional supervision. Various construction techniques can be applied for minor joint repair and conduit leakage, but major repairs require a plan be developed by a professional engineer experienced in dam spillway construction.

Any other questions, comments concerns, or fact sheet requests, should be directed to the Division of Water at the following address:

Ohio Department of Natural Resources
Division of Water
Dam Safety Engineering Program
1939 Fountain Square, Building E-3
Columbus, Ohio 43224-1336
(614) 265-6731 (Voice) (614) 447-9503 (Fax)
<http://www.dnr.state.oh.us/odnr/water/>



Bob Taft Governor • Samuel W. Speck Director • James R. Morris, P.E. Chief



Ohio Department of Natural Resources Division of Water Fact Sheet

Fact Sheet 94-28

Dam Safety: Trees and Brush

The establishment and control of proper vegetation is an important part of dam maintenance. Properly maintained vegetation can help prevent erosion of embankment and earth channel surfaces, and aid in the control of groundhogs and muskrats. The uncontrolled growth of vegetation can damage embankments and concrete structures and make close inspection difficult.

Trees and Brush

Trees and brush should not be permitted on embankment surfaces or in vegetated earth spillways. Extensive root systems can provide seepage paths for water. Trees that blow down or fall over can leave large holes in the embankment surface that will weaken the embankment and can lead to increased erosion. Brush obscures the surface limiting visual inspection, provides a haven for burrowing animals, and retards growth of grass vegetation. Tree and brush growth adjacent to concrete walls and structures may eventually cause damage to the concrete and should be removed.

Stump Removal & Sprout Prevention

Stumps of cut trees should be removed so vegetation can be established and the surface mowed. Stumps can be removed either by pulling or with machines that grind them down. All woody material should be removed to about 6 inches below the ground surface. The cavity should be filled with well-compacted soil and grass vegetation established.

Stumps of trees in riprap cannot usually be pulled or ground down, but can be chemically treated so they will not continually form new sprouts. Certain herbicides are effective for this purpose and can even be used at water supply reservoirs if applied by licensed personnel. For product information and information on how to obtain a license, contact the Ohio Department of Agriculture at the following address:

Ohio Department of Agriculture
Pesticide Regulation
8995 E. Main Street
Reynoldsburg, Ohio 43068
Telephone Number (614) 728-6987

These products should be painted, not sprayed, on the stumps. Other instructions found on the label should be strictly followed when handling and applying these materials. Only a few commercially available chemicals can be used along shorelines or near water.

Embankment Maintenance

Embankments, areas adjacent to spillway structures, vegetated channels, and other areas associated with a dam require continual maintenance of the vegetal cover. Grass mowing, brush cutting, and removal of woody vegetation (including trees) are necessary for the proper maintenance of a dam, dike, or levee. All embankment slopes and vegetated earth spillways should be mowed at least once a year. Aesthetics, unobstructed viewing during inspections, maintenance of a non-erodible surface, and discouragement of groundhog habitation are reasons for proper maintenance of the vegetal cover.

Methods used in the past for control of vegetation, but are now considered unacceptable, include chemical spraying, and burning. More acceptable methods include the use of weed whips or power brush-cutters and mowers. Chemical spraying to first kill small trees and brush is acceptable if precautions are taken to protect the local environment.

It is important to remember not to mow when the embankment is wet. It is also important to use proper equipment for the slope and type of vegetation to be cut. Also, always follow the manufacturer's recommended safe operation procedures.

Any other questions, comments, concerns, or fact sheet requests, should be directed to the Division of Water at the following address:

Ohio Department of Natural Resources
Division of Water
Dam Safety Engineering Program
1939 Fountain Square, Building E-3
Columbus, Ohio 43224-1336
(614) 265-6731 (Voice) (614) 447-9503 (Fax)
<http://www.dnr.state.oh.us/odnr/water/>



Bob Taft *Governor* • Samuel W. Speck *Director* • James R. Morris, P.E. *Chief*



Ohio Department of Natural Resources Division of Water Fact Sheet

Fact Sheet 99-52

Dam Safety: Upstream Slope Protection

Slope protection is usually needed to protect the upstream slope against erosion due to wave action. Without proper slope protection, a serious erosion problem known as “beaching” can develop on the upstream slope.

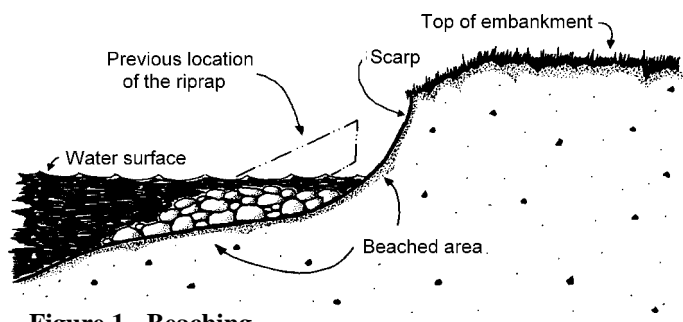

Figure 1 - Beaching

The repeated action of waves striking the embankment surface erodes fill material and displaces it farther down the slope, creating a “beach.” The amount of erosion depends on the predominant wind direction, the orientation of the dam, the steepness of the slope, water level fluctuations, boating activities, and other factors. Further erosion can lead to cracking and sloughing of the slope which can extend into the crest, reducing its width. When erosion occurs and beaching develops on the upstream slope of a dam, repairs should be made as soon as possible. However, an erosion scarp less than 1 foot high may be stable and not require repair.

The upstream face of a dam is commonly protected against wave erosion by placement of a layer of rock riprap over a layer of bedding and a filter material. Other material such as concrete facing, soil-cement, fabri-form bags, slush grouted rocks, steel sheet piling, and articulated concrete blocks can also be used. Vegetative protection combined with a berm on the upstream slope can also be effective.

Rock Riprap

Rock riprap consists of a heterogeneous mixture of irregular shaped rocks placed over gravel bedding and a sand filter or geotextile fabric. The smaller rocks help to fill the spaces between the larger pieces forming an interlocking mass. The filter prevents soil particles on the embankment surface from being washed out through the spaces (or voids) between the

rocks. The maximum rock size and weight must be large enough to break up the energy of the maximum anticipated wave action and hold the smaller stones in place. If the rock size is too small, it will eventually be displaced and washed away by wave action. If the riprap is sparse or if the filter or bedding material is too small, the filter material will wash out easily, allowing the embankment material to erode. Once the erosion has started, beaching will develop if remedial measures are not taken. Technical Release No. 69 developed by the USDA, Natural Resources Conservation Service can be used to help design engineers develop a preliminary or detailed design for riprap slope protection.

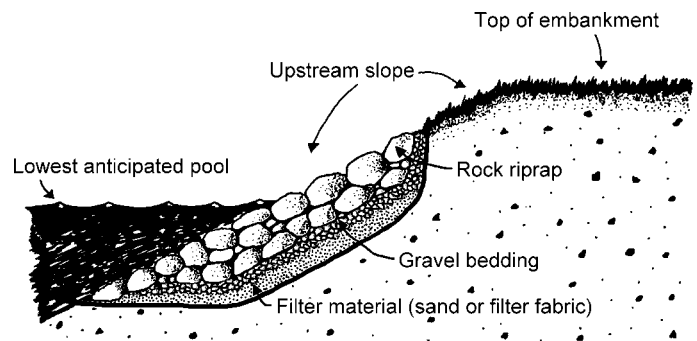

Figure 2 - Rock Riprap

The dam owner should expect some deterioration (weathering) of riprap. Freezing and thawing, wetting and drying, abrasive wave action, and other natural processes will eventually break down the riprap. Its useful life varies with the characteristics of the stone used. Stone for riprap should be rock that is dense and well cemented. In Ohio, glacial cobbles or boulders, most limestone, and a few types of sandstone are acceptable for riprap. Most sandstones and shales found in Ohio do not provide long-term protection. Due to the high initial cost of rock riprap, its durability should be determined by appropriate testing procedures prior to installation. Vegetative growth within the slope protection is undesirable because it can displace stone and disturb the filter material. Heavy undergrowth prevents an adequate inspection of the upstream slope and may hide potential problems. For additional information, see the “Trees and Brush” fact sheet.

Continued on back!

Sufficient maintenance funds should be allocated for the addition of riprap and the removal of vegetation. Severe erosion or reoccurring problems may require a registered professional engineer to design a more effective slope protection.

Vegetated Wave Berm

Vegetated wave berms dissipate wave energy and protect the slope from erosion. Berms are constructed on the upstream slope at the normal pool level and should be no less than 20 feet wide. This method of slope protection will not work well where the water surface fluctuates regularly from normal pool. If improper or sparse vegetation is present, the wave berm may not adequately dissipate the wave energy, allowing erosion and beaching to develop on the upstream slope. Technical Release No. 56 developed by the USDA, Natural Resources Conservation Service provides design and layout information.

The vegetation on the wave berm should be monitored regularly to verify adequate growth. Sufficient funds should be allocated for the regular maintenance of the vegetation. Severe erosion or reoccurring problems may require a registered professional engineer to design a more effective slope protection.

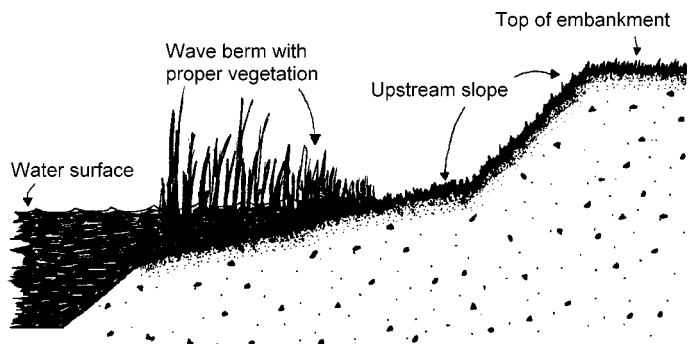

Figure 3 - Vegetated wave berm

Concrete Facing

Concrete facing can be used if severe wave action is anticipated, however, settlement of the embankment must be insignificant to insure adequate support for the concrete facing. A properly designed and constructed concrete facing can be expensive. This slope protection should extend several feet above and below the normal pool level. It should terminate on a berm or against a concrete curb or header. Granular filter or filter fabric (geotextile) is required under the concrete facing to help reduce the risk of undermining.

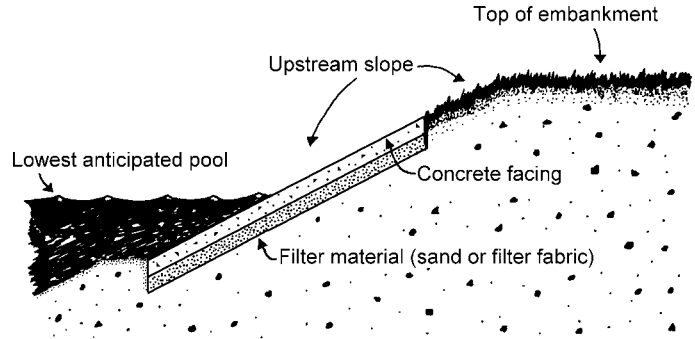

Figure 4 - Concrete facing

As with any type of slope protection, problems will develop if the concrete facing has not been properly designed or installed. Concrete facing often fails because the wave action washes soil particles from beneath the slabs through joints and cracks. This process is known as undermining, which will continue until large voids are created. Detection of voids is difficult because the voids are hidden. Failure of the concrete facing may be sudden and extensive. Concrete facing should be monitored for cracks and open joints. Open joints should be sealed with plastic fillers and cracks should be grouted and sealed. For additional information, see the “Problems with Concrete Materials” fact sheet.

Inspection and Monitoring

Regular inspection and monitoring of the upstream slope protection is essential to detect any problems. It is important to keep written records of the location and extent of any erosion, undermining, or deterioration of the riprap, wave berm or other slope protection. Photographs provide invaluable records of changing conditions. A rapidly changing condition may indicate a very serious problem, and the Dam Safety Engineering Program should be contacted immediately. All records should be kept in the operation, maintenance, and inspection manual for the dam.

Any other questions, comments concerns, or fact sheet requests, should be directed to the Division of Water at the following address:

Ohio Department of Natural Resources
 Division of Water
 Dam Safety Engineering Program
 1939 Fountain Square, Building E-3
 Columbus, Ohio 43224-1336
 (614) 265-6731 (Voice) (614) 447-9503 (Fax)
<http://www.dnr.state.oh.us/odnr/water/>

