



DANA 44 (30 spline) OX Locker

This is your OX Locker installation manual for the DANA 44 front and rear. This installation guide is illustrated with a Jeep TJ (rear). Please note before installation you need: an installation kit which includes bearings, shims, ring gear bolts, etc. You must use this manual in conjunction with your vehicle's service manual. Professional installation by a certified mechanic is recommended.

Note: Depending on the year, make, and model of your vehicle, some deviations and modifications may be needed during installation: 1) routing of the cable 2) placement of the shifter.

The OX Locker is proudly made in the USA – Pat. No. 6,432,020

If you have any installation questions please write, call, or e-mail:

OX/FMG

11625 Prosperous Drive

Odessa, FL 33556

Tech Support: 866-813-2716

Fax: 727-569-3200

oxtechsupport@earthlink.net

www.fcma.com

Carrier Assembly

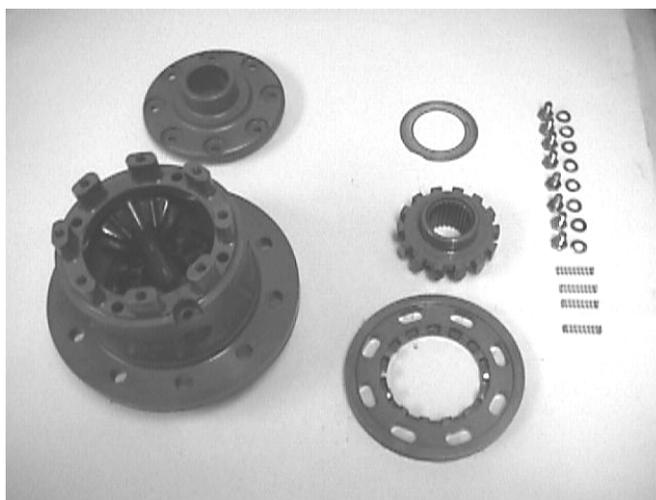

OX Locker needs final assembly. Remove all packaging including any tie wraps. Picture shows the parts that need to be assembled:

8 – bolts, ¼-28 thread

8 - spring washers

1 - small carrier cap

1 - thrust washer

1 - locking ring gear

1 - locking side gear

4 - springs

1 - big carrier cap
(attached to carrier)

1.



Install the 4 springs in the 4 chamfered holes.

2.



Install thrust washer behind locking side gear.

3.

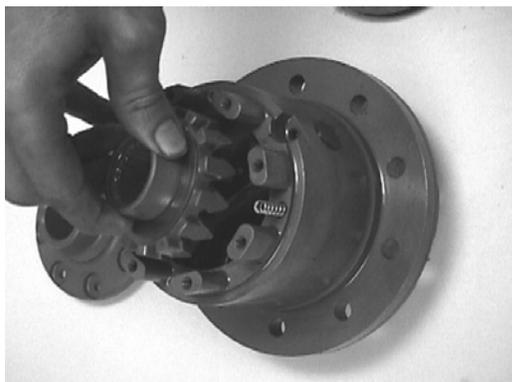

Install locking side gear with gears facing engagement with spider gears

4.



Slide the ring gear around the carrier.

5.

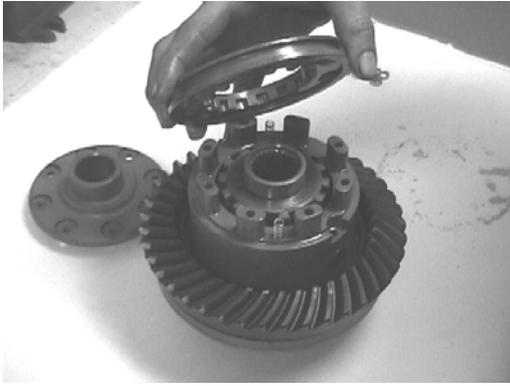

Install locking ring gear with gears facing engagement with locking side gear

6.

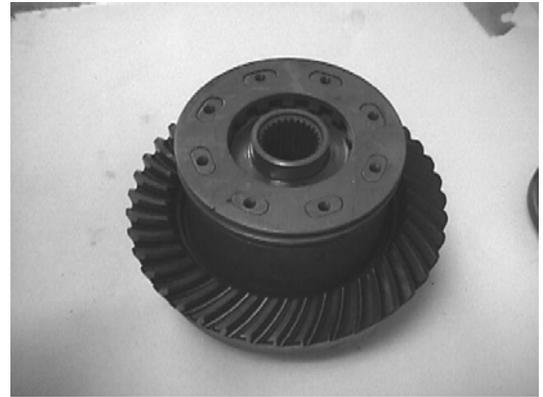

The flat side must be facing up!

7.

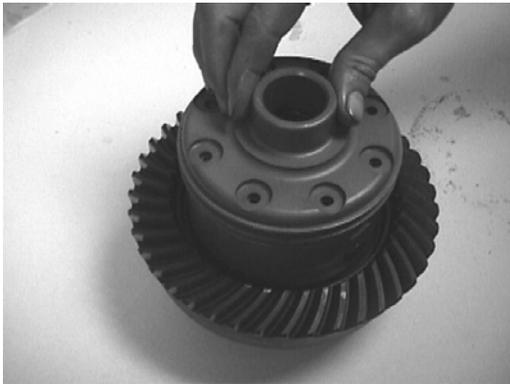

Install small carrier cap – align holes, make sure it slides into locking side gear smoothly. **NOTE: Make sure this cap sits flush with all 8 cams – if cap is not flush, it could cause severe damage to the carrier**

8.



Install the 1/4 bolts and spring washers. Apply high strength loctite to bolts.

9.

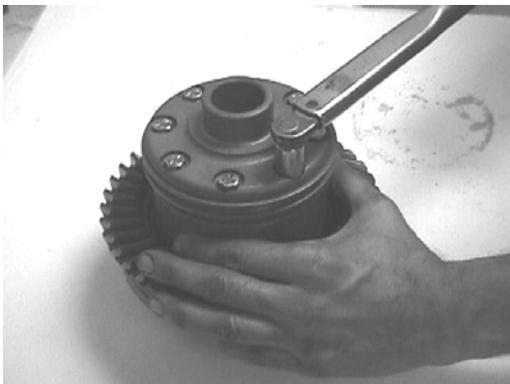

Torque 1/4 bolts to 12 FT LBS. Note: when tightening, tighten the bolts in the following pattern: 1 – 5 – 7 – 3 – 8 – 4 – 6 – 2

10.

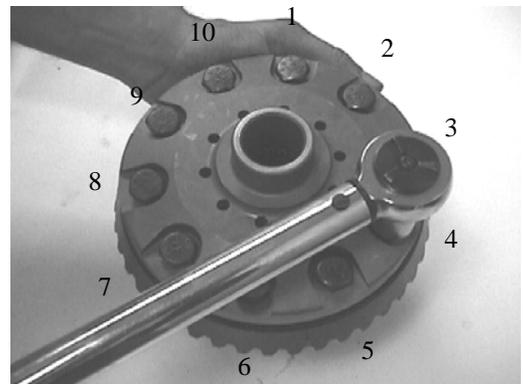

Install your bolts from your original ring gear – we recommend you install new bolts. Torque them to 80 FT LBS using the following pattern: 1 – 6 – 8 – 3 – 10 – 5 – 7 – 2 – 9 – 4 Note: ring gear is a tight fit on the carrier.

OX Locker[™] Installation – Dana 44

1.

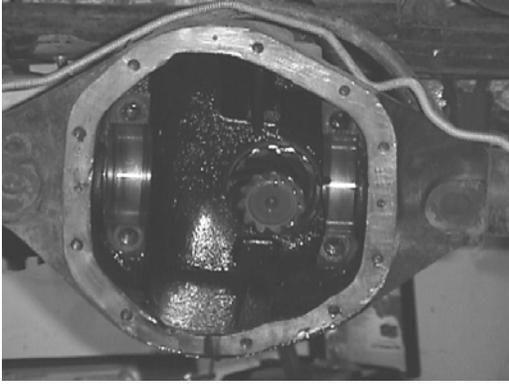

Remove tires, brakes, rotors, and axles in accordance with your vehicle's manufacturer's service manual (MSM). Drain oil then remove carrier. Now is a good time to check seals and clean entire housing.

2.

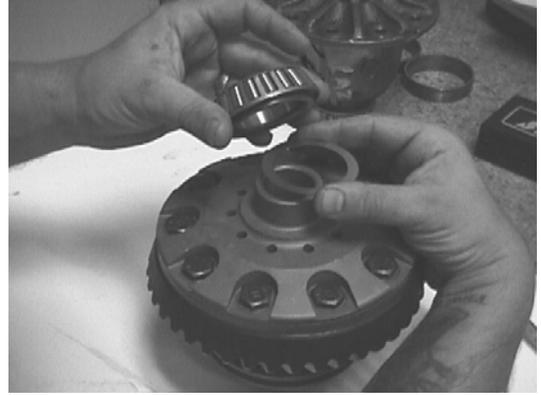

Install your bearings and shims in accordance with your MSM. Note: installation kit not included – bearings, shims, etc.

3.



Check your pattern in accordance with your MSM. Note: gear set up should be done by a certified mechanic

4.

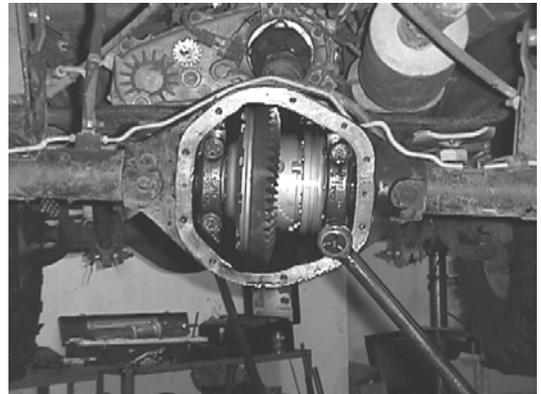

Torque bearing caps to 80 FT LBS. Install axles, rotors, brakes, and tires in accordance with your MSM.

5.



The cable has a short fitting and a long fitting. Short fitting goes into the cover.

6.

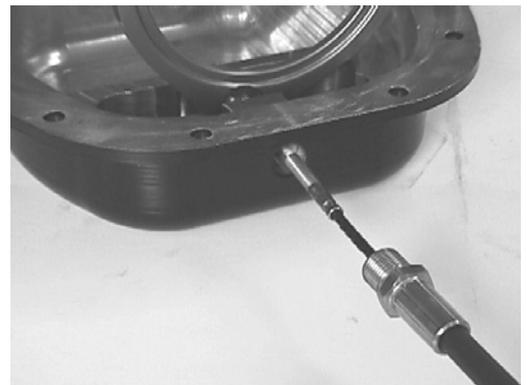

Install fitting into the cover. Screw the cable rod in first and then the fitting as needed.

7.

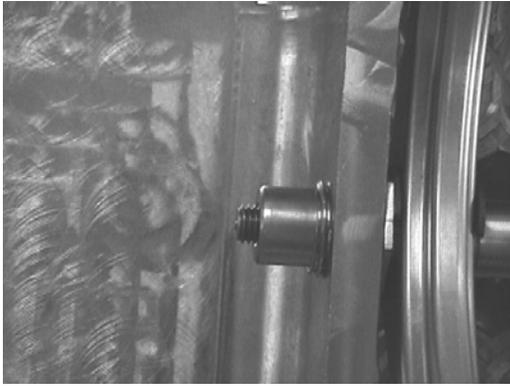

Leave about 2 – 3 threads out of the piston that slides in the cover.

8.

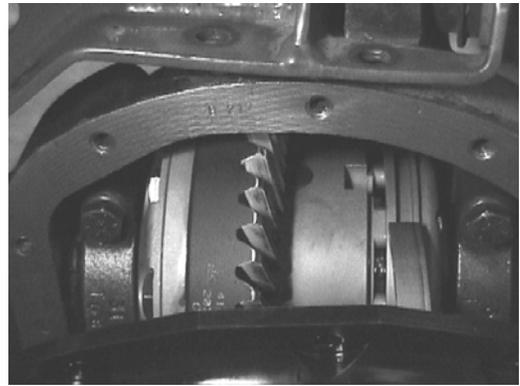

Install cover on to the differential. Make sure the fork slides on the locking ring.

9.



Install diff cover bolts supplied and torque to 30 FT LBS. Note: Use gasket or sealant in accordance with your MSM.

10.



Do not make the turn coming out of the differential too tight or too loose.

Too tight may cause the cable to be inaccurate on the stroke and too loose may cause the cable to come in contact with the exhaust.

11.

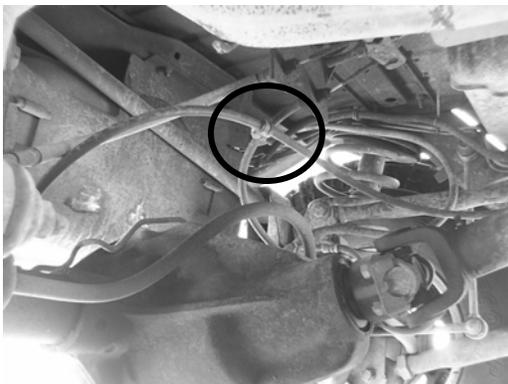

Secure the cable on the opposite side of where the exhaust is located

12.

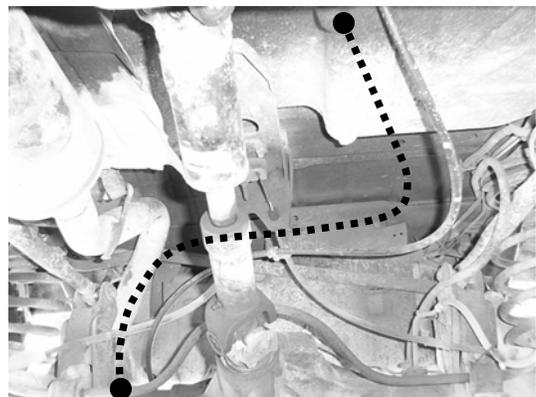

Follow the routing as shown.

13.

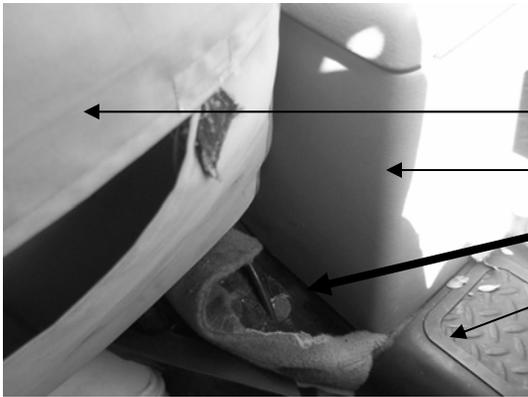

Driver Seat

Center Console

Drill Hole

Rear Floorboard

Open a 7/8" hole through the floorboard, then cut it oval from front to rear to enable the cable to pass through without interference. Note: for best results, open hole 16" to the rear of where you are going to install the shifter box.

14.

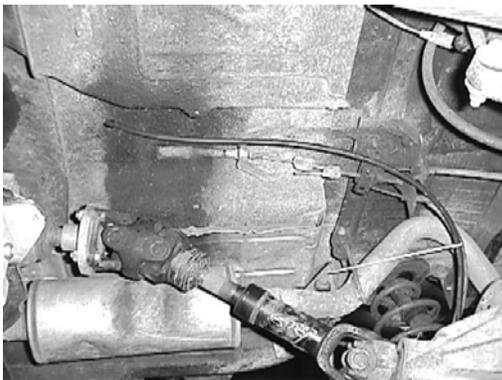

Give the cable plenty of slack to allow for articulation. No sharp turns or kinks.

OX Lockertm – New shifter assembly and adjustment.

The installation of the shifter should be done after the cover is placed on the differential. Make sure you have already routed the cable and placed it near to where you are going to install it permanently.

1.



Shifter Assembly

2.

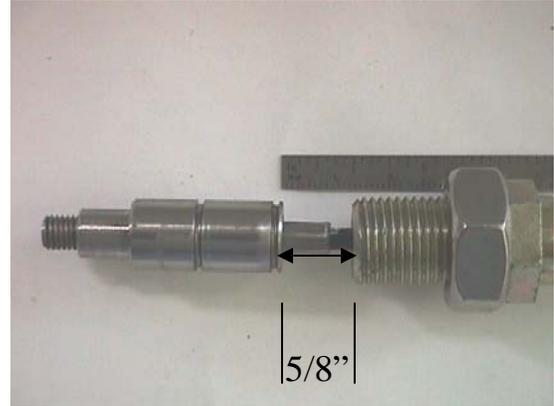

Thread the piston into the rod end of the cable. Note: Make sure to leave 5/8" gap and to use medium strength loc-tite

3.



Place spring on piston and into the swivel fitting on the shifter.

4.

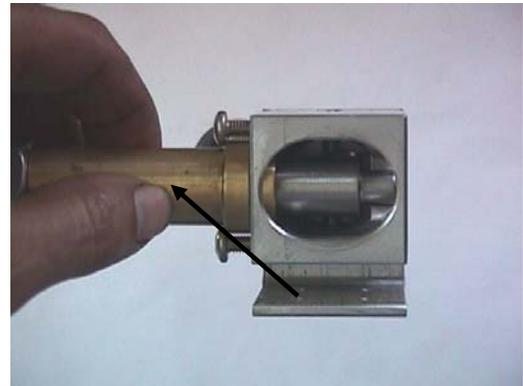

Thread the swivel fitting until it touches the shift rod as shown.

5.



Shift several times into lock and unlock. Check the shift on the unlock position (make sure it is still touching, if not adjust appropriately, then tighten the two screws on the swivel fitting, tighten the lock nut, and install your shifter.

OX Locker installation Notes:

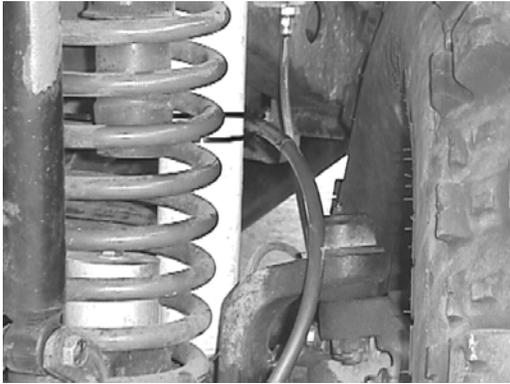

When installing the cable, fasten to as many areas as necessary to keep it from rubbing against unwanted surfaces. You may want to apply some chaffing tape to areas of high friction. Tape not included.

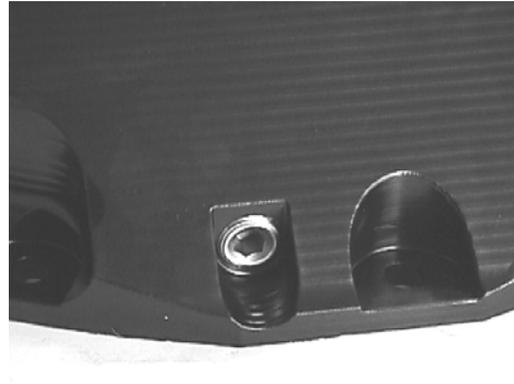

When draining oil, use bottom drain plug. If you remove the cover you have to readjust the shifter.



When installing the knob, don't thread all the way down. Make sure that the shifter can shift clear.

SAFETY FEATURE: To avoid accidental shifting or tampering with the shifter while driving on the street, you can thread the knob all the way down in the unlock position. Note: Remember to back off the knob when you are ready to use your locker off road.



Mount the shifter(s) in an easy to reach and easy to maintain place and in a straight as possible path with the cable (do not kink the cable).



OX Locker Limited Warranty

ONE YEAR limited warranty on manufacturer defects:

- This warranty covers only parts originally supplied by OX/FMG if they are shown to have a manufacturer's defect. All parts must be returned to OX/FMG and if upon inspection by OX/FMG, they were installed correctly in their intended application and were not mistreated they will be repaired or replaced.
- This warranty does not cover vehicles with modified high-horsepower engines (modified beyond the original manufacturer's recommendation).
- OX/FMG recommends professional installation by a qualified mechanic. Purchaser/user assumes all risks and liabilities in connection therewith.
- Installation and use of these parts constitutes acceptance of all the above stipulations. If the purchaser/user does not agree to these terms, the OX Locker should not be installed and returned to the supplier.
- TO REDEEM your coverage you must return the defective part(s) along with your claim #. Claim # can only be obtained by calling or e-mailing OX/FMG. OX/FMG will make a complete evaluation of your claim before validating it. (727) 569-1000 OR oxtechsupport@earthlink.net

OX Locker™ - US Pat. 6,432,020

Questions for OX/FMG :

Service

1. An initial oil change at 1500 miles is recommended. After this, periodic oil changes should be done in accordance with the vehicles owner's manual.
2. If differential is immersed in deep water, the oil inside your housing could get water contamination. An oil change is recommended.

Cable Installation Recommendation

1. Use a fuel line hose on rubbing surfaces.
2. Cut hose on one side, slip over cable, and use a tie wrap on each end to hold it in place.
3. Don't create too many bends or bind the cable. This will affect the stroke adjustment.
4. Make sure that the cable exits the floor board or the firewall as straight as possible.

Shifter Installation Recommendation

1. We recommend to mount the shifter on an open area with easy access.
2. When adjusting the shifter, it should be kept close to the place it's going to be mounted.

How To Engage And Disengage

1. The OX Locker tm can engage and disengage by simply shifting from (O) open to (X) locked.
2. The OX Locker tm is intended to be engaged only when the terrain ahead requires extra traction control. NOTE: This product is not intended to be used on paved streets under any condition. This product is intended for OFF ROAD USE ONLY.
3. To engage the locker on rough or slippery terrain, move the shifter to the (X) position, the locker will engage almost immediately. To disengage move the shifter to the (O) position, the locker will disengage as soon as the load is release from the differential, this happens almost immediately.
4. The OX Locker tm can be engaged at any speed.

Troubleshooting

Problem	The locker seems to be properly adjusted, but after a few cycles it loses its adjustment.
Solution	Check for excessive slack in the cable adjustment, also look for a very tight bend or an area that is being pressed between two parts, and also check to see if the cable was burned by the exhaust. The shifter should have tension as soon as you start to shift into the lock position.

WARNING: Do not engage the OX Locker tm on paved roadways under any conditions (dry,rain, snow etc.) or high traction surfaces, this makes the steering very difficult and puts unnecessary strain on the drive train. This could cause serious damages and/or it could even be fatal.

PARTS LIST FOR DANA 44 P/N OXD44C392H
30 Spline

ITEM	PART NUMBER	PART NAME	QTY.
1	OXD44-01	BIG CARRIER CAP	1
2	OXD44-02	THRUST WASHER	2
3	OXD44-03	SIDE GEAR	1
4	OXD44-04	SPIDER GEAR	4
5	OXD44-05	LONG CROSS SHAFT	1
6	OXD44-06	SMALL THRUST WASHER	4
7	OXD44-07	CARRIER CASE	1
8	OXD44-08	LOCKING SIDE GEAR	1
9	OXUNP-09	SPRING S-770	4
10	OXD44-10	LOCKING RING	1
11	OXD44-11	SMALL CARRIER CAP	1
12	OXUNP-12	¼ SPRING WASHER	8
13	OXUNP-13	¼ -28 GRADE 8 BOLT	8
14	OXD44-14	CENTER BLOCK	1
15	OXD44-15	SMALL SHAFT	2
16	OXD44-16	DIFFERENTIAL COVER	1
17	OXUNP-17	DIF. COVER PISTON	1
18	OXD44-18	DIF. COVER FORK	1
19	OXUNP-19	½" RETAINING RING	2
20	OXUNP-20	O-RING 568-12	1
21	OX46001	LOCKER CABLE ASSY.	1
22	OXSHIFTER-01	SHIFTER BOX	1
23	OXSHIFTER-02	SWIVEL FITTING	1
24	OXSHIFTER-03	SHIFTER SPRING	1
25	OXSHIFTER-04	SPRING PISTON	1
26	OXSHIFTER-05	SPRING SLEEVE	1
27	OXSHIFTER-06	3/16 X 1.5 DOWEL PIN	1
28	OXSHIFTER-07	TRIGGER CUP	1
29	OXSHIFTER-08	TRIGGER SPRING	1
30	OXSHIFTER-09	SHIFTER FORK	1
31	OXSHIFTER-10	SHIFTER KNOB	1
32	OXHSIFTER-11	PHILLIPS PAN HEAD SCREWS	6
33	OXSHIFTER-12	SHIFTER BRACKET	1
34	OXSTICKER	3M REFLECTIVE GOLD	1
35	OXUNP-21	OIL FILL PLUG	1
36	OXUNP-22	OIL FILL PLUG WASHER	1
37	OXUNP-23	DRAIN PLUG	1
38	OXUNP-24	HEX FLG BOLT 5/16-18 X ¾	10
39	OXUNP-25	7/32 X 1 ½ SPRING PIN	3

DXD44C392H SCHEMATIC SHEET 2 OF 3

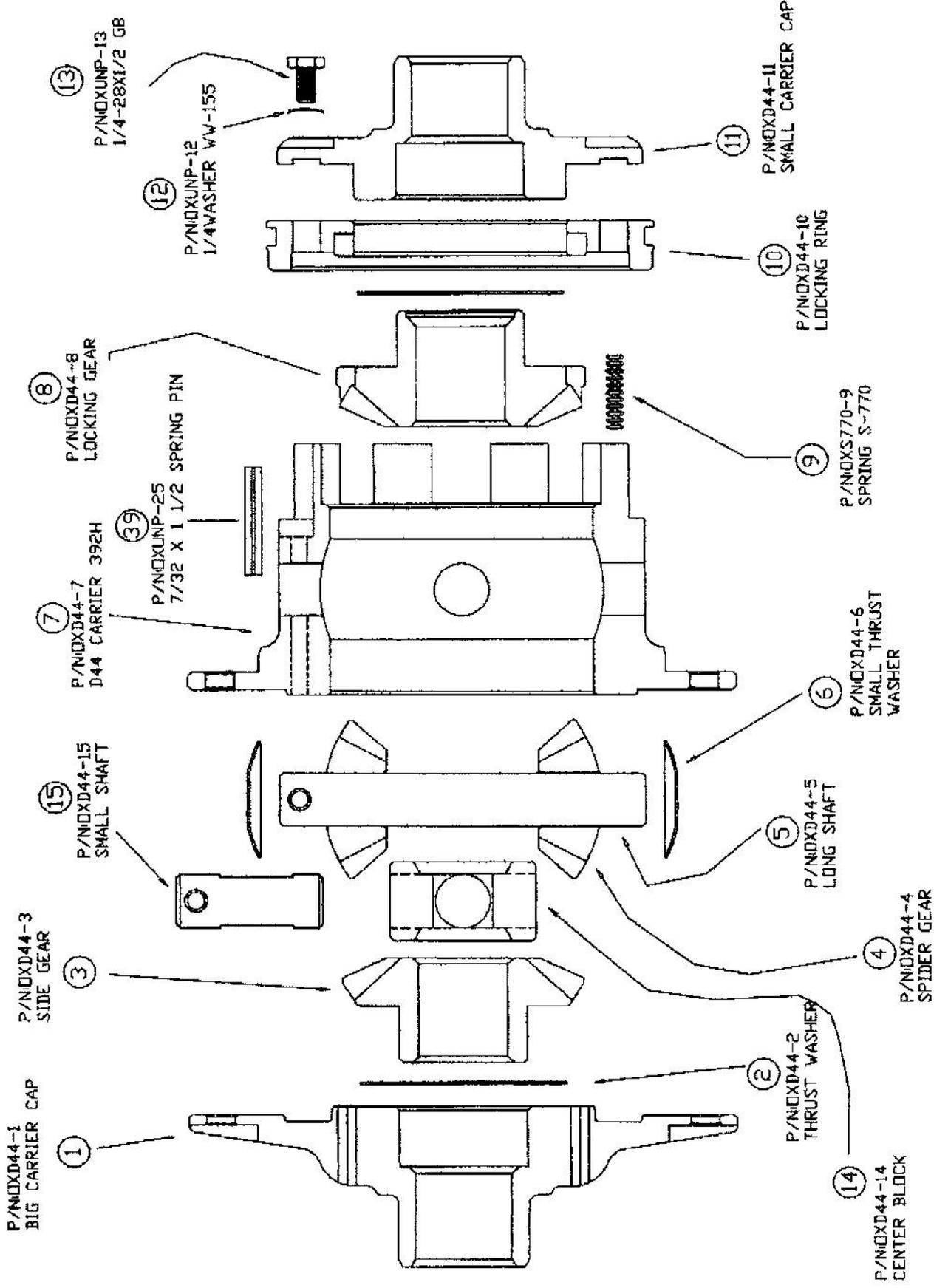

OXD44C392H SCHEMATIC SHEET 3 OF 3

