



# Data Center Standards: How TIA-942 and BICSI-002 Work Together

Jonathan Jew – President, J&M Consultants, Inc  
TIA TR-42 Secretary  
TIA TR-42.3 Vice-Chair  
BICSI Data Center Subcommittee Co-Chair  
USTAG ISO/IEC JTC 1 SC 25 WG 3 Vice-Chair



# Jonathan Jew

- 30+ years
- 90+ data center projects
- Co-Chair BICSI Data Center Design & Implementation Subcommittee
- US Project Lead for ISO/IEC 24764 and ISO/IEC 11801-5 international data center cabling standards
- Primary contributor ANSI/TIA-942, ANSI/TIA-942-A, and editor of ANSI/TIA-942-B revision (data centers)
- Primary contributor ISO/IEC TR 14763-2-1 telecom identifiers, ANSI/TIA-606-B telecom administration, and editor ANSI/TIA-606-C revision



TIA-942 & BICSI-002 are each part of a family of publications



# TIA-942 is part of a family of TR-42 cabling standards

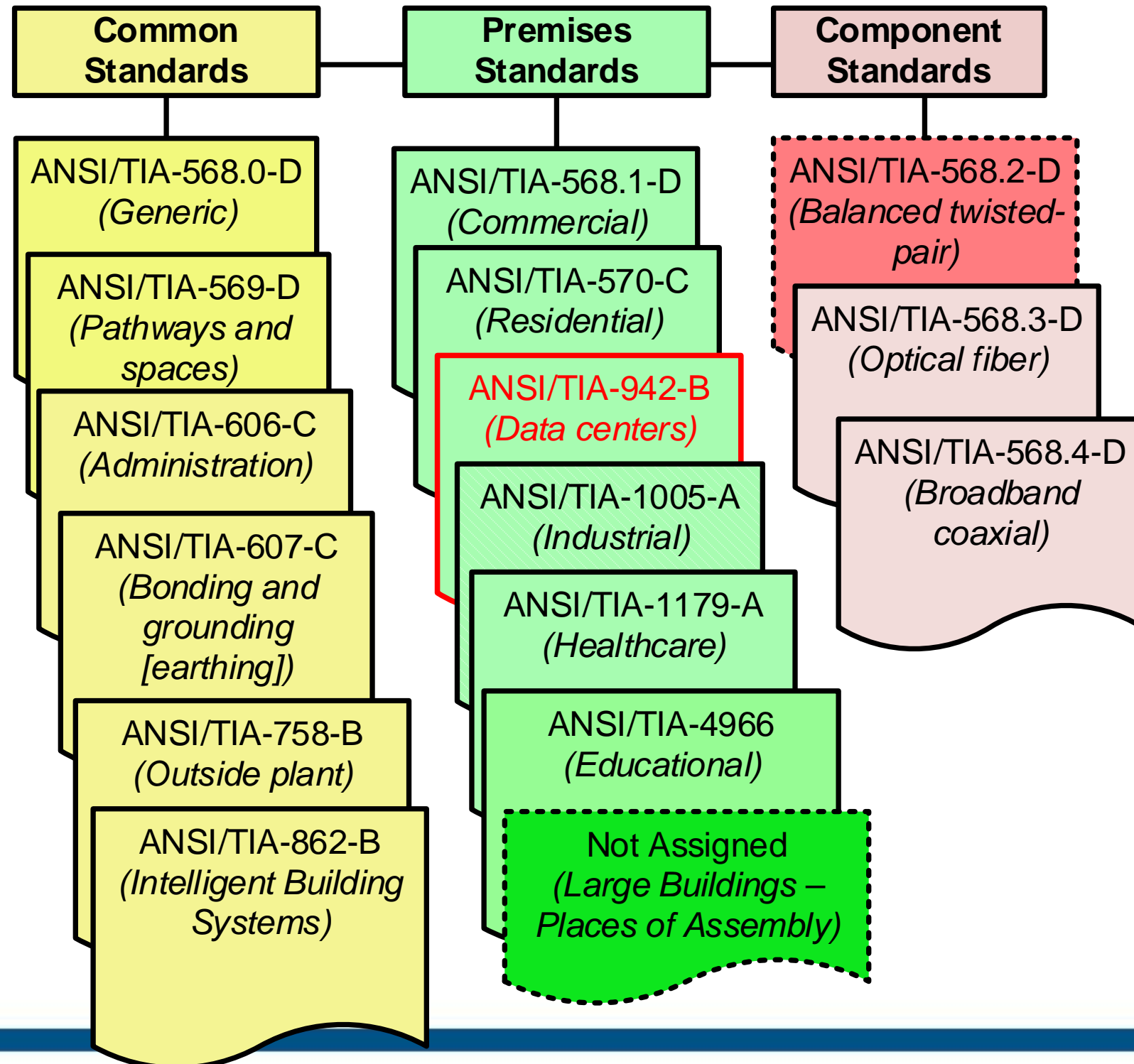



TIA standards apply in US and Canada  
and are widely used in other countries



Other families of standards apply in  
other countries



# European (CENELEC) premises cabling standards

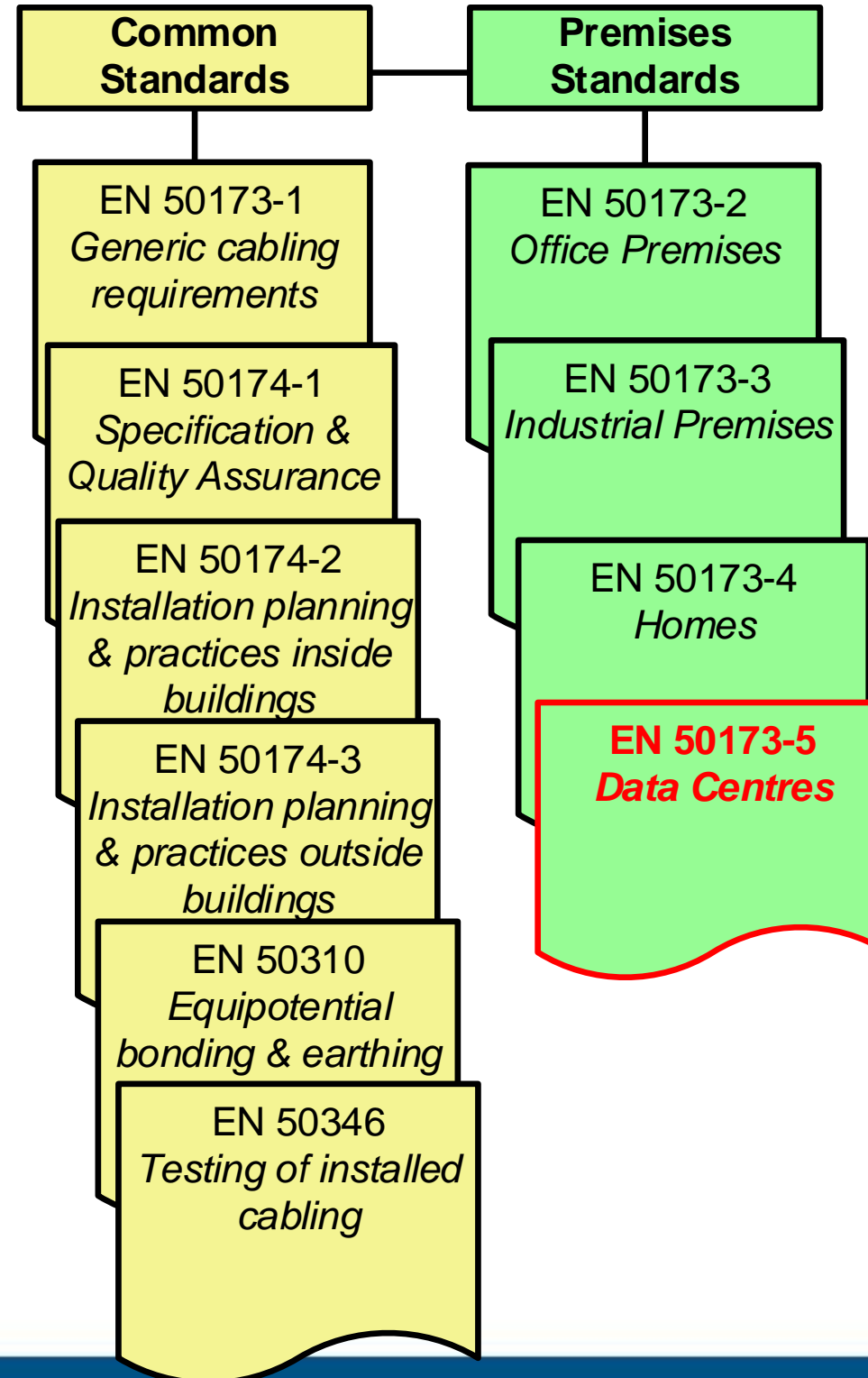



# International (ISO/IEC) premises cabling standards

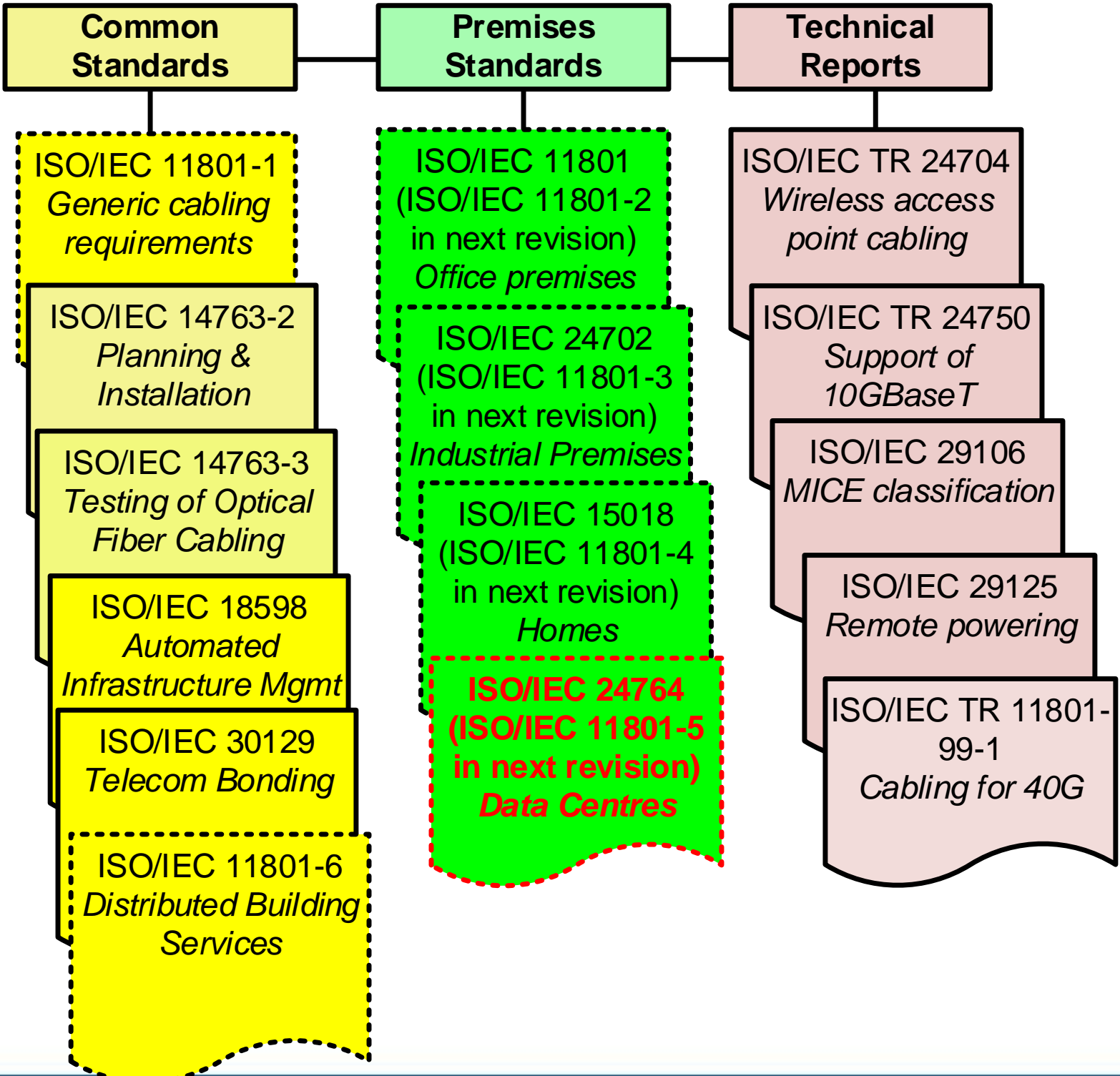





BICSI standards and manuals are also a family of complementary publications and are meant to work with TIA, CENELEC, ISO, & other national standards



# BICSI-002 is part of a family of standards & manuals

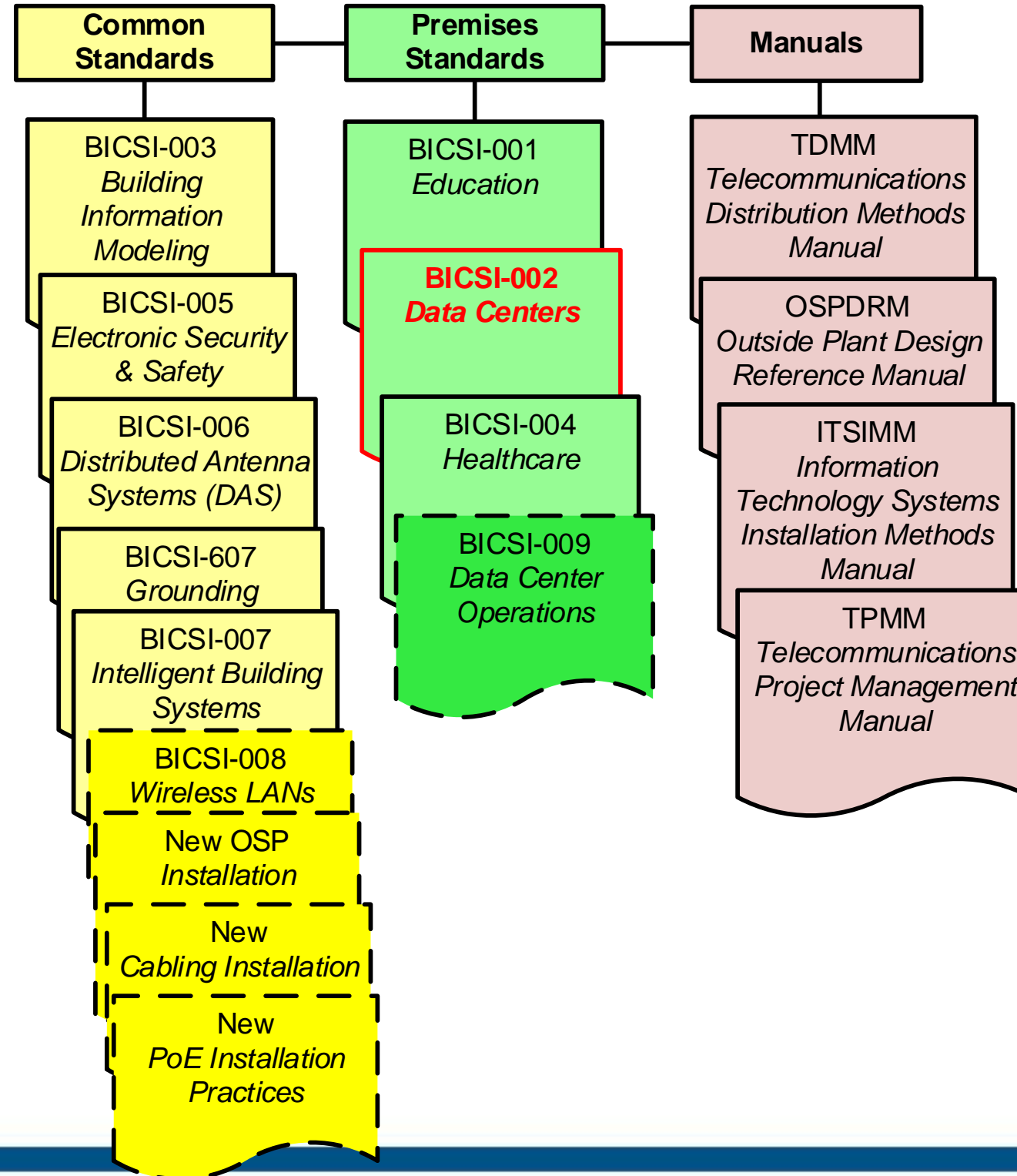



# BICSI Publications Complement National Standards

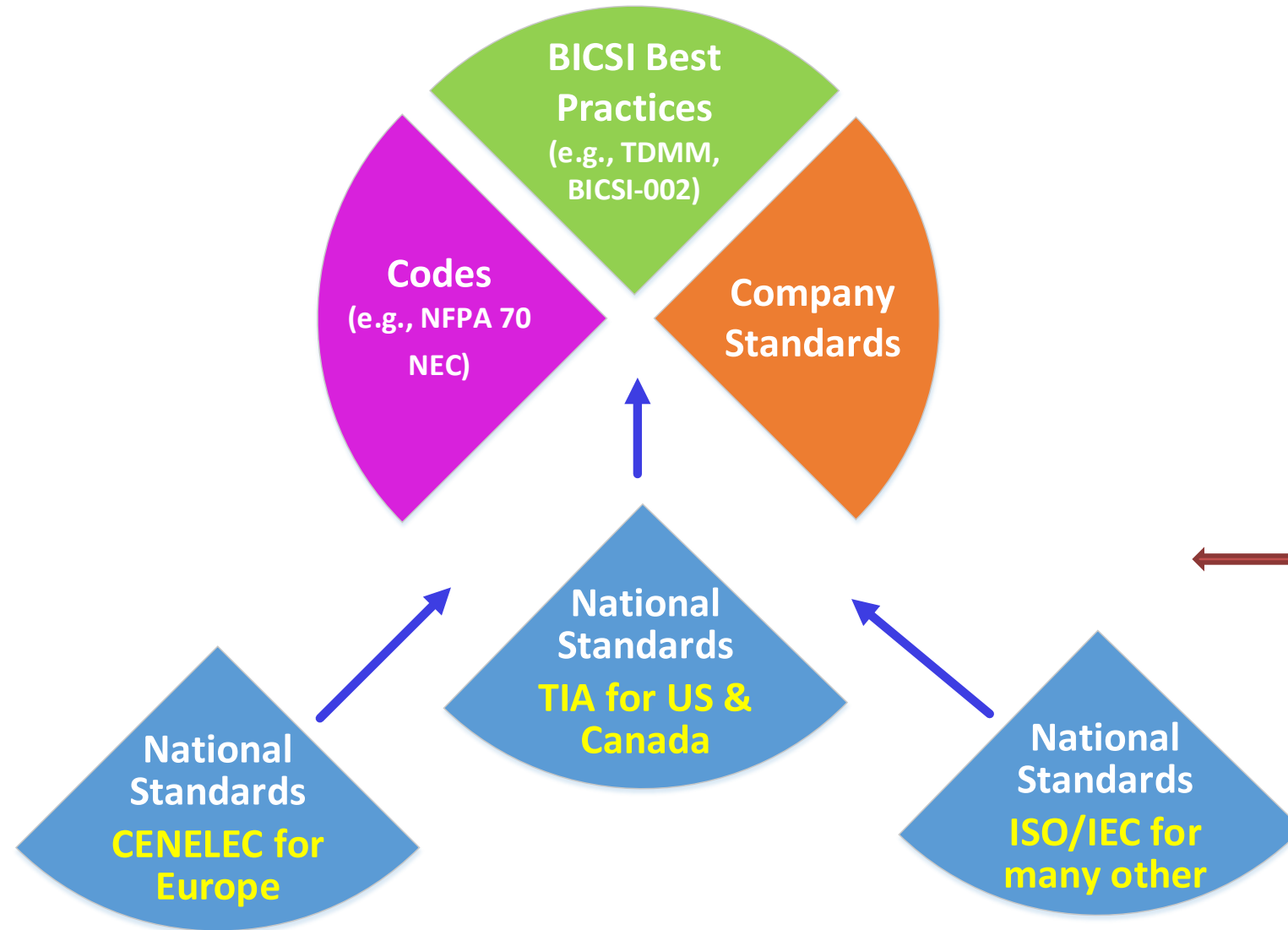

Example: BICSI-002 specifies to see national standard for mesh-bonding network design, temperature & humidity limits, telecom cabling design



BICSI-002 by design is intended to complement TIA-942 and other national data center standards, and is incomplete without them



## TIA-942 and BICSI-002

- TIA-942 provides requirements for the design of data center telecommunications infrastructure
- BICSI-002 provides a wide range of information, recommendations, and requirements regarding all aspects of designing a data center



# TIA-942 and BICSI-002

- BICSI-002 provides best practices that exceed the minimum requirements of TIA-942
- BICSI-002 provides information on a wide range of subjects not covered in TIA-942



# BICSI-002 Best Practices vs TIA-942 requirements

- Example: Ceiling heights
  - TIA-942
    - minimum height 2.6 m (8.5 ft)
  - BICSI-002
    - minimum height 3 m (10 ft)
    - Recommended height 4.5 m (15 ft) or greater

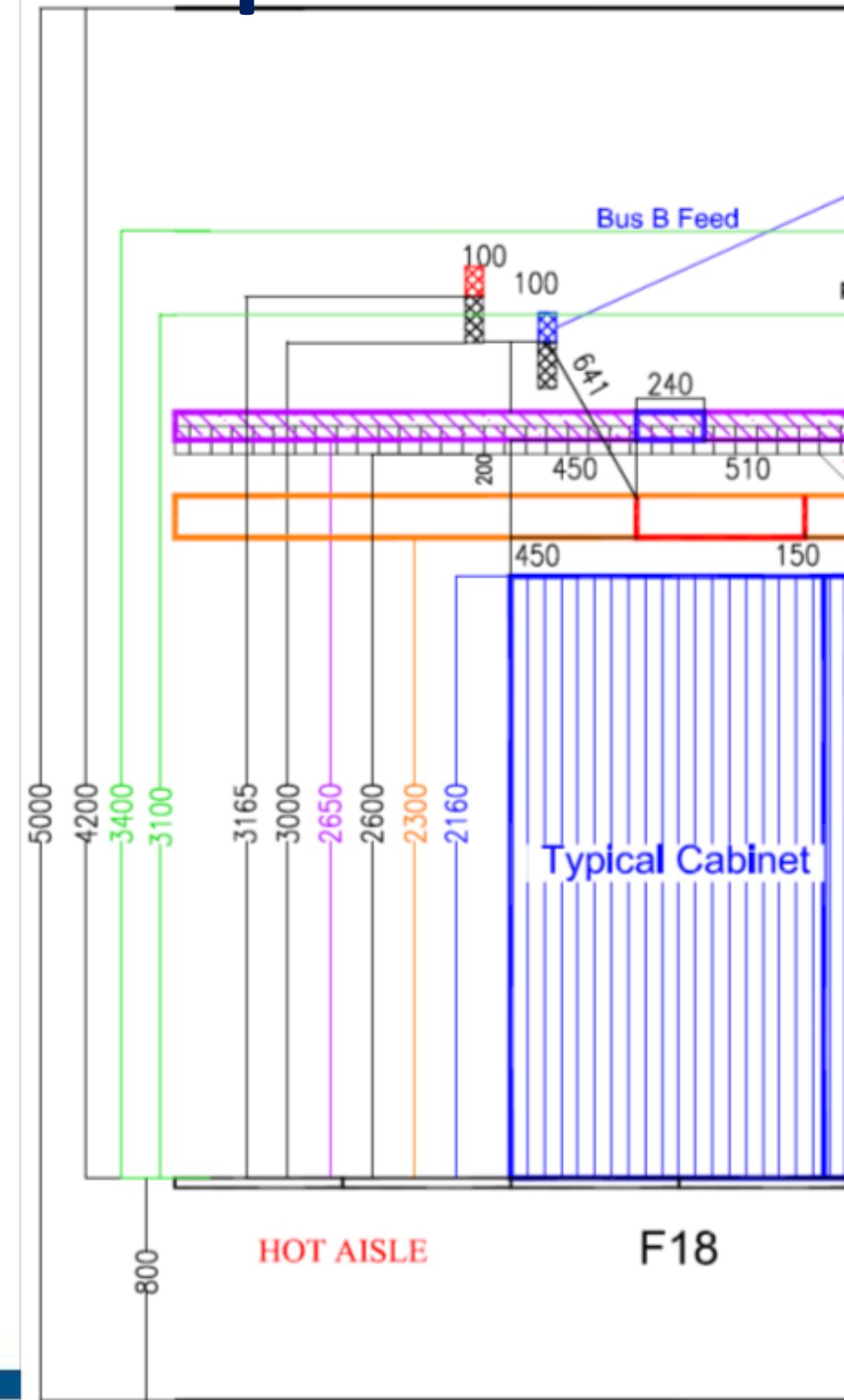

**BICSI-002 provides information on a wide range of subjects not covered in TIA-942**

## TIA-942-B & BICSI-002-2015

### Pages of Content

■ TIA-942-B ■ BICSI-002

Page

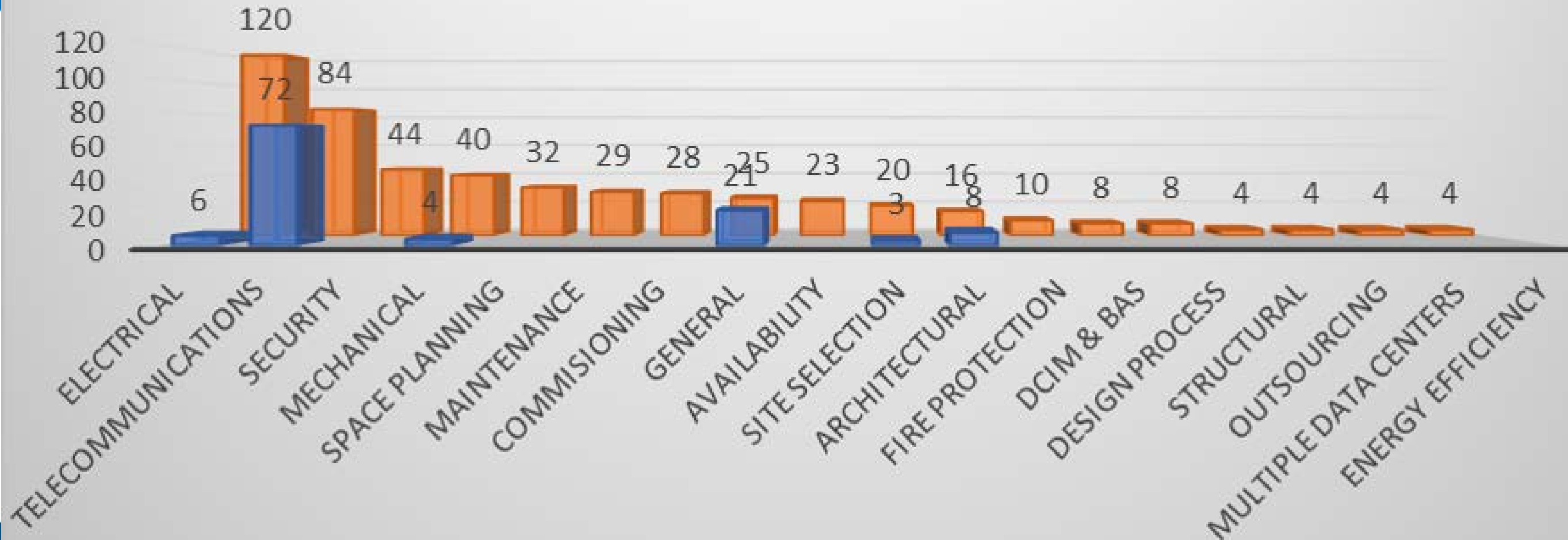





# BICSI-002 mostly deals with aspects of data center design other than telecom

BICSI-002	Pages
Electrical	120
Telecommunications	84
Security	44
Mechanical	40
Space Planning	32
Maintenance	29
Commissioning	28
General	25
Availability	23
Site Selection	20
Architectural	16
Fire Protection	10
DCIM & BAS	8
Design Process	8
Structural	4
Outsourcing	4
Multiple Data Centers	4
Energy Efficiency	4
TOTAL	503

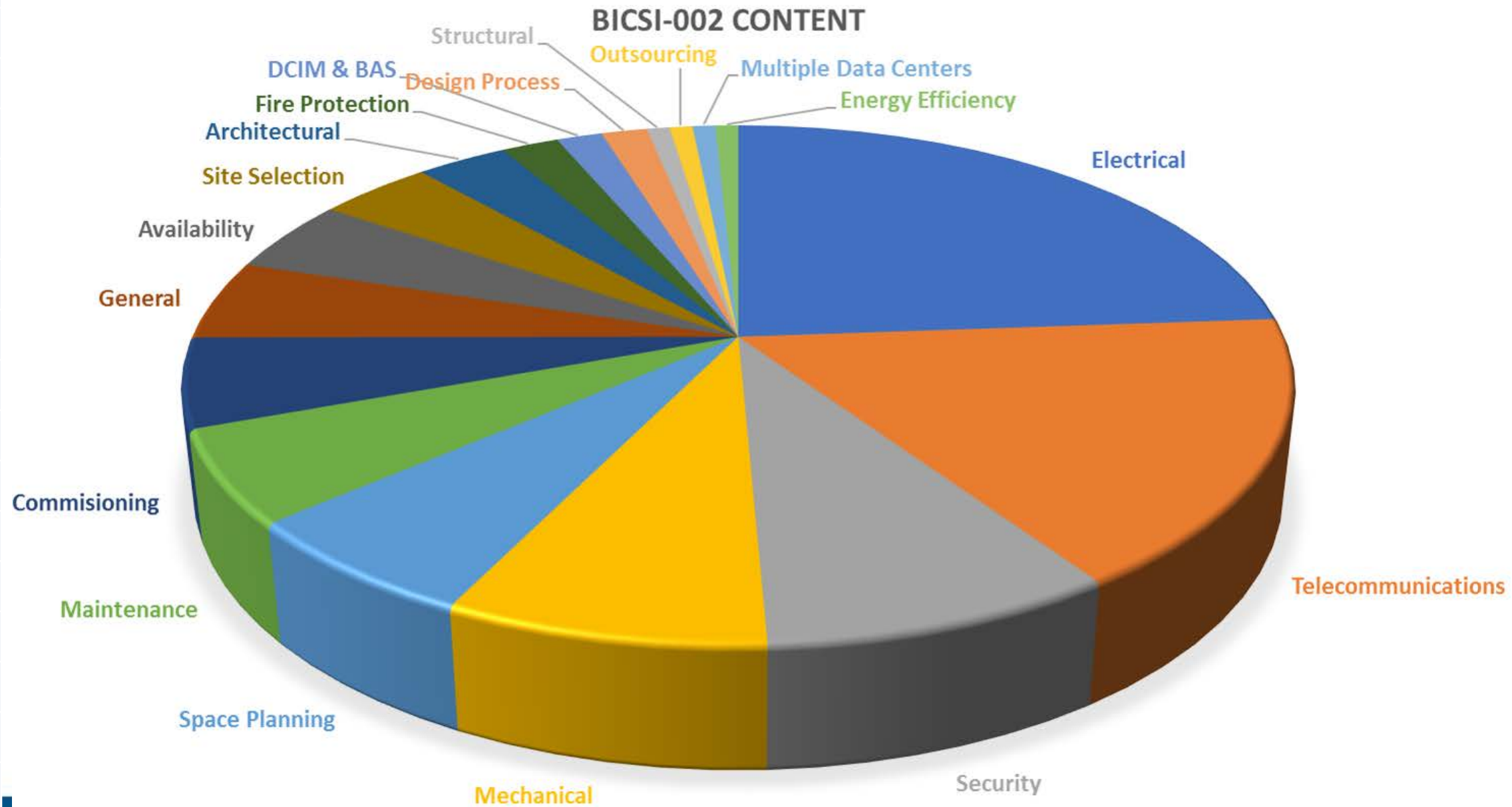



# Using BICSI-002 & TIA-942

- Design of the telecommunications cabling infrastructure (cabling system, pathways, spaces) should use both TIA-942-B and BICSI-002-2014
- Use BICSI-002 to understand other aspects of the data center design and make informed decisions when specifying requirements and reviewing designs by other disciplines



# DC Operations Standard

- New BICSI 009 Data Center Operations standard being developed
- Includes participants from a wide variety of organizations & countries
- Use as a reference for operation & maintenance of the data center after it is built





# DC Operations Standard Sections

- Governance
- Standard Operating Procedures
- Maintenance Procedures
- Emergency Operating Procedures
- Management





# ANSI/TIA-942 Telecommunications Infrastructure for Data Centers



# ANSI/TIA-942 Background

- ANSI/TIA-942, originally published in April 2005, was the first standard developed by an accredited standards organization that specifically addressed physical data center infrastructure
- TIA-942 was developed by experts mostly from the US and Canada, but it also included experts from other countries
- Contributions from many organizations in the data center industry that normally don't participate in TIA standards
- Continuously updated to accommodate changes in technologies and practices



# What is In TIA-942?

- Cabling scheme topology – hierarchical tree with elements added for redundancy
- Types of cabling (balanced twisted-pair, multimode fiber, single-mode fiber, T3/E3 coaxial cable, broadband coaxial cable)
- Cable lengths (dependent on media & applications)
- Telecommunications pathways – cable trays, conduit, optical fiber duct, etc.
- Cabling system distributors (main, intermediate, horizontal)



# What is In TIA-942?

- Requirements for computer rooms and entrance rooms (e.g., door sizes, lighting, temperature, humidity, floor loading)
- Supporting circuits (T3, E3, T1, E1, TIA-232 & TIA-561 serial console, and data center fabrics)
- Energy efficiency considerations
- Access providers (demarcation, information to provide to carriers, information that carriers should provide to data center designer)
- Site selection considerations





# What is In TIA-942?

- Informative Annex on Rating of data center availability (similar to Tiers and BICSI Classes)
  - Telecommunications Infrastructure
  - Architectural
  - Security
  - Structural
  - Electrical
  - Mechanical



# TIA-942 Revisions and Addenda

- **ANSI/TIA-942 Addendum 1** - Data Center Coaxial Cabling Specifications and Application Distances, March 2008,
- **ANSI/TIA-942 Addendum 2** - Additional Guidelines for Data Centers, February 2010, Harmonized with 2008 ASHRAE Environmental Guidelines for Datacom Equipment and several other updates
- **ANSI/TIA-942-A - Aug 2012** - Major modification to TIA-942 to incorporate new technologies and data center practices
- **ANSI/TIA-942-B – June 2017-** additional updates to incorporate new technologies and practices



# Updates in TIA-942-B

- Added **MPO-16 and MPO-32** (ANSI/TIA-604-18) and **MPO-24** (ANSI/TIA-604-5) as options for termination of more than two fibers in addition to the MPO-12 connector
- Added **category 8** as an allowed type of balanced twisted-pair cable. Changed recommendation for **category 6A balanced twisted-pair cable to category 6A or higher**
- Added **OM5 wideband laser-optimized 50/125 um multimode** as an allowed and recommended type of multimode fiber cable
- Added **75-ohm broadband coaxial cables and connectors** as specified in ANSI/TIA-568.4-D as allowed types of coaxial cables and connectors



# 12 & 32-fiber MPOs

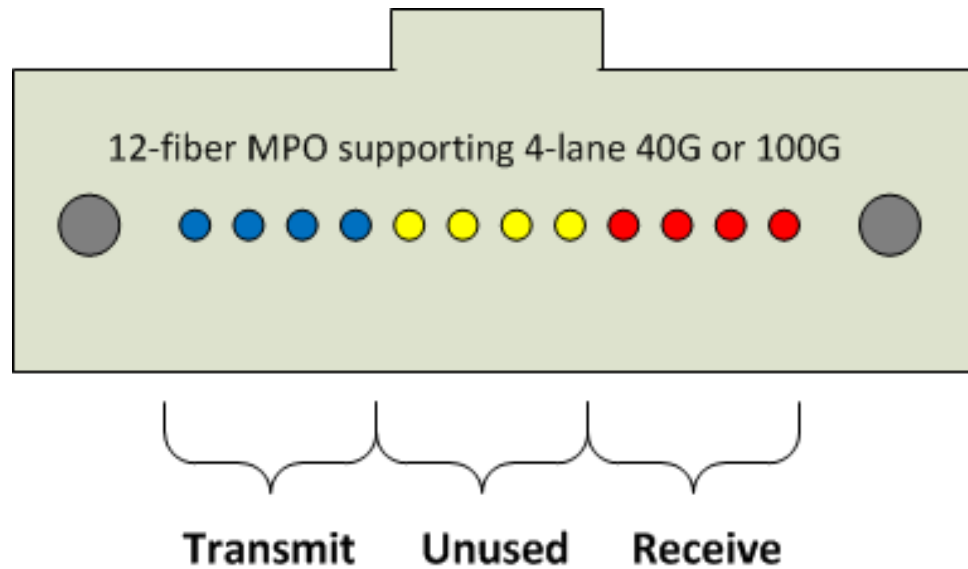

12-fiber MPO has 4 of 12 unused fibers for 40G and 100G

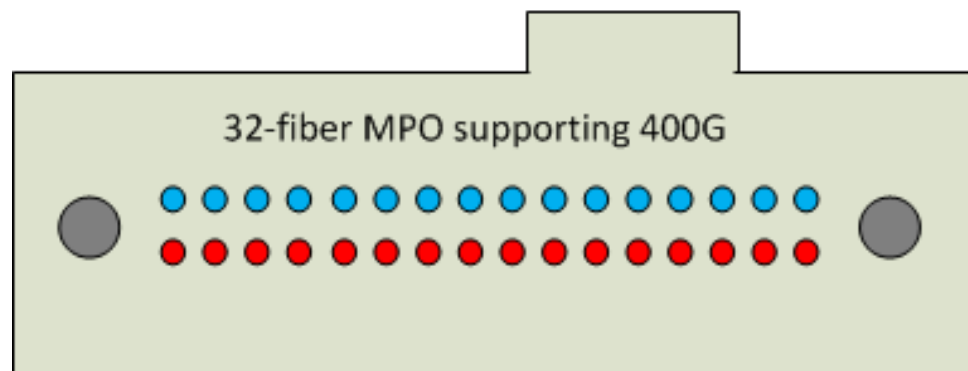

400GBASE-SR16 (400G Ethernet) will use 32-fiber MPO and waste no OM3/OM4 fibers



# Category 8 Balanced Twisted-Pair

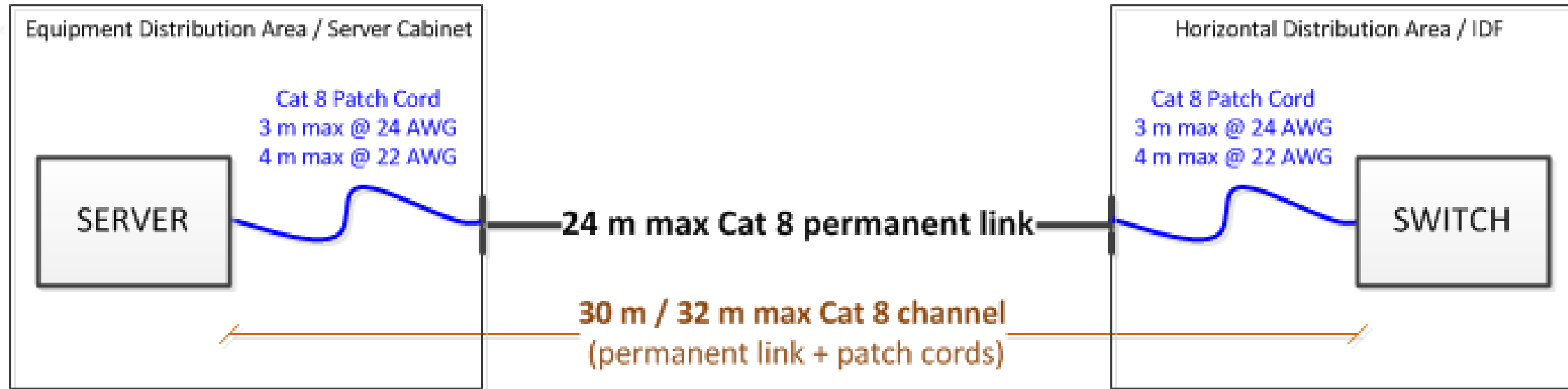

- 24 m max permanent link (panel-to-panel)
- 30 to 32 m channels (3 to 4 m patch cords depending on derating factor of cords)
- No intermediate patch panels



# OM5 Wideband multimode fiber

- OM5 or wideband multimode fiber recently approved in June 2016 as ANSI/TIA-492AAAE. OM5 name was approved by ISO/IEC in Oct 2016
- Supports 4 wavelengths in a single-pair of fibers allowing 40G or 100G Ethernet, which currently require 4-pairs of fibers, to run on a single pair
- TIA recently approved lime green as the color for OM5 jackets, connectors, and adapters

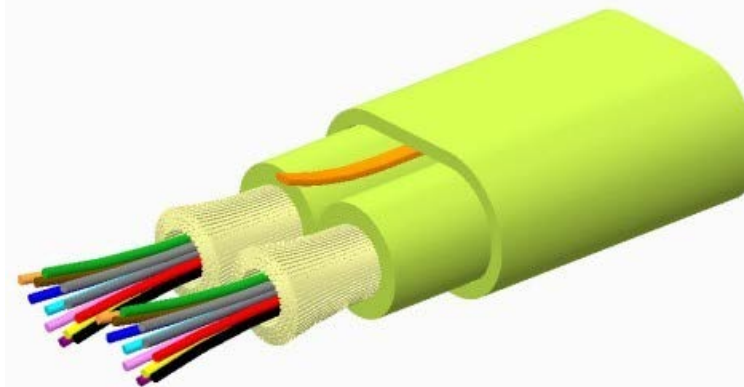



# Updates in TIA-942-B

- Added recommendation to **not install optical fiber cords and cables** (both bend insensitive and non-bend insensitive) without adequate armoring or sufficiently thick jacket in pathways that can create microbends, such as non-continuous cable supports, **wire basket trays, and cable ladders without radiused cable supports or solid bottoms.**





# Updates in TIA-942-B

- **Reduced quantity of convenience outlets required** on computer room walls (to one per wall minimum from previous minimum spacing of 12 ft apart)
- Local fire protection codes may be used instead of NFPA 75
- Power for air conditioning systems and controls in computer rooms and entrance rooms should be redundant, but do not need to be powered from the same PDUs or panel boards that serve ICT equipment in the room
- Added **recommendation that cabinets be at 1200 mm (48") deep and to consider cabinets wider than 600 mm (24") wide.**

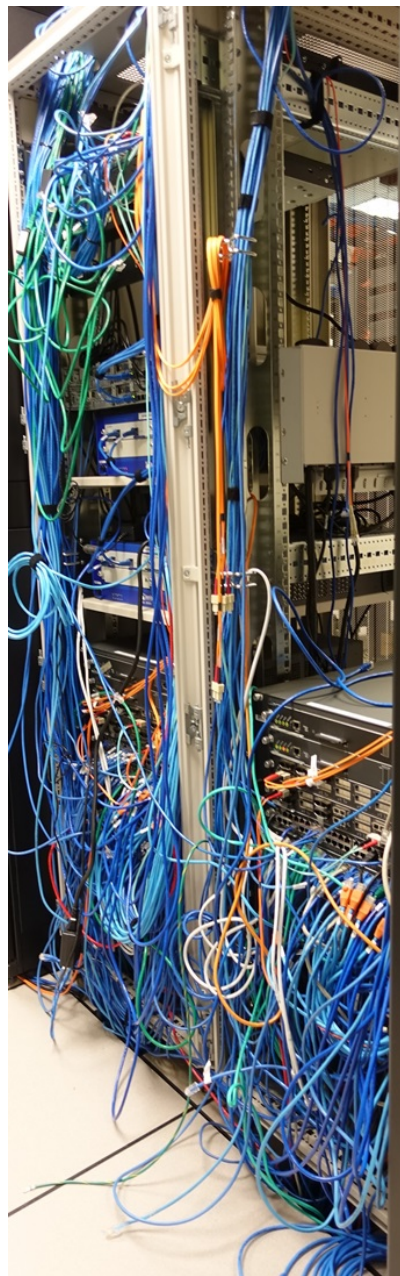





# Updates in TIA-942-B

- Recommended **maximum cable lengths for direct attach cabling in equipment distribution areas or EDAs (e.g., server cabinets) has been reduced from 10 m (33 ft) to 7 m (23 ft),** adequate from top-of-rack switch to servers in same or adjacent cabinet
- 7m maximum cable length doesn't apply to cabling within distributors (MDA, IDA, HDA, Entrance Room), however **direct attach cabling within distributors should be within a row.**

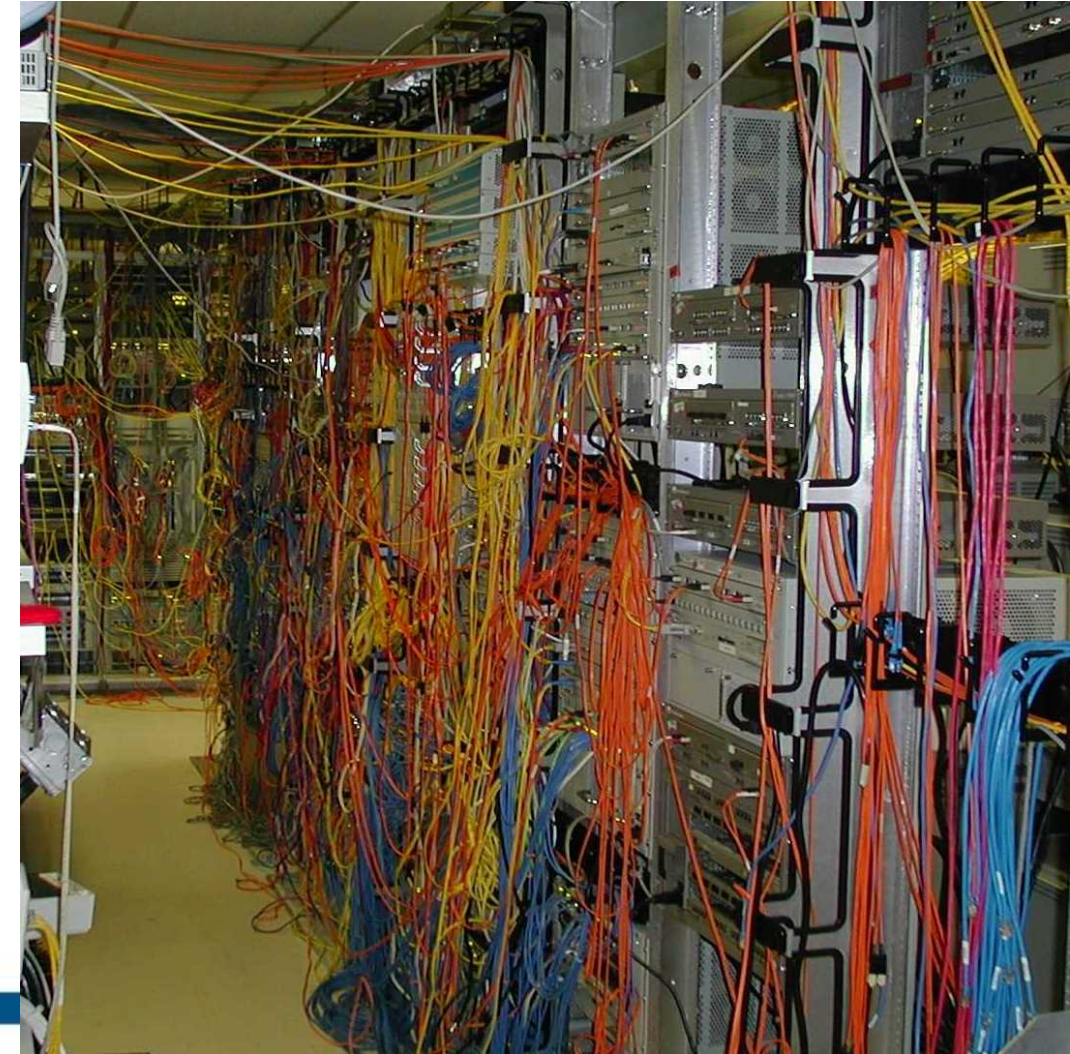
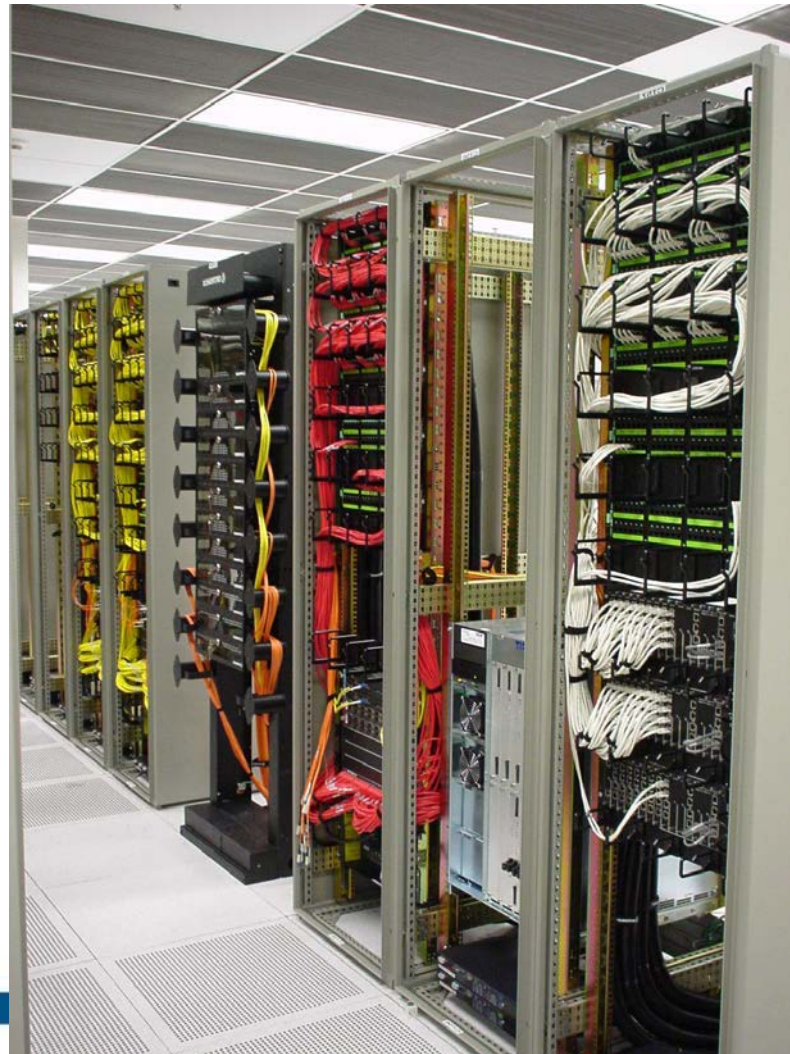



# Updates in TIA-942-B

- Added recommendation to **consider preterminated cabling** to reduce installation time and improve consistency and quality of terminations.





# Updates in TIA-942-B

- Added recommendation to consider needs for proper labeling, cable routing, cable management, and ability to insert and remove cords without disrupting existing or adjacent connections when selecting patch panels.





# Updates in TIA-942-B

- Adds normative **reference to ANSI/TIA-5017 regarding physical security** for the data center telecommunications infrastructure published Feb 2016
- Of interest to any designer concerned about enhanced physical security for telecommunications pathways & spaces
- Participants included persons involved in designing telecommunications infrastructure for classified military facilities, but information is useful to anyone concerned about physical security

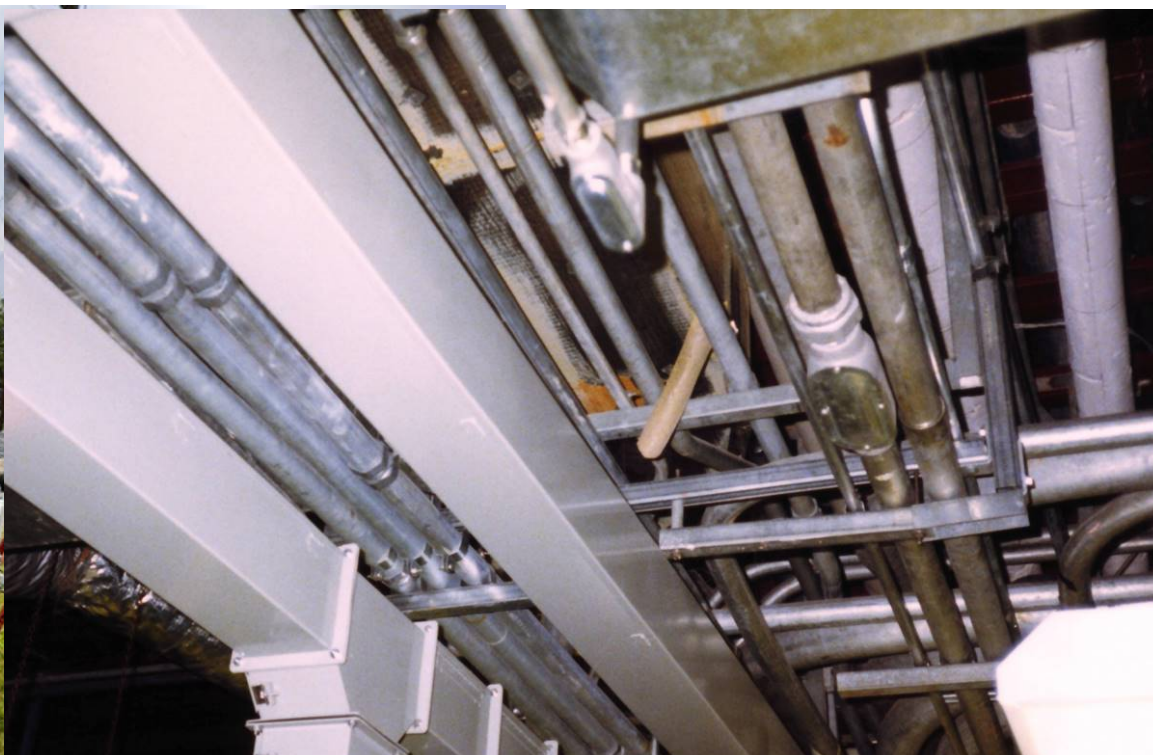



# Updates in TIA-942-B

- Adds normative **reference to ANSI/TIA-862-B for cabling for intelligent building systems** including networked data center electrical, mechanical, and security equipment (published Feb 2016)
- Provides guidelines for cabling of a wide range of intelligent building systems used in all types of buildings, especially in data centers (e.g., security, electrical, HVAC, energy management, lighting systems, wireless)

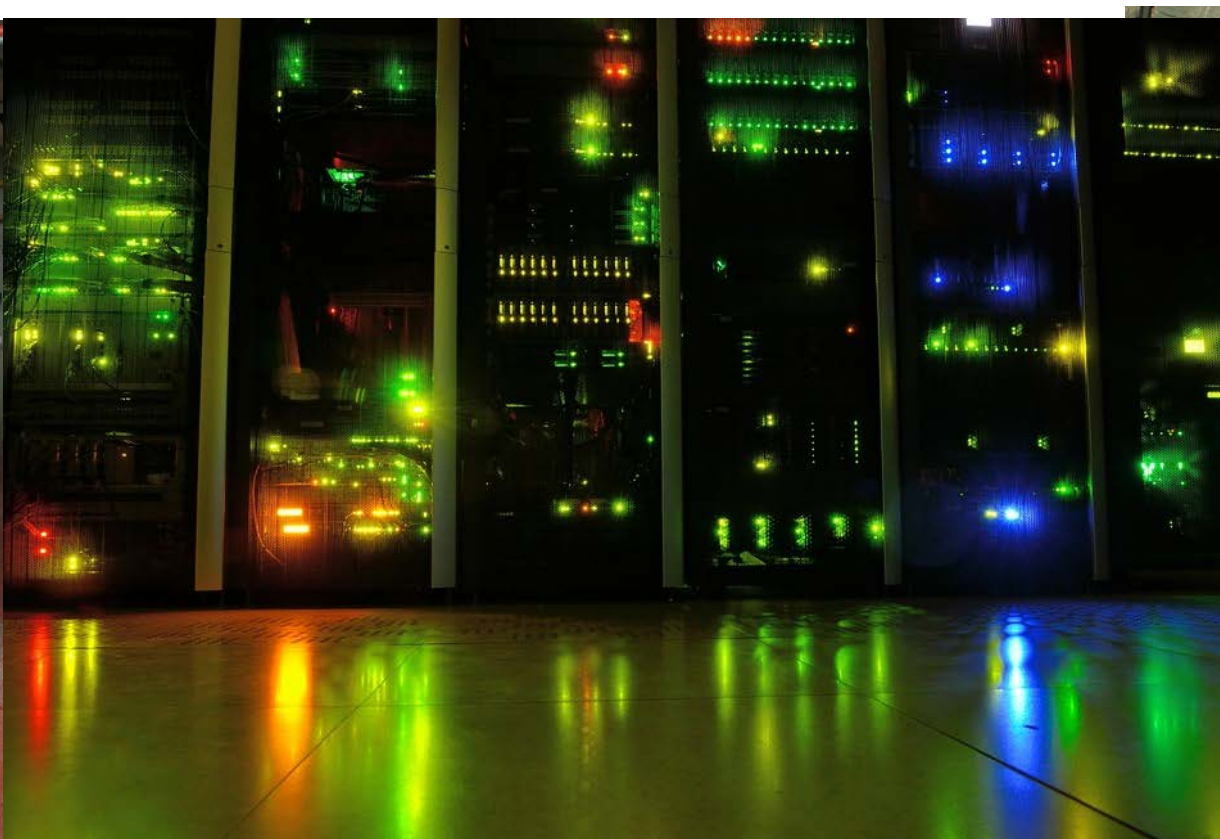



# Updates in TIA-942-B

- Added reference to **TIA TSB 162-A for guidelines regarding cabling for wireless access points** (published Nov 2013)
- Added reference to **TIA TSB-5018 for guidelines regarding cabling for DAS (distributed antenna systems)** published July 2016
- Added reference to **TIA TSB-184-A for guidelines regarding power delivery over balanced twisted-pair cabling** (published Mar 2017), which was updated to include higher power levels (1000 mA per pair) and refined temperature rise models
- **Numerous changes to the rating tables** in Annex F including those that specify concurrent maintainability for Rating-3 (formerly Tier 3) and fault tolerance for Rating-4 (formerly Tier 4).



# Updates in Referenced TIA-569-D Standard

- Incorporated revised temperature and humidity limits from ASHRAE Thermal Guidelines, 4<sup>th</sup> edition (which permits a **wider range of temperature & humidity** to reduce energy consumption)
- Changed **maximum 2.1 m (7 ft) maximum cabinet/rack height** from a **requirement to a recommendation** permitting use of taller cabinets/racks

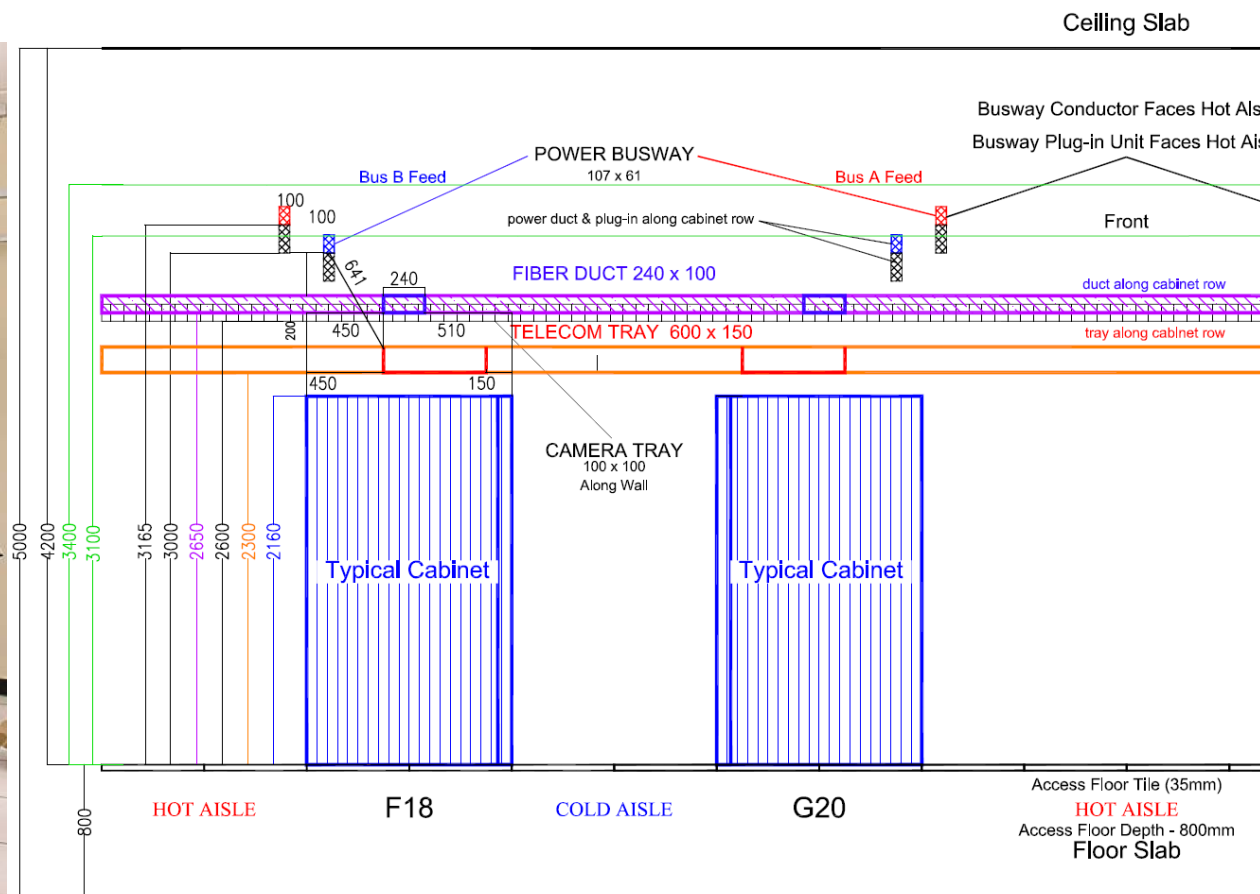



# Updates in Referenced TIA-569-D Standard

- Reduced minimum distance between top of cable tray and obstructions or cable tray above from 300 mm (12 in) to 200 mm (8 in) – impacts required ceiling heights or raised floor heights for stacked cable trays

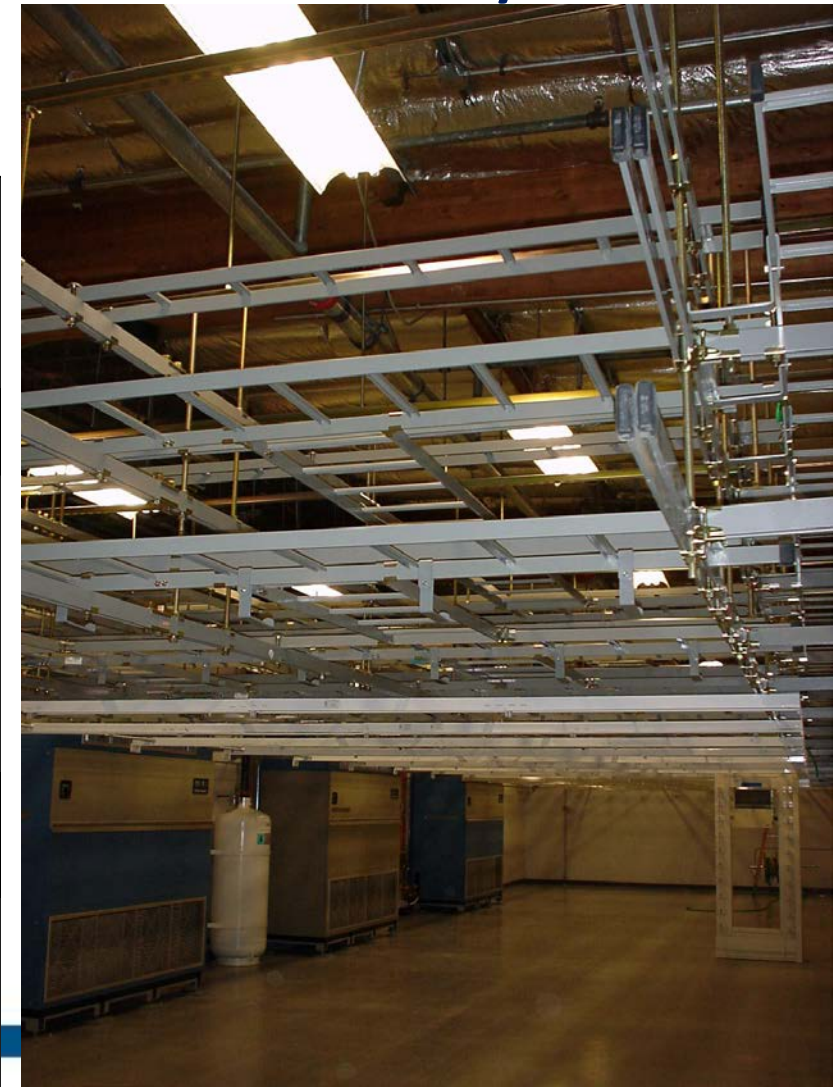
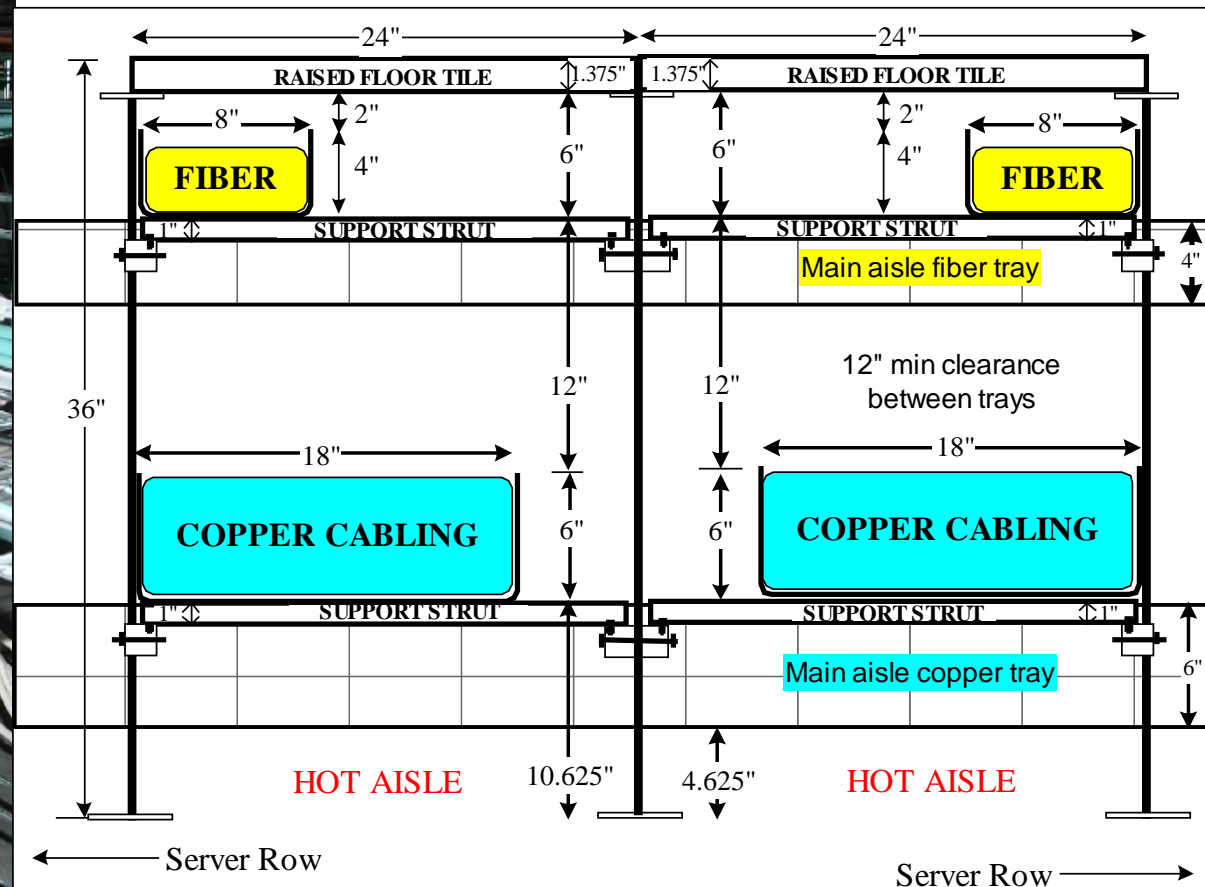





# Updates in Referenced TIA-607-C Standard

- Electrically continuous structural metal frame of the building may be used in place of a TBB (telecommunications bonding backbone)

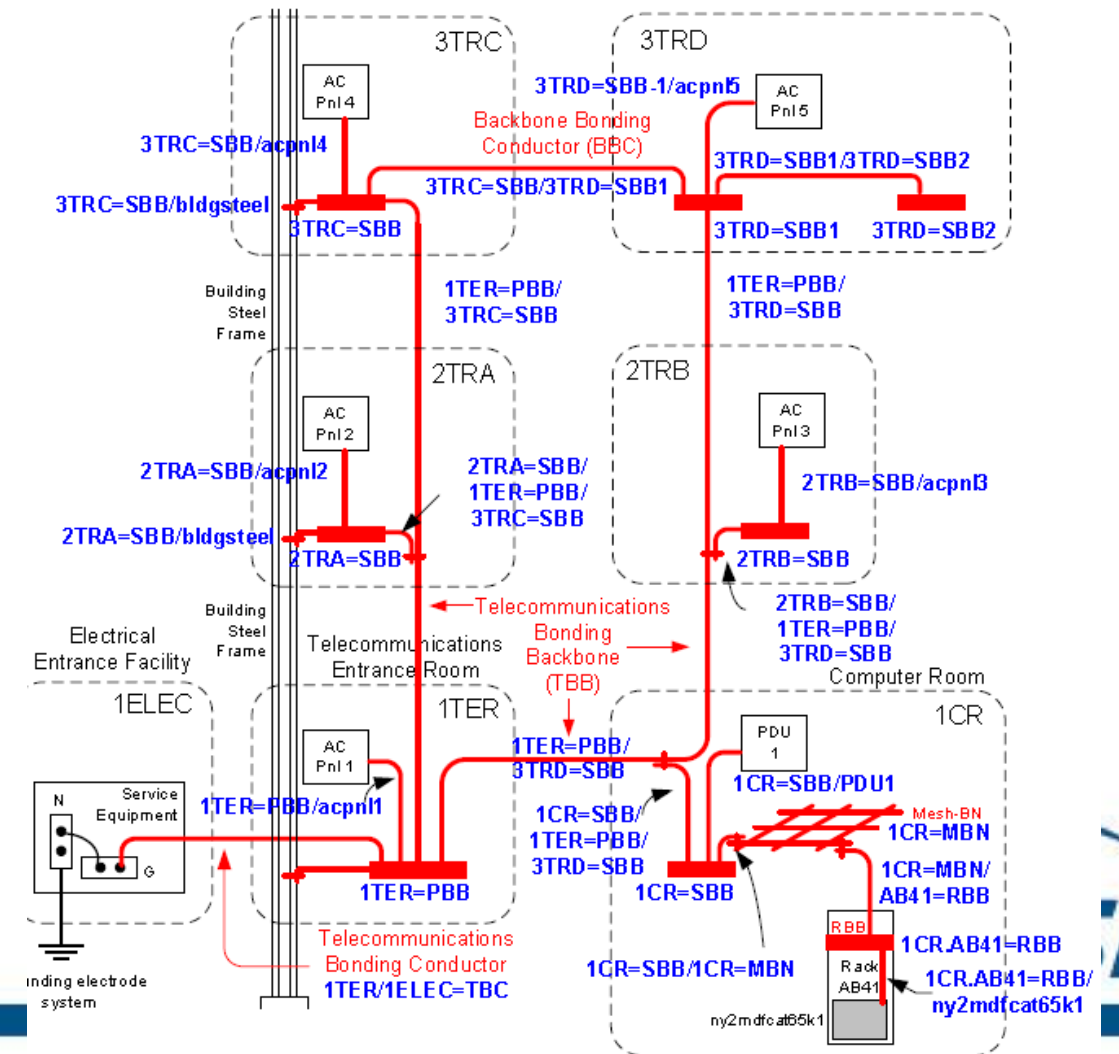



# Questions?

**Jonathan Jew** - President J&M Consultants, Inc.

Website: [www.j-and-m.com](http://www.j-and-m.com)

Email: [jew@j-and-m.com](mailto:jew@j-and-m.com)

Co-chair BICSI data center subcommittee

Editor TDMM 13<sup>th</sup> Edition Telecom Administration

Vice-Chair TIA TR-42.3 pathways & spaces

Vice-Chair USTAG to ISO/IEC JTC 1 SC 25 WG 3

Editor ISO/IEC TR 14763-2-1 telecom admin identifiers

SME BICSI TI&M Telecommunications Administration

Secretary TIA TR-42