

## Data sheet | Item number: 859-752

Optocoupler module; Nominal input voltage: 5 VDC; Output voltage range: 0 ... 24 VDC; Limiting continuous current: 0.5 A; Frequency: 10 kHz; gray

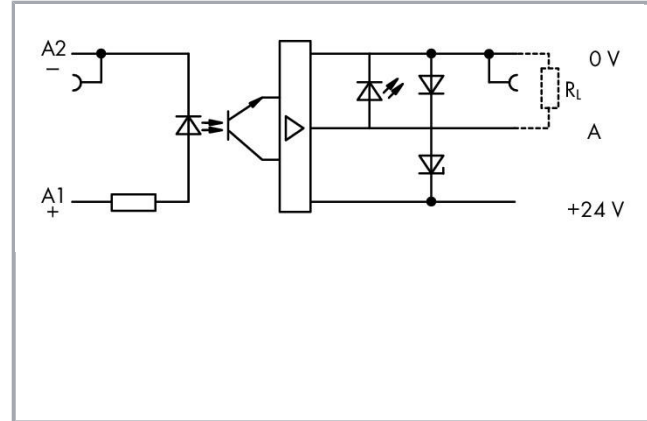

[www.wago.com/859-752](http://www.wago.com/859-752)

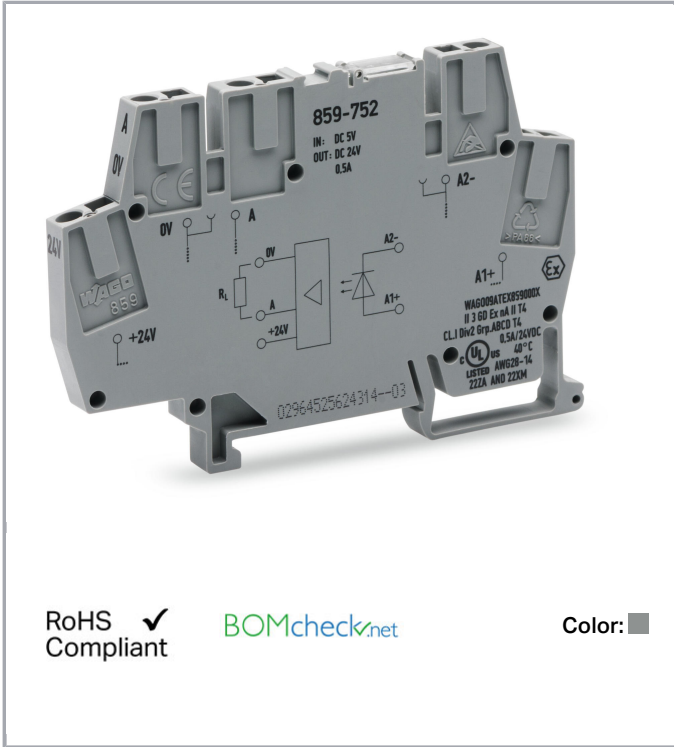

RoHS Compliant

Color:

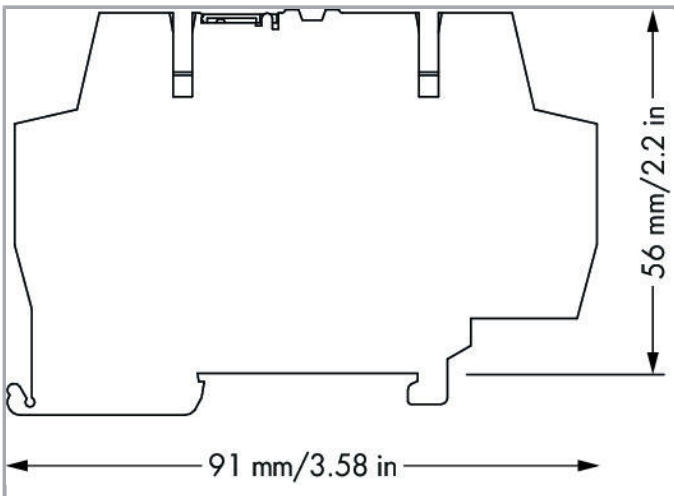

### Item description

#### Note:

Subject to changes. Please also observe the further product documentation!

WAGO Kontakttechnik GmbH & Co. KG  
Hansastr. 27  
32423 Minden  
Phone: +49571 887-0 | Fax: +49571 887-169  
Email: [info.de@wago.com](mailto:info.de@wago.com) | Web: [www.wago.com](http://www.wago.com)

Do you have any questions about our products?  
We are always happy to take your call at +49 (571) 887-44222.

Optocouplers and solid state relays are designed for use in signal processing networks, which are not supplied by the low-voltage power supply networks.

## Data

### Technical Data

#### Control circuit

Nominal input voltage $U_N$	DC 5 V
Input voltage range (low level)	DC 0 ... 1 V
Input voltage range (high level)	DC 4 ... 6 V
Nominal input current at $U_N$	10 mA

#### Load circuit:

Circuit type	3-wire connection High-side switching
Limiting continuous current	0,5 A
Nominal output voltage	DC 24 V
Output voltage range	DC 20 ... 30 V
Max. voltage drop at output	≤ DC 1,2 V
Leakage current at nominal voltage	≤ 10 μA
Max. output (reverse current)	12.5 mA
Turn-on time	≤ 15 μs
Drop-out time	≤ 30 μs
Switching frequency	≤ 10 kHz

#### Signaling

Status indication	Red LED
-------------------	---------

#### Safety and protection:

Rated voltage	300 V
Overvoltage category	II
Pollution degree	2
Dielectric strength, control/load circuit (AC, 1 min)	2,5 kVrms
Insulation type (control/load circuit)	Basic insulation
Insulation type (adjacent devices)	Reinforced insulation (safe isolation)

Subject to changes. Please also observe the further product documentation!



## Connection data

Connection technology	CAGE CLAMP®
Solid conductor	0,08 ... 2,5 mm <sup>2</sup> / 28 ... 14 AWG
Fine-stranded conductor	0,08 ... 2,5 mm <sup>2</sup> / 28 ... 14 AWG
Strip length	5 ... 6 mm / 0.2 ... 0.24 inch

## Geometrical Data

Width	6 mm / 0.236 inch
Height from upper-edge of DIN-35 rail	56 mm / 2.205 inch
Depth	91 mm / 3.583 inch

## Mechanical data

Type of mounting	DIN-35 rail
------------------	-------------

## Material Data

Color	gray
Fire load	0.313 MJ
Weight	18 g

## Environmental Requirements

Surrounding air (operating) temperature at U <sub>N</sub>	-25 ... 40 °C
Surrounding air (storage) temperature	-40 ... 70 °C
Processing temperature	-25 ... +50 °C

## Standards and specifications

Standards/specifications	EN 60664-1; EN 61000-6-2; EN 61000-6-3; EN 61373; UL 508
--------------------------	--

## Commercial data

Product Group	6 (Interface Electronics)
Packaging type	BOX
Country of origin	DE
GTIN	4055143605465
Customs Tariff No.	85365005000

Subject to changes. Please also observe the further product documentation!

WAGO Kontakttechnik GmbH & Co. KG  
 Hansastr. 27  
 32423 Minden  
 Phone: +49571 887-0 | Fax: +49571 887-169  
 Email: [info.de@wago.com](mailto:info.de@wago.com) | Web: [www.wago.com](http://www.wago.com)

Do you have any questions about our products?  
 We are always happy to take your call at +49 (571) 887-44222.

## Approvals / Certificates

### UL-Approvals

Logo	Approval	Additional Approval Text	Certificate name
	<b>UL</b> UL International Netherlands B.V. (ORDINARY LOCATIONS)	UL 508	E175199 Sec.4



## Counterpart

## Compatible products

### End plate

<b>Item no.: 859-525</b> End and intermediate plate; 1 mm thick; gray	<a href="http://www.wago.com/859-525">www.wago.com/859-525</a>
--	--

### ferrule

 <b>Item no.: 216-221</b> Ferrule; Sleeve for 0.5 mm <sup>2</sup> / 20 AWG; insulated; electro-tin plated; white	<a href="http://www.wago.com/216-221">www.wago.com/216-221</a>
<b>Item no.: 216-222</b> Ferrule; Sleeve for 0.75 mm <sup>2</sup> / 18 AWG; insulated; electro-tin plated; gray	<a href="http://www.wago.com/216-222">www.wago.com/216-222</a>
 <b>Item no.: 216-223</b> Ferrule; Sleeve for 1 mm <sup>2</sup> / AWG 18; insulated; electro-tin plated; red	<a href="http://www.wago.com/216-223">www.wago.com/216-223</a>
<b>Item no.: 216-224</b> Ferrule; Sleeve for 1.5 mm <sup>2</sup> / AWG 16; insulated; electro-tin plated; black	<a href="http://www.wago.com/216-224">www.wago.com/216-224</a>
<b>Item no.: 216-321</b> Ferrule; Sleeve for 0.25 mm <sup>2</sup> / AWG 24; insulated; electro-tin plated; yellow	<a href="http://www.wago.com/216-321">www.wago.com/216-321</a>
 <b>Item no.: 216-322</b> Ferrule; Sleeve for 0.34 mm <sup>2</sup> / 22 AWG; insulated; electro-tin plated; green	<a href="http://www.wago.com/216-322">www.wago.com/216-322</a>

### tools

<b>Item no.: 210-720</b> Operating tool; Blade: 3.5 x 0.5 mm; with a partially insulated shaft	<a href="http://www.wago.com/210-720">www.wago.com/210-720</a>
---	--

### Test Accessories

Subject to changes. Please also observe the further product documentation!

WAGO Kontakttechnik GmbH & Co. KG  
 Hansastr. 27  
 32423 Minden  
 Phone: +49571 887-0 | Fax: +49571 887-169  
 Email: [info.de@wago.com](mailto:info.de@wago.com) | Web: [www.wago.com](http://www.wago.com)

Do you have any questions about our products?  
 We are always happy to take your call at +49 (571) 887-44222.

Item no.: 859-500

Test pin; 1 mm Ø; with solder connection for test wire

[www.wago.com/859-500](http://www.wago.com/859-500)

---

**Marking accessories**

---

Item no.: 2009-145

Mini-WSB Inline; for Smart Printer; 1700 pieces on roll; stretchable 5 - 5.2 mm; plain; snap-on type; white

[www.wago.com/2009-145](http://www.wago.com/2009-145)

Item no.: 2009-145/000-002

Mini-WSB Inline; for Smart Printer; 1700 pieces on roll; stretchable 5 - 5.2 mm; plain; snap-on type; white /000-002

[www.wago.com/2009-145](http://www.wago.com/2009-145)

Item no.: 2009-145/000-005

Mini-WSB Inline; for Smart Printer; 1700 pieces on roll; stretchable 5 - 5.2 mm; plain; snap-on type; red

[www.wago.com/2009-145](http://www.wago.com/2009-145)  
/000-005

Item no.: 2009-145/000-006

Mini-WSB Inline; for Smart Printer; 1700 pieces on roll; stretchable 5 - 5.2 mm; plain; snap-on type; blue

[www.wago.com/2009-145](http://www.wago.com/2009-145)  
/000-006

Item no.: 2009-145/000-007

Mini-WSB Inline; for Smart Printer; 1700 pieces on roll; stretchable 5 - 5.2 mm; plain; snap-on type; white /000-007

[www.wago.com/2009-145](http://www.wago.com/2009-145)

Item no.: 2009-145/000-012

Mini-WSB Inline; for Smart Printer; 1700 pieces on roll; stretchable 5 - 5.2 mm; plain; snap-on type; orange

[www.wago.com/2009-145](http://www.wago.com/2009-145)  
/000-012

Item no.: 2009-145/000-023

Mini-WSB Inline; for Smart Printer; 1700 pieces on roll; stretchable 5 - 5.2 mm; plain; snap-on type; green

[www.wago.com/2009-145](http://www.wago.com/2009-145)  
/000-023

Item no.: 2009-145/000-024

Mini-WSB Inline; for Smart Printer; 1700 pieces on roll; stretchable 5 - 5.2 mm; plain; snap-on type; violet

[www.wago.com/2009-145](http://www.wago.com/2009-145)  
/000-024

Item no.: 210-110

Fiber-tip pen

[www.wago.com/210-110](http://www.wago.com/210-110)

Item no.: 248-501

Miniature WSB Quick marking system; plain; Marker width 5 mm; 10 strips with 10 markers per card

[www.wago.com/248-501](http://www.wago.com/248-501)

Item no.: 248-501/000-002

Mini-WSB marking card; as card; not stretchable; plain; snap-on type; yellow

[www.wago.com/248-501](http://www.wago.com/248-501)  
/000-002

Item no.: 248-501/000-005

Mini-WSB marking card; as card; not stretchable; plain; snap-on type; red

[www.wago.com/248-501](http://www.wago.com/248-501)  
/000-005

Item no.: 248-501/000-006

Mini-WSB marking card; as card; not stretchable; plain; snap-on type; blue

[www.wago.com/248-501](http://www.wago.com/248-501)  
/000-006

Subject to changes. Please also observe the further product documentation!

WAGO Kontakttechnik GmbH &amp; Co. KG

Hansastr. 27





32423 Minden

Phone: +49571 887-0 | Fax: +49571 887-169

Email: [info.de@wago.com](mailto:info.de@wago.com) | Web: [www.wago.com](http://www.wago.com)

Do you have any questions about our products?

We are always happy to take your call at +49 (571) 887-44222.

	<b>Item no.: 248-501/000-007</b> Mini-WSB marking card; as card; not stretchable; plain; snap-on type; gray	<a href="http://www.wago.com/248-501/000-007">www.wago.com/248-501/000-007</a>
	<b>Item no.: 248-501/000-012</b> Mini-WSB marking card; as card; not stretchable; plain; snap-on type; orange	<a href="http://www.wago.com/248-501/000-012">www.wago.com/248-501/000-012</a>
	<b>Item no.: 248-501/000-017</b> Mini-WSB marking card; as card; not stretchable; plain; snap-on type; light green	<a href="http://www.wago.com/248-501/000-017">www.wago.com/248-501/000-017</a>
	<b>Item no.: 248-501/000-023</b> Mini-WSB marking card; as card; not stretchable; plain; snap-on type; green	<a href="http://www.wago.com/248-501/000-023">www.wago.com/248-501/000-023</a>
	<b>Item no.: 248-501/000-024</b> Mini-WSB marking card; as card; not stretchable; plain; snap-on type; violet	<a href="http://www.wago.com/248-501/000-024">www.wago.com/248-501/000-024</a>
	<b>Item no.: 248-502</b> Mini-WSB marking card; as card; MARKED; 1 ... 10 (10x); not stretchable; Horizontal marking; snap-on type; white	<a href="http://www.wago.com/248-502">www.wago.com/248-502</a>
	<b>Item no.: 248-502/000-024</b> Mini-WSB marking card; as card; MARKED; 1 ... 10 (10x); not stretchable; Horizontal marking; snap-on type; violet	<a href="http://www.wago.com/248-502/000-024">www.wago.com/248-502/000-024</a>
	<b>Item no.: 248-503</b> Mini-WSB marking card; as card; MARKED; 11 ... 20 (10x); not stretchable; Horizontal marking; snap-on type; white	<a href="http://www.wago.com/248-503">www.wago.com/248-503</a>
	<b>Item no.: 248-503/000-024</b> Mini-WSB marking card; as card; MARKED; 11 ... 20 (10x); not stretchable; Horizontal marking; snap-on type; violet	<a href="http://www.wago.com/248-503/000-024">www.wago.com/248-503/000-024</a>
	<b>Item no.: 248-504</b> Mini-WSB marking card; as card; MARKED; 21 ... 30 (10x); not stretchable; Horizontal marking; snap-on type; white	<a href="http://www.wago.com/248-504">www.wago.com/248-504</a>
	<b>Item no.: 248-504/000-024</b> Mini-WSB marking card; as card; MARKED; 21 ... 30 (10x); not stretchable; Horizontal marking; snap-on type; violet	<a href="http://www.wago.com/248-504/000-024">www.wago.com/248-504/000-024</a>
	<b>Item no.: 248-505/000-024</b> Mini-WSB marking card; as card; MARKED; 31 ... 40 (10x); not stretchable; Horizontal marking; snap-on type; violet	<a href="http://www.wago.com/248-505/000-024">www.wago.com/248-505/000-024</a>
	<b>Item no.: 248-506</b> Mini-WSB marking card; as card; MARKED; 41 ... 50 (10x); not stretchable; Horizontal marking; snap-on type; white	<a href="http://www.wago.com/248-506">www.wago.com/248-506</a>
<b>Jumper</b>		
	<b>Item no.: 859-402</b> Push-in type jumper bar; 2-way; Nominal current 18 A; insulated; light gray	<a href="http://www.wago.com/859-402">www.wago.com/859-402</a>

Subject to changes. Please also observe the further product documentation!



**Item no.: 859-402/000-005**  
Push-in type jumper bar; 2-way; Nominal current 18 A; insulated; red

[www.wago.com/859-402/000-005](http://www.wago.com/859-402/000-005)



**Item no.: 859-402/000-006**  
Push-in type jumper bar; 2-way; Nominal current 18 A; insulated; blue

[www.wago.com/859-402/000-006](http://www.wago.com/859-402/000-006)



**Item no.: 859-402/000-029**  
Push-in type jumper bar; 2-way; Nominal current 18 A; insulated; yellow

[www.wago.com/859-402/000-029](http://www.wago.com/859-402/000-029)



**Item no.: 859-403**  
Push-in type jumper bar; 3-way; Nominal current 18 A; insulated; light gray

[www.wago.com/859-403](http://www.wago.com/859-403)



**Item no.: 859-403/000-005**  
Push-in type jumper bar; 3-way; Nominal current 18 A; insulated; red

[www.wago.com/859-403/000-005](http://www.wago.com/859-403/000-005)



**Item no.: 859-403/000-006**  
Push-in type jumper bar; 3-way; Nominal current 18 A; insulated; blue

[www.wago.com/859-403/000-006](http://www.wago.com/859-403/000-006)



**Item no.: 859-403/000-029**  
Push-in type jumper bar; 3-way; Nominal current 18 A; insulated; yellow

[www.wago.com/859-403/000-029](http://www.wago.com/859-403/000-029)



**Item no.: 859-404**  
Push-in type jumper bar; 4-way; Nominal current 18 A; insulated; light gray

[www.wago.com/859-404](http://www.wago.com/859-404)

**Item no.: 859-404/000-005**  
Push-in type jumper bar; 4-way; Nominal current 18 A; insulated; red

[www.wago.com/859-404/000-005](http://www.wago.com/859-404/000-005)

**Item no.: 859-404/000-006**  
Push-in type jumper bar; 4-way; Nominal current 18 A; insulated; blue

[www.wago.com/859-404/000-006](http://www.wago.com/859-404/000-006)

**Item no.: 859-404/000-029**  
Push-in type jumper bar; 4-way; Nominal current 18 A; insulated; yellow

[www.wago.com/859-404/000-029](http://www.wago.com/859-404/000-029)

**Item no.: 859-405**  
Push-in type jumper bar; 5-way; Nominal current 18 A; insulated; light gray

[www.wago.com/859-405](http://www.wago.com/859-405)









**Item no.: 859-405/000-005**  
Push-in type jumper bar; 5-way; Nominal current 18 A; insulated; red

[www.wago.com/859-405/000-005](http://www.wago.com/859-405/000-005)

**Item no.: 859-405/000-006**  
Push-in type jumper bar; 5-way; Nominal current 18 A; insulated; blue

[www.wago.com/859-405/000-006](http://www.wago.com/859-405/000-006)

Subject to changes. Please also observe the further product documentation!

	<b>Item no.: 859-405/000-029</b> Push-in type jumper bar; 5-way; Nominal current 18 A; insulated; yellow	<a href="http://www.wago.com/859-405/000-029">www.wago.com/859-405/000-029</a>
	<b>Item no.: 859-406</b> Push-in type jumper bar; 6-way; Nominal current 18 A; insulated; light gray	<a href="http://www.wago.com/859-406">www.wago.com/859-406</a>
	<b>Item no.: 859-406/000-005</b> Push-in type jumper bar; 6-way; Nominal current 18 A; insulated; red	<a href="http://www.wago.com/859-406/000-005">www.wago.com/859-406/000-005</a>
	<b>Item no.: 859-406/000-006</b> Push-in type jumper bar; 6-way; Nominal current 18 A; insulated; blue	<a href="http://www.wago.com/859-406/000-006">www.wago.com/859-406/000-006</a>
	<b>Item no.: 859-406/000-029</b> Push-in type jumper bar; 6-way; Nominal current 18 A; insulated; yellow	<a href="http://www.wago.com/859-406/000-029">www.wago.com/859-406/000-029</a>
	<b>Item no.: 859-407</b> Push-in type jumper bar; 7-way; Nominal current 18 A; insulated; light gray	<a href="http://www.wago.com/859-407">www.wago.com/859-407</a>
	<b>Item no.: 859-407/000-005</b> Push-in type jumper bar; 7-way; Nominal current 18 A; insulated; red	<a href="http://www.wago.com/859-407/000-005">www.wago.com/859-407/000-005</a>
	<b>Item no.: 859-407/000-006</b> Push-in type jumper bar; 7-way; Nominal current 18 A; insulated; blue	<a href="http://www.wago.com/859-407/000-006">www.wago.com/859-407/000-006</a>
	<b>Item no.: 859-407/000-029</b> Push-in type jumper bar; 7-way; Nominal current 18 A; insulated; yellow	<a href="http://www.wago.com/859-407/000-029">www.wago.com/859-407/000-029</a>
	<b>Item no.: 859-408</b> Push-in type jumper bar; 8-way; Nominal current 18 A; insulated; light gray	<a href="http://www.wago.com/859-408">www.wago.com/859-408</a>
	<b>Item no.: 859-408/000-005</b> Push-in type jumper bar; 8-way; Nominal current 18 A; insulated; red	<a href="http://www.wago.com/859-408/000-005">www.wago.com/859-408/000-005</a>
	<b>Item no.: 859-408/000-006</b> Push-in type jumper bar; 8-way; Nominal current 18 A; insulated; blue	<a href="http://www.wago.com/859-408/000-006">www.wago.com/859-408/000-006</a>
	<b>Item no.: 859-408/000-029</b> Push-in type jumper bar; 8-way; Nominal current 18 A; insulated; yellow	<a href="http://www.wago.com/859-408/000-029">www.wago.com/859-408/000-029</a>
	<b>Item no.: 859-409</b> Push-in type jumper bar; 9-way; Nominal current 18 A; insulated; light gray	<a href="http://www.wago.com/859-409">www.wago.com/859-409</a>

Subject to changes. Please also observe the further product documentation!





Item no.: 859-409/000-005

Push-in type jumper bar; 9-way; Nominal current 18 A; insulated; red

[www.wago.com/859-409/000-005](http://www.wago.com/859-409/000-005)



Item no.: 859-409/000-006

Push-in type jumper bar; 9-way; Nominal current 18 A; insulated; blue

[www.wago.com/859-409/000-006](http://www.wago.com/859-409/000-006)



Item no.: 859-409/000-029

Push-in type jumper bar; 9-way; Nominal current 18 A; insulated; yellow

[www.wago.com/859-409/000-029](http://www.wago.com/859-409/000-029)



Item no.: 859-410

Push-in type jumper bar; 10-way; Nominal current 18 A; insulated; light gray

[www.wago.com/859-410](http://www.wago.com/859-410)

Item no.: 859-410/000-005

Push-in type jumper bar; 10-way; Nominal current 18 A; insulated; red

[www.wago.com/859-410/000-005](http://www.wago.com/859-410/000-005)

Item no.: 859-410/000-006

Push-in type jumper bar; 10-way; Nominal current 18 A; insulated; blue

[www.wago.com/859-410/000-006](http://www.wago.com/859-410/000-006)

Item no.: 859-410/000-029

Push-in type jumper bar; 10-way; Nominal current 18 A; insulated; yellow

[www.wago.com/859-410/000-029](http://www.wago.com/859-410/000-029)

## Downloads

### Documentation

#### Instruction Leaflet

Relay modules, Optocoupler modules	V 1.2.0 Aug 30, 2019	pdf 2.2 MB	Download
------------------------------------	-------------------------	---------------	----------

#### Additional Information

Disposal; Electrical and electronic equipment, Packaging	V 1.0.0	pdf 265.8 kB	Download
--	---------	-----------------	----------

## CAD/CAE-Data

### CAD data

2D/3D Models 859-752	URL	Download
----------------------	-----	----------

### CAE data

EPLAN Data Portal 859-752

Subject to changes. Please also observe the further product documentation!

WAGO Kontakttechnik GmbH & Co. KG  
 Hansastr. 27  
 32423 Minden  
 Phone: +49571 887-0 | Fax: +49571 887-169  
 Email: [info.de@wago.com](mailto:info.de@wago.com) | Web: [www.wago.com](http://www.wago.com)

Do you have any questions about our products?  
 We are always happy to take your call at +49 (571) 887-44222.

## Installation Notes

### Inserting a conductor

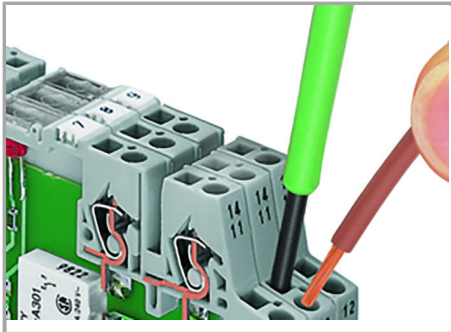

Connection of conductor

### Jumpered

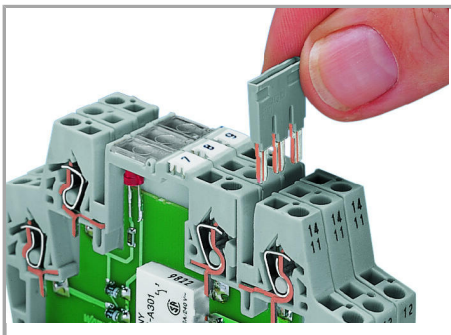

Easy commoning using adjacent jumpers

### Marking

Subject to changes. Please also observe the further product documentation!

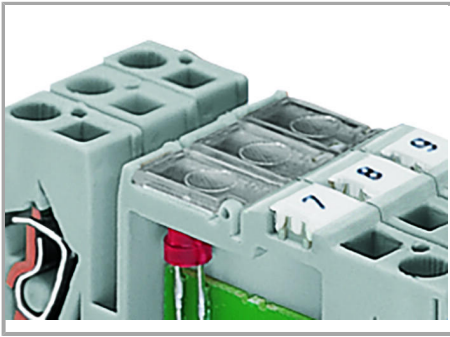

Marking using miniature WSB quick marking card

Subject to changes. Please also observe the further product documentation!