

Date: **June 02, 2021**



Crown Castle  
2000 Corporate Drive  
Canonsburg, PA 15317  
(724) 416-2000

**Subject:** **Structural Analysis Report**

**Carrier Designation:** **DISH Network Co-Locate**  
**Site Number:** BOBDL00083A  
**Site Name:** CT-CCI-T-876331

**Crown Castle Designation:** **BU Number:** 876331  
**Site Name:** NEW BRITAIN GRAVEL PIT  
**JDE Job Number:** 650073  
**Work Order Number:** 1966745  
**Order Number:** 556610 Rev. 0

**Engineering Firm Designation:** **Crown Castle Project Number:** 1966745

**Site Data:** **115 North Mountain Rd, NEW BRITAIN, Hartford County, CT**  
**Latitude 41° 40' 35.72", Longitude -72° 49' 17.09"**  
**118 Foot - Monopole Tower**

Crown Castle is pleased to submit this "**Structural Analysis Report**" to determine the structural integrity of the above-mentioned tower.

The purpose of the analysis is to determine acceptability of the tower stress level. Based on our analysis we have determined the tower stress level for the structure and foundation, under the following load case, to be:

LC7: Proposed Equipment Configuration

**Sufficient Capacity**

This analysis utilizes an ultimate 3-second gust wind speed of 125 mph as required by the 2018 Connecticut State Building Code (2015 IBC). Applicable Standard references and design criteria are listed in Section 2 - "Analysis Criteria".

Structural analysis prepared by: Kayla Weimert

Respectfully submitted by:

Maham Barimani, P.E.  
Senior Project Engineer

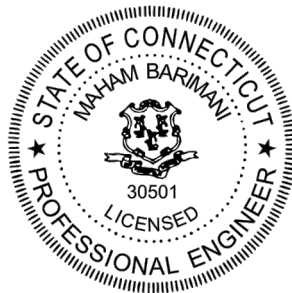

## TABLE OF CONTENTS

### 1) INTRODUCTION

### 2) ANALYSIS CRITERIA

Table 1 - Proposed Equipment Configuration

Table 2 - Other Considered Equipment

### 3) ANALYSIS PROCEDURE

Table 3 - Documents Provided

3.1) Analysis Method

3.2) Assumptions

### 4) ANALYSIS RESULTS

Table 4 - Section Capacity (Summary)

Table 5 - Tower Component Stresses vs. Capacity - LC7

4.1) Recommendations

### 5) APPENDIX A

tnxTower Output

### 6) APPENDIX B

Base Level Drawing

### 7) APPENDIX C

Additional Calculations

## 1) INTRODUCTION

This tower is a 118 ft Monopole tower designed by ROHN. The tower has been modified multiple times to accommodate additional loading.

## 2) ANALYSIS CRITERIA

<b>TIA-222 Revision:</b>	TIA-222-H
<b>Risk Category:</b>	II
<b>Wind Speed:</b>	125 mph
<b>Exposure Category:</b>	C
<b>Topographic Factor:</b>	1
<b>Ice Thickness:</b>	2 in
<b>Wind Speed with Ice:</b>	50 mph
<b>Service Wind Speed:</b>	60 mph

**Table 1 - Proposed Equipment Configuration**

Mounting Level (ft)	Center Line Elevation (ft)	Number of Antennas	Antenna Manufacturer	Antenna Model	Number of Feed Lines	Feed Line Size (in)
62.0	62.0	3	fujitsu	TA08025-B604	1	1-1/2
		3	fujitsu	TA08025-B605		
		3	jma wireless	MX08FRO665-21 w/ Mount Pipe		
		1	raycap	RDIDC-9181-PF-48		
		1	tower mounts	Commscope MC-PK8-DSH		

**Table 2 - Other Considered Equipment**

Mounting Level (ft)	Center Line Elevation (ft)	Number of Antennas	Antenna Manufacturer	Antenna Model	Number of Feed Lines	Feed Line Size (in)
116.0	116.0	3	alcatel lucent	800MHz 2X50W RRH W/FILTER	-	-
		3	alcatel lucent	PCS 1900MHz 4x45W-65MHz		
		1	tower mounts	Pipe Mount [PM 601-3]		
114.0	116.0	3	alcatel lucent	TD-RRH8x20-25	4 1	1-1/4 1/2
		1	andrew	VHLP1-23		
		1	rfs celwave	APXV9ERR18-C-A20 w/ Mount Pipe		
		2	rfs celwave	APXVSP18-C-A20 w/ Mount Pipe		
		3	rfs celwave	APXVTM14-C-120 w/ Mount Pipe		
	1	samsung telecommunications	WIMAX DAP HEAD			
	114.0	1	tower mounts	Platform Mount [LP 502-1]		
108.0	108.0	3	commscope	SDX1926Q-43	3 6	1-5/8 7/8
		3	ericsson	AIR 32 B2a/B66Aa		
		3	ericsson	AIR6449 B41_T-MOBILE w/ Mount Pipe		
		3	ericsson	KRY 112 144/1		
		3	ericsson	RADIO 4449 B71 B85A_T-MOBILE		
		3	ericsson	RRUS 4415 B25		

Mounting Level (ft)	Center Line Elevation (ft)	Number of Antennas	Antenna Manufacturer	Antenna Model	Number of Feed Lines	Feed Line Size (in)	
		3	rfs celwave	APXVAARR24_43-U-NA20 w/ Mount Pipe			
		1	tower mounts	Platform Mount [LP 303-1_KCKR-HR-1]			
98.0	98.0	1	andrew	SBNH-1D6565C w/ Mount Pipe	2 1 1	3/4 3/8 conduit	
		2	cci antennas	HPA-65R-BUU-H6 w/ Mount Pipe			
		1	cci antennas	HPA-65R-BUU-H8 w/ Mount Pipe			
		3	communication components inc.	DTMABP7819VG12A			
		3	ericsson	RRUS 11 B12			
		3	ericsson	RRUS 32 B2			
		2	kmw communications	AM-X-CD-16-65-00T-RET w/ Mount Pipe			
		6	powerwave technologies	7020.00			
		3	powerwave technologies	7770.00 w/ Mount Pipe			
		3	powerwave technologies	TT19-08BP111-001			
		1	raycap	DC6-48-60-18-8F			
		85.0	86.0	3			alcatel lucent
3	alcatel lucent			RRH2X60-PCS			
6	andrew			CBC721-DF			
6	andrew			HBXX-6517DS-A2M w/ Mount Pipe			
2	antel			BXA-70040-6CF-EDIN-2 w/ Mount Pipe			
4	antel			BXA-70063-6CF-2 w/ Mount Pipe			
1	rfs celwave		DB-B1-6C-12AB-0Z				
	85.0	1	tower mounts	Platform Mount [LP 303-1]			
80.0	81.0	1	lucent	KS24019-L112A	1	1/2 conduit	
	80.0	1	tower mounts	Side Arm Mount [SO 701-1]	1		
72.0	74.0	2	argus technologies	LLPX310R w/ Mount Pipe	2 3 3 2	1/2 1/4 5/8 conduit	
		1	dragonwave	HORIZON COMPACT			
		1	samsung telecommunications	WIMAX DAP HEAD			
	73.0	1	andrew	VHLP1-23			
		1	samsung telecommunications	WIMAX DAP HEAD			
	72.0	72.0	1	argus technologies			LLPX310R w/ Mount Pipe
			1	dragonwave			A-ANT-18G-2-C
			1	dragonwave			HORIZON COMPACT
			1	samsung telecommunications			WIMAX DAP HEAD
		1	tower mounts	Side Arm Mount [SO 101-3]			

### 3) ANALYSIS PROCEDURE

**Table 3 - Documents Provided**

Document	Reference	Source
4-TOWER MANUFACTURER DRAWINGS	5875885	CCISITES
4-TOWER FOUNDATION DRAWINGS/DESIGN/SPECS	1947809	CCISITES
4-GEOTECHNICAL REPORTS	2192549	CCISITES
4-TOWER REINFORCEMENT DESIGN/DRAWINGS/DATA	2268906	CCISITES
4-TOWER REINFORCEMENT DESIGN/DRAWINGS/DATA	3259703	CCISITES
4-POST-MODIFICATION INSPECTION	3684848	CCISITES
4-TOWER REINFORCEMENT DESIGN/DRAWINGS/DATA	4858411	CCISITES
4-POST-MODIFICATION INSPECTION	5407775	CCISITES
4-TOWER REINFORCEMENT DESIGN/DRAWINGS/DATA	5371260	CCISITES
4-POST-MODIFICATION INSPECTION	5596857	CCISITES
4-TOWER REINFORCEMENT DESIGN/DRAWINGS/DATA	5907683	CCISITES
4-POST-MODIFICATION INSPECTION	6131239	CCISITES

#### 3.1) Analysis Method

tnxTower (version 8.0.9.0), a commercially available analysis software package, was used to create a three-dimensional model of the tower and calculate member stresses for various loading cases. Selected output from the analysis is included in Appendix A. When applicable, Crown Castle has calculated and provided the effective area for panel antennas using approved methods following the intent of the TIA-222 standard.

tnxTower was used to determine the loads on the modified structure. Additional calculations were performed to determine the stresses in the pole and in the reinforcing elements. These calculations are included in Appendix C.

#### 3.2) Assumptions

- 1) Tower and structures were maintained in accordance with the TIA-222 Standard.
- 2) The configuration of antennas, transmission cables, mounts and other appurtenances are as specified in Tables 1 and 2 and the referenced drawings.

This analysis may be affected if any assumptions are not valid or have been made in error. Crown Castle should be notified to determine the effect on the structural integrity of the tower.

### 4) ANALYSIS RESULTS

**Table 4 - Section Capacity (Summary)**

Elevation (ft)	Component Type	Size	Critical Element	% Capacity	Pass / Fail
118 - 113	Pole	TP24x24x0.25	Pole	2.5%	Pass
113 - 108	Pole	TP24x24x0.25	Pole	7.1%	Pass
108 - 103	Pole	TP24x24x0.25	Pole	18.1%	Pass
103 - 98	Pole	TP24x24x0.25	Pole	28.7%	Pass
98 - 93	Pole	TP24x24x0.25	Pole	45.4%	Pass
93 - 90	Pole	TP24x24x0.25	Pole	55.2%	Pass
90 - 85	Pole	TP24x24x0.375	Pole	46.0%	Pass

Elevation (ft)	Component Type	Size	Critical Element	% Capacity	Pass / Fail
85 - 80	Pole	TP24x24x0.375	Pole	61.7%	Pass
80 - 76.5	Pole	TP24x24x0.375	Pole	72.3%	Pass
76.5 - 76.25	Pole + Reinf.	TP24x24x0.5875	Reinf. 18 Tension Rupture	52.5%	Pass
76.25 - 74	Pole + Reinf.	TP24x24x0.5875	Reinf. 18 Tension Rupture	57.4%	Pass
74 - 73.75	Pole + Reinf.	TP24x24x0.9	Reinf. 3 Compression	56.9%	Pass
73.75 - 68.88	Pole + Reinf.	TP24x24x0.9	Reinf. 3 Compression	68.1%	Pass
68.88 - 68.63	Pole + Reinf.	TP24x24x0.575	Reinf. 13 Tension Rupture	70.2%	Pass
68.63 - 64.5	Pole + Reinf.	TP24x24x0.575	Reinf. 13 Tension Rupture	80.2%	Pass
64.5 - 64.25	Pole + Reinf.	TP24x24x1.05	Reinf. 3 Compression	69.5%	Pass
64.25 - 63	Pole + Reinf.	TP24x24x1.05	Reinf. 3 Compression	72.1%	Pass
63 - 62.75	Pole + Reinf.	TP24x24x1	Reinf. 3 Compression	74.9%	Pass
62.75 - 60	Pole + Reinf.	TP24x24x1	Reinf. 3 Compression	81.7%	Pass
60 - 59.75	Pole + Reinf.	TP30x30x0.675	Reinf. 2 Compression	51.8%	Pass
59.75 - 54.75	Pole + Reinf.	TP30x30x0.675	Reinf. 2 Compression	59.8%	Pass
54.75 - 49.75	Pole + Reinf.	TP30x30x0.675	Reinf. 2 Compression	67.9%	Pass
49.75 - 49.25	Pole + Reinf.	TP30x30x0.675	Reinf. 2 Compression	68.7%	Pass
49.25 - 49	Pole + Reinf.	TP30x30x0.875	Reinf. 2 Compression	63.3%	Pass
49 - 44	Pole + Reinf.	TP30x30x0.875	Reinf. 2 Compression	70.8%	Pass
44 - 42	Pole + Reinf.	TP30x30x0.875	Reinf. 2 Compression	73.8%	Pass
42 - 41.75	Pole + Reinf.	TP30x30x1	Reinf. 2 Compression	65.3%	Pass
41.75 - 36.75	Pole + Reinf.	TP30x30x1	Reinf. 2 Compression	72.0%	Pass
36.75 - 34.5	Pole + Reinf.	TP30x30x1	Reinf. 2 Compression	75.1%	Pass
34.5 - 34.25	Pole + Reinf.	TP30x30x1.05	Reinf. 8 Compression	67.0%	Pass
34.25 - 34	Pole + Reinf.	TP30x30x1.05	Reinf. 8 Compression	67.3%	Pass
34 - 33.75	Pole + Reinf.	TP30x30x0.95	Reinf. 8 Compression	75.8%	Pass
33.75 - 30	Pole + Reinf.	TP30x30x0.95	Reinf. 8 Compression	81.1%	Pass
30 - 29.75	Pole + Reinf.	TP36x36x0.7	Reinf. 1 Compression	73.4%	Pass
29.75 - 28.5	Pole + Reinf.	TP36x36x0.7	Reinf. 1 Compression	75.0%	Pass
28.5 - 28.25	Pole + Reinf.	TP36x36x0.8375	Reinf. 1 Compression	62.3%	Pass
28.25 - 23.25	Pole + Reinf.	TP36x36x0.8375	Reinf. 1 Compression	67.7%	Pass
23.25 - 23	Pole + Reinf.	TP36x36x0.975	Reinf. 1 Compression	63.6%	Pass
23 - 21.5	Pole + Reinf.	TP36x36x0.975	Reinf. 1 Compression	65.2%	Pass
21.5 - 21.25	Pole + Reinf.	TP36x36x0.825	Reinf. 1 Compression	78.2%	Pass
21.25 - 19	Pole + Reinf.	TP36x36x0.825	Reinf. 1 Compression	81.1%	Pass
19 - 18.75	Pole + Reinf.	TP36x36x0.975	Reinf. 1 Compression	68.7%	Pass
18.75 - 18.5	Pole + Reinf.	TP36x36x0.975	Reinf. 1 Compression	69.0%	Pass
18.5 - 18.25	Pole + Reinf.	TP36x36x0.925	Reinf. 1 Compression	70.8%	Pass
18.25 - 13.25	Pole + Reinf.	TP36x36x0.925	Reinf. 1 Compression	76.3%	Pass
13.25 - 12.7	Pole + Reinf.	TP36x36x0.925	Reinf. 1 Compression	76.9%	Pass
12.7 - 12.45	Pole + Reinf.	TP36x36x0.9	Reinf. 1 Compression	80.1%	Pass
12.45 - 11.5	Pole + Reinf.	TP36x36x0.9	Reinf. 1 Compression	81.2%	Pass
11.5 - 11.25	Pole + Reinf.	TP36x36x0.9	Reinf. 4 Compression	71.8%	Pass
11.25 - 10.5	Pole + Reinf.	TP36x36x0.9	Reinf. 4 Compression	72.6%	Pass
10.5 - 10.25	Pole + Reinf.	TP36x36x1.325	Reinf. 24 Compression	68.4%	Pass

Elevation (ft)	Component Type	Size	Critical Element	% Capacity	Pass / Fail
10.25 - 7.5	Pole + Reinf.	TP36x36x1.325	Reinf. 24 Compression	71.1%	Pass
7.5 - 7.25	Pole + Reinf.	TP36x36x1.4	Reinf. 24 Compression	69.0%	Pass
7.25 - 6.25	Pole + Reinf.	TP36x36x1.4	Reinf. 24 Compression	69.9%	Pass
6.25 - 6	Pole + Reinf.	TP36x36x1.4	Reinf. 24 Compression	70.2%	Pass
6 - 3.73	Pole + Reinf.	TP36x36x1.725	Reinf. 24 Compression	60.4%	Pass
3.73 - 3.48	Pole + Reinf.	TP36x36x1.725	Reinf. 24 Compression	60.6%	Pass
3.48 - 2.75	Pole + Reinf.	TP36x36x1.725	Reinf. 24 Compression	61.2%	Pass
2.75 - 2.5	Pole + Reinf.	TP36x36x1.675	Reinf. 24 Compression	65.6%	Pass
2.5 - 2	Pole + Reinf.	TP36x36x1.675	Reinf. 24 Compression	66.1%	Pass
2 - 1.75	Pole + Reinf.	TP36x36x1.425	Reinf. 24 Compression	73.6%	Pass
1.75 - 0	Pole + Reinf.	TP36x36x1.425	Reinf. 24 Compression	75.3%	Pass
				Summary	
			Pole	75.0%	Pass
			Reinforcement	81.7%	Pass
			Overall	81.7%	Pass

**Table 5 - Tower Component Stresses vs. Capacity - LC7**

Notes	Component	Elevation (ft)	% Capacity	Pass / Fail
1	Flange Connection	90	21.6	Pass
1	Flange Connection	60	83.3	Pass
1	Flange Connection	30	95.5	Pass
1	Anchor Rods	0	95.4	Pass
1	Base Plate	0	59.4	Pass
1	Base Foundation (Structure)	0	100.0	Pass
1	Base Foundation (Soil Interaction)	0	10.2	Pass

<b>Structure Rating (max from all components) =</b>	<b>100%</b>
---	-------------

Notes:

- 1) See additional documentation in "Appendix C – Additional Calculations" for calculations supporting the % capacity consumed.

#### 4.1) Recommendations

The tower and its foundation have sufficient capacity to carry the proposed load configuration. No modifications are required at this time.

**APPENDIX A**  
**TNXTOWER OUTPUT**



Section	Size	Length (ft)	Grade	Weight (K)
1	P24x0.25	5.0000	A572-42	0.3
2	P24x0.25	5.0000	A572-42	0.3
3	P24x0.25	5.0000	A572-42	0.3
4	P24x0.25	5.0000	A572-42	0.3
5	P24x0.25	5.0000	A572-42	0.3
6	P24x0.25	3.0000	A572-42	0.2
7	P24x0.375	5.0000	A572-42	0.5
8	P24x0.375	5.0000	A572-42	0.5
9	P24x0.375	5.0000	A572-42	0.3
10	P24x0.375	5.0000	A572-42	0.3
11	P24x0.375	5.0000	A572-42	0.3
12	P24x0.375	5.0000	A572-42	0.3
13	P24x0.375	5.0000	A572-42	0.3
14	P24x0.375	5.0000	A572-42	0.3
15	P24x0.375	5.0000	A572-42	0.3
16	P24x0.375	5.0000	A572-42	0.3
17	P24x0.375	5.0000	A572-42	0.3
18	P24x0.375	5.0000	A572-42	0.3
19	P24x0.375	5.0000	A572-42	0.3
20	P24x0.375	5.0000	A572-42	0.3
21	P30x0.675	5.0000	A572-42	1.1
22	P30x0.675	5.0000	A572-42	1.1
23	P30x0.675	5.0000	A572-42	1.1
24	P30x0.675	5.0000	A572-42	1.1
25	P30x0.675	5.0000	A572-42	1.1
26	P30x0.675	5.0000	A572-42	1.1
27	P30x0.675	5.0000	A572-42	1.1
28	P30x0.675	5.0000	A572-42	1.1
29	P30x0.675	5.0000	A572-42	1.1
30	P30x0.675	5.0000	A572-42	1.1
31	P30x0.675	5.0000	A572-42	1.1
32	P30x0.675	5.0000	A572-42	1.1
33	P30x0.675	5.0000	A572-42	1.1
34	P30x0.675	5.0000	A572-42	1.1
35	P30x0.675	5.0000	A572-42	1.1
36	P30x0.675	5.0000	A572-42	1.1
37	P30x0.675	5.0000	A572-42	1.1
38	P30x0.675	5.0000	A572-42	1.1
39	P30x0.675	5.0000	A572-42	1.1
40	P30x0.675	5.0000	A572-42	1.1
41	P30x0.675	5.0000	A572-42	1.1
42	P30x0.675	5.0000	A572-42	1.1
43	P30x0.675	5.0000	A572-42	1.1
44	P30x0.675	5.0000	A572-42	1.1
45	P30x0.675	5.0000	A572-42	1.1
46	P30x0.675	5.0000	A572-42	1.1
47	P30x0.675	5.0000	A572-42	1.1
48	P30x0.675	5.0000	A572-42	1.1
49	P30x0.675	5.0000	A572-42	1.1
50	P30x0.675	5.0000	A572-42	1.1
51	P30x0.675	5.0000	A572-42	1.1
52	P30x0.675	5.0000	A572-42	1.1
53	P30x0.675	5.0000	A572-42	1.1
54	P30x0.675	5.0000	A572-42	1.1
55	P30x0.675	5.0000	A572-42	1.1
56	P30x0.675	5.0000	A572-42	1.1
57	P30x0.675	5.0000	A572-42	1.1
58	P30x0.675	5.0000	A572-42	1.1
59	P30x0.675	5.0000	A572-42	1.1
60	P30x0.675	5.0000	A572-42	1.1
61	P30x0.675	5.0000	A572-42	1.1
62	P30x0.675	5.0000	A572-42	1.1
63	P30x0.675	5.0000	A572-42	1.1
64	P30x0.675	5.0000	A572-42	1.1
65	P30x0.675	5.0000	A572-42	1.1
66	P30x0.675	5.0000	A572-42	1.1
67	P30x0.675	5.0000	A572-42	1.1
68	P30x0.675	5.0000	A572-42	1.1
69	P30x0.675	5.0000	A572-42	1.1
70	P30x0.675	5.0000	A572-42	1.1
71	P30x0.675	5.0000	A572-42	1.1
72	P30x0.675	5.0000	A572-42	1.1
73	P30x0.675	5.0000	A572-42	1.1
74	P30x0.675	5.0000	A572-42	1.1
75	P30x0.675	5.0000	A572-42	1.1
76	P30x0.675	5.0000	A572-42	1.1
77	P30x0.675	5.0000	A572-42	1.1
78	P30x0.675	5.0000	A572-42	1.1
79	P30x0.675	5.0000	A572-42	1.1
80	P30x0.675	5.0000	A572-42	1.1
81	P30x0.675	5.0000	A572-42	1.1
82	P30x0.675	5.0000	A572-42	1.1
83	P30x0.675	5.0000	A572-42	1.1
84	P30x0.675	5.0000	A572-42	1.1
85	P30x0.675	5.0000	A572-42	1.1
86	P30x0.675	5.0000	A572-42	1.1
87	P30x0.675	5.0000	A572-42	1.1
88	P30x0.675	5.0000	A572-42	1.1
89	P30x0.675	5.0000	A572-42	1.1
90	P30x0.675	5.0000	A572-42	1.1
91	P30x0.675	5.0000	A572-42	1.1
92	P30x0.675	5.0000	A572-42	1.1
93	P30x0.675	5.0000	A572-42	1.1
94	P30x0.675	5.0000	A572-42	1.1
95	P30x0.675	5.0000	A572-42	1.1
96	P30x0.675	5.0000	A572-42	1.1
97	P30x0.675	5.0000	A572-42	1.1
98	P30x0.675	5.0000	A572-42	1.1
99	P30x0.675	5.0000	A572-42	1.1
100	P30x0.675	5.0000	A572-42	1.1

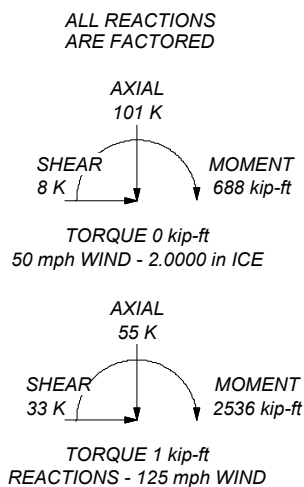
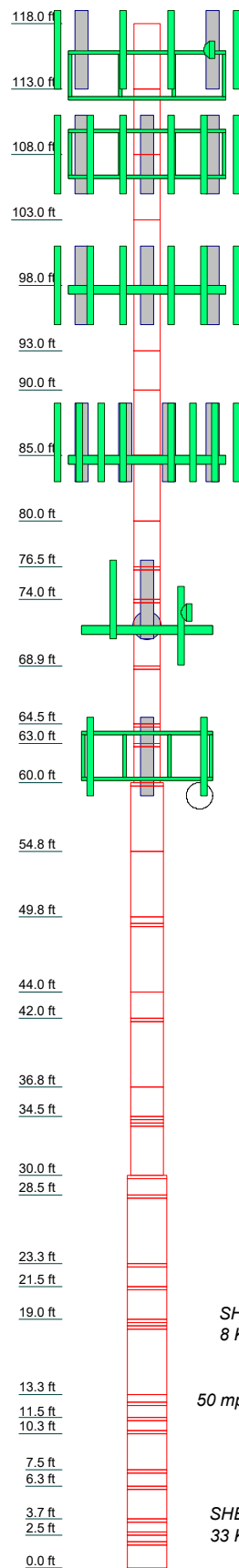

### MATERIAL STRENGTH

GRADE	Fy	Fu	GRADE	Fy	Fu
A572-42	42 ksi	60 ksi			

### TOWER DESIGN NOTES

1. Tower is located in Hartford County, Connecticut.
2. Tower designed for Exposure C to the TIA-222-H Standard.
3. Tower designed for a 125 mph basic wind in accordance with the TIA-222-H Standard.
4. Tower is also designed for a 50 mph basic wind with 2.00 in ice. Ice is considered to increase in thickness with height.
5. Deflections are based upon a 60 mph wind.
6. Tower Risk Category II.
7. Topographic Category 1 with Crest Height of 0.0000 ft
8. TOWER RATING: 81.7%

**CROWN CASTLE**  
 The Pathway to Possible

**Crown Castle**  
 2000 Corporate Drive  
 Canonsburg, PA 15317  
 Phone: (724) 416-2000  
 FAX:

Job: <b>BU# 876331</b>			
Project:	Client: Crown Castle	Drawn by: Kayla Weimert	App'd:
Code: TIA-222-H	Date: 06/02/21	Scale: NTS	Dwg No. E-1
Path: C:\Users\KWeimert\Desktop\SAPI WORK\876331\WO 1966745 - SAPIProd\876331.dwg			

## Tower Input Data

The tower is a monopole.  
 This tower is designed using the TIA-222-H standard.  
 The following design criteria apply:

- Tower is located in Hartford County, Connecticut.
- Tower base elevation above sea level: 350.0000 ft.
- Basic wind speed of 125 mph.
- Risk Category II.
- Exposure Category C.
- Simplified Topographic Factor Procedure for wind speed-up calculations is used.
- Topographic Category: 1.
- Crest Height: 0.0000 ft.
- Nominal ice thickness of 2.0000 in.
- Ice thickness is considered to increase with height.
- Ice density of 56.0000 pcf.
- A wind speed of 50 mph is used in combination with ice.
- Temperature drop of 50.0000 °F.
- Deflections calculated using a wind speed of 60 mph.
- TOWER RATING: 81.7%.
- A non-linear (P-delta) analysis was used.
- Pressures are calculated at each section.
- Stress ratio used in pole design is 1.
- Tower analysis based on target reliabilities in accordance with Annex S.
- Load Modification Factors used:  $K_{es}(F_w) = 0.95$ ,  $K_{es}(t_i) = 0.85$ .
- Maximum demand-capacity ratio is: 1.05.
- Local bending stresses due to climbing loads, feed line supports, and appurtenance mounts are not considered.

## Options

Consider Moments - Legs Consider Moments - Horizontals Consider Moments - Diagonals Use Moment Magnification ✓ Use Code Stress Ratios ✓ Use Code Safety Factors - Guys Escalate Ice Always Use Max Kz Use Special Wind Profile  Include Bolts In Member Capacity  Leg Bolts Are At Top Of Section Secondary Horizontal Braces Leg Use Diamond Inner Bracing (4 Sided) SR Members Have Cut Ends SR Members Are Concentric	Distribute Leg Loads As Uniform Assume Legs Pinned ✓ Assume Rigid Index Plate ✓ Use Clear Spans For Wind Area Use Clear Spans For KL/r Retension Guys To Initial Tension ✓ Bypass Mast Stability Checks ✓ Use Azimuth Dish Coefficients ✓ Project Wind Area of Appurt.  Autocalc Torque Arm Areas  Add IBC .6D+W Combination ✓ Sort Capacity Reports By Component Triangulate Diamond Inner Bracing Treat Feed Line Bundles As Cylinder Ignore KL/ry For 60 Deg. Angle Legs	Use ASCE 10 X-Brace Ly Rules Calculate Redundant Bracing Forces Ignore Redundant Members in FEA SR Leg Bolts Resist Compression All Leg Panels Have Same Allowable Offset Girt At Foundation ✓ Consider Feed Line Torque Include Angle Block Shear Check Use TIA-222-H Bracing Resist. Exemption Use TIA-222-H Tension Splice Exemption  <div style="text-align: center; background-color: #e0e0e0; padding: 2px;"><b>Poles</b></div> ✓ Include Shear-Torsion Interaction Always Use Sub-Critical Flow Use Top Mounted Sockets Pole Without Linear Attachments Pole With Shroud Or No Appurtenances Outside and Inside Corner Radii Are Known
--	---	---

## Pole Section Geometry

Section	Elevation ft	Section Length ft	Pole Size	Pole Grade	Socket Length ft
L1	118.0000- 113.0000	5.0000	P24x0.25	A572-42 (42 ksi)	
L2	113.0000- 108.0000	5.0000	P24x0.25	A572-42 (42 ksi)	
L3	108.0000- 103.0000	5.0000	P24x0.25	A572-42 (42 ksi)	
L4	103.0000- 98.0000	5.0000	P24x0.25	A572-42 (42 ksi)	
L5	98.0000-93.0000	5.0000	P24x0.25	A572-42 (42 ksi)	
L6	93.0000-90.0000	3.0000	P24x0.25	A572-42 (42 ksi)	
L7	90.0000-85.0000	5.0000	P24x0.375	A572-42 (42 ksi)	
L8	85.0000-80.0000	5.0000	P24x0.375	A572-42 (42 ksi)	
L9	80.0000-76.5000	3.5000	P24x0.375	A572-42 (42 ksi)	
L10	76.5000-76.2500	0.2500	P24x0.5875	A572-42 (42 ksi)	
L11	76.2500-74.0000	2.2500	P24x0.5875	A572-42 (42 ksi)	
L12	74.0000-73.7500	0.2500	P24x0.9	A572-42 (42 ksi)	
L13	73.7500-68.8800	4.8700	P24x0.9	A572-42 (42 ksi)	
L14	68.8800-68.6300	0.2500	P24x0.575	A572-42 (42 ksi)	
L15	68.6300-64.5000	4.1300	P24x0.575	A572-42 (42 ksi)	
L16	64.5000-64.2500	0.2500	P24x1.05	A572-42 (42 ksi)	
L17	64.2500-63.0000	1.2500	P24x1.05	A572-42 (42 ksi)	
L18	63.0000-62.7500	0.2500	P24x1	A572-42 (42 ksi)	
L19	62.7500-60.0000	2.7500	P24x1	A572-42 (42 ksi)	
L20	60.0000-59.7500	0.2500	P30x0.675	A572-42 (42 ksi)	
L21	59.7500-54.7500	5.0000	P30x0.675	A572-42 (42 ksi)	
L22	54.7500-49.7500	5.0000	P30x0.675	A572-42 (42 ksi)	
L23	49.7500-49.2500	0.5000	P30x0.675	A572-42 (42 ksi)	
L24	49.2500-49.0000	0.2500	P30x0.875	A572-42 (42 ksi)	
L25	49.0000-44.0000	5.0000	P30x0.875	A572-42 (42 ksi)	
L26	44.0000-42.0000	2.0000	P30x0.875	A572-42 (42 ksi)	
L27	42.0000-41.7500	0.2500	P30x1	A572-42 (42 ksi)	
L28	41.7500-36.7500	5.0000	P30x1	A572-42 (42 ksi)	
L29	36.7500-34.5000	2.2500	P30x1	A572-42 (42 ksi)	
L30	34.5000-34.2500	0.2500	P30x1.05	A572-42 (42 ksi)	
L31	34.2500-34.0000	0.2500	P30x1.05	A572-42 (42 ksi)	
L32	34.0000-33.7500	0.2500	P30x0.95	A572-42 (42 ksi)	
L33	33.7500-30.0000	3.7500	P30x0.95	A572-42 (42 ksi)	
L34	30.0000-29.7500	0.2500	P36x0.7	A572-42 (42 ksi)	
L35	29.7500-28.5000	1.2500	P36x0.7	A572-42	

Section	Elevation ft	Section Length ft	Pole Size	Pole Grade	Socket Length ft
L36	28.5000-28.2500	0.2500	P36x0.8375	(42 ksi) A572-42	
L37	28.2500-23.2500	5.0000	P36x0.8375	(42 ksi) A572-42	
L38	23.2500-23.0000	0.2500	P36x0.975	(42 ksi) A572-42	
L39	23.0000-21.5000	1.5000	P36x0.975	(42 ksi) A572-42	
L40	21.5000-21.2500	0.2500	P36x0.825	(42 ksi) A572-42	
L41	21.2500-19.0000	2.2500	P36x0.825	(42 ksi) A572-42	
L42	19.0000-18.7500	0.2500	P36x0.975	(42 ksi) A572-42	
L43	18.7500-18.5000	0.2500	P36x0.975	(42 ksi) A572-42	
L44	18.5000-18.2500	0.2500	P36x0.925	(42 ksi) A572-42	
L45	18.2500-13.2500	5.0000	P36x0.925	(42 ksi) A572-42	
L46	13.2500-12.7000	0.5500	P36x0.925	(42 ksi) A572-42	
L47	12.7000-12.4500	0.2500	P36x0.9	(42 ksi) A572-42	
L48	12.4500-11.5000	0.9500	P36x0.9	(42 ksi) A572-42	
L49	11.5000-11.2500	0.2500	P36x0.9	(42 ksi) A572-42	
L50	11.2500-10.5000	0.7500	P36x0.9	(42 ksi) A572-42	
L51	10.5000-10.2500	0.2500	P36x1.325	(42 ksi) A572-42	
L52	10.2500-7.5000	2.7500	P36x1.325	(42 ksi) A572-42	
L53	7.5000-7.2500	0.2500	P36x1.4	(42 ksi) A572-42	
L54	7.2500-6.2500	1.0000	P36x1.4	(42 ksi) A572-42	
L55	6.2500-6.0000	0.2500	P36x1.4	(42 ksi) A572-42	
L56	6.0000-3.7300	2.2700	P36x1.725	(42 ksi) A572-42	
L57	3.7300-3.4800	0.2500	P36x1.725	(42 ksi) A572-42	
L58	3.4800-2.7500	0.7300	P36x1.725	(42 ksi) A572-42	
L59	2.7500-2.5000	0.2500	P36x1.675	(42 ksi) A572-42	
L60	2.5000-2.0000	0.5000	P36x1.675	(42 ksi) A572-42	
L61	2.0000-1.7500	0.2500	P36x1.425	(42 ksi) A572-42	
L62	1.7500-0.0000	1.7500	P36x1.425	(42 ksi) A572-42	

Tower Elevation ft	Gusset Area (per face) ft <sup>2</sup>	Gusset Thickness in	Gusset Grade	Adjust. Factor A <sub>r</sub>	Adjust. Factor A <sub>r</sub>	Weight Mult.	Double Angle Stitch Bolt Spacing Diagonals in	Double Angle Stitch Bolt Spacing Horizontals in	Double Angle Stitch Bolt Spacing Redundants in
L1 118.0000- 113.0000				1	1	1			
L2 113.0000- 108.0000				1	1	1			
L3 108.0000- 103.0000				1	1	1			

Tower Elevation	Gusset Area (per face)	Gusset Thickness	Gusset Grade	Adjust. Factor $A_r$	Adjust. Factor $A_r$	Weight Mult.	Double Angle Stitch Bolt Spacing Diagonals in	Double Angle Stitch Bolt Spacing Horizontals in	Double Angle Stitch Bolt Spacing Redundants in
ft	ft <sup>2</sup>	in							
L4 103.0000-98.0000				1	1	1			
L5 98.0000-93.0000				1	1	1			
L6 93.0000-90.0000				1	1	1			
L7 90.0000-85.0000				1	1	1			
L8 85.0000-80.0000				1	1	1			
L9 80.0000-76.5000				1	1	1			
L10 76.5000-76.2500				1	1	0.956504			
L11 76.2500-74.0000				1	1	0.956504			
L12 74.0000-73.7500				1	1	0.938317			
L13 73.7500-68.8800				1	1	0.938317			
L14 68.8800-68.6300				1	1	0.976776			
L15 68.6300-64.5000				1	1	0.976776			
L16 64.5000-64.2500				1	1	0.928412			
L17 64.2500-63.0000				1	1	0.928412			
L18 63.0000-62.7500				1	1	0.941574			
L19 62.7500-60.0000				1	1	0.941574			
L20 60.0000-59.7500				1	1	1.03516			
L21 59.7500-54.7500				1	1	1.03516			
L22 54.7500-49.7500				1	1	1.03516			
L23 49.7500-49.2500				1	1	1.03516			
L24 49.2500-49.0000				1	1	0.878976			
L25 49.0000-44.0000				1	1	0.878976			
L26 44.0000-42.0000				1	1	0.878976			
L27 42.0000-41.7500				1	1	0.871205			
L28 41.7500-36.7500				1	1	0.871205			
L29 36.7500-34.5000				1	1	0.871205			
L30 34.5000-34.2500				1	1	0.925396			
L31 34.2500-34.0000				1	1	0.925396			
L32 34.0000-33.7500				1	1	0.915479			
L33 33.7500-30.0000				1	1	0.915479			
L34 30.0000-29.7500				1	1	1.02978			
L35 29.7500-28.5000				1	1	1.02978			
L36 28.5000-28.2500				1	1	1.01			
L37 28.2500-				1	1	1.01			

Tower Elevation	Gusset Area (per face)	Gusset Thickness	Gusset Grade	Adjust. Factor $A_r$	Adjust. Factor $A_r$	Weight Mult.	Double Angle Stitch Bolt Spacing Diagonals in	Double Angle Stitch Bolt Spacing Horizontals in	Double Angle Stitch Bolt Spacing Redundants in
ft	ft <sup>2</sup>	in							
L38 23.2500-23.0000				1	1	0.982824			
L39 23.0000-21.5000				1	1	0.982824			
L40 21.5000-21.2500				1	1	1.00849			
L41 21.2500-19.0000				1	1	1.00849			
L42 19.0000-18.7500				1	1	0.982824			
L43 18.7500-18.5000				1	1	0.982824			
L44 18.5000-18.2500				1	1	0.95108			
L45 18.2500-13.2500				1	1	0.95108			
L46 13.2500-12.7000				1	1	0.95108			
L47 12.7000-12.4500				1	1	0.981841			
L48 12.4500-11.5000				1	1	0.981841			
L49 11.5000-11.2500				1	1	1.07001			
L50 11.2500-10.5000				1	1	1.07001			
L51 10.5000-10.2500				1	1	0.839629			
L52 10.2500-7.5000				1	1	0.839629			
L53 7.5000-7.2500				1	1	0.828084			
L54 7.2500-6.2500				1	1	0.828084			
L55 6.2500-6.0000				1	1	0.828084			
L56 6.0000-3.7300				1	1	0.713254			
L57 3.7300-3.4800				1	1	0.713254			
L58 3.4800-2.7500				1	1	0.713254			
L59 2.7500-2.5000				1	1	0.667039			
L60 2.5000-2.0000				1	1	0.667039			
L61 2.0000-1.7500				1	1	0.691176			
L62 1.7500-0.0000				1	1	0.691176			

**Feed Line/Linear Appurtenances - Entered As Round Or Flat**

Description	Sector	Exclude From Torque Calculation	Component Type	Placement ft	Total Number	Number Per Row	Start/End Position	Width or Diameter in	Perimeter in	Weight plf
***										
***										
***										
MS-400	A	No	Surface Af (CaAa)	65.5000 - 60.5000	1	1	0.300 0.300	0.7500	9.5000	0.0000

Description	Sector	Exclude From Torque Calculation	Component Type	Placement ft	Total Number	Number Per Row	Start/End Position	Width or Diameter in	Perimeter in	Weight plf
MS-400	B	No	Surface Af (CaAa)	65.5000 - 60.5000	1	1	0.300	0.7500	9.5000	0.0000
MS-400	C	No	Surface Af (CaAa)	65.5000 - 60.5000	1	1	0.300	0.7500	9.5000	0.0000
MS-400	A	No	Surface Af (CaAa)	35.5000 - 30.5000	1	1	-0.300	0.7500	9.5000	0.0000
MS-400	B	No	Surface Af (CaAa)	35.5000 - 30.5000	1	1	-0.300	0.7500	9.5000	0.0000
MS-400	C	No	Surface Af (CaAa)	35.5000 - 30.5000	1	1	-0.300	0.7500	9.5000	0.0000
MS-450	A	No	Surface Af (CaAa)	20.5000 - 0.5000	1	1	-0.300	1.0000	11.0000	0.0000
MS-450	B	No	Surface Af (CaAa)	20.5000 - 0.5000	1	1	-0.300	1.0000	11.0000	0.0000
MS-450	C	No	Surface Af (CaAa)	20.5000 - 0.5000	1	1	-0.300	1.0000	11.0000	0.0000
***										
CCI-65FP-045100	A	No	Surface Af (CaAa)	70.2500 - 60.2500	1	1	0.000	4.5000	11.0000	0.0000
CCI-65FP-045100	B	No	Surface Af (CaAa)	70.2500 - 60.2500	1	1	0.000	4.5000	11.0000	0.0000
CCI-65FP-045100	C	No	Surface Af (CaAa)	70.2500 - 60.2500	1	1	0.000	4.5000	11.0000	0.0000
CCI-65FP-040075	A	No	Surface Af (CaAa)	43.0000 - 33.0000	1	1	-0.167	4.0000	9.5000	0.0000
CCI-65FP-040075	B	No	Surface Af (CaAa)	43.0000 - 33.0000	1	1	-0.167	4.0000	9.5000	0.0000
CCI-65FP-040075	C	No	Surface Af (CaAa)	43.0000 - 33.0000	1	1	-0.167	4.0000	9.5000	0.0000
CCI-65FP-060100	A	No	Surface Af (CaAa)	25.5000 - 0.5000	1	1	-0.500	6.0000	14.0000	0.0000
CCI-65FP-060100	B	No	Surface Af (CaAa)	25.5000 - 0.5000	1	1	0.000	6.0000	14.0000	0.0000
***										
CCI-65FP-040075	A	No	Surface Af (CaAa)	50.2500 - 30.2500	1	1	-0.500	4.0000	9.5000	0.0000
CCI-65FP-040075	C	No	Surface Af (CaAa)	50.2500 - 30.2500	1	1	0.000	4.0000	9.5000	0.0000
CCI-65FP-045100	A	No	Surface Af (CaAa)	30.0000 - 20.0000	1	1	-0.167	4.5000	11.0000	0.0000
CCI-65FP-045100	B	No	Surface Af (CaAa)	30.0000 - 20.0000	1	1	-0.167	4.5000	11.0000	0.0000
CCI-65FP-045100	C	No	Surface Af (CaAa)	30.0000 - 20.0000	1	1	-0.167	4.5000	11.0000	0.0000
***										
CCI-65FP-045100	A	No	Surface Af (CaAa)	78.0000 - 67.0000	1	1	-0.167	4.5000	11.0000	0.0000
CCI-65FP-045100	B	No	Surface Af (CaAa)	78.0000 - 67.0000	1	1	-0.167	4.5000	11.0000	0.0000
CCI-65FP-045100	C	No	Surface Af (CaAa)	78.0000 - 67.0000	1	1	-0.167	4.5000	11.0000	0.0000
CCI-65FP-045100	A	No	Surface Af (CaAa)	29.5000 - 17.0000	1	1	0.000	4.5000	11.0000	0.0000
CCI-65FP-045100	C	No	Surface Af (CaAa)	29.5000 - 17.0000	1	1	0.000	4.5000	11.0000	0.0000
CCI-65FP-065125	B	No	Surface Af (CaAa)	13.0000 - 4.0000	1	1	-0.500	6.5000	15.5000	0.0000
***										
***										
LDF7-50A(1-5/8)	A	No	Surface Ar (CaAa)	85.0000 - 0.0000	13	7	0.300	1.9800		0.8200
1" Rigid Conduit	B	No	Surface Ar (CaAa)	80.0000 - 0.0000	1	1	0.500	1.0000		0.6000
FSJ4P-50B-1(1/2)	C	No	Surface Ar (CaAa)	72.0000 - 0.0000	2	2	0.480	0.5300		0.1400
2" Rigid Conduit	C	No	Surface Ar (CaAa)	72.0000 - 0.0000	2	2	0.400	2.0000		2.8000
***										

Description	Sector	Exclude From Torque Calculation	Component Type	Placement ft	Total Number	Number Per Row	Start/End Position	Width or Diameter in	Perimeter in	Weight plf
CU12PSM9P6XXX(1-1/2) *** ***	C	No	Surface Ar (CaAa)	62.0000 - 0.0000	1	1	0.470 0.470	1.6000		2.3500

### Feed Line/Linear Appurtenances - Entered As Area

Description	Face or Leg	Allow Shield	Exclude From Torque Calculation	Component Type	Placement ft	Total Number	CAAA	Weight
							ft <sup>2</sup> /ft	plf
*** *** *** *** ***								
LDF4-50A(1/2)	B	No	No	Inside Pole	114.0000 - 0.0000	1	No Ice 1/2" Ice 1" Ice 2" Ice	0.1500 0.1500 0.1500 0.1500
HB114-1-08U4-M5J(1-1/4)	B	No	No	Inside Pole	114.0000 - 0.0000	3	No Ice 1/2" Ice 1" Ice 2" Ice	1.0800 1.0800 1.0800 1.0800
HB114-21U3M12-XXXF(1-1/4)	B	No	No	Inside Pole	114.0000 - 0.0000	1	No Ice 1/2" Ice 1" Ice 2" Ice	1.2200 1.2200 1.2200 1.2200
***								
AL5-50(7/8)	B	No	No	Inside Pole	108.0000 - 0.0000	6	No Ice 1/2" Ice 1" Ice 2" Ice	0.2600 0.2600 0.2600 0.2600
HCS 6X12 4AWG(1-5/8)	B	No	No	Inside Pole	108.0000 - 0.0000	1	No Ice 1/2" Ice 1" Ice 2" Ice	2.4000 2.4000 2.4000 2.4000
MLE HYBRID 9POWER/18FIBER RL 2(1-5/8)	B	No	No	Inside Pole	108.0000 - 0.0000	1	No Ice 1/2" Ice 1" Ice 2" Ice	1.0700 1.0700 1.0700 1.0700
HCS 6X12 4AWG(1-5/8)	B	No	No	Inside Pole	108.0000 - 0.0000	1	No Ice 1/2" Ice 1" Ice 2" Ice	2.4000 2.4000 2.4000 2.4000
***								
LDF5-50A(7/8)	C	No	No	Inside Pole	98.0000 - 0.0000	12	No Ice 1/2" Ice 1" Ice 2" Ice	0.3300 0.3300 0.3300 0.3300
FB-L98B-002-75000(3/8)	C	No	No	Inside Pole	98.0000 - 0.0000	1	No Ice 1/2" Ice 1" Ice 2" Ice	0.0586 0.0586 0.0586 0.0586
WR-VG86ST-BRD(3/4)	C	No	No	Inside Pole	98.0000 - 0.0000	2	No Ice 1/2" Ice 1" Ice 2" Ice	0.5840 0.5840 0.5840 0.5840
2" Rigid Conduit	C	No	No	Inside Pole	98.0000 - 0.0000	1	No Ice 1/2" Ice 1" Ice 2" Ice	2.8000 2.8000 2.8000 2.8000
***								
LDF4-50A(1/2)	B	No	No	Inside Pole	80.0000 - 0.0000	1	No Ice 1/2" Ice	0.1500 0.1500



Description	Face or Leg	Allow Shield	Exclude From Torque Calculation	Component Type	Placement ft	Total Number		C <sub>AA</sub> ft <sup>2</sup> /ft	Weight plf
							1" Ice	0.0000	0.1500
							2" Ice	0.0000	0.1500
***									
FSJ1-50A(1/4)	C	No	No	Inside Pole	72.0000 - 0.0000	3	No Ice	0.0000	0.0450
							1/2" Ice	0.0000	0.0450
							1" Ice	0.0000	0.0450
HJ4.5-50(5/8)	C	No	No	Inside Pole	72.0000 - 0.0000	3	2" Ice	0.0000	0.0450
							No Ice	0.0000	0.4000
							1/2" Ice	0.0000	0.4000
							1" Ice	0.0000	0.4000
							2" Ice	0.0000	0.4000
***									
***									

### Feed Line/Linear Appurtenances Section Areas

Tower Section	Tower Elevation ft	Face	A <sub>R</sub> ft <sup>2</sup>	A <sub>F</sub> ft <sup>2</sup>	C <sub>AA</sub> In Face ft <sup>2</sup>	C <sub>AA</sub> Out Face ft <sup>2</sup>	Weight K
L1	118.0000-113.0000	A	0.000	0.000	0.000	0.000	0.0000
		B	0.000	0.000	0.000	0.000	0.0046
		C	0.000	0.000	0.000	0.000	0.0000
L2	113.0000-108.0000	A	0.000	0.000	0.000	0.000	0.0000
		B	0.000	0.000	0.000	0.000	0.0231
		C	0.000	0.000	0.000	0.000	0.0000
L3	108.0000-103.0000	A	0.000	0.000	0.000	0.000	0.0000
		B	0.000	0.000	0.000	0.000	0.0602
		C	0.000	0.000	0.000	0.000	0.0000
L4	103.0000-98.0000	A	0.000	0.000	0.000	0.000	0.0000
		B	0.000	0.000	0.000	0.000	0.0602
		C	0.000	0.000	0.000	0.000	0.0000
L5	98.0000-93.0000	A	0.000	0.000	0.000	0.000	0.0000
		B	0.000	0.000	0.000	0.000	0.0602
		C	0.000	0.000	0.000	0.000	0.0399
L6	93.0000-90.0000	A	0.000	0.000	0.000	0.000	0.0000
		B	0.000	0.000	0.000	0.000	0.0361
		C	0.000	0.000	0.000	0.000	0.0240
L7	90.0000-85.0000	A	0.000	0.000	0.000	0.000	0.0000
		B	0.000	0.000	0.000	0.000	0.0602
		C	0.000	0.000	0.000	0.000	0.0399
L8	85.0000-80.0000	A	0.000	0.000	6.930	0.000	0.0533
		B	0.000	0.000	0.000	0.000	0.0602
		C	0.000	0.000	0.000	0.000	0.0399
L9	80.0000-76.5000	A	0.000	0.000	5.976	0.000	0.0373
		B	0.000	0.000	1.475	0.000	0.0448
		C	0.000	0.000	1.125	0.000	0.0280
L10	76.5000-76.2500	A	0.000	0.000	0.534	0.000	0.0027
		B	0.000	0.000	0.213	0.000	0.0032
		C	0.000	0.000	0.188	0.000	0.0020
L11	76.2500-74.0000	A	0.000	0.000	4.806	0.000	0.0240
		B	0.000	0.000	1.912	0.000	0.0288
		C	0.000	0.000	1.688	0.000	0.0180
L12	74.0000-73.7500	A	0.000	0.000	0.534	0.000	0.0027
		B	0.000	0.000	0.213	0.000	0.0032
		C	0.000	0.000	0.188	0.000	0.0020
L13	73.7500-68.8800	A	0.000	0.000	11.430	0.000	0.0519
		B	0.000	0.000	5.167	0.000	0.0623
		C	0.000	0.000	6.259	0.000	0.0614
L14	68.8800-68.6300	A	0.000	0.000	0.722	0.000	0.0027
		B	0.000	0.000	0.400	0.000	0.0032
		C	0.000	0.000	0.501	0.000	0.0038
L15	68.6300-64.5000	A	0.000	0.000	10.148	0.000	0.0440

Tower Sectio n	Tower Elevation ft	Face	A <sub>R</sub> ft <sup>2</sup>	A <sub>F</sub> ft <sup>2</sup>	C <sub>AA</sub> In Face ft <sup>2</sup>	C <sub>AA</sub> Out Face ft <sup>2</sup>	Weight K
		B	0.000	0.000	4.837	0.000	0.0528
		C	0.000	0.000	6.513	0.000	0.0628
L16	64.5000-64.2500	A	0.000	0.000	0.560	0.000	0.0027
		B	0.000	0.000	0.238	0.000	0.0032
		C	0.000	0.000	0.340	0.000	0.0038
L17	64.2500-63.0000	A	0.000	0.000	2.800	0.000	0.0133
		B	0.000	0.000	1.192	0.000	0.0160
		C	0.000	0.000	1.700	0.000	0.0190
L18	63.0000-62.7500	A	0.000	0.000	0.560	0.000	0.0027
		B	0.000	0.000	0.238	0.000	0.0032
		C	0.000	0.000	0.340	0.000	0.0038
L19	62.7500-60.0000	A	0.000	0.000	5.920	0.000	0.0293
		B	0.000	0.000	2.383	0.000	0.0352
		C	0.000	0.000	3.820	0.000	0.0465
L20	60.0000-59.7500	A	0.000	0.000	0.346	0.000	0.0027
		B	0.000	0.000	0.025	0.000	0.0032
		C	0.000	0.000	0.167	0.000	0.0044
L21	59.7500-54.7500	A	0.000	0.000	6.930	0.000	0.0533
		B	0.000	0.000	0.500	0.000	0.0640
		C	0.000	0.000	3.330	0.000	0.0878
L22	54.7500-49.7500	A	0.000	0.000	7.263	0.000	0.0533
		B	0.000	0.000	0.500	0.000	0.0640
		C	0.000	0.000	3.663	0.000	0.0878
L23	49.7500-49.2500	A	0.000	0.000	1.026	0.000	0.0053
		B	0.000	0.000	0.050	0.000	0.0064
		C	0.000	0.000	0.666	0.000	0.0088
L24	49.2500-49.0000	A	0.000	0.000	0.513	0.000	0.0027
		B	0.000	0.000	0.025	0.000	0.0032
		C	0.000	0.000	0.333	0.000	0.0044
L25	49.0000-44.0000	A	0.000	0.000	10.263	0.000	0.0533
		B	0.000	0.000	0.500	0.000	0.0640
		C	0.000	0.000	6.663	0.000	0.0878
L26	44.0000-42.0000	A	0.000	0.000	4.772	0.000	0.0213
		B	0.000	0.000	0.867	0.000	0.0256
		C	0.000	0.000	3.332	0.000	0.0351
L27	42.0000-41.7500	A	0.000	0.000	0.680	0.000	0.0027
		B	0.000	0.000	0.192	0.000	0.0032
		C	0.000	0.000	0.500	0.000	0.0044
L28	41.7500-36.7500	A	0.000	0.000	13.597	0.000	0.0533
		B	0.000	0.000	3.833	0.000	0.0640
		C	0.000	0.000	9.997	0.000	0.0878
L29	36.7500-34.5000	A	0.000	0.000	6.222	0.000	0.0240
		B	0.000	0.000	1.829	0.000	0.0288
		C	0.000	0.000	4.602	0.000	0.0395
L30	34.5000-34.2500	A	0.000	0.000	0.706	0.000	0.0027
		B	0.000	0.000	0.218	0.000	0.0032
		C	0.000	0.000	0.526	0.000	0.0044
L31	34.2500-34.0000	A	0.000	0.000	0.706	0.000	0.0027
		B	0.000	0.000	0.218	0.000	0.0032
		C	0.000	0.000	0.526	0.000	0.0044
L32	34.0000-33.7500	A	0.000	0.000	0.706	0.000	0.0027
		B	0.000	0.000	0.218	0.000	0.0032
		C	0.000	0.000	0.526	0.000	0.0044
L33	33.7500-30.0000	A	0.000	0.000	8.368	0.000	0.0400
		B	0.000	0.000	1.212	0.000	0.0480
		C	0.000	0.000	5.668	0.000	0.0658
L34	30.0000-29.7500	A	0.000	0.000	0.534	0.000	0.0027
		B	0.000	0.000	0.213	0.000	0.0032
		C	0.000	0.000	0.354	0.000	0.0044
L35	29.7500-28.5000	A	0.000	0.000	3.420	0.000	0.0133
		B	0.000	0.000	1.063	0.000	0.0160
		C	0.000	0.000	2.520	0.000	0.0219
L36	28.5000-28.2500	A	0.000	0.000	0.722	0.000	0.0027
		B	0.000	0.000	0.213	0.000	0.0032
		C	0.000	0.000	0.541	0.000	0.0044
L37	28.2500-23.2500	A	0.000	0.000	16.680	0.000	0.0533
		B	0.000	0.000	6.500	0.000	0.0640
		C	0.000	0.000	10.830	0.000	0.0878
L38	23.2500-23.0000	A	0.000	0.000	0.971	0.000	0.0027

Tower Sectio n	Tower Elevation ft	Face	A <sub>R</sub> ft <sup>2</sup>	A <sub>F</sub> ft <sup>2</sup>	C <sub>AA</sub> In Face ft <sup>2</sup>	C <sub>AA</sub> Out Face ft <sup>2</sup>	Weight K
		B	0.000	0.000	0.462	0.000	0.0032
		C	0.000	0.000	0.541	0.000	0.0044
L39	23.0000-21.5000	A	0.000	0.000	5.829	0.000	0.0160
		B	0.000	0.000	2.775	0.000	0.0192
		C	0.000	0.000	3.249	0.000	0.0263
L40	21.5000-21.2500	A	0.000	0.000	0.971	0.000	0.0027
		B	0.000	0.000	0.462	0.000	0.0032
		C	0.000	0.000	0.541	0.000	0.0044
L41	21.2500-19.0000	A	0.000	0.000	8.243	0.000	0.0240
		B	0.000	0.000	3.662	0.000	0.0288
		C	0.000	0.000	4.373	0.000	0.0395
L42	19.0000-18.7500	A	0.000	0.000	0.826	0.000	0.0027
		B	0.000	0.000	0.317	0.000	0.0032
		C	0.000	0.000	0.396	0.000	0.0044
L43	18.7500-18.5000	A	0.000	0.000	0.826	0.000	0.0027
		B	0.000	0.000	0.317	0.000	0.0032
		C	0.000	0.000	0.396	0.000	0.0044
L44	18.5000-18.2500	A	0.000	0.000	0.826	0.000	0.0027
		B	0.000	0.000	0.317	0.000	0.0032
		C	0.000	0.000	0.396	0.000	0.0044
L45	18.2500-13.2500	A	0.000	0.000	13.701	0.000	0.0533
		B	0.000	0.000	6.333	0.000	0.0640
		C	0.000	0.000	5.101	0.000	0.0878
L46	13.2500-12.7000	A	0.000	0.000	1.404	0.000	0.0059
		B	0.000	0.000	0.975	0.000	0.0070
		C	0.000	0.000	0.458	0.000	0.0097
L47	12.7000-12.4500	A	0.000	0.000	0.638	0.000	0.0027
		B	0.000	0.000	0.548	0.000	0.0032
		C	0.000	0.000	0.208	0.000	0.0044
L48	12.4500-11.5000	A	0.000	0.000	2.425	0.000	0.0101
		B	0.000	0.000	2.084	0.000	0.0122
		C	0.000	0.000	0.791	0.000	0.0167
L49	11.5000-11.2500	A	0.000	0.000	0.638	0.000	0.0027
		B	0.000	0.000	0.548	0.000	0.0032
		C	0.000	0.000	0.208	0.000	0.0044
L50	11.2500-10.5000	A	0.000	0.000	1.914	0.000	0.0080
		B	0.000	0.000	1.645	0.000	0.0096
		C	0.000	0.000	0.625	0.000	0.0132
L51	10.5000-10.2500	A	0.000	0.000	0.638	0.000	0.0027
		B	0.000	0.000	0.548	0.000	0.0032
		C	0.000	0.000	0.208	0.000	0.0044
L52	10.2500-7.5000	A	0.000	0.000	7.020	0.000	0.0293
		B	0.000	0.000	6.031	0.000	0.0352
		C	0.000	0.000	2.290	0.000	0.0483
L53	7.5000-7.2500	A	0.000	0.000	0.638	0.000	0.0027
		B	0.000	0.000	0.548	0.000	0.0032
		C	0.000	0.000	0.208	0.000	0.0044
L54	7.2500-6.2500	A	0.000	0.000	2.553	0.000	0.0107
		B	0.000	0.000	2.193	0.000	0.0128
		C	0.000	0.000	0.833	0.000	0.0176
L55	6.2500-6.0000	A	0.000	0.000	0.638	0.000	0.0027
		B	0.000	0.000	0.548	0.000	0.0032
		C	0.000	0.000	0.208	0.000	0.0044
L56	6.0000-3.7300	A	0.000	0.000	5.795	0.000	0.0242
		B	0.000	0.000	4.728	0.000	0.0290
		C	0.000	0.000	1.890	0.000	0.0398
L57	3.7300-3.4800	A	0.000	0.000	0.638	0.000	0.0027
		B	0.000	0.000	0.317	0.000	0.0032
		C	0.000	0.000	0.208	0.000	0.0044
L58	3.4800-2.7500	A	0.000	0.000	1.863	0.000	0.0078
		B	0.000	0.000	0.925	0.000	0.0093
		C	0.000	0.000	0.608	0.000	0.0128
L59	2.7500-2.5000	A	0.000	0.000	0.638	0.000	0.0027
		B	0.000	0.000	0.317	0.000	0.0032
		C	0.000	0.000	0.208	0.000	0.0044
L60	2.5000-2.0000	A	0.000	0.000	1.276	0.000	0.0053
		B	0.000	0.000	0.633	0.000	0.0064
		C	0.000	0.000	0.416	0.000	0.0088
L61	2.0000-1.7500	A	0.000	0.000	0.638	0.000	0.0027

Tower Section	Tower Elevation	Face	A <sub>R</sub>	A <sub>F</sub>	C <sub>A</sub> A <sub>A</sub> In Face	C <sub>A</sub> A <sub>A</sub> Out Face	Weight
n	ft		ft <sup>2</sup>	ft <sup>2</sup>	ft <sup>2</sup>	ft <sup>2</sup>	K
L62	1.7500-0.0000	B	0.000	0.000	0.317	0.000	0.0032
		C	0.000	0.000	0.208	0.000	0.0044
		A	0.000	0.000	3.884	0.000	0.0187
		B	0.000	0.000	1.633	0.000	0.0224
		C	0.000	0.000	1.374	0.000	0.0307

**Feed Line/Linear Appurtenances Section Areas - With Ice**

Tower Section	Tower Elevation	Face or Leg	Ice Thickness	A <sub>R</sub>	A <sub>F</sub>	C <sub>A</sub> A <sub>A</sub> In Face	C <sub>A</sub> A <sub>A</sub> Out Face	Weight
n	ft		in	ft <sup>2</sup>	ft <sup>2</sup>	ft <sup>2</sup>	ft <sup>2</sup>	K
L1	118.0000-113.0000	A	1.927	0.000	0.000	0.000	0.000	0.0000
		B		0.000	0.000	0.000	0.000	0.0046
		C		0.000	0.000	0.000	0.000	0.0000
L2	113.0000-108.0000	A	1.918	0.000	0.000	0.000	0.000	0.0000
		B		0.000	0.000	0.000	0.000	0.0231
		C		0.000	0.000	0.000	0.000	0.0000
L3	108.0000-103.0000	A	1.910	0.000	0.000	0.000	0.000	0.0000
		B		0.000	0.000	0.000	0.000	0.0602
		C		0.000	0.000	0.000	0.000	0.0000
L4	103.0000-98.0000	A	1.900	0.000	0.000	0.000	0.000	0.0000
		B		0.000	0.000	0.000	0.000	0.0602
		C		0.000	0.000	0.000	0.000	0.0000
L5	98.0000-93.0000	A	1.891	0.000	0.000	0.000	0.000	0.0000
		B		0.000	0.000	0.000	0.000	0.0602
		C		0.000	0.000	0.000	0.000	0.0399
L6	93.0000-90.0000	A	1.883	0.000	0.000	0.000	0.000	0.0000
		B		0.000	0.000	0.000	0.000	0.0361
		C		0.000	0.000	0.000	0.000	0.0240
L7	90.0000-85.0000	A	1.874	0.000	0.000	0.000	0.000	0.0000
		B		0.000	0.000	0.000	0.000	0.0602
		C		0.000	0.000	0.000	0.000	0.0399
L8	85.0000-80.0000	A	1.863	0.000	0.000	10.991	0.000	0.2138
		B		0.000	0.000	0.000	0.000	0.0602
		C		0.000	0.000	0.000	0.000	0.0399
L9	80.0000-76.5000	A	1.853	0.000	0.000	9.164	0.000	0.1685
		B		0.000	0.000	3.126	0.000	0.0869
		C		0.000	0.000	1.479	0.000	0.0474
L10	76.5000-76.2500	A	1.849	0.000	0.000	0.795	0.000	0.0139
		B		0.000	0.000	0.364	0.000	0.0080
		C		0.000	0.000	0.246	0.000	0.0052
L11	76.2500-74.0000	A	1.846	0.000	0.000	7.153	0.000	0.1246
		B		0.000	0.000	3.272	0.000	0.0723
		C		0.000	0.000	2.217	0.000	0.0470
L12	74.0000-73.7500	A	1.843	0.000	0.000	0.795	0.000	0.0138
		B		0.000	0.000	0.363	0.000	0.0080
		C		0.000	0.000	0.246	0.000	0.0052
L13	73.7500-68.8800	A	1.836	0.000	0.000	16.772	0.000	0.2859
		B		0.000	0.000	8.374	0.000	0.1733
		C		0.000	0.000	10.937	0.000	0.1972
L14	68.8800-68.6300	A	1.829	0.000	0.000	1.031	0.000	0.0169
		B		0.000	0.000	0.600	0.000	0.0112
		C		0.000	0.000	0.871	0.000	0.0146
L15	68.6300-64.5000	A	1.824	0.000	0.000	14.916	0.000	0.2585
		B		0.000	0.000	7.797	0.000	0.1636
		C		0.000	0.000	12.256	0.000	0.2207
L16	64.5000-64.2500	A	1.817	0.000	0.000	0.870	0.000	0.0165
		B		0.000	0.000	0.440	0.000	0.0108
		C		0.000	0.000	0.709	0.000	0.0143
L17	64.2500-63.0000	A	1.815	0.000	0.000	4.351	0.000	0.0826
		B		0.000	0.000	2.197	0.000	0.0540
		C		0.000	0.000	3.543	0.000	0.0712
L18	63.0000-62.7500	A	1.813	0.000	0.000	0.870	0.000	0.0165
		B		0.000	0.000	0.439	0.000	0.0108
		C		0.000	0.000	0.708	0.000	0.0142
L19	62.7500-60.0000	A	1.809	0.000	0.000	9.155	0.000	0.1723

Tower Section	Tower Elevation ft	Face or Leg	Ice Thickness in	A <sub>R</sub> ft <sup>2</sup>	A <sub>F</sub> ft <sup>2</sup>	C <sub>AA</sub> In Face ft <sup>2</sup>	C <sub>AA</sub> Out Face ft <sup>2</sup>	Weight K
		B		0.000	0.000	4.417	0.000	0.1095
		C		0.000	0.000	8.417	0.000	0.1670
L20	60.0000-59.7500	A	1.804	0.000	0.000	0.546	0.000	0.0104
		B		0.000	0.000	0.115	0.000	0.0047
		C		0.000	0.000	0.514	0.000	0.0106
L21	59.7500-54.7500	A	1.796	0.000	0.000	10.908	0.000	0.2080
		B		0.000	0.000	2.296	0.000	0.0946
		C		0.000	0.000	10.249	0.000	0.2117
L22	54.7500-49.7500	A	1.780	0.000	0.000	11.399	0.000	0.2122
		B		0.000	0.000	2.280	0.000	0.0942
		C		0.000	0.000	10.704	0.000	0.2156
L23	49.7500-49.2500	A	1.770	0.000	0.000	1.598	0.000	0.0262
		B		0.000	0.000	0.227	0.000	0.0094
		C		0.000	0.000	1.526	0.000	0.0265
L24	49.2500-49.0000	A	1.769	0.000	0.000	0.799	0.000	0.0131
		B		0.000	0.000	0.113	0.000	0.0047
		C		0.000	0.000	0.763	0.000	0.0132
L25	49.0000-44.0000	A	1.759	0.000	0.000	15.954	0.000	0.2601
		B		0.000	0.000	2.259	0.000	0.0936
		C		0.000	0.000	15.213	0.000	0.2632
L26	44.0000-42.0000	A	1.746	0.000	0.000	7.264	0.000	0.1143
		B		0.000	0.000	1.793	0.000	0.0482
		C		0.000	0.000	6.955	0.000	0.1154
L27	42.0000-41.7500	A	1.741	0.000	0.000	1.019	0.000	0.0156
		B		0.000	0.000	0.336	0.000	0.0074
		C		0.000	0.000	0.980	0.000	0.0158
L28	41.7500-36.7500	A	1.730	0.000	0.000	20.352	0.000	0.3103
		B		0.000	0.000	6.694	0.000	0.1468
		C		0.000	0.000	19.544	0.000	0.3130
L29	36.7500-34.5000	A	1.713	0.000	0.000	9.469	0.000	0.1490
		B		0.000	0.000	3.332	0.000	0.0762
		C		0.000	0.000	9.088	0.000	0.1501
L30	34.5000-34.2500	A	1.707	0.000	0.000	1.097	0.000	0.0180
		B		0.000	0.000	0.416	0.000	0.0099
		C		0.000	0.000	1.054	0.000	0.0181
L31	34.2500-34.0000	A	1.706	0.000	0.000	1.097	0.000	0.0180
		B		0.000	0.000	0.415	0.000	0.0099
		C		0.000	0.000	1.054	0.000	0.0181
L32	34.0000-33.7500	A	1.704	0.000	0.000	1.097	0.000	0.0179
		B		0.000	0.000	0.415	0.000	0.0099
		C		0.000	0.000	1.053	0.000	0.0181
L33	33.7500-30.0000	A	1.694	0.000	0.000	13.340	0.000	0.2281
		B		0.000	0.000	3.381	0.000	0.1108
		C		0.000	0.000	12.673	0.000	0.2298
L34	30.0000-29.7500	A	1.683	0.000	0.000	0.773	0.000	0.0128
		B		0.000	0.000	0.344	0.000	0.0074
		C		0.000	0.000	0.727	0.000	0.0129
L35	29.7500-28.5000	A	1.679	0.000	0.000	4.877	0.000	0.0750
		B		0.000	0.000	1.716	0.000	0.0370
		C		0.000	0.000	4.647	0.000	0.0755
L36	28.5000-28.2500	A	1.675	0.000	0.000	1.026	0.000	0.0155
		B		0.000	0.000	0.343	0.000	0.0074
		C		0.000	0.000	0.979	0.000	0.0156
L37	28.2500-23.2500	A	1.658	0.000	0.000	23.474	0.000	0.3371
		B		0.000	0.000	9.830	0.000	0.1760
		C		0.000	0.000	19.509	0.000	0.3095
L38	23.2500-23.0000	A	1.641	0.000	0.000	1.354	0.000	0.0185
		B		0.000	0.000	0.672	0.000	0.0105
		C		0.000	0.000	0.971	0.000	0.0153
L39	23.0000-21.5000	A	1.634	0.000	0.000	8.117	0.000	0.1103
		B		0.000	0.000	4.030	0.000	0.0627
		C		0.000	0.000	5.820	0.000	0.0915
L40	21.5000-21.2500	A	1.628	0.000	0.000	1.352	0.000	0.0183
		B		0.000	0.000	0.671	0.000	0.0104
		C		0.000	0.000	0.969	0.000	0.0152
L41	21.2500-19.0000	A	1.618	0.000	0.000	11.957	0.000	0.1692
		B		0.000	0.000	5.830	0.000	0.0985
		C		0.000	0.000	8.502	0.000	0.1413
L42	19.0000-18.7500	A	1.608	0.000	0.000	1.238	0.000	0.0181

Tower Section	Tower Elevation ft	Face or Leg	Ice Thickness in	A <sub>R</sub> ft <sup>2</sup>	A <sub>F</sub> ft <sup>2</sup>	C <sub>A</sub> A <sub>A</sub> In Face ft <sup>2</sup>	C <sub>A</sub> A <sub>A</sub> Out Face ft <sup>2</sup>	Weight K
		B		0.000	0.000	0.558	0.000	0.0103
		C		0.000	0.000	0.854	0.000	0.0150
L43	18.7500-18.5000	A	1.605	0.000	0.000	1.238	0.000	0.0181
		B		0.000	0.000	0.557	0.000	0.0103
		C		0.000	0.000	0.853	0.000	0.0150
L44	18.5000-18.2500	A	1.603	0.000	0.000	1.237	0.000	0.0180
		B		0.000	0.000	0.557	0.000	0.0103
		C		0.000	0.000	0.853	0.000	0.0150
L45	18.2500-13.2500	A	1.579	0.000	0.000	20.884	0.000	0.3161
		B		0.000	0.000	11.070	0.000	0.2023
		C		0.000	0.000	13.157	0.000	0.2557
L46	13.2500-12.7000	A	1.548	0.000	0.000	2.148	0.000	0.0327
		B		0.000	0.000	1.535	0.000	0.0257
		C		0.000	0.000	1.294	0.000	0.0262
L47	12.7000-12.4500	A	1.544	0.000	0.000	0.976	0.000	0.0148
		B		0.000	0.000	0.821	0.000	0.0131
		C		0.000	0.000	0.587	0.000	0.0119
L48	12.4500-11.5000	A	1.536	0.000	0.000	3.703	0.000	0.0561
		B		0.000	0.000	3.116	0.000	0.0496
		C		0.000	0.000	2.225	0.000	0.0450
L49	11.5000-11.2500	A	1.528	0.000	0.000	0.973	0.000	0.0147
		B		0.000	0.000	0.819	0.000	0.0130
		C		0.000	0.000	0.584	0.000	0.0118
L50	11.2500-10.5000	A	1.521	0.000	0.000	2.916	0.000	0.0439
		B		0.000	0.000	2.452	0.000	0.0387
		C		0.000	0.000	1.746	0.000	0.0352
L51	10.5000-10.2500	A	1.514	0.000	0.000	0.971	0.000	0.0146
		B		0.000	0.000	0.816	0.000	0.0129
		C		0.000	0.000	0.580	0.000	0.0117
L52	10.2500-7.5000	A	1.491	0.000	0.000	10.637	0.000	0.1581
		B		0.000	0.000	8.931	0.000	0.1392
		C		0.000	0.000	6.327	0.000	0.1269
L53	7.5000-7.2500	A	1.463	0.000	0.000	0.963	0.000	0.0141
		B		0.000	0.000	0.807	0.000	0.0124
		C		0.000	0.000	0.569	0.000	0.0114
L54	7.2500-6.2500	A	1.451	0.000	0.000	3.842	0.000	0.0561
		B		0.000	0.000	3.219	0.000	0.0493
		C		0.000	0.000	2.265	0.000	0.0451
L55	6.2500-6.0000	A	1.437	0.000	0.000	0.958	0.000	0.0139
		B		0.000	0.000	0.802	0.000	0.0122
		C		0.000	0.000	0.563	0.000	0.0112
L56	6.0000-3.7300	A	1.404	0.000	0.000	8.652	0.000	0.1237
		B		0.000	0.000	6.942	0.000	0.1053
		C		0.000	0.000	5.045	0.000	0.0996
L57	3.7300-3.4800	A	1.362	0.000	0.000	0.946	0.000	0.0133
		B		0.000	0.000	0.521	0.000	0.0089
		C		0.000	0.000	0.546	0.000	0.0107
L58	3.4800-2.7500	A	1.343	0.000	0.000	2.753	0.000	0.0383
		B		0.000	0.000	1.513	0.000	0.0255
		C		0.000	0.000	1.582	0.000	0.0309
L59	2.7500-2.5000	A	1.320	0.000	0.000	0.939	0.000	0.0129
		B		0.000	0.000	0.515	0.000	0.0086
		C		0.000	0.000	0.537	0.000	0.0104
L60	2.5000-2.0000	A	1.300	0.000	0.000	1.872	0.000	0.0255
		B		0.000	0.000	1.023	0.000	0.0170
		C		0.000	0.000	1.064	0.000	0.0206
L61	2.0000-1.7500	A	1.276	0.000	0.000	0.932	0.000	0.0125
		B		0.000	0.000	0.508	0.000	0.0084
		C		0.000	0.000	0.527	0.000	0.0102
L62	1.7500-0.0000	A	1.182	0.000	0.000	5.599	0.000	0.0747
		B		0.000	0.000	2.638	0.000	0.0474
		C		0.000	0.000	3.339	0.000	0.0637

**Feed Line Center of Pressure**

Section	Elevation	CP <sub>x</sub>	CP <sub>z</sub>	CP <sub>x</sub> Ice	CP <sub>z</sub> Ice
	ft	in	in	in	in
L1	118.0000-113.0000	0.0000	0.0000	0.0000	0.0000
L2	113.0000-108.0000	0.0000	0.0000	0.0000	0.0000
L3	108.0000-103.0000	0.0000	0.0000	0.0000	0.0000
L4	103.0000-98.0000	0.0000	0.0000	0.0000	0.0000
L5	98.0000-93.0000	0.0000	0.0000	0.0000	0.0000
L6	93.0000-90.0000	0.0000	0.0000	0.0000	0.0000
L7	90.0000-85.0000	0.0000	0.0000	0.0000	0.0000
L8	85.0000-80.0000	-1.5578	-7.3290	-1.1241	-5.2884
L9	80.0000-76.5000	-0.8071	-5.0209	-0.1736	-3.6525
L10	76.5000-76.2500	-0.5968	-3.7131	-0.1422	-2.9752
L11	76.2500-74.0000	-0.5968	-3.7131	-0.1427	-2.9757
L12	74.0000-73.7500	-0.5968	-3.7131	-0.1433	-2.9761
L13	73.7500-68.8800	-0.8798	-2.2212	-0.9860	-1.6803
L14	68.8800-68.6300	-0.9012	-1.5982	-1.1612	-1.0463
L15	68.6300-64.5000	-1.0555	-1.8720	-1.2985	-1.1721
L16	64.5000-64.2500	-1.1355	-2.0138	-1.3237	-1.1971
L17	64.2500-63.0000	-1.1355	-2.0138	-1.3236	-1.1978
L18	63.0000-62.7500	-1.1355	-2.0138	-1.3236	-1.1986
L19	62.7500-60.0000	-1.3458	-1.9525	-1.6512	-1.0029
L20	60.0000-59.7500	-3.3012	-4.3901	-2.7985	-1.4105
L21	59.7500-54.7500	-3.3012	-4.3901	-2.7974	-1.4158
L22	54.7500-49.7500	-3.2873	-3.6005	-2.7974	-1.0339
L23	49.7500-49.2500	-2.4491	1.2301	-2.8079	1.8883
L24	49.2500-49.0000	-2.4491	1.2301	-2.8078	1.8876
L25	49.0000-44.0000	-2.4491	1.2301	-2.8067	1.8826
L26	44.0000-42.0000	-2.1052	1.0574	-2.5078	1.6768
L27	42.0000-41.7500	-1.8460	0.9272	-2.2669	1.5141
L28	41.7500-36.7500	-1.8460	0.9272	-2.2653	1.5091
L29	36.7500-34.5000	-1.7969	0.9026	-2.1811	1.4472
L30	34.5000-34.2500	-1.7392	0.8736	-2.0860	1.3821
L31	34.2500-34.0000	-1.7392	0.8736	-2.0859	1.3816
L32	34.0000-33.7500	-1.7392	0.8736	-2.0857	1.3811
L33	33.7500-30.0000	-2.1509	0.8783	-2.4576	1.4604
L34	30.0000-29.7500	-2.3013	-3.0271	-2.4422	-1.2770
L35	29.7500-28.5000	-2.5872	-1.4323	-3.0478	-0.6277
L36	28.5000-28.2500	-2.7498	-1.2381	-3.1736	-0.4881
L37	28.2500-23.2500	-2.1150	-0.4585	-2.6003	0.1115
L38	23.2500-23.0000	-1.4801	0.3212	-2.0085	0.7315
L39	23.0000-21.5000	-1.4801	0.3212	-2.0076	0.7293
L40	21.5000-21.2500	-1.4801	0.3212	-2.0068	0.7270
L41	21.2500-19.0000	-1.5550	0.3375	-2.0222	0.7297
L42	19.0000-18.7500	-1.7221	0.3737	-2.1499	0.7724
L43	18.7500-18.5000	-1.7221	0.3737	-2.1498	0.7717
L44	18.5000-18.2500	-1.7221	0.3737	-2.1496	0.7709
L45	18.2500-13.2500	-0.9396	-0.1647	-1.5702	0.3767
L46	13.2500-12.7000	-1.6138	-1.4149	-2.0118	-0.5421
L47	12.7000-12.4500	-2.3539	-2.1921	-2.5293	-1.1304
L48	12.4500-11.5000	-2.3539	-2.1921	-2.5290	-1.1349
L49	11.5000-11.2500	-2.3539	-2.1921	-2.5287	-1.1396
L50	11.2500-10.5000	-2.3539	-2.1921	-2.5284	-1.1437
L51	10.5000-10.2500	-2.3539	-2.1921	-2.5282	-1.1481
L52	10.2500-7.5000	-2.3539	-2.1921	-2.5273	-1.1623
L53	7.5000-7.2500	-2.3539	-2.1921	-2.5263	-1.1791
L54	7.2500-6.2500	-2.3539	-2.1921	-2.5258	-1.1871
L55	6.2500-6.0000	-2.3539	-2.1921	-2.5253	-1.1958
L56	6.0000-3.7300	-2.1668	-1.9956	-2.3895	-1.0652
L57	3.7300-3.4800	-0.6278	-0.3793	-1.3074	0.1216
L58	3.4800-2.7500	-0.6278	-0.3793	-1.3034	0.1113
L59	2.7500-2.5000	-0.6278	-0.3793	-1.2988	0.0993
L60	2.5000-2.0000	-0.6278	-0.3793	-1.2946	0.0885
L61	2.0000-1.7500	-0.6278	-0.3793	-1.2898	0.0759
L62	1.7500-0.0000	-1.0351	-1.0080	-1.6600	-0.4345

Note: For pole sections, center of pressure calculations do not consider feed line shielding.

### Shielding Factor Ka

Tower Section	Feed Line Record No.	Description	Feed Line Segment Elev.	K <sub>a</sub> No Ice	K <sub>a</sub> Ice
L8	57	LDF7-50A(1-5/8)	80.00 - 85.00	1.0000	1.0000
L9	34	CCI-65FP-045100	76.50 - 78.00	1.0000	1.0000
L9	35	CCI-65FP-045100	76.50 - 78.00	1.0000	1.0000
L9	36	CCI-65FP-045100	76.50 - 78.00	1.0000	1.0000
L9	57	LDF7-50A(1-5/8)	76.50 - 80.00	1.0000	1.0000
L9	62	1" Rigid Conduit	76.50 - 80.00	1.0000	1.0000
L10	34	CCI-65FP-045100	76.25 - 76.50	1.0000	1.0000
L10	35	CCI-65FP-045100	76.25 - 76.50	1.0000	1.0000
L10	36	CCI-65FP-045100	76.25 - 76.50	1.0000	1.0000
L10	57	LDF7-50A(1-5/8)	76.25 - 76.50	1.0000	1.0000
L10	62	1" Rigid Conduit	76.25 - 76.50	1.0000	1.0000
L11	34	CCI-65FP-045100	74.00 - 76.25	1.0000	1.0000
L11	35	CCI-65FP-045100	74.00 - 76.25	1.0000	1.0000
L11	36	CCI-65FP-045100	74.00 - 76.25	1.0000	1.0000
L11	57	LDF7-50A(1-5/8)	74.00 - 76.25	1.0000	1.0000
L11	62	1" Rigid Conduit	74.00 - 76.25	1.0000	1.0000
L12	34	CCI-65FP-045100	73.75 - 74.00	1.0000	1.0000
L12	35	CCI-65FP-045100	73.75 - 74.00	1.0000	1.0000
L12	36	CCI-65FP-045100	73.75 - 74.00	1.0000	1.0000
L12	57	LDF7-50A(1-5/8)	73.75 - 74.00	1.0000	1.0000
L12	62	1" Rigid Conduit	73.75 - 74.00	1.0000	1.0000
L13	19	CCI-65FP-045100	68.88 - 70.25	1.0000	1.0000
L13	20	CCI-65FP-045100	68.88 - 70.25	1.0000	1.0000
L13	21	CCI-65FP-045100	68.88 - 70.25	1.0000	1.0000
L13	34	CCI-65FP-045100	68.88 - 73.75	1.0000	1.0000
L13	35	CCI-65FP-045100	68.88 - 73.75	1.0000	1.0000
L13	36	CCI-65FP-045100	68.88 - 73.75	1.0000	1.0000
L13	57	LDF7-50A(1-5/8)	68.88 - 73.75	1.0000	1.0000
L13	62	1" Rigid Conduit	68.88 - 73.75	1.0000	1.0000
L13	65	FSJ4P-50B-1(1/2)	68.88 - 72.00	1.0000	1.0000
L13	67	2" Rigid Conduit	68.88 -	1.0000	1.0000



Tower Section	Feed Line Record No.	Description	Feed Line Segment Elev.	K <sub>a</sub> No Ice	K <sub>a</sub> Ice
			72.00		
L14	19	CCI-65FP-045100	68.63 - 68.88	1.0000	1.0000
L14	20	CCI-65FP-045100	68.63 - 68.88	1.0000	1.0000
L14	21	CCI-65FP-045100	68.63 - 68.88	1.0000	1.0000
L14	34	CCI-65FP-045100	68.63 - 68.88	1.0000	1.0000
L14	35	CCI-65FP-045100	68.63 - 68.88	1.0000	1.0000
L14	36	CCI-65FP-045100	68.63 - 68.88	1.0000	1.0000
L14	57	LDF7-50A(1-5/8)	68.63 - 68.88	1.0000	1.0000
L14	62	1" Rigid Conduit	68.63 - 68.88	1.0000	1.0000
L14	65	FSJ4P-50B-1(1/2)	68.63 - 68.88	1.0000	1.0000
L14	67	2" Rigid Conduit	68.63 - 68.88	1.0000	1.0000
L15	9	MS-400	64.50 - 65.50	1.0000	1.0000
L15	10	MS-400	64.50 - 65.50	1.0000	1.0000
L15	11	MS-400	64.50 - 65.50	1.0000	1.0000
L15	19	CCI-65FP-045100	64.50 - 68.63	1.0000	1.0000
L15	20	CCI-65FP-045100	64.50 - 68.63	1.0000	1.0000
L15	21	CCI-65FP-045100	64.50 - 68.63	1.0000	1.0000
L15	34	CCI-65FP-045100	67.00 - 68.63	1.0000	1.0000
L15	35	CCI-65FP-045100	67.00 - 68.63	1.0000	1.0000
L15	36	CCI-65FP-045100	67.00 - 68.63	1.0000	1.0000
L15	57	LDF7-50A(1-5/8)	64.50 - 68.63	1.0000	1.0000
L15	62	1" Rigid Conduit	64.50 - 68.63	1.0000	1.0000
L15	65	FSJ4P-50B-1(1/2)	64.50 - 68.63	1.0000	1.0000
L15	67	2" Rigid Conduit	64.50 - 68.63	1.0000	1.0000
L16	9	MS-400	64.25 - 64.50	1.0000	1.0000
L16	10	MS-400	64.25 - 64.50	1.0000	1.0000
L16	11	MS-400	64.25 - 64.50	1.0000	1.0000
L16	19	CCI-65FP-045100	64.25 - 64.50	1.0000	1.0000
L16	20	CCI-65FP-045100	64.25 - 64.50	1.0000	1.0000
L16	21	CCI-65FP-045100	64.25 - 64.50	1.0000	1.0000
L16	57	LDF7-50A(1-5/8)	64.25 - 64.50	1.0000	1.0000
L16	62	1" Rigid Conduit	64.25 - 64.50	1.0000	1.0000
L16	65	FSJ4P-50B-1(1/2)	64.25 - 64.50	1.0000	1.0000
L16	67	2" Rigid Conduit	64.25 - 64.50	1.0000	1.0000
L17	9	MS-400	63.00 - 64.25	1.0000	1.0000

Tower Section	Feed Line Record No.	Description	Feed Line Segment Elev.	K <sub>a</sub> No Ice	K <sub>a</sub> Ice
L17	10	MS-400	63.00 - 64.25	1.0000	1.0000
L17	11	MS-400	63.00 - 64.25	1.0000	1.0000
L17	19	CCI-65FP-045100	63.00 - 64.25	1.0000	1.0000
L17	20	CCI-65FP-045100	63.00 - 64.25	1.0000	1.0000
L17	21	CCI-65FP-045100	63.00 - 64.25	1.0000	1.0000
L17	57	LDF7-50A(1-5/8)	63.00 - 64.25	1.0000	1.0000
L17	62	1" Rigid Conduit	63.00 - 64.25	1.0000	1.0000
L17	65	FSJ4P-50B-1(1/2)	63.00 - 64.25	1.0000	1.0000
L17	67	2" Rigid Conduit	63.00 - 64.25	1.0000	1.0000
L18	9	MS-400	62.75 - 63.00	1.0000	1.0000
L18	10	MS-400	62.75 - 63.00	1.0000	1.0000
L18	11	MS-400	62.75 - 63.00	1.0000	1.0000
L18	19	CCI-65FP-045100	62.75 - 63.00	1.0000	1.0000
L18	20	CCI-65FP-045100	62.75 - 63.00	1.0000	1.0000
L18	21	CCI-65FP-045100	62.75 - 63.00	1.0000	1.0000
L18	57	LDF7-50A(1-5/8)	62.75 - 63.00	1.0000	1.0000
L18	62	1" Rigid Conduit	62.75 - 63.00	1.0000	1.0000
L18	65	FSJ4P-50B-1(1/2)	62.75 - 63.00	1.0000	1.0000
L18	67	2" Rigid Conduit	62.75 - 63.00	1.0000	1.0000
L19	9	MS-400	60.50 - 62.75	1.0000	1.0000
L19	10	MS-400	60.50 - 62.75	1.0000	1.0000
L19	11	MS-400	60.50 - 62.75	1.0000	1.0000
L19	19	CCI-65FP-045100	60.25 - 62.75	1.0000	1.0000
L19	20	CCI-65FP-045100	60.25 - 62.75	1.0000	1.0000
L19	21	CCI-65FP-045100	60.25 - 62.75	1.0000	1.0000
L19	57	LDF7-50A(1-5/8)	60.00 - 62.75	1.0000	1.0000
L19	62	1" Rigid Conduit	60.00 - 62.75	1.0000	1.0000
L19	65	FSJ4P-50B-1(1/2)	60.00 - 62.75	1.0000	1.0000
L19	67	2" Rigid Conduit	60.00 - 62.75	1.0000	1.0000
L19	69	CU12PSM9P6XXX(1-1/2)	60.00 - 62.00	1.0000	1.0000
L20	57	LDF7-50A(1-5/8)	59.75 - 60.00	1.0000	1.0000
L20	62	1" Rigid Conduit	59.75 - 60.00	1.0000	1.0000
L20	65	FSJ4P-50B-1(1/2)	59.75 - 60.00	1.0000	1.0000
L20	67	2" Rigid Conduit	59.75 - 60.00	1.0000	1.0000
L20	69	CU12PSM9P6XXX(1-1/2)	59.75 -	1.0000	1.0000

Tower Section	Feed Line Record No.	Description	Feed Line Segment Elev.	K <sub>a</sub> No Ice	K <sub>a</sub> Ice
			60.00		
L21	57	LDF7-50A(1-5/8)	54.75 - 59.75	1.0000	1.0000
L21	62	1" Rigid Conduit	54.75 - 59.75	1.0000	1.0000
L21	65	FSJ4P-50B-1(1/2)	54.75 - 59.75	1.0000	1.0000
L21	67	2" Rigid Conduit	54.75 - 59.75	1.0000	1.0000
L21	69	CU12PSM9P6XXX(1-1/2)	54.75 - 59.75	1.0000	1.0000
L22	28	CCI-65FP-040075	49.75 - 50.25	1.0000	1.0000
L22	29	CCI-65FP-040075	49.75 - 50.25	1.0000	1.0000
L22	57	LDF7-50A(1-5/8)	49.75 - 54.75	1.0000	1.0000
L22	62	1" Rigid Conduit	49.75 - 54.75	1.0000	1.0000
L22	65	FSJ4P-50B-1(1/2)	49.75 - 54.75	1.0000	1.0000
L22	67	2" Rigid Conduit	49.75 - 54.75	1.0000	1.0000
L22	69	CU12PSM9P6XXX(1-1/2)	49.75 - 54.75	1.0000	1.0000
L23	28	CCI-65FP-040075	49.25 - 49.75	1.0000	1.0000
L23	29	CCI-65FP-040075	49.25 - 49.75	1.0000	1.0000
L23	57	LDF7-50A(1-5/8)	49.25 - 49.75	1.0000	1.0000
L23	62	1" Rigid Conduit	49.25 - 49.75	1.0000	1.0000
L23	65	FSJ4P-50B-1(1/2)	49.25 - 49.75	1.0000	1.0000
L23	67	2" Rigid Conduit	49.25 - 49.75	1.0000	1.0000
L23	69	CU12PSM9P6XXX(1-1/2)	49.25 - 49.75	1.0000	1.0000
L24	28	CCI-65FP-040075	49.00 - 49.25	1.0000	1.0000
L24	29	CCI-65FP-040075	49.00 - 49.25	1.0000	1.0000
L24	57	LDF7-50A(1-5/8)	49.00 - 49.25	1.0000	1.0000
L24	62	1" Rigid Conduit	49.00 - 49.25	1.0000	1.0000
L24	65	FSJ4P-50B-1(1/2)	49.00 - 49.25	1.0000	1.0000
L24	67	2" Rigid Conduit	49.00 - 49.25	1.0000	1.0000
L24	69	CU12PSM9P6XXX(1-1/2)	49.00 - 49.25	1.0000	1.0000
L25	28	CCI-65FP-040075	44.00 - 49.00	1.0000	1.0000
L25	29	CCI-65FP-040075	44.00 - 49.00	1.0000	1.0000
L25	57	LDF7-50A(1-5/8)	44.00 - 49.00	1.0000	1.0000
L25	62	1" Rigid Conduit	44.00 - 49.00	1.0000	1.0000
L25	65	FSJ4P-50B-1(1/2)	44.00 - 49.00	1.0000	1.0000
L25	67	2" Rigid Conduit	44.00 - 49.00	1.0000	1.0000
L25	69	CU12PSM9P6XXX(1-1/2)	44.00 - 49.00	1.0000	1.0000
L26	22	CCI-65FP-040075	42.00 - 43.00	1.0000	1.0000

Tower Section	Feed Line Record No.	Description	Feed Line Segment Elev.	K <sub>a</sub> No Ice	K <sub>a</sub> Ice
L26	23	CCI-65FP-040075	42.00 - 43.00	1.0000	1.0000
L26	24	CCI-65FP-040075	42.00 - 43.00	1.0000	1.0000
L26	28	CCI-65FP-040075	42.00 - 44.00	1.0000	1.0000
L26	29	CCI-65FP-040075	42.00 - 44.00	1.0000	1.0000
L26	57	LDF7-50A(1-5/8)	42.00 - 44.00	1.0000	1.0000
L26	62	1" Rigid Conduit	42.00 - 44.00	1.0000	1.0000
L26	65	FSJ4P-50B-1(1/2)	42.00 - 44.00	1.0000	1.0000
L26	67	2" Rigid Conduit	42.00 - 44.00	1.0000	1.0000
L26	69	CU12PSM9P6XXX(1-1/2)	42.00 - 44.00	1.0000	1.0000
L27	22	CCI-65FP-040075	41.75 - 42.00	1.0000	1.0000
L27	23	CCI-65FP-040075	41.75 - 42.00	1.0000	1.0000
L27	24	CCI-65FP-040075	41.75 - 42.00	1.0000	1.0000
L27	28	CCI-65FP-040075	41.75 - 42.00	1.0000	1.0000
L27	29	CCI-65FP-040075	41.75 - 42.00	1.0000	1.0000
L27	57	LDF7-50A(1-5/8)	41.75 - 42.00	1.0000	1.0000
L27	62	1" Rigid Conduit	41.75 - 42.00	1.0000	1.0000
L27	65	FSJ4P-50B-1(1/2)	41.75 - 42.00	1.0000	1.0000
L27	67	2" Rigid Conduit	41.75 - 42.00	1.0000	1.0000
L27	69	CU12PSM9P6XXX(1-1/2)	41.75 - 42.00	1.0000	1.0000
L28	22	CCI-65FP-040075	36.75 - 41.75	1.0000	1.0000
L28	23	CCI-65FP-040075	36.75 - 41.75	1.0000	1.0000
L28	24	CCI-65FP-040075	36.75 - 41.75	1.0000	1.0000
L28	28	CCI-65FP-040075	36.75 - 41.75	1.0000	1.0000
L28	29	CCI-65FP-040075	36.75 - 41.75	1.0000	1.0000
L28	57	LDF7-50A(1-5/8)	36.75 - 41.75	1.0000	1.0000
L28	62	1" Rigid Conduit	36.75 - 41.75	1.0000	1.0000
L28	65	FSJ4P-50B-1(1/2)	36.75 - 41.75	1.0000	1.0000
L28	67	2" Rigid Conduit	36.75 - 41.75	1.0000	1.0000
L28	69	CU12PSM9P6XXX(1-1/2)	36.75 - 41.75	1.0000	1.0000
L29	12	MS-400	34.50 - 35.50	1.0000	1.0000
L29	13	MS-400	34.50 - 35.50	1.0000	1.0000
L29	14	MS-400	34.50 - 35.50	1.0000	1.0000
L29	22	CCI-65FP-040075	34.50 - 36.75	1.0000	1.0000
L29	23	CCI-65FP-040075	34.50 - 36.75	1.0000	1.0000
L29	24	CCI-65FP-040075	34.50 -	1.0000	1.0000

Tower Section	Feed Line Record No.	Description	Feed Line Segment Elev.	K <sub>a</sub> No Ice	K <sub>a</sub> Ice
L29	28	CCI-65FP-040075	36.75 34.50 -	1.0000	1.0000
L29	29	CCI-65FP-040075	36.75 34.50 -	1.0000	1.0000
L29	57	LDF7-50A(1-5/8)	36.75 34.50 -	1.0000	1.0000
L29	62	1" Rigid Conduit	36.75 34.50 -	1.0000	1.0000
L29	65	FSJ4P-50B-1(1/2)	36.75 34.50 -	1.0000	1.0000
L29	67	2" Rigid Conduit	36.75 34.50 -	1.0000	1.0000
L29	69	CU12PSM9P6XXX(1-1/2)	36.75 34.50 -	1.0000	1.0000
L30	12	MS-400	34.25 - 34.50	1.0000	1.0000
L30	13	MS-400	34.25 - 34.50	1.0000	1.0000
L30	14	MS-400	34.25 - 34.50	1.0000	1.0000
L30	22	CCI-65FP-040075	34.25 - 34.50	1.0000	1.0000
L30	23	CCI-65FP-040075	34.25 - 34.50	1.0000	1.0000
L30	24	CCI-65FP-040075	34.25 - 34.50	1.0000	1.0000
L30	28	CCI-65FP-040075	34.25 - 34.50	1.0000	1.0000
L30	29	CCI-65FP-040075	34.25 - 34.50	1.0000	1.0000
L30	57	LDF7-50A(1-5/8)	34.25 - 34.50	1.0000	1.0000
L30	62	1" Rigid Conduit	34.25 - 34.50	1.0000	1.0000
L30	65	FSJ4P-50B-1(1/2)	34.25 - 34.50	1.0000	1.0000
L30	67	2" Rigid Conduit	34.25 - 34.50	1.0000	1.0000
L30	69	CU12PSM9P6XXX(1-1/2)	34.25 - 34.50	1.0000	1.0000
L31	12	MS-400	34.00 - 34.25	1.0000	1.0000
L31	13	MS-400	34.00 - 34.25	1.0000	1.0000
L31	14	MS-400	34.00 - 34.25	1.0000	1.0000
L31	22	CCI-65FP-040075	34.00 - 34.25	1.0000	1.0000
L31	23	CCI-65FP-040075	34.00 - 34.25	1.0000	1.0000
L31	24	CCI-65FP-040075	34.00 - 34.25	1.0000	1.0000
L31	28	CCI-65FP-040075	34.00 - 34.25	1.0000	1.0000
L31	29	CCI-65FP-040075	34.00 - 34.25	1.0000	1.0000
L31	57	LDF7-50A(1-5/8)	34.00 - 34.25	1.0000	1.0000
L31	62	1" Rigid Conduit	34.00 - 34.25	1.0000	1.0000
L31	65	FSJ4P-50B-1(1/2)	34.00 - 34.25	1.0000	1.0000
L31	67	2" Rigid Conduit	34.00 - 34.25	1.0000	1.0000
L31	69	CU12PSM9P6XXX(1-1/2)	34.00 - 34.25	1.0000	1.0000
L32	12	MS-400	33.75 - 34.00	1.0000	1.0000

Tower Section	Feed Line Record No.	Description	Feed Line Segment Elev.	K <sub>a</sub> No Ice	K <sub>a</sub> Ice
L32	13	MS-400	33.75 - 34.00	1.0000	1.0000
L32	14	MS-400	33.75 - 34.00	1.0000	1.0000
L32	22	CCI-65FP-040075	33.75 - 34.00	1.0000	1.0000
L32	23	CCI-65FP-040075	33.75 - 34.00	1.0000	1.0000
L32	24	CCI-65FP-040075	33.75 - 34.00	1.0000	1.0000
L32	28	CCI-65FP-040075	33.75 - 34.00	1.0000	1.0000
L32	29	CCI-65FP-040075	33.75 - 34.00	1.0000	1.0000
L32	57	LDF7-50A(1-5/8)	33.75 - 34.00	1.0000	1.0000
L32	62	1" Rigid Conduit	33.75 - 34.00	1.0000	1.0000
L32	65	FSJ4P-50B-1(1/2)	33.75 - 34.00	1.0000	1.0000
L32	67	2" Rigid Conduit	33.75 - 34.00	1.0000	1.0000
L32	69	CU12PSM9P6XXX(1-1/2)	33.75 - 34.00	1.0000	1.0000
L33	12	MS-400	30.50 - 33.75	1.0000	1.0000
L33	13	MS-400	30.50 - 33.75	1.0000	1.0000
L33	14	MS-400	30.50 - 33.75	1.0000	1.0000
L33	22	CCI-65FP-040075	33.00 - 33.75	1.0000	1.0000
L33	23	CCI-65FP-040075	33.00 - 33.75	1.0000	1.0000
L33	24	CCI-65FP-040075	33.00 - 33.75	1.0000	1.0000
L33	28	CCI-65FP-040075	30.25 - 33.75	1.0000	1.0000
L33	29	CCI-65FP-040075	30.25 - 33.75	1.0000	1.0000
L33	57	LDF7-50A(1-5/8)	30.00 - 33.75	1.0000	1.0000
L33	62	1" Rigid Conduit	30.00 - 33.75	1.0000	1.0000
L33	65	FSJ4P-50B-1(1/2)	30.00 - 33.75	1.0000	1.0000
L33	67	2" Rigid Conduit	30.00 - 33.75	1.0000	1.0000
L33	69	CU12PSM9P6XXX(1-1/2)	30.00 - 33.75	1.0000	1.0000
L34	30	CCI-65FP-045100	29.75 - 30.00	1.0000	1.0000
L34	31	CCI-65FP-045100	29.75 - 30.00	1.0000	1.0000
L34	32	CCI-65FP-045100	29.75 - 30.00	1.0000	1.0000
L34	57	LDF7-50A(1-5/8)	29.75 - 30.00	1.0000	1.0000
L34	62	1" Rigid Conduit	29.75 - 30.00	1.0000	1.0000
L34	65	FSJ4P-50B-1(1/2)	29.75 - 30.00	1.0000	1.0000
L34	67	2" Rigid Conduit	29.75 - 30.00	1.0000	1.0000
L34	69	CU12PSM9P6XXX(1-1/2)	29.75 - 30.00	1.0000	1.0000
L35	30	CCI-65FP-045100	28.50 - 29.75	1.0000	1.0000
L35	31	CCI-65FP-045100	28.50 -	1.0000	1.0000

Tower Section	Feed Line Record No.	Description	Feed Line Segment Elev.	K <sub>a</sub> No Ice	K <sub>a</sub> Ice
			29.75		
L35	32	CCI-65FP-045100	28.50 -	1.0000	1.0000
			29.75		
L35	37	CCI-65FP-045100	28.50 -	1.0000	1.0000
			29.50		
L35	38	CCI-65FP-045100	28.50 -	1.0000	1.0000
			29.50		
L35	57	LDF7-50A(1-5/8)	28.50 -	1.0000	1.0000
			29.75		
L35	62	1" Rigid Conduit	28.50 -	1.0000	1.0000
			29.75		
L35	65	FSJ4P-50B-1(1/2)	28.50 -	1.0000	1.0000
			29.75		
L35	67	2" Rigid Conduit	28.50 -	1.0000	1.0000
			29.75		
L35	69	CU12PSM9P6XXX(1-1/2)	28.50 -	1.0000	1.0000
			29.75		
L36	30	CCI-65FP-045100	28.25 -	1.0000	1.0000
			28.50		
L36	31	CCI-65FP-045100	28.25 -	1.0000	1.0000
			28.50		
L36	32	CCI-65FP-045100	28.25 -	1.0000	1.0000
			28.50		
L36	37	CCI-65FP-045100	28.25 -	1.0000	1.0000
			28.50		
L36	38	CCI-65FP-045100	28.25 -	1.0000	1.0000
			28.50		
L36	57	LDF7-50A(1-5/8)	28.25 -	1.0000	1.0000
			28.50		
L36	62	1" Rigid Conduit	28.25 -	1.0000	1.0000
			28.50		
L36	65	FSJ4P-50B-1(1/2)	28.25 -	1.0000	1.0000
			28.50		
L36	67	2" Rigid Conduit	28.25 -	1.0000	1.0000
			28.50		
L36	69	CU12PSM9P6XXX(1-1/2)	28.25 -	1.0000	1.0000
			28.50		
L37	25	CCI-65FP-060100	23.25 -	1.0000	1.0000
			25.50		
L37	26	CCI-65FP-060100	23.25 -	1.0000	1.0000
			25.50		
L37	30	CCI-65FP-045100	23.25 -	1.0000	1.0000
			28.25		
L37	31	CCI-65FP-045100	23.25 -	1.0000	1.0000
			28.25		
L37	32	CCI-65FP-045100	23.25 -	1.0000	1.0000
			28.25		
L37	37	CCI-65FP-045100	23.25 -	1.0000	1.0000
			28.25		
L37	38	CCI-65FP-045100	23.25 -	1.0000	1.0000
			28.25		
L37	57	LDF7-50A(1-5/8)	23.25 -	1.0000	1.0000
			28.25		
L37	62	1" Rigid Conduit	23.25 -	1.0000	1.0000
			28.25		
L37	65	FSJ4P-50B-1(1/2)	23.25 -	1.0000	1.0000
			28.25		
L37	67	2" Rigid Conduit	23.25 -	1.0000	1.0000
			28.25		
L37	69	CU12PSM9P6XXX(1-1/2)	23.25 -	1.0000	1.0000
			28.25		
L38	25	CCI-65FP-060100	23.00 -	1.0000	1.0000
			23.25		
L38	26	CCI-65FP-060100	23.00 -	1.0000	1.0000
			23.25		
L38	30	CCI-65FP-045100	23.00 -	1.0000	1.0000
			23.25		
L38	31	CCI-65FP-045100	23.00 -	1.0000	1.0000
			23.25		

Tower Section	Feed Line Record No.	Description	Feed Line Segment Elev.	K <sub>a</sub> No Ice	K <sub>a</sub> Ice
L38	32	CCI-65FP-045100	23.00 - 23.25	1.0000	1.0000
L38	37	CCI-65FP-045100	23.00 - 23.25	1.0000	1.0000
L38	38	CCI-65FP-045100	23.00 - 23.25	1.0000	1.0000
L38	57	LDF7-50A(1-5/8)	23.00 - 23.25	1.0000	1.0000
L38	62	1" Rigid Conduit	23.00 - 23.25	1.0000	1.0000
L38	65	FSJ4P-50B-1(1/2)	23.00 - 23.25	1.0000	1.0000
L38	67	2" Rigid Conduit	23.00 - 23.25	1.0000	1.0000
L38	69	CU12PSM9P6XXX(1-1/2)	23.00 - 23.25	1.0000	1.0000
L39	25	CCI-65FP-060100	21.50 - 23.00	1.0000	1.0000
L39	26	CCI-65FP-060100	21.50 - 23.00	1.0000	1.0000
L39	30	CCI-65FP-045100	21.50 - 23.00	1.0000	1.0000
L39	31	CCI-65FP-045100	21.50 - 23.00	1.0000	1.0000
L39	32	CCI-65FP-045100	21.50 - 23.00	1.0000	1.0000
L39	37	CCI-65FP-045100	21.50 - 23.00	1.0000	1.0000
L39	38	CCI-65FP-045100	21.50 - 23.00	1.0000	1.0000
L39	57	LDF7-50A(1-5/8)	21.50 - 23.00	1.0000	1.0000
L39	62	1" Rigid Conduit	21.50 - 23.00	1.0000	1.0000
L39	65	FSJ4P-50B-1(1/2)	21.50 - 23.00	1.0000	1.0000
L39	67	2" Rigid Conduit	21.50 - 23.00	1.0000	1.0000
L39	69	CU12PSM9P6XXX(1-1/2)	21.50 - 23.00	1.0000	1.0000
L40	25	CCI-65FP-060100	21.25 - 21.50	1.0000	1.0000
L40	26	CCI-65FP-060100	21.25 - 21.50	1.0000	1.0000
L40	30	CCI-65FP-045100	21.25 - 21.50	1.0000	1.0000
L40	31	CCI-65FP-045100	21.25 - 21.50	1.0000	1.0000
L40	32	CCI-65FP-045100	21.25 - 21.50	1.0000	1.0000
L40	37	CCI-65FP-045100	21.25 - 21.50	1.0000	1.0000
L40	38	CCI-65FP-045100	21.25 - 21.50	1.0000	1.0000
L40	57	LDF7-50A(1-5/8)	21.25 - 21.50	1.0000	1.0000
L40	62	1" Rigid Conduit	21.25 - 21.50	1.0000	1.0000
L40	65	FSJ4P-50B-1(1/2)	21.25 - 21.50	1.0000	1.0000
L40	67	2" Rigid Conduit	21.25 - 21.50	1.0000	1.0000
L40	69	CU12PSM9P6XXX(1-1/2)	21.25 - 21.50	1.0000	1.0000
L41	15	MS-450	19.00 - 20.50	1.0000	1.0000
L41	16	MS-450	19.00 - 20.50	1.0000	1.0000
L41	17	MS-450	19.00 -	1.0000	1.0000



Tower Section	Feed Line Record No.	Description	Feed Line Segment Elev.	K <sub>a</sub> No Ice	K <sub>a</sub> Ice
L41	25	CCI-65FP-060100	20.50 19.00 - 21.25	1.0000	1.0000
L41	26	CCI-65FP-060100	19.00 - 21.25	1.0000	1.0000
L41	30	CCI-65FP-045100	20.00 - 21.25	1.0000	1.0000
L41	31	CCI-65FP-045100	20.00 - 21.25	1.0000	1.0000
L41	32	CCI-65FP-045100	20.00 - 21.25	1.0000	1.0000
L41	37	CCI-65FP-045100	19.00 - 21.25	1.0000	1.0000
L41	38	CCI-65FP-045100	19.00 - 21.25	1.0000	1.0000
L41	57	LDF7-50A(1-5/8)	19.00 - 21.25	1.0000	1.0000
L41	62	1" Rigid Conduit	19.00 - 21.25	1.0000	1.0000
L41	65	FSJ4P-50B-1(1/2)	19.00 - 21.25	1.0000	1.0000
L41	67	2" Rigid Conduit	19.00 - 21.25	1.0000	1.0000
L41	69	CU12PSM9P6XXX(1-1/2)	19.00 - 21.25	1.0000	1.0000
L42	15	MS-450	18.75 - 19.00	1.0000	1.0000
L42	16	MS-450	18.75 - 19.00	1.0000	1.0000
L42	17	MS-450	18.75 - 19.00	1.0000	1.0000
L42	25	CCI-65FP-060100	18.75 - 19.00	1.0000	1.0000
L42	26	CCI-65FP-060100	18.75 - 19.00	1.0000	1.0000
L42	37	CCI-65FP-045100	18.75 - 19.00	1.0000	1.0000
L42	38	CCI-65FP-045100	18.75 - 19.00	1.0000	1.0000
L42	57	LDF7-50A(1-5/8)	18.75 - 19.00	1.0000	1.0000
L42	62	1" Rigid Conduit	18.75 - 19.00	1.0000	1.0000
L42	65	FSJ4P-50B-1(1/2)	18.75 - 19.00	1.0000	1.0000
L42	67	2" Rigid Conduit	18.75 - 19.00	1.0000	1.0000
L42	69	CU12PSM9P6XXX(1-1/2)	18.75 - 19.00	1.0000	1.0000
L43	15	MS-450	18.50 - 18.75	1.0000	1.0000
L43	16	MS-450	18.50 - 18.75	1.0000	1.0000
L43	17	MS-450	18.50 - 18.75	1.0000	1.0000
L43	25	CCI-65FP-060100	18.50 - 18.75	1.0000	1.0000
L43	26	CCI-65FP-060100	18.50 - 18.75	1.0000	1.0000
L43	37	CCI-65FP-045100	18.50 - 18.75	1.0000	1.0000
L43	38	CCI-65FP-045100	18.50 - 18.75	1.0000	1.0000
L43	57	LDF7-50A(1-5/8)	18.50 - 18.75	1.0000	1.0000
L43	62	1" Rigid Conduit	18.50 - 18.75	1.0000	1.0000
L43	65	FSJ4P-50B-1(1/2)	18.50 - 18.75	1.0000	1.0000

Tower Section	Feed Line Record No.	Description	Feed Line Segment Elev.	K <sub>a</sub> No Ice	K <sub>a</sub> Ice
L43	67	2" Rigid Conduit	18.50 - 18.75	1.0000	1.0000
L43	69	CU12PSM9P6XXX(1-1/2)	18.50 - 18.75	1.0000	1.0000
L44	15	MS-450	18.25 - 18.50	1.0000	1.0000
L44	16	MS-450	18.25 - 18.50	1.0000	1.0000
L44	17	MS-450	18.25 - 18.50	1.0000	1.0000
L44	25	CCI-65FP-060100	18.25 - 18.50	1.0000	1.0000
L44	26	CCI-65FP-060100	18.25 - 18.50	1.0000	1.0000
L44	37	CCI-65FP-045100	18.25 - 18.50	1.0000	1.0000
L44	38	CCI-65FP-045100	18.25 - 18.50	1.0000	1.0000
L44	57	LDF7-50A(1-5/8)	18.25 - 18.50	1.0000	1.0000
L44	62	1" Rigid Conduit	18.25 - 18.50	1.0000	1.0000
L44	65	FSJ4P-50B-1(1/2)	18.25 - 18.50	1.0000	1.0000
L44	67	2" Rigid Conduit	18.25 - 18.50	1.0000	1.0000
L44	69	CU12PSM9P6XXX(1-1/2)	18.25 - 18.50	1.0000	1.0000
L45	15	MS-450	13.25 - 18.25	1.0000	1.0000
L45	16	MS-450	13.25 - 18.25	1.0000	1.0000
L45	17	MS-450	13.25 - 18.25	1.0000	1.0000
L45	25	CCI-65FP-060100	13.25 - 18.25	1.0000	1.0000
L45	26	CCI-65FP-060100	13.25 - 18.25	1.0000	1.0000
L45	37	CCI-65FP-045100	17.00 - 18.25	1.0000	1.0000
L45	38	CCI-65FP-045100	17.00 - 18.25	1.0000	1.0000
L45	57	LDF7-50A(1-5/8)	13.25 - 18.25	1.0000	1.0000
L45	62	1" Rigid Conduit	13.25 - 18.25	1.0000	1.0000
L45	65	FSJ4P-50B-1(1/2)	13.25 - 18.25	1.0000	1.0000
L45	67	2" Rigid Conduit	13.25 - 18.25	1.0000	1.0000
L45	69	CU12PSM9P6XXX(1-1/2)	13.25 - 18.25	1.0000	1.0000
L46	15	MS-450	12.70 - 13.25	1.0000	1.0000
L46	16	MS-450	12.70 - 13.25	1.0000	1.0000
L46	17	MS-450	12.70 - 13.25	1.0000	1.0000
L46	25	CCI-65FP-060100	12.70 - 13.25	1.0000	1.0000
L46	26	CCI-65FP-060100	12.70 - 13.25	1.0000	1.0000
L46	39	CCI-65FP-065125	12.70 - 13.00	1.0000	1.0000
L46	57	LDF7-50A(1-5/8)	12.70 - 13.25	1.0000	1.0000
L46	62	1" Rigid Conduit	12.70 - 13.25	1.0000	1.0000
L46	65	FSJ4P-50B-1(1/2)	12.70 -	1.0000	1.0000

Tower Section	Feed Line Record No.	Description	Feed Line Segment Elev.	K <sub>a</sub> No Ice	K <sub>a</sub> Ice
L46	67	2" Rigid Conduit	13.25 12.70 -	1.0000	1.0000
L46	69	CU12PSM9P6XXX(1-1/2)	13.25 12.70 -	1.0000	1.0000
L47	15	MS-450	13.25 12.45 -	1.0000	1.0000
L47	16	MS-450	12.70 12.45 -	1.0000	1.0000
L47	17	MS-450	12.70 12.45 -	1.0000	1.0000
L47	25	CCI-65FP-060100	12.70 12.45 -	1.0000	1.0000
L47	26	CCI-65FP-060100	12.70 12.45 -	1.0000	1.0000
L47	39	CCI-65FP-065125	12.70 12.45 -	1.0000	1.0000
L47	57	LDF7-50A(1-5/8)	12.70 12.45 -	1.0000	1.0000
L47	62	1" Rigid Conduit	12.70 12.45 -	1.0000	1.0000
L47	65	FSJ4P-50B-1(1/2)	12.70 12.45 -	1.0000	1.0000
L47	67	2" Rigid Conduit	12.70 12.45 -	1.0000	1.0000
L47	69	CU12PSM9P6XXX(1-1/2)	12.70 12.45 -	1.0000	1.0000
L48	15	MS-450	12.45 11.50 -	1.0000	1.0000
L48	16	MS-450	12.45 11.50 -	1.0000	1.0000
L48	17	MS-450	12.45 11.50 -	1.0000	1.0000
L48	25	CCI-65FP-060100	12.45 11.50 -	1.0000	1.0000
L48	26	CCI-65FP-060100	12.45 11.50 -	1.0000	1.0000
L48	39	CCI-65FP-065125	12.45 11.50 -	1.0000	1.0000
L48	57	LDF7-50A(1-5/8)	12.45 11.50 -	1.0000	1.0000
L48	62	1" Rigid Conduit	12.45 11.50 -	1.0000	1.0000
L48	65	FSJ4P-50B-1(1/2)	12.45 11.50 -	1.0000	1.0000
L48	67	2" Rigid Conduit	12.45 11.50 -	1.0000	1.0000
L48	69	CU12PSM9P6XXX(1-1/2)	12.45 11.50 -	1.0000	1.0000
L49	15	MS-450	12.45 11.25 -	1.0000	1.0000
L49	16	MS-450	11.50 11.25 -	1.0000	1.0000
L49	17	MS-450	11.50 11.25 -	1.0000	1.0000
L49	25	CCI-65FP-060100	11.50 11.25 -	1.0000	1.0000
L49	26	CCI-65FP-060100	11.50 11.25 -	1.0000	1.0000
L49	39	CCI-65FP-065125	11.50 11.25 -	1.0000	1.0000
L49	57	LDF7-50A(1-5/8)	11.50 11.25 -	1.0000	1.0000
L49	62	1" Rigid Conduit	11.50 11.25 -	1.0000	1.0000
L49	65	FSJ4P-50B-1(1/2)	11.50 11.25 -	1.0000	1.0000
L49	67	2" Rigid Conduit	11.50 11.25 -	1.0000	1.0000

Tower Section	Feed Line Record No.	Description	Feed Line Segment Elev.	K <sub>a</sub> No Ice	K <sub>a</sub> Ice
L49	69	CU12PSM9P6XXX(1-1/2)	11.25 - 11.50	1.0000	1.0000
L50	15	MS-450	10.50 - 11.25	1.0000	1.0000
L50	16	MS-450	10.50 - 11.25	1.0000	1.0000
L50	17	MS-450	10.50 - 11.25	1.0000	1.0000
L50	25	CCI-65FP-060100	10.50 - 11.25	1.0000	1.0000
L50	26	CCI-65FP-060100	10.50 - 11.25	1.0000	1.0000
L50	39	CCI-65FP-065125	10.50 - 11.25	1.0000	1.0000
L50	57	LDF7-50A(1-5/8)	10.50 - 11.25	1.0000	1.0000
L50	62	1" Rigid Conduit	10.50 - 11.25	1.0000	1.0000
L50	65	FSJ4P-50B-1(1/2)	10.50 - 11.25	1.0000	1.0000
L50	67	2" Rigid Conduit	10.50 - 11.25	1.0000	1.0000
L50	69	CU12PSM9P6XXX(1-1/2)	10.50 - 11.25	1.0000	1.0000
L51	15	MS-450	10.25 - 10.50	1.0000	1.0000
L51	16	MS-450	10.25 - 10.50	1.0000	1.0000
L51	17	MS-450	10.25 - 10.50	1.0000	1.0000
L51	25	CCI-65FP-060100	10.25 - 10.50	1.0000	1.0000
L51	26	CCI-65FP-060100	10.25 - 10.50	1.0000	1.0000
L51	39	CCI-65FP-065125	10.25 - 10.50	1.0000	1.0000
L51	57	LDF7-50A(1-5/8)	10.25 - 10.50	1.0000	1.0000
L51	62	1" Rigid Conduit	10.25 - 10.50	1.0000	1.0000
L51	65	FSJ4P-50B-1(1/2)	10.25 - 10.50	1.0000	1.0000
L51	67	2" Rigid Conduit	10.25 - 10.50	1.0000	1.0000
L51	69	CU12PSM9P6XXX(1-1/2)	10.25 - 10.50	1.0000	1.0000
L52	15	MS-450	7.50 - 10.25	1.0000	1.0000
L52	16	MS-450	7.50 - 10.25	1.0000	1.0000
L52	17	MS-450	7.50 - 10.25	1.0000	1.0000
L52	25	CCI-65FP-060100	7.50 - 10.25	1.0000	1.0000
L52	26	CCI-65FP-060100	7.50 - 10.25	1.0000	1.0000
L52	39	CCI-65FP-065125	7.50 - 10.25	1.0000	1.0000
L52	57	LDF7-50A(1-5/8)	7.50 - 10.25	1.0000	1.0000
L52	62	1" Rigid Conduit	7.50 - 10.25	1.0000	1.0000
L52	65	FSJ4P-50B-1(1/2)	7.50 - 10.25	1.0000	1.0000
L52	67	2" Rigid Conduit	7.50 - 10.25	1.0000	1.0000
L52	69	CU12PSM9P6XXX(1-1/2)	7.50 - 10.25	1.0000	1.0000
L53	15	MS-450	7.25 - 7.50	1.0000	1.0000
L53	16	MS-450	7.25 - 7.50	1.0000	1.0000
L53	17	MS-450	7.25 - 7.50	1.0000	1.0000
L53	25	CCI-65FP-060100	7.25 - 7.50	1.0000	1.0000
L53	26	CCI-65FP-060100	7.25 - 7.50	1.0000	1.0000
L53	39	CCI-65FP-065125	7.25 - 7.50	1.0000	1.0000
L53	57	LDF7-50A(1-5/8)	7.25 - 7.50	1.0000	1.0000
L53	62	1" Rigid Conduit	7.25 - 7.50	1.0000	1.0000
L53	65	FSJ4P-50B-1(1/2)	7.25 - 7.50	1.0000	1.0000
L53	67	2" Rigid Conduit	7.25 - 7.50	1.0000	1.0000
L53	69	CU12PSM9P6XXX(1-1/2)	7.25 - 7.50	1.0000	1.0000
L54	15	MS-450	6.25 - 7.25	1.0000	1.0000

Tower Section	Feed Line Record No.	Description	Feed Line Segment Elev.	K <sub>a</sub> No Ice	K <sub>a</sub> Ice
L54	16	MS-450	6.25 - 7.25	1.0000	1.0000
L54	17	MS-450	6.25 - 7.25	1.0000	1.0000
L54	25	CCI-65FP-060100	6.25 - 7.25	1.0000	1.0000
L54	26	CCI-65FP-060100	6.25 - 7.25	1.0000	1.0000
L54	39	CCI-65FP-065125	6.25 - 7.25	1.0000	1.0000
L54	57	LDF7-50A(1-5/8)	6.25 - 7.25	1.0000	1.0000
L54	62	1" Rigid Conduit	6.25 - 7.25	1.0000	1.0000
L54	65	FSJ4P-50B-1(1/2)	6.25 - 7.25	1.0000	1.0000
L54	67	2" Rigid Conduit	6.25 - 7.25	1.0000	1.0000
L54	69	CU12PSM9P6XXX(1-1/2)	6.25 - 7.25	1.0000	1.0000
L55	15	MS-450	6.00 - 6.25	1.0000	1.0000
L55	16	MS-450	6.00 - 6.25	1.0000	1.0000
L55	17	MS-450	6.00 - 6.25	1.0000	1.0000
L55	25	CCI-65FP-060100	6.00 - 6.25	1.0000	1.0000
L55	26	CCI-65FP-060100	6.00 - 6.25	1.0000	1.0000
L55	39	CCI-65FP-065125	6.00 - 6.25	1.0000	1.0000
L55	57	LDF7-50A(1-5/8)	6.00 - 6.25	1.0000	1.0000
L55	62	1" Rigid Conduit	6.00 - 6.25	1.0000	1.0000
L55	65	FSJ4P-50B-1(1/2)	6.00 - 6.25	1.0000	1.0000
L55	67	2" Rigid Conduit	6.00 - 6.25	1.0000	1.0000
L55	69	CU12PSM9P6XXX(1-1/2)	6.00 - 6.25	1.0000	1.0000
L56	15	MS-450	3.73 - 6.00	1.0000	1.0000
L56	16	MS-450	3.73 - 6.00	1.0000	1.0000
L56	17	MS-450	3.73 - 6.00	1.0000	1.0000
L56	25	CCI-65FP-060100	3.73 - 6.00	1.0000	1.0000
L56	26	CCI-65FP-060100	3.73 - 6.00	1.0000	1.0000
L56	39	CCI-65FP-065125	4.00 - 6.00	1.0000	1.0000
L56	57	LDF7-50A(1-5/8)	3.73 - 6.00	1.0000	1.0000
L56	62	1" Rigid Conduit	3.73 - 6.00	1.0000	1.0000
L56	65	FSJ4P-50B-1(1/2)	3.73 - 6.00	1.0000	1.0000
L56	67	2" Rigid Conduit	3.73 - 6.00	1.0000	1.0000
L56	69	CU12PSM9P6XXX(1-1/2)	3.73 - 6.00	1.0000	1.0000
L57	15	MS-450	3.48 - 3.73	1.0000	1.0000
L57	16	MS-450	3.48 - 3.73	1.0000	1.0000
L57	17	MS-450	3.48 - 3.73	1.0000	1.0000
L57	25	CCI-65FP-060100	3.48 - 3.73	1.0000	1.0000
L57	26	CCI-65FP-060100	3.48 - 3.73	1.0000	1.0000
L57	57	LDF7-50A(1-5/8)	3.48 - 3.73	1.0000	1.0000
L57	62	1" Rigid Conduit	3.48 - 3.73	1.0000	1.0000
L57	65	FSJ4P-50B-1(1/2)	3.48 - 3.73	1.0000	1.0000
L57	67	2" Rigid Conduit	3.48 - 3.73	1.0000	1.0000
L57	69	CU12PSM9P6XXX(1-1/2)	3.48 - 3.73	1.0000	1.0000
L58	15	MS-450	2.75 - 3.48	1.0000	1.0000
L58	16	MS-450	2.75 - 3.48	1.0000	1.0000
L58	17	MS-450	2.75 - 3.48	1.0000	1.0000
L58	25	CCI-65FP-060100	2.75 - 3.48	1.0000	1.0000
L58	26	CCI-65FP-060100	2.75 - 3.48	1.0000	1.0000
L58	57	LDF7-50A(1-5/8)	2.75 - 3.48	1.0000	1.0000
L58	62	1" Rigid Conduit	2.75 - 3.48	1.0000	1.0000
L58	65	FSJ4P-50B-1(1/2)	2.75 - 3.48	1.0000	1.0000
L58	67	2" Rigid Conduit	2.75 - 3.48	1.0000	1.0000
L58	69	CU12PSM9P6XXX(1-1/2)	2.75 - 3.48	1.0000	1.0000
L59	15	MS-450	2.50 - 2.75	1.0000	1.0000
L59	16	MS-450	2.50 - 2.75	1.0000	1.0000
L59	17	MS-450	2.50 - 2.75	1.0000	1.0000
L59	25	CCI-65FP-060100	2.50 - 2.75	1.0000	1.0000
L59	26	CCI-65FP-060100	2.50 - 2.75	1.0000	1.0000
L59	57	LDF7-50A(1-5/8)	2.50 - 2.75	1.0000	1.0000
L59	62	1" Rigid Conduit	2.50 - 2.75	1.0000	1.0000
L59	65	FSJ4P-50B-1(1/2)	2.50 - 2.75	1.0000	1.0000
L59	67	2" Rigid Conduit	2.50 - 2.75	1.0000	1.0000
L59	69	CU12PSM9P6XXX(1-1/2)	2.50 - 2.75	1.0000	1.0000
L60	15	MS-450	2.00 - 2.50	1.0000	1.0000
L60	16	MS-450	2.00 - 2.50	1.0000	1.0000
L60	17	MS-450	2.00 - 2.50	1.0000	1.0000
L60	25	CCI-65FP-060100	2.00 - 2.50	1.0000	1.0000
L60	26	CCI-65FP-060100	2.00 - 2.50	1.0000	1.0000
L60	57	LDF7-50A(1-5/8)	2.00 - 2.50	1.0000	1.0000
L60	62	1" Rigid Conduit	2.00 - 2.50	1.0000	1.0000

Tower Section	Feed Line Record No.	Description	Feed Line Segment Elev.	K <sub>a</sub> No Ice	K <sub>a</sub> Ice
L60	65	FSJ4P-50B-1(1/2)	2.00 - 2.50	1.0000	1.0000
L60	67	2" Rigid Conduit	2.00 - 2.50	1.0000	1.0000
L60	69	CU12PSM9P6XXX(1-1/2)	2.00 - 2.50	1.0000	1.0000
L61	15	MS-450	1.75 - 2.00	1.0000	1.0000
L61	16	MS-450	1.75 - 2.00	1.0000	1.0000
L61	17	MS-450	1.75 - 2.00	1.0000	1.0000
L61	25	CCI-65FP-060100	1.75 - 2.00	1.0000	1.0000
L61	26	CCI-65FP-060100	1.75 - 2.00	1.0000	1.0000
L61	57	LDF7-50A(1-5/8)	1.75 - 2.00	1.0000	1.0000
L61	62	1" Rigid Conduit	1.75 - 2.00	1.0000	1.0000
L61	65	FSJ4P-50B-1(1/2)	1.75 - 2.00	1.0000	1.0000
L61	67	2" Rigid Conduit	1.75 - 2.00	1.0000	1.0000
L61	69	CU12PSM9P6XXX(1-1/2)	1.75 - 2.00	1.0000	1.0000
L62	15	MS-450	0.50 - 1.75	1.0000	1.0000
L62	16	MS-450	0.50 - 1.75	1.0000	1.0000
L62	17	MS-450	0.50 - 1.75	1.0000	1.0000
L62	25	CCI-65FP-060100	0.50 - 1.75	1.0000	1.0000
L62	26	CCI-65FP-060100	0.50 - 1.75	1.0000	1.0000
L62	57	LDF7-50A(1-5/8)	0.00 - 1.75	1.0000	1.0000
L62	62	1" Rigid Conduit	0.00 - 1.75	1.0000	1.0000
L62	65	FSJ4P-50B-1(1/2)	0.00 - 1.75	1.0000	1.0000
L62	67	2" Rigid Conduit	0.00 - 1.75	1.0000	1.0000
L62	69	CU12PSM9P6XXX(1-1/2)	0.00 - 1.75	1.0000	1.0000

**Effective Width of Flat Linear Attachments / Feed Lines**

Tower Section	Attachment Record No.	Description	Attachment Segment Elev.	Ratio Calculation Method	Effective Width Ratio
L9	34	CCI-65FP-045100	76.50 - 78.00	Auto	1.0000
L9	35	CCI-65FP-045100	76.50 - 78.00	Auto	1.0000
L9	36	CCI-65FP-045100	76.50 - 78.00	Auto	1.0000
L10	34	CCI-65FP-045100	76.25 - 76.50	Auto	1.0000
L10	35	CCI-65FP-045100	76.25 - 76.50	Auto	1.0000
L10	36	CCI-65FP-045100	76.25 - 76.50	Auto	1.0000
L11	34	CCI-65FP-045100	74.00 - 76.25	Auto	1.0000
L11	35	CCI-65FP-045100	74.00 - 76.25	Auto	1.0000
L11	36	CCI-65FP-045100	74.00 - 76.25	Auto	1.0000
L12	34	CCI-65FP-045100	73.75 - 74.00	Auto	1.0000
L12	35	CCI-65FP-045100	73.75 - 74.00	Auto	1.0000
L12	36	CCI-65FP-045100	73.75 - 74.00	Auto	1.0000
L13	19	CCI-65FP-045100	68.88 - 70.25	Auto	1.0000
L13	20	CCI-65FP-045100	68.88 - 70.25	Auto	1.0000
L13	21	CCI-65FP-045100	68.88 - 70.25	Auto	1.0000
L13	34	CCI-65FP-045100	68.88 -	Auto	1.0000

Tower Section	Attachment Record No.	Description	Attachment Segment Elev.	Ratio Calculation Method	Effective Width Ratio
L13	35	CCI-65FP-045100	73.75 68.88 - 73.75	Auto	1.0000
L13	36	CCI-65FP-045100	68.88 - 73.75	Auto	1.0000
L14	19	CCI-65FP-045100	68.63 - 68.88	Auto	1.0000
L14	20	CCI-65FP-045100	68.63 - 68.88	Auto	1.0000
L14	21	CCI-65FP-045100	68.63 - 68.88	Auto	1.0000
L14	34	CCI-65FP-045100	68.63 - 68.88	Auto	1.0000
L14	35	CCI-65FP-045100	68.63 - 68.88	Auto	1.0000
L14	36	CCI-65FP-045100	68.63 - 68.88	Auto	1.0000
L15	9	MS-400	64.50 - 65.50	Auto	1.0000
L15	10	MS-400	64.50 - 65.50	Auto	1.0000
L15	11	MS-400	64.50 - 65.50	Auto	1.0000
L15	19	CCI-65FP-045100	64.50 - 68.63	Auto	1.0000
L15	20	CCI-65FP-045100	64.50 - 68.63	Auto	1.0000
L15	21	CCI-65FP-045100	64.50 - 68.63	Auto	1.0000
L15	34	CCI-65FP-045100	67.00 - 68.63	Auto	1.0000
L15	35	CCI-65FP-045100	67.00 - 68.63	Auto	1.0000
L15	36	CCI-65FP-045100	67.00 - 68.63	Auto	1.0000
L16	9	MS-400	64.25 - 64.50	Auto	1.0000
L16	10	MS-400	64.25 - 64.50	Auto	1.0000
L16	11	MS-400	64.25 - 64.50	Auto	1.0000
L16	19	CCI-65FP-045100	64.25 - 64.50	Auto	1.0000
L16	20	CCI-65FP-045100	64.25 - 64.50	Auto	1.0000
L16	21	CCI-65FP-045100	64.25 - 64.50	Auto	1.0000
L17	9	MS-400	63.00 - 64.25	Auto	1.0000
L17	10	MS-400	63.00 - 64.25	Auto	1.0000
L17	11	MS-400	63.00 - 64.25	Auto	1.0000
L17	19	CCI-65FP-045100	63.00 - 64.25	Auto	1.0000
L17	20	CCI-65FP-045100	63.00 - 64.25	Auto	1.0000
L17	21	CCI-65FP-045100	63.00 - 64.25	Auto	1.0000
L18	9	MS-400	62.75 - 63.00	Auto	1.0000
L18	10	MS-400	62.75 - 63.00	Auto	1.0000
L18	11	MS-400	62.75 - 63.00	Auto	1.0000
L18	19	CCI-65FP-045100	62.75 - 63.00	Auto	1.0000
L18	20	CCI-65FP-045100	62.75 -	Auto	1.0000

Tower Section	Attachment Record No.	Description	Attachment Segment Elev.	Ratio Calculation Method	Effective Width Ratio
L18	21	CCI-65FP-045100	63.00 62.75 - 63.00	Auto	1.0000
L19	9	MS-400	60.50 - 62.75	Auto	1.0000
L19	10	MS-400	60.50 - 62.75	Auto	1.0000
L19	11	MS-400	60.50 - 62.75	Auto	1.0000
L19	19	CCI-65FP-045100	60.25 - 62.75	Auto	1.0000
L19	20	CCI-65FP-045100	60.25 - 62.75	Auto	1.0000
L19	21	CCI-65FP-045100	60.25 - 62.75	Auto	1.0000
L22	28	CCI-65FP-040075	49.75 - 50.25	Auto	1.0000
L22	29	CCI-65FP-040075	49.75 - 50.25	Auto	1.0000
L23	28	CCI-65FP-040075	49.25 - 49.75	Auto	1.0000
L23	29	CCI-65FP-040075	49.25 - 49.75	Auto	1.0000
L24	28	CCI-65FP-040075	49.00 - 49.25	Auto	1.0000
L24	29	CCI-65FP-040075	49.00 - 49.25	Auto	1.0000
L25	28	CCI-65FP-040075	44.00 - 49.00	Auto	1.0000
L25	29	CCI-65FP-040075	44.00 - 49.00	Auto	1.0000
L26	22	CCI-65FP-040075	42.00 - 43.00	Auto	1.0000
L26	23	CCI-65FP-040075	42.00 - 43.00	Auto	1.0000
L26	24	CCI-65FP-040075	42.00 - 43.00	Auto	1.0000
L26	28	CCI-65FP-040075	42.00 - 44.00	Auto	1.0000
L26	29	CCI-65FP-040075	42.00 - 44.00	Auto	1.0000
L27	22	CCI-65FP-040075	41.75 - 42.00	Auto	1.0000
L27	23	CCI-65FP-040075	41.75 - 42.00	Auto	1.0000
L27	24	CCI-65FP-040075	41.75 - 42.00	Auto	1.0000
L27	28	CCI-65FP-040075	41.75 - 42.00	Auto	1.0000
L27	29	CCI-65FP-040075	41.75 - 42.00	Auto	1.0000
L28	22	CCI-65FP-040075	36.75 - 41.75	Auto	1.0000
L28	23	CCI-65FP-040075	36.75 - 41.75	Auto	1.0000
L28	24	CCI-65FP-040075	36.75 - 41.75	Auto	1.0000
L28	28	CCI-65FP-040075	36.75 - 41.75	Auto	1.0000
L28	29	CCI-65FP-040075	36.75 - 41.75	Auto	1.0000
L29	12	MS-400	34.50 - 35.50	Auto	1.0000
L29	13	MS-400	34.50 - 35.50	Auto	1.0000
L29	14	MS-400	34.50 - 35.50	Auto	1.0000
L29	22	CCI-65FP-040075	34.50 -	Auto	1.0000



Tower Section	Attachment Record No.	Description	Attachment Segment Elev.	Ratio Calculation Method	Effective Width Ratio
L29	23	CCI-65FP-040075	36.75 34.50 - 36.75	Auto	1.0000
L29	24	CCI-65FP-040075	34.50 - 36.75	Auto	1.0000
L29	28	CCI-65FP-040075	34.50 - 36.75	Auto	1.0000
L29	29	CCI-65FP-040075	34.50 - 36.75	Auto	1.0000
L30	12	MS-400	34.25 - 34.50	Auto	1.0000
L30	13	MS-400	34.25 - 34.50	Auto	1.0000
L30	14	MS-400	34.25 - 34.50	Auto	1.0000
L30	22	CCI-65FP-040075	34.25 - 34.50	Auto	1.0000
L30	23	CCI-65FP-040075	34.25 - 34.50	Auto	1.0000
L30	24	CCI-65FP-040075	34.25 - 34.50	Auto	1.0000
L30	28	CCI-65FP-040075	34.25 - 34.50	Auto	1.0000
L30	29	CCI-65FP-040075	34.25 - 34.50	Auto	1.0000
L31	12	MS-400	34.00 - 34.25	Auto	1.0000
L31	13	MS-400	34.00 - 34.25	Auto	1.0000
L31	14	MS-400	34.00 - 34.25	Auto	1.0000
L31	22	CCI-65FP-040075	34.00 - 34.25	Auto	1.0000
L31	23	CCI-65FP-040075	34.00 - 34.25	Auto	1.0000
L31	24	CCI-65FP-040075	34.00 - 34.25	Auto	1.0000
L31	28	CCI-65FP-040075	34.00 - 34.25	Auto	1.0000
L31	29	CCI-65FP-040075	34.00 - 34.25	Auto	1.0000
L32	12	MS-400	33.75 - 34.00	Auto	1.0000
L32	13	MS-400	33.75 - 34.00	Auto	1.0000
L32	14	MS-400	33.75 - 34.00	Auto	1.0000
L32	22	CCI-65FP-040075	33.75 - 34.00	Auto	1.0000
L32	23	CCI-65FP-040075	33.75 - 34.00	Auto	1.0000
L32	24	CCI-65FP-040075	33.75 - 34.00	Auto	1.0000
L32	28	CCI-65FP-040075	33.75 - 34.00	Auto	1.0000
L32	29	CCI-65FP-040075	33.75 - 34.00	Auto	1.0000
L33	12	MS-400	30.50 - 33.75	Auto	1.0000
L33	13	MS-400	30.50 - 33.75	Auto	1.0000
L33	14	MS-400	30.50 - 33.75	Auto	1.0000
L33	22	CCI-65FP-040075	33.00 - 33.75	Auto	1.0000
L33	23	CCI-65FP-040075	33.00 - 33.75	Auto	1.0000
L33	24	CCI-65FP-040075	33.00 -	Auto	1.0000

Tower Section	Attachment Record No.	Description	Attachment Segment Elev.	Ratio Calculation Method	Effective Width Ratio
L33	28	CCI-65FP-040075	33.75 30.25 - 33.75	Auto	1.0000
L33	29	CCI-65FP-040075	30.25 - 33.75	Auto	1.0000
L34	30	CCI-65FP-045100	29.75 - 30.00	Auto	1.0000
L34	31	CCI-65FP-045100	29.75 - 30.00	Auto	1.0000
L34	32	CCI-65FP-045100	29.75 - 30.00	Auto	1.0000
L35	30	CCI-65FP-045100	28.50 - 29.75	Auto	1.0000
L35	31	CCI-65FP-045100	28.50 - 29.75	Auto	1.0000
L35	32	CCI-65FP-045100	28.50 - 29.75	Auto	1.0000
L35	37	CCI-65FP-045100	28.50 - 29.50	Auto	1.0000
L35	38	CCI-65FP-045100	28.50 - 29.50	Auto	1.0000
L36	30	CCI-65FP-045100	28.25 - 28.50	Auto	1.0000
L36	31	CCI-65FP-045100	28.25 - 28.50	Auto	1.0000
L36	32	CCI-65FP-045100	28.25 - 28.50	Auto	1.0000
L36	37	CCI-65FP-045100	28.25 - 28.50	Auto	1.0000
L36	38	CCI-65FP-045100	28.25 - 28.50	Auto	1.0000
L37	25	CCI-65FP-060100	23.25 - 25.50	Auto	1.0000
L37	26	CCI-65FP-060100	23.25 - 25.50	Auto	1.0000
L37	30	CCI-65FP-045100	23.25 - 28.25	Auto	1.0000
L37	31	CCI-65FP-045100	23.25 - 28.25	Auto	1.0000
L37	32	CCI-65FP-045100	23.25 - 28.25	Auto	1.0000
L37	37	CCI-65FP-045100	23.25 - 28.25	Auto	1.0000
L37	38	CCI-65FP-045100	23.25 - 28.25	Auto	1.0000
L38	25	CCI-65FP-060100	23.00 - 23.25	Auto	1.0000
L38	26	CCI-65FP-060100	23.00 - 23.25	Auto	1.0000
L38	30	CCI-65FP-045100	23.00 - 23.25	Auto	1.0000
L38	31	CCI-65FP-045100	23.00 - 23.25	Auto	1.0000
L38	32	CCI-65FP-045100	23.00 - 23.25	Auto	1.0000
L38	37	CCI-65FP-045100	23.00 - 23.25	Auto	1.0000
L38	38	CCI-65FP-045100	23.00 - 23.25	Auto	1.0000
L39	25	CCI-65FP-060100	21.50 - 23.00	Auto	1.0000
L39	26	CCI-65FP-060100	21.50 - 23.00	Auto	1.0000
L39	30	CCI-65FP-045100	21.50 - 23.00	Auto	1.0000
L39	31	CCI-65FP-045100	21.50 - 23.00	Auto	1.0000
L39	32	CCI-65FP-045100	21.50 -	Auto	1.0000

Tower Section	Attachment Record No.	Description	Attachment Segment Elev.	Ratio Calculation Method	Effective Width Ratio
L39	37	CCI-65FP-045100	23.00 21.50 - 23.00	Auto	1.0000
L39	38	CCI-65FP-045100	21.50 - 23.00	Auto	1.0000
L40	25	CCI-65FP-060100	21.25 - 21.50	Auto	1.0000
L40	26	CCI-65FP-060100	21.25 - 21.50	Auto	1.0000
L40	30	CCI-65FP-045100	21.25 - 21.50	Auto	1.0000
L40	31	CCI-65FP-045100	21.25 - 21.50	Auto	1.0000
L40	32	CCI-65FP-045100	21.25 - 21.50	Auto	1.0000
L40	37	CCI-65FP-045100	21.25 - 21.50	Auto	1.0000
L40	38	CCI-65FP-045100	21.25 - 21.50	Auto	1.0000
L41	15	MS-450	19.00 - 20.50	Auto	1.0000
L41	16	MS-450	19.00 - 20.50	Auto	1.0000
L41	17	MS-450	19.00 - 20.50	Auto	1.0000
L41	25	CCI-65FP-060100	19.00 - 21.25	Auto	1.0000
L41	26	CCI-65FP-060100	19.00 - 21.25	Auto	1.0000
L41	30	CCI-65FP-045100	20.00 - 21.25	Auto	1.0000
L41	31	CCI-65FP-045100	20.00 - 21.25	Auto	1.0000
L41	32	CCI-65FP-045100	20.00 - 21.25	Auto	1.0000
L41	37	CCI-65FP-045100	19.00 - 21.25	Auto	1.0000
L41	38	CCI-65FP-045100	19.00 - 21.25	Auto	1.0000
L42	15	MS-450	18.75 - 19.00	Auto	1.0000
L42	16	MS-450	18.75 - 19.00	Auto	1.0000
L42	17	MS-450	18.75 - 19.00	Auto	1.0000
L42	25	CCI-65FP-060100	18.75 - 19.00	Auto	1.0000
L42	26	CCI-65FP-060100	18.75 - 19.00	Auto	1.0000
L42	37	CCI-65FP-045100	18.75 - 19.00	Auto	1.0000
L42	38	CCI-65FP-045100	18.75 - 19.00	Auto	1.0000
L43	15	MS-450	18.50 - 18.75	Auto	1.0000
L43	16	MS-450	18.50 - 18.75	Auto	1.0000
L43	17	MS-450	18.50 - 18.75	Auto	1.0000
L43	25	CCI-65FP-060100	18.50 - 18.75	Auto	1.0000
L43	26	CCI-65FP-060100	18.50 - 18.75	Auto	1.0000
L43	37	CCI-65FP-045100	18.50 - 18.75	Auto	1.0000
L43	38	CCI-65FP-045100	18.50 - 18.75	Auto	1.0000
L44	15	MS-450	18.25 -	Auto	1.0000

Tower Section	Attachment Record No.	Description	Attachment Segment Elev.	Ratio Calculation Method	Effective Width Ratio
L44	16	MS-450	18.50 18.25 - 18.50	Auto	1.0000
L44	17	MS-450	18.25 - 18.50	Auto	1.0000
L44	25	CCI-65FP-060100	18.25 - 18.50	Auto	1.0000
L44	26	CCI-65FP-060100	18.25 - 18.50	Auto	1.0000
L44	37	CCI-65FP-045100	18.25 - 18.50	Auto	1.0000
L44	38	CCI-65FP-045100	18.25 - 18.50	Auto	1.0000
L45	15	MS-450	13.25 - 18.25	Auto	1.0000
L45	16	MS-450	13.25 - 18.25	Auto	1.0000
L45	17	MS-450	13.25 - 18.25	Auto	1.0000
L45	25	CCI-65FP-060100	13.25 - 18.25	Auto	1.0000
L45	26	CCI-65FP-060100	13.25 - 18.25	Auto	1.0000
L45	37	CCI-65FP-045100	17.00 - 18.25	Auto	1.0000
L45	38	CCI-65FP-045100	17.00 - 18.25	Auto	1.0000
L46	15	MS-450	12.70 - 13.25	Auto	1.0000
L46	16	MS-450	12.70 - 13.25	Auto	1.0000
L46	17	MS-450	12.70 - 13.25	Auto	1.0000
L46	25	CCI-65FP-060100	12.70 - 13.25	Auto	1.0000
L46	26	CCI-65FP-060100	12.70 - 13.25	Auto	1.0000
L46	39	CCI-65FP-065125	12.70 - 13.00	Auto	1.0000
L47	15	MS-450	12.45 - 12.70	Auto	1.0000
L47	16	MS-450	12.45 - 12.70	Auto	1.0000
L47	17	MS-450	12.45 - 12.70	Auto	1.0000
L47	25	CCI-65FP-060100	12.45 - 12.70	Auto	1.0000
L47	26	CCI-65FP-060100	12.45 - 12.70	Auto	1.0000
L47	39	CCI-65FP-065125	12.45 - 12.70	Auto	1.0000
L48	15	MS-450	11.50 - 12.45	Auto	1.0000
L48	16	MS-450	11.50 - 12.45	Auto	1.0000
L48	17	MS-450	11.50 - 12.45	Auto	1.0000
L48	25	CCI-65FP-060100	11.50 - 12.45	Auto	1.0000
L48	26	CCI-65FP-060100	11.50 - 12.45	Auto	1.0000
L48	39	CCI-65FP-065125	11.50 - 12.45	Auto	1.0000
L49	15	MS-450	11.25 - 11.50	Auto	1.0000
L49	16	MS-450	11.25 - 11.50	Auto	1.0000
L49	17	MS-450	11.25 -	Auto	1.0000

Tower Section	Attachment Record No.	Description	Attachment Segment Elev.	Ratio Calculation Method	Effective Width Ratio
L49	25	CCI-65FP-060100	11.50 11.25 - 11.50	Auto	1.0000
L49	26	CCI-65FP-060100	11.25 - 11.50	Auto	1.0000
L49	39	CCI-65FP-065125	11.25 - 11.50	Auto	1.0000
L50	15	MS-450	10.50 - 11.25	Auto	1.0000
L50	16	MS-450	10.50 - 11.25	Auto	1.0000
L50	17	MS-450	10.50 - 11.25	Auto	1.0000
L50	25	CCI-65FP-060100	10.50 - 11.25	Auto	1.0000
L50	26	CCI-65FP-060100	10.50 - 11.25	Auto	1.0000
L50	39	CCI-65FP-065125	10.50 - 11.25	Auto	1.0000
L51	15	MS-450	10.25 - 10.50	Auto	1.0000
L51	16	MS-450	10.25 - 10.50	Auto	1.0000
L51	17	MS-450	10.25 - 10.50	Auto	1.0000
L51	25	CCI-65FP-060100	10.25 - 10.50	Auto	1.0000
L51	26	CCI-65FP-060100	10.25 - 10.50	Auto	1.0000
L51	39	CCI-65FP-065125	10.25 - 10.50	Auto	1.0000
L52	15	MS-450	7.50 - 10.25	Auto	1.0000
L52	16	MS-450	7.50 - 10.25	Auto	1.0000
L52	17	MS-450	7.50 - 10.25	Auto	1.0000
L52	25	CCI-65FP-060100	7.50 - 10.25	Auto	1.0000
L52	26	CCI-65FP-060100	7.50 - 10.25	Auto	1.0000
L52	39	CCI-65FP-065125	7.50 - 10.25	Auto	1.0000
L53	15	MS-450	7.25 - 7.50	Auto	1.0000
L53	16	MS-450	7.25 - 7.50	Auto	1.0000
L53	17	MS-450	7.25 - 7.50	Auto	1.0000
L53	25	CCI-65FP-060100	7.25 - 7.50	Auto	1.0000
L53	26	CCI-65FP-060100	7.25 - 7.50	Auto	1.0000
L53	39	CCI-65FP-065125	7.25 - 7.50	Auto	1.0000
L54	15	MS-450	6.25 - 7.25	Auto	1.0000
L54	16	MS-450	6.25 - 7.25	Auto	1.0000
L54	17	MS-450	6.25 - 7.25	Auto	1.0000
L54	25	CCI-65FP-060100	6.25 - 7.25	Auto	1.0000
L54	26	CCI-65FP-060100	6.25 - 7.25	Auto	1.0000
L54	39	CCI-65FP-065125	6.25 - 7.25	Auto	1.0000
L55	15	MS-450	6.00 - 6.25	Auto	1.0000
L55	16	MS-450	6.00 - 6.25	Auto	1.0000
L55	17	MS-450	6.00 - 6.25	Auto	1.0000
L55	25	CCI-65FP-060100	6.00 - 6.25	Auto	1.0000
L55	26	CCI-65FP-060100	6.00 - 6.25	Auto	1.0000
L55	39	CCI-65FP-065125	6.00 - 6.25	Auto	1.0000
L56	15	MS-450	3.73 - 6.00	Auto	1.0000
L56	16	MS-450	3.73 - 6.00	Auto	1.0000
L56	17	MS-450	3.73 - 6.00	Auto	1.0000
L56	25	CCI-65FP-060100	3.73 - 6.00	Auto	1.0000
L56	26	CCI-65FP-060100	3.73 - 6.00	Auto	1.0000
L56	39	CCI-65FP-065125	4.00 - 6.00	Auto	1.0000
L57	15	MS-450	3.48 - 3.73	Auto	1.0000
L57	16	MS-450	3.48 - 3.73	Auto	1.0000
L57	17	MS-450	3.48 - 3.73	Auto	1.0000
L57	25	CCI-65FP-060100	3.48 - 3.73	Auto	1.0000
L57	26	CCI-65FP-060100	3.48 - 3.73	Auto	1.0000
L58	15	MS-450	2.75 - 3.48	Auto	1.0000
L58	16	MS-450	2.75 - 3.48	Auto	1.0000

Tower Section	Attachment Record No.	Description	Attachment Segment Elev.	Ratio Calculation Method	Effective Width Ratio
L58	17	MS-450	2.75 - 3.48	Auto	1.0000
L58	25	CCI-65FP-060100	2.75 - 3.48	Auto	1.0000
L58	26	CCI-65FP-060100	2.75 - 3.48	Auto	1.0000
L59	15	MS-450	2.50 - 2.75	Auto	1.0000
L59	16	MS-450	2.50 - 2.75	Auto	1.0000
L59	17	MS-450	2.50 - 2.75	Auto	1.0000
L59	25	CCI-65FP-060100	2.50 - 2.75	Auto	1.0000
L59	26	CCI-65FP-060100	2.50 - 2.75	Auto	1.0000
L60	15	MS-450	2.00 - 2.50	Auto	1.0000
L60	16	MS-450	2.00 - 2.50	Auto	1.0000
L60	17	MS-450	2.00 - 2.50	Auto	1.0000
L60	25	CCI-65FP-060100	2.00 - 2.50	Auto	1.0000
L60	26	CCI-65FP-060100	2.00 - 2.50	Auto	1.0000
L61	15	MS-450	1.75 - 2.00	Auto	1.0000
L61	16	MS-450	1.75 - 2.00	Auto	1.0000
L61	17	MS-450	1.75 - 2.00	Auto	1.0000
L61	25	CCI-65FP-060100	1.75 - 2.00	Auto	1.0000
L61	26	CCI-65FP-060100	1.75 - 2.00	Auto	1.0000
L62	15	MS-450	0.50 - 1.75	Auto	1.0000
L62	16	MS-450	0.50 - 1.75	Auto	1.0000
L62	17	MS-450	0.50 - 1.75	Auto	1.0000
L62	25	CCI-65FP-060100	0.50 - 1.75	Auto	1.0000
L62	26	CCI-65FP-060100	0.50 - 1.75	Auto	1.0000

### Discrete Tower Loads

Description	Face or Leg	Offset Type	Offsets: Horz Lateral Vert ft ft ft	Azimuth Adjustment °	Placement ft
***					
***					
Bridge Stiffener (84" x 9" x 1.25")	A	None		0.0000	90.0000
Bridge Stiffener (84" x 9" x 1.25")	B	None		0.0000	90.0000
Bridge Stiffener (84" x 9" x 1.25")	C	None		0.0000	90.0000
Bridge Stiffener (84" x 14.5" x 1.25")	A	None		0.0000	60.0000
Bridge Stiffener (84" x 14.5" x 1.25")	B	None		0.0000	60.0000
Bridge Stiffener (84" x 14.5" x 1.25")	C	None		0.0000	60.0000
Bridge Stiffener (84" x 14.5" x 1.25")	A	None		0.0000	30.0000
Bridge Stiffener (84" x 14.5" x 1.25")	B	None		0.0000	30.0000
Bridge Stiffener (84" x 14.5" x 1.25")	C	None		0.0000	30.0000
***					
***					
PCS 1900MHz 4x45W-65MHz	A	From Leg	1.0000 0.0000 0.0000	0.0000	116.0000
PCS 1900MHz 4x45W-65MHz	B	From Leg	1.0000 0.0000 0.0000	0.0000	116.0000
PCS 1900MHz 4x45W-65MHz	C	From Leg	1.0000 0.0000 0.0000	0.0000	116.0000
800MHz 2X50W RRH W/FILTER	A	From Leg	1.0000 0.0000 0.0000	0.0000	116.0000
800MHz 2X50W RRH W/FILTER	B	From Leg	1.0000 0.0000 0.0000	0.0000	116.0000

Description	Face or Leg	Offset Type	Offsets: Horz Lateral Vert ft ft ft	Azimuth Adjustment °	Placement ft
800MHz 2X50W RRH W/FILTER	C	From Leg	1.0000 0.0000 0.0000	0.0000	116.0000
Pipe Mount [PM 601-3] ***	C	None		0.0000	116.0000
APXVSP18-C-A20 w/ Mount Pipe	A	From Leg	4.0000 0.0000 2.0000	0.0000	114.0000
APXVSP18-C-A20 w/ Mount Pipe	B	From Leg	4.0000 0.0000 2.0000	0.0000	114.0000
APXV9ERR18-C-A20 w/ Mount Pipe	C	From Leg	4.0000 0.0000 2.0000	0.0000	114.0000
APXVTM14-C-120 w/ Mount Pipe	A	From Leg	4.0000 0.0000 2.0000	0.0000	114.0000
APXVTM14-C-120 w/ Mount Pipe	B	From Leg	4.0000 0.0000 2.0000	0.0000	114.0000
APXVTM14-C-120 w/ Mount Pipe	C	From Leg	4.0000 0.0000 2.0000	0.0000	114.0000
TD-RRH8x20-25	A	From Leg	4.0000 0.0000 2.0000	0.0000	114.0000
TD-RRH8x20-25	B	From Leg	4.0000 0.0000 2.0000	0.0000	114.0000
TD-RRH8x20-25	C	From Leg	4.0000 0.0000 2.0000	0.0000	114.0000
WIMAX DAP HEAD	B	From Leg	4.0000 0.0000 2.0000	0.0000	114.0000
Platform Mount [LP 502-1] (2) 4' x 2" Pipe Mount	C A	None From Leg	4.0000 0.0000 0.0000	0.0000 0.0000	114.0000 114.0000
(2) 4' x 2" Pipe Mount	B	From Leg	4.0000 0.0000 0.0000	0.0000	114.0000
(2) 4' x 2" Pipe Mount	C	From Leg	4.0000 0.0000 0.0000	0.0000	114.0000
***					
AIR6449 B41_T-MOBILE w/ Mount Pipe	A	From Leg	4.0000 0.0000 0.0000	0.0000	108.0000
AIR6449 B41_T-MOBILE w/ Mount Pipe	B	From Leg	4.0000 0.0000 0.0000	0.0000	108.0000
AIR6449 B41_T-MOBILE w/ Mount Pipe	C	From Leg	4.0000 0.0000 0.0000	0.0000	108.0000
APXVAARR24_43-U-NA20 w/ Mount Pipe	A	From Leg	4.0000 0.0000 0.0000	0.0000	108.0000
APXVAARR24_43-U-NA20 w/ Mount Pipe	B	From Leg	4.0000 0.0000 0.0000	0.0000	108.0000
APXVAARR24_43-U-NA20 w/ Mount Pipe	C	From Leg	4.0000 0.0000 0.0000	0.0000	108.0000
AIR 32 B2A/B66AA w/ Mount Pipe	A	From Leg	4.0000	0.0000	108.0000

Description	Face or Leg	Offset Type	Offsets: Horz Lateral Vert ft ft ft	Azimuth Adjustment °	Placement ft
			0.0000		
AIR 32 B2A/B66AA w/ Mount Pipe	B	From Leg	0.0000 4.0000	0.0000	108.0000
AIR 32 B2A/B66AA w/ Mount Pipe	C	From Leg	0.0000 4.0000	0.0000	108.0000
KRY 112 144/1	A	From Leg	0.0000 4.0000	0.0000	108.0000
KRY 112 144/1	B	From Leg	0.0000 4.0000	0.0000	108.0000
KRY 112 144/1	C	From Leg	0.0000 4.0000	0.0000	108.0000
SDX1926Q-43	A	From Leg	0.0000 4.0000	0.0000	108.0000
SDX1926Q-43	B	From Leg	0.0000 4.0000	0.0000	108.0000
SDX1926Q-43	C	From Leg	0.0000 4.0000	0.0000	108.0000
RADIO 4449 B71 B85A_T-MOBILE	A	From Leg	0.0000 4.0000	0.0000	108.0000
RADIO 4449 B71 B85A_T-MOBILE	B	From Leg	0.0000 4.0000	0.0000	108.0000
RADIO 4449 B71 B85A_T-MOBILE	C	From Leg	0.0000 4.0000	0.0000	108.0000
RRUS 4415 B25	A	From Leg	0.0000 4.0000	0.0000	108.0000
RRUS 4415 B25	B	From Leg	0.0000 4.0000	0.0000	108.0000
RRUS 4415 B25	C	From Leg	0.0000 4.0000	0.0000	108.0000
Platform Mount [LP 303-1_KCKR-HR-1] 6' x 2" Mount Pipe	C	None	0.0000	0.0000	108.0000
6' x 2" Mount Pipe	A	From Leg	4.0000	0.0000	108.0000
6' x 2" Mount Pipe	B	From Leg	0.0000 4.0000	0.0000	108.0000
6' x 2" Mount Pipe	C	From Leg	0.0000 4.0000	0.0000	108.0000
***			0.0000		
HPA-65R-BUU-H6 w/ Mount Pipe	A	From Leg	4.0000	0.0000	98.0000
HPA-65R-BUU-H8 w/ Mount Pipe	B	From Leg	0.0000 4.0000	0.0000	98.0000
HPA-65R-BUU-H6 w/ Mount Pipe	C	From Leg	0.0000 4.0000	0.0000	98.0000
SBNH-1D6565C w/ Mount Pipe	A	From Leg	0.0000 4.0000	0.0000	98.0000



Description	Face or Leg	Offset Type	Offsets: Horz Lateral Vert ft ft ft	Azimuth Adjustment °	Placement ft
			0.0000		
AM-X-CD-16-65-00T-RET w/ Mount Pipe	B	From Leg	0.0000 4.0000	0.0000	98.0000
			0.0000		
AM-X-CD-16-65-00T-RET w/ Mount Pipe	C	From Leg	0.0000 4.0000	0.0000	98.0000
			0.0000		
7770.00 w/ Mount Pipe	A	From Leg	0.0000 4.0000	0.0000	98.0000
			0.0000		
7770.00 w/ Mount Pipe	B	From Leg	0.0000 4.0000	0.0000	98.0000
			0.0000		
7770.00 w/ Mount Pipe	C	From Leg	0.0000 4.0000	0.0000	98.0000
			0.0000		
RRUS 11 B12	A	From Leg	0.0000 4.0000	0.0000	98.0000
			0.0000		
RRUS 11 B12	B	From Leg	0.0000 4.0000	0.0000	98.0000
			0.0000		
RRUS 11 B12	C	From Leg	0.0000 4.0000	0.0000	98.0000
			0.0000		
DTMABP7819VG12A	A	From Leg	0.0000 4.0000	0.0000	98.0000
			0.0000		
DTMABP7819VG12A	B	From Leg	0.0000 4.0000	0.0000	98.0000
			0.0000		
DTMABP7819VG12A	C	From Leg	0.0000 4.0000	0.0000	98.0000
			0.0000		
RRUS 32 B2	A	From Leg	0.0000 4.0000	0.0000	98.0000
			0.0000		
RRUS 32 B2	B	From Leg	0.0000 4.0000	0.0000	98.0000
			0.0000		
RRUS 32 B2	C	From Leg	0.0000 4.0000	0.0000	98.0000
			0.0000		
TT19-08BP111-001	A	From Leg	0.0000 4.0000	0.0000	98.0000
			0.0000		
TT19-08BP111-001	B	From Leg	0.0000 4.0000	0.0000	98.0000
			0.0000		
TT19-08BP111-001	C	From Leg	0.0000 4.0000	0.0000	98.0000
			0.0000		
(2) 7020.00	A	From Leg	0.0000 4.0000	0.0000	98.0000
			0.0000		
(2) 7020.00	B	From Leg	0.0000 4.0000	0.0000	98.0000
			0.0000		
(2) 7020.00	C	From Leg	0.0000 4.0000	0.0000	98.0000
			0.0000		
DC6-48-60-18-8F	A	From Leg	0.0000 4.0000	0.0000	98.0000
			0.0000		
			0.0000		

Description	Face or Leg	Offset Type	Offsets:		
			Horz Lateral Vert ft ft ft	Azimuth Adjustment °	Placement ft
Platform Mount [LP 712-1] ***	C	None		0.0000	98.0000
(2) HBXX-6517DS-A2M w/ Mount Pipe	A	From Leg	4.0000 0.0000 1.0000	0.0000	85.0000
(2) HBXX-6517DS-A2M w/ Mount Pipe	B	From Leg	4.0000 0.0000 1.0000	0.0000	85.0000
(2) HBXX-6517DS-A2M w/ Mount Pipe	C	From Leg	4.0000 0.0000 1.0000	0.0000	85.0000
(2) BXA-70040-6CF-EDIN-2 w/ Mount Pipe	A	From Leg	4.0000 0.0000 1.0000	0.0000	85.0000
(2) BXA-70063-6CF-2 w/ Mount Pipe	B	From Leg	4.0000 0.0000 1.0000	0.0000	85.0000
(2) BXA-70063-6CF-2 w/ Mount Pipe	C	From Leg	4.0000 0.0000 1.0000	0.0000	85.0000
(2) CBC721-DF	B	From Leg	4.0000 0.0000 1.0000	0.0000	85.0000
(4) CBC721-DF	C	From Leg	4.0000 0.0000 1.0000	0.0000	85.0000
(2) RRH2X60-AWS	A	From Leg	4.0000 0.0000 1.0000	0.0000	85.0000
RRH2X60-AWS	B	From Leg	4.0000 0.0000 1.0000	0.0000	85.0000
RRH2X60-PCS	B	From Leg	4.0000 0.0000 1.0000	0.0000	85.0000
(2) RRH2X60-PCS	C	From Leg	4.0000 0.0000 1.0000	0.0000	85.0000
DB-B1-6C-12AB-0Z	B	From Leg	4.0000 0.0000 1.0000	0.0000	85.0000
Platform Mount [LP 303-1] ***	C	None		0.0000	85.0000
KS24019-L112A	A	From Leg	3.0000 0.0000 1.0000	0.0000	80.0000
Side Arm Mount [SO 701-1] ***	A	From Leg	1.5000 0.0000 0.0000	0.0000	80.0000
LLPX310R w/ Mount Pipe	A	From Leg	2.0000 0.0000 2.0000	0.0000	72.0000
LLPX310R w/ Mount Pipe	B	From Leg	2.0000 0.0000 0.0000	0.0000	72.0000
LLPX310R w/ Mount Pipe	C	From Leg	2.0000 0.0000 2.0000	0.0000	72.0000
WIMAX DAP HEAD	A	From Leg	2.0000 0.0000 2.0000	0.0000	72.0000
WIMAX DAP HEAD	B	From Leg	2.0000 0.0000 0.0000	0.0000	72.0000

Description	Face or Leg	Offset Type	Offsets: Horz Lateral Vert ft ft ft	Azimuth Adjustment °	Placement ft
WIMAX DAP HEAD	B	From Leg	2.0000 0.0000 1.0000	0.0000	72.0000
HORIZON COMPACT	A	From Leg	2.0000 0.0000 0.0000	0.0000	72.0000
HORIZON COMPACT	C	From Leg	2.0000 0.0000 2.0000	0.0000	72.0000
Side Arm Mount [SO 101-3] ***	C	None		0.0000	72.0000
MX08FRO665-21 w/ Mount Pipe	A	From Leg	4.0000 0.0000 0.0000	0.0000	62.0000
MX08FRO665-21 w/ Mount Pipe	B	From Leg	4.0000 0.0000 0.0000	0.0000	62.0000
MX08FRO665-21 w/ Mount Pipe	C	From Leg	4.0000 0.0000 0.0000	0.0000	62.0000
TA08025-B604	A	From Leg	4.0000 0.0000 0.0000	0.0000	62.0000
TA08025-B604	B	From Leg	4.0000 0.0000 0.0000	0.0000	62.0000
TA08025-B604	C	From Leg	4.0000 0.0000 0.0000	0.0000	62.0000
TA08025-B605	A	From Leg	4.0000 0.0000 0.0000	0.0000	62.0000
TA08025-B605	B	From Leg	4.0000 0.0000 0.0000	0.0000	62.0000
TA08025-B605	C	From Leg	4.0000 0.0000 0.0000	0.0000	62.0000
RDIDC-9181-PF-48	A	From Leg	4.0000 0.0000 0.0000	0.0000	62.0000
(2) 8' x 2" Mount Pipe	A	From Leg	4.0000 0.0000 0.0000	0.0000	62.0000
(2) 8' x 2" Mount Pipe	B	From Leg	4.0000 0.0000 0.0000	0.0000	62.0000
(2) 8' x 2" Mount Pipe	C	From Leg	4.0000 0.0000 0.0000	0.0000	62.0000
Sabre_C10801018-32788 *** ***	C	None		0.0000	62.0000

**Dishes**

Description	Face or Leg	Dish Type	Offset Type	Offsets: Horz Lateral Vert ft	Azimuth Adjustment °	3 dB Beam Width °	Elevation ft	Outside Diameter ft
*** *** VHLP1-23	B	Paraboloid w/Shroud (HP)	From Leg	4.0000 0.0000 2.0000	0.0000		114.0000	1.2750
*** A-ANT-18G-2-C	A	Paraboloid w/Shroud (HP)	From Leg	2.0000 0.0000 0.0000	0.0000		72.0000	2.1750
VHLP1-23 *** ***	B	Paraboloid w/Shroud (HP)	From Leg	2.0000 0.0000 1.0000	0.0000		72.0000	1.2750

### Load Combinations

Comb. No.	Description
1	Dead Only
2	1.2 Dead+1.0 Wind 0 deg - No Ice
3	0.9 Dead+1.0 Wind 0 deg - No Ice
4	1.2 Dead+1.0 Wind 30 deg - No Ice
5	0.9 Dead+1.0 Wind 30 deg - No Ice
6	1.2 Dead+1.0 Wind 60 deg - No Ice
7	0.9 Dead+1.0 Wind 60 deg - No Ice
8	1.2 Dead+1.0 Wind 90 deg - No Ice
9	0.9 Dead+1.0 Wind 90 deg - No Ice
10	1.2 Dead+1.0 Wind 120 deg - No Ice
11	0.9 Dead+1.0 Wind 120 deg - No Ice
12	1.2 Dead+1.0 Wind 150 deg - No Ice
13	0.9 Dead+1.0 Wind 150 deg - No Ice
14	1.2 Dead+1.0 Wind 180 deg - No Ice
15	0.9 Dead+1.0 Wind 180 deg - No Ice
16	1.2 Dead+1.0 Wind 210 deg - No Ice
17	0.9 Dead+1.0 Wind 210 deg - No Ice
18	1.2 Dead+1.0 Wind 240 deg - No Ice
19	0.9 Dead+1.0 Wind 240 deg - No Ice
20	1.2 Dead+1.0 Wind 270 deg - No Ice
21	0.9 Dead+1.0 Wind 270 deg - No Ice
22	1.2 Dead+1.0 Wind 300 deg - No Ice
23	0.9 Dead+1.0 Wind 300 deg - No Ice
24	1.2 Dead+1.0 Wind 330 deg - No Ice
25	0.9 Dead+1.0 Wind 330 deg - No Ice
26	1.2 Dead+1.0 Ice+1.0 Temp
27	1.2 Dead+1.0 Wind 0 deg+1.0 Ice+1.0 Temp
28	1.2 Dead+1.0 Wind 30 deg+1.0 Ice+1.0 Temp
29	1.2 Dead+1.0 Wind 60 deg+1.0 Ice+1.0 Temp
30	1.2 Dead+1.0 Wind 90 deg+1.0 Ice+1.0 Temp
31	1.2 Dead+1.0 Wind 120 deg+1.0 Ice+1.0 Temp
32	1.2 Dead+1.0 Wind 150 deg+1.0 Ice+1.0 Temp
33	1.2 Dead+1.0 Wind 180 deg+1.0 Ice+1.0 Temp
34	1.2 Dead+1.0 Wind 210 deg+1.0 Ice+1.0 Temp
35	1.2 Dead+1.0 Wind 240 deg+1.0 Ice+1.0 Temp
36	1.2 Dead+1.0 Wind 270 deg+1.0 Ice+1.0 Temp
37	1.2 Dead+1.0 Wind 300 deg+1.0 Ice+1.0 Temp
38	1.2 Dead+1.0 Wind 330 deg+1.0 Ice+1.0 Temp
39	Dead+Wind 0 deg - Service
40	Dead+Wind 30 deg - Service
41	Dead+Wind 60 deg - Service
42	Dead+Wind 90 deg - Service
43	Dead+Wind 120 deg - Service
44	Dead+Wind 150 deg - Service
45	Dead+Wind 180 deg - Service

Comb. No.	Description
46	Dead+Wind 210 deg - Service
47	Dead+Wind 240 deg - Service
48	Dead+Wind 270 deg - Service
49	Dead+Wind 300 deg - Service
50	Dead+Wind 330 deg - Service

### Maximum Member Forces

Section No.	Elevation ft	Component Type	Condition	Gov. Load Comb.	Axial K	Major Axis Moment kip-ft	Minor Axis Moment kip-ft
L1	118 - 113	Pole	Max Tension	39	0.0000	0.0001	-0.0000
			Max. Compression	26	-9.4789	-0.6019	-0.3432
			Max. Mx	8	-3.0557	-8.3996	-0.2301
			Max. My	14	-3.0577	-0.3303	-8.2167
			Max. Vy	20	-3.6424	8.0019	0.0089
			Max. Vx	2	-3.6005	-0.0339	7.9701
			Max. Torque	4			-0.3715
L2	113 - 108	Pole	Max Tension	1	0.0000	0.0000	0.0000
			Max. Compression	26	-10.1911	-0.6090	-0.3327
			Max. Mx	8	-3.4424	-27.3581	-0.4170
			Max. My	14	-3.4444	-0.5460	-27.0281
			Max. Vy	20	-3.9741	27.0431	0.2245
			Max. Vx	2	-3.9322	0.2548	26.8020
			Max. Torque	4			-0.3715
L3	108 - 103	Pole	Max Tension	1	0.0000	0.0000	0.0000
			Max. Compression	26	-22.1112	-0.6235	-0.3089
			Max. Mx	8	-8.0985	-69.5118	-0.6086
			Max. My	14	-8.1002	-0.7732	-69.0359
			Max. Vy	20	-8.6109	69.2817	0.4503
			Max. Vx	2	-8.5695	0.5501	68.8333
			Max. Torque	4			-0.3715
L4	103 - 98	Pole	Max Tension	1	0.0000	0.0000	0.0000
			Max. Compression	26	-22.8649	-0.6371	-0.2835
			Max. Mx	8	-8.5440	-113.2663	-0.8001
			Max. My	14	-8.5455	-1.0005	-112.6450
			Max. Vy	20	-8.9264	113.1214	0.6768
			Max. Vx	2	-8.8851	0.8459	112.4662
			Max. Torque	4			-0.3715
L5	98 - 93	Pole	Max Tension	1	0.0000	0.0000	0.0000
			Max. Compression	26	-32.7510	-1.1903	0.6336
			Max. Mx	8	-11.6934	-180.0068	-1.0031
			Max. My	2	-11.6943	1.0893	178.8706
			Max. Vy	20	-13.4838	179.6246	1.0626
			Max. Vx	2	-13.4136	1.0893	178.8706
			Max. Torque	14			0.6563
L6	93 - 90	Pole	Max Tension	1	0.0000	0.0000	0.0000
			Max. Compression	26	-33.2302	-1.1989	0.6547
			Max. Mx	8	-12.0116	-220.6474	-1.1678
			Max. My	2	-12.0121	1.3180	219.3532
			Max. Vy	20	-13.6526	220.3178	1.2508
			Max. Vx	2	-13.5825	1.3180	219.3532
			Max. Torque	14			0.6562
L7	90 - 85	Pole	Max Tension	1	0.0000	0.0000	0.0000
			Max. Compression	26	-35.6385	-1.2115	0.6908
			Max. Mx	8	-13.6779	-291.3397	-1.4430
			Max. My	2	-13.6778	1.7010	289.7850
			Max. Vy	20	-14.3040	291.0987	1.5660
			Max. Vx	2	-14.2343	1.7010	289.7850
			Max. Torque	14			0.6560
L8	85 - 80	Pole	Max Tension	1	0.0000	0.0000	0.0000
			Max. Compression	26	-45.8482	-1.5392	2.0085
			Max. Mx	8	-17.2015	-389.8515	-1.6255
			Max. My	2	-17.1806	2.1991	390.4417
			Max. Vy	20	-19.1472	389.6471	2.2159
			Max. Vx	2	-19.4166	2.1991	390.4417
			Max. Torque	14			1.0042

Section No.	Elevation ft	Component Type	Condition	Gov. Load Comb.	Axial K	Major Axis Moment kip-ft	Minor Axis Moment kip-ft
L9	80 - 76.5	Pole	Max Tension	1	0.0000	0.0000	0.0000
			Max. Compression	26	-46.9173	-1.4098	2.5108
			Max. Mx	8	-17.8662	-457.4000	-1.6533
			Max. My	2	-17.8506	2.5817	459.0793
			Max. Vy	20	-19.4399	457.3455	2.7420
			Max. Vx	2	-19.6297	2.5817	459.0793
L10	76.5 - 76.25	Pole	Max. Torque	14			1.0039
			Max Tension	1	0.0000	0.0000	0.0000
			Max. Compression	26	-47.0028	-1.4008	2.5216
			Max. Mx	8	-17.9318	-462.2514	-1.6700
			Max. My	2	-17.9166	2.6090	463.9874
			Max. Vy	20	-19.4578	462.2090	2.7649
L11	76.25 - 74	Pole	Max. Vx	14	19.6418	-2.6628	-462.9698
			Max. Torque	14			1.0036
			Max Tension	1	0.0000	0.0000	0.0000
			Max. Compression	26	-47.7716	-1.3167	2.6028
			Max. Mx	20	-18.4072	506.2909	2.9699
			Max. My	2	-18.4027	2.8548	508.3069
L12	74 - 73.75	Pole	Max. Vy	20	-19.7116	506.2909	2.9699
			Max. Vx	14	19.8945	-2.8208	-507.4193
			Max. Torque	14			1.0035
			Max Tension	1	0.0000	0.0000	0.0000
			Max. Compression	26	-47.8774	-1.3076	2.6140
			Max. Mx	20	-18.4884	511.2234	2.9928
L13	73.75 - 68.88	Pole	Max. My	2	-18.4847	2.8820	513.2476
			Max. Vy	20	-19.7340	511.2234	2.9928
			Max. Vx	14	19.9168	-2.8385	-512.3924
			Max. Torque	14			1.0034
			Max Tension	1	0.0000	0.0000	0.0000
			Max. Compression	26	-52.0815	-1.5946	3.0757
L14	68.88 - 68.63	Pole	Max. Mx	20	-20.6035	612.0729	3.5510
			Max. My	2	-20.5980	3.2638	614.6498
			Max. Vy	20	-21.2320	612.0729	3.5510
			Max. Vx	14	21.5069	-3.3568	-614.4359
			Max. Torque	14			1.1809
			Max Tension	1	0.0000	0.0000	0.0000
L15	68.63 - 64.5	Pole	Max. Compression	26	-52.1828	-1.5854	3.0793
			Max. Mx	20	-20.6672	617.3861	3.5788
			Max. My	2	-20.6621	3.2968	619.9768
			Max. Vy	20	-21.2606	617.3861	3.5788
			Max. Vx	14	21.5286	-3.3764	-619.8138
			Max. Torque	14			1.1808
L16	64.5 - 64.25	Pole	Max Tension	1	0.0000	0.0000	0.0000
			Max. Compression	26	-53.7921	-1.4292	3.1153
			Max. Mx	20	-21.6177	706.3616	4.0344
			Max. My	14	-21.6122	-3.6985	-709.5817
			Max. Vy	20	-21.8151	706.3616	4.0344
			Max. Vx	14	21.9558	-3.6985	-709.5817
L17	64.25 - 63	Pole	Max. Torque	14			1.1807
			Max Tension	1	0.0000	0.0000	0.0000
			Max. Compression	26	-53.9218	-1.4199	3.1196
			Max. Mx	20	-21.7147	711.8201	4.0619
			Max. My	14	-21.7098	-3.7180	-715.0708
			Max. Vy	20	-21.8432	711.8201	4.0619
L18	63 - 62.75	Pole	Max. Vx	14	21.9728	-3.7180	-715.0708
			Max. Torque	14			1.1803
			Max Tension	1	0.0000	0.0000	0.0000
			Max. Compression	26	-54.5696	-1.3721	3.1281
			Max. Mx	20	-22.1345	739.2581	4.1993
			Max. My	14	-22.1321	-3.8152	-742.6209
L18	63 - 62.75	Pole	Max. Vy	20	-22.0452	739.2581	4.1993
			Max. Vx	14	22.1200	-3.8152	-742.6209
			Max. Torque	14			1.1803
			Max Tension	1	0.0000	0.0000	0.0000
L18	63 - 62.75	Pole	Max. Compression	26	-54.6967	-1.3628	3.1307
			Max. Mx	20	-22.2260	744.7748	4.2268
			Max. My	14	-22.2241	-3.8347	-748.1518

Section No.	Elevation ft	Component Type	Condition	Gov. Load Comb.	Axial K	Major Axis Moment kip-ft	Minor Axis Moment kip-ft
L19	62.75 - 60	Pole	Max. Vy	20	-22.0760	744.7748	4.2268
			Max. Vx	14	22.1397	-3.8347	-748.1518
			Max. Torque	14			1.1802
			Max Tension	1	0.0000	0.0000	0.0000
			Max. Compression	26	-62.2550	-1.2578	3.6711
			Max. Mx	20	-25.9841	811.1061	4.6463
			Max. My	14	-25.9855	-4.0493	-814.4206
			Max. Vy	20	-25.0078	811.1061	4.6463
L20	60 - 59.75	Pole	Max. Vx	14	24.9981	-4.0493	-814.4206
			Max. Torque	24			-1.2925
			Max Tension	1	0.0000	0.0000	0.0000
			Max. Compression	26	-64.5253	-1.2467	3.6712
			Max. Mx	20	-27.6086	817.4768	4.6731
			Max. My	14	-27.6101	-4.0682	-820.7859
			Max. Vy	20	-25.4789	817.4768	4.6731
			Max. Vx	14	25.4675	-4.0682	-820.7859
L21	59.75 - 54.75	Pole	Max. Torque	24			-1.2909
			Max Tension	1	0.0000	0.0000	0.0000
			Max. Compression	26	-66.7438	-1.0167	3.6173
			Max. Mx	20	-29.2311	945.7611	5.2092
			Max. My	14	-29.2340	-4.4461	-948.8762
			Max. Vy	20	-25.8140	945.7611	5.2092
			Max. Vx	14	25.7704	-4.4461	-948.8762
			Max. Torque	24			-1.2909
L22	54.75 - 49.75	Pole	Max Tension	1	0.0000	0.0000	0.0000
			Max. Compression	26	-68.9667	-0.7786	3.5569
			Max. Mx	20	-30.8744	1075.6100	5.7433
			Max. My	14	-30.8786	-4.8220	-
			Max. Vy	20	-26.1139	1075.6100	5.7433
			Max. Vx	14	26.0363	-4.8220	-
			Max. Torque	24			1078.3657
			Max Tension	1	0.0000	0.0000	0.0000
L23	49.75 - 49.25	Pole	Max. Compression	26	-69.1986	-0.7462	3.5429
			Max. Mx	20	-31.0447	1088.6758	5.7966
			Max. My	14	-31.0491	-4.8594	-
			Max. Vy	20	-26.1381	1088.6758	5.7966
			Max. Vx	14	26.0550	-4.8594	-
			Max. Torque	24			1091.3857
			Max Tension	1	0.0000	0.0000	0.0000
			Max. Compression	26	-69.3206	-0.7302	3.5372
L24	49.25 - 49	Pole	Max. Mx	20	-31.1356	1095.2146	5.8233
			Max. My	14	-31.1400	-4.8782	-
			Max. Vy	20	-26.1512	1095.2146	5.8233
			Max. Vx	14	26.0653	-4.8782	-
			Max. Torque	24			1097.9005
			Max Tension	1	0.0000	0.0000	0.0000
			Max. Compression	26	-71.7567	-0.4071	3.3903
			Max. Mx	20	-32.8886	1226.8195	6.3550
L25	49 - 44	Pole	Max. My	14	-32.8944	-5.2518	-
			Max. Vy	20	-26.4718	1226.8195	6.3550
			Max. Vx	2	-26.5082	6.5951	1225.3802
			Max. Torque	24			-1.2903
			Max Tension	1	0.0000	0.0000	0.0000
			Max. Compression	26	-72.7612	-0.2789	3.3330
			Max. Mx	20	-33.5959	1279.8856	6.5670
			Max. My	14	-33.6022	-5.4006	-
L26	44 - 42	Pole	Max. Vy	20	-26.5881	1279.8856	6.5670
			Max. Vx	2	-26.7348	6.8642	1278.5925
			Max. Torque	24			-1.2903
			Max Tension	1	0.0000	0.0000	0.0000

Section No.	Elevation ft	Component Type	Condition	Gov. Load Comb.	Axial K	Major Axis Moment kip-ft	Minor Axis Moment kip-ft
L27	42 - 41.75	Pole	Max. Torque	24			-1.2900
			Max Tension	1	0.0000	0.0000	0.0000
			Max. Compression	26	-72.8999	-0.2631	3.3278
			Max. Mx	20	-33.7008	1286.5352	6.5935
			Max. My	14	-33.7071	-5.4192	-
L28	41.75 - 36.75	Pole	Max. Vy	20	-26.5938	1286.5352	6.5935
			Max. Vx	2	-26.7549	6.8979	1285.2759
			Max. Torque	24			-1.2899
			Max Tension	1	0.0000	0.0000	0.0000
			Max. Compression	26	-75.6667	0.0555	3.1849
			Max. Mx	20	-35.6440	1420.2782	7.1219
L29	36.75 - 34.5	Pole	Max. My	14	-35.6511	-5.7897	-
							1420.9631
			Max. Vy	8	27.0375	-	-3.8990
						1415.0025	
			Max. Vx	2	-27.3300	7.5693	1420.4400
			Max. Torque	24			-1.2899
L30	34.5 - 34.25	Pole	Max Tension	1	0.0000	0.0000	0.0000
			Max. Compression	26	-76.9390	0.1976	3.1223
			Max. Mx	20	-36.5215	1481.0397	7.3589
			Max. My	2	-36.5097	7.8709	1482.1761
			Max. Vy	8	27.2740	-	-4.0415
						1476.0385	
L31	34.25 - 34	Pole	Max. Vx	2	-27.5814	7.8709	1482.1761
			Max. Torque	24			-1.2897
			Max Tension	1	0.0000	0.0000	0.0000
			Max. Compression	26	-77.0937	0.2132	3.1169
			Max. Mx	20	-36.6372	1487.8247	7.3852
			Max. My	2	-36.6258	7.9045	1489.0702
L32	34 - 33.75	Pole	Max. Vy	8	27.2975	-	-4.0573
						1482.8539	
			Max. Vx	2	-27.5982	7.9045	1489.0702
			Max. Torque	24			-1.2718
			Max Tension	1	0.0000	0.0000	0.0000
			Max. Compression	26	-77.2484	0.2289	3.1100
L33	33.75 - 30	Pole	Max. Mx	20	-36.7439	1494.6188	7.4115
			Max. My	2	-36.7327	7.9380	1495.9715
			Max. Vy	8	27.3327	-	-4.0731
						1489.6780	
			Max. Vx	2	-27.6269	7.9380	1495.9715
			Max. Torque	24			-1.2694
L34	30 - 29.75	Pole	Max Tension	1	0.0000	0.0000	0.0000
			Max. Compression	26	-77.3939	0.2447	3.1029
			Max. Mx	20	-36.8416	1501.4218	7.4378
			Max. My	2	-36.8307	7.9715	1502.8799
			Max. Vy	8	27.3673	-	-4.0889
						1496.5108	
L35	29.75 - 28.5	Pole	Max. Vx	2	-27.6549	7.9715	1502.8799
			Max. Torque	24			-1.2670
			Max Tension	1	0.0000	0.0000	0.0000
			Max. Compression	26	-79.4547	0.4751	3.0037
			Max. Mx	20	-38.3049	1604.4443	7.8313
			Max. My	2	-38.2971	8.4728	1607.2729
L35	29.75 - 28.5	Pole	Max. Vy	8	27.8591	-	-4.3254
						1599.9635	
			Max. Vx	2	-28.0505	8.4728	1607.2729
			Max. Torque	24			-1.2646
			Max Tension	1	0.0000	0.0000	0.0000
			Max. Compression	26	-81.7038	0.4879	3.0024
L35	29.75 - 28.5	Pole	Max. Mx	20	-39.9575	1611.4692	7.8572
			Max. My	2	-39.9499	8.5069	1614.3753
			Max. Vy	8	28.2328	-	-4.3415
						1607.0149	
			Max. Vx	2	-28.4236	8.5069	1614.3753
			Max. Torque	24			-1.2198
L35	29.75 - 28.5	Pole	Max Tension	1	0.0000	0.0000	0.0000
			Max. Compression	26	-82.4062	0.5680	2.9783



Section No.	Elevation ft	Component Type	Condition	Gov. Load Comb.	Axial K	Major Axis Moment kip-ft	Minor Axis Moment kip-ft	
L36	28.5 - 28.25	Pole	Max. Mx	20	-40.4394	1646.6443	7.9871	
			Max. My	2	-40.4306	8.6770	1649.9872	
			Max. Vy	8	28.3939	-	-4.4212	
							1642.3719	
			Max. Vx	2	-28.5847	8.6770	1649.9872	
			Max. Torque	24			-1.2198	
			Max Tension	1	0.0000	0.0000	0.0000	
			Max. Compression	26	-82.5615	0.5845	2.9749	
			Max. Mx	20	-40.5606	1653.6898	8.0130	
			Max. My	2	-40.5518	8.7111	1657.1319	
L37	28.25 - 23.25	Pole	Max. Vy	8	28.4111	-	-4.4373	
							1649.4657	
			Max. Vx	2	-28.6019	8.7111	1657.1319	
			Max. Torque	24			-1.2198	
			Max Tension	1	0.0000	0.0000	0.0000	
			Max. Compression	26	-85.7144	0.9388	2.8829	
			Max. Mx	20	-42.7824	1796.1137	8.5307	
			Max. My	2	-42.7748	9.3900	1801.6100	
			Max. Vy	8	29.0248	-	-4.7557	
							1792.9362	
L38	23.25 - 23	Pole	Max. Vx	2	-29.2108	9.3900	1801.6100	
			Max. Torque	24			-1.2198	
			Max Tension	1	0.0000	0.0000	0.0000	
			Max. Compression	26	-85.8872	0.9575	2.8802	
			Max. Mx	20	-42.9127	1803.3115	8.5565	
			Max. My	2	-42.9053	9.4240	1808.9121	
			Max. Vy	8	29.0456	-	-4.7716	
							1800.1886	
			Max. Vx	2	-29.2310	9.4240	1808.9121	
			Max. Torque	24			-1.2197	
L39	23 - 21.5	Pole	Max Tension	1	0.0000	0.0000	0.0000	
			Max. Compression	26	-86.9225	1.0707	2.8549	
			Max. Mx	20	-43.6435	1846.6534	8.7114	
			Max. My	2	-43.6363	9.6271	1852.8812	
			Max. Vy	8	29.2418	-	-4.8668	
							1843.8622	
			Max. Vx	2	-29.4242	9.6271	1852.8812	
			Max. Torque	24			-1.2197	
			Max Tension	1	0.0000	0.0000	0.0000	
			Max. Compression	26	-87.0811	1.0893	2.8520	
L40	21.5 - 21.25	Pole	Max. Mx	20	-43.7636	1853.9026	8.7371	
			Max. My	2	-43.7567	9.6611	1860.2351	
			Max. Vy	8	29.2562	-	-4.8828	
							1851.1673	
			Max. Vx	2	-29.4380	9.6611	1860.2351	
			Max. Torque	24			-1.2196	
			Max Tension	1	0.0000	0.0000	0.0000	
			Max. Compression	26	-88.5205	1.2576	2.8156	
			Max. Mx	20	-44.7503	1919.4591	8.9687	
			Max. My	2	-44.7440	9.9654	1926.7385	
L41	21.25 - 19	Pole	Max. Vy	8	29.5167	-	-5.0255	
							1917.2251	
			Max. Vx	2	-29.7049	9.9654	1926.7385	
			Max. Torque	24			-1.2196	
			Max Tension	1	0.0000	0.0000	0.0000	
			Max. Compression	26	-88.6921	1.2760	2.8128	
			Max. Mx	20	-44.8830	1926.7790	8.9944	
			Max. My	2	-44.8770	9.9993	1934.1630	
			Max. Vy	8	29.5392	-	-5.0414	
							1924.6002	
L42	19 - 18.75	Pole	Max. Vx	2	-29.7202	9.9993	1934.1630	
			Max. Torque	24			-1.2044	
			Max Tension	1	0.0000	0.0000	0.0000	
			Max. Compression	26	-88.8635	1.2946	2.8089	
			Max. Mx	20	-45.0068	1934.1080	9.0201	
			Max. My	2	-45.0009	10.0330	1941.5947	
			Max. Vy	8	29.5749	-	-5.0572	
							1931.9842	
			Max. Vx	2	-29.7202	9.9993	1934.1630	
			Max. Torque	24			-1.2044	
L43	18.75 - 18.5	Pole	Max Tension	1	0.0000	0.0000	0.0000	
			Max. Compression	26	-88.8635	1.2946	2.8089	
			Max. Mx	20	-45.0068	1934.1080	9.0201	
			Max. My	2	-45.0009	10.0330	1941.5947	
			Max. Vy	8	29.5749	-	-5.0572	
							1931.9842	
			Max. Vx	2	-29.7202	9.9993	1934.1630	
			Max. Torque	24			-1.2044	
			Max Tension	1	0.0000	0.0000	0.0000	
			Max. Compression	26	-88.8635	1.2946	2.8089	

Section No.	Elevation ft	Component Type	Condition	Gov. Load Comb.	Axial K	Major Axis Moment kip-ft	Minor Axis Moment kip-ft
L44	18.5 - 18.25	Pole	Max. Vx	2	-29.7487	10.0330	1941.5947
			Max. Torque	24			-1.2022
			Max Tension	1	0.0000	0.0000	0.0000
			Max. Compression	26	-89.0262	1.3131	2.8050
			Max. Mx	20	-45.1220	1941.4461	9.0458
			Max. My	2	-45.1163	10.0668	1949.0334
			Max. Vy	8	29.6101	-	-5.0731
L45	18.25 - 13.25	Pole	Max. Vx	2	-29.7769	10.0668	1949.0334
			Max. Torque	24			-1.2000
			Max Tension	1	0.0000	0.0000	0.0000
			Max. Compression	26	-92.1829	1.6274	2.7588
			Max. Mx	20	-47.4285	2089.5936	9.5578
			Max. My	2	-47.4244	10.7407	2099.1547
			Max. Vy	8	30.1043	-	-5.3891
L46	13.25 - 12.7	Pole	Max. Vx	2	-30.2956	10.7407	2099.1547
			Max. Torque	24			-1.1978
			Max Tension	1	0.0000	0.0000	0.0000
			Max. Compression	26	-92.5289	1.6574	2.7632
			Max. Mx	20	-47.6879	2106.0498	9.6139
			Max. My	2	-47.6843	10.8147	2115.8208
			Max. Vy	8	30.1647	-	-5.4238
L47	12.7 - 12.45	Pole	Max. Vx	2	-30.3416	10.8147	2115.8208
			Max. Torque	14			1.1783
			Max Tension	1	0.0000	0.0000	0.0000
			Max. Compression	26	-92.6880	1.6700	2.7686
			Max. Mx	20	-47.8075	2113.5430	9.6393
			Max. My	2	-47.8040	10.8483	2123.4059
			Max. Vy	8	30.1911	-	-5.4396
L48	12.45 - 11.5	Pole	Max. Vx	2	-30.3608	10.8483	2123.4059
			Max. Torque	14			1.1783
			Max Tension	1	0.0000	0.0000	0.0000
			Max. Compression	26	-93.2914	1.7183	2.7868
			Max. Mx	20	-48.2437	2142.0912	9.7361
			Max. My	2	-48.2406	10.9759	2152.2830
			Max. Vy	8	30.3193	-	-5.4994
L49	11.5 - 11.25	Pole	Max. Vx	2	-30.4620	10.9759	2152.2830
			Max. Torque	14			1.1783
			Max Tension	1	0.0000	0.0000	0.0000
			Max. Compression	26	-93.4588	1.7309	2.7921
			Max. Mx	20	-48.3767	2149.6234	9.7615
			Max. My	2	-48.3739	11.0095	2159.8964
			Max. Vy	8	30.3383	-	-5.5152
L50	11.25 - 10.5	Pole	Max. Vx	2	-30.4739	11.0095	2159.8964
			Max. Torque	14			1.1783
			Max Tension	1	0.0000	0.0000	0.0000
			Max. Compression	26	-93.9604	1.7688	2.8064
			Max. Mx	20	-48.7487	2172.2686	9.8378
			Max. My	2	-48.7462	11.1101	2182.7715
			Max. Vy	8	30.4381	-	-5.5624
L51	10.5 - 10.25	Pole	Max. Vx	2	-30.5523	11.1101	2182.7715
			Max. Torque	14			1.1783
			Max Tension	1	0.0000	0.0000	0.0000
			Max. Compression	26	-94.1427	1.7813	2.8118
			Max. Mx	20	-48.8943	2179.8334	9.8631
			Max. My	2	-48.8921	11.1437	2190.4085
			Max. Vy	8	30.4613	-	-5.5782
L52	10.25 - 7.5	Pole	Max. Vx	2	-30.5684	11.1437	2190.4085
			Max. Torque	14			1.1782
			Max Tension	1	0.0000	0.0000	0.0000
			Max. Compression	26	-96.1382	1.9186	2.8638

Section No.	Elevation ft	Component Type	Condition	Gov. Load Comb.	Axial K	Major Axis Moment kip-ft	Minor Axis Moment kip-ft	
L53	7.5 - 7.25	Pole	Max. Mx	20	-50.4222	2263.6172	10.1423	
			Max. My	2	-50.4208	11.5117	2274.8376	
			Max. Vy	8	30.8342	-	-5.7509	
							2263.5093	
			Max. Vx	2	-30.8632	11.5117	2274.8376	
			Max. Torque	14			1.1782	
			Max Tension	1	0.0000	0.0000	0.0000	
			Max. Compression	26	-96.3235	1.9309	2.8690	
			Max. Mx	20	-50.5757	2271.2854	10.1675	
			Max. My	2	-50.5745	11.5453	2282.5510	
L54	7.25 - 6.25	Pole	Max. Vy	8	30.8521	-	-5.7666	
							2271.2131	
			Max. Vx	2	-30.8740	11.5453	2282.5510	
			Max. Torque	14			1.1782	
			Max Tension	1	0.0000	0.0000	0.0000	
			Max. Compression	26	-97.0631	1.9801	2.8872	
			Max. Mx	8	-51.1479	-	-5.8293	
							2302.1094	
			Max. My	2	-51.1475	11.6788	2313.4681	
			Max. Vy	8	30.9913	-	-5.8293	
L55	6.25 - 6	Pole					2302.1094	
			Max. Vx	2	-30.9848	11.6788	2313.4681	
			Max. Torque	14			1.1782	
			Max Tension	1	0.0000	0.0000	0.0000	
			Max. Compression	26	-97.2475	1.9923	2.8921	
			Max. Mx	8	-51.2984	-	-5.8450	
							2309.8537	
			Max. My	2	-51.2981	11.7123	2321.2132	
			Max. Vy	8	31.0141	-	-5.8450	
							2309.8537	
L56	6 - 3.73	Pole	Max. Vx	2	-31.0005	11.7123	2321.2132	
			Max. Torque	14			1.1782	
			Max Tension	1	0.0000	0.0000	0.0000	
			Max. Compression	26	-98.9684	2.1038	2.9262	
			Max. Mx	8	-52.6618	-	-5.9870	
							2380.5489	
			Max. My	2	-52.6616	12.0151	2391.8356	
			Max. Vy	8	31.3228	-	-5.9870	
							2380.5489	
			Max. Vx	2	-31.2461	12.0151	2391.8356	
L57	3.73 - 3.48	Pole	Max. Torque	14			1.1782	
			Max Tension	1	0.0000	0.0000	0.0000	
			Max. Compression	26	-99.1540	2.1173	2.9251	
			Max. Mx	8	-52.8186	-	-6.0026	
							2388.3737	
			Max. My	2	-52.8185	12.0485	2399.6460	
			Max. Vy	8	31.3263	-	-6.0026	
							2388.3737	
			Max. Vx	2	-31.2619	12.0485	2399.6460	
			Max. Torque	14			1.1782	
L58	3.48 - 2.75	Pole	Max Tension	1	0.0000	0.0000	0.0000	
			Max. Compression	26	-99.6944	2.1564	2.9211	
			Max. Mx	8	-53.2560	-	-6.0482	
							2411.2412	
			Max. My	2	-53.2558	12.1457	2422.4892	
			Max. Vy	8	31.3708	-	-6.0482	
							2411.2412	
			Max. Vx	2	-31.3424	12.1457	2422.4892	
			Max. Torque	14			1.1782	
			Max Tension	1	0.0000	0.0000	0.0000	
L59	2.75 - 2.5	Pole	Max. Compression	26	-99.8664	2.1696	2.9200	
			Max. Mx	8	-53.3981	-	-6.0638	
							2419.0791	
			Max. My	2	-53.3979	12.1791	2430.3248	
			Max. Vy	8	31.3785	-	-6.0638	
							2419.0791	
			Max. Vx	2	-31.3623	12.1791	2430.3248	
			Max. Torque	14			1.1782	
			Max Tension	1	0.0000	0.0000	0.0000	
			L60	2.5 - 2	Pole	Max. Torque	14	
Max Tension	1	0.0000				0.0000	0.0000	

Section No.	Elevation ft	Component Type	Condition	Gov. Load Comb.	Axial K	Major Axis Moment kip-ft	Minor Axis Moment kip-ft	
L61	2 - 1.75	Pole	Max. Compression	26	-100.2093	2.1959	2.9175	
			Max. Mx	8	-53.6739	-	-6.0950	
							2434.7645	
			Max. My	2	-53.6737	12.2456	2446.0148	
			Max. Vy	8	31.4075	-	-6.0950	
							2434.7645	
			Max. Vx	2	-31.4159	12.2456	2446.0148	
			Max. Torque	14			1.1782	
			Max Tension	1	0.0000	0.0000	0.0000	
			Max. Compression	26	-100.3662	2.2089	2.9164	
						-6.1107		
					2442.6120			
					12.2789	2453.8692		
					-	-6.1107		
					2442.6120			
					12.2789	2453.8692		
						1.1782		
					0.0000	0.0000		
					-101.4248	2.2927		
					-54.6681	-		
						-6.2197		
					2497.6215			
					-54.6680	12.5116		
					-31.5578	2497.1761		
					-31.6219	12.5116		
						2509.0138		
						1.1782		

### Maximum Reactions

Location	Condition	Gov. Load Comb.	Vertical K	Horizontal, X K	Horizontal, Z K
Pole	Max. Vert	38	101.4248	4.0114	6.9833
	Max. H <sub>x</sub>	20	54.6827	31.5324	0.1050
	Max. H <sub>z</sub>	2	54.6827	0.1152	31.5964
	Max. M <sub>x</sub>	2	2509.0138	0.1152	31.5964
	Max. M <sub>z</sub>	8	2497.6215	-31.4889	-0.0578
	Max. Torsion	14	1.1782	-0.0855	-30.4018
	Min. Vert	17	41.0120	14.4096	-25.4651
	Min. H <sub>x</sub>	8	54.6827	-31.4889	-0.0578
	Min. H <sub>z</sub>	14	54.6827	-0.0855	-30.4018
	Min. M <sub>x</sub>	14	-2475.6460	-0.0855	-30.4018
	Min. M <sub>z</sub>	20	-2497.1761	31.5324	0.1050
	Min. Torsion	22	-1.1608	26.3488	15.4882

### Tower Mast Reaction Summary

Load Combination	Vertical K	Shear <sub>x</sub> K	Shear <sub>z</sub> K	Overturing Moment, M <sub>x</sub> kip-ft	Overturing Moment, M <sub>z</sub> kip-ft	Torque kip-ft
Dead Only	45.5689	0.0000	0.0000	-0.3699	0.5017	0.0000
1.2 Dead+1.0 Wind 0 deg - No Ice	54.6827	-0.1152	-31.5964	-2509.0138	12.5117	1.1191
0.9 Dead+1.0 Wind 0 deg - No Ice	41.0120	-0.1152	-31.5964	-2487.3302	12.2475	1.1120
1.2 Dead+1.0 Wind 30 deg - No Ice	54.6827	15.7326	-27.6756	-2188.8580	-1242.5074	0.7326
0.9 Dead+1.0 Wind 30 deg - No Ice	41.0120	15.7326	-27.6756	-2169.9791	-1231.9850	0.7283
1.2 Dead+1.0 Wind 60 deg - No Ice	54.6827	28.1484	-16.4286	-1278.2044	-2190.6515	-0.2518
0.9 Dead+1.0 Wind 60 deg - No Ice	41.0120	28.1484	-16.4286	-1267.2013	-2172.0920	-0.2523

Load Combination	Vertical K	Shear <sub>x</sub> K	Shear <sub>z</sub> K	Overturning Moment, M <sub>x</sub> kip-ft	Overturning Moment, M <sub>z</sub> kip-ft	Torque kip-ft
No Ice						
1.2 Dead+1.0 Wind 90 deg - No Ice	54.6827	31.4889	0.0578	6.2198	-2497.6215	-0.9134
0.9 Dead+1.0 Wind 90 deg - No Ice	41.0120	31.4889	0.0578	6.2749	-2476.2928	-0.9099
1.2 Dead+1.0 Wind 120 deg - No Ice	54.6827	26.8136	15.8040	1258.8038	-2134.7052	-1.0654
0.9 Dead+1.0 Wind 120 deg - No Ice	41.0120	26.8136	15.8040	1248.0806	-2116.4125	-1.0589
1.2 Dead+1.0 Wind 150 deg - No Ice	54.6827	15.9578	27.9660	2185.6805	-1247.8768	-1.0914
0.9 Dead+1.0 Wind 150 deg - No Ice	41.0120	15.9578	27.9660	2167.0321	-1237.2724	-1.0835
1.2 Dead+1.0 Wind 180 deg - No Ice	54.6827	0.0855	30.4018	2475.6460	-8.3631	-1.1782
0.9 Dead+1.0 Wind 180 deg - No Ice	41.0120	0.0855	30.4018	2454.2856	-8.4232	-1.1711
1.2 Dead+1.0 Wind 210 deg - No Ice	54.6827	-14.4096	25.4651	2118.9467	1199.6437	-0.7625
0.9 Dead+1.0 Wind 210 deg - No Ice	41.0120	-14.4096	25.4651	2100.5609	1189.0016	-0.7580
1.2 Dead+1.0 Wind 240 deg - No Ice	54.6827	-27.3885	16.0028	1254.2079	2151.7677	0.2157
0.9 Dead+1.0 Wind 240 deg - No Ice	41.0120	-27.3885	16.0028	1243.5656	2133.0871	0.2163
1.2 Dead+1.0 Wind 270 deg - No Ice	54.6827	-31.5324	-0.1050	-10.8993	2497.1761	0.9088
0.9 Dead+1.0 Wind 270 deg - No Ice	41.0120	-31.5324	-0.1050	-10.6756	2475.5130	0.9052
1.2 Dead+1.0 Wind 300 deg - No Ice	54.6827	-26.3488	-15.4882	-1261.6774	2145.2989	1.1608
0.9 Dead+1.0 Wind 300 deg - No Ice	41.0120	-26.3488	-15.4882	-1250.6678	2126.6082	1.1541
1.2 Dead+1.0 Wind 330 deg - No Ice	54.6827	-15.9769	-27.9538	-2184.3745	1249.9823	1.1261
0.9 Dead+1.0 Wind 330 deg - No Ice	41.0120	-15.9769	-27.9538	-2165.5122	1239.0855	1.1181
1.2 Dead+1.0 Ice+1.0 Temp	101.4248	0.0000	-0.0000	-2.9080	2.2927	0.0001
1.2 Dead+1.0 Wind 0 deg+1.0 Ice+1.0 Temp	101.4248	-0.0230	-7.6758	-677.8709	4.9011	0.2766
1.2 Dead+1.0 Wind 30 deg+1.0 Ice+1.0 Temp	101.4248	3.8355	-6.7040	-590.0726	-333.5905	0.1615
1.2 Dead+1.0 Wind 60 deg+1.0 Ice+1.0 Temp	101.4248	6.8344	-3.9693	-344.2159	-585.9293	-0.0653
1.2 Dead+1.0 Wind 90 deg+1.0 Ice+1.0 Temp	101.4248	7.8305	0.0098	-1.7853	-676.4109	-0.2345
1.2 Dead+1.0 Wind 120 deg+1.0 Ice+1.0 Temp	101.4248	6.6797	3.9080	338.7068	-582.1259	-0.2892
1.2 Dead+1.0 Wind 150 deg+1.0 Ice+1.0 Temp	101.4248	4.0162	7.0015	590.4158	-338.5391	-0.2497
1.2 Dead+1.0 Wind 180 deg+1.0 Ice+1.0 Temp	101.4248	0.0158	7.6567	671.5006	0.5223	-0.2894
1.2 Dead+1.0 Wind 210 deg+1.0 Ice+1.0 Temp	101.4248	-3.8062	6.6718	583.8516	337.1848	-0.1646
1.2 Dead+1.0 Wind 240 deg+1.0 Ice+1.0 Temp	101.4248	-6.8310	3.9688	337.7144	590.2088	0.0620
1.2 Dead+1.0 Wind 270 deg+1.0 Ice+1.0 Temp	101.4248	-7.8514	-0.0199	-5.2055	681.6793	0.2325
1.2 Dead+1.0 Wind 300 deg+1.0 Ice+1.0 Temp	101.4248	-6.6657	-3.8902	-344.5032	587.4713	0.3067
1.2 Dead+1.0 Wind 330 deg+1.0 Ice+1.0 Temp	101.4248	-4.0114	-6.9833	-596.4528	343.6589	0.2560
Dead+Wind 0 deg - Service	45.5689	-0.0250	-6.8576	-542.0818	3.0657	0.2436
Dead+Wind 30 deg - Service	45.5689	3.4146	-6.0066	-472.9538	-267.9406	0.1577
Dead+Wind 60 deg - Service	45.5689	6.1092	-3.5656	-276.3157	-472.6938	-0.0592
Dead+Wind 90 deg - Service	45.5689	6.8343	0.0125	1.0499	-538.9611	-0.2054
Dead+Wind 120 deg - Service	45.5689	5.8196	3.4301	271.5219	-460.5776	-0.2382
Dead+Wind 150 deg -	45.5689	3.4634	6.0696	471.6833	-269.0969	-0.2411

Load Combination	Vertical K	Shear <sub>x</sub> K	Shear <sub>z</sub> K	Overturning Moment, M <sub>x</sub> kip-ft	Overturning Moment, M <sub>z</sub> kip-ft	Torque kip-ft
Service						
Dead+Wind 180 deg - Service	45.5689	0.0185	6.5984	534.2614	-1.4380	-0.2554
Dead+Wind 210 deg - Service	45.5689	-3.1275	5.5270	457.2228	259.3871	-0.1612
Dead+Wind 240 deg - Service	45.5689	-5.9443	3.4732	270.5401	465.0083	0.0532
Dead+Wind 270 deg - Service	45.5689	-6.8437	-0.0228	-2.6433	539.5942	0.2032
Dead+Wind 300 deg - Service	45.5689	-5.7187	-3.3615	-272.7291	463.6056	0.2561
Dead+Wind 330 deg - Service	45.5689	-3.4676	-6.0670	-471.9850	270.2847	0.2468

## Solution Summary

Load Comb.	Sum of Applied Forces			Sum of Reactions			% Error
	PX K	PY K	PZ K	PX K	PY K	PZ K	
1	0.0000	-45.5689	0.0000	0.0000	45.5689	0.0000	0.000%
2	-0.1152	-54.6827	-31.5964	0.1152	54.6827	31.5964	0.000%
3	-0.1152	-41.0120	-31.5964	0.1152	41.0120	31.5964	0.000%
4	15.7326	-54.6827	-27.6756	-15.7326	54.6827	27.6756	0.000%
5	15.7326	-41.0120	-27.6756	-15.7326	41.0120	27.6756	0.000%
6	28.1484	-54.6827	-16.4286	-28.1484	54.6827	16.4286	0.000%
7	28.1484	-41.0120	-16.4286	-28.1484	41.0120	16.4286	0.000%
8	31.4889	-54.6827	0.0578	-31.4889	54.6827	-0.0578	0.000%
9	31.4889	-41.0120	0.0578	-31.4889	41.0120	-0.0578	0.000%
10	26.8136	-54.6827	15.8040	-26.8136	54.6827	-15.8040	0.000%
11	26.8136	-41.0120	15.8040	-26.8136	41.0120	-15.8040	0.000%
12	15.9578	-54.6827	27.9660	-15.9578	54.6827	-27.9660	0.000%
13	15.9578	-41.0120	27.9660	-15.9578	41.0120	-27.9660	0.000%
14	0.0855	-54.6827	30.4018	-0.0855	54.6827	-30.4018	0.000%
15	0.0855	-41.0120	30.4018	-0.0855	41.0120	-30.4018	0.000%
16	-14.4096	-54.6827	25.4651	14.4096	54.6827	-25.4651	0.000%
17	-14.4096	-41.0120	25.4651	14.4096	41.0120	-25.4651	0.000%
18	-27.3885	-54.6827	16.0028	27.3885	54.6827	-16.0028	0.000%
19	-27.3885	-41.0120	16.0028	27.3885	41.0120	-16.0028	0.000%
20	-31.5324	-54.6827	-0.1050	31.5324	54.6827	0.1050	0.000%
21	-31.5324	-41.0120	-0.1050	31.5324	41.0120	0.1050	0.000%
22	-26.3488	-54.6827	-15.4882	26.3488	54.6827	15.4882	0.000%
23	-26.3488	-41.0120	-15.4882	26.3488	41.0120	15.4882	0.000%
24	-15.9769	-54.6827	-27.9538	15.9769	54.6827	27.9538	0.000%
25	-15.9769	-41.0120	-27.9538	15.9769	41.0120	27.9538	0.000%
26	0.0000	-101.4248	0.0000	-0.0000	101.4248	0.0000	0.000%
27	-0.0230	-101.4248	-7.6758	0.0230	101.4248	7.6758	0.000%
28	3.8355	-101.4248	-6.7039	-3.8355	101.4248	6.7040	0.000%
29	6.8344	-101.4248	-3.9693	-6.8344	101.4248	3.9693	0.000%
30	7.8305	-101.4248	0.0098	-7.8305	101.4248	-0.0098	0.000%
31	6.6797	-101.4248	3.9080	-6.6797	101.4248	-3.9080	0.000%
32	4.0162	-101.4248	7.0015	-4.0162	101.4248	-7.0015	0.000%
33	0.0158	-101.4248	7.6566	-0.0158	101.4248	-7.6567	0.000%
34	-3.8062	-101.4248	6.6718	3.8062	101.4248	-6.6718	0.000%
35	-6.8310	-101.4248	3.9688	6.8310	101.4248	-3.9688	0.000%
36	-7.8514	-101.4248	-0.0199	7.8514	101.4248	0.0199	0.000%
37	-6.6657	-101.4248	-3.8902	6.6657	101.4248	3.8902	0.000%
38	-4.0114	-101.4248	-6.9833	4.0114	101.4248	6.9833	0.000%
39	-0.0250	-45.5689	-6.8576	0.0250	45.5689	6.8576	0.000%
40	3.4146	-45.5689	-6.0066	-3.4146	45.5689	6.0066	0.000%
41	6.1092	-45.5689	-3.5656	-6.1092	45.5689	3.5656	0.000%
42	6.8343	-45.5689	0.0125	-6.8343	45.5689	-0.0125	0.000%
43	5.8196	-45.5689	3.4301	-5.8196	45.5689	-3.4301	0.000%
44	3.4634	-45.5689	6.0696	-3.4634	45.5689	-6.0696	0.000%
45	0.0185	-45.5689	6.5984	-0.0185	45.5689	-6.5984	0.000%
46	-3.1275	-45.5689	5.5270	3.1275	45.5689	-5.5270	0.000%
47	-5.9443	-45.5689	3.4732	5.9443	45.5689	-3.4732	0.000%

Load Comb.	Sum of Applied Forces			Sum of Reactions			% Error
	PX K	PY K	PZ K	PX K	PY K	PZ K	
48	-6.8437	-45.5689	-0.0228	6.8437	45.5689	0.0228	0.000%
49	-5.7187	-45.5689	-3.3615	5.7187	45.5689	3.3615	0.000%
50	-3.4676	-45.5689	-6.0670	3.4676	45.5689	6.0670	0.000%

**Non-Linear Convergence Results**

Load Combination	Converged?	Number of Cycles	Displacement Tolerance	Force Tolerance
1	Yes	4	0.0000001	0.0000001
2	Yes	5	0.0000001	0.00018663
3	Yes	5	0.0000001	0.00008759
4	Yes	6	0.0000001	0.00015401
5	Yes	6	0.0000001	0.00005300
6	Yes	6	0.0000001	0.00015256
7	Yes	6	0.0000001	0.00005230
8	Yes	5	0.0000001	0.00014620
9	Yes	5	0.0000001	0.00006649
10	Yes	6	0.0000001	0.00014602
11	Yes	6	0.0000001	0.00005018
12	Yes	6	0.0000001	0.00015745
13	Yes	6	0.0000001	0.00005422
14	Yes	5	0.0000001	0.00026553
15	Yes	5	0.0000001	0.00012689
16	Yes	6	0.0000001	0.00014377
17	Yes	6	0.0000001	0.00004967
18	Yes	6	0.0000001	0.00015001
19	Yes	6	0.0000001	0.00005166
20	Yes	5	0.0000001	0.00019797
21	Yes	5	0.0000001	0.00009251
22	Yes	6	0.0000001	0.00015739
23	Yes	6	0.0000001	0.00005428
24	Yes	6	0.0000001	0.00014610
25	Yes	6	0.0000001	0.00005002
26	Yes	4	0.0000001	0.00024456
27	Yes	6	0.0000001	0.00055471
28	Yes	6	0.0000001	0.00060688
29	Yes	6	0.0000001	0.00060691
30	Yes	6	0.0000001	0.00055128
31	Yes	6	0.0000001	0.00059804
32	Yes	6	0.0000001	0.00060064
33	Yes	6	0.0000001	0.00054387
34	Yes	6	0.0000001	0.00059291
35	Yes	6	0.0000001	0.00059501
36	Yes	6	0.0000001	0.00054889
37	Yes	6	0.0000001	0.00060666
38	Yes	6	0.0000001	0.00060842
39	Yes	4	0.0000001	0.00040954
40	Yes	5	0.0000001	0.00004532
41	Yes	5	0.0000001	0.00004335
42	Yes	4	0.0000001	0.00037870
43	Yes	4	0.0000001	0.00099213
44	Yes	5	0.0000001	0.00004746
45	Yes	4	0.0000001	0.00042333
46	Yes	4	0.0000001	0.00097325
47	Yes	5	0.0000001	0.00004189
48	Yes	4	0.0000001	0.00038418
49	Yes	5	0.0000001	0.00004712
50	Yes	4	0.0000001	0.00099784

**Maximum Tower Deflections - Service Wind**

Section No.	Elevation ft	Horz. Deflection in	Gov. Load Comb.	Tilt °	Twist °
L1	118 - 113	12.0334	41	0.8946	0.0019
L2	113 - 108	11.0969	41	0.8942	0.0019
L3	108 - 103	10.1626	41	0.8899	0.0018
L4	103 - 98	9.2359	41	0.8786	0.0017
L5	98 - 93	8.3261	41	0.8574	0.0017
L6	93 - 90	7.4448	41	0.8234	0.0015
L7	90 - 85	6.9360	41	0.7956	0.0014
L8	85 - 80	6.1233	41	0.7554	0.0013
L9	80 - 76.5	5.3596	41	0.7014	0.0011
L10	76.5 - 76.25	4.8624	41	0.6543	0.0010
L11	76.25 - 74	4.8282	41	0.6519	0.0009
L12	74 - 73.75	4.5263	41	0.6293	0.0009
L13	73.75 - 68.88	4.4933	41	0.6275	0.0009
L14	68.88 - 68.63	3.8723	41	0.5891	0.0008
L15	68.63 - 64.5	3.8415	41	0.5858	0.0008
L16	64.5 - 64.25	3.3593	41	0.5281	0.0006
L17	64.25 - 63	3.3317	41	0.5259	0.0006
L18	63 - 62.75	3.1954	41	0.5147	0.0006
L19	62.75 - 60	3.1686	41	0.5124	0.0006
L20	60 - 59.75	2.8812	41	0.4850	0.0006
L21	59.75 - 54.75	2.8559	41	0.4831	0.0005
L22	54.75 - 49.75	2.3707	41	0.4426	0.0005
L23	49.75 - 49.25	1.9309	41	0.3963	0.0004
L24	49.25 - 49	1.8897	41	0.3913	0.0004
L25	49 - 44	1.8693	41	0.3894	0.0004
L26	44 - 42	1.4831	41	0.3474	0.0003
L27	42 - 41.75	1.3413	41	0.3293	0.0003
L28	41.75 - 36.75	1.3241	41	0.3273	0.0003
L29	36.75 - 34.5	1.0037	41	0.2839	0.0002
L30	34.5 - 34.25	0.8748	41	0.2630	0.0002
L31	34.25 - 34	0.8611	41	0.2607	0.0002
L32	34 - 33.75	0.8475	41	0.2584	0.0002
L33	33.75 - 30	0.8341	41	0.2559	0.0002
L34	30 - 29.75	0.6483	41	0.2167	0.0002
L35	29.75 - 28.5	0.6370	41	0.2146	0.0002
L36	28.5 - 28.25	0.5822	41	0.2042	0.0002
L37	28.25 - 23.25	0.5716	41	0.2024	0.0002
L38	23.25 - 23	0.3788	41	0.1652	0.0001
L39	23 - 21.5	0.3702	41	0.1635	0.0001
L40	21.5 - 21.25	0.3205	41	0.1532	0.0001
L41	21.25 - 19	0.3125	41	0.1512	0.0001
L42	19 - 18.75	0.2457	41	0.1325	0.0001
L43	18.75 - 18.5	0.2388	41	0.1307	0.0001
L44	18.5 - 18.25	0.2320	41	0.1289	0.0001
L45	18.25 - 13.25	0.2253	41	0.1270	0.0001
L46	13.25 - 12.7	0.1129	41	0.0871	0.0001
L47	12.7 - 12.45	0.1031	41	0.0825	0.0001
L48	12.45 - 11.5	0.0989	41	0.0804	0.0001
L49	11.5 - 11.25	0.0837	41	0.0722	0.0000
L50	11.25 - 10.5	0.0800	41	0.0700	0.0000
L51	10.5 - 10.25	0.0695	41	0.0634	0.0000
L52	10.25 - 7.5	0.0662	41	0.0619	0.0000
L53	7.5 - 7.25	0.0356	41	0.0444	0.0000
L54	7.25 - 6.25	0.0333	41	0.0428	0.0000
L55	6.25 - 6	0.0250	41	0.0366	0.0000
L56	6 - 3.73	0.0231	41	0.0350	0.0000
L57	3.73 - 3.48	0.0094	41	0.0229	0.0000
L58	3.48 - 2.75	0.0082	41	0.0215	0.0000
L59	2.75 - 2.5	0.0052	41	0.0175	0.0000
L60	2.5 - 2	0.0043	41	0.0161	0.0000
L61	2 - 1.75	0.0028	41	0.0133	0.0000
L62	1.75 - 0	0.0021	41	0.0116	0.0000

**Critical Deflections and Radius of Curvature - Service Wind**



Elevation ft	Appurtenance	Gov. Load Comb.	Deflection in	Tilt °	Twist °	Radius of Curvature ft
116.0000	VHLP1-23	41	11.6588	0.8947	0.0020	130476
114.0000	APXVSP18-C-A20 w/ Mount Pipe	41	11.2842	0.8945	0.0020	130476
108.0000	AIR6449 B41_T-MOBILE w/ Mount Pipe	41	10.1626	0.8899	0.0019	38482
98.0000	HPA-65R-BUU-H6 w/ Mount Pipe	41	8.3261	0.8574	0.0017	10432
90.0000	Bridge Stiffener (84" x 9" x 1.25")	41	6.9360	0.7956	0.0014	6757
85.0000	(2) HBXX-6517DS-A2M w/ Mount Pipe	41	6.1233	0.7554	0.0013	6091
80.0000	KS24019-L112A	41	5.3596	0.7014	0.0011	4725
73.0000	VHLP1-23	41	4.3952	0.6226	0.0009	6537
72.0000	A-ANT-18G-2-C	41	4.2657	0.6164	0.0009	6607
62.0000	MX08FRO665-21 w/ Mount Pipe	41	3.0886	0.5047	0.0006	5773
60.0000	Bridge Stiffener (84" x 14.5" x 1.25")	41	2.8812	0.4850	0.0006	6441
30.0000	Bridge Stiffener (84" x 14.5" x 1.25")	41	0.6483	0.2167	0.0002	6278

### Maximum Tower Deflections - Design Wind

Section No.	Elevation ft	Horz. Deflection in	Gov. Load Comb.	Tilt °	Twist °
L1	118 - 113	55.7488	12	4.1532	0.0089
L2	113 - 108	51.4066	12	4.1512	0.0088
L3	108 - 103	47.0743	12	4.1320	0.0086
L4	103 - 98	42.7772	12	4.0798	0.0083
L5	98 - 93	38.5636	6	3.9810	0.0081
L6	93 - 90	34.4851	6	3.8226	0.0072
L7	90 - 85	32.1302	6	3.6928	0.0066
L8	85 - 80	28.3681	6	3.5055	0.0060
L9	80 - 76.5	24.8324	6	3.2542	0.0051
L10	76.5 - 76.25	22.5301	6	3.0363	0.0045
L11	76.25 - 74	22.3717	6	3.0252	0.0044
L12	74 - 73.75	20.9733	6	2.9201	0.0041
L13	73.75 - 68.88	20.8209	6	2.9118	0.0041
L14	68.88 - 68.63	17.9444	6	2.7327	0.0037
L15	68.63 - 64.5	17.8020	6	2.7176	0.0036
L16	64.5 - 64.25	15.5677	6	2.4483	0.0030
L17	64.25 - 63	15.4398	6	2.4382	0.0030
L18	63 - 62.75	14.8087	6	2.3862	0.0028
L19	62.75 - 60	14.6841	6	2.3751	0.0028
L20	60 - 59.75	13.3529	6	2.2481	0.0025
L21	59.75 - 54.75	13.2354	6	2.2394	0.0025
L22	54.75 - 49.75	10.9870	6	2.0520	0.0022
L23	49.75 - 49.25	8.9490	6	1.8371	0.0018
L24	49.25 - 49	8.7579	6	1.8141	0.0018
L25	49 - 44	8.6632	6	1.8050	0.0018
L26	44 - 42	6.8733	6	1.6107	0.0015
L27	42 - 41.75	6.2162	6	1.5267	0.0014
L28	41.75 - 36.75	6.1365	6	1.5172	0.0014
L29	36.75 - 34.5	4.6516	6	1.3161	0.0011
L30	34.5 - 34.25	4.0542	6	1.2189	0.0010
L31	34.25 - 34	3.9907	6	1.2083	0.0010
L32	34 - 33.75	3.9277	6	1.1977	0.0010
L33	33.75 - 30	3.8653	6	1.1860	0.0010
L34	30 - 29.75	3.0045	6	1.0042	0.0008
L35	29.75 - 28.5	2.9522	6	0.9947	0.0008
L36	28.5 - 28.25	2.6981	6	0.9465	0.0007
L37	28.25 - 23.25	2.6487	6	0.9383	0.0007
L38	23.25 - 23	1.7554	6	0.7655	0.0005
L39	23 - 21.5	1.7156	6	0.7577	0.0005
L40	21.5 - 21.25	1.4850	6	0.7099	0.0005
L41	21.25 - 19	1.4481	6	0.7005	0.0005

Section No.	Elevation ft	Horz. Deflection in	Gov. Load Comb.	Tilt °	Twist °
L42	19 - 18.75	1.1382	6	0.6141	0.0004
L43	18.75 - 18.5	1.1063	6	0.6057	0.0004
L44	18.5 - 18.25	1.0748	6	0.5973	0.0004
L45	18.25 - 13.25	1.0438	6	0.5884	0.0004
L46	13.25 - 12.7	0.5232	6	0.4036	0.0003
L47	12.7 - 12.45	0.4779	6	0.3824	0.0002
L48	12.45 - 11.5	0.4581	6	0.3725	0.0002
L49	11.5 - 11.25	0.3878	6	0.3344	0.0002
L50	11.25 - 10.5	0.3705	6	0.3243	0.0002
L51	10.5 - 10.25	0.3220	6	0.2938	0.0002
L52	10.25 - 7.5	0.3068	6	0.2866	0.0002
L53	7.5 - 7.25	0.1649	6	0.2055	0.0001
L54	7.25 - 6.25	0.1543	6	0.1983	0.0001
L55	6.25 - 6	0.1158	6	0.1694	0.0001
L56	6 - 3.73	0.1071	6	0.1621	0.0001
L57	3.73 - 3.48	0.0434	6	0.1060	0.0001
L58	3.48 - 2.75	0.0380	6	0.0997	0.0001
L59	2.75 - 2.5	0.0241	6	0.0812	0.0000
L60	2.5 - 2	0.0201	6	0.0746	0.0000
L61	2 - 1.75	0.0129	6	0.0615	0.0000
L62	1.75 - 0	0.0099	6	0.0539	0.0000

### Critical Deflections and Radius of Curvature - Design Wind

Elevation ft	Appurtenance	Gov. Load Comb.	Deflection in	Tilt °	Twist °	Radius of Curvature ft
116.0000	VHLP1-23	12	54.0115	4.1534	0.0090	30176
114.0000	APXVSP18-C-A20 w/ Mount Pipe	12	52.2747	4.1524	0.0089	30176
108.0000	AIR6449 B41_T-MOBILE w/ Mount Pipe	12	47.0743	4.1320	0.0086	8573
98.0000	HPA-65R-BUU-H6 w/ Mount Pipe	6	38.5636	3.9810	0.0081	2284
90.0000	Bridge Stiffener (84" x 9" x 1.25")	6	32.1302	3.6928	0.0066	1474
85.0000	(2) HBXX-6517DS-A2M w/ Mount Pipe	6	28.3681	3.5055	0.0060	1325
80.0000	KS24019-L112A	6	24.8324	3.2542	0.0051	1024
73.0000	VHLP1-23	6	20.3664	2.8889	0.0041	1417
72.0000	A-ANT-18G-2-C	6	19.7665	2.8597	0.0040	1432
62.0000	MX08FRO665-21 w/ Mount Pipe	6	14.3139	2.3394	0.0027	1248
60.0000	Bridge Stiffener (84" x 14.5" x 1.25")	6	13.3529	2.2481	0.0025	1392
30.0000	Bridge Stiffener (84" x 14.5" x 1.25")	6	3.0045	1.0042	0.0008	1355

### Compression Checks

### Pole Design Data

Section No.	Elevation ft	Size	L ft	L <sub>u</sub> ft	Kl/r	A in <sup>2</sup>	P <sub>u</sub> K	φP <sub>n</sub> K	Ratio $\frac{P_u}{\phi P_n}$
L1	118 - 113 (1)	P24x0.25	5.0000	0.0000	0.0	18.653	-3.0550	662.2650	0.005
L2	113 - 108 (2)	P24x0.25	5.0000	0.0000	0.0	18.653	-3.4417	662.2650	0.005
L3	108 - 103 (3)	P24x0.25	5.0000	0.0000	0.0	18.653	-8.0984	662.2650	0.012

Section No.	Elevation ft	Size	L ft	L <sub>u</sub> ft	Kl/r	A in <sup>2</sup>	P <sub>u</sub> K	φP <sub>n</sub> K	Ratio P <sub>u</sub> / φP <sub>n</sub>
L4	103 - 98 (4)	P24x0.25	5.0000	0.0000	0.0	18.653 <sup>2</sup>	-8.5439	662.2650	0.013
L5	98 - 93 (5)	P24x0.25	5.0000	0.0000	0.0	18.653 <sup>2</sup>	-11.6936	662.2650	0.018
L6	93 - 90 (6)	P24x0.25	3.0000	0.0000	0.0	18.653 <sup>2</sup>	-12.0119	662.2650	0.018
L7	90 - 85 (7)	P24x0.375	5.0000	0.0000	0.0	27.832 <sup>2</sup>	-13.6784	1052.0700	0.013
L8	85 - 80 (8)	P24x0.375	5.0000	0.0000	0.0	27.832 <sup>5</sup>	-17.1794	1052.0700	0.016
L9	80 - 76.5 (9)	P24x0.375	3.5000	0.0000	0.0	27.832 <sup>5</sup>	-17.8491	1052.0700	0.017
L10	76.5 - 76.25 (10)	P24x0.5875	0.2500	0.0000	0.0	43.212 <sup>1</sup>	-17.9151	1633.4200	0.011
L11	76.25 - 74 (11)	P24x0.5875	2.2500	0.0000	0.0	43.212 <sup>1</sup>	-18.4013	1633.4200	0.011
L12	74 - 73.75 (12)	P24x0.9	0.2500	0.0000	0.0	65.313 <sup>7</sup>	-18.4832	2468.8600	0.007
L13	73.75 - 68.88 (13)	P24x0.9	4.8700	0.0000	0.0	65.313 <sup>7</sup>	-20.5970	2468.8600	0.008
L14	68.88 - 68.63 (14)	P24x0.575	0.2500	0.0000	0.0	42.315 <sup>3</sup>	-20.6611	1599.5200	0.013
L15	68.63 - 64.5 (15)	P24x0.575	4.1300	0.0000	0.0	42.315 <sup>3</sup>	-21.6090	1599.5200	0.014
L16	64.5 - 64.25 (16)	P24x1.05	0.2500	0.0000	0.0	75.704 <sup>5</sup>	-21.7062	2861.6300	0.008
L17	64.25 - 63 (17)	P24x1.05	1.2500	0.0000	0.0	75.704 <sup>5</sup>	-22.1266	2861.6300	0.008
L18	63 - 62.75 (18)	P24x1	0.2500	0.0000	0.0	72.256 <sup>6</sup>	-22.2182	2731.3000	0.008
L19	62.75 - 60 (19)	P24x1	2.7500	0.0000	0.0	72.256 <sup>6</sup>	-25.9752	2731.3000	0.010
L20	60 - 59.75 (20)	P30x0.675	0.2500	0.0000	0.0	62.185 <sup>9</sup>	-27.5997	2350.6300	0.012
L21	59.75 - 54.75 (21)	P30x0.675	5.0000	0.0000	0.0	62.185 <sup>9</sup>	-29.2228	2350.6300	0.012
L22	54.75 - 49.75 (22)	P30x0.675	5.0000	0.0000	0.0	62.185 <sup>9</sup>	-30.8668	2350.6300	0.013
L23	49.75 - 49.25 (23)	P30x0.675	0.5000	0.0000	0.0	62.185 <sup>9</sup>	-31.0372	2350.6300	0.013
L24	49.25 - 49 (24)	P30x0.875	0.2500	0.0000	0.0	80.061 <sup>5</sup>	-31.1281	3026.3300	0.010
L25	49 - 44 (25)	P30x0.875	5.0000	0.0000	0.0	80.061 <sup>5</sup>	-32.8817	3026.3300	0.011
L26	44 - 42 (26)	P30x0.875	2.0000	0.0000	0.0	80.061 <sup>5</sup>	-33.5893	3026.3300	0.011
L27	42 - 41.75 (27)	P30x1	0.2500	0.0000	0.0	91.106 <sup>2</sup>	-33.6942	3443.8100	0.010
L28	41.75 - 36.75 (28)	P30x1	5.0000	0.0000	0.0	91.106 <sup>2</sup>	-35.6381	3443.8100	0.010
L29	36.75 - 34.5 (29)	P30x1	2.2500	0.0000	0.0	91.106 <sup>2</sup>	-36.5145	3443.8100	0.011
L30	34.5 - 34.25 (30)	P30x1.05	0.2500	0.0000	0.0	95.496 <sup>6</sup>	-36.6304	3609.7700	0.010
L31	34.25 - 34 (31)	P30x1.05	0.2500	0.0000	0.0	95.496 <sup>6</sup>	-36.7371	3609.7700	0.010
L32	34 - 33.75 (32)	P30x0.95	0.2500	0.0000	0.0	86.700 <sup>1</sup>	-36.8349	3277.2600	0.011
L33	33.75 - 30 (33)	P30x0.95	3.7500	0.0000	0.0	86.700 <sup>1</sup>	-38.2848	3277.2600	0.012
L34	30 - 29.75 (34)	P36x0.7	0.2500	0.0000	0.0	77.628 <sup>8</sup>	-39.9379	2934.3700	0.014
L35	29.75 - 28.5 (35)	P36x0.7	1.2500	0.0000	0.0	77.628 <sup>8</sup>	-40.4189	2934.3700	0.014
L36	28.5 - 28.25 (36)	P36x0.8375	0.2500	0.0000	0.0	92.515 <sup>5</sup>	-40.5403	3497.0900	0.012
L37	28.25 - 23.25 (37)	P36x0.8375	5.0000	0.0000	0.0	92.515 <sup>5</sup>	-42.7647	3497.0900	0.012

Section No.	Elevation ft	Size	L ft	L <sub>u</sub> ft	KI/r	A in <sup>2</sup>	P <sub>u</sub> K	φP <sub>n</sub> K	Ratio P <sub>u</sub> φP <sub>n</sub>
L38	23.25 - 23 (38)	P36x0.975	0.2500	0.0000	0.0	107.28 30	-42.8955	4055.3100	0.011
L39	23 - 21.5 (39)	P36x0.975	1.5000	0.0000	0.0	107.28 30	-43.6267	4055.3100	0.011
L40	21.5 - 21.25 (40)	P36x0.825	0.2500	0.0000	0.0	91.167 1	-43.7474	3446.1100	0.013
L41	21.25 - 19 (41)	P36x0.825	2.2500	0.0000	0.0	91.167 1	-44.7354	3446.1100	0.013
L42	19 - 18.75 (42)	P36x0.975	0.2500	0.0000	0.0	107.28 30	-44.8687	4055.3100	0.011
L43	18.75 - 18.5 (43)	P36x0.975	0.2500	0.0000	0.0	107.28 30	-44.9926	4055.3100	0.011
L44	18.5 - 18.25 (44)	P36x0.925	0.2500	0.0000	0.0	101.92 70	-45.1080	3852.8400	0.012
L45	18.25 - 13.25 (45)	P36x0.925	5.0000	0.0000	0.0	101.92 70	-47.4172	3852.8400	0.012
L46	13.25 - 12.7 (46)	P36x0.925	0.5500	0.0000	0.0	101.92 70	-47.6774	3852.8400	0.012
L47	12.7 - 12.45 (47)	P36x0.9	0.2500	0.0000	0.0	99.242 9	-47.7974	3751.3800	0.013
L48	12.45 - 11.5 (48)	P36x0.9	0.9500	0.0000	0.0	99.242 9	-48.2342	3751.3800	0.013
L49	11.5 - 11.25 (49)	P36x0.9	0.2500	0.0000	0.0	99.242 9	-48.3678	3751.3800	0.013
L50	11.25 - 10.5 (50)	P36x0.9	0.7500	0.0000	0.0	99.242 9	-48.7404	3751.3800	0.013
L51	10.5 - 10.25 (51)	P36x1.325	0.2500	0.0000	0.0	144.33 90	-48.8865	5456.0000	0.009
L52	10.25 - 7.5 (52)	P36x1.325	2.7500	0.0000	0.0	144.33 90	-50.4161	5456.0000	0.009
L53	7.5 - 7.25 (53)	P36x1.4	0.2500	0.0000	0.0	152.17 90	-50.5703	5752.3600	0.009
L54	7.25 - 6.25 (54)	P36x1.4	1.0000	0.0000	0.0	152.17 90	-51.1435	5752.3600	0.009
L55	6.25 - 6 (55)	P36x1.4	0.2500	0.0000	0.0	152.17 90	-51.2945	5752.3600	0.009
L56	6 - 3.73 (56)	P36x1.725	2.2700	0.0000	0.0	185.74 50	-52.6588	7021.1500	0.008
L57	3.73 - 3.48 (57)	P36x1.725	0.2500	0.0000	0.0	185.74 50	-52.8161	7021.1500	0.008
L58	3.48 - 2.75 (58)	P36x1.725	0.7300	0.0000	0.0	185.74 50	-53.2537	7021.1500	0.008
L59	2.75 - 2.5 (59)	P36x1.675	0.2500	0.0000	0.0	180.62 40	-53.3960	6827.5800	0.008
L60	2.5 - 2 (60)	P36x1.675	0.5000	0.0000	0.0	180.62 40	-53.6721	6827.5800	0.008
L61	2 - 1.75 (61)	P36x1.425	0.2500	0.0000	0.0	154.78 40	-53.7994	5850.8500	0.009
L62	1.75 - 0 (62)	P36x1.425	1.7500	0.0000	0.0	154.78 40	-54.6673	5850.8500	0.009

### Pole Bending Design Data

Section No.	Elevation ft	Size	M <sub>ux</sub> kip-ft	φM <sub>nx</sub> kip-ft	Ratio M <sub>ux</sub> φM <sub>nx</sub>	M <sub>uy</sub> kip-ft	φM <sub>ny</sub> kip-ft	Ratio M <sub>uy</sub> φM <sub>ny</sub>
L1	118 - 113 (1)	P24x0.25	8.4796	396.6833	0.021	0.0000	396.6833	0.000
L2	113 - 108 (2)	P24x0.25	27.5128	396.6833	0.069	0.0000	396.6833	0.000
L3	108 - 103 (3)	P24x0.25	69.7385	396.6833	0.176	0.0000	396.6833	0.000
L4	103 - 98 (4)	P24x0.25	113.5650	396.6833	0.286	0.0000	396.6833	0.000
L5	98 - 93 (5)	P24x0.25	180.3408	396.6833	0.455	0.0000	396.6833	0.000
L6	93 - 90 (6)	P24x0.25	221.0433	396.6833	0.557	0.0000	396.6833	0.000
L7	90 - 85 (7)	P24x0.375	291.8375	623.7167	0.468	0.0000	623.7167	0.000
L8	85 - 80 (8)	P24x0.375	391.6800	623.7167	0.628	0.0000	623.7167	0.000
L9	80 - 76.5 (9)	P24x0.375	460.2833	623.7167	0.738	0.0000	623.7167	0.000

Section No.	Elevation ft	Size	$M_{ux}$	$\phi M_{nx}$	Ratio	$M_{uy}$	$\phi M_{ny}$	Ratio
			kip-ft	kip-ft	$\frac{M_{ux}}{\phi M_{nx}}$	kip-ft	kip-ft	$\frac{M_{uy}}{\phi M_{ny}}$
L10	76.5 - 76.25 (10)	P24x0.5875	465.1908	1014.6250	0.458	0.0000	1014.6250	0.000
L11	76.25 - 74 (11)	P24x0.5875	509.5075	1014.6250	0.502	0.0000	1014.6250	0.000
L12	74 - 73.75 (12)	P24x0.9	514.4475	1513.5500	0.340	0.0000	1513.5500	0.000
L13	73.75 - 68.88 (13)	P24x0.9	615.6608	1513.5500	0.407	0.0000	1513.5500	0.000
L14	68.88 - 68.63 (14)	P24x0.575	620.9850	994.0917	0.625	0.0000	994.0917	0.000
L15	68.63 - 64.5 (15)	P24x0.575	710.4625	994.0917	0.715	0.0000	994.0917	0.000
L16	64.5 - 64.25 (16)	P24x1.05	715.9392	1743.2833	0.411	0.0000	1743.2833	0.000
L17	64.25 - 63 (17)	P24x1.05	743.4592	1743.2833	0.426	0.0000	1743.2833	0.000
L18	63 - 62.75 (18)	P24x1	748.9908	1667.4000	0.449	0.0000	1667.4000	0.000
L19	62.75 - 60 (19)	P24x1	815.4233	1667.4000	0.489	0.0000	1667.4000	0.000
L20	60 - 59.75 (20)	P30x0.675	821.8142	1828.8000	0.449	0.0000	1828.8000	0.000
L21	59.75 - 54.75 (21)	P30x0.675	950.5083	1828.8000	0.520	0.0000	1828.8000	0.000
L22	54.75 - 49.75 (22)	P30x0.675	1080.7833	1828.8000	0.591	0.0000	1828.8000	0.000
L23	49.75 - 49.25 (23)	P30x0.675	1093.8917	1828.8000	0.598	0.0000	1828.8000	0.000
L24	49.25 - 49 (24)	P30x0.875	1100.4500	2338.7333	0.471	0.0000	2338.7333	0.000
L25	49 - 44 (25)	P30x0.875	1232.4917	2338.7333	0.527	0.0000	2338.7333	0.000
L26	44 - 42 (26)	P30x0.875	1285.7333	2338.7333	0.550	0.0000	2338.7333	0.000
L27	42 - 41.75 (27)	P30x1	1292.4083	2650.2000	0.488	0.0000	2650.2000	0.000
L28	41.75 - 36.75 (28)	P30x1	1426.6000	2650.2000	0.538	0.0000	2650.2000	0.000
L29	36.75 - 34.5 (29)	P30x1	1487.6500	2650.2000	0.561	0.0000	2650.2000	0.000
L30	34.5 - 34.25 (30)	P30x1.05	1494.4750	2773.2417	0.539	0.0000	2773.2417	0.000
L31	34.25 - 34 (31)	P30x1.05	1501.3083	2773.2417	0.541	0.0000	2773.2417	0.000
L32	34 - 33.75 (32)	P30x0.95	1508.1500	2526.2750	0.597	0.0000	2526.2750	0.000
L33	33.75 - 30 (33)	P30x0.95	1613.5167	2526.2750	0.639	0.0000	2526.2750	0.000
L34	30 - 29.75 (34)	P36x0.7	1620.7333	2705.1667	0.599	0.0000	2705.1667	0.000
L35	29.75 - 28.5 (35)	P36x0.7	1656.9500	2705.1667	0.613	0.0000	2705.1667	0.000
L36	28.5 - 28.25 (36)	P36x0.8375	1664.2167	3262.4000	0.510	0.0000	3262.4000	0.000
L37	28.25 - 23.25 (37)	P36x0.8375	1811.1833	3262.4000	0.555	0.0000	3262.4000	0.000
L38	23.25 - 23 (38)	P36x0.975	1818.6167	3768.6333	0.483	0.0000	3768.6333	0.000
L39	23 - 21.5 (39)	P36x0.975	1863.3583	3768.6333	0.494	0.0000	3768.6333	0.000
L40	21.5 - 21.25 (40)	P36x0.825	1870.8417	3215.9750	0.582	0.0000	3215.9750	0.000
L41	21.25 - 19 (41)	P36x0.825	1938.5167	3215.9750	0.603	0.0000	3215.9750	0.000
L42	19 - 18.75 (42)	P36x0.975	1946.0750	3768.6333	0.516	0.0000	3768.6333	0.000
L43	18.75 - 18.5 (43)	P36x0.975	1953.6417	3768.6333	0.518	0.0000	3768.6333	0.000
L44	18.5 - 18.25 (44)	P36x0.925	1961.2167	3585.4917	0.547	0.0000	3585.4917	0.000
L45	18.25 - 13.25 (45)	P36x0.925	2114.4750	3585.4917	0.590	0.0000	3585.4917	0.000

Section No.	Elevation ft	Size	$M_{ux}$	$\phi M_{nx}$	Ratio	$M_{uy}$	$\phi M_{ny}$	Ratio
			kip-ft	kip-ft	$\frac{M_{ux}}{\phi M_{nx}}$	kip-ft	kip-ft	$\frac{M_{uy}}{\phi M_{ny}}$
L46	13.25 - 12.7 (46)	P36x0.925	2131.5333	3585.4917	0.594	0.0000	3585.4917	0.000
L47	12.7 - 12.45 (47)	P36x0.9	2139.3000	3493.5167	0.612	0.0000	3493.5167	0.000
L48	12.45 - 11.5 (48)	P36x0.9	2168.8917	3493.5167	0.621	0.0000	3493.5167	0.000
L49	11.5 - 11.25 (49)	P36x0.9	2176.6917	3493.5167	0.623	0.0000	3493.5167	0.000
L50	11.25 - 10.5 (50)	P36x0.9	2200.1583	3493.5167	0.630	0.0000	3493.5167	0.000
L51	10.5 - 10.25 (51)	P36x1.325	2207.9917	5020.7750	0.440	0.0000	5020.7750	0.000
L52	10.25 - 7.5 (52)	P36x1.325	2294.7333	5020.7750	0.457	0.0000	5020.7750	0.000
L53	7.5 - 7.25 (53)	P36x1.4	2302.6667	5282.3583	0.436	0.0000	5282.3583	0.000
L54	7.25 - 6.25 (54)	P36x1.4	2334.4917	5282.3583	0.442	0.0000	5282.3583	0.000
L55	6.25 - 6 (55)	P36x1.4	2342.4667	5282.3583	0.443	0.0000	5282.3583	0.000
L56	6 - 3.73 (56)	P36x1.725	2415.2833	6388.8247	0.378	0.0000	6388.8247	0.000
L57	3.73 - 3.48 (57)	P36x1.725	2423.3417	6388.8247	0.379	0.0000	6388.8247	0.000
L58	3.48 - 2.75 (58)	P36x1.725	2446.9333	6388.8247	0.383	0.0000	6388.8247	0.000
L59	2.75 - 2.5 (59)	P36x1.675	2455.0250	6221.4413	0.395	0.0000	6221.4413	0.000
L60	2.5 - 2 (60)	P36x1.675	2471.2417	6221.4413	0.397	0.0000	6221.4413	0.000
L61	2 - 1.75 (61)	P36x1.425	2479.3583	5369.0250	0.462	0.0000	5369.0250	0.000
L62	1.75 - 0 (62)	P36x1.425	2536.2917	5369.0250	0.472	0.0000	5369.0250	0.000

### Pole Shear Design Data

Section No.	Elevation ft	Size	Actual	$\phi V_n$	Ratio	Actual	$\phi T_n$	Ratio
			$V_u$ K	K	$\frac{V_u}{\phi V_n}$	$T_u$ kip-ft	kip-ft	$\frac{T_u}{\phi T_n}$
L1	118 - 113 (1)	P24x0.25	3.6409	201.8610	0.018	0.0011	324.2292	0.000
L2	113 - 108 (2)	P24x0.25	3.9725	201.8610	0.020	0.0011	324.2292	0.000
L3	108 - 103 (3)	P24x0.25	8.6083	201.8610	0.043	0.0011	324.2292	0.000
L4	103 - 98 (4)	P24x0.25	8.9237	201.8610	0.044	0.0011	324.2292	0.000
L5	98 - 93 (5)	P24x0.25	13.4870	201.8610	0.067	0.4239	324.2292	0.001
L6	93 - 90 (6)	P24x0.25	13.6556	201.8610	0.068	0.4238	324.2292	0.001
L7	90 - 85 (7)	P24x0.375	14.3065	315.6210	0.045	0.4237	655.5675	0.001
L8	85 - 80 (8)	P24x0.375	19.4009	315.6210	0.061	0.8284	655.5675	0.001
L9	80 - 76.5 (9)	P24x0.375	19.6234	315.6210	0.062	0.9424	655.5675	0.001
L10	76.5 - 76.25 (10)	P24x0.5875	19.6275	490.0250	0.040	0.9423	1008.6667	0.001
L11	76.25 - 74 (11)	P24x0.5875	19.7501	490.0250	0.040	0.9422	1008.6667	0.001
L12	74 - 73.75 (12)	P24x0.9	19.7590	740.6580	0.027	0.9421	1504.2083	0.001
L13	73.75 - 68.88 (13)	P24x0.9	21.2875	740.6580	0.029	1.1797	1504.2083	0.001
L14	68.88 - 68.63 (14)	P24x0.575	21.3083	479.8550	0.044	1.1797	988.2583	0.001
L15	68.63 - 64.5 (15)	P24x0.575	21.9074	479.8550	0.046	1.1444	988.2583	0.001
L16	64.5 - 64.25 (16)	P24x1.05	21.9339	858.4890	0.026	1.1444	1732.2000	0.001
L17	64.25 - 63 (17)	P24x1.05	22.1249	858.4890	0.026	1.1445	1732.2000	0.001
L18	63 - 62.75 (18)	P24x1	22.1539	819.3900	0.027	1.1445	1656.9083	0.001
L19	62.75 - 60 (19)	P24x1	25.1079	819.3900	0.031	1.2575	1656.9083	0.001
L20	60 - 59.75 (20)	P30x0.675	25.5798	705.1880	0.036	1.2561	1818.1167	0.001
L21	59.75 - 54.75	P30x0.675	25.9169	705.1880	0.037	1.2558	1818.1167	0.001

Section No.	Elevation ft	Size	Actual $V_u$ K	$\phi V_n$ K	Ratio $\frac{V_u}{\phi V_n}$	Actual $T_u$ kip-ft	$\phi T_n$ kip-ft	Ratio $\frac{T_u}{\phi T_n}$
L22	(21) 54.75 - 49.75	P30x0.675	26.2191	705.1880	0.037	1.2555	1818.1167	0.001
L23	(22) 49.75 - 49.25	P30x0.675	26.2435	705.1880	0.037	1.2555	1818.1167	0.001
L24	(23) 49.25 - 49	P30x0.875	26.2567	907.8980	0.029	1.2555	2324.7833	0.001
L25	(24) 49 - 44 (25)	P30x0.875	26.5796	907.8980	0.029	1.2552	2324.7833	0.001
L26	44 - 42 (26)	P30x0.875	26.6967	907.8980	0.029	1.2551	2324.7833	0.001
L27	42 - 41.75 (27)	P30x1	26.7024	1033.1400	0.026	1.2551	2634.1417	0.000
L28	41.75 - 36.75 (28)	P30x1	26.9965	1033.1400	0.026	1.2549	2634.1417	0.000
L29	36.75 - 34.5 (29)	P30x1	27.3005	1033.1400	0.026	1.2459	2634.1417	0.000
L30	34.5 - 34.25 (30)	P30x1.05	27.3250	1082.9300	0.025	1.2370	2756.3167	0.000
L31	34.25 - 34 (31)	P30x1.05	27.3614	1082.9300	0.025	1.2346	2756.3167	0.000
L32	34 - 33.75 (32)	P30x0.95	27.3972	983.1790	0.028	1.2323	2511.0667	0.000
L33	33.75 - 30 (33)	P30x0.95	28.5436	983.1790	0.029	0.0932	2511.0667	0.000
L34	30 - 29.75 (34)	P36x0.7	28.9180	880.3100	0.033	0.0932	2732.0583	0.000
L35	29.75 - 28.5 (35)	P36x0.7	29.0834	880.3100	0.033	0.0932	2732.0583	0.000
L36	28.5 - 28.25 (36)	P36x0.8375	29.1011	1049.1300	0.028	0.0932	3243.3000	0.000
L37	28.25 - 23.25 (37)	P36x0.8375	29.7332	1049.1300	0.028	0.0932	3243.3000	0.000
L38	23.25 - 23 (38)	P36x0.975	29.7545	1216.5900	0.024	0.0932	3746.3083	0.000
L39	23 - 21.5 (39)	P36x0.975	29.9566	1216.5900	0.025	0.0932	3746.3083	0.000
L40	21.5 - 21.25 (40)	P36x0.825	29.9715	1033.8300	0.029	0.0931	3197.1667	0.000
L41	21.25 - 19 (41)	P36x0.825	30.2411	1033.8300	0.029	0.0931	3197.1667	0.000
L42	19 - 18.75 (42)	P36x0.975	30.2646	1216.5900	0.025	0.0938	3746.3083	0.000
L43	18.75 - 18.5 (43)	P36x0.975	30.3017	1216.5900	0.025	0.0945	3746.3083	0.000
L44	18.5 - 18.25 (44)	P36x0.925	30.3384	1155.8500	0.026	0.0951	3564.3417	0.000
L45	18.25 - 13.25 (45)	P36x0.925	31.0153	1155.8500	0.027	0.1106	3564.3417	0.000
L46	13.25 - 12.7 (46)	P36x0.925	31.0782	1155.8500	0.027	0.1161	3564.3417	0.000
L47	12.7 - 12.45 (47)	P36x0.9	31.1049	1125.4100	0.028	0.1198	3472.9583	0.000
L48	12.45 - 11.5 (48)	P36x0.9	31.2356	1125.4100	0.028	0.1337	3472.9583	0.000
L49	11.5 - 11.25 (49)	P36x0.9	31.2550	1125.4100	0.028	0.1374	3472.9583	0.000
L50	11.25 - 10.5 (50)	P36x0.9	31.3567	1125.4100	0.028	0.1484	3472.9583	0.000
L51	10.5 - 10.25 (51)	P36x1.325	31.3803	1636.8000	0.019	0.1521	4989.8917	0.000
L52	10.25 - 7.5 (52)	P36x1.325	31.7601	1636.8000	0.019	0.1925	4989.8917	0.000
L53	7.5 - 7.25 (53)	P36x1.4	31.7784	1725.7100	0.018	0.1962	5249.5583	0.000
L54	7.25 - 6.25 (54)	P36x1.4	31.9202	1725.7100	0.018	0.2109	5249.5583	0.000
L55	6.25 - 6 (55)	P36x1.4	31.9434	1725.7100	0.019	0.2145	5249.5583	0.000
L56	6 - 3.73 (56)	P36x1.725	32.2592	2106.3500	0.015	0.2453	6347.2667	0.000
L57	3.73 - 3.48 (57)	P36x1.725	32.2825	2106.3500	0.015	0.2461	6347.2667	0.000
L58	3.48 - 2.75 (58)	P36x1.725	32.3855	2106.3500	0.015	0.2485	6347.2667	0.000

Section No.	Elevation ft	Size	Actual $V_u$ K	$\phi V_n$ K	Ratio $V_u$ $\phi V_n$	Actual $T_u$ kip-ft	$\phi T_n$ kip-ft	Ratio $T_u$ $\phi T_n$
L59	2.75 - 2.5 (59)	P36x1.675	32.4131	2048.2800	0.016	0.2493	6181.2833	0.000
L60	2.5 - 2 (60)	P36x1.675	32.4822	2048.2800	0.016	0.2510	6181.2833	0.000
L61	2 - 1.75 (61)	P36x1.425	32.5115	1755.2500	0.019	0.2518	5335.5833	0.000
L62	1.75 - 0 (62)	P36x1.425	32.6177	1755.2500	0.019	0.2518	5335.5833	0.000

### Pole Interaction Design Data

Section No.	Elevation ft	Ratio $P_u$ $\phi P_n$	Ratio $M_{ux}$ $\phi M_{nx}$	Ratio $M_{uy}$ $\phi M_{ny}$	Ratio $V_u$ $\phi V_n$	Ratio $T_u$ $\phi T_n$	Comb. Stress Ratio	Allow. Stress Ratio	Criteria
L1	118 - 113 (1)	0.005	0.021	0.000	0.018	0.000	0.026	1.050	4.8.2
L2	113 - 108 (2)	0.005	0.069	0.000	0.020	0.000	0.075	1.050	4.8.2
L3	108 - 103 (3)	0.012	0.176	0.000	0.043	0.000	0.190	1.050	4.8.2
L4	103 - 98 (4)	0.013	0.286	0.000	0.044	0.000	0.301	1.050	4.8.2
L5	98 - 93 (5)	0.018	0.455	0.000	0.067	0.001	0.477	1.050	4.8.2
L6	93 - 90 (6)	0.018	0.557	0.000	0.068	0.001	0.580	1.050	4.8.2
L7	90 - 85 (7)	0.013	0.468	0.000	0.045	0.001	0.483	1.050	4.8.2
L8	85 - 80 (8)	0.016	0.628	0.000	0.061	0.001	0.648	1.050	4.8.2
L9	80 - 76.5 (9)	0.017	0.738	0.000	0.062	0.001	0.759	1.050	4.8.2
L10	76.5 - 76.25 (10)	0.011	0.458	0.000	0.040	0.001	0.471	1.050	4.8.2
L11	76.25 - 74 (11)	0.011	0.502	0.000	0.040	0.001	0.515	1.050	4.8.2
L12	74 - 73.75 (12)	0.007	0.340	0.000	0.027	0.001	0.348	1.050	4.8.2
L13	73.75 - 68.88 (13)	0.008	0.407	0.000	0.029	0.001	0.416	1.050	4.8.2
L14	68.88 - 68.63 (14)	0.013	0.625	0.000	0.044	0.001	0.640	1.050	4.8.2
L15	68.63 - 64.5 (15)	0.014	0.715	0.000	0.046	0.001	0.730	1.050	4.8.2
L16	64.5 - 64.25 (16)	0.008	0.411	0.000	0.026	0.001	0.419	1.050	4.8.2
L17	64.25 - 63 (17)	0.008	0.426	0.000	0.026	0.001	0.435	1.050	4.8.2
L18	63 - 62.75 (18)	0.008	0.449	0.000	0.027	0.001	0.458	1.050	4.8.2
L19	62.75 - 60 (19)	0.010	0.489	0.000	0.031	0.001	0.500	1.050	4.8.2
L20	60 - 59.75 (20)	0.012	0.449	0.000	0.036	0.001	0.462	1.050	4.8.2
L21	59.75 - 54.75 (21)	0.012	0.520	0.000	0.037	0.001	0.534	1.050	4.8.2
L22	54.75 - 49.75 (22)	0.013	0.591	0.000	0.037	0.001	0.606	1.050	4.8.2
L23	49.75 - 49.25 (23)	0.013	0.598	0.000	0.037	0.001	0.613	1.050	4.8.2
L24	49.25 - 49 (24)	0.010	0.471	0.000	0.029	0.001	0.482	1.050	4.8.2
L25	49 - 44 (25)	0.011	0.527	0.000	0.029	0.001	0.539	1.050	4.8.2
L26	44 - 42 (26)	0.011	0.550	0.000	0.029	0.001	0.562	1.050	4.8.2
L27	42 - 41.75 (27)	0.010	0.488	0.000	0.026	0.000	0.498	1.050	4.8.2
L28	41.75 - 36.75 (28)	0.010	0.538	0.000	0.026	0.000	0.549	1.050	4.8.2
L29	36.75 - 34.5 (29)	0.011	0.561	0.000	0.026	0.000	0.573	1.050	4.8.2
L30	34.5 - 34.25 (30)	0.010	0.539	0.000	0.025	0.000	0.550	1.050	4.8.2
L31	34.25 - 34 (31)	0.010	0.541	0.000	0.025	0.000	0.552	1.050	4.8.2
L32	34 - 33.75 (32)	0.011	0.597	0.000	0.028	0.000	0.609	1.050	4.8.2



Section No.	Elevation ft	Ratio	Ratio	Ratio	Ratio	Ratio	Comb. Stress Ratio	Allow. Stress Ratio	Criteria
		$P_u$	$M_{ux}$	$M_{uy}$	$V_u$	$T_u$			
		$\phi P_n$	$\phi M_{nx}$	$\phi M_{ny}$	$\phi V_n$	$\phi T_n$			
L33	33.75 - 30 (33)	0.012	0.639	0.000	0.029	0.000	0.651	1.050	4.8.2
L34	30 - 29.75 (34)	0.014	0.599	0.000	0.033	0.000	0.614	1.050	4.8.2
L35	29.75 - 28.5 (35)	0.014	0.613	0.000	0.033	0.000	0.627	1.050	4.8.2
L36	28.5 - 28.25 (36)	0.012	0.510	0.000	0.028	0.000	0.522	1.050	4.8.2
L37	28.25 - 23.25 (37)	0.012	0.555	0.000	0.028	0.000	0.568	1.050	4.8.2
L38	23.25 - 23 (38)	0.011	0.483	0.000	0.024	0.000	0.494	1.050	4.8.2
L39	23 - 21.5 (39)	0.011	0.494	0.000	0.025	0.000	0.506	1.050	4.8.2
L40	21.5 - 21.25 (40)	0.013	0.582	0.000	0.029	0.000	0.595	1.050	4.8.2
L41	21.25 - 19 (41)	0.013	0.603	0.000	0.029	0.000	0.617	1.050	4.8.2
L42	19 - 18.75 (42)	0.011	0.516	0.000	0.025	0.000	0.528	1.050	4.8.2
L43	18.75 - 18.5 (43)	0.011	0.518	0.000	0.025	0.000	0.530	1.050	4.8.2
L44	18.5 - 18.25 (44)	0.012	0.547	0.000	0.026	0.000	0.559	1.050	4.8.2
L45	18.25 - 13.25 (45)	0.012	0.590	0.000	0.027	0.000	0.603	1.050	4.8.2
L46	13.25 - 12.7 (46)	0.012	0.594	0.000	0.027	0.000	0.608	1.050	4.8.2
L47	12.7 - 12.45 (47)	0.013	0.612	0.000	0.028	0.000	0.626	1.050	4.8.2
L48	12.45 - 11.5 (48)	0.013	0.621	0.000	0.028	0.000	0.634	1.050	4.8.2
L49	11.5 - 11.25 (49)	0.013	0.623	0.000	0.028	0.000	0.637	1.050	4.8.2
L50	11.25 - 10.5 (50)	0.013	0.630	0.000	0.028	0.000	0.644	1.050	4.8.2
L51	10.5 - 10.25 (51)	0.009	0.440	0.000	0.019	0.000	0.449	1.050	4.8.2
L52	10.25 - 7.5 (52)	0.009	0.457	0.000	0.019	0.000	0.467	1.050	4.8.2
L53	7.5 - 7.25 (53)	0.009	0.436	0.000	0.018	0.000	0.445	1.050	4.8.2
L54	7.25 - 6.25 (54)	0.009	0.442	0.000	0.018	0.000	0.451	1.050	4.8.2
L55	6.25 - 6 (55)	0.009	0.443	0.000	0.019	0.000	0.453	1.050	4.8.2
L56	6 - 3.73 (56)	0.008	0.378	0.000	0.015	0.000	0.386	1.050	4.8.2
L57	3.73 - 3.48 (57)	0.008	0.379	0.000	0.015	0.000	0.387	1.050	4.8.2
L58	3.48 - 2.75 (58)	0.008	0.383	0.000	0.015	0.000	0.391	1.050	4.8.2
L59	2.75 - 2.5 (59)	0.008	0.395	0.000	0.016	0.000	0.403	1.050	4.8.2
L60	2.5 - 2 (60)	0.008	0.397	0.000	0.016	0.000	0.405	1.050	4.8.2
L61	2 - 1.75 (61)	0.009	0.462	0.000	0.019	0.000	0.471	1.050	4.8.2
L62	1.75 - 0 (62)	0.009	0.472	0.000	0.019	0.000	0.482	1.050	4.8.2

### Section Capacity Table

Section No.	Elevation ft	Component Type	Size	Critical Element	P K	$\phi P_{allow}$ K	% Capacity	Pass Fail
L1	118 - 113	Pole	P24x0.25	1	-3.0550	695.3782	2.5	Pass
L2	113 - 108	Pole	P24x0.25	2	-3.4417	695.3782	7.1	Pass
L3	108 - 103	Pole	P24x0.25	3	-8.0984	695.3782	18.1	Pass
L4	103 - 98	Pole	P24x0.25	4	-8.5439	695.3782	28.7	Pass
L5	98 - 93	Pole	P24x0.25	5	-11.6936	695.3782	45.4	Pass

Section No.	Elevation ft	Component Type	Size	Critical Element	P K	$\phi P_{allow}$ K	% Capacity	Pass Fail	
L6	93 - 90	Pole	P24x0.25	6	-12.0119	695.3782	55.2	Pass	
L7	90 - 85	Pole	P24x0.375	7	-13.6784	1104.6734	46.0	Pass	
L8	85 - 80	Pole	P24x0.375	8	-17.1794	1104.6734	61.7	Pass	
L9	80 - 76.5	Pole	P24x0.375	9	-17.8491	1104.6734	72.3	Pass	
L10	76.5 - 76.25	Pole	P24x0.5875	10	-17.9151	1715.0909	44.9	Pass	
L11	76.25 - 74	Pole	P24x0.5875	11	-18.4013	1715.0909	49.1	Pass	
L12	74 - 73.75	Pole	P24x0.9	12	-18.4832	2592.3029	33.2	Pass	
L13	73.75 - 68.88	Pole	P24x0.9	13	-20.5970	2592.3029	39.6	Pass	
L14	68.88 - 68.63	Pole	P24x0.575	14	-20.6611	1679.4959	60.9	Pass	
L15	68.63 - 64.5	Pole	P24x0.575	15	-21.6090	1679.4959	69.6	Pass	
L16	64.5 - 64.25	Pole	P24x1.05	16	-21.7062	3004.7114	39.9	Pass	
L17	64.25 - 63	Pole	P24x1.05	17	-22.1266	3004.7114	41.4	Pass	
L18	63 - 62.75	Pole	P24x1	18	-22.2182	2867.8649	43.6	Pass	
L19	62.75 - 60	Pole	P24x1	19	-25.9752	2867.8649	47.6	Pass	
L20	60 - 59.75	Pole	P30x0.675	20	-27.5997	2468.1614	44.0	Pass	
L21	59.75 - 54.75	Pole	P30x0.675	21	-29.2228	2468.1614	50.8	Pass	
L22	54.75 - 49.75	Pole	P30x0.675	22	-30.8668	2468.1614	57.7	Pass	
L23	49.75 - 49.25	Pole	P30x0.675	23	-31.0372	2468.1614	58.4	Pass	
L24	49.25 - 49	Pole	P30x0.875	24	-31.1281	3177.6464	45.9	Pass	
L25	49 - 44	Pole	P30x0.875	25	-32.8817	3177.6464	51.3	Pass	
L26	44 - 42	Pole	P30x0.875	26	-33.5893	3177.6464	53.5	Pass	
L27	42 - 41.75	Pole	P30x1	27	-33.6942	3616.0003	47.4	Pass	
L28	41.75 - 36.75	Pole	P30x1	28	-35.6381	3616.0003	52.3	Pass	
L29	36.75 - 34.5	Pole	P30x1	29	-36.5145	3616.0003	54.5	Pass	
L30	34.5 - 34.25	Pole	P30x1.05	30	-36.6304	3790.2583	52.4	Pass	
L31	34.25 - 34	Pole	P30x1.05	31	-36.7371	3790.2583	52.6	Pass	
L32	34 - 33.75	Pole	P30x0.95	32	-36.8349	3441.1228	58.0	Pass	
L33	33.75 - 30	Pole	P30x0.95	33	-38.2848	3441.1228	62.0	Pass	
L34	30 - 29.75	Pole	P36x0.7	34	-39.9379	3081.0884	58.5	Pass	
L35	29.75 - 28.5	Pole	P36x0.7	35	-40.4189	3081.0884	59.8	Pass	
L36	28.5 - 28.25	Pole	P36x0.8375	36	-40.5403	3671.9443	49.8	Pass	
L37	28.25 - 23.25	Pole	P36x0.8375	37	-42.7647	3671.9443	54.1	Pass	
L38	23.25 - 23	Pole	P36x0.975	38	-42.8955	4258.0753	47.0	Pass	
L39	23 - 21.5	Pole	P36x0.975	39	-43.6267	4258.0753	48.2	Pass	
L40	21.5 - 21.25	Pole	P36x0.825	40	-43.7474	3618.4153	56.7	Pass	
L41	21.25 - 19	Pole	P36x0.825	41	-44.7354	3618.4153	58.7	Pass	
L42	19 - 18.75	Pole	P36x0.975	42	-44.8687	4258.0753	50.3	Pass	
L43	18.75 - 18.5	Pole	P36x0.975	43	-44.9926	4258.0753	50.5	Pass	
L44	18.5 - 18.25	Pole	P36x0.925	44	-45.1080	4045.4818	53.3	Pass	
L45	18.25 - 13.25	Pole	P36x0.925	45	-47.4172	4045.4818	57.4	Pass	
L46	13.25 - 12.7	Pole	P36x0.925	46	-47.6774	4045.4818	57.9	Pass	
L47	12.7 - 12.45	Pole	P36x0.9	47	-47.7974	3938.9488	59.6	Pass	
L48	12.45 - 11.5	Pole	P36x0.9	48	-48.2342	3938.9488	60.4	Pass	
L49	11.5 - 11.25	Pole	P36x0.9	49	-48.3678	3938.9488	60.6	Pass	
L50	11.25 - 10.5	Pole	P36x0.9	50	-48.7404	3938.9488	61.3	Pass	
L51	10.5 - 10.25	Pole	P36x1.325	51	-48.8865	5728.7997	42.8	Pass	
L52	10.25 - 7.5	Pole	P36x1.325	52	-50.4161	5728.7997	44.4	Pass	
L53	7.5 - 7.25	Pole	P36x1.4	53	-50.5703	6039.9777	42.4	Pass	
L54	7.25 - 6.25	Pole	P36x1.4	54	-51.1435	6039.9777	43.0	Pass	
L55	6.25 - 6	Pole	P36x1.4	55	-51.2945	6039.9777	43.1	Pass	
L56	6 - 3.73	Pole	P36x1.725	56	-52.6588	7372.2072	36.7	Pass	
L57	3.73 - 3.48	Pole	P36x1.725	57	-52.8161	7372.2072	36.9	Pass	
L58	3.48 - 2.75	Pole	P36x1.725	58	-53.2537	7372.2072	37.2	Pass	
L59	2.75 - 2.5	Pole	P36x1.675	59	-53.3960	7168.9587	38.4	Pass	
L60	2.5 - 2	Pole	P36x1.675	60	-53.6721	7168.9587	38.6	Pass	
L61	2 - 1.75	Pole	P36x1.425	61	-53.7994	6143.3922	44.9	Pass	
L62	1.75 - 0	Pole	P36x1.425	62	-54.6673	6143.3922	45.9	Pass	
							Summary		
							Pole (L9)	72.3	Pass
							<b>RATING =</b>	<b>72.3</b>	<b>Pass</b>

**\*NOTE: Above stress ratios for reinforced sections are approximate. More exact calculations are presented in Appendix C.**

**APPENDIX B**  
**BASE LEVEL DRAWING**

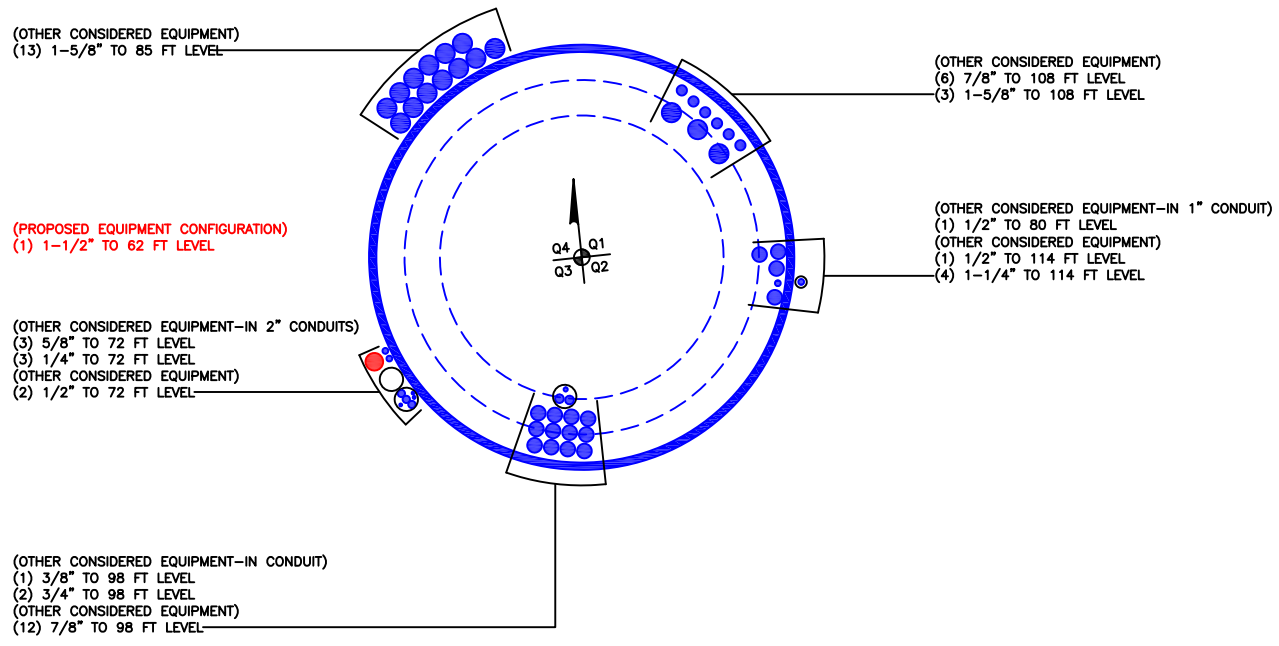

**APPENDIX C**  
**ADDITIONAL CALCULATIONS**

Site BU: 876331  
Work Order: 1966745

Copyright © 2019 Crown Castle

**Pole Geometry**

	Pole Height Above Base (ft)	Section Length (ft)	Lap Splice Length (ft)	Number of Sides	Top Diameter (in)	Bottom Diameter (in)	Wall Thickness (in)	Bend Radius (in)	Pole Material
1	118	28		0	24	24	0.25		A572-42
2	90	30		0	24.00	24	0.375		A572-42
3	60	30		0	30.00	30	0.375		A572-42
4	30	30		0	36.00	36	0.375		A572-42

**Reinforcement Configuration**

	Bottom Effective Elevation (ft)	Top Effective Elevation (ft)	Type	Model	Number	1	2	3	4	5	6	7	8	9	10	11	12	13	14	15	16	17	18	
1	3.83	30	plate	A	3	0	135	225																
2	30	60	plate	B	3	0	135	225																
3	60	74	plate	C	3							0	135	225										
4	2	19	plate	MS-450 (1.1875")	2										65	295								
5	2	7.5	plate	MS-450 (1.1875")	1												180							
6	7.5	12.7	plate	FP 1.25x4	1												200							
7	12.7	19	plate	MS-450 (1.1875")	1													180						
8	30	34.5	plate	MS-400 (1.1875")	3														45	180	295			
9	60	64.5	plate	MS-400 (1.1875")	3	65	180	295																
10	2.75	23.25	plate	CCI-AFP-060100	2				30	310														
11	34	42	plate	CCI-SFP-040075	3						75	205	320											
12	60	63	plate	FP 3.75x1 (1.1875)	3									90	195	320								
13	63	68.88	plate	CCI-SFP-045100	3												90	195	320					
14	0	3.75	plate	FP 1.25x7.25	3															34	214	304		
15	0	3.75	plate	FP 1.25x7	1																			124
16	21.5	28.5	plate	CCI-SFP-045100	3	90	200	330																
17	30	49.25	plate	CCI-SFP-040075	2				100	270														
18	68.88	76.5	plate	CCI-SFP-045100	3						40	160	275											
19	18.5	30	plate	FP 4x1 (1.1875)	1									50										
20	18.5	30	plate	CCI-SFP-045100	1									253										
21	0	10.5	plate	FP 1.25x5.5	2										106	350								
22	0	6.25	plate	FP 1.25x9.25	1												169							
23	6.25	11.5	plate	FP 1.25x7	1												160							
24	0	10.5	plate	FP 1.25x8	1																		282	
25	0	7.5	solid round	1.75" Williams R71	2																		106	350
26																								

**Reinforcement Details**

	B (in)	H (in)	Gross Area (in <sup>2</sup> )	Pole Face to Centroid (in)	Bottom Termination Type	Bottom Termination Length (in)	Top Termination Type	Top Termination Length (in)	Lu (in)	Net Area (in <sup>2</sup> )	Bolt Hole Size (in)	Reinforcement Material
1	9.67599	1.01526	9.82367	0.50763154	None	n/a	None	n/a	24.000	8.555	1.1875	A572-65
2	9.67599	1.01526	9.82367	0.50763154	None	n/a	None	n/a	24.000	8.555	1.1875	A572-65
3	8.734	0.76149	6.65082	0.380742644	None	n/a	None	n/a	24.000	5.699	1.1875	A572-65
4	4.5	1	4.5	0.5	PC 8.8 - M20 (100)	18	PC 8.8 - M20 (100)	18.000	20.625	3.250	1.1875	A572-65
5	4.5	1	4.5	0.5	PC 8.8 - M20 (100)	18	PC 8.8 - M20 (100)	18.000	20.625	3.250	1.1875	A572-65
6	1.25	4	5	2	None	n/a	None	n/a	20.625	5.000	0.0000	A572-65
7	4.5	1	4.5	0.5	PC 8.8 - M20 (100)	18	PC 8.8 - M20 (100)	18.000	20.625	3.250	1.1875	A572-65
8	4	0.75	3	0.375	PC 8.8 - M20 (100)	12	PC 8.8 - M20 (100)	12.000	16.875	2.063	1.1875	A572-65
9	4	0.75	3	0.375	PC 8.8 - M20 (100)	12	PC 8.8 - M20 (100)	12.000	16.875	2.063	1.1875	A572-65
10	6	1	6	0.5	PC 8.8 - M20 (100)	30	PC 8.8 - M20 (100)	30.000	16.000	4.750	1.1875	A572-65
11	4	0.75	3	0.375	PC 8.8 - M20 (100)	12	PC 8.8 - M20 (100)	12.000	16.000	2.063	1.1875	A572-65
12	3.75	1	3.75	0.5	None	n/a	None	n/a	16.000	2.500	1.1875	A572-65
13	4.5	1	4.5	0.5	PC 8.8 - M20 (100)	18	PC 8.8 - M20 (100)	18.000	20.000	3.250	1.1875	A572-65
14	1.25	7.25	9.0625	3.625	None	n/a	None	n/a	0.000	9.063	0.0000	A572-65
15	1.25	7	8.75	3.5	None	n/a	None	n/a	0.000	8.750	0.0000	A572-65
16	4.5	1	4.5	0.5	PC 8.8 - M20 (100)	18	PC 8.8 - M20 (100)	18.000	20.000	3.250	1.1875	A572-65
17	4	0.75	3	0.375	PC 8.8 - M20 (100)	12	PC 8.8 - M20 (100)	12.000	16.000	2.063	1.1875	A572-65
18	4.5	1	4.5	0.5	PC 8.8 - M20 (100)	18	PC 8.8 - M20 (100)	18.000	20.000	3.250	1.1875	A572-65
19	4	1	4	0.5	None	n/a	None	n/a	20.000	2.750	1.1875	A572-65
20	4.5	1	4.5	0.5	PC 8.8 - M20 (100)	18	PC 8.8 - M20 (100)	18.000	20.000	3.250	1.1875	A572-65
21	1.25	5.5	6.875	2.75	None	n/a	None	n/a	0.000	6.875	0.0000	A572-65
22	1.25	9.25	11.5625	4.625	None	n/a	None	n/a	0.000	11.563	0.0000	A572-65
23	1.25	7	8.75	3.5	None	n/a	None	n/a	0.000	8.750	0.0000	A572-65
24	1.25	8	10	4	None	n/a	None	n/a	27.000	10.000	0.0000	A572-65
25	0	0	2.663	9.625	None	n/a	None	n/a	6.000	2.663	0.0000	A722-07

**Connection Details for Custom Reinforcements**

Reinforcement	End	# Bolts	N or X	Bolt Spacing (in)	Edge Dist (in)	Weld Grade (ksi)	Transverse (Horiz.) Weld Type	Horiz. Weld Length (in)	Horiz. Groove Depth (in)	Horiz. Groove Angle (deg)	Horiz. Fillet Size (in)	Vertical Weld Length (in)	Vertical Fillet Size (in)	Rev H Connection Capacity (kip)
1.75" Williams R71	Top	-	-	-	-	0	0	0	-	-	0	-	-	-
	Bottom	-	-	-	-	0	0	0	-	-	0	-	-	-
FP 1.25x4	Top	-	-	-	-	0	0	0	-	-	0	-	-	-
	Bottom	-	-	-	-	0	0	0	-	-	0	-	-	-
FP 1.25x7.25	Top	-	-	-	-	0	0	0	-	-	0	-	-	-
	Bottom	-	-	-	-	0	0	0	-	-	0	-	-	-
FP 1.25x7	Top	-	-	-	-	0	0	0	-	-	0	-	-	-
	Bottom	-	-	-	-	0	0	0	-	-	0	-	-	-
FP 1.25x5.5	Top	-	-	-	-	0	0	0	-	-	0	-	-	-
	Bottom	-	-	-	-	0	0	0	-	-	0	-	-	-
FP 1.25x9.25	Top	-	-	-	-	0	0	0	-	-	0	-	-	-
	Bottom	-	-	-	-	0	0	0	-	-	0	-	-	-
FP 1.25x8	Top	-	-	-	-	0	0	0	-	-	0	-	-	-
	Bottom	-	-	-	-	0	0	0	-	-	0	-	-	-
A	Top	-	-	-	-	0	0	0	-	-	0	-	-	-
	Bottom	-	-	-	-	0	0	0	-	-	0	-	-	-
B	Top	-	-	-	-	0	0	0	-	-	0	-	-	-
	Bottom	-	-	-	-	0	0	0	-	-	0	-	-	-
C	Top	-	-	-	-	0	0	0	-	-	0	-	-	-
	Bottom	-	-	-	-	0	0	0	-	-	0	-	-	-
FP 3.75x1 (1.1875)	Top	-	-	-	-	0	0	0	-	-	0	-	-	-
	Bottom	-	-	-	-	0	0	0	-	-	0	-	-	-
FP 4x1 (1.1875)	Top	-	-	-	-	0	0	0	-	-	0	-	-	-
	Bottom	-	-	-	-	0	0	0	-	-	0	-	-	-

# TNX Geometry Input

Increment (ft):  [Export to TNX](#)

	Section Height (ft)	Section Length (ft)	Lap Splice Length (ft)	Number of Sides	Top Diameter (in)	Bottom Diameter (in)	Wall Thickness (in)	Tapered Pole Grade	Weight Multiplier
1	118 - 113	5		0	24.000	24.000	0.25	A572-42	1.000
2	113 - 108	5		0	24.000	24.000	0.25	A572-42	1.000
3	108 - 103	5		0	24.000	24.000	0.25	A572-42	1.000
4	103 - 98	5		0	24.000	24.000	0.25	A572-42	1.000
5	98 - 93	5		0	24.000	24.000	0.25	A572-42	1.000
6	93 - 90	3	0	0	24.000	24.000	0.25	A572-42	1.000
7	90 - 85	5		0	24.000	24.000	0.375	A572-42	1.000
8	85 - 80	5		0	24.000	24.000	0.375	A572-42	1.000
9	80 - 76.5	3.5		0	24.000	24.000	0.375	A572-42	1.000
10	76.5 - 76.25	0.25		0	24.000	24.000	0.5875	A572-42	0.957
11	76.25 - 74	2.25		0	24.000	24.000	0.5875	A572-42	0.957
12	74 - 73.75	0.25		0	24.000	24.000	0.9	A572-42	0.938
13	73.75 - 68.88	4.87		0	24.000	24.000	0.9	A572-42	0.938
14	68.88 - 68.63	0.25		0	24.000	24.000	0.575	A572-42	0.977
15	68.63 - 64.5	4.13		0	24.000	24.000	0.575	A572-42	0.977
16	64.5 - 64.25	0.25		0	24.000	24.000	1.05	A572-42	0.928
17	64.25 - 63	1.25		0	24.000	24.000	1.05	A572-42	0.928
18	63 - 62.75	0.25		0	24.000	24.000	1	A572-42	0.942
19	62.75 - 60	2.75	0	0	24.000	24.000	1	A572-42	0.942
20	60 - 59.75	0.25		0	30.000	30.000	0.675	A572-42	1.035
21	59.75 - 54.75	5		0	30.000	30.000	0.675	A572-42	1.035
22	54.75 - 49.75	5		0	30.000	30.000	0.675	A572-42	1.035
23	49.75 - 49.25	0.5		0	30.000	30.000	0.675	A572-42	1.035
24	49.25 - 49	0.25		0	30.000	30.000	0.875	A572-42	0.879
25	49 - 44	5		0	30.000	30.000	0.875	A572-42	0.879
26	44 - 42	2		0	30.000	30.000	0.875	A572-42	0.879
27	42 - 41.75	0.25		0	30.000	30.000	1	A572-42	0.871
28	41.75 - 36.75	5		0	30.000	30.000	1	A572-42	0.871
29	36.75 - 34.5	2.25		0	30.000	30.000	1	A572-42	0.871
30	34.5 - 34.25	0.25		0	30.000	30.000	1.05	A572-42	0.925
31	34.25 - 34	0.25		0	30.000	30.000	1.05	A572-42	0.925
32	34 - 33.75	0.25		0	30.000	30.000	0.95	A572-42	0.915
33	33.75 - 30	3.75	0	0	30.000	30.000	0.95	A572-42	0.915
34	30 - 29.75	0.25		0	36.000	36.000	0.7	A572-42	1.030
35	29.75 - 28.5	1.25		0	36.000	36.000	0.7	A572-42	1.030
36	28.5 - 28.25	0.25		0	36.000	36.000	0.8375	A572-42	1.010
37	28.25 - 23.25	5		0	36.000	36.000	0.8375	A572-42	1.010
38	23.25 - 23	0.25		0	36.000	36.000	0.975	A572-42	0.983
39	23 - 21.5	1.5		0	36.000	36.000	0.975	A572-42	0.983
40	21.5 - 21.25	0.25		0	36.000	36.000	0.825	A572-42	1.008
41	21.25 - 19	2.25		0	36.000	36.000	0.825	A572-42	1.008
42	19 - 18.75	0.25		0	36.000	36.000	0.975	A572-42	0.983
43	18.75 - 18.5	0.25		0	36.000	36.000	0.975	A572-42	0.983
44	18.5 - 18.25	0.25		0	36.000	36.000	0.925	A572-42	0.951
45	18.25 - 13.25	5		0	36.000	36.000	0.925	A572-42	0.951
46	13.25 - 12.7	0.55		0	36.000	36.000	0.925	A572-42	0.951
47	12.7 - 12.45	0.25		0	36.000	36.000	0.9	A572-42	0.982
48	12.45 - 11.5	0.95		0	36.000	36.000	0.9	A572-42	0.982
49	11.5 - 11.25	0.25		0	36.000	36.000	0.9	A572-42	1.070
50	11.25 - 10.5	0.75		0	36.000	36.000	0.9	A572-42	1.070
51	10.5 - 10.25	0.25		0	36.000	36.000	1.325	A572-42	0.840
52	10.25 - 7.5	2.75		0	36.000	36.000	1.325	A572-42	0.840
53	7.5 - 7.25	0.25		0	36.000	36.000	1.4	A572-42	0.828
54	7.25 - 6.25	1		0	36.000	36.000	1.4	A572-42	0.828
55	6.25 - 6	0.25		0	36.000	36.000	1.4	A572-42	0.828
56	6 - 3.73	2.27		0	36.000	36.000	1.725	A572-42	0.713
57	3.73 - 3.48	0.25		0	36.000	36.000	1.725	A572-42	0.713
58	3.48 - 2.75	0.73		0	36.000	36.000	1.725	A572-42	0.713
59	2.75 - 2.5	0.25		0	36.000	36.000	1.675	A572-42	0.667
60	2.5 - 2	0.5		0	36.000	36.000	1.675	A572-42	0.667
61	2 - 1.75	0.25		0	36.000	36.000	1.425	A572-42	0.691
62	1.75 - 0	1.75		0	36.000	36.000	1.425	A572-42	0.691

# TNX Section Forces

Increment (ft):		TNX Output			
	5	Section Height (ft)	P <sub>u</sub> (K)	M <sub>ux</sub> (kip-ft)	V <sub>u</sub> (K)
1	118 - 113		3.05	8.48	3.64
2	113 - 108		3.44	27.51	3.97
3	108 - 103		8.10	69.74	8.61
4	103 - 98		8.54	113.56	8.92
5	98 - 93		11.69	180.34	13.49
6	93 - 90		12.01	221.04	13.66
7	90 - 85		13.68	291.84	14.31
8	85 - 80		17.18	391.68	19.40
9	80 - 76.5		17.85	460.28	19.62
10	76.5 - 76.25		17.92	465.19	19.63
11	76.25 - 74		18.40	509.51	19.75
12	74 - 73.75		18.48	514.45	19.76
13	73.75 - 68.88		20.60	615.66	21.29
14	68.88 - 68.63		20.66	620.99	21.31
15	68.63 - 64.5		21.61	710.46	21.91
16	64.5 - 64.25		21.71	715.94	21.93
17	64.25 - 63		22.13	743.46	22.12
18	63 - 62.75		22.22	748.99	22.15
19	62.75 - 60		25.98	815.42	25.11
20	60 - 59.75		27.60	821.81	25.58
21	59.75 - 54.75		29.22	950.51	25.92
22	54.75 - 49.75		30.87	1080.78	26.22
23	49.75 - 49.25		31.04	1093.89	26.24
24	49.25 - 49		31.13	1100.45	26.26
25	49 - 44		32.88	1232.49	26.58
26	44 - 42		33.59	1285.74	26.70
27	42 - 41.75		33.69	1292.41	26.70
28	41.75 - 36.75		35.64	1426.60	27.00
29	36.75 - 34.5		36.51	1487.65	27.30
30	34.5 - 34.25		36.63	1494.47	27.32
31	34.25 - 34		36.74	1501.31	27.36
32	34 - 33.75		36.83	1508.15	27.40
33	33.75 - 30		38.28	1613.51	28.54
34	30 - 29.75		39.94	1620.74	28.92
35	29.75 - 28.5		40.42	1656.95	29.08
36	28.5 - 28.25		40.54	1664.22	29.10
37	28.25 - 23.25		42.76	1811.19	29.73
38	23.25 - 23		42.90	1818.62	29.75
39	23 - 21.5		43.63	1863.36	29.96
40	21.5 - 21.25		43.75	1870.84	29.97
41	21.25 - 19		44.74	1938.52	30.24
42	19 - 18.75		44.87	1946.08	30.26
43	18.75 - 18.5		44.99	1953.64	30.30
44	18.5 - 18.25		45.11	1961.22	30.34
45	18.25 - 13.25		47.42	2114.48	31.02
46	13.25 - 12.7		47.68	2131.54	31.08
47	12.7 - 12.45		47.80	2139.30	31.10
48	12.45 - 11.5		48.23	2168.89	31.24
49	11.5 - 11.25		48.37	2176.69	31.26
50	11.25 - 10.5		48.74	2200.15	31.36
51	10.5 - 10.25		48.89	2207.99	31.38
52	10.25 - 7.5		50.42	2294.73	31.76
53	7.5 - 7.25		50.57	2302.67	31.78
54	7.25 - 6.25		51.14	2334.49	31.92
55	6.25 - 6		51.29	2342.47	31.94
56	6 - 3.73		52.66	2415.28	32.26
57	3.73 - 3.48		52.82	2423.34	32.28
58	3.48 - 2.75		53.25	2446.93	32.39
59	2.75 - 2.5		53.40	2455.02	32.41
60	2.5 - 2		53.67	2471.24	32.48
61	2 - 1.75		53.80	2479.36	32.51
62	1.75 - 0		54.67	2536.29	32.62



# Analysis Results

Elevation (ft)	Component Type	Size	Critical Element	% Capacity	Pass / Fail
118 - 113	Pole	TP24x24x0.25	Pole	2.5%	Pass
113 - 108	Pole	TP24x24x0.25	Pole	7.1%	Pass
108 - 103	Pole	TP24x24x0.25	Pole	18.1%	Pass
103 - 98	Pole	TP24x24x0.25	Pole	28.7%	Pass
98 - 93	Pole	TP24x24x0.25	Pole	45.4%	Pass
93 - 90	Pole	TP24x24x0.25	Pole	55.2%	Pass
90 - 85	Pole	TP24x24x0.375	Pole	46.0%	Pass
85 - 80	Pole	TP24x24x0.375	Pole	61.7%	Pass
80 - 76.5	Pole	TP24x24x0.375	Pole	72.3%	Pass
76.5 - 76.25	Pole + Reinf.	TP24x24x0.5875	Reinf. 18 Tension Rupture	52.5%	Pass
76.25 - 74	Pole + Reinf.	TP24x24x0.5875	Reinf. 18 Tension Rupture	57.4%	Pass
74 - 73.75	Pole + Reinf.	TP24x24x0.9	Reinf. 3 Compression	56.9%	Pass
73.75 - 68.88	Pole + Reinf.	TP24x24x0.9	Reinf. 3 Compression	68.1%	Pass
68.88 - 68.63	Pole + Reinf.	TP24x24x0.575	Reinf. 13 Tension Rupture	70.2%	Pass
68.63 - 64.5	Pole + Reinf.	TP24x24x0.575	Reinf. 13 Tension Rupture	80.2%	Pass
64.5 - 64.25	Pole + Reinf.	TP24x24x1.05	Reinf. 3 Compression	69.5%	Pass
64.25 - 63	Pole + Reinf.	TP24x24x1.05	Reinf. 3 Compression	72.1%	Pass
63 - 62.75	Pole + Reinf.	TP24x24x1	Reinf. 3 Compression	74.9%	Pass
62.75 - 60	Pole + Reinf.	TP24x24x1	Reinf. 3 Compression	81.7%	Pass
60 - 59.75	Pole + Reinf.	TP30x30x0.675	Reinf. 2 Compression	51.8%	Pass
59.75 - 54.75	Pole + Reinf.	TP30x30x0.675	Reinf. 2 Compression	59.8%	Pass
54.75 - 49.75	Pole + Reinf.	TP30x30x0.675	Reinf. 2 Compression	67.9%	Pass
49.75 - 49.25	Pole + Reinf.	TP30x30x0.675	Reinf. 2 Compression	68.7%	Pass
49.25 - 49	Pole + Reinf.	TP30x30x0.875	Reinf. 2 Compression	63.3%	Pass
49 - 44	Pole + Reinf.	TP30x30x0.875	Reinf. 2 Compression	70.8%	Pass
44 - 42	Pole + Reinf.	TP30x30x0.875	Reinf. 2 Compression	73.8%	Pass
42 - 41.75	Pole + Reinf.	TP30x30x1	Reinf. 2 Compression	65.3%	Pass
41.75 - 36.75	Pole + Reinf.	TP30x30x1	Reinf. 2 Compression	72.0%	Pass
36.75 - 34.5	Pole + Reinf.	TP30x30x1	Reinf. 2 Compression	75.1%	Pass
34.5 - 34.25	Pole + Reinf.	TP30x30x1.05	Reinf. 8 Compression	67.0%	Pass
34.25 - 34	Pole + Reinf.	TP30x30x1.05	Reinf. 8 Compression	67.3%	Pass
34 - 33.75	Pole + Reinf.	TP30x30x0.95	Reinf. 8 Compression	75.8%	Pass
33.75 - 30	Pole + Reinf.	TP30x30x0.95	Reinf. 8 Compression	81.1%	Pass
30 - 29.75	Pole + Reinf.	TP36x36x0.7	Reinf. 1 Compression	73.4%	Pass
29.75 - 28.5	Pole + Reinf.	TP36x36x0.7	Reinf. 1 Compression	75.0%	Pass
28.5 - 28.25	Pole + Reinf.	TP36x36x0.8375	Reinf. 1 Compression	62.3%	Pass
28.25 - 23.25	Pole + Reinf.	TP36x36x0.8375	Reinf. 1 Compression	67.7%	Pass
23.25 - 23	Pole + Reinf.	TP36x36x0.975	Reinf. 1 Compression	63.6%	Pass
23 - 21.5	Pole + Reinf.	TP36x36x0.975	Reinf. 1 Compression	65.2%	Pass
21.5 - 21.25	Pole + Reinf.	TP36x36x0.825	Reinf. 1 Compression	78.2%	Pass
21.25 - 19	Pole + Reinf.	TP36x36x0.825	Reinf. 1 Compression	81.1%	Pass
19 - 18.75	Pole + Reinf.	TP36x36x0.975	Reinf. 1 Compression	68.7%	Pass
18.75 - 18.5	Pole + Reinf.	TP36x36x0.975	Reinf. 1 Compression	69.0%	Pass
18.5 - 18.25	Pole + Reinf.	TP36x36x0.925	Reinf. 1 Compression	70.8%	Pass
18.25 - 13.25	Pole + Reinf.	TP36x36x0.925	Reinf. 1 Compression	76.3%	Pass
13.25 - 12.7	Pole + Reinf.	TP36x36x0.925	Reinf. 1 Compression	76.9%	Pass
12.7 - 12.45	Pole + Reinf.	TP36x36x0.9	Reinf. 1 Compression	80.1%	Pass
12.45 - 11.5	Pole + Reinf.	TP36x36x0.9	Reinf. 1 Compression	81.2%	Pass
11.5 - 11.25	Pole + Reinf.	TP36x36x0.9	Reinf. 4 Compression	71.8%	Pass
11.25 - 10.5	Pole + Reinf.	TP36x36x0.9	Reinf. 4 Compression	72.6%	Pass
10.5 - 10.25	Pole + Reinf.	TP36x36x1.325	Reinf. 24 Compression	68.4%	Pass
10.25 - 7.5	Pole + Reinf.	TP36x36x1.325	Reinf. 24 Compression	71.1%	Pass
7.5 - 7.25	Pole + Reinf.	TP36x36x1.4	Reinf. 24 Compression	69.0%	Pass
7.25 - 6.25	Pole + Reinf.	TP36x36x1.4	Reinf. 24 Compression	69.9%	Pass
6.25 - 6	Pole + Reinf.	TP36x36x1.4	Reinf. 24 Compression	70.2%	Pass
6 - 3.73	Pole + Reinf.	TP36x36x1.725	Reinf. 24 Compression	60.4%	Pass
3.73 - 3.48	Pole + Reinf.	TP36x36x1.725	Reinf. 24 Compression	60.6%	Pass
3.48 - 2.75	Pole + Reinf.	TP36x36x1.725	Reinf. 24 Compression	61.2%	Pass
2.75 - 2.5	Pole + Reinf.	TP36x36x1.675	Reinf. 24 Compression	65.6%	Pass
2.5 - 2	Pole + Reinf.	TP36x36x1.675	Reinf. 24 Compression	66.1%	Pass
2 - 1.75	Pole + Reinf.	TP36x36x1.425	Reinf. 24 Compression	73.6%	Pass
1.75 - 0	Pole + Reinf.	TP36x36x1.425	Reinf. 24 Compression	75.3%	Pass
				Summary	
			Pole	75.0%	Pass
			Reinforcement	81.7%	Pass
			Overall	81.7%	Pass

# Additional Calculations

Section Elevation (ft)	Moment of Inertia (in <sup>4</sup> )			Area (in <sup>2</sup> )			% Capacity*																												
	Pole	Reinf.	Total	Pole	Reinf.	Total	Pole	R1	R2	R3	R4	R5	R6	R7	R8	R9	R10	R11	R12	R13	R14	R15	R16	R17	R18	R19	R20	R21	R22	R23	R24	R25			
118 - 113	1315	n/a	1315	18.65	n/a	18.65	2.5%																												
113 - 108	1315	n/a	1315	18.65	n/a	18.65	7.1%																												
108 - 103	1315	n/a	1315	18.65	n/a	18.65	18.1%																												
103 - 98	1315	n/a	1315	18.65	n/a	18.65	28.7%																												
98 - 93	1315	n/a	1315	18.65	n/a	18.65	45.4%																												
93 - 90	1315	n/a	1315	18.65	n/a	18.65	55.2%																												
90 - 85	1942	n/a	1942	27.83	n/a	27.83	46.0%																												
85 - 80	1942	n/a	1942	27.83	n/a	27.83	61.7%																												
80 - 76.5	1942	n/a	1942	27.83	n/a	27.83	72.3%																												
76.5 - 76.25	1943	1016	2959	27.83	13.50	41.33	48.2%																			52.5%									
76.25 - 74	1943	1016	2959	27.83	13.50	41.33	52.7%																			57.4%									
74 - 73.75	1946	2432	4377	27.83	33.45	61.28	36.7%				56.9%															42.1%									
73.75 - 68.88	1946	2432	4377	27.83	33.45	61.28	43.9%				68.1%															50.3%									
68.88 - 68.63	1944	966	2909	27.83	13.50	41.33	65.7%															70.2%													
68.63 - 64.5	1944	966	2909	27.83	13.50	41.33	75.0%																												
64.5 - 64.25	1946	3035	4980	27.83	42.45	70.28	44.7%																												
64.25 - 63	1946	3035	4980	27.83	42.45	70.28	46.4%				69.5%						53.1%																		
63 - 62.75	1946	2881	4827	27.83	40.20	68.03	48.3%				72.1%						55.1%																		
62.75 - 60	1946	2881	4827	27.83	40.20	68.03	52.6%				74.9%						57.4%										58.0%								
60 - 59.75	3835	2908	6743	34.90	29.47	64.37	49.3%			51.8%																									
59.75 - 54.75	3835	2908	6743	34.90	29.47	64.37	56.9%			59.8%																									
54.75 - 49.75	3835	2908	6743	34.90	29.47	64.37	64.6%			67.9%																									
49.75 - 49.25	3835	2908	6743	34.90	29.47	64.37	65.4%			68.7%																									
49.25 - 49	3865	4725	8590	34.90	35.47	70.37	53.7%			63.3%															61.6%										
49 - 44	3865	4725	8590	34.90	35.47	70.37	60.1%			70.8%															68.9%										
44 - 42	3865	4725	8590	34.90	35.47	70.37	62.7%			73.8%															71.9%										
42 - 41.75	3853	5807	9660	34.90	44.47	79.37	55.4%			65.3%									64.2%						63.1%										
41.75 - 36.75	3853	5807	9660	34.90	44.47	79.37	61.1%			72.0%									70.9%						69.6%										
36.75 - 34.5	3853	5807	9660	34.90	44.47	79.37	63.7%			75.1%									73.9%						72.6%										
34.5 - 34.25	3830	6099	9929	34.90	53.47	88.37	59.5%			66.4%									67.3%						66.4%										
34.25 - 34	3830	6099	9929	34.90	53.47	88.37	59.7%			66.7%									67.2%						66.7%										
34 - 33.75	3843	5260	9103	34.90	44.47	79.37	67.6%			75.0%									75.8%						75.0%										
33.75 - 30	3843	5260	9103	34.90	44.47	79.37	72.2%			80.2%															80.2%										
30 - 29.75	6661	5382	12043	41.97	37.97	79.94	65.8%	73.4%																		62.6%	61.6%								
29.75 - 28.5	6661	5382	12043	41.97	37.97	79.94	67.2%	75.0%																		64.0%	62.9%								
28.5 - 28.25	6662	7690	14352	41.97	51.47	93.44	56.9%	62.3%																		57.6%	55.3%	54.7%							
28.25 - 23.25	6662	7690	14352	41.97	51.47	93.44	61.8%	67.7%																	62.6%	60.1%	59.5%								
23.25 - 23	6697	9842	16539	41.97	63.47	105.44	55.8%	63.6%																	57.2%	52.5%	53.5%								
23 - 21.5	6697	9842	16539	41.97	63.47	105.44	57.2%	65.2%																	49.1%	53.8%	54.8%								
21.5 - 21.25	6724	7313	14037	41.97	49.97	91.94	68.7%	78.2%																	57.1%	61.6%	62.4%								
21.25 - 19	6724	7313	14037	41.97	49.97	91.94	71.1%	81.1%																	59.1%	63.8%	64.6%								
19 - 18.75	6701	9731	16433	41.97	63.47	105.44	60.3%	68.7%																	51.2%	55.4%	55.3%								
18.75 - 18.5	6701	9731	16433	41.97	63.47	105.44	60.5%	69.0%			57.5%														51.4%	55.6%	55.5%								
18.5 - 18.25	6681	8998	15679	41.97	54.97	96.94	62.8%	70.8%																	54.9%										
18.25 - 13.25	6681	8998	15679	41.97	54.97	96.94	67.6%	76.3%																	59.2%										
13.25 - 12.7	6681	8998	15679	41.97	54.97	96.94	68.2%	76.9%																	59.7%										
12.7 - 12.45	6696	8570	15266	41.97	55.47	97.44	71.1%	80.1%					65.6%												60.5%										
12.45 - 11.5	6696	8570	15266	41.97	55.47	97.44	72.0%	81.2%					66.5%												61.3%										
11.5 - 11.25	6664	8760	15424	41.97	64.22	106.19	69.3%	70.2%					71.8%												57.8%										
11.25 - 10.5	6664	8760	15424	41.97	64.22	106.19	70.1%	71.0%					72.6%												58.5%									43.0%	
10.5 - 10.25	6738	15243	21981	41.97	79.22	121.19	52.3%	62.3%					62.6%												48.2%										
10.25 - 7.5	6738	15243	21981	41.97	79.22	121.19	54.4%	64.8%					57.3%												50.1%							44.0%	68.4%		
7.5 - 7.25	6661	16114	22775	41.97	84.05	126.02	49.4%	67.3%					53.4%												47.5%										
7.25 - 6.25	6661	16114	22775	41.97	84.05	126.02	50.1%	68.2%					54.1%												48.2%										
6.25 - 6	6661	16114	22775	41.97	84.05	126.02	50.3%	68.4%					53.3%												48.3%										
6 - 3.73	6660	20955	27615	41.97	90.51	132.48	43.1%						46.7%												43.5%										
3.73 - 3.48	6660	20955	27615	41.97	90.51	132.48	43.3%						46.8%												50.4%	39.0%									
3.48 - 2.75	6660	20955	27615	41.97	90.51	132.48	43.7%						47.3%												44.1%										
2.75 - 2.5	6662	19845	26507	41.97	78.51	120.48	46.3%						52.6%																						

## Welded-Plate Monopole Bridge Stiffeners per TIA-222-H

### Site Data

BU#: 876331  
Site Name: NEW BRITAIN GRAVEL PIT  
Order #: 556610 Rev. 0

### Factored Loads at Splice Elevation

Moment:	221.04	ft-kips
Axial:	12.01	kips
Shear:	13.66	kips

Elevation:	90	ft
------------	----	----

### Splice Bolt Data

Quantity:	20	
Bolt Diameter:	1	in
Bolt Circle:	28	in

### Pole Data

Upper Diam:	24	in
Upper Thickness:	0.25	in
Lower Diam:	24	in
Lower Thickness:	0.375	in
Pipe Steel (Fy):	42	ksi

### Bridge Stiffener Data

Quantity:	3	
Total Length:	60.0	in
Plate Thickness:	1.250	in
Steel Grade (Fy):	65.0	ksi
Steel Ultimate (Fu):	80.0	ksi
Weld Type:	Fillet (both sides)	
Weld Size:	0.375	in
Weld Strength:	70	ksi
Upper Weld Length:	39	in
Upper Weld, C:	3.5962	Table 8-4
Upper Plate Width:	4.5	in
Lower Weld Length:	18.7	in
Lower Weld, C:	3.5962	Table 8-4
Lower Plate Width:	4.5	in
Gap PL Length:	2.3	in
Gap PL Width:	4.5	in

### Stress Increase Factor

ASIF:	1.000	
-------	-------	--

### Stiffener Results 19.9%

Maximum Compression:	65.4	kips
Allowable Compression:	327.8	kips
Compression Stress Ratio:	19.9%	
Maximum Tension:	65.4	kips
Allowable Tension:	329.1	kips
Tension Stress Ratio:	19.9%	
Maximum Flexure:	147.1	in.kips
Allowable Flexure:	4261.8	in.kips
Bending&Shear Stress Ratio:	2.9%	

### Weld Results 21.6%

Upper Weld Eccentric Load:	65.36	kip
Allowable Weld Strength:	631.13	kip
Upper Weld Strength Ratio:	10.4%	
Upper Weld Eccentric Load:	65.36	kip
Allowable Weld Strength:	302.62	kip
Lower Weld Strength Ratio:	21.6%	

### Pole Results 8.9%

Punching Shear Stress:	2.52	kip/in
Allowable Punching Stress:	28.35	kip/in
Punching Shear Stress Ratio:	8.9%	

### Loads to Use to Check Flange and Bolts w / CCIPlate

Moment:	105	ft.kips
Axial:	12.0	kips
Shear:	13.7	kips

# Monopole Flange Plate Connection

Elevation = 90 ft.



BU #	876331
Site Name	EW BRITAIN GRAVEL P
Order #	556610 Rev. 0

Applied Loads	
Moment (kip-ft)	105.00
Axial Force (kips)	12.01
Shear Force (kips)	13.66

TIA-222 Revision	H
------------------	---

\*TIA-222-H Section 15.5 Applied

Top Plate - External

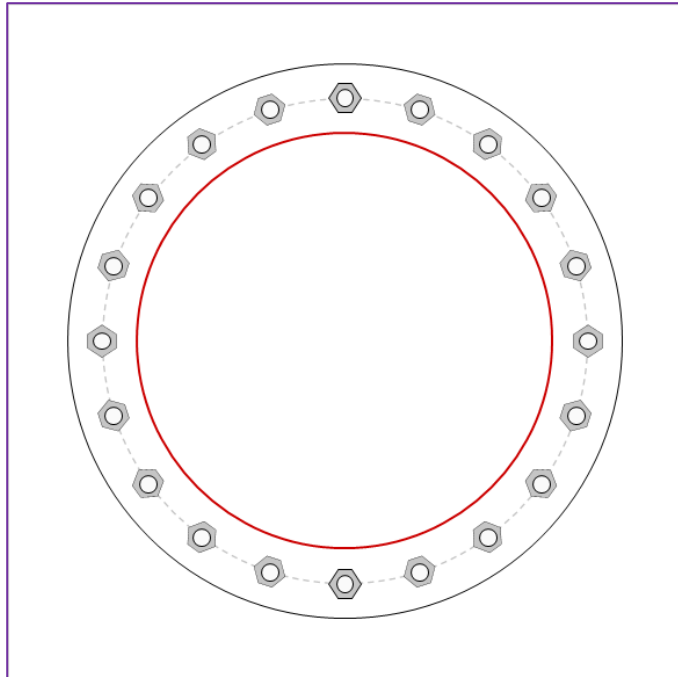

Bottom Plate - External

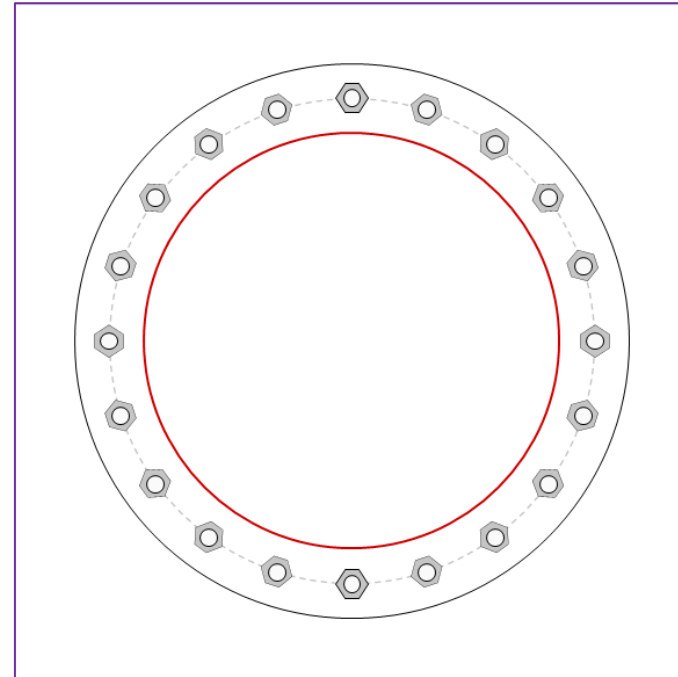

### Connection Properties

#### Bolt Data

(20) 1"  $\phi$  bolts (A325 N; Fy=92 ksi, Fu=120 ksi) on 28" BC

#### Top Plate Data

32" OD x 1.5" Plate (A36; Fy=36 ksi, Fu=58 ksi)

#### Bottom Plate Data

32" OD x 1.5" Plate (A36; Fy=36 ksi, Fu=58 ksi)

#### Top Stiffener Data

N/A

#### Bottom Stiffener Data

N/A

#### Top Pole Data

24" x 0.25" round pole (A572-42; Fy=42 ksi, Fu=60 ksi)

#### Bottom Pole Data

24" x 0.375" round pole (A572-42; Fy=42 ksi, Fu=60 ksi)

### Analysis Results

#### Bolt Capacity

Max Load (kips)	8.39
Allowable (kips)	54.53
Stress Rating:	<b>14.7% Pass</b>

#### Top Plate Capacity

Max Stress (ksi):	5.33	(Flexural)
Allowable Stress (ksi):	32.40	
Stress Rating:	<b>15.7%</b>	<b>Pass</b>
Tension Side Stress Rating:	<b>6.3%</b>	<b>Pass</b>

#### Bottom Plate Capacity

Max Stress (ksi):	5.33	(Flexural)
Allowable Stress (ksi):	32.40	
Stress Rating:	<b>15.7%</b>	<b>Pass</b>
Tension Side Stress Rating:	<b>6.3%</b>	<b>Pass</b>

## Welded-Plate Monopole Bridge Stiffeners per TIA-222-H

### Site Data

BU#: 876331  
Site Name: NEW BRITAIN GRAVEL PIT  
Order #: 556610 Rev. 0

### Factored Loads at Splice Elevation

Moment:	815.42	ft-kips
Axial:	25.98	kips
Shear:	25.11	kips

Elevation:	60	ft
------------	----	----

### Splice Bolt Data

Quantity:	12	
Bolt Diameter:	1.5	in
Bolt Circle:	35.5	in

### Pole Data

Upper Diam:	24	in
Upper Thickness:	0.375	in
Lower Diam:	30	in
Lower Thickness:	0.375	in
Pipe Steel (Fy):	42	ksi

### Bridge Stiffener Data

Quantity:	6	
Total Length:	60.0	in
Plate Thickness:	1.000	in
Steel Grade (Fy):	65.0	ksi
Steel Ultimate (Fu):	80.0	ksi
Weld Type:	Fillet (both sides)	
Weld Size:	0.375	in
Weld Strength:	70	ksi
Upper Weld Length:	23.25	in
Upper Weld, C:	2.469	Table 8-4
Upper Plate Width:	3	in
Lower Weld Length:	20	in
Lower Weld, C:	2.7675	Table 8-4
Lower Plate Width:	3	in
Gap PL Length:	16.8	in
Gap PL Width:	3	in

### Stress Increase Factor

ASIF:	1.000	
-------	-------	--

### Stiffener Results 62.4%

Maximum Compression:	79.6	kips
Allowable Compression:	127.4	kips
Compression Stress Ratio:	62.4%	
Maximum Tension:	79.6	kips
Allowable Tension:	175.5	kips
Tension Stress Ratio:	45.3%	
Maximum Flexure:	119.3	in.kips
Allowable Flexure:	5270.5	in.kips
Bending&Shear Stress Ratio:	2.4%	

### Weld Results 31.9%

Upper Weld Eccentric Load:	79.56	kip
Allowable Weld Strength:	258.32	kip
Upper Weld Strength Ratio:	30.8%	
Upper Weld Eccentric Load:	79.56	kip
Allowable Weld Strength:	249.08	kip
Lower Weld Strength Ratio:	31.9%	

### Pole Results 4.7%

Punching Shear Stress:	1.32	kip/in
Allowable Punching Stress:	28.35	kip/in
Punching Shear Stress Ratio:	4.7%	

### Loads to Use to Check Flange and Bolts w / CCIPlate

Moment:	547	ft.kips
Axial:	26.0	kips
Shear:	25.1	kips

# Monopole Flange Plate Connection

Elevation = 60 ft.



BU #	876331
Site Name	EW BRITAIN GRAVEL P
Order #	556610 Rev. 0

Applied Loads	
Moment (kip-ft)	547.00
Axial Force (kips)	25.98
Shear Force (kips)	25.11

TIA-222 Revision	H
------------------	---

\*TIA-222-H Section 15.5 Applied

Top Plate - External

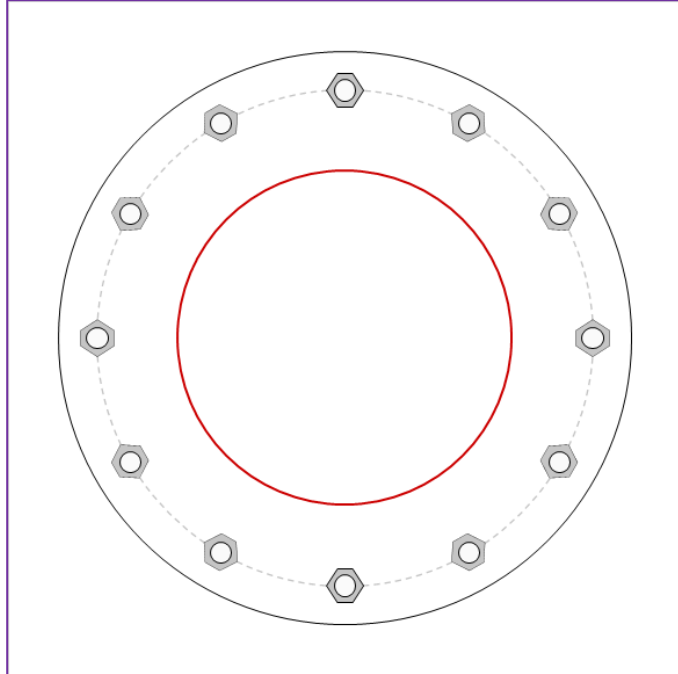

Bottom Plate - External

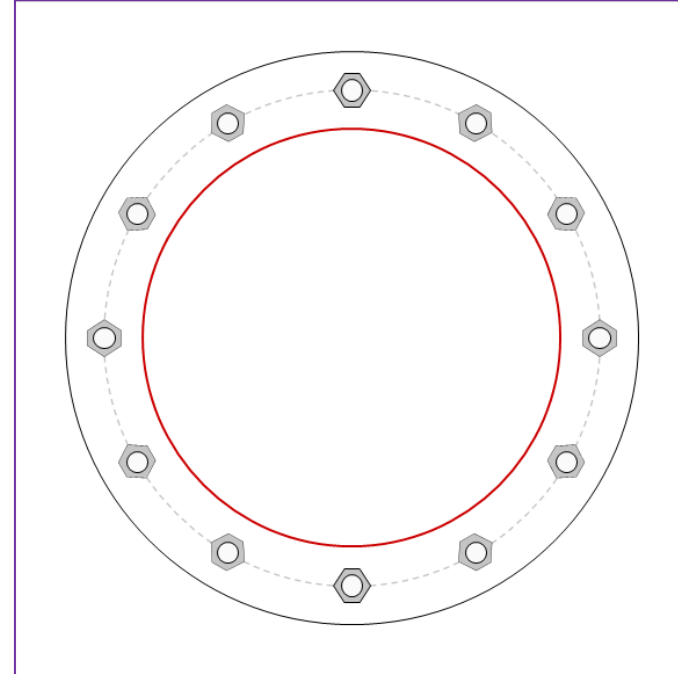

### Connection Properties

#### Bolt Data

(12) 1-1/2"  $\phi$  bolts (A325 N; Fy=81 ksi, Fu=120 ksi) on 35.5" BC

#### Top Plate Data

41" OD x 2" Plate (A36; Fy=36 ksi, Fu=58 ksi)

#### Top Stiffener Data

N/A

#### Top Pole Data

24" x 0.375" round pole (A572-42; Fy=42 ksi, Fu=60 ksi)

#### Bottom Plate Data

41" OD x 2" Plate (A36; Fy=36 ksi, Fu=58 ksi)

#### Bottom Stiffener Data

N/A

#### Bottom Pole Data

30" x 0.375" round pole (A572-42; Fy=42 ksi, Fu=60 ksi)

### Analysis Results

#### Bolt Capacity

Max Load (kips)	59.43
Allowable (kips)	126.86
Stress Rating:	<b>44.6%</b> Pass

#### Top Plate Capacity

Max Stress (ksi):	28.32	(Flexural)
Allowable Stress (ksi):	32.40	
Stress Rating:	<b>83.3%</b>	Pass
Tension Side Stress Rating:	<b>49.2%</b>	Pass

#### Bottom Plate Capacity

Max Stress (ksi):	13.94	(Flexural)
Allowable Stress (ksi):	32.40	
Stress Rating:	<b>41.0%</b>	Pass
Tension Side Stress Rating:	<b>15.3%</b>	Pass

## Welded-Plate Monopole Bridge Stiffeners per TIA-222-H

### Site Data

BU#: 876331  
Site Name: NEW BRITAIN GRAVEL PIT  
Order #: 556610 Rev. 0

### Factored Loads at Splice Elevation

Moment:	1613.51	ft-kips
Axial:	38.28	kips
Shear:	28.54	kips

Elevation:	30	ft
------------	----	----

### Splice Bolt Data

Quantity:	16	
Bolt Diameter:	1.5	in
Bolt Circle:	41.5	in

### Pole Data

Upper Diam:	30	in
Upper Thickness:	0.375	in
Lower Diam:	36	in
Lower Thickness:	0.375	in
Pipe Steel (Fy):	42	ksi

### Bridge Stiffener Data

Quantity:	6	
Total Length:	60.0	in
Plate Thickness:	1.000	in
Steel Grade (Fy):	65.0	ksi
Steel Ultimate (Fu):	80.0	ksi
Weld Type:	Fillet (both sides)	
Weld Size:	0.375	in
Weld Strength:	70	ksi
Upper Weld Length:	32.25	in
Upper Weld, C:	2.8133	Table 8-4
Upper Plate Width:	5.5	in
Lower Weld Length:	28.25	in
Lower Weld, C:	3.0481	Table 8-4
Lower Plate Width:	5.5	in
Gap PL Length:	-0.5	in
Gap PL Width:	5.5	in

### Stress Increase Factor

ASIF:	1.000	
-------	-------	--

### Stiffener Results 52.1%

Maximum Compression:	167.5	kips
Allowable Compression:	321.7	kips
Compression Stress Ratio:	52.1%	
Maximum Tension:	167.5	kips
Allowable Tension:	321.8	kips
Tension Stress Ratio:	52.1%	
Maximum Flexure:	460.6	in.kips
Allowable Flexure:	10140.6	in.kips
Bending&Shear Stress Ratio:	5.3%	

### Weld Results 43.2%

Upper Weld Eccentric Load:	167.49	kip
Allowable Weld Strength:	408.28	kip
Upper Weld Strength Ratio:	41.0%	
Upper Weld Eccentric Load:	167.49	kip
Allowable Weld Strength:	387.49	kip
Lower Weld Strength Ratio:	43.2%	

### Pole Results 9.4%

Punching Shear Stress:	2.66	kip/in
Allowable Punching Stress:	28.35	kip/in
Punching Shear Stress Ratio:	9.4%	

### Loads to Use to Check Flange and Bolts w / CCIPlate

Moment:	870	ft.kips
Axial:	38.3	kips
Shear:	28.5	kips

# Monopole Flange Plate Connection

Elevation = 30 ft.



BU #	876331
Site Name	EW BRITAIN GRAVEL P
Order #	556610 Rev. 0

Applied Loads	
Moment (kip-ft)	870.00
Axial Force (kips)	38.28
Shear Force (kips)	28.54

TIA-222 Revision	H
------------------	---

\*TIA-222-H Section 15.5 Applied

Top Plate - External

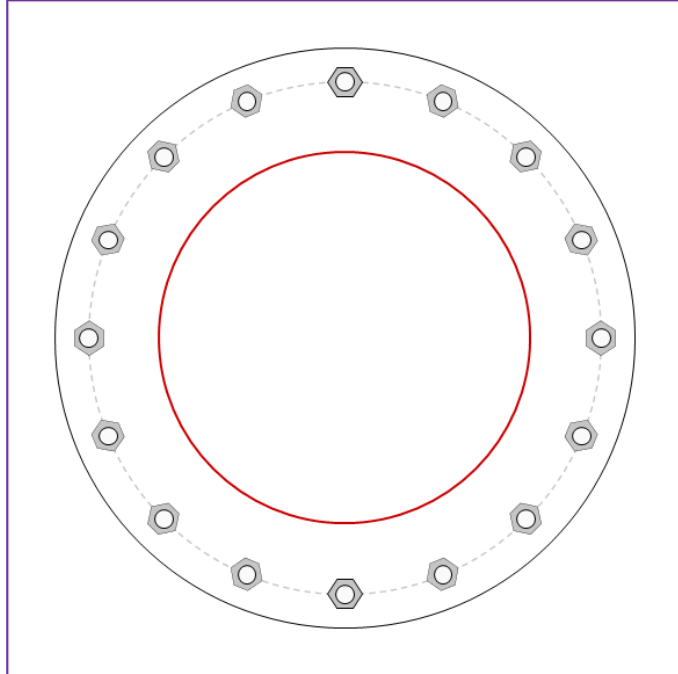

Bottom Plate - External

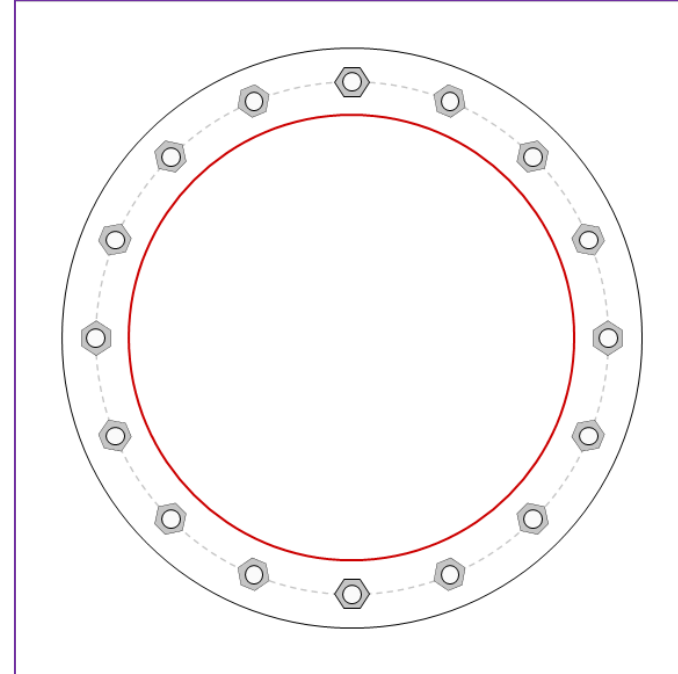

### Connection Properties

#### Bolt Data

(16) 1-1/2"  $\phi$  bolts (A325 N; Fy=81 ksi, Fu=120 ksi) on 41.5" BC

#### Top Plate Data

47" OD x 2" Plate (A36; Fy=36 ksi, Fu=58 ksi)

#### Bottom Plate Data

47" OD x 2" Plate (A36; Fy=36 ksi, Fu=58 ksi)

#### Top Stiffener Data

N/A

#### Bottom Stiffener Data

N/A

#### Top Pole Data

30" x 0.375" round pole (A572-42; Fy=42 ksi, Fu=60 ksi)

#### Bottom Pole Data

36" x 0.375" round pole (A572-42; Fy=42 ksi, Fu=60 ksi)

### Analysis Results

#### Bolt Capacity

Max Load (kips)	60.47
Allowable (kips)	126.87
Stress Rating:	<b>45.4% Pass</b>

#### Top Plate Capacity

Max Stress (ksi):	32.49	(Flexural)
Allowable Stress (ksi):	32.40	
Stress Rating:	<b>95.5%</b>	<b>Pass</b>
Tension Side Stress Rating:	<b>53.9%</b>	<b>Pass</b>

#### Bottom Plate Capacity

Max Stress (ksi):	15.55	(Flexural)
Allowable Stress (ksi):	32.40	
Stress Rating:	<b>45.7%</b>	<b>Pass</b>
Tension Side Stress Rating:	<b>17.5%</b>	<b>Pass</b>



# Monopole Base Plate Connection



Site Info	
BU #	876331
Site Name	EW BRITAIN GRAVEL P
Order #	556610 Rev. 0

Analysis Considerations	
TIA-222 Revision	H
Grout Considered:	See Custom Sheet
$l_{ar}$ (in)	See Custom Sheet

Applied Loads	
Moment (kip-ft)	2536.29
Axial Force (kips)	54.67
Shear Force (kips)	32.62

\*TIA-222-H Section 15.5 Applied

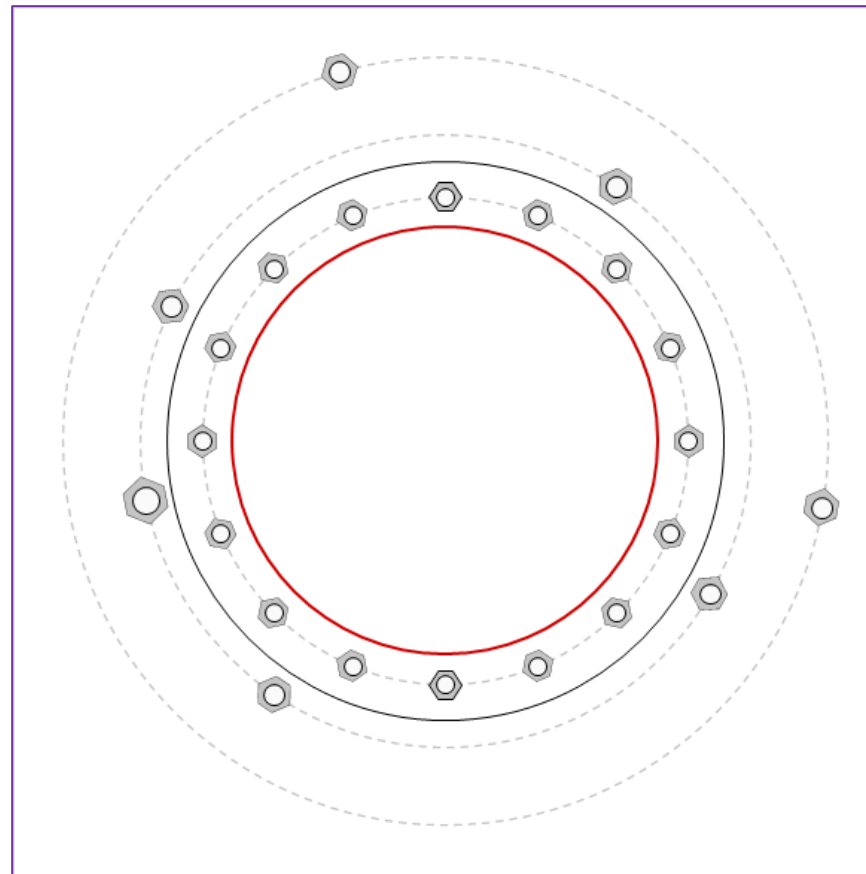

Connection Properties	Analysis Results
-----------------------	------------------

Anchor Rod Data
GROUP 1: (16) 1-1/2" $\phi$ bolts (A354-BC N; $F_y=109$ ksi, $F_u=125$ ksi) on 41" BC
GROUP 2: (4) 1-3/4" $\phi$ bolts (Williams R71 N; $F_y=127.7$ ksi, $F_u=125$ ksi) on 51.5" BC <i>pos. (deg): 56, 154, 236, 330</i>
GROUP 3: (1) 2-1/4" $\phi$ bolts (A193 Gr. B7 N; $F_y=105$ ksi, $F_u=125$ ksi) on 51.5" BC <i>pos. (deg): 191.3</i>
GROUP 4: (2) 1-3/4" $\phi$ bolts (Williams R71 N; $F_y=127.7$ ksi, $F_u=125$ ksi) on 64.5" BC <i>pos. (deg): 106, 350</i>
Base Plate Data
47" OD x 2" Plate (A36; $F_y=36$ ksi, $F_u=58$ ksi)
Stiffener Data
N/A
Pole Data
36" x 0.375" round pole (A572-42; $F_y=42$ ksi, $F_u=60$ ksi)

Anchor Rod Summary	<i>(units of kips, kip-in)</i>		
GROUP 1:	$P_{u\_t} = 89.15$	$\phi P_{n\_t} = 132.19$	<b>Stress Rating</b>
	$V_u = 2.04$	$\phi V_n = 82.83$	<b>64.2%</b>
	$M_u = n/a$	$\phi M_n = n/a$	<b>Pass</b>
GROUP 2:	$P_{u\_t} = 201.69$	$\phi P_{n\_t} = 254.06$	<b>Stress Rating</b>
	$V_u = 0$	$\phi V_n = 127.03$	<b>75.6%</b>
	$M_u = n/a$	$\phi M_n = n/a$	<b>Pass</b>
GROUP 3:	$P_{u\_t} = 194.82$	$\phi P_{n\_t} = 304.69$	<b>Stress Rating</b>
	$V_u = 0$	$\phi V_n = 186.38$	<b>60.9%</b>
	$M_u = n/a$	$\phi M_n = n/a$	<b>Pass</b>
GROUP 4:	$P_{u\_t} = 178.3$	$\phi P_{n\_t} = 178.13$	<b>Stress Rating</b>
	$V_u = 0$	$\phi V_n = 112.75$	<b>95.4%</b>
	$M_u = n/a$	$\phi M_n = n/a$	<b>Pass</b>
Base Plate Summary			
Max Stress (ksi):	20.19	(Flexural)	
Allowable Stress (ksi):	32.4		
Stress Rating:	<b>59.3%</b>		<b>Pass</b>

# CCiplate

Elevation (ft) 0 (Base)

note: Bending interaction not considered when Grout Considered = "Yes"

Bolt Group	Resist Axial	Resist Shear	Induce Plate Bending	Grout Considered	Apply at BARB Elevation	BARB CL Elevation (ft)
1	Yes	Yes	Yes	No	No	
2	Yes	No	No	No	No	
3	Yes	No	No	No	No	
4	No	No	No	No	No	

## Custom Bolt Connection

Bolt	Bolt Group ID	Location (deg.)	Diameter (in)	Material	Bolt Circle (in)	Eta Factor, $\eta$ :	$I_{ar}$ (in):	Thread Type	Area Override, in <sup>2</sup>	Tension Only
1	1	0	1.5	A354-BC	41	0.5	1.5	N-Included		No
2	1	22.5	1.5	A354-BC	41	0.5	1.5	N-Included		No
3	1	45	1.5	A354-BC	41	0.5	1.5	N-Included		No
4	1	67.5	1.5	A354-BC	41	0.5	1.5	N-Included		No
5	1	90	1.5	A354-BC	41	0.5	1.5	N-Included		No
6	1	112.5	1.5	A354-BC	41	0.5	1.5	N-Included		No
7	1	135	1.5	A354-BC	41	0.5	1.5	N-Included		No
8	1	157.5	1.5	A354-BC	41	0.5	1.5	N-Included		No
9	1	180	1.5	A354-BC	41	0.5	1.5	N-Included		No
10	1	202.5	1.5	A354-BC	41	0.5	1.5	N-Included		No
11	1	225	1.5	A354-BC	41	0.5	1.5	N-Included		No
12	1	247.5	1.5	A354-BC	41	0.5	1.5	N-Included		No
13	1	270	1.5	A354-BC	41	0.5	1.5	N-Included		No
14	1	292.5	1.5	A354-BC	41	0.5	1.5	N-Included		No
15	1	315	1.5	A354-BC	41	0.5	1.5	N-Included		No
16	1	337.5	1.5	A354-BC	41	0.5	1.5	N-Included		No
17	2	56	1.75	Williams R71	51.5	0.5	0	N-Included	2.71	No
18	2	154	1.75	Williams R71	51.5	0.5	0	N-Included	2.71	No
19	2	236	1.75	Williams R71	51.5	0.5	0	N-Included	2.71	No
20	2	330	1.75	Williams R71	51.5	0.5	0	N-Included	2.71	No
21	3	191.3	2.25	A193 Gr. B7	51.5	0.5	0	N-Included		No
22	4	106	1.75	Williams R71	64.5	0.5	0	N-Included		No
23	4	350	1.75	Williams R71	64.5	0.5	0	N-Included		No

## Plot Graphic

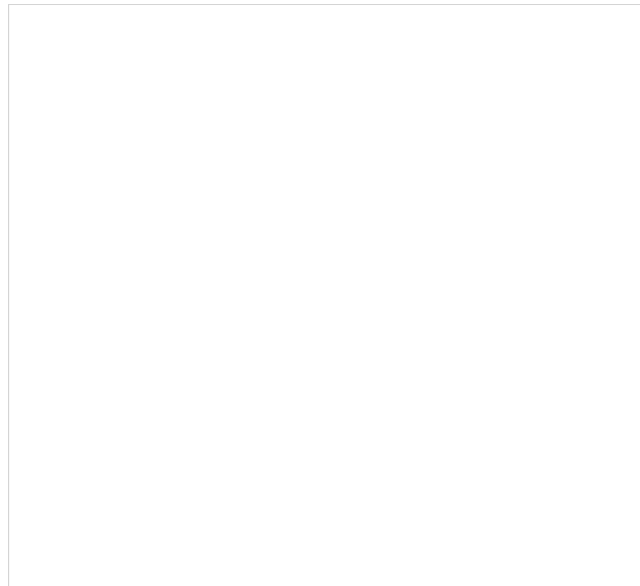
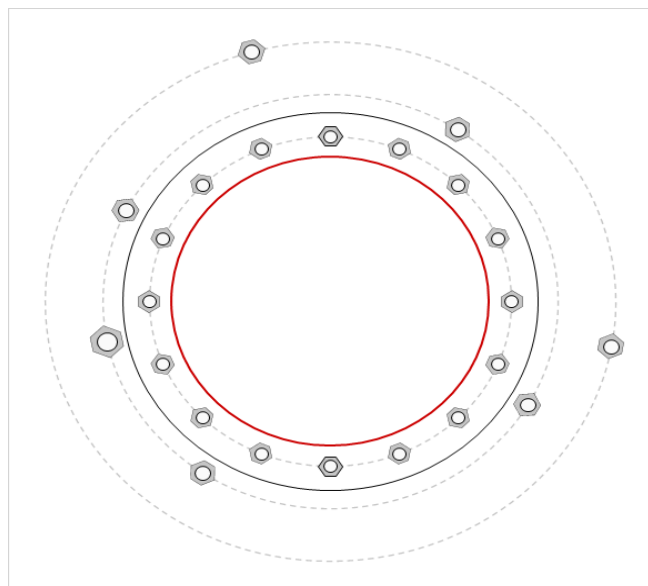

# Pier and Pad Foundation



**BU #:** 876331  
**Site Name:** NEW BRITAIN GR  
**App. Number:** 556610 Rev. 0

**TIA-222 Revision:** H  
**Tower Type:** Monopole

**Top & Bot. Pad Rein. Different?:**   
**Block Foundation?:**   
**Rectangular Pad?:**

Superstructure Analysis Reactions		
Compression, $P_{comp}$ :	54.68	kips
Base Shear, $V_{u\_comp}$ :	32.59	kips
Moment, $M_u$ :	2536.29	ft-kips
Tower Height, $H$ :	118	ft
BP Dist. Above Fdn, $bp_{dist}$ :	1.5	in
Bolt Circle / Bearing Plate Width, $BC$ :	41	in

Foundation Analysis Checks				
	Capacity	Demand	Rating*	Check
<i>Pad Flexure (kip*ft)</i>	4029.63	1741.53	<b>41.2%</b>	<b>Pass</b>
<i>Pad Shear - 1-way (kips)</i>	1064.77	319.64	<b>28.6%</b>	<b>Pass</b>
<i>Pad Shear - 2-way (Comp) (ksi)</i>	0.164	0.000	<b>0.0%</b>	<b>Pass</b>
<i>Flexural 2-way (Comp) (kip*ft)</i>	8059.26	0.00	<b>0.0%</b>	<b>Pass</b>

\*Rating per TIA-222-H Section 15.5

<b>Structural Rating*:</b>	<b>41.2%</b>
----------------------------	--------------

Pad Properties		
Depth, $D$ :	4	ft
Pad Width, $W_1$ :	16	ft
Pad Thickness, $T$ :	6	ft
Pad Rebar Size (Bottom dir. 2), $Sp_2$ :	8	
Pad Rebar Quantity (Bottom dir. 2), $mp_2$ :	17	
Pad Clear Cover, $cc_{pad}$ :	3	in

Material Properties		
Rebar Grade, $F_y$ :	60	ksi
Concrete Compressive Strength, $F'_c$ :	3	ksi
Dry Concrete Density, $\delta_c$ :	150	pcf

Soil Properties		
Total Soil Unit Weight, $\gamma$ :	150	pcf
Ultimate Gross Bearing, $Q_{ult}$ :	30.000	ksf
Cohesion, $C_u$ :	10.000	ksf
Friction Angle, $\phi$ :	0	degrees
SPT Blow Count, $N_{blows}$ :		
Base Friction, $\mu$ :	0.3	
Neglected Depth, $N$ :	0.00	ft
Foundation Bearing on Rock?	No	
Groundwater Depth, $gw$ :	N/A	ft

<--Toggle between Gross and Net

## Pile Foundation

Checks the capacity of pile foundation configurations for monopoles or self-support towers with individual foundations in Rev. F, G, and H.



<b>BU #:</b>	876331
<b>Site Name:</b>	NEW BRITAIN GRAVEL PIT
<b>Order:</b>	529723 Rev. 0

<b>Tower Type:</b>	Monopole
<b>TIA Revision:</b>	H

Top & Bot. Pad Rein. Different?:	<input type="checkbox"/>
----------------------------------	--------------------------

Factored Design Reactions At Base		
Moment, M:	2536.29	ft-kips
Axial, Pu:	0	kips
Shear, Sc:	0	kips
Load Eccentricity, Ecc:	0	in
Bolt Circle / Bearing Plate Width, BC:	41	in

Pile Properties		
Pile Shape:	Round	
Pile Material:	Steel	
Length of Pile, Lpile:	33	ft
Pile Diameter:	1.375	in
Pile (Soil) Capacity Given?	Yes	
Steel Grade, Fy:	150	ksi

Pile Group		
Group Configuration:	Asymmetric	
Orientation of Neutral Axis, θ:	0	deg
Group Efficiency Given in Geotech?	No	

Program Calculated Group Efficiency, Eg: 1.00

Pile Cap		
Cap Type:	Block	
Depth to Bottom of Block, D:	4.00	ft
Thickness of Block, T:	6.00	ft
Block Width, Wx:	16.00	ft
Block Length, Wy:	16.00	ft
Pad Rebar Size (Bot.), Spad:	8	
Pad Rebar Quantity (X-direction) (Bot.), Mpad:	17	
Pad Rebar Quantity (Y-direction) (Bot.), Mpad <sub>y</sub> :	17	

Material Properties		
Rebar Grade, Fy:	60	ksi
Concrete Strength, Fc:	3	ksi
Clear Cover, cc:	3	in

Soil Properties		
Groundwater Depth, GW:	100.00	ft
Soil Unit Weight:	150	pcf
Cohesion, Co:	10	ksf
Friction Angle, φ:	0	deg
Neglected Depth, ND:	1	ft
Negative Friction Force (per pile), Sw:		kips
SPT Blow Count, N <sub>blows</sub> :		

Design Checks				
	Capacity	Demand	Rating*	Check
<b>PILE CHECKS</b>				
Pile Tensile Strength (kips):	178.19	187.13	100.0%	Pass
<b>PAD CHECKS</b>				

\*Rating per TIA-222-H Section 15.5

Structural Rating:	<b>100.0%</b>
--------------------	---------------

[Click here to enter group information and pile coordinates](#)

Ultimate Pile Capacities		
Ultimate Compression, Cn:	170	kips
Ultimate Tension, Tn:	170	kips

Per CCI sites Doc. # 2268906

# Pier and Pad Foundation



**BU #:** 876331  
**Site Name:** NEW BRITAIN GR  
**App. Number:** 556610 Rev. 0

**TIA-222 Revision:** H  
**Tower Type:** Monopole

**Top & Bot. Pad Rein. Different?:**   
**Block Foundation?:**   
**Rectangular Pad?:**

Superstructure Analysis Reactions		
Compression, $P_{comp}$ :	54.68	kips
Base Shear, $V_{u\_comp}$ :	32.59	kips
Moment, $M_u$ :	0	ft-kips
Tower Height, $H$ :	118	ft
BP Dist. Above Fdn, $bp_{dist}$ :	1.5	in
Bolt Circle / Bearing Plate Width, $BC$ :	41	in

Foundation Analysis Checks				
	Capacity	Demand	Rating*	Check
<i>Lateral (Sliding) (kips)</i>	1030.28	32.59	3.0%	Pass
<i>Bearing Pressure (ksf)</i>	22.50	1.45	6.1%	Pass
<i>Overturning (kip*ft)</i>	1949.93	199.61	10.2%	Pass

\*Rating per TIA-222-H Section 15.5

Soil Rating*:	10.2%
---------------	-------

Pad Properties		
Depth, $D$ :	4	ft
Pad Width, $W_1$ :	16	ft
Pad Thickness, $T$ :	6	ft
Pad Rebar Size (Bottom dir. 2), $Sp_2$ :	8	
Pad Rebar Quantity (Bottom dir. 2), $mp_2$ :	17	
Pad Clear Cover, $cc_{pad}$ :	3	in

Material Properties		
Rebar Grade, $F_y$ :	60	ksi
Concrete Compressive Strength, $F'_c$ :	3	ksi
Dry Concrete Density, $\delta_c$ :	150	pcf

Soil Properties		
Total Soil Unit Weight, $\gamma$ :	150	pcf
Ultimate Gross Bearing, $Q_{ult}$ :	30.000	ksf
Cohesion, $C_u$ :	10.000	ksf
Friction Angle, $\phi$ :	0	degrees
SPT Blow Count, $N_{blows}$ :		
Base Friction, $\mu$ :	0.3	
Neglected Depth, $N$ :	0.00	ft
Foundation Bearing on Rock?	No	
Groundwater Depth, $gw$ :	N/A	ft

<--Toggle between Gross and Net

# ASCE 7 Hazards Report

**Address:**  
No Address at This Location

**Standard:** ASCE/SEI 7-10  
**Risk Category:** II  
**Soil Class:** D - Stiff Soil

**Elevation:** 350.25 ft (NAVD 88)  
**Latitude:** 41.676589  
**Longitude:** -72.821414

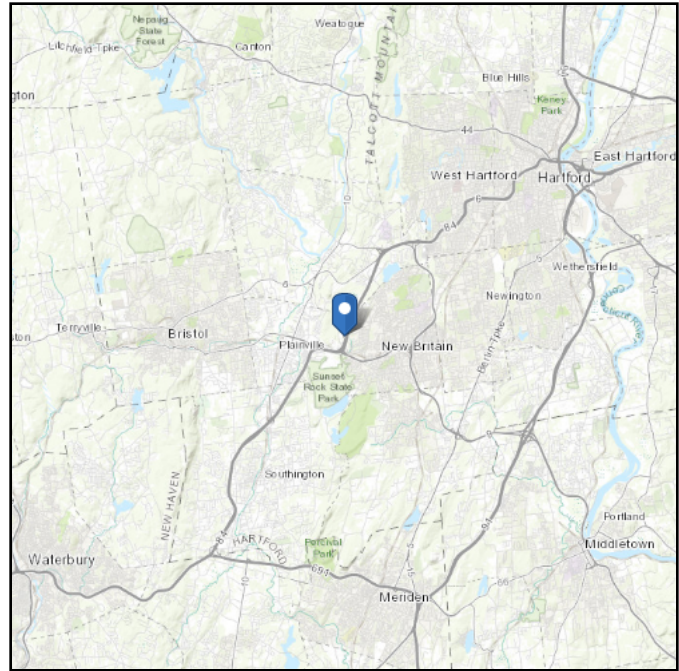
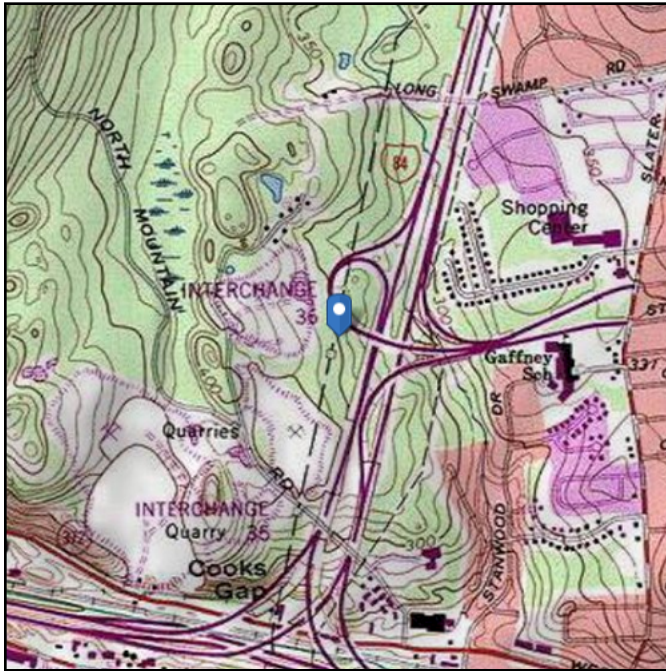

## Wind

### Results:

Wind Speed:	<b>125 Vmph</b>	<i>*wind speed per Appendix N</i>
10-year MRI	76 Vmph	
25-year MRI	86 Vmph	
50-year MRI	92 Vmph	
100-year MRI	99 Vmph	

**Data Source:** ASCE/SEI 7-10, Fig. 26.5-1A and Figs. CC-1–CC-4, incorporating errata of March 12, 2014

**Date Accessed:** Thu Oct 29 2020

Value provided is 3-second gust wind speeds at 33 ft above ground for Exposure C Category, based on linear interpolation between contours. Wind speeds are interpolated in accordance with the 7-10 Standard. Wind speeds correspond to approximately a 7% probability of exceedance in 50 years (annual exceedance probability = 0.00143, MRI = 700 years).

Site is in a hurricane-prone region as defined in ASCE/SEI 7-10 Section 26.2. Glazed openings need not be protected against wind-borne debris.

Mountainous terrain, gorges, ocean promontories, and special wind regions should be examined for unusual wind conditions.

**Site Soil Class:** D - Stiff Soil

**Results:**

$S_s$ :	0.183	$S_{DS}$ :	0.195
$S_1$ :	0.064	$S_{D1}$ :	0.102
$F_a$ :	1.6	$T_L$ :	6
$F_v$ :	2.4	PGA :	0.093
$S_{MS}$ :	0.293	PGA <sub>M</sub> :	0.149
$S_{M1}$ :	0.153	F <sub>PGA</sub> :	1.6
		$I_e$ :	1

**Seismic Design Category** B

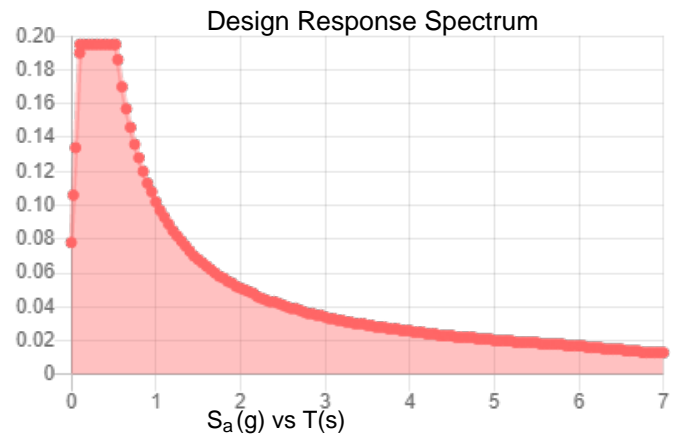
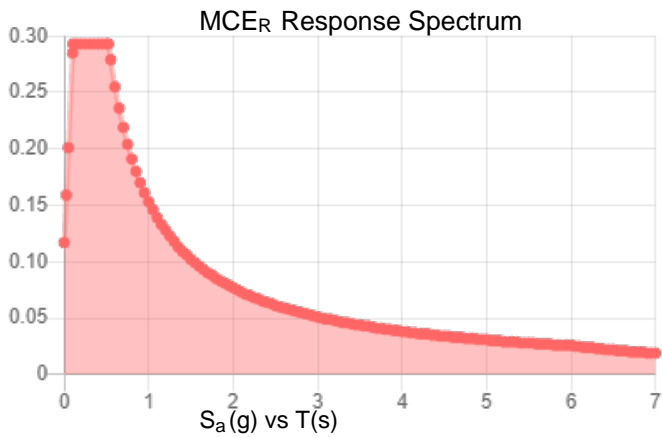

**Data Accessed:**

Thu Oct 29 2020

**Date Source:**

USGS Seismic Design Maps based on ASCE/SEI 7-10, incorporating Supplement 1 and errata of March 31, 2013, and ASCE/SEI 7-10 Table 1.5-2. Additional data for site-specific ground motion procedures in accordance with ASCE/SEI 7-10 Ch. 21 are available from USGS.

## Ice

---

**Results:**

Ice Thickness: 1.00 in.

Concurrent Temperature: 5 F

Gust Speed: 50 mph

**Data Source:** Standard ASCE/SEI 7-10, Figs. 10-2 through 10-8

**Date Accessed:** Thu Oct 29 2020

Ice thicknesses on structures in exposed locations at elevations higher than the surrounding terrain and in valleys and gorges may exceed the mapped values.

Values provided are equivalent radial ice thicknesses due to freezing rain with concurrent 3-second gust speeds, for a 50-year mean recurrence interval, and temperatures concurrent with ice thicknesses due to freezing rain. Thicknesses for ice accretions caused by other sources shall be obtained from local meteorological studies. Ice thicknesses in exposed locations at elevations higher than the surrounding terrain and in valleys and gorges may exceed the mapped values.

---

The ASCE 7 Hazard Tool is provided for your convenience, for informational purposes only, and is provided “as is” and without warranties of any kind. The location data included herein has been obtained from information developed, produced, and maintained by third party providers; or has been extrapolated from maps incorporated in the ASCE 7 standard. While ASCE has made every effort to use data obtained from reliable sources or methodologies, ASCE does not make any representations or warranties as to the accuracy, completeness, reliability, currency, or quality of any data provided herein. Any third-party links provided by this Tool should not be construed as an endorsement, affiliation, relationship, or sponsorship of such third-party content by or from ASCE.

ASCE does not intend, nor should anyone interpret, the results provided by this Tool to replace the sound judgment of a competent professional, having knowledge and experience in the appropriate field(s) of practice, nor to substitute for the standard of care required of such professionals in interpreting and applying the contents of this Tool or the ASCE 7 standard.

In using this Tool, you expressly assume all risks associated with your use. Under no circumstances shall ASCE or its officers, directors, employees, members, affiliates, or agents be liable to you or any other person for any direct, indirect, special, incidental, or consequential damages arising from or related to your use of, or reliance on, the Tool or any information obtained therein. To the fullest extent permitted by law, you agree to release and hold harmless ASCE from any and all liability of any nature arising out of or resulting from any use of data provided by the ASCE 7 Hazard Tool.