

## De-humming a Hammond B-3 Organ

### 1 Issue

For most hammond enthusiasts, it is quite a “must” to own at least one of the famous “B-3” organs. I also have one of these. Triggered by the question of email friend Jac van de Walle, I took some audio recordings of its sound and this was the starting point of it all.

His ears are very critical, so he immediately heard the small amount of hum in the background of the audio file. He responded, that his own organ would have a better performance regarding hum and noise. Damn! So this story started. :-)



figure 1: my Hammond B-3

I have to admit, that my hammond organ actually is noticeably humming, if volume swell is in “volume max“ position. Frankly speaking I never had a problem with that so far, because in this position the organ is so loudly playing that even the windows in my music room are starting to oscillate ;-)

 and I guess many other organs are much worse than this, but nevertheless it’s gonna be an interesting project to evaluate the reason for this noise.

And it is finally a matter of honour for an electronics engineer not to stop until the root cause for this humming is found.

The first hint is, that the noticed hum is obviously “pulsating”- probably by the scanner frequency of around 7Hz. With this small observation I start my next project.

## 2 First measurements

The first action that I take is to measure directly on the output terminal “G” of AO28 pre-amplifier. So we can see, if the hum is coming from the organ itself or the connected type 122 leslie speaker. This is the measuring setup; I used a Brüel&Kjaer 2606 and a Rigol DS1052.



figure 2: Hammond B-3 and Brüel&Kjaer 2606 measuring amplifier

And this is, what I got:

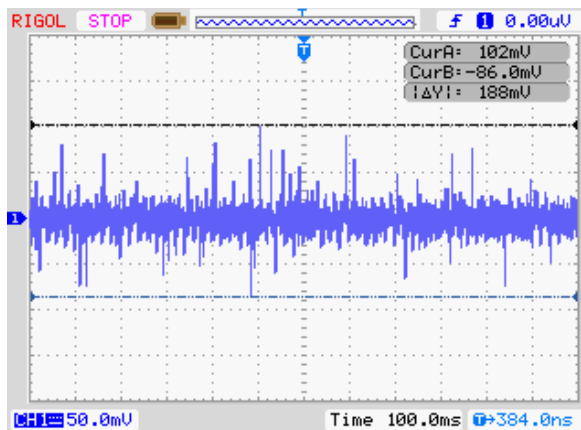

figure 3: noise level @ volume min

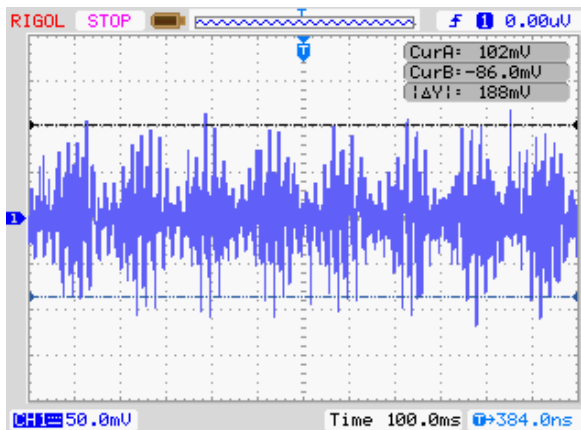

figure 4: noise level @ volume max

## 2.1 Interpretation

The peak-to-peak measurement with the markers of the oscilloscope is almost equal between volume = min (see figure 3) and volume = max (see figure 4); although there is clearly an increasing of 50Hz hum hearable! Reason for that is: the peak-to-peak level is not dominated by the hum, but by high radiofrequency (RF) peaks, produced by the digital 115V PWM frequency converter that I use to generate the 60Hz for the tonewheel generator!

## 3 RF interference

The observed RF interference is looking like that:

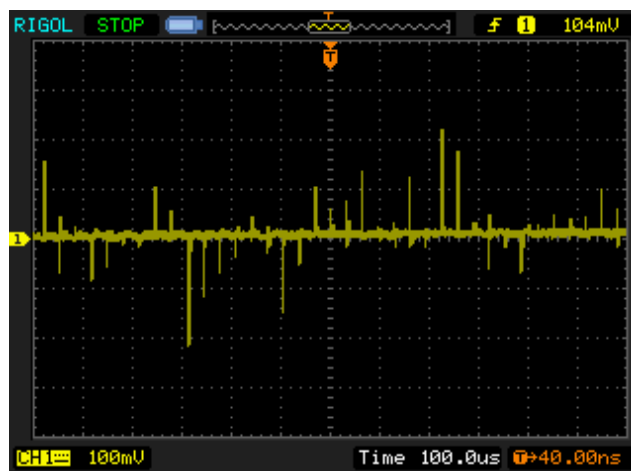

figure 5: RF interference at output terminal G

There is a burst frequency that can be determined to ~30kHz:

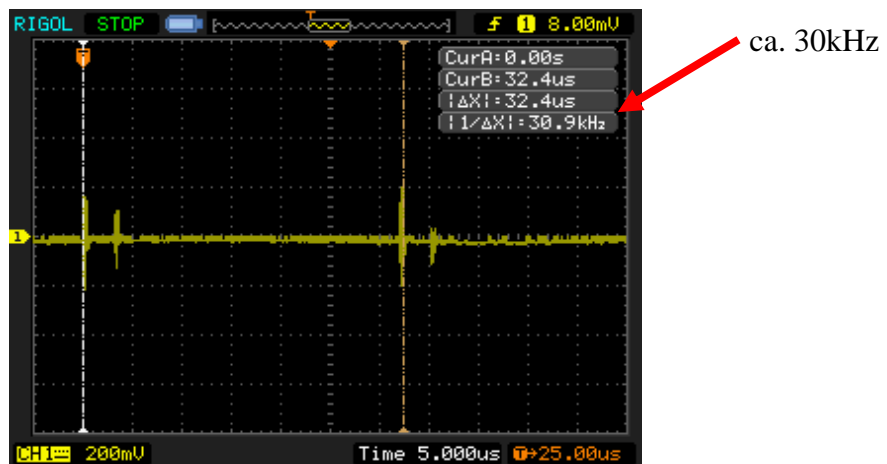

figure 6: burst frequency is around 30kHz

The burst itself contains RF energy with a frequency of ~26MHz.

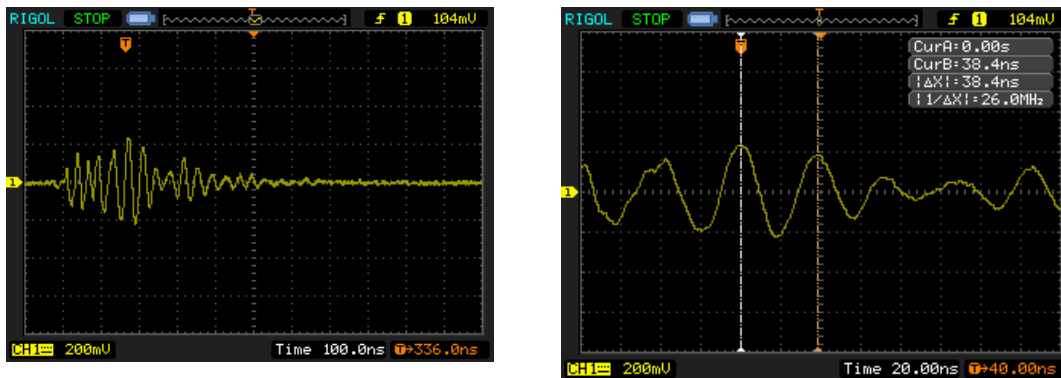

figure 7: one of the RF bursts in detail

Although this observation is not much encouraging, it is probably not the root cause of the hearable hum out of the leslie speakers. Even the PWM burst frequency with its ~30kHz repetition rate is much higher than a human's ear can record.

As long as these bursts do not cause any intermodulation effects, we will now neglect this finding. But momentary it is problematic for our electrical measurement: as the energy of these spikes is very high, it couples into almost any BNC cable, causing the spikes to appear on the oscilloscope- hampering the hum measurement!

The solution is probably, first to bandwidth limit the measuring signal and then make the hum measurement. In this report, this is done by an "oldschool" Brüel&Kjaer 2606 measurement amplifier; activated its built-in HP and TP filters (22,5Hz respectively 22,5kHz). Doing this, most of the undesired RF noise will be suppressed during AF measurement.



Figure 8: using BK 2606 as pre-amp and filter

As the BK2606 is called “measurement amplifier”, he even does not filter and measure the signal, but also amplifies it. At his "recorder output" I can attach my oscilloscope and measure the bandwidth-limited AF signal. So please be informed, that the Y/div scale shown in the following diagrams has to be corrected by the amplification factor of the BK2606- which is 34dB!

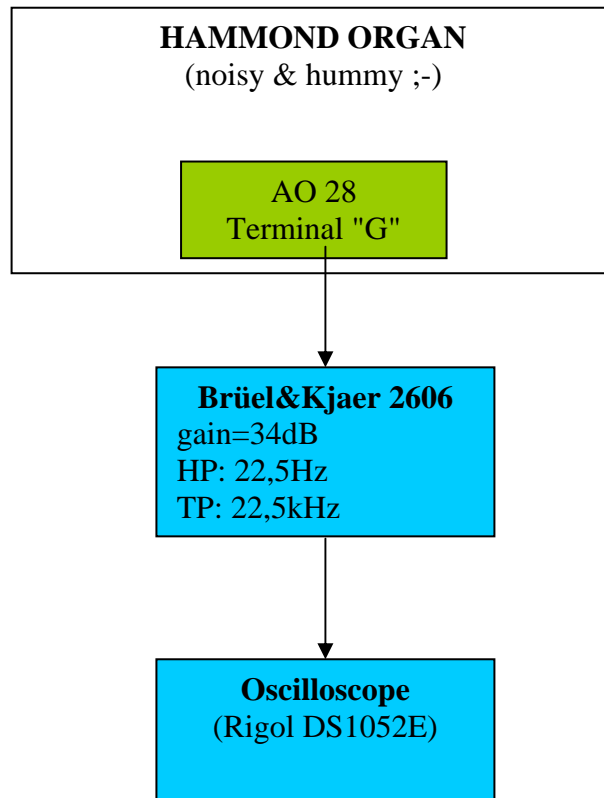

Figure 9: Test configuration for hum measurement

Settings of the BK2606:

- Direct in
- Input range: 0,1V
- Output range: x1
- => both resulting in 34dB amplification factor
- High-pass: 22,5Hz activated
- Low-pass: 22,5kHz activated

## 4 Re-measure the hum

With the BK2606 in the signal line (to suppress the unwanted RF spikes, reason see above), we need to re-measure the reference noise level of chapter2. Using the markers of the oscilloscope we determine the peak-to-peak level of the hum.

A special “persistence” display mode in the oscilloscope, which acts as an infinite overwriting mode, helps us to find the min and max peak during a longer period of time (e.g. 1 minute).

### 4.1 swell = volume min

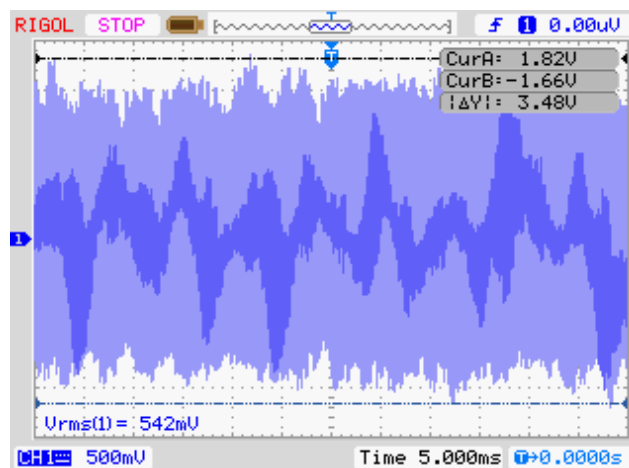

figure 10: noise level @volume min

As seen in figure 10, the peak-to-peak noise level with the volume swell pushed to its minimum position, is around 3,48Vpp ( $\Rightarrow$   $\sim$ 70mVpp at terminal “G”).

### 4.2 swell = volume max

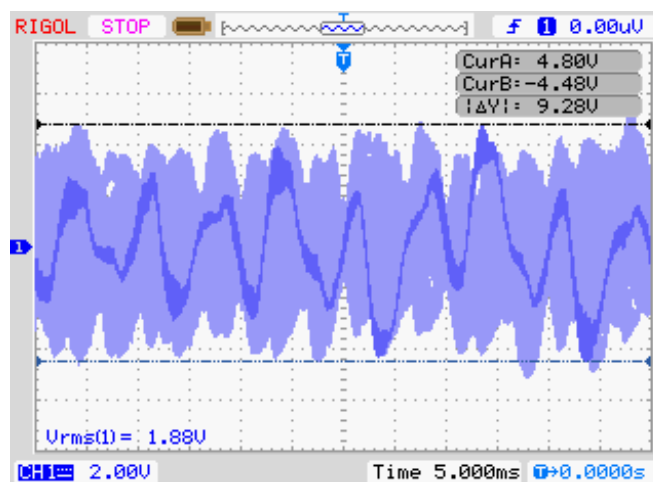

figure 11: noise level @volume max

The peak-to-peak noise level with the swell pushed to its maximum position is  $\sim$ 9,28Vpp ( $\Rightarrow$  185mVpp at terminal “G”).

This is quite much!

## 5 Deactivate internal reverb unit

In this chapter I just disconnect the 115V power supply of the built-in OrganMate spring reverb. In order to maintain the audio signal flow, the signal path is bypassed by a hardware link via an ordinary RCA cable. As in many organs the former owner has built in an insert-option with two RCA jacks, the bypass can easily be done.

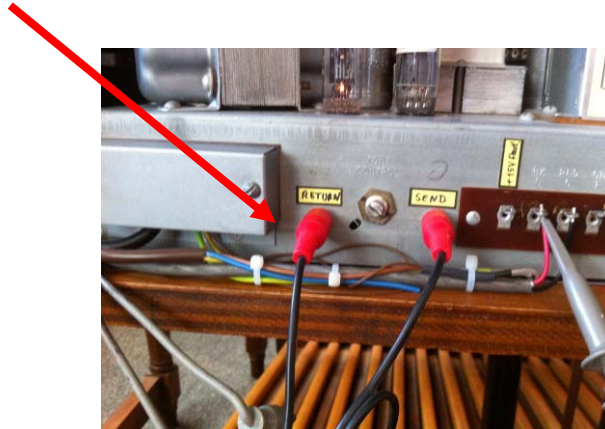

Figure 12: use short RCA cable to bypass the reverb unit

### 5.1 Re-measure noise level

Because the audio signal bypass is changing the overall amplification factor in the organ, we need to re-measure the hum level again in order to get a new reference level for our hum investigations.

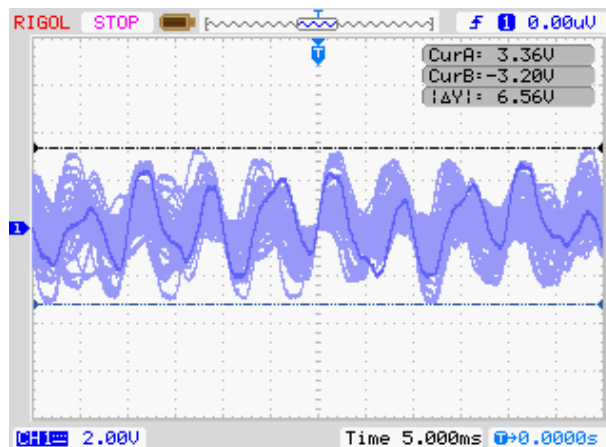

figure 13: hum level with "spring reverb unit" bypassed

We compare this picture with figure 11. Taking the spring reverb out of the audio signal path, causes a little bit loss of gain (before 9,28Vpp, now 6,56Vpp) but changes nothing about the hum itself. Maybe the OrganMate adds a little bit of pink noise (which can be seen as a little “fluffiness” in the waveform in figure 11), but this is not the problem we are looking for.

## 5.2 Disconnect 115V mains of “OrganMate”

As the audio flow is maintained by our bypass cable, we disconnect the 115V power supply of the “OrganMate” spring reverb. The oscillogram changes like this:

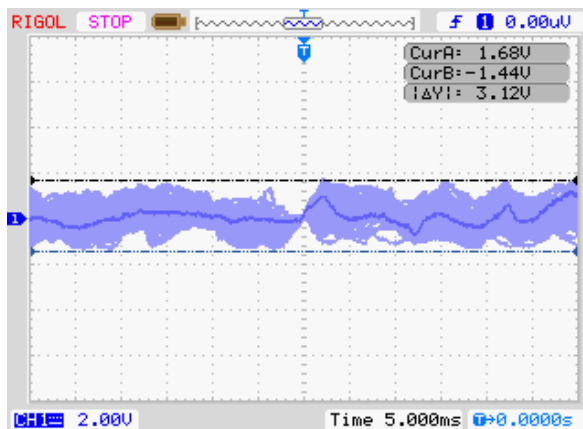

figure 14: noise level @volume=max, but "Spring reverb" disconnected

Now it's gonna be interesting: the hum reduces significantly to only 3,12Vpp. If we obey the 34dB system gain of the measurement setup (BK2606 preamplifier is set to 34dB gain), this would mean a drop from 131mVpp to 62mVpp at the terminal “G” of the AO28– this is an improvement of more than 6dB! Not too bad!

Note: this improvement can be achieved just by disconnecting the power supply of the “OrganMate” spring reverb! So it is quite for sure, that magnetic fields, caused by “Something” inside the OrganMate (maybe its power transformer?) gives a quite good contribution to the organ's hum!

## 6 Investigations

Deeper investigations show, that the hum is coupled via terminal “D” of the AO28 preamplifier into the audio system. “Terminal D” receives its signal from the scanner, this unit is quite known as an electromagnetic/static very sensitive part!

If I turn off the tonewheel generator and thus bring the scanner to a complete standstill, you can observe, that it is possible to find a static maximum of hum- just by turning the tonewheel generator's drive shaft by hand.

Possible explanation: if you turn the generator by hand, you will also turn the capacitive pickup inside the scanner unit. Somewhere between 0° and 359° there is a maximum of interference, depending on what stator package is exposed most to the interfering electromagnetic field. This first observation we will keep in mind, we will check the vibrato system again later!

Note: For further details of the vibrato system, see “Hammond Technikhandbuch”, written by M. Michalzik.



## 7 Step-Down Transformer

We know now, that the OrganMate spring reverb causes some hum in my organ. But is this the only hum source in the organ? To find that out, the influence of the build-in 230V/115V step-down transformer shall be evaluated. For that, the complete transformer will be disassembled and moved outside the organ case. If the transformer has any contribution to the hum problem, we will observe some change in the oscillogram.

step-down transformer also causes some hum into the vibrato system!

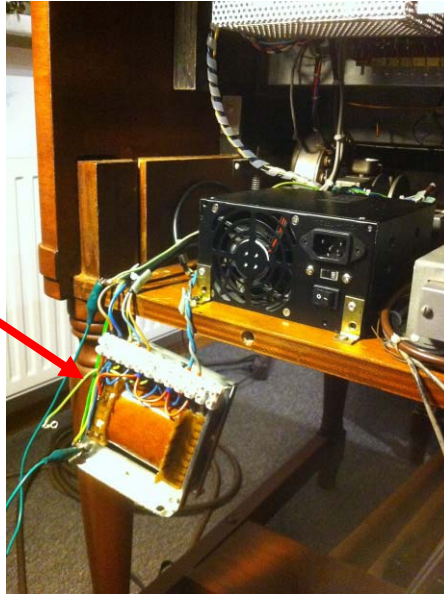

Figure 15: step-down transformer "hanging out" ;-)

This picture shown in figure 16 is the result of the  
a) deactivated spring reverb and  
b) moved step-down transformer

The noise level again drops to 2,72Vpp – so in truth 54mVpp noise level at the output terminal “G” of the AO28.

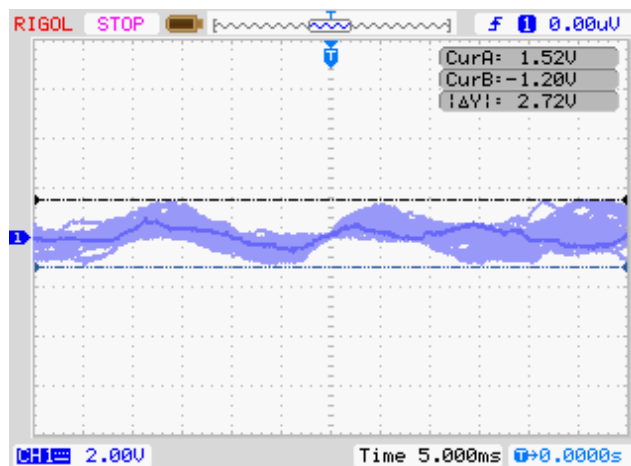

figure 16: noise level @volume=max, reverb bypass, transformer moved outside

So the influence of the step-down transformer to the hum is obviously another 1,7dB.

## 8 Intermediate result

Let's make a short summarization: during the first analysis we saw, that the OrganMate spring reverb is obviously producing hum noise, that interferes somehow with the organ. Currently we do not exactly know, where the hum is going into the system, but it has probably something to do with the vibrato system (scanner, linebox, harness).

We also learned, that the step-down transformer (230V->115V) also produces a little bit hum into the organ system.

This organ is technically quite original, so there should be no "specialities" in it that potentially could cause humming problems; anything ought to work as the hammond engineers have designed it. The only change is the (needed) 60Hz generator for the run motor as well as the OrganMate spring reverb. So my further evaluations will first go into the direction "OrganMate" unit. Besides that, his hum contribution was much greater than that of the step-down-transformer, so it's obviously a great idea to start with the biggest identified hum source first: the spring reverb unit!

### 8.1 De-Assembly of the OrganMate unit

It was not so easy to take the reverb unit out of the organ, as all its cables and wiring have carefully been fixed with cable strips and holders. But there is no other way to get this unit disassembled than doing this briefly step by step.

As I had this puppy out of the organ, the next investigation steps were done on the lab bench. Supplied by a 115V isolation transformer, I wanted to examine the magnetic fields that this unit produces. This is not a trivial and easy job: even big EMC laboratories with all its high-end equipment and expensive, especially designed EMC-chambers provide measuring uncertainties of typical 6dB and more! So measuring EMC effects is obviously something for professional industry and scientific institutes. So if this is so hard to measure EMC- how shall I do this measurement with normal "home stuff" equipment?



figure 17: OrganMate unit on the workbench (metal cage already removed)

I have to admit, that I need to improvise a bit. The best sensor for magnetic AC fields that I found in my lab, was a miniature ac audio transformer. Originally parts like these were used in audio applications to prevent from ground loop issues. But hooked up to an oscilloscope, it also can "measure" (in this case I better should use the word "indicate" ;- ) magnetic AC fields! No doubt that this small solution is not the ultimate "accuracy-top-hit", but will nevertheless be helpful in my search for electromagnetic (narrow) fields.

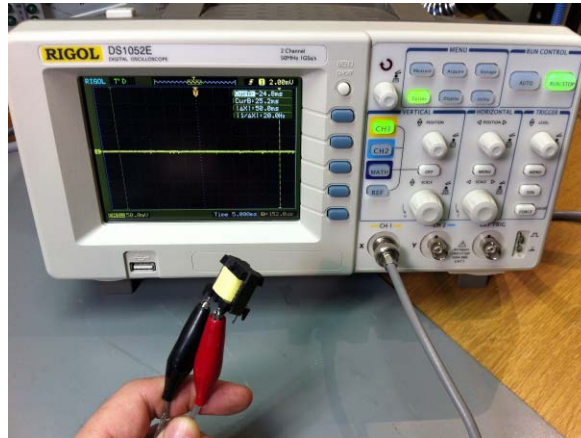

figure 18: small AC transformer as magnetic sensor

## 8.2 magnetic emissions

The first thing I do is to evaluate, if there is any magnetic field visible produced by the OrganMate and -if yes-, where is that coming from. So running the OrganMate unit simply at 115V (no audio input signal needed for this test), the problematic part was found within a few seconds: it is the mains transformer of the OrganMate power supply! It generates a quite strong magnetic field along his copper coil- exactly as you would expect it using the three-finger-rule, that I learned in physical education in school, long long time ago.

There is a clear visible direction, where the magnetic field has its maximum. Unfortunately this maximum of emission heads directly towards the scanner and linebox unit, when assembled in the hammond organ :-)

In order to make the measurement a little bit more comparable, I measure the strength of the ac field (as  $V_{pp}$  value seen on the oscilloscope) in a standard distance of 3cm, using a mechanical holder to fix the sensor in this position.



figure 19: a distance of 3cm is now my standard test parameter

Here you can see the magnetic field in its maximum emission angle\*:

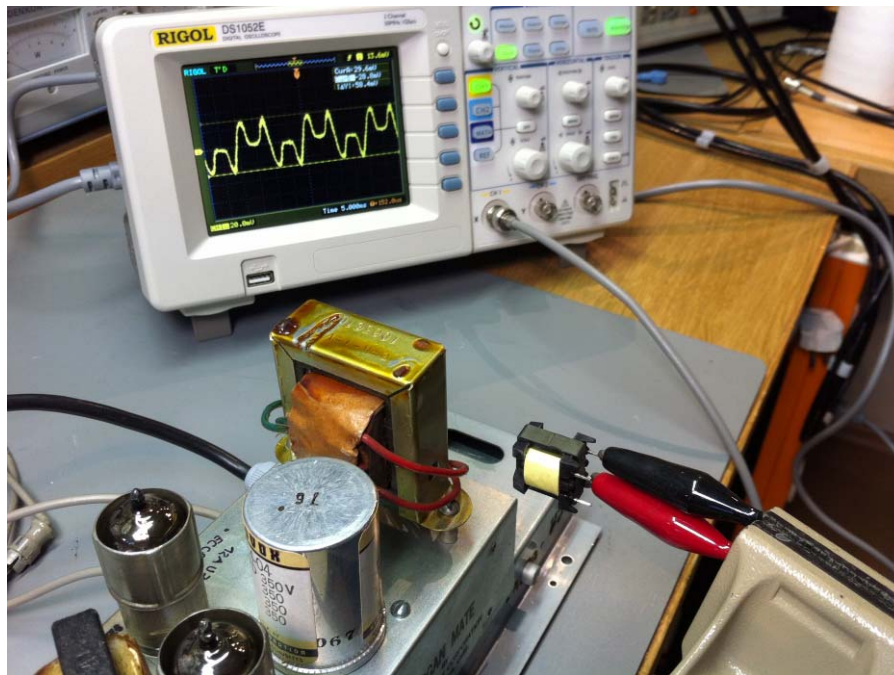

**figure 20: magnetic emissions "in line"**

And this is on the rectangular axis:

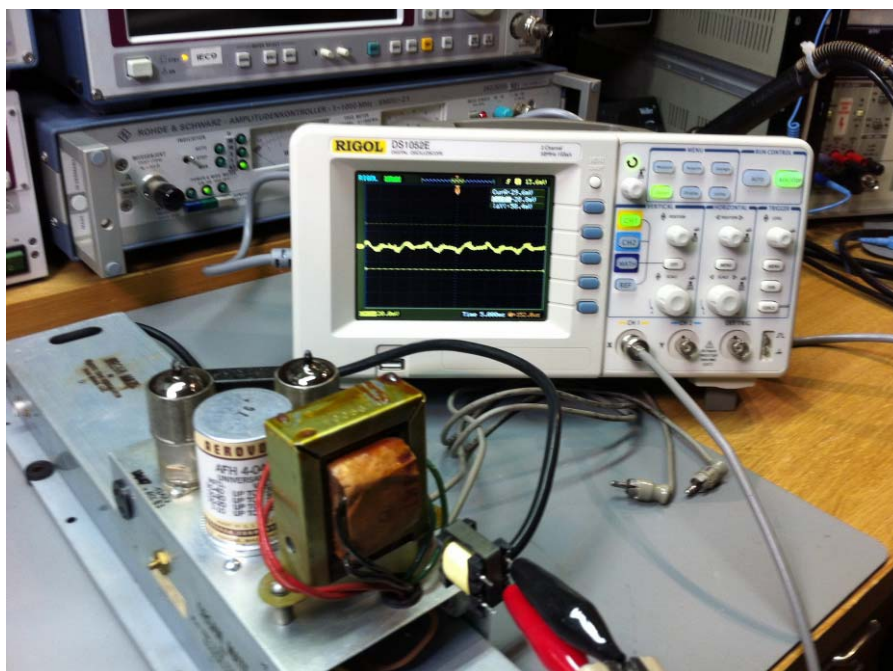

**figure 21: magnetic emissions "rectangular"**

\*Interesting, but not relevant for our problem: if you observe the waveform and its shape, then you will see, that there are only odd harmonics of the 50Hz spectrum available (150Hz, 250Hz,...).

## 8.3 Sensor fabrication

I found that it would be a nice idea to make my new ac field sensor a little bit more “use-able”. So I soldered a thin BNC cable to it, put some shrinking tube around and glued all with hot glue to a wooden stick that you can use as an isolated grip.



figure 22: my new "ac sensor" in production :-)

As I found at least two pieces of these little transformers, I produced two of these units. As you can see, they really work fine! A direct comparison shows that they produce almost identical sensor outputs:

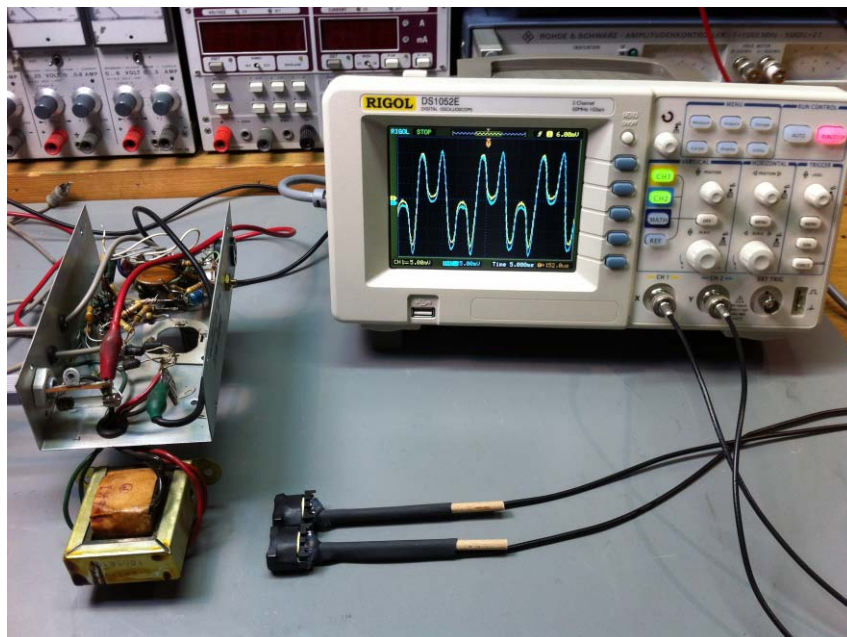

figure 23: two sensors in comparison: almost identical!

(one waveform shown in yellow, the other in cyan)

I am so happy about this simple result, that I present one of the two sensors to Jac. So for the future we can compare our measurements of magnetic fields in our organs. This could turn out as an advantage in den future for the “hum story” :-)

## 8.4 Improvement

So far, so good. We know now, that a electromagnetic field, emitted by the mains transformer of the OrganMate reverb unit, is considered to be the root cause for the biggest part of the hum noise in my hammond organ. So what can I do against this?

Some ideas that I have:

- 1) **Change the transformer** to another model with lower emission spectrum
- 2) Keep the original transformer in OrganMate, but **turn him by 90°** to lead its preferred emission club to another direction (away from the scanner)
- 3) **Assemble the OrganMate somewhere else in the organ** where it is not so sensitive against electromagnetic interference
- 4) Use a **different power supply** for the OrganMate (external) and deactivate the internal power supply unit
- 5) Use **another reverb** unit that MAY be better regarding magnetic emissions (Spacesound, digital reverb, ...)

First, I checked #3. I could change the place of the OrganMate inside the organ. But this would only be a workaround. Better is, to solve the problem at its roots. In addition the only place where I can mount it differently, is next to the matching transformer. And especially this part is also known as to be very sensitive to electromagnetic interference, so probably not a very good idea.

#2 is going into the direction "root cause", but #1 would be the thing to start with. So I checked a second transformer that I found at my desk. Result: in 3cm distance its magnetic field is comparable in its density to the OrganMate transformer! So the "magnetic quality" of this (chosen by random) transformer is not better than the model used in the OrganMate.

Then Jac van de Walle (who is not only very experienced in tube testers and HiFi gear, but also in Hammond organs and he is actually the reason why I write this report in english language) gives me the hint to try to decrease the magnetic field by using a copper stripe around the transformer. And he may be right: if I look at the Hammond transformer used in AO28 preamp, there you can also see this copper band around it! The principle is to absorb the magnetic stray field energy as eddy current. If you search in the literature, then you will find several types of transformer copper shieldings; but mostly used for safety reasons (isolation layer). For me, it would be totally sufficient just to weaken the magnetic stray field.

## 8.5 Copper strip

Fortunately I found such a copper strip in my home "warehouse", so I could make the test very easily. But the result was quite annoying: a decrease of the magnetic field (measured with my new sensor) could not be observed. The mVpp voltage in its main radiation direction did not change with or without the copper strip. Too bad.

## 8.6 Magnetic penetration into the Hammond organ

Inbetween, the search for the magnetic sensitive part inside the hammond organ continues. Jac is not convinced, that the scanner itself is the "weak part" in the signal chain. So we need to test. I need a tool, that is able to generate magnetic AC fields on demand. I remember, that in former times I owned a de-magnetizer, which's normal purpose was to de-magnetize tape recorder heads. This handy tool is a brilliant 50Hz generator for magnetic fields. I take it and hold it against different parts of the (running) organ- always checking for hum to occur.

The result is, that most hum is hearable, if I hold the magnetic field generator just towards the linebox and its wiring! But the scanner (including its shielded pickup-cable) seems not be very "impressed" by my magnetic "injector". As this unit is a capacitive device and very good shielded, it is not very sensitive to magnetic fields, that sounds logic.

But the linebox with all its coils...hmm...could be imagineable, that it transforms the injected ac magnetic field into a small ac voltage.

Until now, I was not able to convince Jac with my linebox-theory. He still expects other reasons for the hum to be picked up and mentions, that my tape-recorder-demagnetizer may not meet the reality (is could be much too strong for this test).

So I discard the demagnetizer and use the transformer instead that I found in my lab and with which I measured with the same intensity of magnetic field than the OrganMate transformer.

## 8.7 Magnetic penetration #2

So I placed this transformer into the running organ; using a plastic box as stand (to bring it to the correct height in the organ). Obviously this simulation of the "OrganMate transformer" worked, because I noticed some hum in the organ that was very similar to the OrganMate hum!

## 8.8 searching for the root cause...

Running this setup, I took a short piece of wire and short-circuited certain points within the vibrato system against ground. If the hum disappears (or in minimum reduces remarkably well), I obviously found a hum sensitive place.

First I short-circuited the input of the linebox (=terminal "C" on the AO28 preamp). No change of the hum.

Then I short-circuited the linebox outputs one after another. Doing this, the hum actually changed! Especially at the end of the linebox (pin 18) the effect is most: the hum significantly reduces!

The same behaviour at the output terminals of the vibrato switch: this switch selects, which outputs of the linebox are routed to the scanner. In C3 or V3 position, the complete length of the linebox is scanned; in position C2/V2 and C1/V1 only the first delay segments are used to reduce the phase vibrato intensity.

It makes no difference, if I short-circuit the vibrato signals before or after the vibrato switch. So I conclude, that this switch itself delivers no contribution to the hum signal and -thus- is out of scope.

If we continue to follow the signal flow in the organ, then the next station is the scanner. His inputs are the 16 contact screws (that you even can see from outside) with its wiring harness; his output is the shielded cable that goes to terminal "D" of the AO28 preamp.

If you meet the correct input screws of the scanner, you can cause the same hum-behaviour like in the linebox.

My conclusion is: from all what I can hear with my own ears, the hum is "generated" by the linebox. Probably it acts like an antenna for any magnetic fields in the inside of the organ. I have no other explanation.

## 9 Restaurating the OrganMate reverb unit

After having done this short test, it requests for a magnetic improvement of the OrganMate (because I do not think that I can improve the linebox in any manner without bad influences for the sound). So I disassembled the unit. One of the first observations that I made, was, that the multisection filter capacitor behind the rectifier was leaky. Not electrically leaky, but chemically leaky!



figure 24: OrganMate from below

In figure 24 you can see, that I point with my handtool to a "white spot". This white stuff is obviously a electrolytic fluid, that disappeared somehow from the capacitor and then dried out next to his solder pins. Not very nice.



## 9.1 Multisection capacitor

So this problem I definitely need to fix first. I took the capacitor apart, cleaning it with alcohol to get a closer look to it. But as a chemical leakage is most possible not a good sign at all, I decided just to replace this part. Original rebuilt parts are available in the USA, but quite costly. So I looked at RS-Components.de and ordered the electrolytic caps separately. In total the multisection capacitor in the OrganMate has four caps inside: 47 $\mu$ F, 20 $\mu$ F, 20 $\mu$ F and 10 $\mu$ F. I chose 47 $\mu$ F, 22 $\mu$ F, 22 $\mu$ F and 15 $\mu$ F as replacement parts.



figure 25: multisection capacitor removed

For the re-capping I disassembled the original multisection cap. First I drilled several holes into it with a drilling machine; just perforating the inner of the cap. Then I broke the inner stuff into pieces with a handtool nippers; and removed the old electrolytic chemicals piece by piece. In the end I had the raw aluminium cylinder housing itself in my hands- ready to be re-filled by modern electrolytic capacitors parts.



figure 26: old multisection capacitor

figure 26: Brrr.....the chemical stuff is so corrosive, that –over the years- it etched “away” even one of the soldering contacts! My decision not only to investigate the hum, but also to care a little bit for the OrganMate unit, was not too bad.

Before I confirmed the order at RS-components.de, I set up a small mechanical simulation in order to test, if the new caps will fit into the old housing. That was a good idea, because I really had to play with some cap types and their different dimensions. In the end I had a combination of the desired 47 $\mu$ F,22 $\mu$ F,22 $\mu$ F,15 $\mu$ F/350V capacitors that can be bundled in a way, that the complete stuff fits into the casing of the old multisection capacitor.

bei RS-Components		C1	C2, C3	C4
	Soll [ $\mu$ F] Aufdruck	40	20	10
	Soll [ $\mu$ F] Schaltplan			
Alternative Part www.rs-online.de Artikel 699-7512	[ $\mu$ F] [V] Durchmesser (mm) Länge (mm) Preis (€) Typ	47 350 16 25 1,44 radial		
Alternative Part www.rs-online.de Artikel 699-7496	[ $\mu$ F] [V] Durchmesser (mm) Länge (mm) Preis (€) Typ			15 350 10 20 0,69 axial
Alternative Part www.rs-online.de Artikel 725-6984	[ $\mu$ F] [V] Durchmesser (mm) Länge (mm) Preis (€) Typ		22 350 10 20 1,07 radial	

figure 27: arrangement simulation in Excel ;-)

A few days later I had the new parts in my hands. I used my hot glue gun to fixate the 4 caps into the aluminium housing. Fortunately the caps were 105°C-types, so my hot glue could would not damage them by introducing too much thermal stress on them.

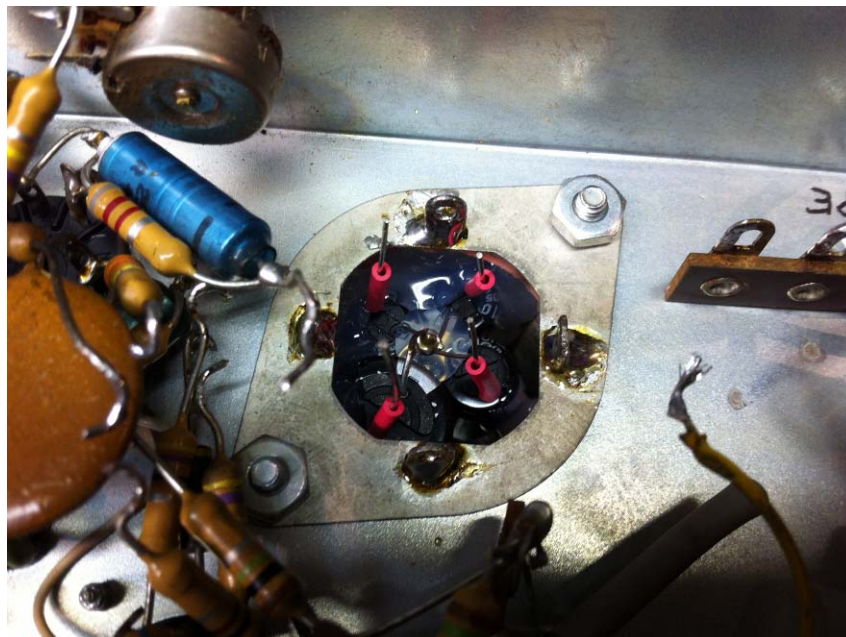

figure 28: multisection capacitor stuffed with new parts inside

After combining all the ground terminals together to a single pin, I soldered the "new" multisection cap into the OrganMate circuit again. I closed the down side of the new re-capped capacitor with a small piece of board. If you also do this, take care to keep necessary isolation distances between the five pins of the multisection capacitor: when in operation, you have here voltages up to 370volts between the terminals. In my case I milled away a lot of copper points from the PCB to have at least minimum 5mm isolation area around each capacitor pin.

After having all re-wired, the issue "capacitor change" was successfully done. A short test run of the transformer with new rectifier diodes and the capacitor was positive.

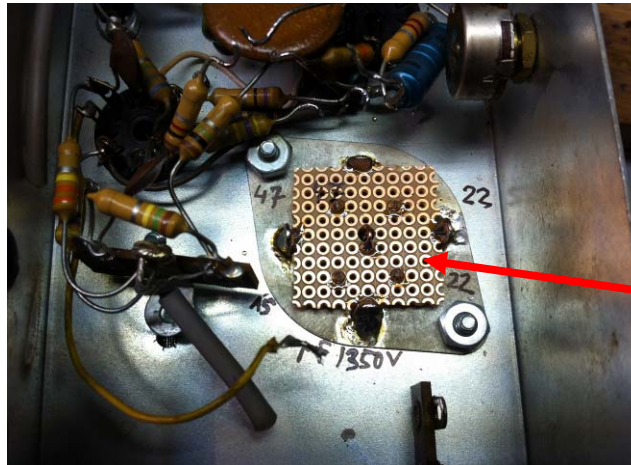

figure 29: capacitor closed by a small piece of PCB

## 9.2 Transformer turn by 90°

Remember: Initially, the multisection capacitor was not the root cause for taking the OrganMate unit apart: it was the transformer and its magnetic field, that I wanted to improve!

After having fixed the broken capacitor, let's finally concentrate on this issue now.

After removing the OrganMate transformer from the chassis, I actually found a possibility to place him 90° in turn. All that I had to do is to drill two new holes into the OrganMate chassis and adapt some wiring. But before I did this, I evaluated potential problems that could arise. I aim on the below mounted spring reverb unit, that also consists of two small "transformers": the transmitter coil and the receiving coil sitting at each end of the long spring mechanism! Remember: they also work magnetic! So when I optimize the main transformer angle for minimum hum in the LineBox of the organ, I must not forget that an optimum LineBox position is not necessarily also the optimum for the transmitter and receiver coil in the spring reverb unit!

But what position would be the best compromise for both- LineBox AND spring reverb unit? I have no other chance than to test.

So I take again my testing transformer and place him directly in a 0°-angle on the spring reverb unit. The transmitter and receiver coil is connected to an audio amplifier box with a built-in speaker so that I can hear any hum received by the spring reverb unit.

I switch on the hum source (transformer) and listen to the loudspeaker. Yes, I can hear some hum. And unfortunately this hum really increases a little bit, if I turn the transformer by 90° to the desired new position! Too bad! The new position may reduce the hum interference in the linebox, but at the same time it causes some more hum into the spring reverb itself!

Obviously it was a good idea to test this, before I grabbed the drilling machine. But I also learned a second thing: this hum reduces when I bring a little bit more distance between the transformer and the spring reverb unit. So if I can take him only a few centimeters away off the case of the spring reverb, the hum significantly reduces. Now I understand, why the

OrganMate transformer was mounted on the chassis with some metal distance bolts: they tried to bring as much distance between this transformer and the spring reverb coils as possible- reducing magnetic interference with this!

So this funny mounting of the main transformer actually has a true technical sense behind it. Got 'ya, developers! ;-)

After having learnt this lesson, I decided to give my 90°-turn a try. So I took the drilling machine and made the necessary holes. Then I mounted the transformer to its new position- using the original metal distance bolts. If you try to do this on your own organ also, then please check, that the new position of the transformer still fits inside the protective metal housing, that will be put over the complete electrical circuit afterwards.



**figure 30: transformer turned by 90°**

The wiring inside the chassis needs to be adapted a little bit. The original connecting cables of the transformer are not long enough to reach its new position, so I have to extend them. The internal fuse holder I also have to move to a new position; same for the holder for the rectifier diodes. In order to further improve the OrganMate, I also changed them (the original ones really look quite worn out- even from the outside housing) to 1N4007 ones. Diodes of this type can handle 1000V peak @ 1Amps current, so it should be an easy job for them to drive the OrganMate circuit.



**figure 31: wiring adapted to new transformer position**

## 9.3 Discrete parts in OrganMate unit

The next thing I should consider is to check all the other electrolytic caps used in the chassis. A replacement is done within minutes and will definitely help to maintain the reliability of the OrganMate over the next decades.



figure 32: measurement of a 25µF capacitor

That this idea was one of my better ones, proofed the first capacitor that I measured. It was supposed to provide a capacity of 25µF, but actually had ~500nF. The same thing with the two other 25µF capacitors. I need to replace all of them.

During my work I also found a few resistors with slightly higher values than they should have, so I also replaced them with modern 2Watts, 1% Metaloxide resistors that I had purchased from Reichelt before.

Then I checked this little potentiometer that is mounted into the chassis and which is marked with this sticker "do not turn - factory adjusted". I was very astonished to see, that it was turned to its maximum position! Very unusual- I can't imagine that a factory alignment causes the trimmer to be set to its end position. I would rather expect that a well designed factory adjustment would result in a setting somewhere in the middle position; not at its mechanical limit stop! So this is quite suspicious in my eyes; something is most probably wrong here. But how was this factory adjustment originally done? No clue- I need to check this thing when I got the OrganMate running again.

One of the last steps that I do to the unit is to connect the heater's supply to the tubes.

## 9.4 Power it up...

With tubes inserted, I power the unit up and measure the supply voltage. With 115V on the input of the OrganMate (it is specified at this voltage) I can measure quite precisely 6,3VAC across the heater's windings, so that is satisfying.

A little bit annoying is the anode power supply. I notice that during power-up (tubes are not yet conducting) the DC voltage directly behind the rectifier hits the 350V limit of the filter capacitors for a few seconds. This is not so good! Okay, this overvoltage is only around 10..20V above and it drops immediately when the tubes start conducting anode current, but nevertheless I do not like this kind of "limit design" at all. It is usually not very reliable, when you violate the max limit of electrical parts- even if this happens only a few seconds each time. Maybe this over-voltage caused the original multisection capacitor to start the observed chemical leakage? Ah, I just don't know, unfortunately. I can only hope that the new caps can withstand this overshoot several years so that I do not need to refurbish this sucker again in a couple of months already.

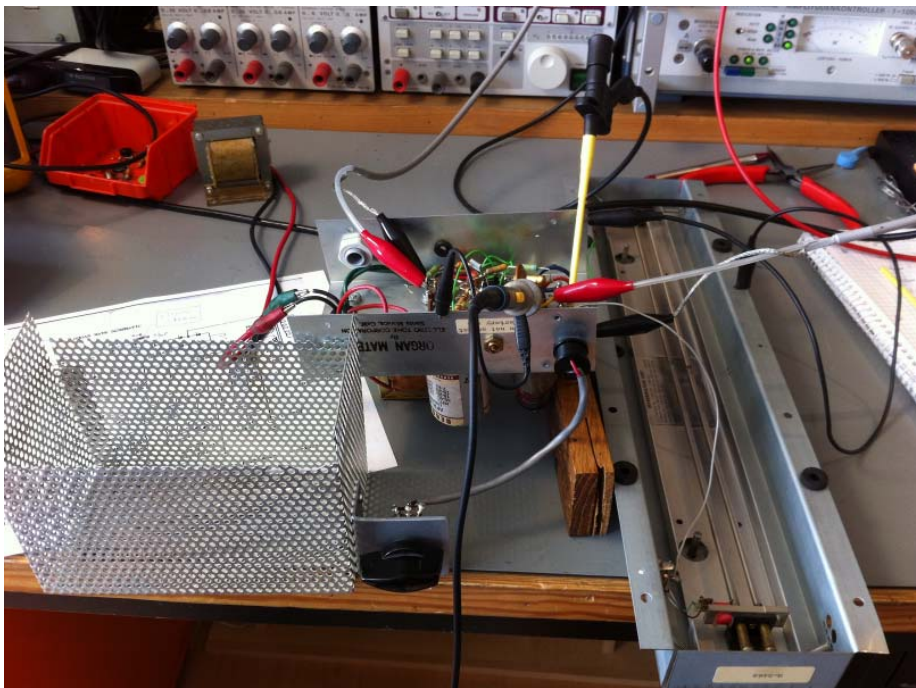

figure 33: test run of the re-newed OrganMate

## 9.5 Voltage measurements

Before I finally finish and reassemble the complete unit, I do some measurements. The very first thing is to check all the supply voltages and operating points of the tubes. By the way- the OrganMate is stuffed with a 12AU7 and a 12AX7 tube. Both I checked with my L3-3 tube tester first to be sure, that they are both operating in spec.

### 9.5.1 Power Supply

The following testing points belong to the power supply chain (including the multisection capacitor):

U<sub>310</sub>= 315VDC   => ok  
U<sub>290</sub>= 300VDC   => ok  
U<sub>275</sub>= 280VDC   => ok  
U<sub>265</sub>= 272VDC   => ok

As stated in the schematics, a tolerance of +/- 10% is acceptable.  
All voltages measured with HP34401 multimeter.

### 9.5.2 Audio paths

The following check points belong to the audio path:

U<sub>300</sub>= 301VDC (AC-Ripple: 60mV RMS)   => ok  
U<sub>105</sub>= 106,6VDC (AC-Ripple: 20mV RMS)   => ok  
U<sub>3,7</sub>= 3,7V DC   => ok  
U<sub>10,7</sub>= 10,6VDC   => ok  
U<sub>190(1)</sub>= 182VDC   => ok  
U<sub>190(2)</sub>= 183VDC   => ok  
U<sub>2,1</sub>= 2,1VDC   => ok  
U<sub>1,9</sub>= 2,1VDC   => ok

It has to be remarked, that there do in minimum two versions of the OrganMate schematics exist. In one of them I have, are definately wrong voltages written at some checkpoints (e.g. 250V-points that are actually 190V-points!). Also the values of some resistors and capacitors are not identical to the values that I have in the circuit (e.g. 6,8MOhm in schematics / actually 8,2MOhm in circuit). So my advice: keep always your attention when reading the OrganMate schematics.

## 9.6 Audio measurements

Next step is the measurement of the audio performance. And here interesting things do happen. I measured the frequency response in different positions of the effect mix knob; starting with 0% (=dry sound, no effect) ending with 75% (=intensive reverb effect).

The curves presented in figure 34 show very astonishing frequency responses; especially when the reverberation path gets effective. Whereas the “dry” frequency response is very linear, it gets completely out-of-shape when mixing more reverb effect to the signal.

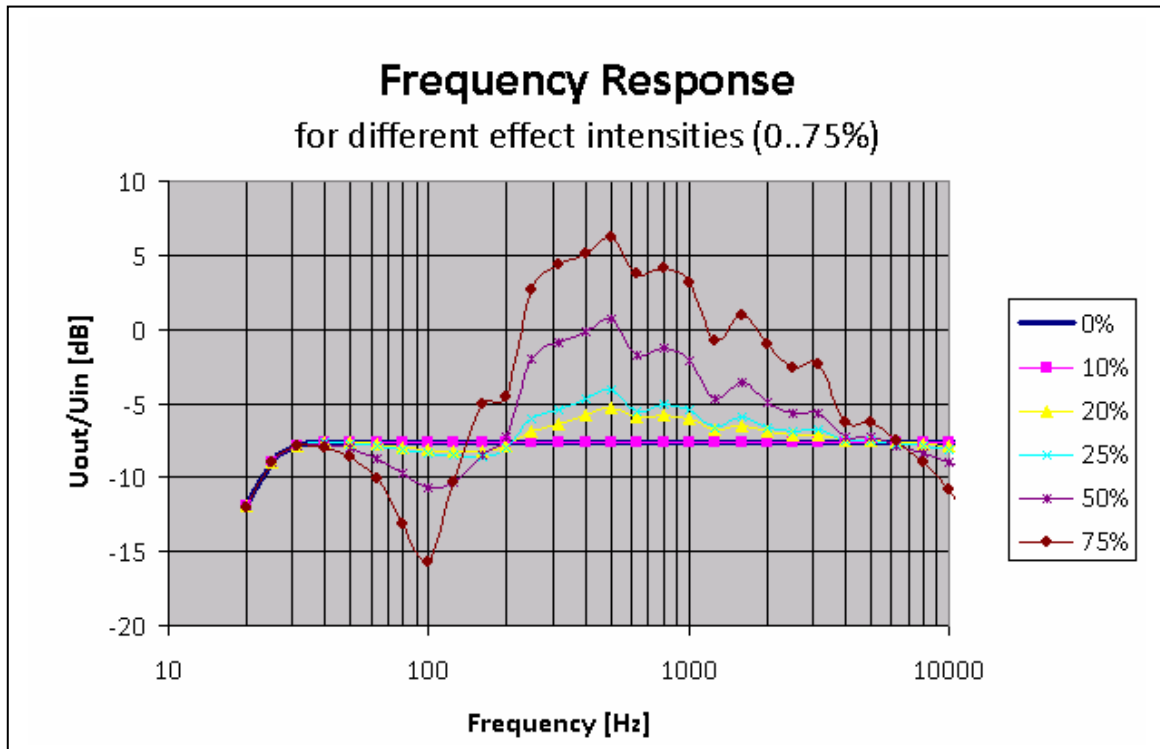

figure 34: frequency response of the OrganMate

In the position “75%” you can see a big drop at 100Hertz of almost 10dB. Then you observe a bandpass behaviour between 100Hz and ~10kHz with a lot of ripple on it. Really amazing- this tiny frequency response shall improve the sound of my B3 hammond organ? But in total is not that worse as you might see it here: setting the effect-mix-knob to 75% is very unusual. If you are not producing "soft-music" for an adult movie ;- ) then in reality you may use not much more than 20 or 25% of the reverb effect. In this range the frequency plot is still quite linear, so has not much influence to the organ's basic sound.

### 9.6.1 Factory set potentiometer

You may ask why I end with the 75% setting and did not use finally the 100% setting for this test. The reason is simple: the organmate starts to oscillate when I turn the effect mix knob to 100%!

When I check the output voltage I can measure a heavy oscillation voltage with a frequency of about 34kHz and an amplitude of ~10Volts peak-peak! Too bad! I noticed that the oscillation changes with the load that you attach to the OrganMate output. You can see the oscillation in figure 35.



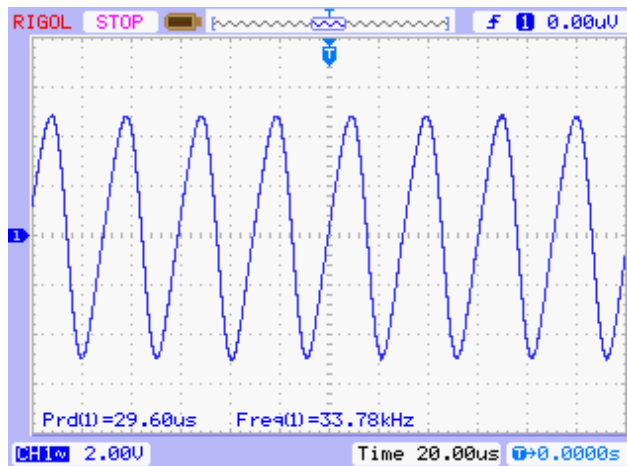

figure 35: OrganMate starts oscillating!

And then I notice that the point, where the oscillation starts, changes with a turn on this “Factory set” potentiometer. This poti obviously changes the gain of the OrganMate unit-until it start oscillating. If I turn it to the position where it originally was when I got this organ, it provides the lowest gain and –thus- the best stability. But even in this low-gain position the my OrganMate unit is not self-oscillating-proof.....

This is a fact that I just have to accept.

### 9.6.2 Adjust the Factory-Potentiometer

Ok, we know now, that you need to pay attention to the correct setting of this potentiometer. But how to set this potentiometer into its correct position? What is the "factory-set" position? Unfortunately I cannot find any hint in the supplier's documentation how the factory alignment has to be done and I cannot believe, that the endstop-position that I found the OrganMate as I bought it, is really the correct one that was chosen by factory.

As I don't have any better idea, my personal "factory setting" is the position, where the OrganMate produces an overall gain of exactly 1. Let me explain: when you have a look to the frequency plot above again, you notice that the OrganMate has some signal loss of ~7dB from its input to its output. This means, that my organ produces 7dB lower output signal than any other non-modified B-3 organ. Especially when you play rock music and want to have a partly distorted sound, those 7dB less are not acceptable. So my first attempt is to align this potentiometer to a position that the OrganMate produces exactly the same output level that you give him on its input => 0dB amplification = neutral.

For doing that, I assembled the unit completely and put an 1kHz signal with an amplitude of 2Vpp (=0,707Vrms) into his line input. (Effect-Knob set to 0%, means completely "dry" sound.) Then I trimmed the factory-potentiometer in a way, that I can measure also 0,707Vrms at its output. This happens somewhere in the second half of the potentiometer operating range which is actually good: there is still enough headroom for adjustment to both sides (fine-trim for more or less amplitude still possible!). The position of the trimpot (still with distance to both endstop-positions) could be an indicator, that my "alignment rule" (=get unity gain of 1) could be occasionally right!

## 10 Plan B!

A few days after I took my measurements, it happened that our organ club (Hammond Nostalgie Club) had a member's meeting. These meetings are not only for necessary, typical club things like elections of the board's people, checking the financial status, reading the report of the last meeting...., bla bla bla, but also for interesting discussions with interesting hammond owners. You can also see several organs, have workshops, listen to music, and so on. It was absolute random, that during this club meeting two of our best club technicians (Herbert Dätwyler and Ulrich Zwarg) participated to this appointment. And Herbert also presented his personal B-3 organ which was also stuffed with -what would you guess?- YEEES, with an OrganMate spring reverb! Ha!

If you happen to meet such brilliant technicians, you should open your ears very widely and just listen and learn! They have collected so much experience over the years, that they know answers for almost any technical problem.

So during the following technical ask-and-answer-workshop I couldn't resist and asked herbert about hum problems that I observed and actually might be in touch with the OrganMate spring reverb. It turned out, that I am completely "on track" with my humming experiences. Because of having had exactly the same problems, Herbert split the OrganMate unit into the electronics part and the spring unit (see figure 36).

The electronics part with its power supply he placed on the ground plate of the organ, but on the RIGHT side (where the matching transformer is). The spring unit he mounted also on the RIGHT side of the organ, but hanging down from the "ceiling" of the organ (roughly where the preset board is). The separation provides still enough distance between OrganMate main unit and the matching transformer to prevent from penetrating magnetic hum fields. The only disadvantage is, that you need to move the organ's identity label (the small metal plate where you can find the model type and the serial number) a little bit so that it still can be read. Okay, that's not so nice, but that's still a fair trade-off!

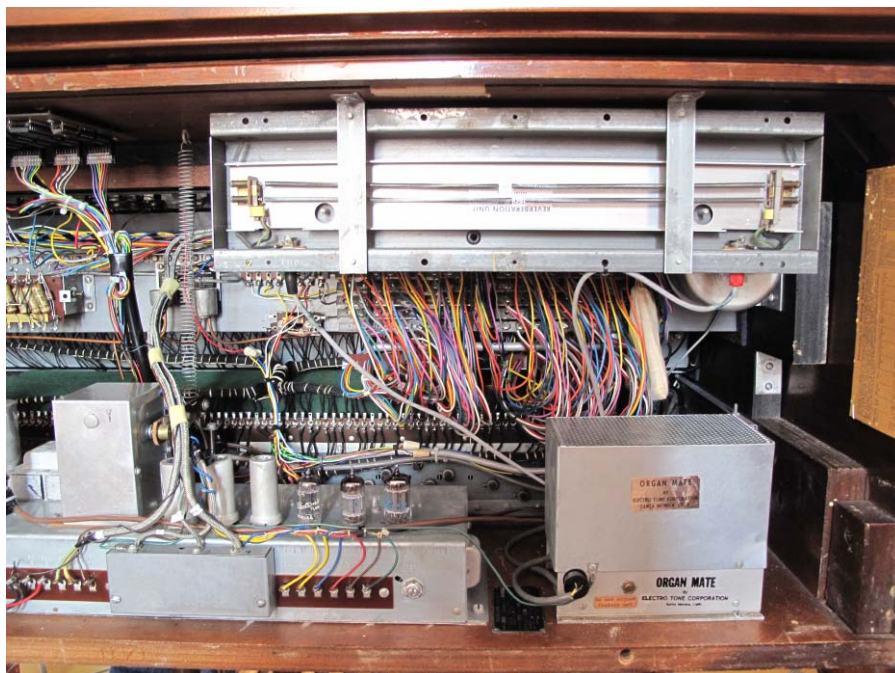

figure 36: OrganMate installation in B-3 of Herbert Dätwyler

Then Ulrich Zwarg added, that also he himself identified hum problems in combination with the OrganMate spring reverb (so I am definitely not "alone" with this problem). His personal solution was to deactivate the internal power-supply of the OrganMate and get the needed voltages from the AO28 organ's amplifier.

So at the end of the day I got two additional, possible solutions of my OrganMate humming problem:

- 6) split OrganMate into spring reverb unit and main electronics unit; place both separately, away from sensitive and interfering components
- 7) deactivate OrganMate hum source and get supply voltage from AO28 amplifier

As you can see, belonging to such a good working community often helps to get ideas that you wouldn't have had just thinking on your own. But as I have spent so much effort on my transformer-turn-project (solution #2) already, so that I will first finish this attempt and give it a try in the organ. Only in case this will not work for any reasons, I would follow the idea #6 or #7. This would be my "Plan B".

# 11 Finalize

I am looking forward for the first try-out of the magnetic improved OrganMate very much. But first I have to finalize it. I am quite progressed with this project; not only the change of the capacitors and resistors, the check of the tubes and the replacement of the rectifier circuit I have done, I have also soldered in a new mains fuse holder and two RCA (=Cinch) input /output jacks (instead of the directly connected cables) for a better and easier connecting interface to the organ.

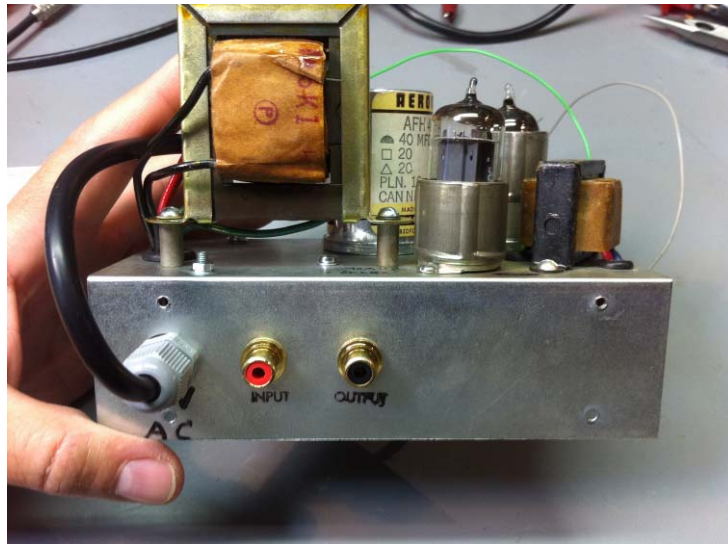

figure 37: OrganMate with new RCA jacks inside

## 11.1 RCA connectors

For the RCA connectors I chose good quality jacks from Neutrik, the plugs itself came from a special ebay-shop that sold me some 90degree-types that perfectly match to the small room inside the organ. They also seem to be very rugged and solid and are capable to handle also better quality coaxial AF cable (that is usually a little bit thicker in its diameter).

## 11.2 Rubber grommets

There is another thing that I fixed during the restoration: the rubber grommets! To improve the mechanical de-coupling of the spring unit to the chassis of the organ, they were put as insulation parts into the screw holes. As you know, rubber gets hard and crisp, when getting old- losing its decoupling attributes.



figure 38: old rubber grommets- falling into pieces when trying to remove

The big question was: where to get new rubber grommets?? After some time, I got an idea: I will use standard through-hole grommets! These rubber parts were usually used to prevent a cable from mechanical damage, when putting it through a hole in a metal chassis. They are ideal for my application: they are available in different standard diameters and they only cost a few bugs for a complete set, so I simply bought one on ebay. It came like this:



figure 39: a set of standard rubber grommets

Okay, the quality of these new parts are really "standard quality", they are not so precisely produced, they all differ a little bit and in addition they smell a little bit strange. Buy anyway- they are indeed a good choice for replacing the old, broken grommets.

original (old)  
ones

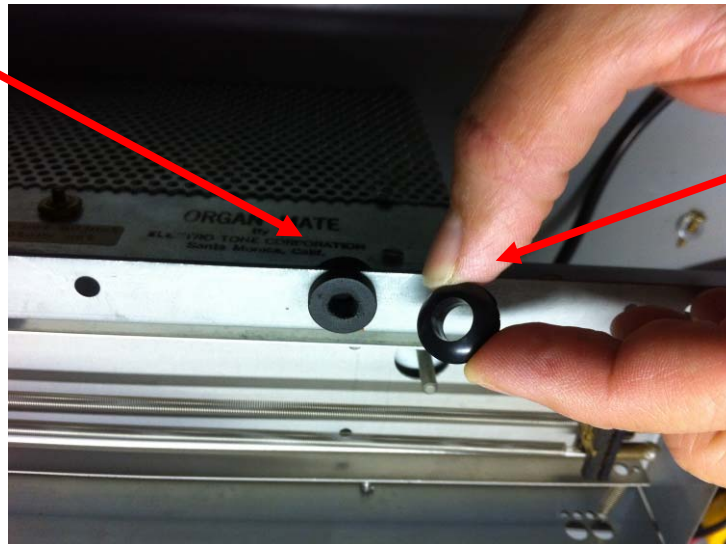

new ones

**figure 40: rubber grommets at the spring unit**

As expected, it was very easy to remove the old, hard grommets. They fell apart by themselves just by touching them a little bit harder. Then I pushed in the new ones. Very nicely, see figure 41.



**figure 41: spring unit stuffed with a new rubber grommet**

To further improve the mechanical insulation effect, I even put on a smaller version of these grommets on each screw. They are so small, that they even fit into the holes of the chassis-mounted grommets in figure 41.



**figure 42: additional grommet on the screw**

This way, we have a mechanical double-insulation against mechanical vibrations of the spring reverb unit.

Having done all this, I re-assembled this sucker in the organ and checked out the result (see next chapter).

## 12 First try-out

Now comes the big disappointment!

All that measures did not lead me to an overall success, unfortunately.

I assembled the improved OrganMate unit to its old place, connected the cables to it and switched the organ on.

OrganMate reverb unit

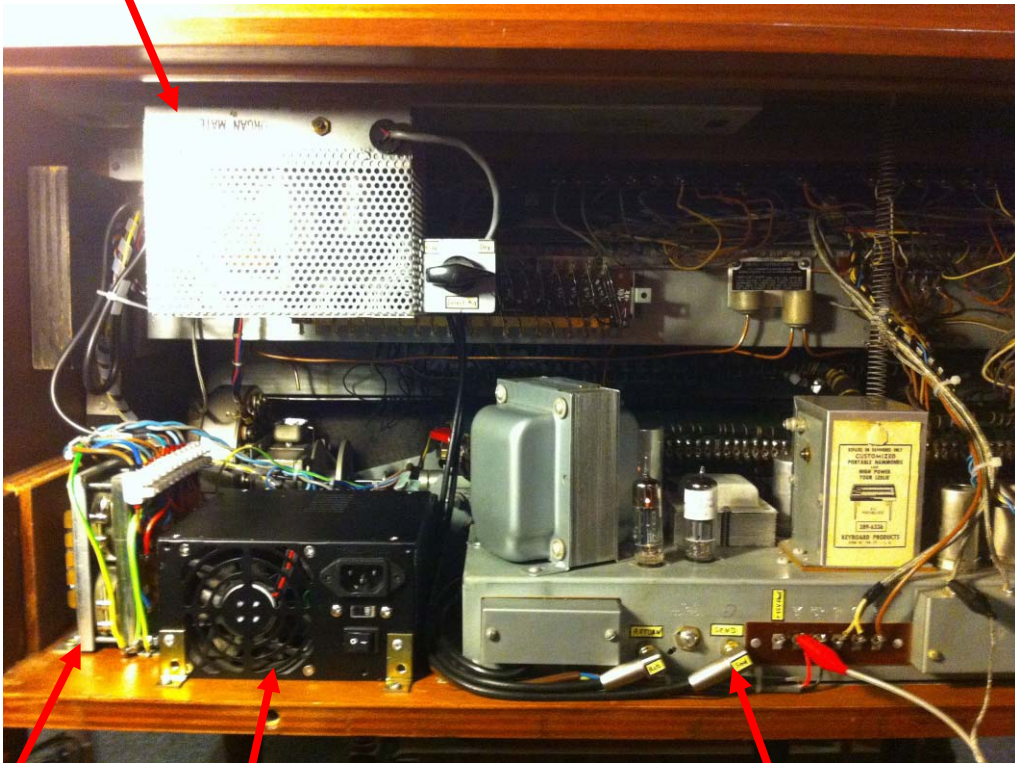

figure 43: all re-mounted in the B3 organ

117V transformer

117V/60Hz converter

one of the new RCA cables  
(with better shielding)

The disappointing was almost endless as I heard the well-known hum, oscillating with about 7 Hz scanner turnaround speed. I made the measurement of the peak-Voltage at output terminal G again.



We remember the figures **BEFORE the restauration (Transformer 0°)**:  
Umax (OrganMate powered **on**, but not part of the audio signal flow): 6,56Vpp  
Umax (OrganMate **off**): 3,12Vpp  
=> reduction of 6,5dB

Now, **AFTER the restauration (Transformer 90°)**:  
Umax (OrganMate powered **on**, but not part of the audio signal flow): 7,2Vpp  
Umax (OrganMate **off**): 3,4Vpp  
=> still the same reduction of 6,5dB

### **CONCLUSION:**

There is absolutely no improvement!!!! The OrganMate power supply still has a big influence on the hum level of the complete organ. Exactly like before, switching off the OrganMate transformers improves the S/N level by 6,5dB. The degree of magnetical penetration is obviously the same like before. What a bummer!!!!

#### Note1:

For all the readers that may mention now, that the comparison of the noise levels is not so simple, because the OrganMate -as part of the signal chain- has changed its amplification factor due to my trimpot alignment, I may say: usually you are right!

But in this case, I made it a little bit simpler for me, as we bypassed the OrganMate unit with a Cinch cable again and only connected/disconnected the power supply circuit. So the test setup configuration was exactly the same- regardless of the adjustment of the factory trimpot. We only measure the influence of the OrganMate's power supply into the signal line of the organ.

#### Note2:

If you read the values, please keep in mind the 34dB system gain of my measurement setup. So the 7,2Vpp measured on the oscilloscope is in truth 144mVpp and the 3,4Vpp is actually 68mVpp at the terminal G of the AO28 preamp.

## **13 Chop it- or not?!**

Realizing that all the work did not improve anything, was a hard drawback for me. So if I really want to be successful with this thing, I probably need to do the same thing like our hammond technicians did: cut the OrganMate into two units und mount the part with the power supply in it to the right side- far away from the sensitive LineBox and the scanner.

This means, that I need to modify the OrganMate chassis somehow with two more audio connectors for a proper interface towards the spring reverb unit.

## 14 Last-minute-idea: the solution!

Just right before I took the screwdriver to disassemble the OrganMate (again), I had an idea. During my humming tests a few weeks ago, I noticed an astonishing effect: a transformer, placed in the nearby of the Linebox produced additional hum, if I switch him on.

Okay, this is not very astonishing.

But if you reverse the powerline of this transformer and switch him on again, the hum noise almost disappears! So most obviously some magnetic field are compensating each other now, resulting in a very low hum level.

So if this works so brilliantly, it is worth a try with the OrganMate unit. A reversed powerline should result in a polarity change (=phase change of 180°) of the emitted magnetic fields. Maybe also in this condition I can force that compensation mechanism?

### 14.1 Current Noise Level

Currently, the noise level of the organ is like this:

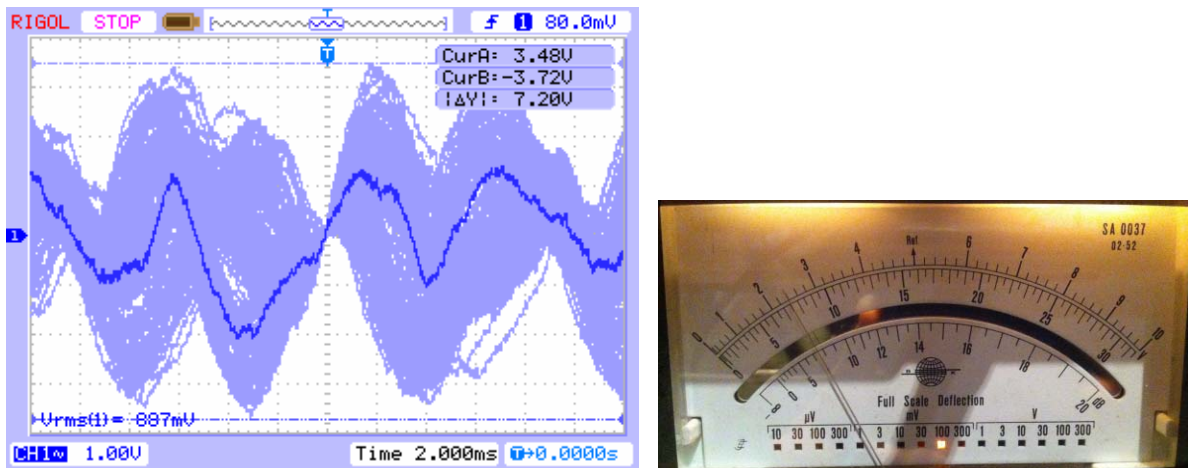

figure 44: noise level after OrganMate restauration (left: Oscilloscope; right: BK2606)

The peak-peak noise level, measured with the oscilloscope (and 34dB gain of the test system) is 7,2Vpp. If I measure the true RMS value with the Brüel&Kjaer 2606 directly at terminal G of the AO28 preamp, it shows **24mVrms**.

### 14.1.1 Comparison of oscilloscope and audio voltmeter

In figure 44 you can see the value of the internal rms measurement of the oscilloscope (887mVrms). To verify my measurements carried out with the BK2606 you could have the idea to check, if this 887mVrms will lead to the same result of 24mVrms if you just subtract the 34dB system gain.

If we do that, then you will be disappointed.

$$U_{AO28, O_{szi}} = U_{O_{szi}} * 10^{(-34dB/20dB)} = 0,887Vrms * 10^{-1,7} = \mathbf{17,7mVrms}$$

whereas the BK2606 instrument showed directly (also see figure 44, right):

$$U_{AO28, BK2606} = \mathbf{24mVrms}$$

This does not match! Why?

The explanation lies in the different integration time of the two measuring instruments: the Brüel&Kjaer 2606 is an absolute specialist in audio and noise measurements. For that, he offers a peak detector, a quasi-peak-detector as well as a RMS detector with a short and a long integration interval. Depending on what you want to measure, you can select the most suitable level detector for your measuring application.

The Rigol DS1052E is an oscilloscope that is made just for "anything". Sure, it also provides peak and RMS measurement, but it is no audio specialist and thus you cannot select a certain integration time to apply with certain audio measurement standards. It just makes a measurement of the currently sampled waveform, calculates its rms value (probably via FFT) and that is, what you get. It provides you the result of the current waveform that was sampled when you press the "screenshot"-key. In this case the value of the sampled waveform was 887mVrms. In the next moment (and the next digitized waveform) it would be a slightly different value. It's just like random and depends on statistical rules of noise measurement.

"Random" is something that is not good in professional measurement. For sure this fact also knew the Brüel&Kjaer developers, when designing their model 2606 so they added a switchable integration constant to the RMS detector. When correctly set (I used the "slow" integration rate for my measurements), it smoothes out the "dancing" waveforms and gives you a quite constant reading that you can rely on.

The oscilloscope does not have this possibility. It just delivers you the rms value of this certain waveform at this moment. When you switch over to the "infinite display overwriting-mode" then it can act as a peak-hold-display. Sometimes this is also worthwhile!

So the result is:

- When using the oscilloscope, it is better to make a peak-hold measurement and give you the result in Vpp.
- When measuring with the BK2606 audio voltmeter, you can also measure rms values; whereas the long integration rate is preferred.
- A direct comparison of "oscilloscope-calculated-rms" to "BK2606-measured-rms" values is not recommended as the integration factor of the rms rectifier is different.



## 14.4 Ready-to-play condition

I bet, a marketing department would even print this nice 17mVrms value into a fancy coloured flyer, if you ask them for the hum level of the organ. But the 17mVrms is only half of the truth- it was measured under special conditions that do not cover the reality (reverb bypassed, vibrato turned off, etc.)!

Because I am a big fan of realistic and honest measurement values, I bring the organ to a "ready-to-play" condition and measure again. This means: First remove the hardware bypass in the signal line of the OrganMate and put him correctly into the signal flow. Rotate his "effect-mix" knob to a realistic position, so ~20% of his variation range.

Then activate the C-3 vibrato and activate a standard preset sound of 888000000. Finally press the volume swell pedal to its maximum position.

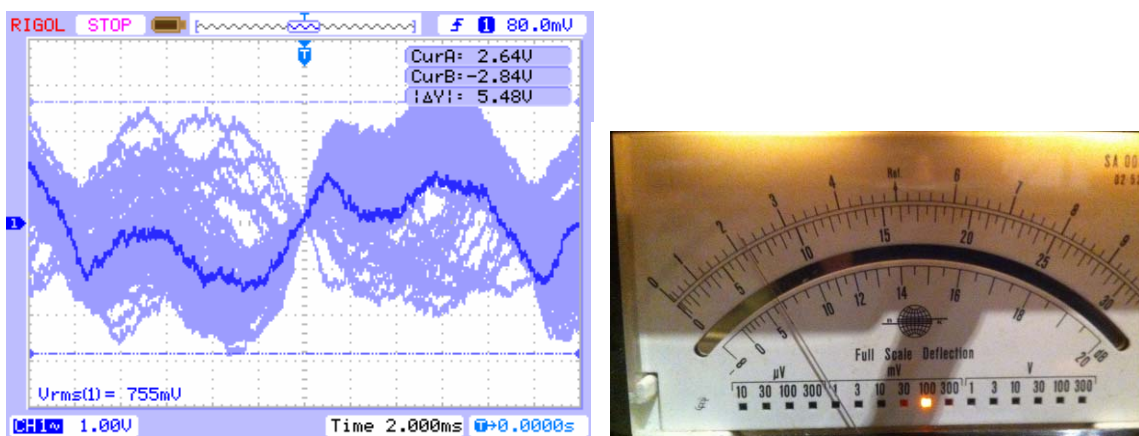

figure 47: Absolute measurement of noise level in "ready-to-play" condition

The BK2606 indicates **22mVrms** at the output terminal "G" of the AO28 preamp now.

### 14.4.1 Practical use of the "ready-to-play" measurement

This value is not theoretically calculated level, but contains any real noise sources inside the organ (vibrato system, reverberation system, percussion system, AO28 system noise, internal leakage,...). It represents the worst-case-condition of a musician might use this organ on stage in a concert. Measuring the noise level in exactly this condition is the only praxis relevant value that you can get! All the other values are only theoretical figures that may sound nice, but do not catch the reality completely.

### 14.4.2 RMS value ⇔ "ear" value

You may argue now, that this value is not so much better than the one we had in chapter 14.1. So where is the overall improvement? Answer: it is in the sound! Although in this "ready-to-play"-condition we have almost the same noise level (22mVrms) that we had before with the humming OrganMate (24mVrms), it sounds by far not so aggressive like we had before. The "ready-to-play"-noise consists of less hum, but more other frequency components like pink noise or some AF leakage. The RMS voltmeter is rating that signal according the formula for the root mean square and gives you the result. But the human ears

do it differently: they judge the "disturbance level" based on psychoacoustic effects, not like a "stupid" multimeter based on the root mean square. So it is absolutely contradictory, if you measure both signals almost the same level, but your ears judge one single more worse than the other. And that is the case here.

For my opinion this 22mVrms is not too bad and really a result of my evaluation work.

#### 14.4.3 S/N measurement (262Hz)

For evaluating the "ready-to-play" Signal-to-Noise-Ratio (=S/N), I set the organ to the above working condition, but only activate the 8' drawbar and press the key "C3" on the upper manual. You can hear the tone #37 which has a frequency of 262Hz.\*

I can measure a signal voltage of 2,5Vrms.

If you calculate the S/N ratio with the above measured noise level (22mVrms), than we get

**S/N<sub>ready-to-play</sub> = 41dB.**

Sure this is not the maximum value that you can get. I am sure that you can find a note with a higher output level that produces a better S/N, but I do not want to make a challenge out of this and measuring the S/N should only be info that is nice to know.

#### 14.4.4 S/N measurement (~1kHz)

For these guys among the readers who prefer measuring at a standard frequency of 1kHz, I made the same measurement with the key "C6" and the 16'-drawbar. This results is a tone very close to 1kHz and looks like this:

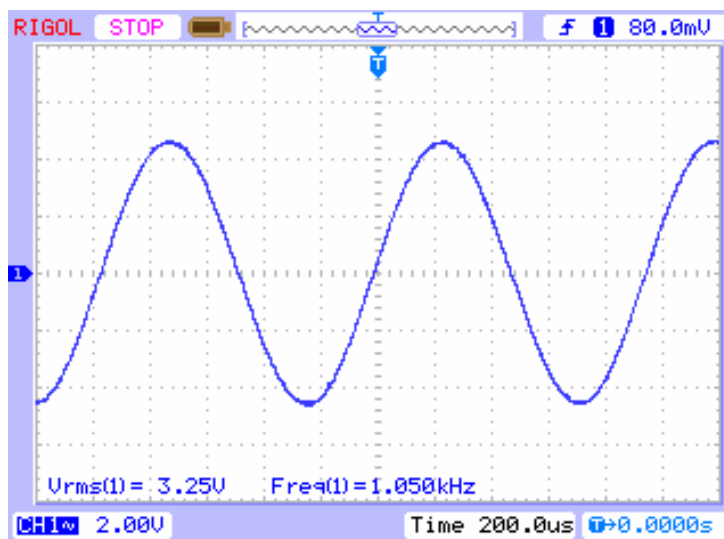

figure 48: S/N measurement with note "C6" at 16' drawbar

This would result in a S/N ratio of ~43dB.

## 15 Final assembly

It looks like I can close this project soon. But before, my organ surprised me again. As you might have seen in some pictures, not everything was nicely arranged during the investigation phase. Some cables hanging around, some grounding points connected only with simple alligator clips, and so on.

To bring this all to a good end, all the temporarily cables were removed and substituted by "correct" wires. Especially the grounding points (safety-grounding of all metallic parts inside the organ) I really tried to make them looking good and reliable. It turned out, that this also had not only a good positive effect on electrical safety, but also on the hum level!

After everything was cabled and assembled nicely, I made one last measurement- and was astonished: only **13mVrms** at the output of the AO28-amp (compare with chapter 14.4: I had 22mVrms there before in "ready-to-play"-mode)!



figure 49: now 13mVrms only!

If we have a look to the corresponding oscillogram:

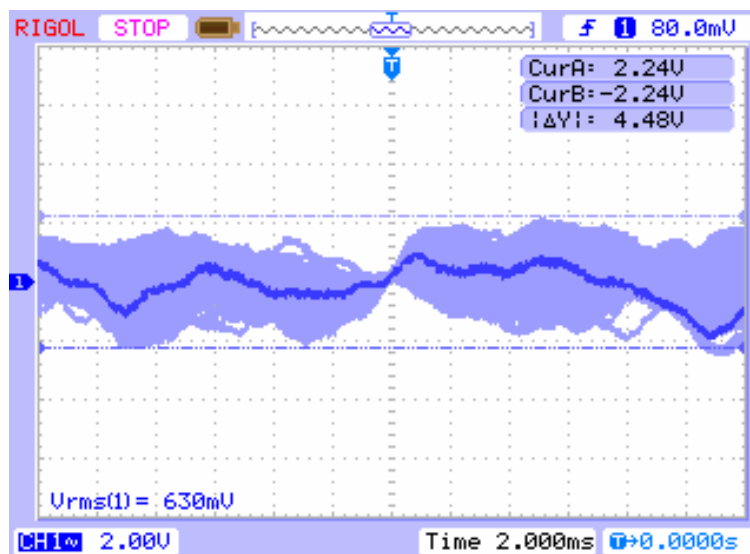

figure 50: only 13mVrms hum level left after final assembly! ☺

This is really big surprise! Obviously caused the better safety grounding the magnetic fields in the transformers to compensate each other better than before so that the residual hum level dropped again by ~4 dB. This is good news, indeed!

Frankly speaking I did not investigate this 4dB improvement in detail again, although a good engineer would have done that. So in the end I cannot say, where this additional performance really comes from. I decided just to enjoy it - without the proofed knowledge where this is actually coming from and whether the magnetic paths have changed or not. If you are interested in that, you are very close to a complete re-engineering of the complete safety-ground concept as well as the audio-ground concept! Good luck with that! :-)



# 16 Conclusion

There are many reasons for a hammond organ to produce hum. But in my case there could be found one dominating reason: magnetical penetration from the OrganMate's power supply transformer into the scanner/vibrato unit into the organ, causing hearable interference.

Many countermeasures were tested, but finally the best=simplest solution was just to reverse the mains connector of the OrganMate's powercord. Modifying the reverb unit in such a way obviously caused some magnetic fields to compensate each other, resulting in a clearly hearable (and measureable) improvement.

As we had to re-adjust the OrganMate after restoration, we changed the system gain with that. So all the reference values, that we measured before, got invalid by doing this. With an unvalid reference point it is hard to say, how much I improved the unwanted hum in total.

But what I can do is, to determine the effect of my "main measure" (=reversing the power line of the OrganMate). Just by swapping the connector again, I can reproduce the old (=humming) condition. In that state, my BK2606 voltmeter says today:

$U_{\text{normal/before}}: \sim 24\text{mVrms}$        $\longrightarrow$        $U_{\text{reversed/after}}: \sim 14\text{mVrms}^*$

So this is an improvement of  $a = 20 \cdot \log\left(\frac{U_{\text{normal}}}{U_{\text{reverse}}}\right) = 4,7\text{dB}$  !

And this is not too bad, folks!

\* As stated in chapter 15, this measurement was only 13mVrms last time. This time, I got 14mVrms. Never mind, there is always a little measurement uncertainty when you are reading values from you voltmeter. And remember, we are measuring tubeamps here - that are well known for their slight variation from day to day, so never mind this.

For those who prefer a more "visible" result, you can take figure 51: in blue is the noise level in "ready-to-play" with the normal connected OrganMate transformer; in yellow the condition with the reversed transformer. Whereas you can clearly see periodic hum dominating in the blue graph, the yellow is much more "flat and noisy"- with much less periodic hum. This is, what we tried to get all the time :-)

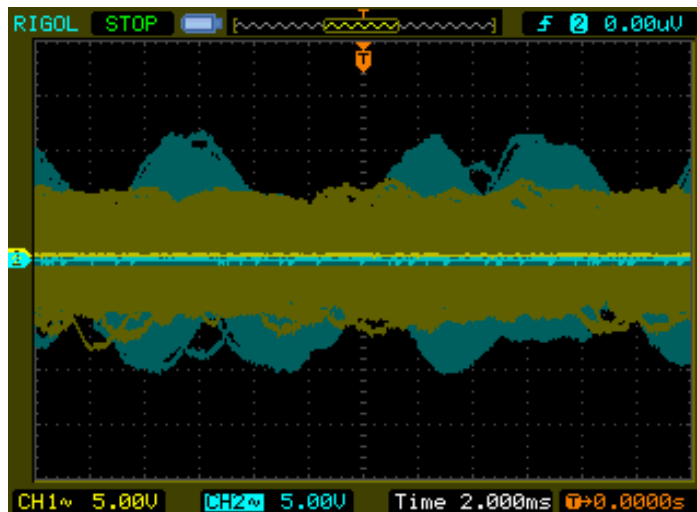

figure 51: before / after comparison

In the end, here is the winner-photo of my Hammond B-3 organ- now with 4,7dB less hum!  
Great! :-)



small weight  
on the key  
"C6"  
to produce  
continuous  
sound during  
measurement

**figure 52: Organ B-3 during measurement**

**Disclaimer:**

This document is protected by copyright law ©. All rights reserved ©.

No copy, distribution, modification. Written only for personal/private use- it is not planned for companies to use this knowhow in a professional/business way.

This report describes technical work that may contain serious risks for your safety! If you plan to check your own organ and are not 100% familiar with electrical safety and protective measures, I highly recommend you to ask a qualified technician for doing this! Electrical gear can cause serious injury to your health when you are not trained to handle all the risks!

This report describes my experiences during this restoration project. No guarantee that this will also work in your equipment and in your special situation. I also feel not responsible for any damages, incidents,... that you might get when using this report as guideline for your own work.

Take care, folks :-)

HNC#316 Marc Michalzik, V1.12  
JUN2013