

UltraDeck®

DECKING
INSTALLATION
GUIDE

ULTRADECK.COM



TABLE OF CONTENTS

JOB SITE STORAGE	3
HARDWARE AND ACCESSORIES	4-5
GENERAL GUIDELINES FOR INSTALLATION	6-10
QUICKCAP™ INSTALLATION	11-12
CLADDING & ENDCAP INSTALLATION	13
CLEANING AND CARE	14-15
WARRANTY	16-17

If you should have any questions, please email
UltraDeckHelpMidwestManufacturing.com before starting your project.

JOB SITE STORAGE

- UltraDeck® must be stored flat and level. Adjust support blocks accordingly.
- When stacking UltraDeck® products, supports should start at each end and be spaced 2' on center. Supports should line up vertically.
- DO NOT stack UltraDeck® products higher than 6 bundles or 12' high.
- COVER MATERIALS ON SITE UNTIL READY FOR INSTALLATION.

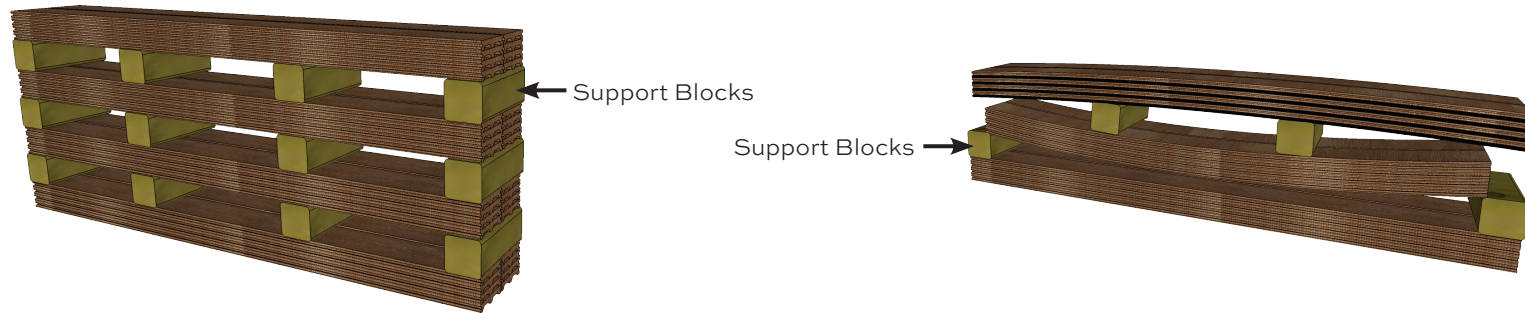

CORRECT STACKING

INCORRECT STACKING

ACCESSORIES & HARDWARE

It's easy and simple to install UltraDeck® over an old deck, or onto an existing or new substructure, with our full range of fasteners and accessories.

COMPLEMENTARY COLORED CLADDING

Use as skirting to cover joists, exposed lumber, and stair stringers, providing a professional, finished appearance. Available in 12' lengths in:

ULTRADECK INSPIRE®

(12 1/8" wide profile)

SKU's: 112-0012-0389



Canyon



Fieldstone



Sandstone



Spanish Cedar

ULTRADECK FUSION®/ FUSION 2.0

(12 1/8" wide profile)

SKU's: 112-0007-0002



Walnut



Rosewood



Coastal Cedar



Driftwood Gray

ULTRADECK TRIUMPH®

(12 1/8" wide profile)

SKU's: 112-0003-0008



Slate



Pecan

ULTRADECK® RUSTIC™

(10 1/2" wide profile)

SKU's: 112-2513-2619



Gray



Hickory



Cedar



Redwood

GRIP FAST® ULTRADECK T-CLIPS®

Composite fastener for Inspire, Fusion, Fusion 2.0, Triumph, Rustic™ and Natural™ Decking. T-Clips® are installed with a drill and screw and will automatically set the proper side gap on decking.



(100 ct)
(25 ct)

SKU: 230-8124
SKU: 230-8122

GRIPFAST® COMPOSITE DECK SCREWS

Optional surface fastener for Rustic™ or Natural™ Radius Edge Boards only. Color matched and designed to reduce “mushrooming” effect of composite material.



SKU's: 230-8045-8062

DEKMOUNT HIDDEN FASTENING SYSTEM®

Recommended for all stair treads, deck boards, and radius board installation to provide a clean, finished look. Available in 8' long, brown powder-coated finish. 3/4" DekMount® premium screws are designed to be used to install both bracket and deck board.



(DekMount®)
(Screws)

SKU: 155-1376
SKU's: 229-1004

QUICKCAP™ HIDDEN FASTENER

For use on UltraDeck® QuickCap™ Automatically sets the recommended gapping between the boards for a clean finish.



SKU: 112-3338

GRIP FAST® ULTRACLIP® HIDDEN DECK FASTENER SYSTEM

Designed for Inspire, Fusion, Fusion 2.0, Triumph, Rustic™ and Natural™ Decking to create a strong and beautiful fastener free finished look.



(UltraClip 45 pc.)
(UltraClip 90 pc.)
(UltraClip 900 pc.)
(Adapter)
(#6 x 1 5/8" Screw)
(1.5" x .113" Collated Nail Screw 930 pc.)

SKU: 230-8114
SKU: 230-8112
SKU: 230-8113
SKU: 230-8115
SKU: 230-8104
SKU: 208-2005

END CAPS

End caps help prevent moisture, dirt, and insect infiltration. They give a clean and professional look to any deck. Available in Natural™ deck and radius edge boards

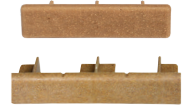

4" Natural Deck Board Cap
6" Natural Radius Edge Board Cap

SKU: 112-2999
SKU: 112-3000

COMPOSITE CLADDING SCREWS

For use on all UltraDeck® Cladding, color matched and designed to reduce “mushrooming” effect of composite material. Actual length of 2".



SKU's: 230-8070-8090

GENERAL GUIDELINES FOR DECK INSTALLATION

DECK FRAMING REQUIREMENTS

Once you decide which way the deck boards will run, determine the span between the joists. Always adjust the joist span to accommodate the deck pattern and stairs. Be sure the foundation is sound, level, and use a minimum of two fasteners for attachment of deck boards to each joist. Be sure to check local codes for additional requirements and information. Additional framing will be required for all butt joints. See nailer board information in Plank & End Gapping. Check local building codes before starting any project!

- Use Masterforce® composite decking blade (SKU 252-6662 7 1/4" or SKU 252-6663 10") for any cutting.
- If the decking substructure is freshly treated, allow adequate dry time to reduce joist movement.
- Decking substructure should be built with a slight angle so that water runs off the decking; a recommended slope is 1/2" drop every 10', away from the building, along the orientation of the decking.
- Ensure that all joists are crowned correctly and that all joists are level across the top as UltraDeck® will conform to the surface contour of the substructure.
- Proper joist spacing is required for proper installation. Joist spacing should never exceed 12" on center. For best results, install wood blocking between each joist, placed every 4'-6' within the structure. This will help reduce movement or twisting of the joists. Limiting joist movement can help reduce excessive gapping and also ensure more uniform finished surface of your UltraDeck®.
- Using joist tape can lengthen the life of the decking substructure.
- Radius edge profiles should be used for stair treads & deck boarder applications.

INSTALLING POSTS TO DECK SUBSTRUCTURE

**For deck designs including railing*

- Step 1.** Determine the location and install the 3 1/2" x 3 1/2" treated posts to the substructure. The maximum post spacing is 6' to the center of each post. Do not notch 3 1/2" x 3 1/2" railing posts.
- Step 2.** Use blocking that is the same size and dimension as the joist members to reinforce the side of the 3 1/2" x 3 1/2" post opposite the rim joist.
- Step 3.** Use three 3" quality deck screws for attaching each end of blocking to joist.
- Step 4.** Secure pre-drilled 3 1/2" x 3 1/2" treated post to the rim joist and reinforcement blocking using two 6" lag screws (minimum spacing of 5 1/4" apart.) Countersink the lag screws if using UltraDeck® cladding.

Note: UltraDeck® post sleeves are designed to fit over dimensional 3 1/2" x 3 1/2" posts. If the 3 1/2" x 3 1/2" posts you are using are outside of standard, trimming or shimming of the 3 1/2" x 3 1/2" edges may be required. Check fit of the 3 1/2" x 3 1/2" post into the post sleeve prior to attaching it to your deck structure and make any changes to the 3 1/2" x 3 1/2" if needed.

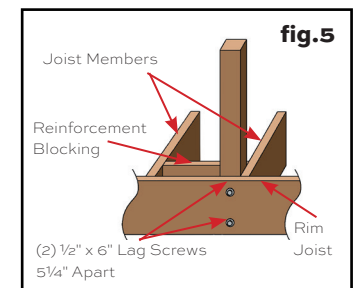
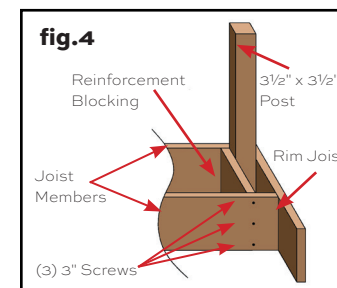
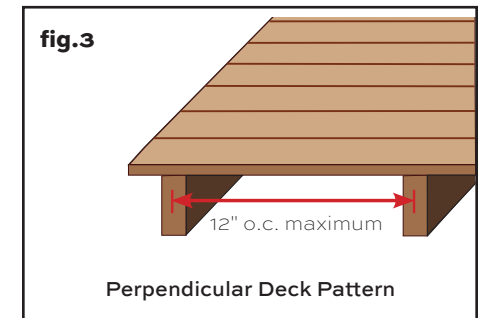
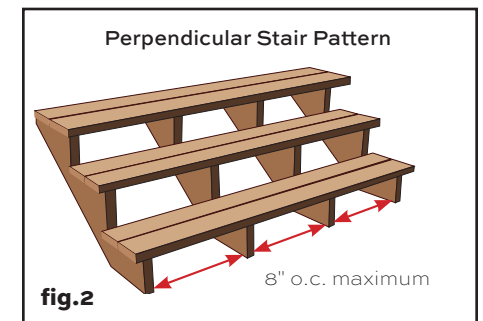
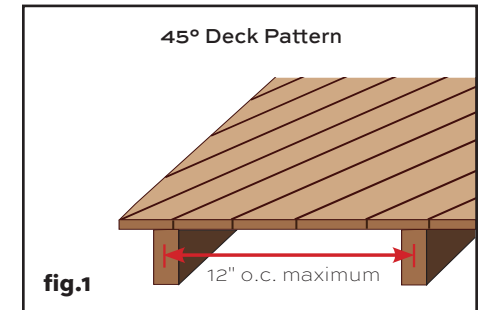

PICTURE FRAMING REQUIREMENTS

When a picture frame is used in decking, it is recommended to use the butt joint method and to add blocking joists at every board end.

- Step 1.** Additional blocking joists will need to be added between the Rim Joist and the 1st joist for every area where picture framing will be added perpendicular to the main direction of decking. The additional framing should be added at 12" on center (Figure 6).
- Step 2.** Lay out deck boards to locate final installation location. There must be solid support under each end cut of the decking. Add extra joist framing where each board will end. Each deck board must be supported by 4 or more joists for proper performance (Figure 7).
- Step 3.** Fasten all deck boards down using 2 T-Clips™ per joist or DekMount with at least 2 screws per board per joist. Make sure to follow the deck board end gapping chart (Figure 10) for gapping between the deck boards.

fig.6

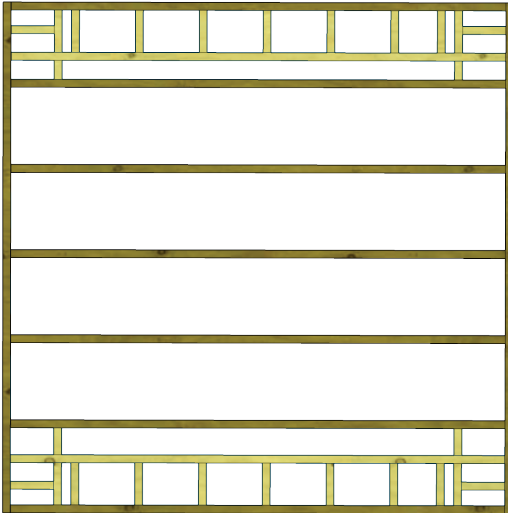
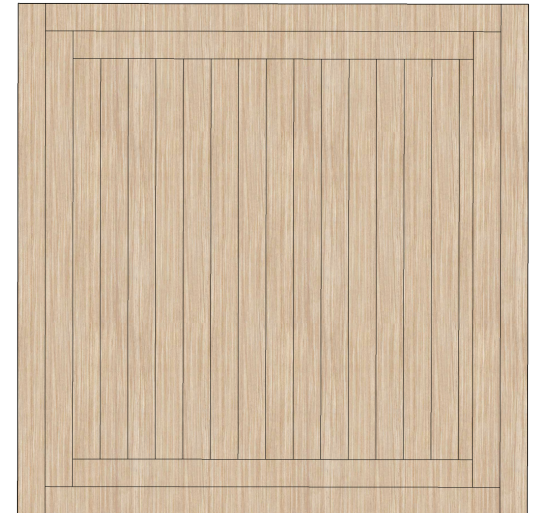

fig.7



fig.8



PLANK & END GAPPING

When installing UltraDeck® decking, gapping guidelines must be followed to ensure that gaps between decking and end gaps allow for proper expansion/contraction, drainage, and the shrinking of treated wood joists that can happen over time.

Note: Changes in length are most significant during the installation process, and should be accounted for if working in extreme temperatures. A good example would be cutting your planks during a hot afternoon, letting them sit outside overnight in the cool air and then installing them the next morning. Chances are, you will notice a certain amount of contraction. The best way to minimize this problem is to fasten your planks as soon as possible after cutting them.

NATURAL™, RUSTIC™, TRIUMPH, FUSION 2.0, FUSION, & INSPIRE

For every 16' of plank, allow a 1/16" gap for every 20°F temperature difference between the time of board installation and the maximum expected temperature (refer to the end gapping chart, Figure 9). With all fastening methods, make sure to use two fasteners for attachment of deck boards to each joist.

NAILER BOARDS

Two additional nailer boards will need to be added to the framing material at any butt joint connection to properly end gap UltraDeck® planks. Additional nailer boards must be installed at all end gaps no matter what installation method used. See Figure 2. DO NOT use decking pieces shorter than 48" on any decking surface other than stairs.

T-CLIPS

Install two UltraDeck T-Clips® to each board at every end gap. The additional nailer boards must be used to aid in supporting the deck planks and proper T-Clip placement. See Figure 2. If installing decking in temperatures below 60°F, it is recommended to use UltraClips.

DEKMOUNT

Install DekMount onto each joist by screwing a 3/4" premium screw through side hole in DekMount. Install deck planks one at a time, from the end of the deck, working back towards the house or walled structure. Install two pieces of DekMount on either board at butt joints.

SURFACE SCREWING

When using screws through the top side of decking, at each end of the plank, pre-drill and sink screws at least 3/4" away from the edge of the plank to prevent splitting. DO NOT over-tighten the fasteners. See surface screwing installation on page 10.

Looking to install as the weather gets cooler? Here are a few tips and tricks.

Step 1. Be sure to follow proper storage guidelines found on page 3.

Step 2. BoWrench® (SKU 2371995) may be a great addition to your tools list. This tool will help to move boards into the right place with minimal effort.

Step 3. Use the sun to your advantage. Storing boards in the sun on a flat level area will help provide flexibility and create an easier install.

We advise working on the deck in full sun when possible.

Step 4. We recommend using metal fasteners, such as GripFast® UltraClips® when installing decking at/below 60°F. Plastic fasteners are known to expand/contract in cooler weather, whereas the metal clips will hold form and keep your experience smooth.

End Gapping Chart

fig.9

END GAP DISTANCE FOR EVERY 16' OF PLANK						
Current Temp	Maximum Expected Temperature					
	70	80	90	100	110	120
40	3/32"	1/8"	5/32"	3/16"	7/32"	1/4"
50	1/16"	3/32"	1/8"	5/32"	3/16"	7/32"
60	1/32"	1/16"	3/32"	1/8"	5/32"	3/16"
70	---	1/32"	1/16"	3/32"	1/8"	5/32"
80	---	---	1/32"	1/16"	3/32"	1/8"
90	---	---	---	1/32"	1/16"	3/32"
100	---	---	---	---	1/32"	1/16"



T-CLIP™ / DEKMOUNT® fig.10

END GAPPING SOLUTIONS

A deck board installed as a joining board at the seams will minimize the look of end to end contraction by separating the visual gap.



fig.11

ULTRADECK® PLANK BOARD INSTALLATION

SIDE-TO-SIDE GAPPING

When installing decking with a T-Clip or UltraClip®, the fasteners will automatically set the side-to-side gapping of the decking. If installing decking using DekMount or surface screwing options (see Fastening Systems on page 5) a minimum of $\frac{3}{16}$ " gap will need to be left between planks. If the temperature is below 40°F at the time of installation, a $\frac{3}{8}$ " gap is recommended.

T-CLIP™ INSTALLATION

Follow the deck framing tips, the plank gapping, and end gapping pages to begin your plank installation. These steps are key to ensure your decking is properly installed to last for many years. Before installing Fusion or Inspire decking, be sure to look over all your boards and note color differences in order to distribute the boards in a pleasing, natural looking manner. Use the T-Clip calculator on ultradeck.com to help estimate how many T-Clips you need. If installing decking in temperatures below 60°F, it is recommended to use UltraClips.

Note: T-Clips have arrows on them to show which way of installation. Always have arrows pointing towards last completed deck board. Make sure all arrows are facing the same direction.

INSTALLING PLANKS THAT RUN PARALLEL TO A HOUSE

Step 1A. Pre-drill the first UltraDeck® plank along the outer lip every 8". Fasten it to the rim joist with $1\frac{5}{8}$ " premium deck screws. Do not use UltraDeck T-Clips® to secure the outside edge of the first board.

Step 2A. Install a row of UltraDeck T-Clips® at every joist along the deck frame (A). Then, slide the next UltraDeck® plank into place (B). Attach the next row of UltraDeck® T-Clips™, sliding the next plank into place (C). Continue this process until the deck surface is covered.

Step 3A. Finish by securing the final board with UltraDeck T-Clips® to the ledger along the house at every joist. If necessary, cut the final board down to fit, pre-drill every 8", and fasten it to the ledger with premium deck screws.

INSTALLING PLANKS THAT RUN PERPENDICULAR TO A HOUSE

Step 1B. Begin by pre-drilling the first plank along the outer lip every 8". Fasten the plank to the rim joist with $1\frac{5}{8}$ " premium deck screws. UltraDeck T-Clips® are not used on the outside edge of the first board.

Step 2B. Install a row of UltraDeck T-Clips® at every joist along the deck frame (A). Then, slide the next UltraDeck® plank into place (B). Attach the next row of UltraDeck T-Clips®, sliding the next plank into place (C). Continue this process until the deck surface is covered.

Step 3B. Pre-drill the last UltraDeck® plank along the outer lip every 8". Fasten it to the rim joist with $1\frac{5}{8}$ " premium deck screws. Do not use UltraDeck T-Clips® to secure the outside edge of the last board.

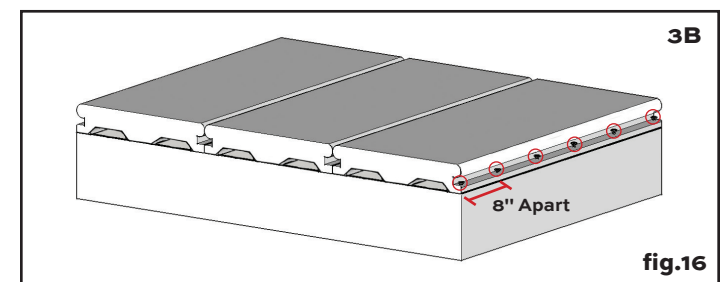
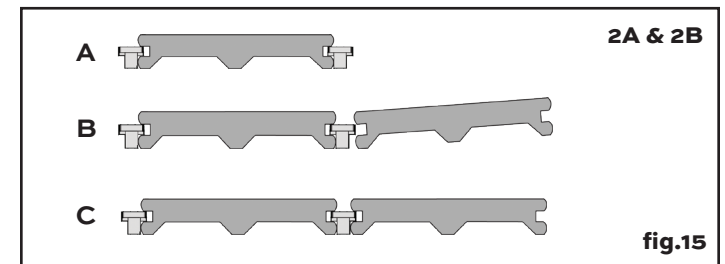
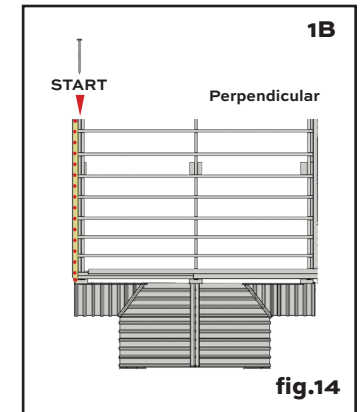
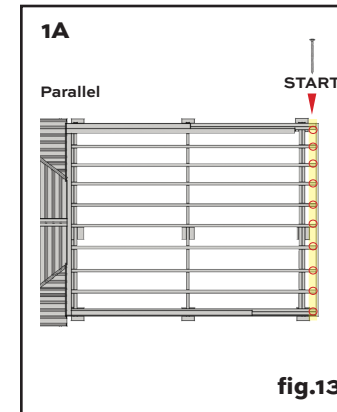
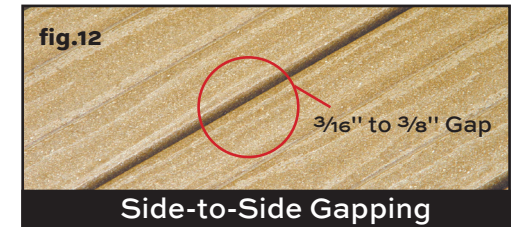

DEKMOUNT INSTALLATION

Follow the deck framing tips, the plank gapping, and end gapping pages to begin your plank installation. These steps are key to ensure your decking is properly installed to last for many years. Before installing Fusion decking, be sure to look over all your boards and note color differences in order to distribute the boards in a pleasing, natural looking manner.

Step 1. Install DekMount onto each joist by screwing a 3/4" premium screw through side hole in DekMount. DekMount should be flush on top of the joist and flat against the side of the joist. DekMount is easily cut with snips to fit in any required length. Stagger DekMount butt joints so they don't land in the same location on each joist. 12" is recommended for staggering of butt joints.

Step 2. Install deck planks one at a time, from the end of the deck, working back towards the house or walled structure. This allows you to reach the last plank attached from beneath the deck. The deck planks should be located and spaced using side to side and end gapping charts before screwing. Screw from the bottom; for best results, do not screw at the edge. By kneeling on top of the plank and reaching underneath, the screws are driven upwards through the DekMount and into the plank. DekMount is designed to provide for a minimum of 2 holes for each plank. If the deck is elevated and is easier to fasten from below the deck, another person should be on top of the deck, not only to ensure proper spacing, but to provide weight; allowing the screws to securely anchor deck board.

Note: Use of clamp to secure board in place prior to fastening will aid in installation.

SURFACE SCREWING INSTALLATION

**For Rustic™ & Natural™ radius boards only*

Follow the deck framing tips, the plank gapping, and end gapping pages to begin your plank installation. These steps are key to ensure your decking is properly installed to last for many years.

Note: When using this method, use composite deck screws, or 2 1/2" conventional deck screws. Composite deck screws are recommended for this application, as they pull shavings into the screw hole, eliminating the "mushrooming effect". When using conventional deck screws, you must pre-drill and countersink for each screw to avoid the "mushrooming effect".

Step 1. Begin screwing, keeping screws at least 3/4" away from the edge or end of the plank to prevent splitting.

It is necessary to pre-drill and countersink at each end of an UltraDeck® board. Always add additional nailer boards at butt seams (see page 6). Do not over tighten fasteners. When fastening Natural™ Radius planks, screws must be passed through the interior channel to avoid compression of the planks (2 screws must be placed on each board at every joist).

Note: For radius board installation, follow DekMount or surface screwing installation instructions. If installing decking planks with T-Clips, follow Step 3 of T-Clip installation on final grooved deck (at perpendicular joists only). For deck framing perimeter applications, additional bridging joists every 12" may be required to support radius edge boards installed in perimeter applications.

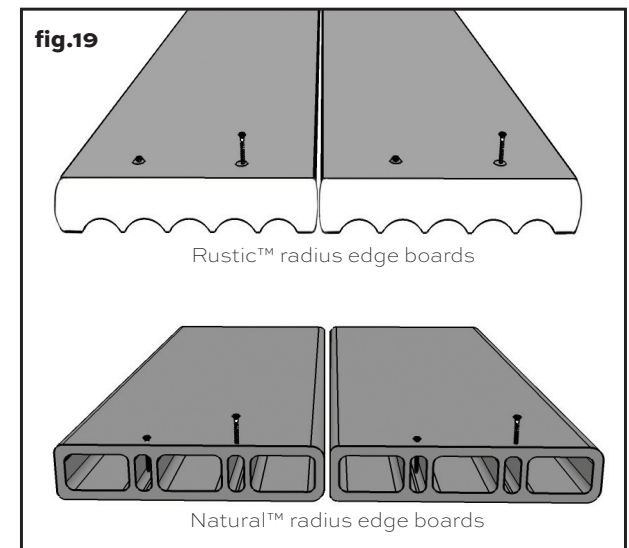
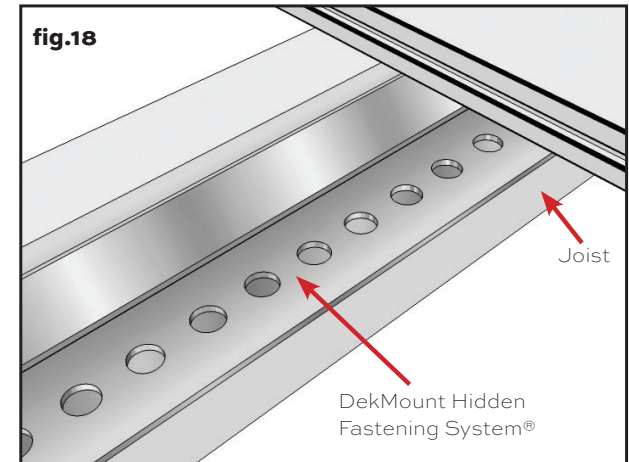
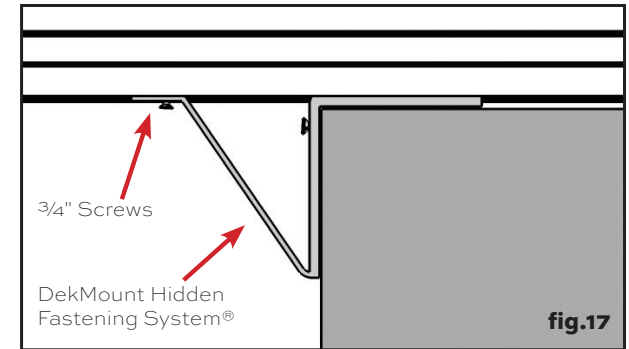

QUICKCAP™ INSTALLATION

QUICKCAP™ SITE PREPARATION

Check the condition of your current deck to make sure it is sound. If any part of the substructure or the surface is showing decay, make repairs prior to installing the QuickCap™ boards. Any raised or twisted boards should be fastened down with quality 3" premium deck screws, tightened until the deck surface is level, Figure 1. If there are any areas where two deck boards come together end to end on top of a joist, the joist should be inspected for structural stability (an additional joist should be added if needed). If using additional screws and joists is not successful in smoothing out the deck surface, sand down any raised edges using an abrasive sanding disk attached to an angle grinder, Figure 2. Existing decking must be properly side gapped to provide proper drainage. QuickCap™ is designed as a resurfacing material for existing wood decks. QuickCap™ must be installed on top of an existing wood deck, and can not be installed over concrete, open framing, plywood, or other non-wood decking material.

QUICKCAP™ END GAPPING

If two QuickCap™ boards are spliced, a joining board installed at the seams will minimize the amount of visual end-to-end gap, Figure 3. This is done by separating the end-to-end gapping. If splices are needed and the joining board method is not used, it is recommended to stagger splices by two feet or more and use QuickCap™ Fasteners 3/4" to 2" at each side of the splice, Figure 4. QuickCap™ boards expand and contract with temperature changes. Follow the End Gapping Chart if any splices are needed to cover the surface of your old deck, Figure 5.

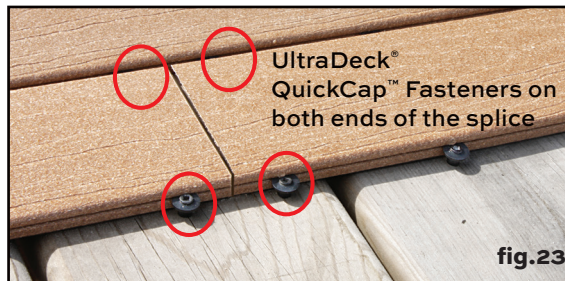

fig.25 End Gapping Chart

END GAP DISTANCE FOR EVERY 16' OF PLANK

Current Temp	Maximum Expected Temperature					
	70	80	90	100	110	120
40	3/32"	1/8"	5/32"	3/16"	7/32"	1/4"
50	1/16"	3/32"	1/8"	5/32"	3/16"	7/32"
60	1/32"	1/16"	3/32"	1/8"	5/32"	3/16"
70	---	1/32"	1/16"	3/32"	1/8"	5/32"
80	---	---	1/32"	1/16"	3/32"	1/8"
90	---	---	---	1/32"	1/16"	3/32"
100	---	---	---	---	1/32"	1/16"

QUICKCAP™ INSTALLATION

- Step 1.** Snap a chalk line, parallel to the existing surface, at 1 1/2" in from the edge of the deck to act as a reference. Add an additional chalk line every 16" to mark the placement of each QuickCap™ fastener. If the chalk line falls in the gap between the existing deck boards, move the line back until the line is at least 3/4" in from the edge of the existing deck boards. This will decrease the space between this line and the previous line making sure the chalk lines do not exceed the recommended 16" spacing. The 16" spacing for additional lines will continue from this adjusted line.
- Step 2.** Color-matched cladding screws may be used to attach the first section of the QuickCap™ boards along the outside edge of the deck. Pre-drill with 1/8" bit and countersink each screw. These screws should be placed every 16" and go through the first leg that is at least 1 1/4" in from the outside edge.
- Step 3.** Install a row of QuickCap™ fasteners on the chalk lines, one every 16". Then slide the QuickCap™ plank into place. Continue this process until the deck surface is covered. Do not over tighten the fasteners; this will not allow the clip head to line up with the groove in the plank.
- Step 4.** QuickCap™ boards can be ripped down when less than a full width is needed. Fasten the unaltered edge of the board to the existing deck with a QuickCap™ Fastener. Then fasten the altered edge by pre-drilling and fastening with color matched cladding screws to the cut side of the board.
- Step 5.** Color-matched cladding screws may be used to attach the last section of the QuickCap™ boards along the outside edge of the deck. Pre-drill and countersink each screw. These screws should be placed every 16" and go through the first leg that is at least 1 1/4" in from the outside edge.

Note: Cladding screws are only to be used to fasten the first and last boards. QuickCap™ fasteners should be used to fasten decking, surface screwing installation is not an approved fastening method.

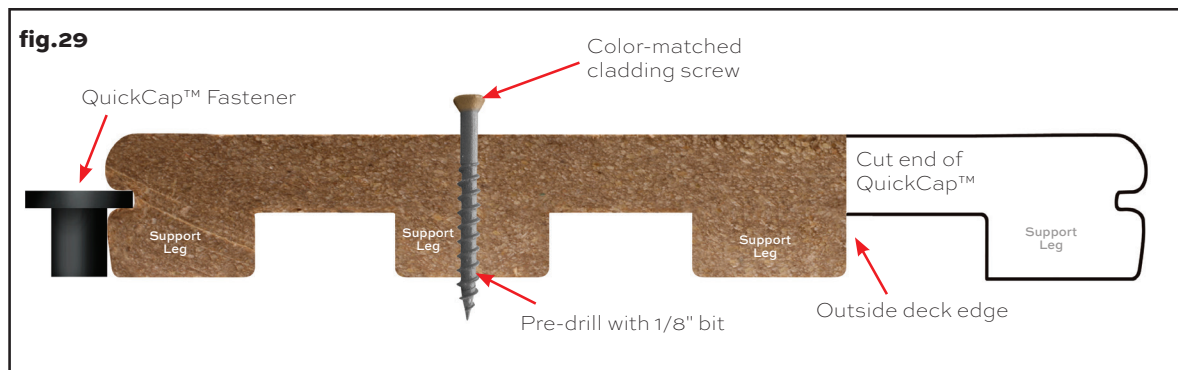
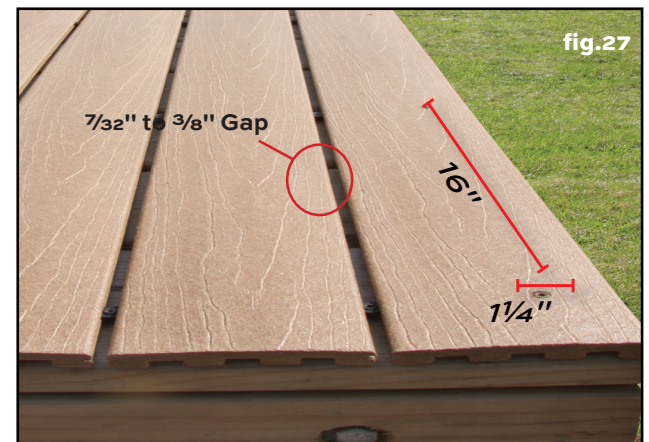
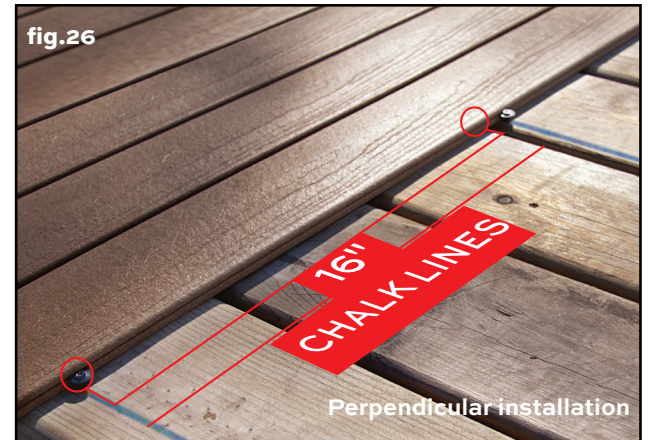

CLADDING & END CAP INSTALLATION

ULTRADECK® CLADDING

Cladding Dimensions:

UltraDeck Triumph®, Fusion, Fusion 2.0, Inspire: 1/2" x 12 1/8" x 12'

UltraDeck® Rustic™: 7/16" x 10 1/2" x 12'

Cladding will provide a professional finished look to your deck. UltraDeck® cladding can be used as skirting to cover joist members, elevated support posts, outside edges of board profiles, stair stringers, and other exposed lumber products.

When attaching cladding to the deck frame, use color-matched cladding screws. In order to be sure there is enough room for proper expansion and contraction of the UltraDeck® planks, leave a 1/16" gap between cladding and deck boards. Pre-Drill with a 3/16" bit, through the cladding only, then starting 1 1/2" from the top and bottom edge of the cladding every 12". Screws should be snug but it is important not to over tighten the screws.

For long distances requiring multiple pieces of UltraDeck® cladding, use opposing miter cuts at the seam to reduce visible joints, leaving a 1/8" gap between the cuts to allow for expansion, Figure 31.

ULTRADECK® PLANK ENDCAPS

**For Natural™ boards only*

Endcaps are a great way to protect your UltraDeck® with hollow profiles by helping create a barrier against moisture, dirt, and insect infestation. They can provide a clean, professional look to end cuts made at a 90° angle. Endcaps are not necessary for any butt joints in the deck. If desired, a silicone adhesive caulk may be used to further secure endcaps to the planks.

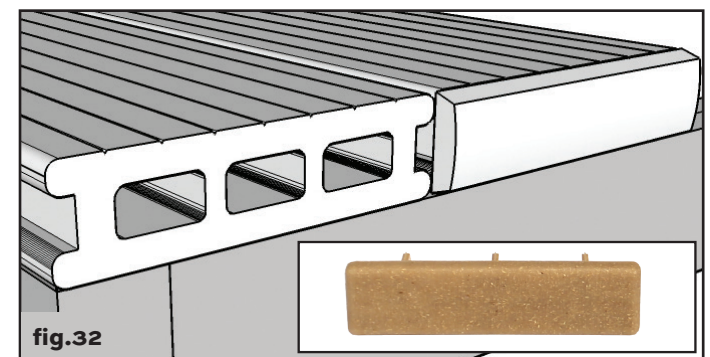
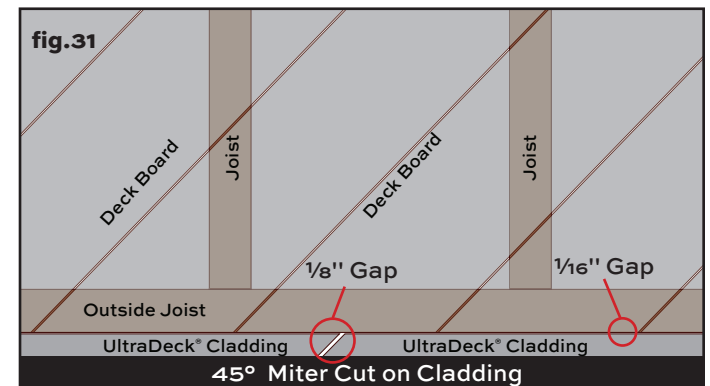

ULTRADECK® CLEANING & CARE

UltraDeck® should be periodically cleaned, at least twice a year, with soap and water or any product made for washing composite decking. Check out the how-to-video for cleaning any UltraDeck® decking and railing products on ultradeck.com. For cleaning of more stubborn dirt and debris, follow these guidelines:

PROBLEM

SOLUTION

CUTTING

Use Masterforce® composite decking blade (SKU 252-6662 7 1/4" or SKU 252-6663 10") for any cutting, available at your local Menards®.

SETTING SIDE GAPPING

Use BoWrench® board bending Tool (SKU 237-1995) to assist in setting gaps and fastening, available at your local Menards®.

CHALK LINES

Most colored chalks are permanent. Use Irwin® Dust-Off Marking Chalk (SKU 244-3224), available at your local Menards®.

WATER SPOTS, LEAF STAINING AND WOOD TANNINS

Tannin leaching occurs naturally in UltraDeck® and all wood-based products. Allow for at least 12 weeks of normal weathering for spots to disappear.

SCUFFS AND ABRASIONS

Scuffs and abrasions can fade or disappear naturally after 12-16 weeks of weathering.

RUST STAINS, GROUND-IN DIRT AND GRIME AND PIGMENT STAINING

Use soap and water to clean your deck. If further cleaning is needed, use Wolman™ DeckBrite® (SKU 553-9932), available at your local Menards®.

MOLD AND MILDEW

Semi-annual (spring and fall) cleaning of your deck is important to prevent buildup of pollen and other debris that can support mold growth. If mold colonies appear, clean the deck with soap and water. If further cleaning is needed, use Wolman DeckBrite (SKU 553-9932), available at your local Menards®. If the deck has not been cleaned regularly, it may require several washes to completely remove all mold colonies.

OIL, GREASE AND FOOD

Rinse the stain with hot water as soon as possible. To remove stains, use Oil Grabber (SKU 561-6025), available at your local Menards®.

USING A PRESSURE WASHER

A pressure washer may be used on your UltraDeck® deck. Use no more than 1500psi with a fan tip kept at least 12" away from the deck.

SANDING

Sanding is not recommended. Sanding will change the appearance of the surface of UltraDeck® material and will void the warranty with respect to any condition caused by the sanding.

ICE AND SNOW

Non-corrosive and non-dyed varieties of ice melting substances should be selected for use on UltraDeck® products. Once the ice melting product has melted unwanted ice, the remaining solids should be swept away. As with any surface, prolonged exposure to ice melting products can lead to a residue appearing on the decking. Once warm weather permits, wash the deck of residue left by melted ice and snow. Never use a metal snow shovel, or shovel with a metal edge on an UltraDeck® deck. The shovel may scratch the deck, which is not covered under warranty.

DIRT AND DEBRIS

Clean deck to remove dirt and debris. Soap and water is all that is needed.

USING A LADDER

When using a ladder on composite decking, it is mandatory to lay down a sheet of plywood over the deck surface to disperse the load of the ladder's feet to nearby underlying joists. The ladder's feet may scratch the deck, which is not covered under warranty. Drill fasteners downward through the top of the plywood sheet to keep it from slipping. Position the fasteners so they adequately protrude and rest firmly in the gaps between the deck boards and into the joists. This will avoid leaving holes in your decking once the plywood sheet is removed. Always follow the ladder manufacturer's instructions and safety tips.

USING PATIO FURNITURE

When using patio furniture on composite decking, make sure the furniture pieces have non-abrasive feet. Any damage caused by the abrasive feet is not covered under warranty.

ULTRADECK® WARRANTY INFORMATION

LIMITED 10 YEAR WARRANTY (NATURAL™, QUICKCAP™, RUSTIC™)

WARRANTY: Midwest Manufacturing® warrants to the original purchaser of the Natural™, QuickCap™, or Rustic™ UltraDeck® decking product that the product will not split, rot, warp, or suffer structural damage from fungal decay for a period of ten (10) years. The warranty period begins on the date the product was purchased and ends ten (10) years later or when the property on which the UltraDeck® product was originally installed has transferred ownership, whichever comes earlier. Midwest Manufacturing® warrants that the UltraDeck® product will be resistant to permanent staining resulting from spills of food and beverage items that would typically be present on a residential deck. The UltraDeck product is not stain proof. Stains may result when substances are not properly cleaned and the product is exposed to UV Rays.

LIMITATIONS: This warranty applies only to the original purchaser who purchased the product for residential purposes. This warranty does not apply if the product is used for non-residential purposes. This warranty is non-transferable, and the original purchaser must present an original purchase invoice or receipt to be eligible. This warranty applies only if the product is properly installed, cared for, and maintained in accordance with the UltraDeck® installation instructions. Otherwise, this warranty is void. This warranty does not cover defects that occur through normal wear and tear, misuse of the product, negligence in the use of the product, or improper storage and handling prior to installation. This warranty does not cover defects due to movement of the structure to which the product is attached, improper design of the structure, acts of nature, or environmental conditions such as mold, mildew, or external debris on the decking surface. Minor surface irregularities and color differences are a natural characteristic of polyethylene and may be slightly visible on the wood grain surface and underside of decking. Any such irregularities do not constitute a product defect. THIS WARRANTY IS EXCLUSIVE AND IN LIEU OF ANY OTHER WARRANTIES, INCLUDING ANY WARRANTIES OF MERCHANTABILITY OR FITNESS FOR A PARTICULAR PURPOSE. MIDWEST MANUFACTURING® SPECIFICALLY DISCLAIMS ALL OTHER WARRANTIES, LIABILITIES, AND OBLIGATIONS. MIDWEST MANUFACTURING® SHALL NOT BE BOUND BY ANY OF ITS EMPLOYEES' ORAL OR WRITTEN STATEMENTS UNLESS THE STATEMENTS ARE SIGNED BY A REPRESENTATIVE OF MIDWEST MANUFACTURING®.

REMEDY: During the warranty period, Midwest Manufacturing® will replace the UltraDeck® product that it deems defective, at its own discretion. If replacement is not feasible, Midwest Manufacturing® may offer a merchandise credit to cover the items it deems defective. REPLACEMENT PRODUCT OR A MERCHANDISE CREDIT SHALL BE THE SOLE AND EXCLUSIVE REMEDY FOR ANY DEFECT. Replacement UltraDeck® product will be as close in color, design, and quality to the original product as reasonably possible, at the discretion and determination of Midwest Manufacturing®. However, Midwest Manufacturing® cannot guarantee an exact match, as colors and designs may change. Replacement product will be sent to the Menards® store where the product was originally purchased. The original purchaser must then, at his or her own expense, pick up the replacement product. THE ORIGINAL PURCHASER MUST PAY ALL COSTS OF THE REMOVAL OF DEFECTIVE PRODUCT, TRANSPORTATION, AND INSTALLATION OF THE REPLACEMENT PRODUCT, INCLUDING LABOR. MIDWEST MANUFACTURING® SHALL NOT BE RESPONSIBLE FOR ANY INCIDENTAL OR CONSEQUENTIAL DAMAGES, INCLUDING BUT NOT LIMITED TO LABOR, LOSS OR DAMAGE TO PERSONAL OR REAL PROPERTY, INCONVENIENCE, PAYMENTS TO THIRD PARTIES, OR LOSS OF INCOME. This warranty provides you with specific legal rights, and you may have other rights under the state law. Some states do not allow for the limitation or exclusion of incidental or consequential damages or limits on the length of an implied warranty, so some of the limitations or exclusions in this document may not apply to you.

LIMITED 25 YEAR WARRANTY (TRIUMPH , FUSION, FUSION 2.0, INSPIRE)

WARRANTY: Midwest Manufacturing® warrants to the original purchaser of the Triumph, Fusion, Fusion 2.0, or Inspire UltraDeck® decking product that the product will not split, rot, warp, or suffer structural damage from fungal decay for a period of twenty-five (25) years. The warranty period begins on the date the product was purchased and ends twenty-five (25) years later or when the property on which the UltraDeck® product was originally installed has transferred ownership, whichever comes earlier. Midwest Manufacturing® warrants that the UltraDeck® product will be resistant to permanent staining resulting from spills of food and beverage items that would typically be present on a residential deck. The UltraDeck product is not stain proof. Stains may result when substances are not properly cleaned and the product is exposed to UV Rays. Midwest Manufacturing® warrants that the UltraDeck® product will not change color in excess of 4 Delta E Hunter units. Midwest Manufacturing® does not warrant that the UltraDeck® product is fade proof. The warranty for stain and fade resistance is subject to the twenty-five (25) year UltraDeck Triumph®, Fusion, Fusion 2.0, or Inspire Prorated Stain and Fade Limited Warranty Schedule.

LIMITATIONS: This warranty applies only to the original purchaser who purchased the product for residential purposes. This warranty does not apply if the product is used for non-residential purposes. This warranty is non-transferable, and the original purchaser must present an original purchase invoice or receipt to be eligible. This warranty applies only if the product is properly installed, cared for, and maintained in accordance with the UltraDeck® installation instructions. Otherwise, this warranty is void. This warranty does not cover defects that occur through normal wear and tear, misuse of the product, negligence in the use of the product, or improper storage and handling prior to installation. This warranty does not cover defects due to movement of the structure to which the product is attached, improper design of the structure, acts of nature, or environmental conditions such as mold, mildew, or external debris on the decking surface. Minor surface irregularities and color differences are a natural characteristic of polyethylene and may be slightly visible on the wood grain surface and underside of decking. Any such irregularities do not constitute a product defect. **THIS WARRANTY IS EXCLUSIVE AND IN LIEU OF ANY OTHER WARRANTIES, INCLUDING ANY WARRANTIES OF MERCHANTABILITY OR FITNESS FOR A PARTICULAR PURPOSE. MIDWEST MANUFACTURING® SPECIFICALLY DISCLAIMS ALL OTHER WARRANTIES, LIABILITIES, AND OBLIGATIONS. MIDWEST MANUFACTURING® SHALL NOT BE BOUND BY ANY OF ITS EMPLOYEES' ORAL OR WRITTEN STATEMENTS UNLESS THE STATEMENTS ARE SIGNED BY A REPRESENTATIVE OF MIDWEST MANUFACTURING®.**

REMEDY: During the warranty period, Midwest Manufacturing® will replace the UltraDeck® product that it deems defective, at its own discretion. If replacement is not feasible, Midwest Manufacturing® may offer a merchandise credit to cover the items it deems defective. **REPLACEMENT PRODUCT OR A MERCHANDISE CREDIT SHALL BE THE SOLE AND EXCLUSIVE REMEDY FOR ANY DEFECT.** Replacement UltraDeck® product will be as close in color, design, and quality to the original product as reasonably possible, at the discretion and determination of Midwest Manufacturing®. However, Midwest Manufacturing® cannot guarantee an exact match, as colors and designs may change. Replacement product will be sent to the Menards® store where the product was originally purchased. The original purchaser must then, at his or her own expense, pick up the replacement product. **THE ORIGINAL PURCHASER MUST PAY ALL COSTS OF THE REMOVAL OF DEFECTIVE PRODUCT, TRANSPORTATION, AND INSTALLATION OF THE REPLACEMENT PRODUCT, INCLUDING LABOR. MIDWEST MANUFACTURING® SHALL NOT BE RESPONSIBLE FOR ANY INCIDENTAL OR CONSEQUENTIAL DAMAGES, INCLUDING BUT NOT LIMITED TO LABOR, LOSS OR DAMAGE TO PERSONAL OR REAL PROPERTY, INCONVENIENCE, PAYMENTS TO THIRD PARTIES, OR LOSS OF INCOME.** This warranty provides you with specific legal rights, and you may have other rights under the state law. Some states do not allow for the limitation or exclusion of incidental or consequential damages or limits on the length of an implied warranty, so some of the limitations or exclusions in this document may not apply to you.



فيا