

# Dell XPS 14

# Owner's Manual

Computer model: XPS L421X  
Regulatory model: P30G  
Regulatory type: P30G001



# Notes, Cautions, and Warnings



**NOTE:** A NOTE indicates important information that helps you make better use of your computer.



**CAUTION:** A CAUTION indicates potential damage to hardware or loss of data if instructions are not followed.



**WARNING:** A WARNING indicates a potential for property damage, personal injury, or death.

---

© 2012 Dell Inc.

Trademarks used in this text: Dell™, the DELL logo, and XPS™ are trademarks of Dell Inc.; Microsoft®, Windows®, and the Windows start button logo  are either trademarks or registered trademarks of Microsoft corporation in the United States and/or other countries; Bluetooth® is a registered trademark owned by Bluetooth SIG, Inc. and is used by Dell under license.

# Contents

<b>Before You Begin</b> . . . . .	<b>9</b>
Turn Off Your Computer and Connected Devices. . . . .	9
Safety Instructions. . . . .	9
Recommended Tools. . . . .	10
<b>After Working Inside Your Computer</b> . . . . .	<b>11</b>
<b>Removing the Base Cover</b> . . . . .	<b>12</b>
Procedure . . . . .	12
<b>Replacing the Base Cover</b> . . . . .	<b>15</b>
Procedure . . . . .	15
<b>Removing the System Badge</b> . . . . .	<b>16</b>
Prerequisites. . . . .	16
Procedure . . . . .	16
<b>Replacing the System Badge</b> . . . . .	<b>18</b>
Procedure . . . . .	18
Postrequisites. . . . .	18
<b>Removing the Battery-LED Board</b> . . . . .	<b>19</b>
Prerequisites. . . . .	19
Procedure . . . . .	19
<b>Replacing the Battery-LED Board</b> . . . . .	<b>21</b>
Procedure . . . . .	21
Postrequisites. . . . .	21
<b>Removing the Speakers</b> . . . . .	<b>22</b>
Prerequisites. . . . .	22
Procedure . . . . .	22
<b>Replacing the Speakers</b> . . . . .	<b>24</b>
Procedure . . . . .	24
Postrequisites. . . . .	24

<b>Removing the Battery</b> . . . . .	<b>25</b>
Prerequisites. . . . .	25
Procedure . . . . .	25
<b>Replacing the Battery</b> . . . . .	<b>26</b>
Procedure . . . . .	26
Postrequisites. . . . .	26
<b>Removing the Memory Module</b> . . . . .	<b>27</b>
Prerequisites. . . . .	27
Procedure . . . . .	27
<b>Replacing the Memory Module.</b> . . . . .	<b>29</b>
Procedure . . . . .	29
Postrequisites. . . . .	30
<b>Removing the Wireless Mini-Card</b> . . . . .	<b>31</b>
Prerequisites. . . . .	31
Procedure . . . . .	31
<b>Replacing the Wireless Mini-Card</b> . . . . .	<b>33</b>
Procedure . . . . .	33
Postrequisites. . . . .	33
<b>Removing the mSATA/WWAN Mini-Card.</b> . . . . .	<b>34</b>
Prerequisites. . . . .	34
Procedure . . . . .	34
<b>Replacing the mSATA/WWAN Card</b> . . . . .	<b>35</b>
Procedure . . . . .	35
Postrequisites. . . . .	35
<b>Removing the Hard Drive</b> . . . . .	<b>36</b>
Prerequisites. . . . .	36
Procedure . . . . .	36
<b>Replacing the Hard Drive.</b> . . . . .	<b>39</b>
Procedure . . . . .	39
Postrequisites. . . . .	39

<b>Removing the Power/Battery Status-Light Board</b>	<b>40</b>
Prerequisites . . . . .	40
Procedure . . . . .	40
<b>Replacing the Power/Battery Status-Light Board</b>	<b>42</b>
Procedure . . . . .	42
Postrequisites . . . . .	42
<b>Removing the Coin-Cell Battery</b>	<b>43</b>
Prerequisites . . . . .	43
Procedure . . . . .	43
<b>Replacing the Coin-Cell Battery</b>	<b>44</b>
Procedure . . . . .	44
Postrequisites . . . . .	44
<b>Removing the Fan</b>	<b>45</b>
Prerequisites . . . . .	45
Procedure . . . . .	45
<b>Replacing the Fan</b>	<b>46</b>
Procedure . . . . .	46
Postrequisites . . . . .	46
<b>Removing the Processor Heat-Sink</b>	<b>47</b>
Prerequisites . . . . .	47
Procedure . . . . .	47
<b>Replacing the Processor Heat-Sink</b>	<b>48</b>
Procedure . . . . .	48
Postrequisites . . . . .	48
<b>Removing the I/O Board</b>	<b>49</b>
Prerequisites . . . . .	49
Procedure . . . . .	49
<b>Replacing the I/O Board</b>	<b>51</b>
Procedure . . . . .	51
Postrequisites . . . . .	51

<b>Removing the System Board</b> . . . . .	<b>52</b>
Prerequisites. . . . .	52
Procedure . . . . .	53
<b>Replacing the System Board</b> . . . . .	<b>57</b>
Procedure . . . . .	57
Postrequisites. . . . .	57
Entering the Service Tag in the BIOS. . . . .	57
<b>Removing the Air Vent</b> . . . . .	<b>58</b>
Prerequisites. . . . .	58
Procedure . . . . .	58
<b>Replacing the Air Vent</b> . . . . .	<b>59</b>
Procedure . . . . .	59
Postrequisites. . . . .	59
<b>Removing the Display</b> . . . . .	<b>60</b>
Prerequisites. . . . .	60
Procedure . . . . .	60
<b>Replacing the Display</b> . . . . .	<b>62</b>
Procedure . . . . .	62
Postrequisites. . . . .	62
<b>Removing the Keyboard</b> . . . . .	<b>63</b>
Prerequisites. . . . .	63
Procedure . . . . .	64
<b>Replacing the Keyboard</b> . . . . .	<b>67</b>
Procedure . . . . .	67
Postrequisites. . . . .	67
<b>Removing the Palm Rest</b> . . . . .	<b>68</b>
Prerequisites. . . . .	68
Procedure . . . . .	69
<b>Replacing the Palm Rest</b> . . . . .	<b>71</b>
Procedure . . . . .	71
Postrequisites. . . . .	71

Flashing the BIOS..... 72







# Before You Begin

---

## Turn Off Your Computer and Connected Devices

 **CAUTION:** To avoid losing data, save and close all open files and exit all open programs before you turn off your computer.

- 1 Save and close all open files and exit all open programs.
- 2 Click **Start**  and click **Shut down**.

Microsoft Windows shuts down and then the computer turns off.

 **NOTE:** If you are using a different operating system, see the documentation of your operating system for shut-down instructions.

- 3 Disconnect your computer and all attached devices from their electrical outlets.
- 4 Disconnect all telephone cables, network cables, and attached devices from your computer.

## Safety Instructions

Use the following safety guidelines to protect your computer from potential damage and ensure your personal safety.

 **WARNING:** Before working inside your computer, read the safety information that shipped with your computer. For additional safety best practices information, see the Regulatory Compliance Homepage at [dell.com/regulatory\\_compliance](http://dell.com/regulatory_compliance).

 **WARNING:** Disconnect all power sources before opening the computer cover or panels. After you finish working inside the computer, replace all covers, panels, and screws before connecting to the power source.

 **CAUTION:** To avoid damaging the computer, ensure that the work surface is flat and clean.

 **CAUTION:** To avoid damaging the components and cards, handle them by their edges and avoid touching pins and contacts.

 **CAUTION:** Only a certified service technician is authorized to remove the computer cover and access any of the components inside the computer. See the safety instructions for complete information about safety precautions, working inside your computer, and protecting against electrostatic discharge.

 **CAUTION:** Before touching anything inside your computer, ground yourself by touching an unpainted metal surface, such as the metal at the back of the computer. While you work, periodically touch an unpainted metal surface to dissipate static electricity, which could harm internal components.

△ **CAUTION:** When you disconnect a cable, pull on its connector or on its pull-tab, not on the cable itself. Some cables have connectors with locking tabs or thumb-screws that you must disengage before disconnecting the cable. When disconnecting cables, keep them evenly aligned to avoid bending any connector pins. When connecting cables, ensure that the connectors and ports are correctly oriented and aligned.

△ **CAUTION:** To disconnect a network cable, first unplug the cable from your computer and then unplug the cable from the network device.

△ **CAUTION:** Press and eject any installed card from the media-card reader.

## Recommended Tools

The procedures in this document may require the following tools:

- Phillips screwdriver
- Torx #5 (T5) screwdriver

# After Working Inside Your Computer

---

After you complete replacement procedures, ensure the following:

- Replace all screws and ensure that no stray screws remain inside your computer.
- Connect any external devices, cables, cards, and any other part(s) you removed before working on your computer.
- Connect your computer and all attached devices to their electrical outlets.



**CAUTION: Before turning on your computer, replace all screws and ensure that no stray screws remain inside the computer. Failure to do so may damage your computer.**

# Removing the Base Cover

---

**⚠ WARNING:** Before working inside your computer, read the safety information that shipped with your computer and follow the steps in "Before You Begin" on page 9. After working inside your computer, follow the instructions in "After Working Inside Your Computer" on page 11. For additional safety best practices information, see the Regulatory Compliance Homepage at [dell.com/regulatory\\_compliance](http://dell.com/regulatory_compliance).

## Procedure

- 1 Close the display, and turn the computer over.
- 2 Place your fingertip at the indicator on the base-cover assembly.
- 3 Turn the system badge over and place it on the base-cover assembly.

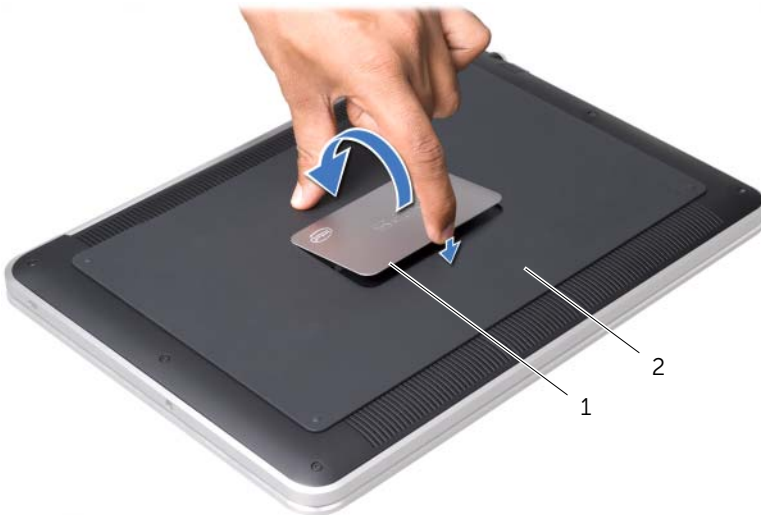

---

1 system badge

2 base-cover assembly

---

- 4 Remove the screws under the system badge that secure the base-cover assembly.

- 5 Remove the screws that secure the base-cover assembly to the palm-rest assembly.
- 6 Starting from the back of the computer, carefully pry the base-cover assembly, turn the base-cover assembly over, and place it on the palm-rest assembly.

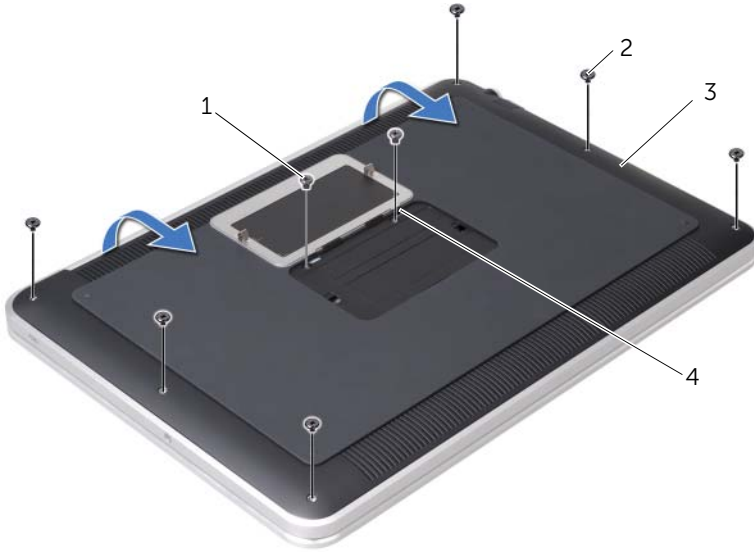

1	screws (2)	2	T5 screws (6)
3	base-cover assembly	4	tabs (2)

- 7 Lift the connector latch and using the pull-tab, disconnect the battery-LED-board cable from the system-board.

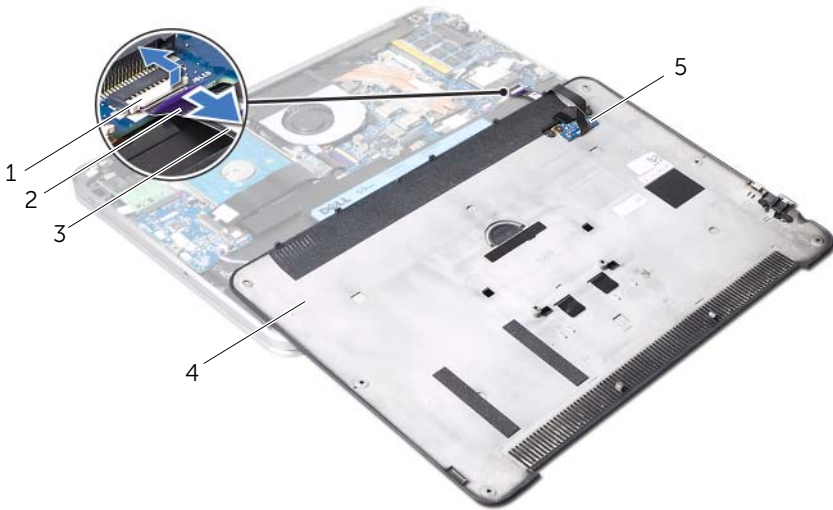

1	connector latch	2	pull-tab
3	battery-LED-board cable	4	base-cover assembly
5	battery-LED board		

- 8 Remove the battery-LED board from the base-cover assembly. See "Removing the Battery-LED Board" on page 19.

# Replacing the Base Cover

---



**WARNING:** Before working inside your computer, read the safety information that shipped with your computer and follow the steps in "Before You Begin" on page 9. After working inside your computer, follow the instructions in "After Working Inside Your Computer" on page 11. For additional safety best practices information, see the Regulatory Compliance Homepage at [dell.com/regulatory\\_compliance](http://dell.com/regulatory_compliance).

## Procedure

- 1 Replace the battery-LED board. See "Replacing the Battery-LED Board" on page 21.
- 2 Slide the battery-LED-board cable into the battery-LED-board cable connector and press down on the connector latch to secure the cable.
- 3 Carefully turn the base-cover assembly over and snap the base-cover assembly into place.
- 4 Replace the screws that secure the base-cover assembly to the palm-rest assembly.
- 5 Replace the screws under the system badge that secure the base-cover assembly.
- 6 Slide the tabs on the system badge into the slots on the base-cover assembly and snap the system badge into place.

# Removing the System Badge

---

**⚠ WARNING:** Before working inside your computer, read the safety information that shipped with your computer and follow the steps in "Before You Begin" on page 9. After working inside your computer, follow the instructions in "After Working Inside Your Computer" on page 11. For additional safety best practices information, see the Regulatory Compliance Homepage at [dell.com/regulatory\\_compliance](http://dell.com/regulatory_compliance).

## Prerequisites

Follow the instructions from step 1 to step 7 in "Removing the Base Cover" on page 12.

## Procedure

- 1 Peel the tapes that secure the system badge to the base-cover assembly.



---

1 base-cover assembly

2 tapes (2)

---



- 2 Turn the base-cover assembly over.
- 3 Using your fingertips, carefully turn the system badge over and remove the tapes from the slots on the base-cover assembly.
- 4 Lift the system badge off the base-cover assembly.

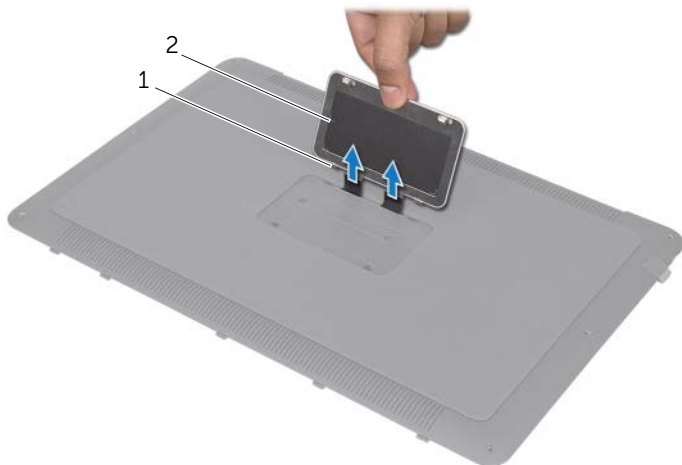

---

1 tabs (2)

2 system badge

---

# Replacing the System Badge

---



**WARNING:** Before working inside your computer, read the safety information that shipped with your computer and follow the steps in "Before You Begin" on page 9. After working inside your computer, follow the instructions in "After Working Inside Your Computer" on page 11. For additional safety best practices information, see the Regulatory Compliance Homepage at [dell.com/regulatory\\_compliance](http://dell.com/regulatory_compliance).

## Procedure

- 1 Slide the tapes on the system badge into the slots on the base-cover assembly.
- 2 Slide the tabs on the system badge into the slots on the base-cover assembly and snap the system badge into place.
- 3 Turn the base-cover assembly over.
- 4 Peel the stickers from the tapes and adhere the tapes to secure the system badge to the base-cover assembly.

## Postrequisites

- 1 Follow the instructions from step 2 to step 6 in "Removing the Base Cover" on page 12.

# Removing the Battery-LED Board

---

**⚠ WARNING:** Before working inside your computer, read the safety information that shipped with your computer and follow the steps in "Before You Begin" on page 9. After working inside your computer, follow the instructions in "After Working Inside Your Computer" on page 11. For additional safety best practices information, see the Regulatory Compliance Homepage at [dell.com/regulatory\\_compliance](http://dell.com/regulatory_compliance).

## Prerequisites

Follow the instructions from step 1 to step 7 in "Removing the Base Cover" on page 12.

## Procedure

- 1 Peel the mylar from the battery-LED board.
- 2 Remove the screws that secure the battery-LED-board bracket to the base cover.
- 3 Lift the battery-LED-board bracket off the base cover.



---

1 battery-LED-board bracket

2 screws (2)

---

- 4 Remove the screw that secures the battery-LED board to the base cover.
- 5 Lift and slide the battery-LED board out of the tab on the base cover.

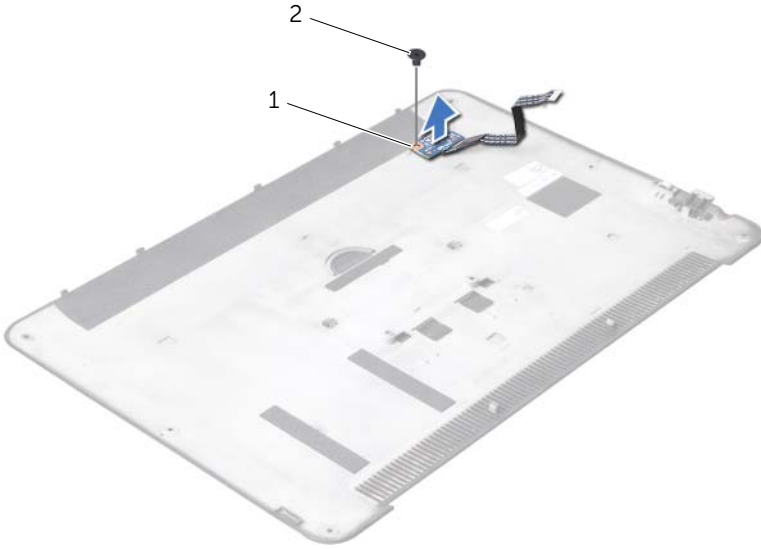

---

1	battery-LED board	2	screw
---	-------------------	---	-------

---

# Replacing the Battery-LED Board

---



**WARNING:** Before working inside your computer, read the safety information that shipped with your computer and follow the steps in "Before You Begin" on page 9. After working inside your computer, follow the instructions in "After Working Inside Your Computer" on page 11. For additional safety best practices information, see the Regulatory Compliance Homepage at [dell.com/regulatory\\_compliance](http://dell.com/regulatory_compliance).

## Procedure

- 1 Slide the battery-LED-board under the tab on the base cover and use the alignment post on the base cover to place the battery-LED-board in position.
- 2 Replace the screw that secures the battery-LED board to the base cover.
- 3 Align the screw holes on the battery-LED-board bracket with the screw holes on the base cover.
- 4 Replace the screws that secure the battery-LED-board bracket to the base cover.
- 5 Adhere the mylar on the battery- LED board.

## Postrequisites

- 1 Follow the instructions from step 2 to step 6 in "Removing the Base Cover" on page 12.

# Removing the Speakers

---

**⚠ WARNING:** Before working inside your computer, read the safety information that shipped with your computer and follow the steps in "Before You Begin" on page 9. After working inside your computer, follow the instructions in "After Working Inside Your Computer" on page 11. For additional safety best practices information, see the Regulatory Compliance Homepage at [dell.com/regulatory\\_compliance](http://dell.com/regulatory_compliance).

## Prerequisites

Follow the instructions from step 1 to step 7 in "Removing the Base Cover" on page 12.

## Procedure

- 1 Peel the mylar from the speakers.

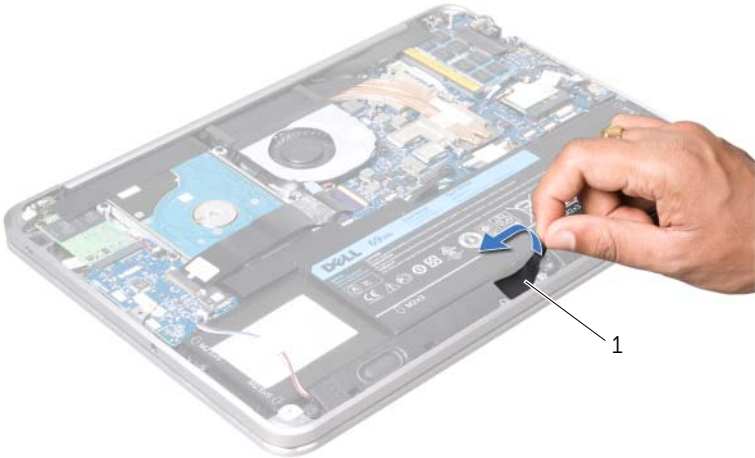

---

1 mylar

---

- 2 Disconnect the speaker cable from the I/O-board connector.
- 3 Note the location of the tape that secures the speaker cable to the battery and peel the tape off.
- 4 Remove the screws that secure the speakers to the palm-rest assembly.
- 5 Lift the speakers, along with the speaker cable, away from the palm-rest assembly.

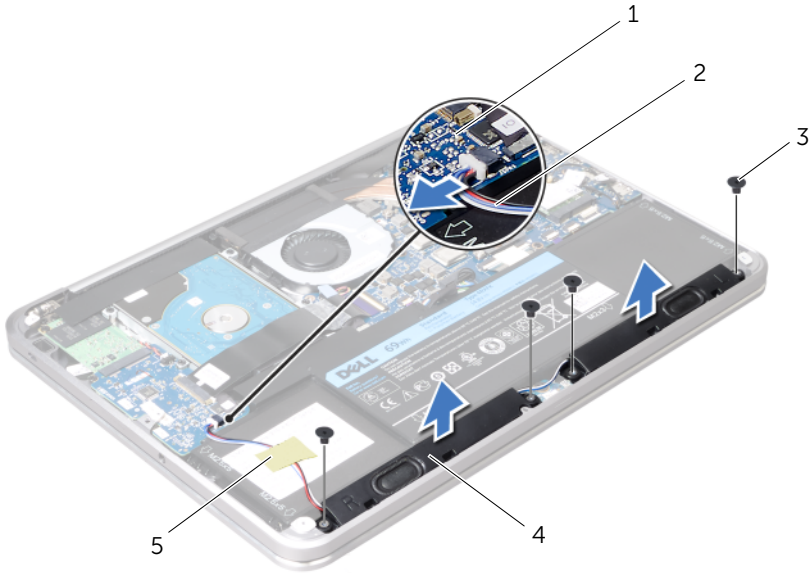

1	I/O board	2	speaker cable
3	screws (4)	4	speakers (2)
5	tape		

# Replacing the Speakers

---



**WARNING:** Before working inside your computer, read the safety information that shipped with your computer and follow the steps in "Before You Begin" on page 9. After working inside your computer, follow the instructions in "After Working Inside Your Computer" on page 11. For additional safety best practices information, see the Regulatory Compliance Homepage at [dell.com/regulatory\\_compliance](http://dell.com/regulatory_compliance).

## Procedure

- 1 Use the alignment posts on the palm-rest assembly to place the speakers in position.  
 **NOTE:** Ensure that the speakers are secured by the alignment posts.
- 2 Replace the screws that secure the speakers to the palm-rest assembly.
- 3 Adhere the mylar on the speakers.
- 4 Connect the speaker cable to the I/O-board connector.
- 5 Adhere the tape that secures the speaker cable to the battery.

## Postrequisites

- 1 Follow the instructions from step 2 to step 6 in "Removing the Base Cover" on page 12.



# Removing the Battery

**⚠ WARNING:** Before working inside your computer, read the safety information that shipped with your computer and follow the steps in "Before You Begin" on page 9. After working inside your computer, follow the instructions in "After Working Inside Your Computer" on page 11. For additional safety best practices information, see the Regulatory Compliance Homepage at [dell.com/regulatory\\_compliance](http://dell.com/regulatory_compliance).

## Prerequisites

- 1 Follow the instructions from step 1 to step 7 in "Removing the Base Cover" on page 12.
- 2 Remove the speakers. See "Removing the Speakers" on page 22.

## Procedure

- 1 Remove the screws that secure the battery to the palm-rest assembly.
- 2 Lift the battery, along with its cable, off the palm-rest assembly.
- 3 Disconnect the battery cable from the system board.

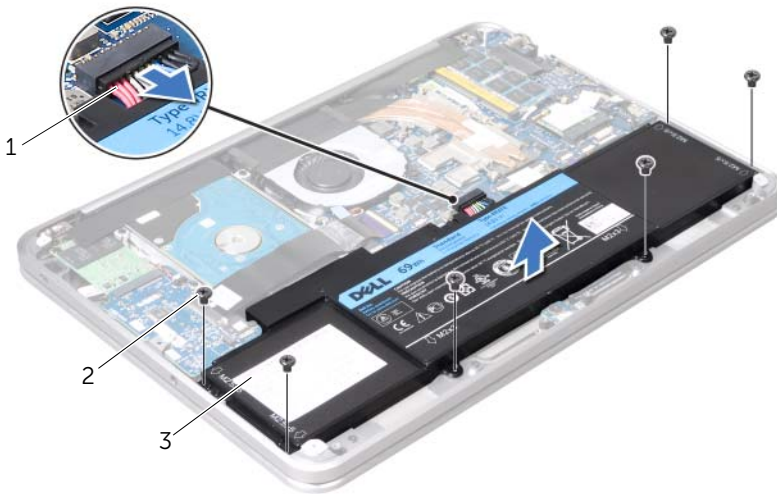

1 battery cable

2 screws (6)

3 battery

- 4 Press and hold the power button for about 5 seconds to ground the system board.

# Replacing the Battery

---



**WARNING:** Before working inside your computer, read the safety information that shipped with your computer and follow the steps in "Before You Begin" on page 9. After working inside your computer, follow the instructions in "After Working Inside Your Computer" on page 11. For additional safety best practices information, see the Regulatory Compliance Homepage at [dell.com/regulatory\\_compliance](http://dell.com/regulatory_compliance).

## Procedure

- 1 Connect the battery cable to the system board.
- 2 Align the screw holes on the battery with the screw holes on the palm-rest assembly.
- 3 Replace the screws that secure the battery to the palm-rest assembly.

## Postrequisites

- 1 Replace the speakers. See "Replacing the Speakers" on page 24.
- 2 Follow the instructions from step 2 to step 6 in "Replacing the Base Cover" on page 15.

# Removing the Memory Module

---

**⚠ WARNING:** Before working inside your computer, read the safety information that shipped with your computer and follow the steps in "Before You Begin" on page 9. After working inside your computer, follow the instructions in "After Working Inside Your Computer" on page 11. For additional safety best practices information, see the Regulatory Compliance Homepage at [dell.com/regulatory\\_compliance](http://dell.com/regulatory_compliance).

## Prerequisites

- 1 Follow the instructions from step 1 to step 7 in "Removing the Base Cover" on page 12.
- 2 Remove the speakers. See "Removing the Speakers" on page 22.
- 3 Remove the battery. See "Removing the Battery" on page 25.

## Procedure

**⚠ CAUTION:** To prevent damage to the memory-module connector, do not use tools to spread the memory-module securing clips.

- 1 Peel the mylar from the system-board assembly.



---

1 mylar

---

- 2 Using your fingertips, carefully spread apart the securing clips on each end of the memory-module connector until the memory module pops up.
- 3 Remove the memory module from the memory-module connector.

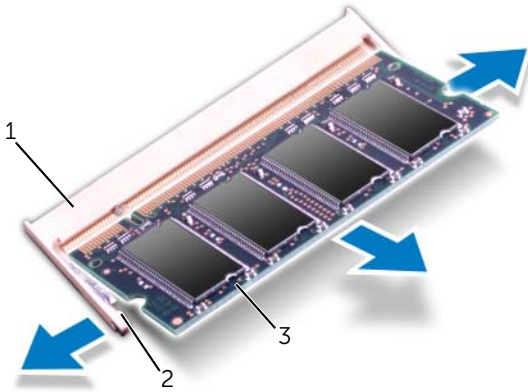

---

1	memory-module connector	2	securing clips (2)
3	memory module		

---

# Replacing the Memory Module

---

**⚠ WARNING:** Before working inside your computer, read the safety information that shipped with your computer and follow the steps in "Before You Begin" on page 9. After working inside your computer, follow the instructions in "After Working Inside Your Computer" on page 11. For additional safety best practices information, see the Regulatory Compliance Homepage at [dell.com/regulatory\\_compliance](http://dell.com/regulatory_compliance).

## Procedure

- 1 Align the notch on the memory module with the tab on the memory-module connector.
- 2 Slide the memory module firmly into the slot at a 45-degree angle, and press the memory module down until it clicks into place. If you do not hear the click, remove the memory module and reinstall it.  
**✍ NOTE:** If the memory module is not installed properly, the computer may not boot.
- 3 Adhere the mylar on the system-board assembly.

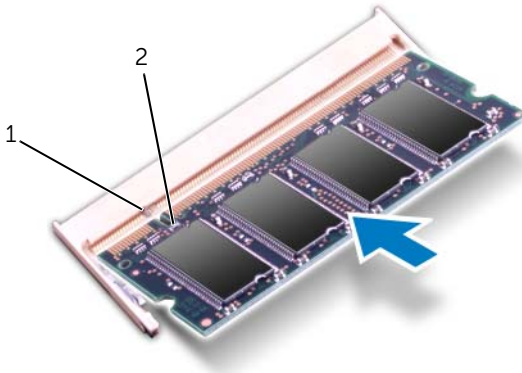

---

1 tab

2 notch

---

## Postrequisites

- 1 Replace the battery. See "Replacing the Battery" on page 26.
- 2 Replace the speakers. See "Replacing the Speakers" on page 24.
- 3 Follow the instructions from step 2 to step 6 in "Replacing the Base Cover" on page 15.
- 4 Turn on the computer.

As the computer boots, it detects the memory module(s) and automatically updates the system configuration information.

To confirm the amount of memory installed in the computer:

Click **Start**  → **Control Panel** → **System and Security** → **System**.

# Removing the Wireless Mini-Card

**⚠ WARNING:** Before working inside your computer, read the safety information that shipped with your computer and follow the steps in "Before You Begin" on page 9. After working inside your computer, follow the instructions in "After Working Inside Your Computer" on page 11. For additional safety best practices information, see the Regulatory Compliance Homepage at [dell.com/regulatory\\_compliance](http://dell.com/regulatory_compliance).

## Prerequisites

- 1 Follow the instructions from step 1 to step 7 in "Removing the Base Cover" on page 12.
- 2 Remove the speakers. See "Removing the Speakers" on page 22.
- 3 Remove the battery. See "Removing the Battery" on page 25.

## Procedure

- 1 Disconnect the antenna cables from the wireless mini-card.
- 2 Remove the screw that secures the wireless mini-card to the system board.

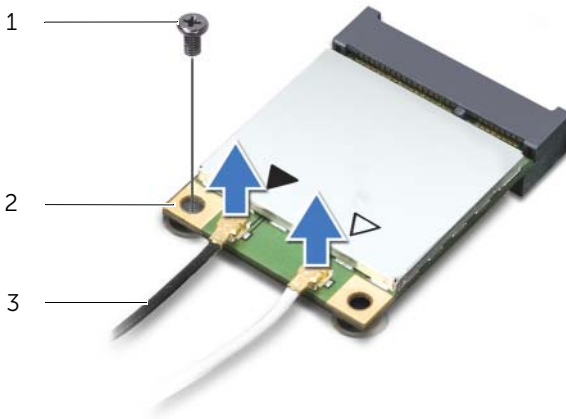

1 screw

2 wireless mini-card

3 antenna cables (2)

3 Slide and remove the wireless-mini card from the system board.

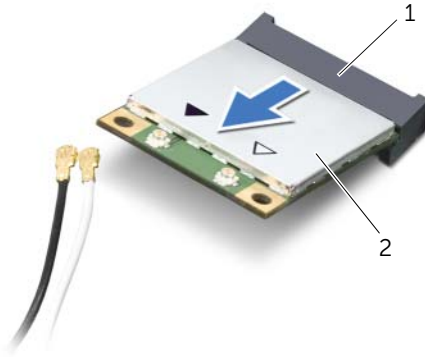

---

1 wireless mini-card connector

2 wireless mini-card

---



# Replacing the Wireless Mini-Card

---

 **WARNING:** Before working inside your computer, read the safety information that shipped with your computer and follow the steps in "Before You Begin" on page 9. After working inside your computer, follow the instructions in "After Working Inside Your Computer" on page 11. For additional safety best practices information, see the Regulatory Compliance Homepage at [dell.com/regulatory\\_compliance](http://dell.com/regulatory_compliance).

## Procedure

1 Align the notch on the Mini-Card with the tab on the mini-card connector.

 **CAUTION:** Use firm and even pressure to slide the mini-card into place. If you use excessive force, you may damage the connector.

 **CAUTION:** The connectors are keyed to ensure correct insertion. If you feel resistance, check the connectors on the mini-card and on the mini-card connector, and realign the mini-card.

 **CAUTION:** To avoid damage to the mini-card, never place cables under the mini-card.

2 Insert the mini-card at a 45-degree angle into the mini-card connector.

3 Press the other end of the mini-card down into the slot on the system board and replace the screw that secures the mini-card to the system board.

4 Connect the antenna cables to the connectors on the mini-card.

The following table provides the antenna-cable color scheme for the mini-card supported by your computer.

Connectors on the mini-card	Antenna-Cable Color Scheme
<b>WLAN + Bluetooth (2 cables)</b>	
Main WLAN + Bluetooth (white triangle)	white
Auxiliary WLAN + Bluetooth (black triangle)	black

## Postrequisites

1 Replace the battery. See "Replacing the Battery" on page 26.

2 Replace the speakers. See "Replacing the Speakers" on page 24.

3 Follow the instructions from step 2 to step 6 in "Replacing the Base Cover" on page 15.

# Removing the mSATA/WWAN Mini-Card

**⚠ WARNING:** Before working inside your computer, read the safety information that shipped with your computer and follow the steps in "Before You Begin" on page 9. After working inside your computer, follow the instructions in "After Working Inside Your Computer" on page 11. For additional safety best practices information, see the Regulatory Compliance Homepage at [dell.com/regulatory\\_compliance](http://dell.com/regulatory_compliance).

## Prerequisites

- 1 Follow the instructions from step 1 to step 7 in "Removing the Base Cover" on page 12.
- 2 Remove the speakers. See "Removing the Speakers" on page 22.
- 3 Remove the battery. See "Removing the Battery" on page 25.

## Procedure

- 1 Peel the mylar from the mSATA/WWAN card.
- 2 If your computer has a WWAN card, disconnect the antenna cables from the WWAN card.
- 3 Remove the screw that secures the mSATA/WWAN card to the palm-rest assembly.
- 4 Slide and remove the mSATA/WWAN card from the I/O board.



---

1	screw	2	mSATA/WWAN card
3	mSATA/WWAN-card connector		

---

# Replacing the mSATA/WWAN Card

---

 **WARNING:** Before working inside your computer, read the safety information that shipped with your computer and follow the steps in "Before You Begin" on page 9. After working inside your computer, follow the instructions in "After Working Inside Your Computer" on page 11. For additional safety best practices information, see the Regulatory Compliance Homepage at [dell.com/regulatory\\_compliance](http://dell.com/regulatory_compliance).

## Procedure

- 1 Adhere the mylar on the mSATA/WWAN card.
- 2 Align the notch on the mSATA/WWAN card with the tab on the mSATA/WWAN-card connector.
- 3 Insert the mSATA/WWAN card at a 45-degree angle into the mSATA/WWAN-card connector.
- 4 Press the other end of the mSATA/WWAN card down into the slot on the I/O board and replace the screw that secures the mSATA/WWAN drive to the palm-rest assembly.
- 5 If you are replacing a WWAN card, connect the antenna cables to the connectors on the WWAN card.

The following table provides the antenna-cable color scheme for the WWAN card supported by your computer.

Connectors on the Mini-Card	Antenna-Cable Color Scheme
<b>WWAN (2 antenna cables)</b>	
Main WWAN (white triangle)	white with gray stripe
Auxiliary WWAN (black triangle)	black with gray stripe

## Postrequisites

- 1 Replace the battery. See "Replacing the Battery" on page 26.
- 2 Replace the speakers. See "Replacing the Speakers" on page 24.
- 3 Follow the instructions from step 2 to step 6 in "Replacing the Base Cover" on page 15.

# Removing the Hard Drive

**⚠ WARNING:** Before working inside your computer, read the safety information that shipped with your computer and follow the steps in "Before You Begin" on page 9. After working inside your computer, follow the instructions in "After Working Inside Your Computer" on page 11. For additional safety best practices information, see the Regulatory Compliance Homepage at [dell.com/regulatory\\_compliance](http://dell.com/regulatory_compliance).

**⚠ CAUTION:** To avoid data loss, do not remove the hard drive while the computer is On or in Sleep state.

**⚠ CAUTION:** Hard drives are extremely fragile. Exercise care when handling the hard drive.

## Prerequisites

- 1 Follow the instructions from step 1 to step 7 in "Removing the Base Cover" on page 12.
- 2 Remove the speakers. See "Removing the Speakers" on page 22.
- 3 Remove the battery. See "Removing the Battery" on page 25.

## Procedure

- 1 Lift the connector latch and, using the pull-tab, disconnect the I/O-board cable from the system board.

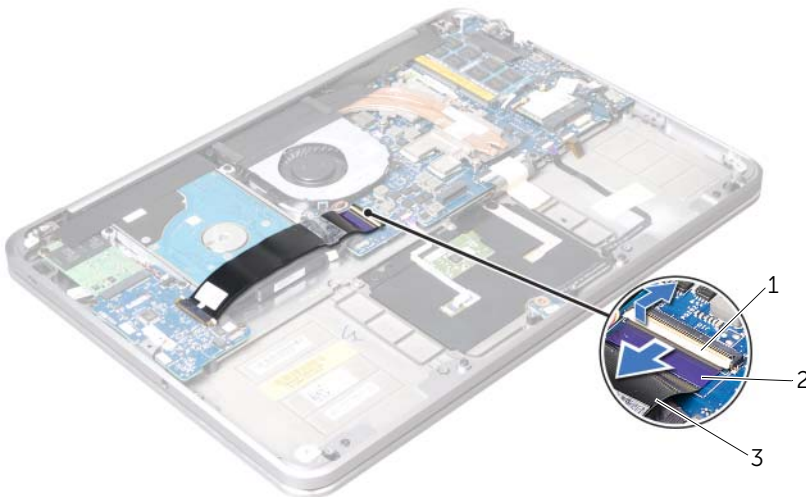

---

1	connector latch
3	I/O-board cable

---

2	pull-tab
---	----------

---

- 2 Using the pull-tab, disconnect the hard-drive cable from the system board.
- 3 Peel the mylar from the hard-drive assembly.
- 4 Remove the screws that secure the hard-drive assembly to the palm-rest assembly.
- 5 Lift the hard-drive assembly, along with its cable, out of the palm-rest assembly.
- 6 Lift the hard-drive assembly, along with its cable, out of the palm-rest assembly.

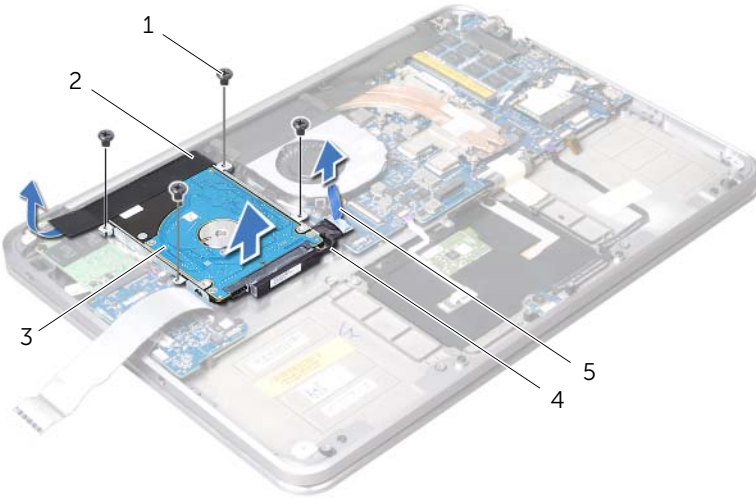

1	screws (4)	2	mylar
3	hard-drive assembly	4	hard-drive cable
5	pull-tab		

- 7 Disconnect the interposer from the hard-drive assembly.

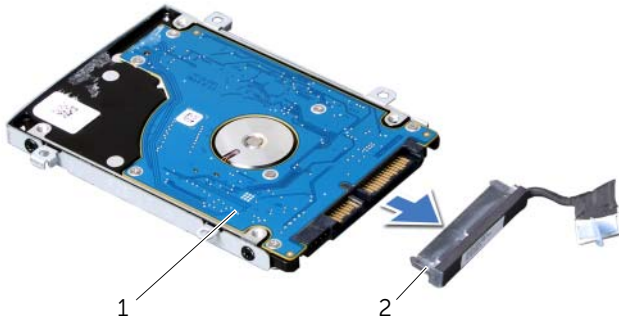

1	hard-drive assembly	2	interposer
---	---------------------	---	------------

- 8 Remove the screws that secure the hard-drive bracket to the hard drive.
- 9 Slide the hard drive out of the hard-drive bracket.

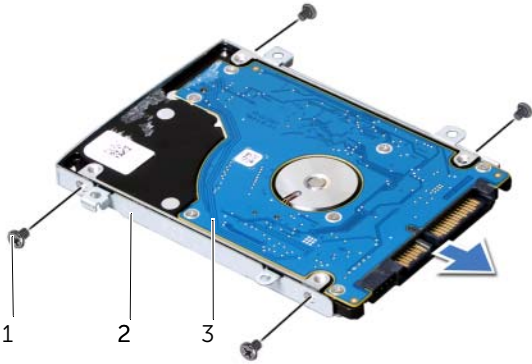

---

1	screws (4)	2	hard-drive bracket
3	hard drive		

---

# Replacing the Hard Drive

---



**WARNING:** Before working inside your computer, read the safety information that shipped with your computer and follow the steps in "Before You Begin" on page 9. After working inside your computer, follow the instructions in "After Working Inside Your Computer" on page 11. For additional safety best practices information, see the Regulatory Compliance Homepage at [dell.com/regulatory\\_compliance](http://dell.com/regulatory_compliance).



**CAUTION:** Hard drives are extremely fragile. Exercise care when handling the hard drive.

## Procedure

- 1 Slide the hard drive into the hard-drive bracket.
- 2 Align the screw holes on the hard drive with the screw holes on the hard-drive bracket and replace the screws that secure the hard-drive bracket to the hard drive.
- 3 Connect the interposer to the hard-drive assembly.  
 **NOTE:** Ensure that there are no cables under the hard drive.
- 4 Align the screw holes on the hard-drive assembly with the screw holes on the palm-rest assembly.
- 5 Replace the screws that secure the hard-drive assembly to the palm-rest assembly.
- 6 Adhere the mylar on the hard-drive assembly.
- 7 Connect the hard-drive cable to the system-board.
- 8 Slide the I/O-board cable into the I/O-board cable connector and press down on the connector latch to secure the cable.

## Postrequisites

- 1 Replace the battery. See "Replacing the Battery" on page 26.
- 2 Replace the speakers. See "Replacing the Speakers" on page 24.
- 3 Follow the instructions from step 2 to step 6 in "Replacing the Base Cover" on page 15.

# Removing the Power/Battery Status-Light Board

---



**WARNING:** Before working inside your computer, read the safety information that shipped with your computer and follow the steps in "Before You Begin" on page 9. After working inside your computer, follow the instructions in "After Working Inside Your Computer" on page 11. For additional safety best practices information, see the Regulatory Compliance Homepage at [dell.com/regulatory\\_compliance](http://dell.com/regulatory_compliance).

## Prerequisites

- 1 Follow the instructions from step 1 to step 7 in "Removing the Base Cover" on page 12.
- 2 Remove the speakers. See "Removing the Speakers" on page 22.
- 3 Remove the battery. See "Removing the Battery" on page 25.

## Procedure

- 1 Lift the connector latch and, using the pull-tab, disconnect the power/battery-status-light cable from the system board.
- 2 Note the location of the tape that secures the power/battery status-light cable to the palm-rest assembly, and then peel the tape.
- 3 Remove the screw that secures the power/battery status-light board to the palm-rest assembly.



- 4 Lift the power/battery status-light board, along with its cable, off the palm-rest assembly.

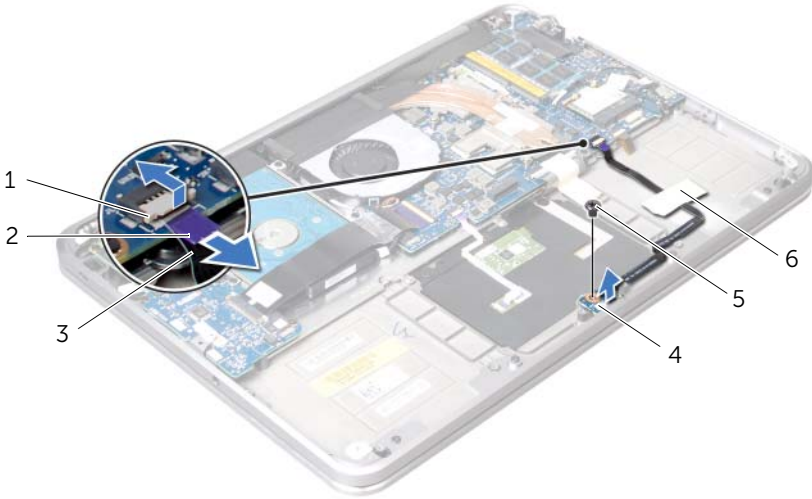

1	connector latch	2	pull-tab
3	power/battery-status-light cable	4	power/battery status-light board
5	screw	6	tape

# Replacing the Power/Battery Status-Light Board

---



**WARNING:** Before working inside your computer, read the safety information that shipped with your computer and follow the steps in "Before You Begin" on page 9. After working inside your computer, follow the instructions in "After Working Inside Your Computer" on page 11. For additional safety best practices information, see the Regulatory Compliance Homepage at [dell.com/regulatory\\_compliance](http://dell.com/regulatory_compliance).

## Procedure

- 1 Align the screw holes on the power/battery status-light board with the screw hole on the palm-rest assembly.
- 2 Replace the screw that secures the power/battery status-light board to the palm-rest assembly.
- 3 Slide the power/battery status-light cable into the power/battery status-light connector and press down on the connector latch to secure the cable.
- 4 Adhere the tape on the power/battery-status-light cable.

## Postrequisites

- 1 Replace the battery. See "Replacing the Battery" on page 26.
- 2 Replace the speakers. See "Replacing the Speakers" on page 24.
- 3 Follow the instructions from step 2 to step 6 in "Replacing the Base Cover" on page 15.

# Removing the Coin-Cell Battery

**⚠ WARNING:** Before working inside your computer, read the safety information that shipped with your computer and follow the steps in "Before You Begin" on page 9. After working inside your computer, follow the instructions in "After Working Inside Your Computer" on page 11. For additional safety best practices information, see the Regulatory Compliance Homepage at [dell.com/regulatory\\_compliance](http://dell.com/regulatory_compliance).

**⚠ CAUTION:** Removing the coin-cell battery resets the BIOS settings to default. It is recommended that you note the BIOS settings before removing the coin-cell battery.

## Prerequisites

- 1 Follow the instructions from step 1 to step 7 in "Removing the Base Cover" on page 12.
- 2 Remove the speakers. See "Removing the Speakers" on page 22.
- 3 Remove the battery. See "Removing the Battery" on page 25.
- 4 Remove the mSATA/WWAN card. "Removing the mSATA/WWAN Mini-Card" on page 34.

## Procedure

- 1 Disconnect the coin-cell-battery cable from the I/O-board.
- 2 Note the coin-cell-battery cable routing and remove the cable from the routing guides on the palm-rest assembly.
- 3 Peel the coin-cell battery off the palm-rest assembly.
- 4 Lift the coin-cell battery along with its cable off the palm-rest assembly.

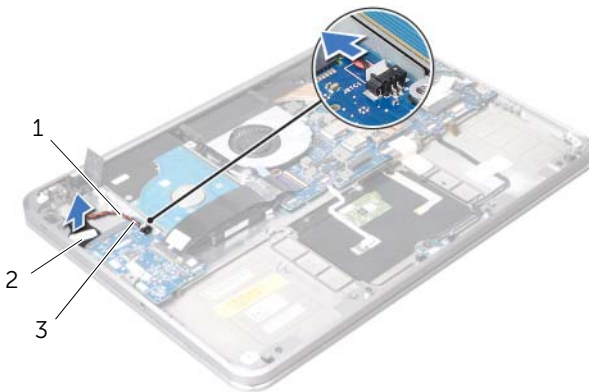

1 routing guides

2 coin-cell battery

3 coin-cell-battery cable

# Replacing the Coin-Cell Battery

---

 **WARNING:** Before working inside your computer, read the safety information that shipped with your computer and follow the steps in "Before You Begin" on page 9. After working inside your computer, follow the instructions in "After Working Inside Your Computer" on page 11. For additional safety best practices information, see the Regulatory Compliance Homepage at [dell.com/regulatory\\_compliance](http://dell.com/regulatory_compliance).

 **WARNING:** The battery may explode if installed incorrectly. Replace the battery only with the same or equivalent type. Discard used batteries according to the manufacturer's instructions.

## Procedure

- 1 Adhere the coin-cell battery to the palm-rest assembly.
- 2 Route the coin-cell-battery cable through the routing guides on the palm-rest assembly.
- 3 Connect the coin-cell battery cable to the I/O board.

## Postrequisites

- 1 Replace the mSATA/WWAN card. "Replacing the mSATA/WWAN Card" on page 35.
- 2 Replace the battery. See "Replacing the Battery" on page 26.
- 3 Replace the speakers. See "Replacing the Speakers" on page 24.
- 4 Follow the instructions from step 2 to step 6 in "Replacing the Base Cover" on page 15.

# Removing the Fan

**⚠ WARNING:** Before working inside your computer, read the safety information that shipped with your computer and follow the steps in "Before You Begin" on page 9. After working inside your computer, follow the instructions in "After Working Inside Your Computer" on page 11. For additional safety best practices information, see the Regulatory Compliance Homepage at [dell.com/regulatory\\_compliance](http://dell.com/regulatory_compliance).

## Prerequisites

- 1 Follow the instructions from step 1 to step 7 in "Removing the Base Cover" on page 12.
- 2 Remove the speakers. See "Removing the Speakers" on page 22.
- 3 Remove the battery. See "Removing the Battery" on page 25.

## Procedure

- 1 Disconnect the fan cable from the system board.
- 2 Remove the screw that secures the fan to the palm-rest assembly.
- 3 Lift the fan, along with its cable, away from the palm-rest assembly.

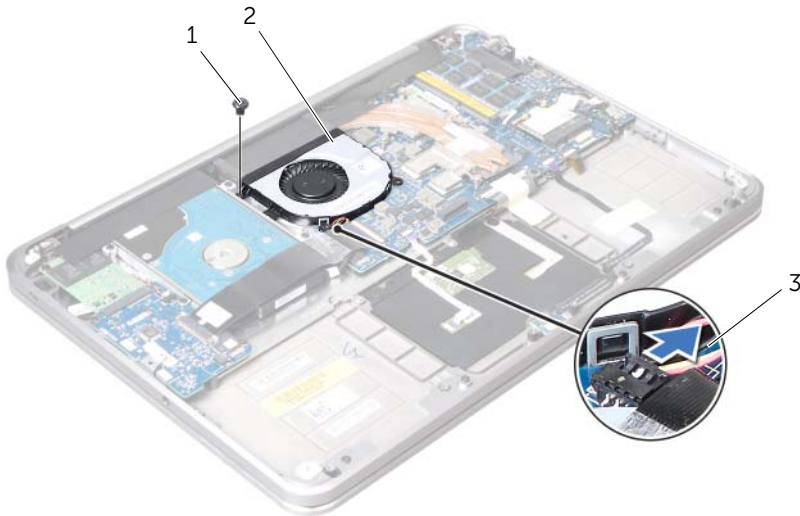

---

1 screw

2 fan

---

3 fan cable

---

# Replacing the Fan

---



**WARNING:** Before working inside your computer, read the safety information that shipped with your computer and follow the steps in "Before You Begin" on page 9. After working inside your computer, follow the instructions in "After Working Inside Your Computer" on page 11. For additional safety best practices information, see the Regulatory Compliance Homepage at [dell.com/regulatory\\_compliance](http://dell.com/regulatory_compliance).

## Procedure

- 1 Connect the fan cable to the system board.
- 2 Align the screw hole on the fan with the screw hole on the palm-rest assembly.
- 3 Replace the screw that secures the fan to the palm-rest assembly.

## Postrequisites

- 1 Replace the battery. See "Replacing the Battery" on page 26.
- 2 Replace the speakers. See "Replacing the Speakers" on page 24.
- 3 Follow the instructions from step 2 to step 6 in "Replacing the Base Cover" on page 15.

# Removing the Processor Heat-Sink

---

**⚠ WARNING:** Before working inside your computer, read the safety information that shipped with your computer and follow the steps in "Before You Begin" on page 9. After working inside your computer, follow the instructions in "After Working Inside Your Computer" on page 11. For additional safety best practices information, see the Regulatory Compliance Homepage at [dell.com/regulatory\\_compliance](http://dell.com/regulatory_compliance).

## Prerequisites

- 1 Follow the instructions from step 1 to step 7 in "Removing the Base Cover" on page 12.
- 2 Remove the speakers. See "Removing the Speakers" on page 22.
- 3 Remove the battery. See "Removing the Battery" on page 25.

## Procedure

- 1 In sequential order (indicated on the processor heat-sink), loosen the captive screws that secure the processor heat-sink to the system board.
- 2 Lift the processor heat-sink off the system board.

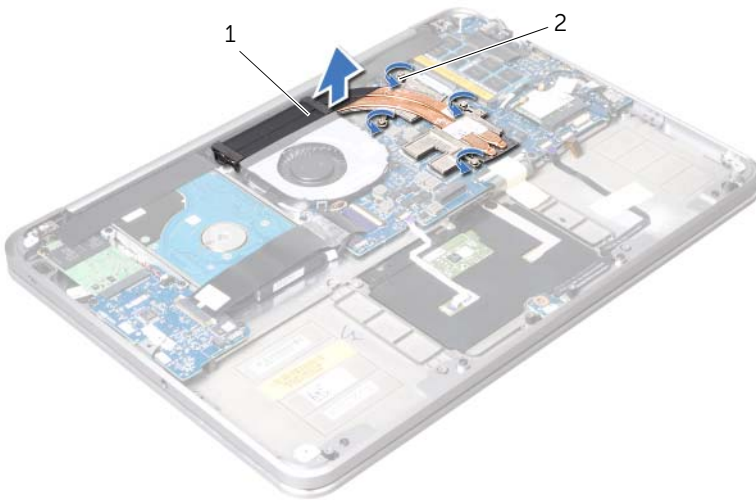

---

1 processor heat-sink

2 captive screws (4)

---

# Replacing the Processor Heat-Sink

---



**WARNING:** Before working inside your computer, read the safety information that shipped with your computer and follow the steps in "Before You Begin" on page 9. After working inside your computer, follow the instructions in "After Working Inside Your Computer" on page 11. For additional safety best practices information, see the Regulatory Compliance Homepage at [dell.com/regulatory\\_compliance](http://dell.com/regulatory_compliance).

## Procedure



**NOTE:** The original thermal grease can be reused, if the original system board and heat sink are reinstalled together. If either the system board or the heat sink is replaced, use the thermal pad provided in the kit to ensure that thermal conductivity is achieved.

- 1 Align the captive screws on the processor heat-sink with the screw holes on the system board.
- 2 In sequential order (indicated on the processor heat-sink), tighten the captive screws that secure the processor heat-sink to the system board.

## Postrequisites

- 1 Replace the battery. See "Replacing the Battery" on page 26.
- 2 Replace the speakers. See "Replacing the Speakers" on page 24.
- 3 Follow the instructions from step 2 to step 6 in "Replacing the Base Cover" on page 15.



# Removing the I/O Board

**⚠ WARNING:** Before working inside your computer, read the safety information that shipped with your computer and follow the steps in "Before You Begin" on page 9. After working inside your computer, follow the instructions in "After Working Inside Your Computer" on page 11. For additional safety best practices information, see the Regulatory Compliance Homepage at [dell.com/regulatory\\_compliance](http://dell.com/regulatory_compliance).

## Prerequisites

- 1 Follow the instructions from step 1 to step 7 in "Removing the Base Cover" on page 12.
- 2 Remove the speakers. See "Removing the Speakers" on page 22.
- 3 Remove the battery. See "Removing the Battery" on page 25.
- 4 Remove the mSATA/WWAN card. See "Removing the mSATA/WWAN Mini-Card" on page 34.

## Procedure

- 1 Disconnect the coin-cell battery cable from the I/O-board.
- 2 Slide the securing latches on the I/O board-cable connector and, using the pull-tab, disconnect the ribbon cable from the I/O-board.
- 3 Disconnect the I/O-board cable from the I/O board.

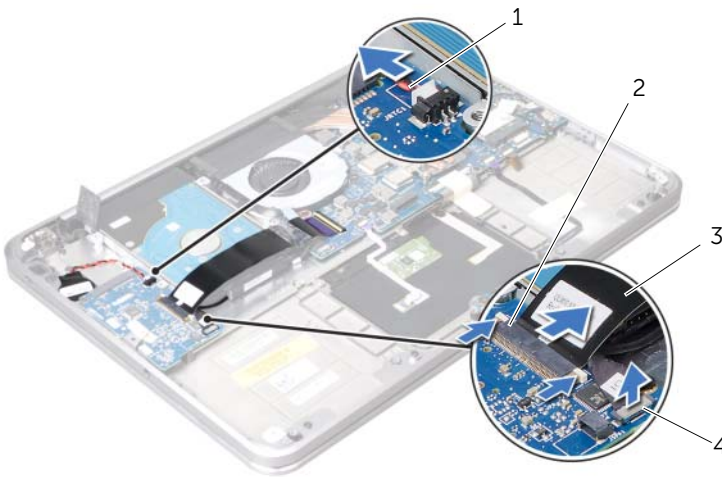

1 coin-cell-battery cable

2 latches

3 ribbon cable

4 I/O board cable

- 4 Remove the screws that secure the I/O board to the palm-rest assembly.
- 5 Lift the I/O board at an angle and release it from the tab on the palm-rest assembly.
- 6 Remove the I/O board off the palm-rest assembly.



---

1	screws (2)	2	I/O board
3	tab		

---

# Replacing the I/O Board

---



**WARNING:** Before working inside your computer, read the safety information that shipped with your computer and follow the steps in "Before You Begin" on page 9. After working inside your computer, follow the instructions in "After Working Inside Your Computer" on page 11. For additional safety best practices information, see the Regulatory Compliance Homepage at [dell.com/regulatory\\_compliance](http://dell.com/regulatory_compliance).

## Procedure

- 1 Slide the I/O board under the tab on the palm-rest assembly.
- 2 Align the screw holes on the I/O board with the screw holes on the palm-rest assembly and replace the screws that secure the I/O board to the palm-rest assembly.
- 3 Slide the I/O-board ribbon cable into the connector on the I/O board and slide the latches to secure the cable.
- 4 Slide the I/O-board cable into the connector on the I/O board and slide the latches to secure the cable.
- 5 Connect the coin-cell battery cable to the I/O-board connector.

## Postrequisites

- 1 Replace the mSATA/WWAN card. See "Replacing the mSATA/WWAN Card" on page 35.
- 2 Replace the battery. See "Replacing the Battery" on page 26.
- 3 Replace the speakers. See "Replacing the Speakers" on page 24.
- 4 Follow the instructions from step 2 to step 6 in "Replacing the Base Cover" on page 15.

# Removing the System Board

---





**WARNING:** Before working inside your computer, read the safety information that shipped with your computer and follow the steps in "Before You Begin" on page 9. After working inside your computer, follow the instructions in "After Working Inside Your Computer" on page 11. For additional safety best practices information, see the Regulatory Compliance Homepage at [dell.com/regulatory\\_compliance](http://dell.com/regulatory_compliance).

## Prerequisites

- 1 Follow the instructions from step 1 to step 7 in "Removing the Base Cover" on page 12.
- 2 Remove the speakers. See "Removing the Speakers" on page 22.
- 3 Remove the battery. See "Removing the Battery" on page 25.
- 4 Remove the memory module(s). See "Removing the Memory Module" on page 27.
- 5 Remove the mini-card. See "Removing the Wireless Mini-Card" on page 31.
- 6 Remove the fan. See "Removing the Fan" on page 45.
- 7 Remove the processor heat-sink. See "Removing the Processor Heat-Sink" on page 47.

## Procedure

 **NOTE:** Your computer's Service Tag is located under the system badge. You must enter the Service Tag in the BIOS after you replace the system board.

 **NOTE:** Before disconnecting the cables from the system board, note the location of the connectors so that you can reconnect them correctly after you replace the system board.

- 1 Peel the mylar from the system board.



---

1 mylar

---

- 2 Disconnect the camera cable from the system board.
- 3 Using the pull-tabs disconnect the display cable from the system board.

4 Lift the connector latch and using, the pull-tab, disconnect the ribbon cable from the system board.

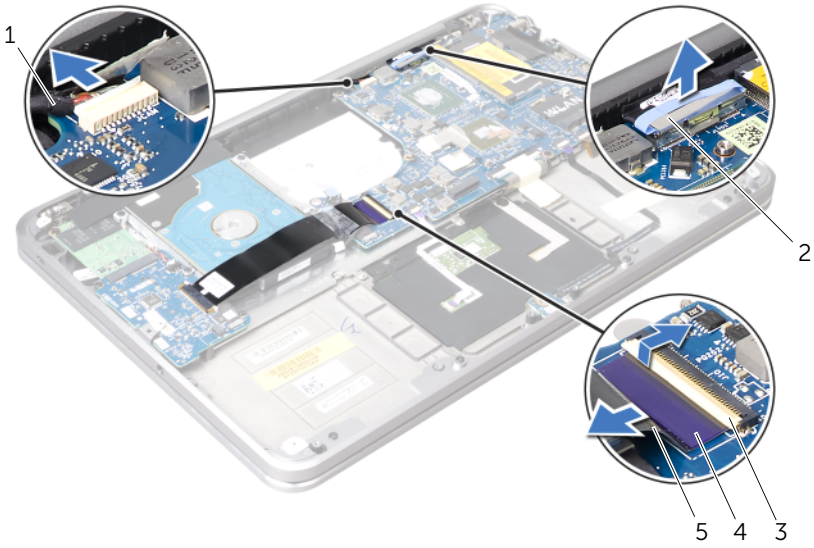

1	camera cable	2	display cable
3	connector latch	4	pull-tab
5	ribbon cable		

- 5** Lift the connector latches and, using the pull-tabs, disconnect the touchpad cable, keyboard cable, power/battery status-light cable, and keyboard-backlight cable from the system board.

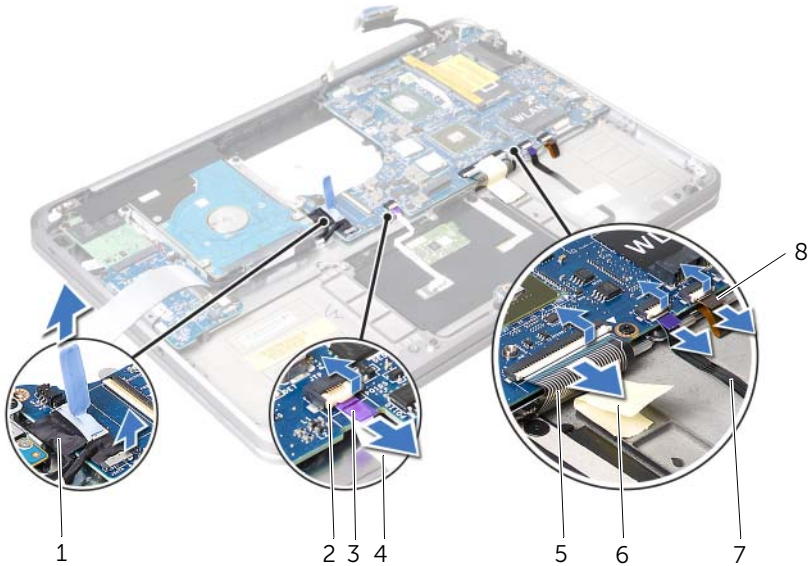

1	hard-drive cable	2	connector latch
3	pull-tab	4	touchpad cable
5	keyboard cable	6	power/battery status-light cable
7	tape	8	keyboard-backlight cable

- 6** Note the routing of the antenna cables and remove the cables from the routing guides on the palm-rest assembly.
- 7** Remove the screws that secure the system board to the palm-rest assembly.

- 8** Lift the system-board assembly at an angle and release the ports on the system board from the slots on the palm-rest assembly

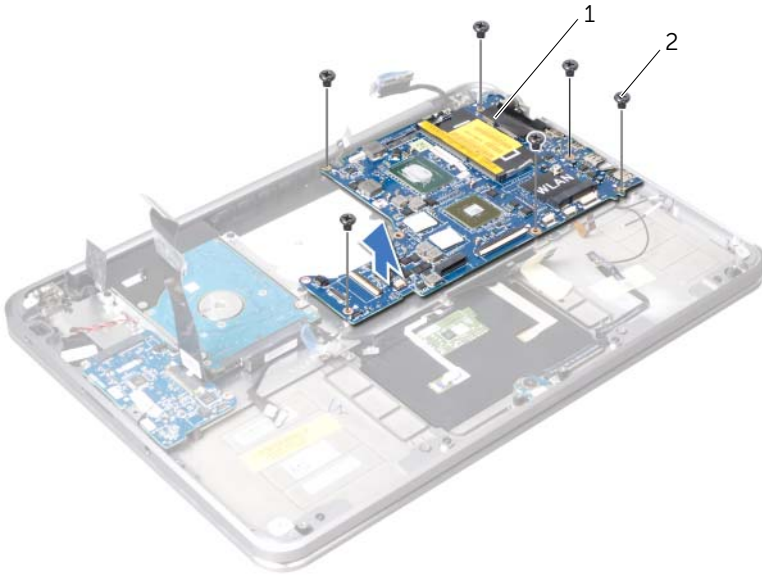

---

1 system board

2 screws (6)

---



# Replacing the System Board

---



**WARNING:** Before working inside your computer, read the safety information that shipped with your computer and follow the steps in "Before You Begin" on page 9. After working inside your computer, follow the instructions in "After Working Inside Your Computer" on page 11. For additional safety best practices information, see the Regulatory Compliance Homepage at [dell.com/regulatory\\_compliance](http://dell.com/regulatory_compliance).

## Procedure

- 1 Slide the system-board ports under the tab and into the slots on the palm-rest assembly.
- 2 Align the screw holes on the system board with the screw holes on the palm-rest assembly.  
 **NOTE:** Ensure that no cables are under the system board.
- 3 Replace the screws that secure the system board to the palm-rest assembly.
- 4 Route the antenna cables through the routing guides on the system board.
- 5 Connect the camera cable, hard-drive cable, and display cable to the system board.
- 6 Slide the ribbon cable, touchpad cable, keyboard cable, power/battery status-light cable, and keyboard-backlight cable into the system-board connectors and press down on the connector latches to secure the cables.
- 7 Adhere the mylar to the system-board assembly.

## Postrequisites

- 1 Replace the processor heat-sink. See "Replacing the Processor Heat-Sink" on page 48.
- 2 Replace the fan. See "Replacing the Fan" on page 46.
- 3 Replace the mini-card. See "Replacing the Wireless Mini-Card" on page 33.
- 4 Replace the memory module(s). See "Replacing the Memory Module" on page 29.
- 5 Replace the battery. See "Replacing the Battery" on page 26.
- 6 Replace the speakers. See "Replacing the Speakers" on page 24.
- 7 Follow the instructions from step 2 to step 6 in "Replacing the Base Cover" on page 15.

## Entering the Service Tag in the BIOS

- 1 Turn on the computer.
- 2 Press <F2> during POST to enter the system setup program.
- 3 Navigate to the main tab and enter the Service Tag in the **Service Tag** field.

# Removing the Air Vent

---

**⚠ WARNING:** Before working inside your computer, read the safety information that shipped with your computer and follow the steps in "Before You Begin" on page 9. After working inside your computer, follow the instructions in "After Working Inside Your Computer" on page 11. For additional safety best practices information, see the Regulatory Compliance Homepage at [dell.com/regulatory\\_compliance](http://dell.com/regulatory_compliance).

## Prerequisites

- 1 Follow the instructions from step 1 to step 7 in "Removing the Base Cover" on page 12.
- 2 Remove the speakers. See "Removing the Speakers" on page 22.
- 3 Remove the battery. See "Removing the Battery" on page 25.
- 4 Follow the instructions from step 1 to step 5 in "Removing the Hard Drive" on page 36.
- 5 Remove the memory module(s). See "Removing the Memory Module" on page 27.
- 6 Remove the mini-card. See "Removing the Wireless Mini-Card" on page 31.
- 7 Remove the fan. See "Removing the Fan" on page 45.
- 8 Remove the processor heat-sink. See "Removing the Processor Heat-Sink" on page 47.
- 9 Remove the system board. See "Removing the System Board" on page 52.

## Procedure

- 1 Note the camera cable routing and remove the cable from the routing guides on the air vent.
- 2 Remove the screws that secure the air vent to the palm-rest assembly.
- 3 Lift the air vent off the palm-rest assembly.

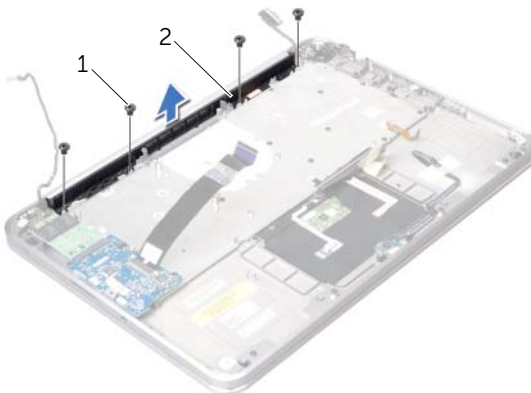

---

1 screws (4)

2 air vent

---

# Replacing the Air Vent

---



**WARNING:** Before working inside your computer, read the safety information that shipped with your computer and follow the steps in "Before You Begin" on page 9. After working inside your computer, follow the instructions in "After Working Inside Your Computer" on page 11. For additional safety best practices information, see the Regulatory Compliance Homepage at [dell.com/regulatory\\_compliance](http://dell.com/regulatory_compliance).

## Procedure

- 1 Align the screw holes on the air vent with the screw holes on the palm-rest assembly.
- 2 Replace the screws that secure the air vent to the palm-rest assembly.
- 3 Route the camera cable through the routing guides on the air vent.

## Postrequisites

- 1 Replace the system board. See "Replacing the System Board" on page 57.
- 2 Replace the processor heat-sink. See "Replacing the Processor Heat-Sink" on page 48.
- 3 Replace the fan. See "Replacing the Fan" on page 46.
- 4 Replace the Mini-Card. See "Replacing the Wireless Mini-Card" on page 33.
- 5 Follow the instructions from step 4 to step 8 in "Replacing the Hard Drive" on page 39.
- 6 Replace the memory module(s). See "Replacing the Memory Module" on page 29.
- 7 Replace the battery. See "Replacing the Battery" on page 26.
- 8 Replace the speakers. See "Replacing the Speakers" on page 24.
- 9 Follow the instructions from step 2 to step 6 in "Replacing the Base Cover" on page 15.

# Removing the Display

---

**⚠ WARNING:** Before working inside your computer, read the safety information that shipped with your computer and follow the steps in "Before You Begin" on page 9. After working inside your computer, follow the instructions in "After Working Inside Your Computer" on page 11. For additional safety best practices information, see the Regulatory Compliance Homepage at [dell.com/regulatory\\_compliance](http://dell.com/regulatory_compliance).

## Prerequisites

- 1 Follow the instructions from step 1 to step 7 in "Removing the Base Cover" on page 12.
- 2 Remove the speakers. See "Removing the Speakers" on page 22.
- 3 Remove the battery. See "Removing the Battery" on page 25.
- 4 Follow the instructions from step 1 to step 5 in "Removing the Hard Drive" on page 36.
- 5 Remove the Mini-Card. See "Removing the Wireless Mini-Card" on page 31.
- 6 Remove the fan. See "Removing the Fan" on page 45.
- 7 Remove the processor heat-sink. See "Removing the Processor Heat-Sink" on page 47.
- 8 Remove the system board. See "Removing the System Board" on page 52.

## Procedure

- 1 Note the camera-cable routing and remove the cable from the routing guides on the air vent.
- 2 Note the display-cable routing and remove the cable from the routing guides on the palm-rest assembly.



---

1 camera-cable routing

2 display-cable routing

---

- 3 Remove the screws that secure the display hinges to the palm-rest assembly.
- 4 Open the palm-rest assembly as far as possible.

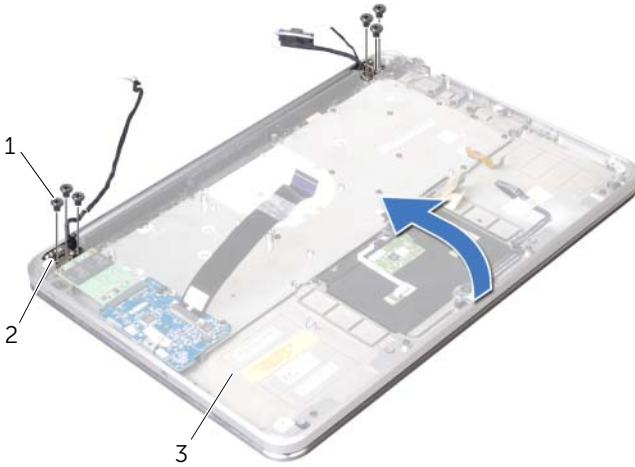

---

1	screws (6)	2	display hinges
3	palm-rest assembly		

---

- 5 Slide and remove the palm-rest assembly from the display hinges and lift the palm-rest assembly away from the display.



---

1	palm-rest assembly	2	tabs (2)
3	display		

---

# Replacing the Display

---



**WARNING:** Before working inside your computer, read the safety information that shipped with your computer and follow the steps in "Before You Begin" on page 9. After working inside your computer, follow the instructions in "After Working Inside Your Computer" on page 11. For additional safety best practices information, see the Regulatory Compliance Homepage at [dell.com/regulatory\\_compliance](http://dell.com/regulatory_compliance).

## Procedure

- 1 Slide the tabs on the palm-rest assembly under the display hinges and align the screw holes on the palm-rest assembly with the screw holes on the display hinges.
- 2 Replace the screws that secure the display hinges to the palm-rest assembly.
- 3 Close the palm-rest assembly.
- 4 Route the display cable through the routing guides on the palm-rest assembly.
- 5 Route the camera cable through the routing guides on the air vent.

## Postrequisites

- 1 Replace the system board. See "Replacing the System Board" on page 57.
- 2 Replace the processor heat-sink. See "Replacing the Processor Heat-Sink" on page 48.
- 3 Replace the fan. See "Replacing the Fan" on page 46.
- 4 Replace the Mini-Card. See "Replacing the Wireless Mini-Card" on page 33.
- 5 Follow the instructions from step 4 to step 8 in "Replacing the Hard Drive" on page 39.
- 6 Replace the battery. See "Replacing the Battery" on page 26.
- 7 Replace the speakers. See "Replacing the Speakers" on page 24.
- 8 Follow the instructions from step 2 to step 6 in "Replacing the Base Cover" on page 15.

# Removing the Keyboard

---



**WARNING:** Before working inside your computer, read the safety information that shipped with your computer and follow the steps in "Before You Begin" on page 9. After working inside your computer, follow the instructions in "After Working Inside Your Computer" on page 11. For additional safety best practices information, see the Regulatory Compliance Homepage at [dell.com/regulatory\\_compliance](http://dell.com/regulatory_compliance).

## Prerequisites

- 1 Follow the instructions from step 1 to step 7 in "Removing the Base Cover" on page 12.
- 2 Remove the speakers. See "Removing the Speakers" on page 22.
- 3 Remove the battery. See "Removing the Battery" on page 25.
- 4 Remove the memory module(s). See "Removing the Memory Module" on page 27.
- 5 Follow the instructions from step 1 to step 5 in "Removing the Hard Drive" on page 36.
- 6 Remove the mSATA/WWAN card. See "Removing the mSATA/WWAN Mini-Card" on page 34.
- 7 Remove the I/O board. See "Removing the I/O Board" on page 49.
- 8 Remove the Mini-Card. See "Removing the Wireless Mini-Card" on page 31.
- 9 Remove the fan. See "Removing the Fan" on page 45.
- 10 Remove the processor heat-sink. See "Removing the Processor Heat-Sink" on page 47.
- 11 Remove the system board. See "Removing the System Board" on page 52.

# Procedure

**△ CAUTION:** The keycaps on the keyboard are fragile, easily dislodged, and time-consuming to replace. Be careful when removing and handling the keyboard.

- 1 Note the location of the mylars and peel them from the keyboard bracket.



---

1 mylars (3)

---

- 2 Remove the screws that secure the keyboard bracket to the palm-rest assembly.





- 3 Lift the keyboard bracket off the keyboard.



---

1 keyboard bracket

---

- 4 Remove the screws that secure the keyboard to the palm-rest assembly.

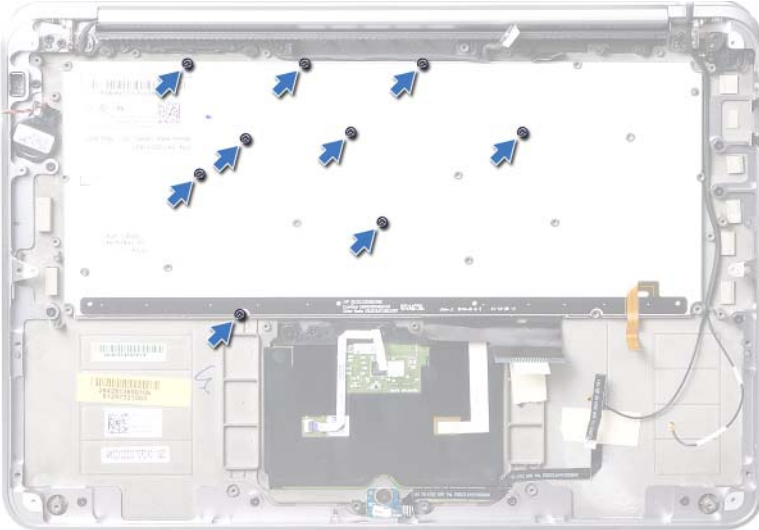

- 5 Lift the keyboard off the palm-rest assembly.



---

1 keyboard

---

# Replacing the Keyboard

---



**WARNING:** Before working inside your computer, read the safety information that shipped with your computer and follow the steps in "Before You Begin" on page 9. After working inside your computer, follow the instructions in "After Working Inside Your Computer" on page 11. For additional safety best practices information, see the Regulatory Compliance Homepage at [dell.com/regulatory\\_compliance](http://dell.com/regulatory_compliance).

## Procedure

- 1 Align the screw holes on the keyboard with the screw holes on the palm-rest assembly.
- 2 Replace the screws that secure the keyboard to the palm-rest assembly.
- 3 Align the screw holes on the keyboard bracket with the screw holes on the palm-rest assembly.
- 4 Replace the screws that secure the keyboard bracket to the palm-rest assembly.
- 5 Adhere the mylars to the keyboard bracket.

## Postrequisites

- 1 Replace the system board. See "Replacing the System Board" on page 57.
- 2 Replace the processor heat-sink. See "Replacing the Processor Heat-Sink" on page 48.
- 3 Replace the fan. See "Replacing the Fan" on page 46.
- 4 Replace the Mini-Card. See "Replacing the Wireless Mini-Card" on page 33.
- 5 Replace the I/O board. See "Replacing the I/O Board" on page 51.
- 6 Replace the mSATA/WWAN card. See "Replacing the mSATA/WWAN Card" on page 35.
- 7 Follow the instructions from step 4 to step 8 in "Replacing the Hard Drive" on page 39.
- 8 Replace the memory module(s). See "Replacing the Memory Module" on page 29.
- 9 Replace the battery. See "Replacing the Battery" on page 26.
- 10 Replace the speakers. See "Replacing the Speakers" on page 24.
- 11 Follow the instructions from step 2 to step 6 in "Replacing the Base Cover" on page 15.

# Removing the Palm Rest

---



**WARNING:** Before working inside your computer, read the safety information that shipped with your computer and follow the steps in "Before You Begin" on page 9. After working inside your computer, follow the instructions in "After Working Inside Your Computer" on page 11. For additional safety best practices information, see the Regulatory Compliance Homepage at [dell.com/regulatory\\_compliance](http://dell.com/regulatory_compliance).

## Prerequisites

- 1 Follow the instructions from step 1 to step 7 in "Removing the Base Cover" on page 12.
- 2 Remove the speakers. See "Removing the Speakers" on page 22.
- 3 Remove the battery. See "Removing the Battery" on page 25.
- 4 Follow the instructions from step 1 to step 5 in "Removing the Hard Drive" on page 36.
- 5 Remove the mSATA/WWAN card. See "Removing the mSATA/WWAN Mini-Card" on page 34.
- 6 Remove the I/O board. See "Removing the I/O Board" on page 49.
- 7 Remove the Mini-Card. See "Removing the Wireless Mini-Card" on page 31.
- 8 Remove the fan. See "Removing the Fan" on page 45.
- 9 Remove the processor heat-sink. See "Removing the Processor Heat-Sink" on page 47.
- 10 Remove the system board. See "Removing the System Board" on page 52.
- 11 Remove the air vent. See "Removing the Air Vent" on page 58.
- 12 Remove the keyboard. See "Removing the Keyboard" on page 63.

# Procedure

- 1 Remove the screws that secure the palm rest to the display hinges.
- 2 Open the palm rest as far as possible.

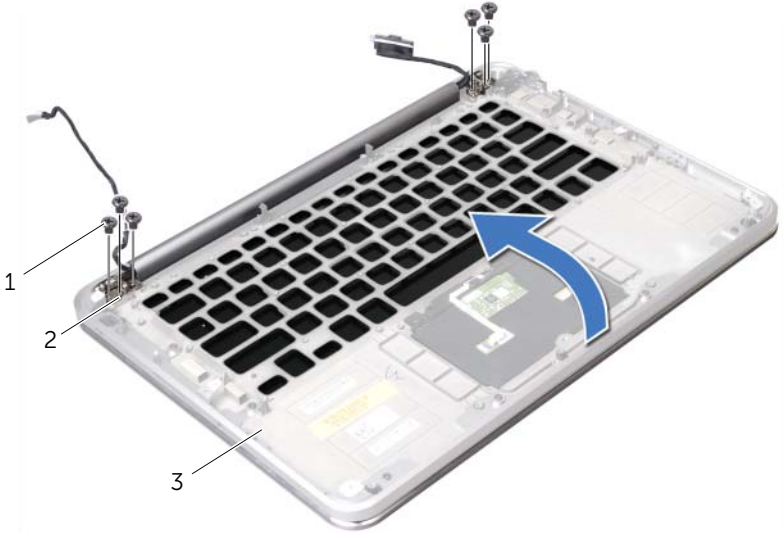

---

1	screws (6)	2	display hinges (2)
3	palm rest		

---

- 3 Slide and remove the palm rest from the display hinges and lift the palm rest away from the display.

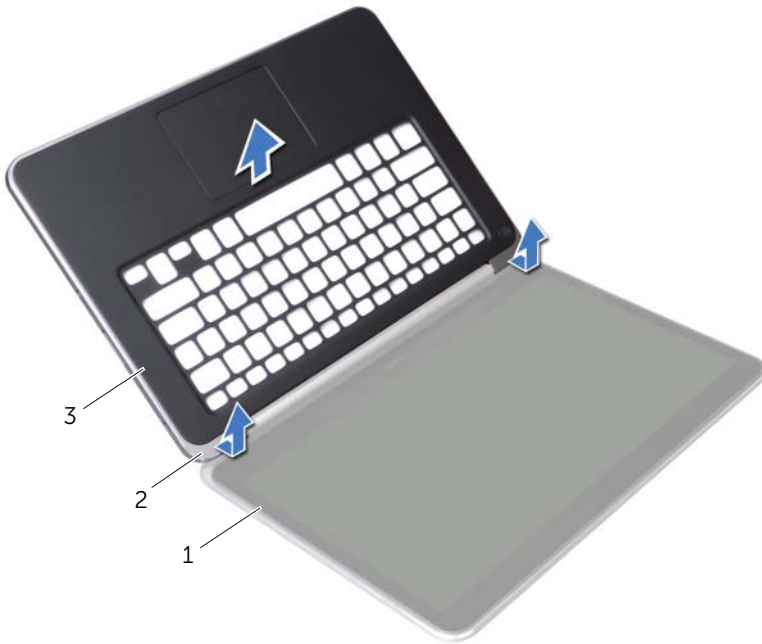

---

1	display	2	tabs (2)
3	palm rest		

---

# Replacing the Palm Rest

---



**WARNING:** Before working inside your computer, read the safety information that shipped with your computer and follow the steps in "Before You Begin" on page 9. After working inside your computer, follow the instructions in "After Working Inside Your Computer" on page 11. For additional safety best practices information, see the Regulatory Compliance Homepage at [dell.com/regulatory\\_compliance](http://dell.com/regulatory_compliance).

## Procedure

- 1 Slide the tabs on the palm rest under the display hinges and align the screw holes on the palm rest with the screw holes on the display hinges.
- 2 Replace the screws that secure the palm rest to the display.
- 3 Close the palm rest.

## Postrequisites

- 1 Replace the keyboard. See "Replacing the Keyboard" on page 67.
- 2 Replace the air vent. See "Replacing the Air Vent" on page 59.
- 3 Replace the system board. See "Replacing the System Board" on page 57.
- 4 Replace the processor heat-sink. See "Replacing the Processor Heat-Sink" on page 48.
- 5 Replace the fan. See "Replacing the Fan" on page 46.
- 6 Replace the Mini-Card. See "Replacing the Wireless Mini-Card" on page 33.
- 7 Replace the I/O board. See "Replacing the I/O Board" on page 51.
- 8 Replace the mSATA/WWAN card. See "Replacing the mSATA/WWAN Card" on page 35.
- 9 Follow the instructions from step 4 to step 8 in "Replacing the Hard Drive" on page 39.
- 10 Replace the battery. See "Replacing the Battery" on page 26.
- 11 Replace the speakers. See "Replacing the Speakers" on page 24.
- 12 Follow the instructions from step 2 to step 6 in "Replacing the Base Cover" on page 15.

# Flashing the BIOS

---

The BIOS may require flashing when an update is available or when replacing the system board. To flash the BIOS:

- 1 Turn on the computer.
- 2 Go to **support.dell.com/support/downloads**.
- 3 Locate the BIOS update file for your computer:



**NOTE:** The Service Tag for your computer is located on a label beneath the system badge at the back of your computer. For more information on locating the Service Tag, see the *Quick Start Guide* that shipped with your computer.

If you have your computer's Service Tag or Express Service Code:

- a Enter your computer's Service Tag or Express Service Code in the **Service Tag or Express Service Code** field.
- b Click **Submit** and proceed to step 4.

If you do not have your computer's Service Tag or Express Service Code:

- a Select one of the following options:
    - **Automatically detect my Service Tag for me**
    - **Choose from My Products and Services List**
    - **Choose from a list of all Dell products**
  - b Click **Continue** and follow the instructions on the screen.
- 4 A list of results appears on the screen. Click **BIOS**.
  - 5 Click **Download File** to download the latest BIOS file.
  - 6 In the **Please select your download method below** window, click For Single File Download via Browser, and then click **Download Now**.
  - 7 In the **Save As** window, select an appropriate location to download the file on your computer.
  - 8 If the **Download Complete** window appears, click **Close**.
  - 9 Navigate to the folder where you downloaded the BIOS update file.
  - 10 Double-click the BIOS update file icon and follow the instructions that appear on the screen.