



 PRODUCT CATALOGUE

2021

INDEX

6-7	PIEZOSURGERY® <i>touch</i>
8-9	PIEZOSURGERY® <i>white</i>
10	enzymec
11	universal cart
12-13	PIEZOSURGERY® spare parts
14	insert kits
15	basic kit/osteotomy kit
16	sinus lift lateral kit/piezo lift kit
17	sinus lift kit/implant prep kit
18	implant prep kit pro/implant prep kit starter
19	mini implant kit/extraction kit
20	explantation kit/periodontal kit
21	resective perio kit/retro surgical kit
22-23	indications
24	trays
25-27	implant prep inserts
28	mini dental implant inserts
29-32	osteotomy inserts
33-34	osteoplasty inserts
35	elevation inserts/periosteum inserts
36	endo retro inserts
37	extraction inserts/explantation inserts
38	periodontal inserts

39 implant cleaning inserts/crown prep tips

40 crown prep tips

42-43 bone expanders

44-45 sinus physiollift® II

46-47 multipiezo pro

48-49 multipiezo *white*

50-51 multipiezo *touch*

52-53 micropiezo

54 compact piezo LED/compact piezo

55-57 ultrasound accessories

58 insert sets

59 set maintenance/set scaling

60 set perio maintenance/set perio treatment

61 set implant cleaning/set endo

62 set endo revision/set endo retro

64 scaling inserts

65 scaling high efficiency inserts

66 perio universal inserts

67 perio anatomic inserts

68 implant cleaning inserts

69 endo inserts

70 endo revision inserts

→ **ULTRASOUND**

→ AIR-POLISHING

- 71 endo retro inserts
- 72 extraction inserts
- 73 cavity margin inserts/restorative inserts
- 74 crown prep inserts

- 76-79 *combi touch*
- 80-81 *combi*
- 82-83 *turbodent*
- 84-85 *starjet*
- 86-87 *prophylaxis powders*
- 88 *universal cart*
- 90-93 *spare parts*

→ DISINFECTION

- 94-95 *OzoActive*

→ LED-CURING

- 96-97 *starlight uno*
- 98-99 *starlight pro*
- 100-101 *starlight s+/starlight s*
- 102 *starlight ortho*
- 103 *spare parts*

- 104-105 appropriate settings for PIEZOSURGERY® inserts
- 106-107 appropriate settings for ultrasound inserts
- 108-109 *mectron online education*
- 110-114 *distributors*

We reserve the right to make technical changes and changes in the scope of the supply. No liability can be accepted for any errors. The reference numbers of the units are meant for standard packagings; they may differ in some countries and according to different voltages.

PIEZOSURGERY® *touch*

The future of bone surgery? Get in touch.



PIEZOSURGERY® *touch*

Equipment set:

- 1 PIEZOSURGERY® *touch* unit
- 1 LED-handpiece, complete with cord
- 1 kit of 8 tubes for pump
- 1 torque wrench K8
- 1 foot pedal
- power cord and suitcase

Ref. no.

05120061



→ TECHNICAL DATA

sizes (l x w x h in mm):

300 x 250 x 95 mm

weight:

3.2 kg

operating frequency:

24.000 – 36.000 Hz

power types:

6 functions

IMPLANT

CORTICAL

CANCELLOUS

SPECIAL

PERIO

ENDO

peristaltic pump capacity:

adjustable on the touch screen:

ENDO / PERIO - 7 levels: from 0 to 6

(from 0 to approximately 75 ml/min)

SPECIAL / CANCELLOUS / CORTICAL /

IMPLANT - 6 capacity levels: from 1 to 6

(from 8 to approximately 75 ml/min)

power supply voltage:

digital 100-240 VAC, 50/60 Hz

max. power absorbed: 120 VA

warranty:

2 years, handpiece 1 year

PIEZOSURGERY® *white*

Equipment set:

- 1 PIEZOSURGERY® *white* unit
- 1 kit of 8 tubes for pump
- 1 torque wrench K8
- 1 foot pedal
- power cord and suitcase
(handpiece and inserts not included)

Ref. no. 05120063

LED-HANDPIECE COMPLETE WITH CORD AND TRAY

- swivel-type LED light can be directed at the insert edge
- handpiece and handpiece cord (including the irrigation line) are fully sterilizable all at once

Ref. no. 03120134



HANDPIECE COMPLETE WITH CORD AND TRAY

- handpiece and handpiece cord (including the irrigation line) are fully sterilizable all at once

Ref. no. 03120217



PIEZOSURGERY® *white*

Get started in bone surgery!





→ TECHNICAL DATA

sizes (l x w x h in mm):

300 x 250 x 95 mm

weight:

3.2 kg

operating frequency:

24.000 – 36.000 Hz

power types:

6 functions

IMPLANT

CORTICAL

CANCELLOUS

SPECIAL

PERIO

ENDO

peristaltic pump capacity:

adjustable on the touch screen:

ENDO / PERIO - 7 levels: from 0 to 6

(from 0 to approximately 75 ml/min)

SPECIAL / CANCELLOUS / CORTICAL /

IMPLANT - 6 capacity levels: from 1 to 6

(from 8 to approximately 75 ml/min)

power supply voltage:

digital 100-240 VAC, 50/60 Hz

max. power absorbed: 120 VA

warranty:

2 years, handpiece 1 year

ENZYMEC

Enzymatic detergent

ENZYMEC is intended for use in cleaning of dental and general surgical instruments, and can be used during pre-cleaning in automatic equipments, ultrasonic cleaners and washer disinfectors according to the instructions and recommendations of the equipment manufacturer.

ENZYMEC

Product	Ref. no.
Enzymec bottle (1 liter)	03900001
Enzymec 4-bottle pack (4 liters)	03900002

- enzymatic solution for efficient removal of organic residues
- specifically dedicated to the “clean” function of all PIEZOSURGERY® devices
- with practical dosage cap



UNIVERSAL CART

For daily use

universal cart – maximum mobility for all your table-top devices. All supply lines are hidden in the easily accessible cable room. The power supply is brought at the tray's height, for an easy connection to your devices.



→ SIZES:

total (l x w x h in mm):

480 x 460 x 850 mm

upper tray:

480 x 370 in 770 mm height

middle tray:

420 x 310 in 440 mm height

lower tray:

480 x 370 in 65 mm height

weight:

29 kg

→ UNIVERSAL CART

Product

universal cart

**universal cart with
water & air connections**

Ref. no.

03540011

03540012



surgical tray



torque wrench K8



irrigation set



PIEZOSURGERY® insert box

SPARE PARTS

High quality spare parts for professionals



DPS adaptor



PIEZOSURGERY®
insert adaptor

ADAPTORS FOR THERMODISINFECTION

Product

Ref. no.

DPS Adaptor (for PIEZOSURGERY® dental irrigation line)*

04610006

spare filter for DPS Adaptor*

4590006

PIEZOSURGERY® insert Adaptor*

04610010

PIEZOSURGERY® COMMON SPARE PARTS

surgical tray

04610004

dynamometric torque wrench K8

02900109

dynamometric torque wrench K7 (for tipholder DB2)

02900081

irrigation set (50 pieces)

03230006

PIEZOSURGERY® insert box

02900111

insert tray

02900037

insert box with bone expander tray

02900107

insert box with implant insert tray

02900108

bag support rod

01380002

* not disposable

PIEZOSURGERY® *touch* AND PIEZOSURGERY® *white*

Product

LED-handpiece complete with cord (PS *touch* and PS *white*)

PIEZOSURGERY® *white* handpiece complete with cord

handpiece LED-cone

handpiece metal cone

handpiece holder

O-ring set for handpiece holder

mobile handpiece holder

kit of 8 tubes for pump

bone grafting kit (liquid flow rate reducer, equipped with 8 silicone tubes and 1 tube-tube connector)

protection foils

(pack of 10 pcs. - each in a single sterile packaging)

footswitch (PS *touch*)

footswitch (PS *white*)

PIEZOSURGERY® *touch* and *white* suitcase

Ref. no.

03120134

03120217

03020158

03020171

02900105

03020160

03110015

02900104

02900106

03230012

02900102

02900114

04440006

PIEZOSURGERY® I + II + 3

handpiece complete with cord

handpiece holder (PSII + 3)

kit of 8 tubes for pump (PSI)

kit of 8 tubes for pump (PSII + 3,
for handpiece cords with metal connector)

kit of 8 tubes for pump (PSII + 3,
for handpiece cords with plastic connector)

peristaltic pump rolling (PSII + 3)

tube-tube connector

footswitch (PSI + II)

footswitch (PS3)

PIEZOSURGERY® 3 suitcase

03120023

02900040

02900022

02900039

02900104

03210006

00680027

02900020

02900078

04440007

kit of 8 tubes for pump

protection foils

tube-tube
connector

LED-handpiece

mobile
handpiece
holder

handpiece complete
with cord

... INSERT KITS

Set of inserts for different applications

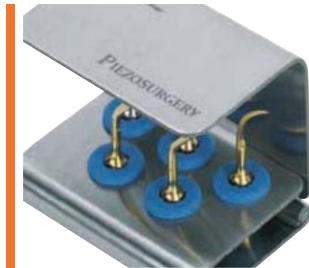

→ BASIC KIT



→ OSTEOTOMY KIT



→ INSERT KITS

Product	Ref. no.
basic kit equipped with inserts OT2, OT7, OP1, OP3 and EX1 description of the single inserts can be found on page 29, 30, 33 and 37	01520001
osteotomy kit equipped with inserts OT7, OT7S-4, OT7S-3, OT8R and OT8L description of the single inserts can be found on page 30	01520010

→ INSERT KITS

Product	Ref. no.
sinus lift lateral kit* equipped with inserts SLC, SLO-H, SLS, SLE1 and SLE2 description of the single inserts can be found on page 31, 34 and 35	01520023
piezo lift kit equipped with inserts PL1, PL2 and PL3 description of the single inserts can be found on page 32	01520024

* developed in collaboration with Prof. Tomaso Vercellotti
and Dr. Philippe Russe

→ SINUS LIFT LATERAL KIT



→ PIEZO LIFT KIT



→ SINUS LIFT KIT



→ IMPLANT PREP KIT



→ INSERT KITS

Product

Ref. no.

sinus lift kit

01520002

equipped with inserts

OT1, OT5, EL1, EL2 and EL3

description of the single inserts can
be found on page 29 and 35

implant prep kit

01520008

equipped with inserts

IM1S, IM2A, IM2P, IM3A, IM3P, OT4

description of the single inserts can
be found on page 25, 26, 27 and 29

→ INSERT KITS

Product

Ref. no.

implant prep kit pro

01520011

equipped with inserts

IM1S, IM2A, IM2P, IM3A, IM3P, OT4, IM4A, IM4P, P2-3, P3-4, 3 PINS IM1S, 3 PINS 2-2,4

description of the single inserts can be found on page 25, 26, 27 and 29

implant prep kit starter

01520017

equipped with inserts

IM1S, IM2P, IM3P, P2-3, OT4

description of the single inserts can be found on page 25, 26, 27 and 29

→ IMPLANT PREP KIT PRO



→ IMPLANT PREP KIT STARTER



→ MINI IMPLANT PREP KIT



→ EXTRACTION KIT



→ INSERT KITS

Product

Ref. no.

mini implant prep kit

01520016

equipped with inserts
IM1S, MDI 1.9, MDI 2.2, MDI 2.5
description of the single inserts can
be found on page 25 and 28

extraction kit

01520003

equipped with inserts
EX1, EX2, EX3, PS2 and PS6
description of the single inserts can
be found on page 37 and 38

→ INSERT KITS

Product

Ref. no.

explantation kit

01520021

equipped with inserts

EXP3-R, EXP3-L, EXP4-R, EXP4-L

description of the single inserts can
be found on page 37

periodontal kit

01520004

equipped with inserts

PS2, OP5, PP1, OP3 and OP3A

description of the single inserts can
be found on page 33 and 38

→ EXPLANATION KIT



→ PERIODONTAL KIT

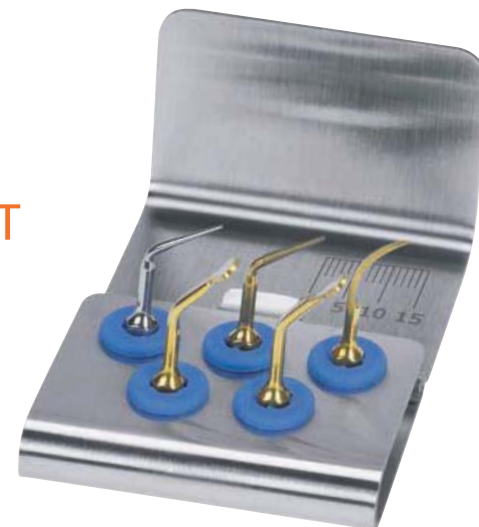

→ RESECTIVE PERIO KIT



→ RETRO SURGICAL KIT



→ INSERT KITS

Product	Ref. no.
resective perio kit* equipped with inserts OT13, OT14, OP5A, OP8** and OP9 description of the single inserts can be found on page 31, 33 and 34	01520022
retro surgical kit equipped with inserts OP7, EN1, EN3, EN5R, EN5L description of the single inserts can be found on page 34 and 36	01520005

* developed in collaboration with Professor Leonardo Trombelli from the University of Ferrara

** only available for PIEZOSURGERY® 3, PIEZOSURGERY® touch and PIEZOSURGERY® white

INDICATIONS

Surgical choice: all

→ SINUS LIFT
CRESTAL APPROACH



→ PIEZO-LIFT

→ PL1 → PL2 → PL3

→ SINUS LIFT
LATERAL APPROACH



→ SINUS PHYSIOLIFT

→ IM1 SP → IM2 SP → P2-3 SP → OT9 → CS1 → CS2 → PIN IM1 → PIN 2-2.4 → PROBE SP

→ STANDARD

→ OPTIONAL

→ SLC → SLO-H → SLS → SLE1 → SLE2 → OP3 → OT1 → OT1A → OT5 → OT5A → OT5B → EL1 → EL2 → EL3

→ IMPLANT SITE
PREPARATION



→ STANDARD

→ IM1S → IM2A → IM3A → IM4A → IM2P → IM3P → IM4P → OT4 → P2-3 → P3-4

→ OPTIONAL

→ IM1 AL → IM2A-15 → IM2.8A → IM3A-15 → IM3.4A → IM2P-15 → IM2.8P → IM3P-15 → IM3.4P

→ MINI DENTAL IMPLANT
SITE PREPARATION



→ STANDARD

→ IM1S → MDI 1.9 → MDI 2.2 → MDI 2.5

→ RIDGE EXPANSION



→ STANDARD

→ OPTIONAL

→ OT7 → OT4 → OP5 → OT2 → OT7A → OT7S-4 → OT7S-3 → OT12 → OT12S → OT7-20

→ PERIOSTEUM
PREPARATION



→ STANDARD

→ PR1 → PR2

→ STANDARD
 → EX1 → EX2 → EX3 → PS2

→ STANDARD
 → EXP3-R → EXP3-L → EXP4-R → EXP4-L

→ STANDARD → OPTIONAL
 → OT7 → OP5 → OT8R → OT8L → OT6 → OT7A → OT7S-4 → OT7S-3 → OT12 → OT12S → OT7-20

→ STANDARD → OPTIONAL
 → OP3 → OP1 → OP2 → OP3A

→ STANDARD → OPTIONAL
 → OP7 → PS2 → EN1 → EN2 → EN3 → EN4 → EN5R → EN5L → EN6R → EN6L → OP3

→ STANDARD
 → OT1 → OT5

→ STANDARD → OPTIONAL
 OT7S-4 → OT7S-3 → OT7 → OT7A

→ STANDARD
 → OP5A → OP8* → OP9 → OT13 → OT14 → OP5 → OP3 → PS2 → PP1 → ICP + IC1

→ OPTIONAL
 → PS1 → PS6 → PP10 → PP11 → PP12 → OP2 → OP3A → OP4 → OP6 → OP6A

→ STANDARD
 → DB2 → CROWN PREP TIPS



→ EXTRACTIONS



→ EXPLANTATION



→ BONE BLOCK GRAFTING



→ BONE CHIP GRAFTING/
BONE MODELING



→ ENDODONTICS



→ OSTEOTOMY
CLOSE TO NERVES



→ CORTICOTOMY
TECHNIQUE



→ PERIODONTAL SURGERY
AND IMPLANT CLEANING



→ PROSTHETICS

* only available for PIEZOSURGERY[®] 3, PIEZOSURGERY[®] touch and PIEZOSURGERY white

TRAYS

Do you like boxing? Don't miss them then.

PIEZOSURGERY® INSERT BOX

- fully autoclavable
- perfect storage of all PIEZOSURGERY® inserts
- light, easy to use, compact and roomy

Ref. no. 02900111

INSERT TRAY

- stainless steel tray with depth markings
- for storage

Ref. no. 02900037



PIEZOSURGERY® insert box

→ INSERTS

For every clinical needs, the proper insert.

→ IMPLANT PREP



IM1S



PIN IM1S



PIN 2-2.4



PIN 2-3



IM1-AL



PIN IM1-AL



PIN 2-2.4-AL



PIN 2-3-AL

→ IMPLANT PREP INSERTS

Product	Ref. no.
insert IM1S initial pilot osteotomy diamond grain size 30 µm	03510019
PIN IM1S	03740007
PIN 2-2.4	03740003
PIN 2-3 alignment pins, dedicated to IM1S, IM2 (Ø 2), IM3 (Ø 3), OT4 (Ø 2.4) , IM1 SP	03740001
insert IM1 AL initial pilot osteotomy diamond grain size 30 µm	03510010
PIN IM1 AL	03740004
PIN 2-2.4 AL	03740005
PIN 2-3 AL 30 mm alignment pins, for extraction sites dedicated to M1 AL, IM2A (Ø 2), OT4 (Ø 2.4), IM3A (Ø 3)	03740006

→ IMPLANT PREP



→ IMPLANT PREP INSERTS

Product	Ref. no.
insert IM2A	03510001
insert IM2A-15	03510015
insert IM2P	03510002
insert IM2P-15	03510016
pilot osteotomy in anterior and posterior region	
insert IM2.8A	03510025
insert IM2.8P	03510026
insert IM3A	03510003
insert IM3A-15	03510017

to enlarge or to finalize the implant site preparation;
insert with double irrigation to avoid overheating

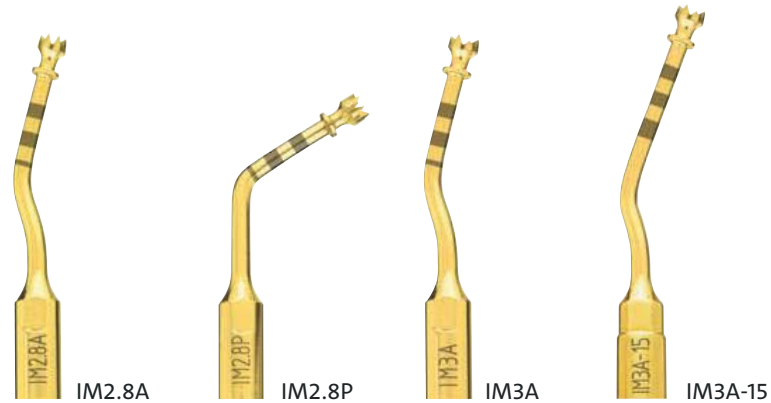

→ IMPLANT PREP

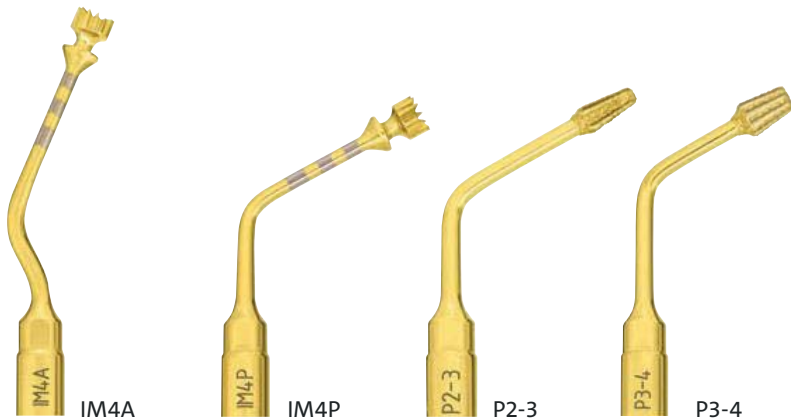
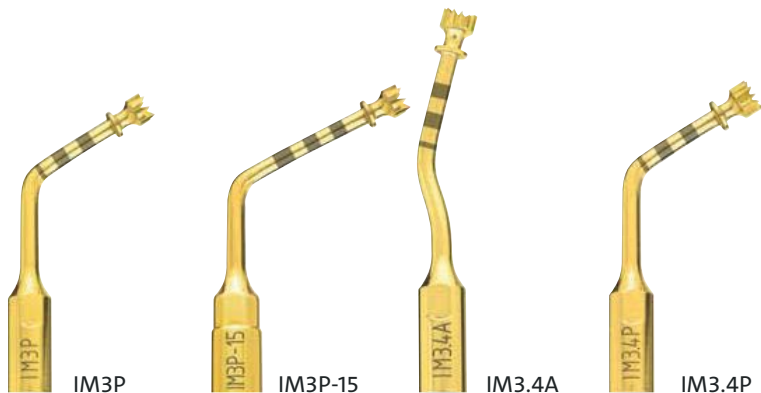

→ IMPLANT PREP INSERTS

Product	Ref. no.
insert IM3P	03510004
insert IM3P-15	03510018
insert IM3.4A	03510027
insert IM3.4P	03510028
to enlarge or to finalize the implant site preparation; insert with double irrigation to avoid overheating	
insert IM4A	03510005
insert IM4P	03510006
to finalize the implant site preparation; insert with double irrigation to avoid overheating	
insert P2-3	03510020
insert P3-4	03510021
to optimize concentricity of implant site preparation between $\varnothing 2$ and $\varnothing 3$ mm diamond grain size 150 μm	

➔ MINI DENTAL IMPLANT



➔ MINI DENTAL IMPLANT INSERTS

Product	Ref. no.
insert MDI 1.9	03510012
insert MDI 2.2	03510013
insert MDI 2.5	03510014

osteotomy technique for mini implants site preparation

→ OSTEOTOMY



→ OSTEOTOMY INSERTS

Product	Ref. no.
insert OT1	03370001
insert OT1A	03370008
to finalize the osteotomy in proximity of soft tissues (for example: sinus membrane, vessel, alveolar nerve) OT1 diamond grain size 91 µm OT1A diamond grain size 126 µm	
insert OT2	03370002
osteotome of great precision in anatomically thin structures (for example, ridge expansion, interdental corticotomies, non traumatic nasal spine)	
insert OT3	03370003
mandibular corticotomy, block harvesting, fragmenta osteotomy	
insert OT4	03370004
to correct pilot osteotomy axis, to finalize the implant site preparation close to the alveolar nerve; sinus crestal approach technique diamond grain size 151 µm	
insert OT5	03370005
insert OT5A	03370009
insert OT5B	03370010
non-traumatic, to finalize the osteotomy or osteoplasty on thin bone and/or near delicate anatomic structures OT5 Ø 1,7 - diamond grain size 91 µm OT5A Ø 1,9 - diamond grain size 91 µm OT5B Ø 1,7 - diamond grain size 126 µm	

OSTEOTOMY INSERTS

Product Ref. no.
insert OT6 03370006

osteotomy of large bone sections
 during maxillofacial surgery

insert OT7 3370007

insert OT7A 03370011

all the osteotomy technique in maxilla and mandible
 – ridge expansion
 – corticotomy technique
 – bone block grafting

Set OT7-20 02900103

(consists of insert OT7-20
 and torque wrench K8)

insert OT7-20* 03370017

ridge expansion technique, bone block grafting
 (from chin/mandible ramus), Le Fort I osteotomy,
 bilateral sagittal split osteotomy

insert OT7S-4 03370014

insert OT7S-3 03370015

very thin osteotomy, corticotomy for orthodontic
 microsurgery technique, root separation in dental
 extraction technique and periodontal surgery

insert OT8R 03370012

insert OT8L 03370013

all the osteotomy technique in maxilla and mandible
 – bone block grafting

* tighten up this insert only with torque wrench K8

OSTEOTOMY



OT6 OT7A OT7 OT7-20
 5 teeth, thickness 0.75 mm 5 teeth, thickness 0.75 mm 5 teeth, thickness 0.55 mm 5 teeth, thickness 0.6 mm



OT7S-4 OT7S-3 OT8R OT8L
 4 teeth, thickness 0.35 mm 3 teeth, thickness 0.35 mm thickness 0.6 mm thickness 0.6 mm

→ OSTEOTOMY



→ OSTEOTOMY INSERTS

Product	Ref. no.
insert OT9	03370016
to finalize the osteotomy or osteoplasty near delicate anatomic structures; removal of the sinus basal cortex in Sinus Physiolift® procedure; insert with double irrigation to avoid overheating	
insert OT11	03370019
removal of the sinus basal cortex and elevation of the sinus membrane during crestal sinus lift procedures	
insert OT12	03370020
insert OT12S	03370021
dedicated to the osteotomy techniques where the standard piezoelectric bone saws may have a difficult surgical approach	
insert OT13	03370022
insert OT14	03370023
non-traumatic bone defect preparation on buccal and/or palatal cortical plates in resective periodontal surgery	
OT13 Ø 1.7 - diamond grain size 150 µm	
OT14 Ø 2.3 - diamond grain size 150 µm	
insert SLO-H	03370025
bone window antrostomy in sinus lift procedure by vestibular approach	

→ OSTEOTOMY



→ OSTEOTOMY INSERTS

Product Ref. no.

insert PL1 03370026
sinus floor reaching and safe bony ring removal during
crestal sinus lift procedure (PIEZO-LIFT)

insert PL2 03370027
sinus floor consumption and initial membrane elevation
during crestal sinus lift procedure (PIEZO-LIFT)

insert PL3 03370028
removal of the sinus basal cortex and elevation of the
sinus membrane during crestal sinus lift procedure
(PIEZO-LIFT)

→ OSTEOPLASTY

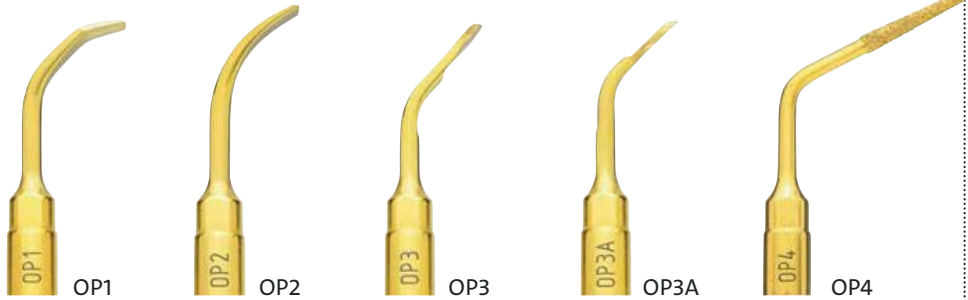

→ OSTEOPLASTY INSERTS

Product	Ref. no.
insert OP1 bone remodelling and harvesting of bone chips	03380001
insert OP2 bone osteotomy, remodelling and removal of inflammatory tissue	03380002
insert OP3 insert OP3A periodontal osteotomy, crown lengthening, bone chips harvesting, inflammatory tissue removal (cyst, etc.)	03380003 03380011
insert OP4 interproximal osteoplasty and root planing diamond grain size 126 µm	03380004
insert OP5 insert OP5A root debridement and root planing during resective and regenerative periodontal surgery OP5 diamond grain size 30 µm OP5A diamond grain size 90 µm	03380005 03380012
insert OP6 insert OP6A root preparation in periodontal surgery OP6 diamond grain size 126 µm OP6A diamond grain size 30 µm	03380006 03380010

OSTEOPLASTY INSERTS

Product	Ref. no.
insert OP7	03380007
peri-apical maxillary bone osteotomy access, inflammatory tissue removal	
insert OP8*	03380008
insert OP9	03380009
Interproximal osteoplasty without damaging adjacent root surfaces	
OP8* cutting edge from 0.7 - 1.3 mm	
OP9 cutting edge from 1 - 2 mm	
insert SLC	03380013
bone consuming during lateral sinus lift procedures	

* only available for PIEZOSURGERY® 3, PIEZOSURGERY® *touch*
and PIEZOSURGERY® *white*

OSTEOPLASTY

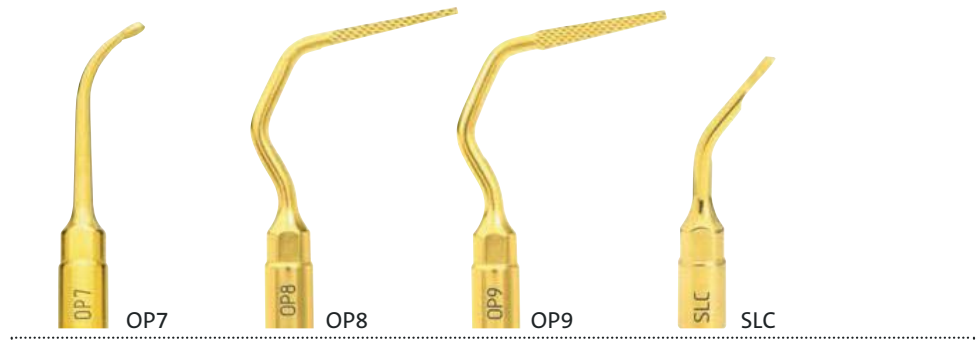

→ ELEVATION



→ PERIOSTEUM



→ ELEVATION INSERTS

Product	Ref. no.
insert EL1 separation of the sinus membrane, 2 mm around the frame of bony window	03390001
insert EL2	03390002
insert EL3 separation of the sinus membrane in internal zones	03390003
insert SLS separation of the sinus membrane during lateral sinus lift procedures	03390006
insert SLE1 elevation of the sinus membrane from the sinus floor	03390007
insert SLE2 elevation of the sinus membrane from the palatal sinus wall	03390008

→ PERIOSTEUM INSERTS

insert PR1	03390004
insert PR2 subperiosteal preparation	03390005

ENDO RETRO INSERTS

Product	Ref. no.
insert EN1 diamond-coated endo apical debrider 3 mm, apical root debridement diamond grain size 30 µm	02170001
insert EN2 smooth endo apical debrider 3 mm, gentle apical root debridement	02170002
insert EN3 diamond-coated endo apical debrider 2.2 mm, apical root debridement diamond grain size 30 µm	02170005
insert EN4 smooth endo apical debrider 2.2 mm, gentle apical root debridement	02170006
insert EN5R	02170007
insert EN5L right and left angled, diamond-coated endo apical debrider 2.2 mm, apical root debridement diamond grain size 30 µm	02170008
insert EN6R	02170009
insert EN6L right and left angled, smooth endo apical debrider 2.2 mm, apical root debridement	02170010

ENDO RETRO



→ EXTRACTION



EX1



EX2



EX3

→ EXPLANTATION



EXP3-R



EXP3-L



EXP4-R



EXP4-L

→ EXTRACTION INSERTS

Product	Ref. no.
insert EX1	03400001
to cut off the ankylosis, root fraction techniques	
insert EX2	03400002
analogue to EX1 in the posterior regions	
insert EX3	03400003
analogue to EX1 in the posterior regions	

→ EXPLANTATION INSERTS

insert EXP3-R	03400004
insert EXP3-L	03400005
insert EXP4-R	03400006
insert EXP4-L	03400007
explantations	

PERIODONTAL INSERTS

Product	Ref. no.
insert PS1 root scaling	03180001
insert PS2 scaling and inflammatory tissue removal fractured root apex extraction	03180003
insert PS6 root scaling	03180005
insert PP1 root planing	03180002
insert PP10 gentle subgingival concrements removal	03180006
insert PP11 gentle subgingival concrements removal	03180007
insert PP12 gentle subgingival concrements removal	03180008

PERIO

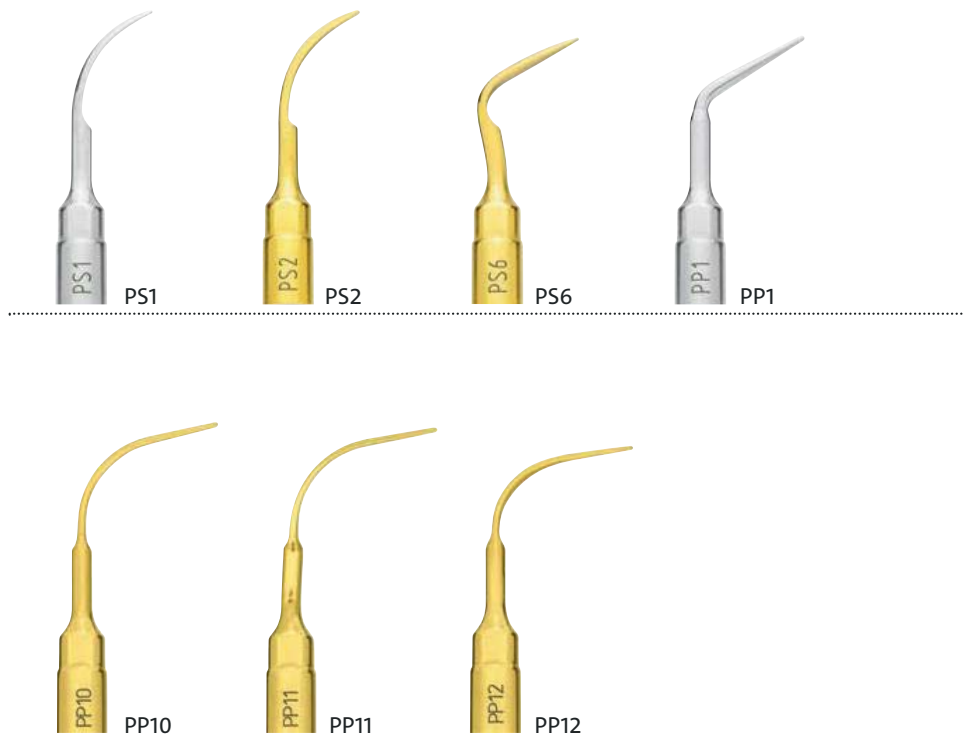

→ IMPLANT CLEANING



→ IMPLANT CLEANING TIPS

Product	Ref. no.
Implant cleaning set P (consists of a tipholder ICP and 5 tips IC1)	01520020
tipholder ICP	03570003
tip IC1 (5 pieces)	02900112

efficient and soft cleaning of implants and restorations; implant cleaning tip IC1 can be easily tightened without any special tools and is fully autoclavable

→ CROWN PREP TIPHOLDER FOR
PIEZOSURGERY® HANDPIECES

Product	Ref. no.
crown prep set PS	02160010
equipped with DB2, AB1 and K7	
tipholder DB2	03570002

→ CROWN PREP TIPHOLDER ACCESSORIES

key AB1	03580001
dynamometric wrench K7	02900081

→ CROWN PREP TIPS FOR CHAMFER T.

crown prep tip TA12D60	03590001
crown prep tip TA14D60	03590002
crown prep tip TA16D60	03590003
crown prep tip TA12D90	03590004
crown prep tip TA14D90	03590005
crown prep tip TA16D90	03590006
crown prep tip TA14D120	03590007
crown prep tip TA16D120	03590008

→ CROWN PREP TIPS FOR VERTICAL T.

crown prep tip TF12D60	03590010
crown prep tip TF16D60	03590011
crown prep tip TF12D90	03590012
crown prep tip TF16D90	03590013

→ CROWN PREP



key AB1



dynamometric
wrench K7

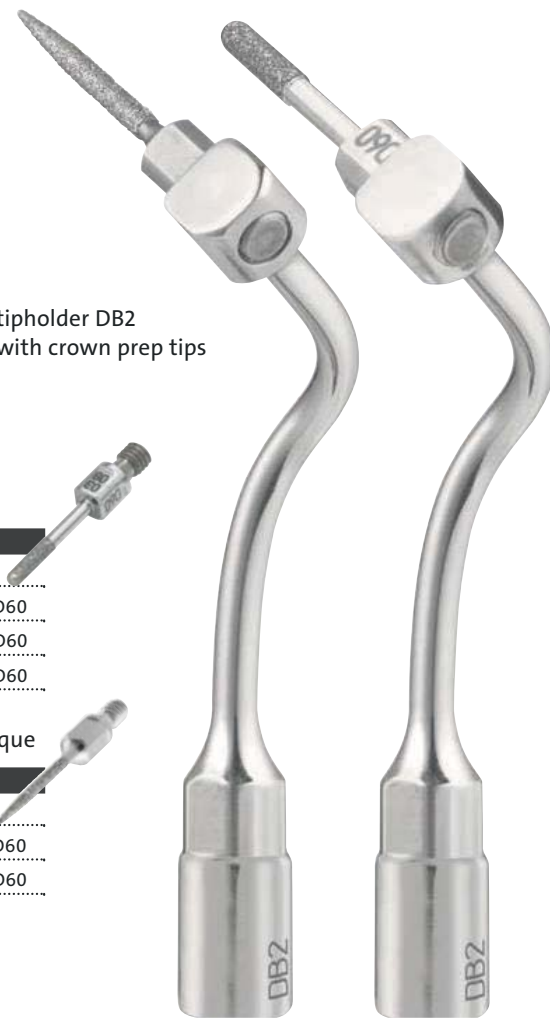

tipholder DB2
with crown prep tips

→ Available lengths and diameters
of crown prep tips

Preparation with chamfer technique

→ Length 10 mm	→ Diamond coating		
diameter	D120	D90	D60
1.2 mm		TA12D90	TA12D60
1.4 mm	TA14D120	TA14D90	TA14D60
1.6 mm	TA16D120	TA16D90	TA16D60

Preparation with vertical preparation technique

→ Length 10 mm	→ Diamond coating		
diameter		D90	D60
1.2 mm		TF12D90	TF12D60
1.6 mm		TF16D90	TF16D60

→ BONE EXPANDERS

Improved primary stability and less trauma

→ BONE EXPANDER KITS

Product	Ref. no.
bone expander kit equipped with: 1 expander of each type, 1 ADM8, 1 bone expander tray	03770001
bone expander kit pro equipped with: 1 expander of each type, 1 ADM8, 1 ADR16, 1 ADR7, 1 ratchet, 1 bone expander tray	03770002
bone expander kit pro s equipped with: 2 expanders of each type, 1 ADM8, 1 ADR16, 1 ADR7, 1 ratchet, 1 bone expander tray	03770005



bone expander kit pro s



- Technique for expanding the atrophic alveolar ridge
- Lateral bone condensation technique
- Alternative to the maxillary sinus elevation technique

→ BONE EXPANDERS (∅ x length in mm)

Product	Ref. no.
2.5 x 11.5	03780001
2.5 x 15	03780002
3.5 x 11.5	03780003
3.5 x 15	03780004
4.5 x 11.5	03780005
4.5 x 15	03780006
ADM8	03790001
Adapter for micromotor	
ADR7	03790002
Short adapter for ratchet	
ADR16	03790003
Long adapter for ratchet	
Ratchet	02270005

SINUS PHYSIOLIFT® II KITS

Product

Ref. no.

sinus physiolift® II pro kit

03770012

equipped with:

PIEZOSURGERY® inserts: IM1 SP, IM2 SP, P2-3 SP, OT9

Alignment pins: PIN IM1, PIN 2-2.4

Crestal sinus elevators 2 x CS1 and 2 x CS2

Pressure control system: Physiolifter

Ball shaped probe PROBE SP

Micromotor and ratchet adapters: ADM10, ADR10

Ratchet

3 insert trays, 3 silicone tubes with tube-tube connector, 2 complete sealed tubes, 3 sterile disposable syringes, Clinical Protocol and DVD

sinus physiolift® II basic kit

03770011

equipped with:

Crestal sinus elevators 2 x CS1 and 2 x CS2

Pressure control system: Physiolifter

Ball shaped probe PROBE SP

Micromotor and ratchet adapters: ADM10, ADR10

Ratchet

2 insert trays, 3 silicone tubes with tube-tube connector, 2 complete sealed tubes, 3 sterile disposable syringes, Clinical Protocol and DVD

sinus physiolift® II starter kit

03770013

equipped with:

Crestal sinus elevators 1 x CS1 and 1 x CS2

Pressure control system: Physiolifter

Micromotor adapter: ADM10

1 insert tray, 1 silicone tube with tube-tube connector,

1 complete sealed tube, 1 sterile disposable syringe,

Clinical Protocol and DVD

SINUS PHYSIOLIFT® II

Controls pressure in the sinus cavity!

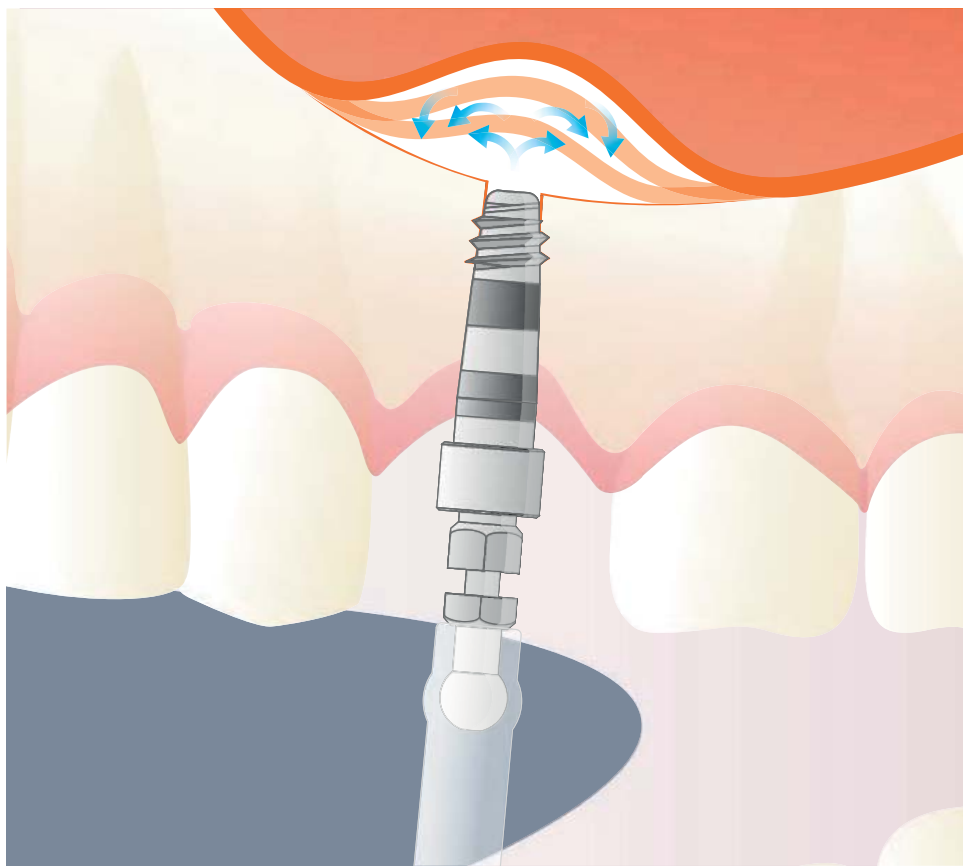



→ SINUS PHYSIOLIFT® II PARTS

Product	Ref. no.
insert IM1 SP	03510011
insert IM2 SP	03510022
insert P2-3 SP	03510024
insert OT9	03370016
PIN IM1	03740002
PIN 2-2.4	03740003
Crestal Sinus Elevator CS1	03920001
Crestal Sinus Elevator CS2	03920002
Ball shaped probe PROBE SP	03920003
Physiolifter	02900097
Micromotor adapter length 10 mm (ADM10)	03790004
Ratchet adapter length 10 mm (ADR10)	03790005
Ratchet	02270005
Silicone tube with tube-tube connector	02900098
Complete sealed tube	02900099
Insert tray physiolift® (small)	02900100
Insert tray physiolift® (large)	02900101

MULTIPIEZO PRO

Put variety into practice, the multi-functional ultrasonic unit.

The widest range of indications in the market. An extremely wide ultrasound power range. Innovative electronics. Unique ergonomics. Put it all together – and you come up with the mectron **multi piezo pro**.



MULTIPIEZO PRO

Equipment set

- 1 multipiezo pro
- 2 LED ultrasonic handpieces
- 3 bottles – 500 ml
- 3 safety bottle caps

Ref. no.

05060021

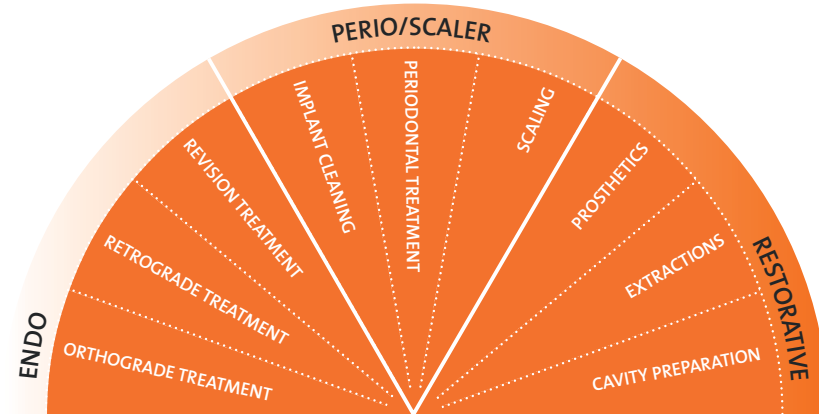



→ TECHNICAL DATA

sizes (l x w x h in mm):

440 x 230 x 145

weight:

3.3 kg

operating frequency:

24.000 – 36.000 Hz

power types:

3 functions, each with seven power levels, SOFT MODE

liquid supply:

via removable bottle

liquid quantity:

adjustable in 7 levels

liquid flow rate:

between 0 and 28 ml

warranty:

2 years, handpiece 1 year



→ MULTIPIEZO *white*

Equipment set

- 1 multipiezo
- 1 LED ultrasonic handpiece
- 3 inserts: scaling inserts S1 and S6, perio insert P10
- 2 bottles, 500 ml
- 2 safety bottle caps

Ref. no.

05060025

→ MULTIPIEZO *white*

Bright prospects for a bright future.

RESTORATIVE MODE PULSE MODE

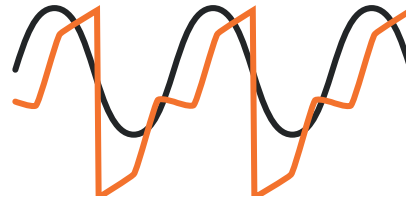

→ Pulse Mode

Pulse Mode (level 6 of restorative function) transforms sine wave-shaped ultrasound oscillations to a new profile, characterized by specific power peaks, which results in an optimized performance for extractions and prosthetics.

STANDARD MODE SOFT MODE

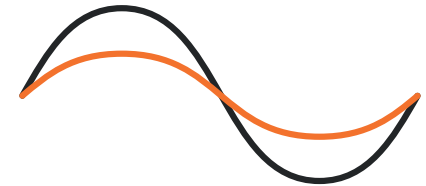

→ SOFT MODE

- special modulation for gentle but still powerful insert movement
- maximum comfort for sensitive patients



→ TECHNICAL DATA

sizes (l x w x h in mm):

320 x 230 x 145

weight:

2.4 kg

operating frequency:

24.000 – 36.000 Hz

power types:

3 functions, each with seven power levels, SOFT MODE

liquid supply:

via removable bottle

liquid quantity:

adjustable in 7 levels

liquid flow rate:

between 0 and 28 ml

warranty:

2 years, handpiece 1 year



→ MULTIPIEZO *touch*

Equipment set

- 1 multipiezo
- 1 LED ultrasonic handpiece
- 3 inserts: scaling inserts S1 and S6, perio insert P10
- 2 bottles, 500 ml
- 2 safety bottle caps

Ref. no.

05060024

→ MULTIPIEZO *touch*

Looking beautiful is looking really beautiful.

RESTORATIVE MODE PULSE MODE

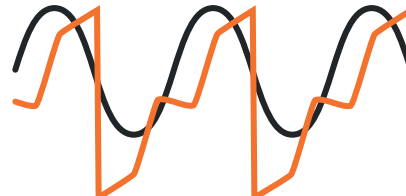

→ Pulse Mode

Pulse Mode (level 6 of restorative function) transforms sine wave-shaped ultrasound oscillations to a new profile, characterized by specific power peaks, which results in an optimized performance for extractions and prosthetics.

STANDARD MODE SOFT MODE

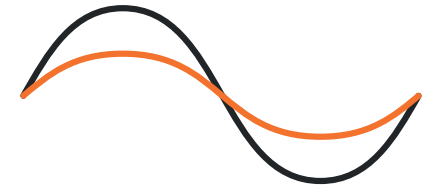

→ SOFT MODE

- special modulation for gentle but still powerful insert movement
- maximum comfort for sensitive patients



→ TECHNICAL DATA

sizes (l x w x h in mm):

320 x 230 x 145

weight:

2.4 kg

operating frequency:

24.000 – 36.000 Hz

power types:

3 functions, each with seven power levels, SOFT MODE

liquid supply:

via removable bottle

liquid quantity:

adjustable in 7 levels

liquid flow rate:

between 0 and 28 ml

warranty:

2 years, handpiece 1 year

MICROPIEZO

A new era in ultrasound devices.

The new advanced entry level ultrasound scaler with three functions:

- scaling and perio treatments
- endodontic treatments
- prosthetic treatments

Patients benefit from gentle ultrasound scaling in SOFT MODE.



MICROPIEZO

- 1 micropiezo
- 1 LED ultrasonic handpiece slim
- 2 inserts: scaling insert S1-S and perio insert P10
- 1 liquid container, 500 ml
- 1 footpedal

Ref. no.

05080013





Integrated WIFI
technology allowing
remote assistance



→ **TECHNICAL DATA**

sizes (l x w x h in mm):

161 x 214 x 171

weight:

0.94 kg

operating frequency:

24.000 – 36.000 Hz

power types:

3 functions (endo, perio-scaling, prosthetics),
SOFT MODE, each with seven power levels

liquid supply:

via removable bottle

liquid quantity:

adjustable in 7 levels

liquid flow rate:

between 0 and 33 ml

available within summer 2021

→ TECHNICAL DATA

operating frequency:

24.000 – 36.000 Hz

power types:

adjustable via the dental chair

power supply:

24 VAC, 50-60 Hz / 32 VDC

water supply:

via the dental unit

warranty:

2 years, handpiece 1 year

→ COMPACT PIEZO LED

Equipment set

1 electronic module

1 LED ultrasonic handpiece

1 basic kit equipped with: scaling inserts S1
and S6, perio inserts P1 and P10

Ref. no. 05090008

→ COMPACT PIEZO P2K

Equipment set

1 electronic module

1 ultrasonic handpiece

1 basic kit equipped with: scaling inserts S1, S2,
S3 and 1 high-efficiency scaling insert S6

Ref. no. 05090003

COMPACT PIEZO LED

COMPACT PIEZO

Compact efficiency or directly built-in.



Including feedback-system for constant power.

SPARE PARTS

High quality spare parts for your ultrasound device.



DSC adaptor for ultrasound inserts

scaler insert adaptor

ADAPTORS FOR THERMODISINFECTION

Product

Ref. no.

DSC Adaptor (for scaler handpiece irrigation line)*

04610007

Spare filter for DSC Adaptor*

04590006

Scaler insert Adaptor*

04610009

COMMON SPARE PARTS

dynamometric torque wrench K10

02900137-001

dynamometric torque wrench K6

02900074

dynamometric wrench K7 (for tipholder DB1)

02900081

water filter

00420004

insert tray

02900072

universal cart

03540011

universal cart with water & air connections

03540012

* not disposable

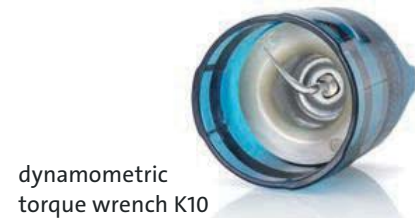

dynamometric torque wrench K10



dynamometric torque wrenches K6 and K7



water filter



safety bottle cap
(blue)



plastic bottle (piezo smart),
with complete bottle cap



plastic bottle
(multipiezo)
with complete
bottle cap



→ SPARE PARTS ULTRASOUND UNITS WITH LED HANDPIECE

Product	Ref. no.
LED ultrasonic handpiece	03120142
handpiece LED-cone	03020158
handpiece metal cone	03020171

→ SPARE PARTS ULTRASOUND UNITS WITHOUT LED HANDPIECE

ultrasonic handpiece (grey)	03120016
ultrasonic handpiece (blue)	03120132
handpiece metal cone	00710034

→ BOTTLES AND BOTTLE CAPS FOR PIEZO SMART, MULTIPIEZO PRO AND MULTIPIEZO

plastic bottle (piezo smart), 300 ml, with blue complete bottle cap	03020066
plastic bottle (piezo smart), 300 ml, with grey complete bottle cap	03020067
plastic bottle (piezo smart), 300 ml, without cap	03230007
plastic bottle (multipiezo), 500 ml, without cap	03150102
complete bottle cap, blue	03020081
complete bottle cap, grey	03020082
safety bottle cap, grey	01950015
safety bottle cap, blue	01950014

SPARE PARTS MULTIEZIO RANGE

Product	Ref. no.
O-ring set for bottle holder (6 pieces)	03020175
peristaltic pump (white)	03210001
peristaltic pump (black - from serial no. 106005993)	03210009
footswitch	02900114

SPARE PARTS MICROPIEZO

LED ultrasonic handpiece slim	03120238-001
kit light guide, metal cone and blue O-ring for LED ultrasonic handpiece slim	02900146-001
liquid container (incl. cap, 500ml)	02900145-001
footpedal	02900144-001
pump	03210009-001
power adapter	03160024-001
kit O-ring + spring for liquid container	02900147-001

SPARE PARTS PIEZO SMART

O-ring set for bottle holder (3 pieces)	03020068
peristaltic pump	03210007
footswitch	02900055
power adapter piezo smart	03020105

SPARE PARTS MICROPIEZO S

footswitch	02900001
water filter	00420004



ultrasonic handpiece (grey)



ultrasonic handpiece (blue)



LED ultrasonic handpiece



LED ultrasonic handpiece slim

→ INSERT SETS

An insert set for every indication.



→ **SafeKey K10 – protects your handpiece and inserts**

- sterilisable dynamometric torque wrench
- every insert is supplied with its own torque wrench



→ SET MAINTENANCE



→ SET SCALING



→ INSERT SETS

Product	Ref. no.
set maintenance equipped with inserts S1, S2, S5, P2, P10 and 5 torque wrenches K10 description of the single inserts can be found on page 64, 66 and 67	02160035-001
set scaling S1, S2, S3, S4, S5 and 5 torque wrenches K10 description of the single inserts can be found on page 64	02160001-001

INSERT SETS

Product

set perio maintenance

equipped with inserts
P10, P11, P12, P13, P14 and
5 torque wrenches K10

description of the single inserts
can be found on page 67

set perio treatment

equipped with inserts
S1-S, P2, P15, P16R, P16L and
5 torque wrenches K10

description of the single inserts
can be found on page 64, 66 and 67

Ref. no.

02160006-001

02160036-001

→ SET PERIO MAINTENANCE



→ SET PERIO TREATMENT



→ SET IMPLANT CLEANING



→ SET ENDO



→ INSERT SETS

Product	Ref. no.
implant cleaning set S equipped with inserts 1 insert ICS 1 torque wrench K10 5 Implant cleaning tips IC1 description of the single inserts can be found on page 68	02160033-001

set endo equipped with inserts E1 (file holder 120°) E2 (file holder 90°) 6 NiTi-files ISO 15, 27 mm, 6 NiTi-files ISO 20, 27 mm 6 NiTi-files ISO 25, 27 mm, 6 NiTi-files ISO 15, 31 mm 6 NiTi-files ISO 20, 31 mm, 6 NiTi-files ISO 25, 31 mm 1 wrench K1 1 wrench for endo files description of the single inserts can be found on page 69	02980020
---	----------

INSERT SETS

Product

set endo revision

equipped with inserts
ER1, ER2, ER3, ER4, ER5 and
5 torque wrenches K10

description of the single inserts
can be found on page 70

set endo retro

equipped with inserts
R1, R2, R3, R4, R5 and
5 torque wrenches K10

description of the single inserts
can be found on page 71

Ref. no.

02160008-001

02160004-001

SET ENDO REVISION



SET ENDO RETRO





→ every insert
is supplied with its
own torque wrench

SCALING INSERTS

Product	Ref. no.
insert S1 universal curette with semicircular diameter for considerable tartar removal	02960001-001
insert S1-S slim universal curette with triangled slightly curved surface for removal of supragingival tartar, subgingival concrements and biofilm	02960009-001
insert S2 universal curette with triangled, slightly curved surface, efficient in the interdental spaces and posterior surfaces	02960002-001
insert S3 flat, with rounded edges for considerable supragingival tartar removal	02960003-001
insert S4 universal curette with 45° angled, triangled and slightly curved surface for tartar removal on mesial and distal interdental surfaces in the posterior area	02960004-001
insert S5 similar shape to S1 insert but longer and thinner for gentle supra- and subgingival tartar removal and for gingivitis	02960005-001

INSERTS

For a wide range of applications

SCALING



→ SCALING HIGH EFFICIENCY



→ every insert is supplied with its own torque wrench

→ SCALING HIGH EFFICIENCY INSERTS

Product	Ref. no.
insert S6 contra-angled universal curette with semicircular diameter, powerful insert (twice the power of S1 insert) for considerable tartar removal	02960006-001
insert S7 contra-angled universal curette with triangled, slightly curved surface, powerful insert (twice the power of S2 insert) efficient in the interdental spaces and posterior surfaces	02960007-001
insert S8 contra-angled, flat working surface with round edges, powerful insert (twice the power of S3 insert) for considerable supragingival tartar removal	02960008-001



→ every insert
is supplied with
its own torque wrench

→ PERIO UNIVERSAL INSERTS

Product	Ref. no.
insert P1 long, straight working tip with a circular surface	02970001-001
insert P2 curved working tip with a circular surface	02970002-001
insert P3 slim insert smooth like a probe	02970003-001
insert P4 extra long, straight working tip with a circular surface	02970004-001

→ PERIO UNIVERSAL



→ PERIO ANATOMIC



→ every insert is supplied with its own torque wrench

→ PERIO ANATOMIC INSERTS

Product	Ref. no.
insert P10 extra long, curved working tip with a circular surface	03080001-001
insert P11 right (inclination of 15°) curved insert with round tip	03080002-001
insert P12 left (inclination of 15°) curved insert with round tip	03080003-001
insert P13 right (inclination of 15°) curved insert with spherical (Ø = 0.8 mm) round tip	03080004-001
insert P14 left (inclination of 15°) curved insert with spherical (Ø = 0.8 mm) round tip	03080005-001
insert P15 universal curette shape with round surface	03080006-001
insert P16R right angled periodontal curette	03080007-001
insert P16L left angled periodontal curette	03080008-001

→ IMPLANT CLEANING



→ every insert
is supplied with
its own torque wrench

→ IMPLANT CLEANING INSERTS

Product	Ref. no.
Implant cleaning set S (consists of a tipholder ICS and 5 tips IC1)	02160033-001
tipholder ICS	03570004-001
tip IC1 (5 pieces) efficient and soft cleaning of implants and restorations	02900112



→ implant cleaning
tip IC1 can be
easily tightened
without any special
tools and is fully
autoclavable

ENDO

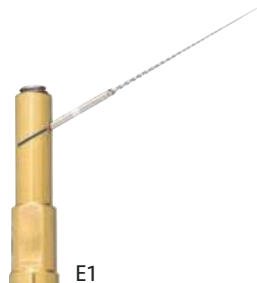

E1

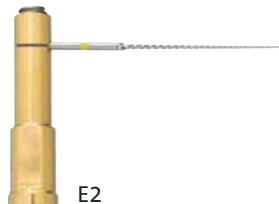

E2



ISO 15



ISO 20



ISO 25

length 27 mm



ISO 15



ISO 20



ISO 25

length 31 mm



→ every insert
is supplied with its
own torque wrench

ENDO INSERTS

Product	Ref. no.
insert E1	02350001-001
120° file holder for endo files and inserts with a shaft of 0,8 mm	
insert E2	02350002-001
90° file holder for endo files and inserts with a shaft of 0,8 mm	

NITI-FILES

highly flexible NiTi-files for mectron file holders,
two lengths, packages of 12 pieces

12 x endo file, ISO 15, 31 mm	02730001
12 x endo file, ISO 20, 31 mm	02730002
12 x endo file, ISO 25, 31 mm	02730003
12 x endo file, ISO 15, 27 mm	02740001
12 x endo file, ISO 20, 27 mm	02740002
12 x endo file, ISO 25, 27 mm	02740003

SPARE PARTS

key K1 for file holders E1 and E2	02270003
key for screw of file holders E1 and E2	02270004
screw for file holder E1	01260005
screw for file holder E2	01260003



→ every insert
is supplied with its
own torque wrench

→ ENDO REVISION INSERTS

Product	Ref. no.
insert ER1 angled shaft with small, spherical (\varnothing 1.7 mm) and D30 diamond coated tip	03450001-001
insert ER2 angled insert with 0.7 mm \varnothing , working length up to 10 mm, the last 5 mm D30 diamond coated	03450002-001
insert ER3 angled insert with 0.6 mm \varnothing , working length up to 10 mm, the last 5 mm D30 diamond coated	03450003-001
insert ER4 angled insert with 0.6 mm \varnothing , working length up to 20 mm, the last 5 mm D30 diamond coated	03450004-001
insert ER5 angled insert with 0.5 mm \varnothing , working length up to 24 mm	03450005-001

→ ENDO REVISION

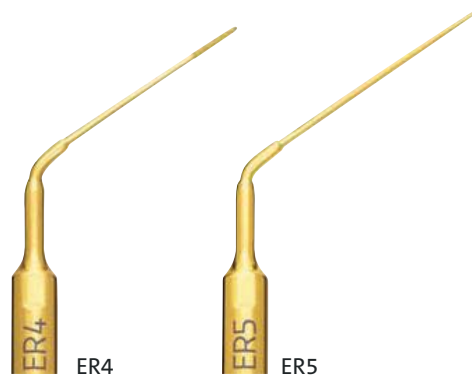

→ ENDO RETRO

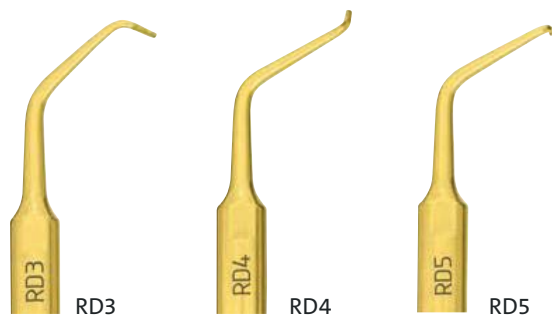
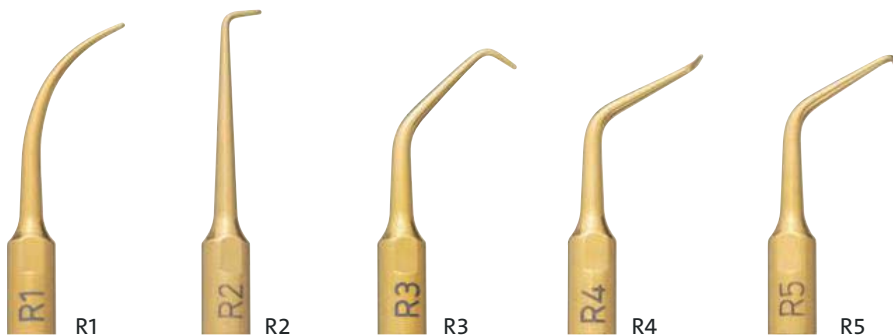

→ every insert
is supplied with its
own torque wrench

→ ENDO RETRO INSERTS

Product	Ref. no.
insert R1 curved insert with a conical round working tip	03050001-001
insert R2 long, straight insert with 90° angled working tip	03050002-001
insert R3 angled shaft, with 90° angled working tip	03050003-001
insert R4 angled shaft, with 90° right angled working tip	03050004-001
insert R5 angled shaft, with 90° left angled working tip	03050005-001
insert RD3 angled shaft, with 90° angled working tip and fine diamond coating (D30)	03050006-001
insert RD4 angled shaft, with 90° right angled working tip and fine diamond coating (D30)	03050007-001
insert RD5 angled shaft, with 90° left angled working tip and fine diamond coating (D30)	03050008-001



→ equipped with
K6 torque wrench

→ EXTRACTION INSERTS

Product	Ref. no.
insert ME1*	03130001-001
insert ME2*	03130002-001
insert ME3*	03130003-001

The specially shaped inserts ME1, ME2 and ME3 – with a blade thickness of only 0.35 mm – perfectly fulfill the anatomical demands of non surgical extractions. They offer maximum intra-operative sensitivity, allowing a great preservation of alveolar bone and periodontal tissues. Furthermore, the physiological solution guarantees maximum visibility thanks to the cavitation effect which leads to a temporary hemostasis of blood vessels.

→ EXTRACTION*

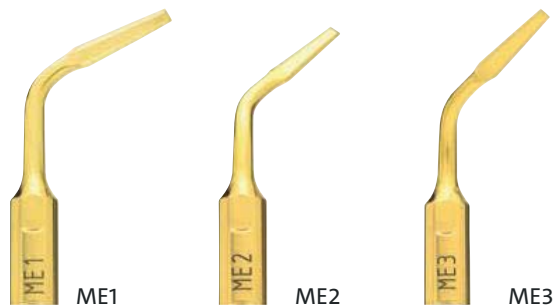

→ **EXCLUSIVE
FOR PULSE
MODE***

* exclusive for units equipped with pulse mode; not available in the United States

→ CAVITY MARGIN

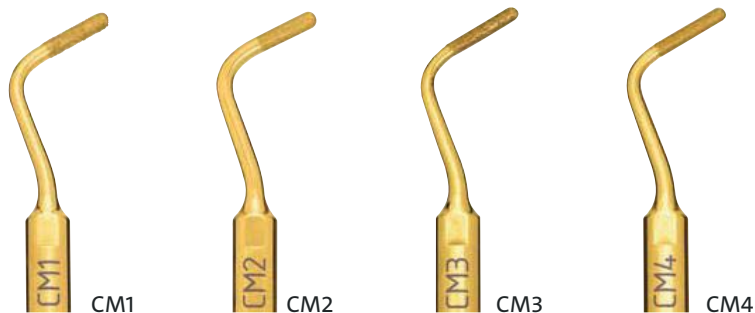

→ RESTORATIVE

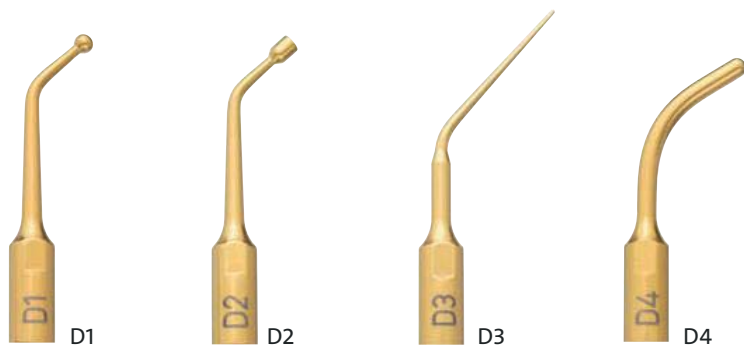

→ every insert
is supplied with its
own torque wrench

→ CAVITY MARGIN INSERTS

Product	Ref. no.
insert CM1	02190003-001
angled shaft with torpedo shaped working tip, Ø 1.8 mm, medium diamond coating (D91)	
insert CM2	02190004-001
angled shaft with torpedo shaped working tip, Ø 1.8 mm, fine diamond coating (D30)	
insert CM3	02190001-001
angled shaft with torpedo shaped working tip, Ø 1.5 mm, medium diamond coating (D91)	
insert CM4	02190002-001
angled shaft with torpedo shaped working tip, Ø 1.5 mm, fine diamond coating (D30)	

→ RESTORATIVE INSERTS

insert D1	02990001-001
– for amalgam condensation in class I, II and V preparations – for gold fillings burnishing	
insert D2	02990002-001
– for amalgam condensation in class I, II and V preparations – for removing of crowns and bridges	
insert D3	02990003-001
for lateral condensation of guttapercha	
insert D4	02990004-001
for crowns, bridges and metal points removal	

→ CROWN PREP TIPHOLDER FOR
ULTRASOUND SCALER HANDPIECES

Product	Ref. no.
crown prep set scaler equipped with DB1, AB1 and K7	02160009
tipholder DB1	03570001

→ CROWN PREP TIPHOLDER ACCESSORIES

key AB1	03580001
dynamometric wrench K7	02900081

→ CROWN PREP TIPS FOR CHAMFER T.

crown prep tip TA12D60	03590001
crown prep tip TA14D60	03590002
crown prep tip TA16D60	03590003
crown prep tip TA12D90	03590004
crown prep tip TA14D90	03590005
crown prep tip TA16D90	03590006
crown prep tip TA14D120	03590007
crown prep tip TA16D120	03590008

→ CROWN PREP TIPS FOR VERTICAL T.

crown prep tip TF12D60	03590010
crown prep tip TF16D60	03590011
crown prep tip TF12D90	03590012
crown prep tip TF16D90	03590013

→ CROWN PREP



key AB1



dynamometric
wrench K7

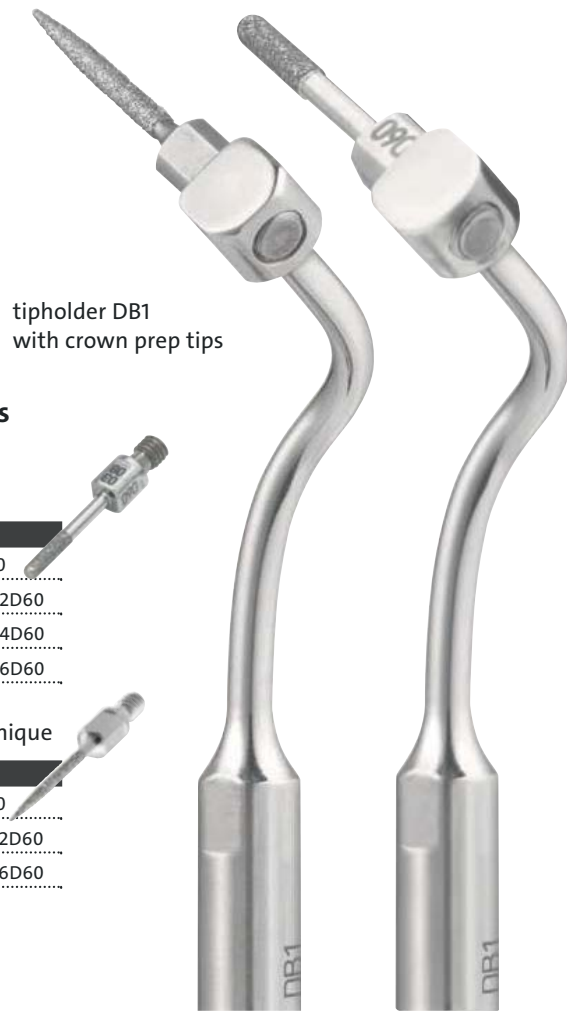

tipholder DB1
with crown prep tips

→ Available lengths and diameters
of crown prep tips

Preparation with chamfer technique

→ Length 10 mm	→ Diamond coating		
diameter	D120	D90	D60
1.2 mm		TA12D90	TA12D60
1.4 mm	TA14D120	TA14D90	TA14D60
1.6 mm	TA16D120	TA16D90	TA16D60

Preparation with vertical preparation technique

→ Length 10 mm	→ Diamond coating		
diameter		D90	D60
1.2 mm		TF12D90	TF12D60
1.6 mm		TF16D90	TF16D60

→ TECHNICAL DATA

sizes (l x w x h in mm): 410 x 260 x 145

weight: 4.8 kg

water supply:

working pressure from 1 to 6 bars

air supply:

input pressure between 4 and 8 bars

ultrasound part:

operating frequency:

24 KHz to 36 KHz

power mode:

"endo", "perio/scaler", "restorative", "SOFT MODE"

power levels from 1 to 5

irrigation:

tap water line – stepless adjustment

peristaltic pump – adjustable on the

touch screen: 7 flow levels from 1

(approx. 5 ml/min) to 7 (approx. 30 ml/min)

possibility to switch off the irrigation in the

power modes "endo", "perio/scaler" and

"restorative" at power levels from 1 to 4

polishing part:

polisher function:

selectable via touch screen: "Prophy" or "Perio"

irrigation:

continuous regulation via knob,

water heated via heating element.

warranty:

2 years, handpiece 1 year

→ COMBI touch

The evolution of prophylaxis.

→ Flexibility

- ultrasound and air-polishing in one unit
- choice between supra- and subgingival air-polishing
- new slim air-polishing handpieces 120° and PERIO with sterile Subgingival Perio Tip and optional 90°
- ultrasound with two irrigation lines, tap water or independent 500 ml bottle

→ Ergonomics

- glass touch screen, easy to clean
- removable powder containers, refill without switching off the unit

→ SOFT MODE

- maximum comfort for sensitive patients

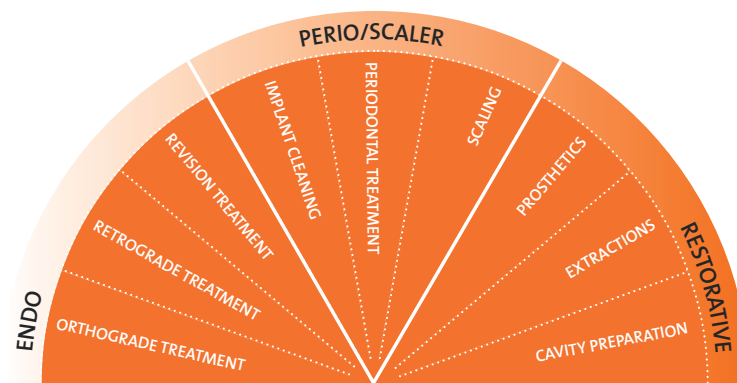

→ widest range of ultrasound indications in the market

SOFT
MODE



AIR-POLISHING

COMBI touch STANDARD

Equipment set

- 1 LED ultrasonic handpiece
- 2 inserts scaling insert S1-S and perio insert P10
- 1 bottle (500ml)
- 1 grey safety bottle cap
- 1 spray head 90°
- 1 spray head 120°
- 1 bottle prophylaxis powder smooth (250g)
- 1 bottle prophylaxis powder sensitive - glycine powder (160g)

Ref. no. 05020015

COMBI touch PERIO

Equipment set

- 1 LED ultrasonic handpiece
- 2 inserts scaling insert S1-S and perio insert P10
- 1 bottle (500ml)
- 1 grey safety bottle cap
- 1 spray head 90°
- 1 spray head 120°
- 1 spray head PERIO
- 1 pack subgingival perio tips (40 pcs)
- 1 wrench k9
- 1 bottle prophylaxis powder smooth (250g)
- 1 bottle prophylaxis powder sensitive - glycine powder bottle (160g)

Ref. no. 05020015

COMBI touch CONFIGURATIONS





available within summer 2021

→ COMBI *touch* STANDARD

Equipment set

- 1 LED ultrasonic handpiece slim
- 2 inserts scaling insert S1-S and perio insert P10
- 1 bottle (500ml)
- 1 grey safety bottle cap
- 1 air-polishing handpiece 90°
- 1 air-polishing handpiece 120°
- 1 bottle of prophylaxis powder smooth (250g)
- 1 bottle of prophylaxis powder sensitive - glycine powder (160g)

Ref. no. 05020015

→ COMBI *touch* PERIO

Equipment set

- 1 LED ultrasonic handpiece slim
- 2 inserts scaling insert S1-S and perio insert P10
- 1 bottle (500ml)
- 1 grey safety bottle cap
- 1 air-polishing handpiece 90°
- 1 air-polishing handpiece 120°
- 1 air-polishing handpiece PERIO
- 1 pack subgingival perio tips (40 pcs)
- 1 wrench k9
- 1 bottle prophylaxis powder smooth (250g)
- 1 bottle prophylaxis powder sensitive - glycine powder (160g)

Ref. no. 05020015

COMBI

The multi-talented prophylaxis unit.

combi offers several treatment options. The powerful ultrasound allows gentle supra- and subgingival scaling and the reliable air-polishing technique provides for both supragingival tooth cleaning and subgingival removal of biofilms.

COMBI

Equipment set

- 1 combi
- 1 ultrasonic handpiece
- 1 basic kit equipped with: scaling inserts S1, S2, S3 and 1 high-efficiency scaling insert S6
- 2 spray heads
- 1 bottle prophylaxis powder intense (250g)
- 1 bottle prophylaxis powder sensitive - glycine powder (160g)
- 1 spare water filter

Ref. no. (230 V version) 05020011





→ TECHNICAL DATA

sizes (l x w x h in mm):

280 x 185 x 100

operating frequency:

24.000 – 29.500 Hz

power supply:

230 VAC, 50/60Hz

water supply:

tap water 1.0 – 6.0 bar

air supply:

4.0 – 8.0 bar

working pressure:

3.5 bar

warranty:

2 years, handpiece 1 year

→ TURBODENT

The stand-alone unit focused specifically on air-polishing.

The underlying technique of **turbodent** is identical with the **combi** unit, it can also be switched easily from supragingival to subgingival treatments.

→ TURBODENT

Equipment set

- 1 turbodent
- 2 spray heads
- 1 bottle prophylaxis powder intense (250g)
- 1 bottle prophylaxis powder sensitive - glycine powder (160g)
- 1 spare water filter

Ref. no. (230 V version)

05010009

→ PERIO
FUNCTION





→ TECHNICAL DATA

sizes (l x w x h in mm):

280 x 185 x 100

power supply:

230 VAC, 50/60Hz

water supply:

tap water 1.0 – 6.0 bar

air supply:

4.0 – 8.0 bar

working pressure:

3.5 bar

warranty:

2 years

STARJET

The new 2 face air-polisher.

STARJET BASIC

Equipment set

- 1 starjet
- 1 spray head 120°
- 1 bottle prophylaxis powder soft (250g)
- 1 bottle prophylaxis powder sensitive - glycine powder (160g)

Product

- starjet basic (BienAir)
- starjet basic (KaVo)
- starjet basic (Sirona)
- starjet basic (W&H)
- starjet basic (Midwest)
- starjet basic (Borden)
- starjet basic (NSK)

Ref. no.

- 05150074-005
- 05150075-005
- 05150076-005
- 05150077-005
- 05150078-005
- 05150079-005
- 05150080-005



One device, two indications – easy switch from supra- to subgingival air-polishing with a PROPHY to PERIO turn.

- maximum flexibility as it can be used with powders with different granulometries
- optimal access thanks to 3 available spray heads – 120°, PERIO and 90° optional
- permanent control of the powder level thanks to the transparent powder chamber
- easy powder filling thanks to lateral opening



→ TECHNICAL DATA

sizes (l x w x h in mm):

200 x 90 x 50

water supply:

0 – 3.0 bar

air supply:

2.0 – 3.0 bar

warranty:

1 year

→ STARJET

Equipment set

1 starjet

1 spray head 120°

1 spray head PERIO;

subgingival perio tips (40 pcs)

1 wrench K9

1 bottle prophylaxis powder soft (250g)

1 bottle prophylaxis powder sensitive - glycine powder (160g)

Product

starjet (BienAir)

starjet (KaVo)

starjet (Sirona)

starjet (W&H)

starjet (Midwest)

starjet (Borden)

starjet (NSK)

Ref. no.

05150074-007

05150075-007

05150076-007

05150077-007

05150078-007

05150079-007

05150080-007



→ MECTRON PROPHYLAXIS POWDERS.

Higher performance for bright results.

→ PROPHYLAXIS POWDER

Product	Ref. no.
Prophylaxis powder intense pack with two bottles (250 g each)	03140002
Prophylaxis powder smooth pack with four bottles (250 g each)	03140010
Prophylaxis powder soft pack with four bottles (250 g each)	03140008
Prophylaxis powder sensitive pack with two bottles (160 g each)	03140007

→ PROPHYLAXIS POWDER INTENSE

effectively
removes supra-
gingival biofilm
and stubborn
extrinsic stains
on the enamel
surface



- Sodium bicarbonate-based
- Average particle size less than 120 µm
- Lemon flavor

→ PROPHYLAXIS POWDER SMOOTH

spherical
particles gently
remove supra-
gingival biofilm
while respecting
the surrounding
tissues



- Calcium carbonate-based
- Average particle size between 45 µm and 75 µm
- Neutral taste

→ PROPHYLAXIS
POWDER SOFT

gently and
effectively
removes
supragingival
biofilm and
stains on the
enamel surface



- Sodium bicarbonate-based
- Average particle size 40 µm
- Mint flavor

→ PROPHYLAXIS
POWDER SENSITIVE

gently removes
supra- and sub-
gingival biofilm



- Glycine-based
- Average particle size 25 µm
- Sweet taste

INDICATIONS	INTENSE	SMOOTH	SOFT	SENSITIVE
Supragingival biofilm removal	●	●	●	●
Removal of stains and pigmentations	●		●	
Subgingival biofilm removal				●
Periodontal pocket detoxification				●
Implant maintenance				●
Peri-implantitis treatment				●
Fixed orthodontic appliances		●	●	●
Preparation for whitening		●		●
Cleaning of prosthesis and restoration materials		●		●
Cleaning of cavity margins before etching	●		●	
Cleaning of fissures before sealing	●		●	
Restoration maintenance		●	●	●

→ SIZES:

total (l x w x h in mm):

480 x 460 x 850 mm

upper tray:

480 x 370 in 770 mm height

middle tray:

420 x 310 in 440 mm height

lower tray:

480 x 370 in 65 mm height

weight:

29 kg

→ UNIVERSAL CART

Let's move the devices!

The **universal cart** – maximum mobility for all your table-top devices. All supply lines are hidden in the easily accessible cable room. The power supply (and the water & air connection – where available) is brought at the tray's height, for an easy connection to your devices.



→ UNIVERSAL CART

Product

Ref. no.

universal cart

03540011

**universal cart with
water & air connections**

03540012



water filter



plastic bottle (scaler) –
combi touch



LED ultrasonic handpiece slim



LED ultrasonic handpiece



dynamometric
torque wrench K6



dynamometric
torque wrench K10

SPARE PARTS

COMMON SPARE PARTS COMBI touch

Product

dynamometric torque wrench K10

dynamometric torque wrench K6

dynamometric torque wrench K7

plastic bottle (scaler), 500 ml, without cap

complete bottle cap, blue

complete bottle cap, grey

safety bottle cap, grey

safety bottle cap, blue

subgingival perio tip (40 pieces)

wrench K9

cleaning needle (0.4 x 57 mm)

cleaning needle (0.8 x 57 mm)

O-ring set combi touch

powder chamber PROPHY

powder chamber PERIO

powder chamber cap

water filter

water supply hose

air supply hose

suitcase combi touch

footswitch

Ref. no.

02900137-001

02900074

02900081

03150102

03020081

03020082

01950014

01950015

02900120

02900122

02900123

02900121

03020206

03020194

03020200

03020195

00420004

02900119

02900012

04440019

02900114

SPARE PARTS COMBI *touch* WITH STANDARD HANDPIECES

Product	Ref. no.
LED ultrasonic handpiece	03120224
handpiece LED-cone	03020205
handpiece metal cone	03020171
90° spray head	03340007
120° spray head	03340008
PERIO spray head	03340009
subgingival perio tip (40 pieces)	02900120
wrench K9	02900122
O-ring set combi <i>touch</i>	03020206

SPARE PARTS COMBI *touch* WITH SLIM HANDPIECES

LED ultrasonic handpiece slim	03120238-001
kit light guide metal cone and blue O-ring for LED ultrasonic handpiece slim	02900146-001
air-polishing handpiece 120°	03120240-001
air-polishing handpiece PERIO	03120241-001
air-polishing handpiece 90°	03120239-001
subgingival perio tip (40 pieces)	02900120
wrench K9	02900122

COMMON SPARE PARTS COMBI AND TURBODENT

dynamometric torque wrench K10	02900137-001
torque wrench K6	02900074
cleaning needle	02900003
O-ring for powder chamber cap	00410018
footswitch	02900001
water filter	00420004
O-ring water coupling	00410024

* not disposable



90° spray head



120° spray head



PERIO spray head



air-polishing handpiece 120°



air-polishing handpiece PERIO



air-polishing handpiece 90°



ultrasonic handpiece (blue)



ultrasonic handpiece (grey)



spray head set turbodent p/s



spray head, to easyjet serial no. 080XXXXY



spray head, from easyjet serial no. 080XXXXY

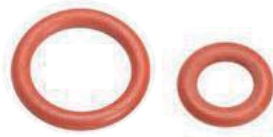

O-ring Set

ADAPTORS FOR THERMODISINFECTION

Product	Ref. no.
DSC Adaptor (for scaler handpiece irrigation line)*	04610007
Spare filter for DSC Adaptor *	04590006
Scaler insert Adaptor *	04610009

SPARE PARTS COMBI, up to serial no. 046XXXXY / TURBODENT, up to serial no. 047XXXXY

ultrasonic handpiece (grey)	03120016
ultrasonic handpiece cord (grey)	02830022
spray head set turbodent p/s	03340003
air polishing handpiece cord (grey)	03120009
O-ring spray head, small	00410013
O-ring spray head, large	00410014

SPARE PARTS COMBI, from serial no. 203XXXXY / TURBODENT, from serial no. 202XXXXY

ultrasonic handpiece (blue)	03120132
ultrasonic handpiece cord (white)	02830042
spray head	03340006
spray head set	03020121
(spray head, silicon protector, long cleaning needle and short cleaning needle)	
air polishing handpiece cord	03120133
silicon protector	03150033

SPARE PARTS STARJET

90° spray head	03340015
120° spray head	03340014
PERIO spray head	03340013
subgingival perio tip (40 pieces)	02900120

SPARE PARTS STARJET

Product	Ref. no.
wrench K9	02900122
O-ring set starjet (2 black + blue)	02900134-001
set powder chamber cap + 1 O-ring blue	02900133-001
cleaning kit starjet	02900136-001
(cleaning needle spray head, cleaning needle starjet body, cleaning brush)	

COMMON SPARE PARTS EASYJET PRO

cleaning needle (long)	02900050
silicon protector for spray head	03150033
O-ring Borden turbine adapter	01970005
O-ring Midwest turbine adapter	01970013

SPARE PARTS EASYJET PRO, up to serial no. 080XXXXXX

spray head set easyjet pro	03020061
(spray head, silicon protector, cleaning needle, small and large O-ring)	
O-ring set easyjet pro	02900051
(1x small and 1x large O-ring for the spray head, 1x O-ring for the powder chamber cap)	
powder chamber cap, transparent	03020059
powder chamber cap, blue	03020060

SPARE PARTS EASYJET PRO (from serial no. 201XXXXXX) AND EASYJET PERIO

spray head	03340006
spray head set	03020121
(spray head, silicon protector, long cleaning needle and short cleaning needle)	
powder chamber cap, blue	03020123
easyjet O-ring set	02900087
(1 small and 1 large O-ring for the spray head, 1 O-ring for the powder chamber cap)	



PERIO spray head



120° spray head



90° spray head



powder chamber cap

...→ OZOACTIVE

The Ozone's benefits for Dentistry.

The **OzoActive** device is specially designed to generate ozonated water at a concentration range that is very safe for both patients and operators.

- minimize the risk of aerosol for a safer clinical practice during the daily activity
- Ozone gas has a high oxidation potential when used as an antimicrobial agent against bacteria and viruses
- effective and faster sterilization and healing of the surgical site
- postoperative pain reduction thanks to its anti-inflammatory action
- perio pockets cleansing and disinfection and periimplantitis management
- hygiene treatment of fixed and mobile prosthesis and orthodontic patients

...→ OZOACTIVE

Equipment set

- 1 device body
- 1 multivoltage power adapter
- 1 footswitch
- Instructions for use
- 1 setting sheet
- 3 disposable irrigation set for PIEZOSURGERY®
- 1 irrigation set for prophylaxis ultrasound units
- 1 pump cover for prophylaxis ultrasound units

Ref. no. 05270001





OzoActive generates ozone gas for distribution into the irrigation lines of mectron PIEZOSURGERY® and ultrasound units.



→ TECHNICAL DATA

sizes (l x w x h in mm):

150 x 140 x 150

weight:

1.6 kg

power types:

2 programs: Oral Surgery and Prophylaxis

liquid and ozone quantity:

adjustable from 0.011 mg to 0.079 mg/liter

synchronized use: level 3 on PIEZOSURGERY®

corresponds to level 3 on OzoActive

power supply:

100-240 V~ 50/60 Hz

max. power consumption:

36 W

warranty:

2 years

→ OZOACTIVE ACCESSORIES

Product	Ref. no.
Aquolab OzoActive - Prophylaxis Irrigation Kit - reusable (1 pc.)	02900157
PIEZOSURGERY® Irrigation Kit - disposable (1 pack of 30 pcs.)	03230018
Aquolab OzoActive footpedal	02900156

STARLIGHT UNO

Colorful and even easiest handling

LED curing light available in 6 different colours.
One touch handling, outstanding curing performance, exchangeable battery ... persuasive features, persuasive price!

STARLIGHT UNO

1 handpiece, 1 charging station

Color

- white
- grey
- turquoise
- yellow
- light blue
- violet

Ref. no.

- 05100092
- 05100093
- 05100094
- 05100095
- 05100096
- 05100097





→ TECHNICAL DATA

sizes (l x Ø in mm):

190 x 21

weight:

77 g

light source:

high power LED

wavelength:

dominant wavelength 440 – 465 nm

light intensity:

> 1.500 mW/cm²

average life span LED:

1.800.000 cycles of 20 sec

battery:

rechargeable Lithium-ion battery
(no memory-effect)

capacity of the accumulator:

240 cycles of 10 sec

charging time:

4 hours (240 min)

warranty:

3 years, battery excluded



STARLIGHT PRO

Lightweight, powerful, versatile



STARLIGHT PRO

1 handpiece, 1 charging station

Color

- white, shiny
- yellow, shiny
- silver
- black, matt
carbon fiber look

Ref. no.

05100083

05100085

05100087

05100086



The lithium-ion battery of the cordless **starlight pro** provides 320 working cycles of 10 seconds – after only 120 minutes of charging. The power of more than 1.400 mW/cm² hardens a 2-mm thick layer in only 10 seconds. All this with only 105 g.



→ TECHNICAL DATA

sizes (l x Ø in mm):

198 x 23

weight:

105 g

light source:

high power LED

wavelength:

dominant wavelength 440 – 465 nm

optical fiber:

Ø 8 mm black, click-clack-connection, sterilisable at 135° C

light intensity:

Ø 8 mm optical fiber, black > 1.400 mW/cm²

average life span LED:

1.800.000 cycles of 20 sec

accumulator:

lithium-ion-accumulator (no memory-effect)

capacity of the accumulator:

320 cycles of 10 sec

charging time:

about 120 min

warranty:

3 years (light guide and battery excluded)



→ TECHNICAL DATA

sizes (l x Ø in mm):

141 x 23

weight:

102 g

wavelength:

440 – 465 nm

optical fiber:

Ø 8 mm, sterilisable at 135° C

light intensity:

Ø 8 mm optical fiber > 1.400 mW/cm²

average life span LED:

1.800.000 cycles of 10 sec

warranty:

3 years (light guide excluded)

→ STARLIGHT S+

Product

starlight s+*

Ref. no.

05100098

→ STARLIGHT S+

flexibility integrated - 3 operating modes
easy handling

starlight s+ can be easily built into your dental unit and is simply placed in the handpiece holder – exactly where you need it.



STARLIGHT S

Built-in kit – the integrated solution

The alternative for dental units. Easily integrated and simply handled.

TECHNICAL DATA

sizes (l x Ø in mm):

148 x 25

weight

65 g

wavelength:

440 – 465 nm

optical fiber:

Ø 8 mm, click-clack-connection,
sterilizable at 135° C

light intensity:

Ø 8 mm optical fiber > 1.400 mW/cm²

average life span LED:

1.800.000 cycles of 20 sec

warranty:

3 years (light guide excluded)

STARLIGHT S

Product

starlight s

Ref. no.

05100003

STARLIGHT ORTHO

Designed for the special needs
of orthodontists

- cures all current materials used in orthodontics efficiently and fast
- exposure times of 5 sec and 10 seconds
- allows curing of a few brackets up to a whole quadrant, with the push of one button



STARLIGHT ORTHO

1 handpiece, 1 charging station

Product

starlight ortho

Ref. no.

05100084

SPARE PARTS

SPARE PARTS STARLIGHT UNO

Product	Ref. no.
battery starlight uno	03020222
protective sleeves (500 pieces)	03230015
optical protection (package with 2 pieces)	02900130

COMMON SPARE PARTS STARLIGHT PRO, S, P AND SLER AND BLUELIGHT

optical protection, sterilizable Ø 8 mm (package of 2 pcs.)	02900018
optical protection, sterilizable Ø 4.5 mm (package of 2 pcs.)	02900019

SPARE PARTS STARLIGHT PRO AND ORTHO with metal click-clack connection of the optical fiber

black optical fiber with metal click-clack connection Ø 8 mm	02900086
--	----------

SPARE PARTS STARLIGHT PRO, S AND P

transparent optical fiber Ø 8 mm	02750009
black optical fiber Ø 8 mm	02750012
transparent optical fiber Ø 4.5 mm	02750013
starlight sx5 cord	02830029

SPARE PARTS STARLIGHT SLER®

transparent optical fiber with metal click-clack connection Ø 8 mm	02900085
black optical fiber with metal click-clack connection Ø 8mm	02900086



optical protection, 8mm



black optical fiber with metal click-clack connection Ø 8 mm



transparent optical fiber Ø 8 mm



black optical fiber Ø 8 mm



transparent optical fiber Ø 4,5 mm



APPROPRIATE SETTINGS

INSERT	PIEZOSURGERY® <i>touch</i>	PIEZOSURGERY® 3	
	PIEZOSURGERY® <i>white</i>	MODE	POWER

IMPLANT PREP

IM1S	special*	BONE	SPECIAL
IM1 AL	implant	IMPL	IMPLANT
IM1 SP	implant	IMPL	IMPLANT
IM2A	implant	IMPL	IMPLANT
IM2A-15	implant	IMPL	IMPLANT
IM2P	implant	IMPL	IMPLANT
IM2P-15	implant	IMPL	IMPLANT
IM2.8A	implant	IMPL	IMPLANT
IM2.8P	implant	IMPL	IMPLANT
IM3A	implant	IMPL	IMPLANT
IM3A -15	implant	IMPL	IMPLANT
IM3P	implant	IMPL	IMPLANT
IM3P-15	implant	IMPL	IMPLANT
IM3.4A	implant	IMPL	IMPLANT
IM3.4P	implant	IMPL	IMPLANT
IM4A	implant	IMPL	IMPLANT
IM4P	implant	IMPL	IMPLANT
P2-3	implant	IMPL	IMPLANT
P3-4	implant	IMPL	IMPLANT

OSTEOTOMY

OT1	cortical/cancellous	BONE	CORTICAL/SPONGIOUS
OT1A	cortical/cancellous	BONE	CORTICAL/SPONGIOUS
OT2	cortical/cancellous	BONE	CORTICAL/SPONGIOUS
OT3	cortical/cancellous	BONE	CORTICAL/SPONGIOUS
OT4	cortical/cancellous	BONE	CORTICAL/SPONGIOUS
OT5	cortical/cancellous	BONE	CORTICAL/SPONGIOUS
OT5A	cortical/cancellous	BONE	CORTICAL/SPONGIOUS
OT5B	cortical/cancellous	BONE	CORTICAL/SPONGIOUS
OT6	cortical/cancellous	BONE	CORTICAL/SPONGIOUS
OT7	cortical/cancellous	BONE	CORTICAL/SPONGIOUS

INSERT	PIEZOSURGERY® <i>touch</i>	PIEZOSURGERY® 3	
	PIEZOSURGERY® <i>white</i>	MODE	POWER

OSTEOTOMY

OT7A	cortical/cancellous	BONE	CORTICAL/SPONGIOUS
OT7S-3	special*	BONE	SPECIAL*
OT7S-4	special*	BONE	SPECIAL*
OT7-20	cortical/cancellous	BONE	CORTICAL/SPONGIOUS
OT8L	cortical/cancellous	BONE	CORTICAL/SPONGIOUS
OT8R	cortical/cancellous	BONE	CORTICAL/SPONGIOUS
OT9	cortical/cancellous	BONE	CORTICAL/SPONGIOUS
OT11	cortical/cancellous	BONE	CORTICAL/SPONGIOUS
OT12	cortical/cancellous	BONE	CORTICAL/SPONGIOUS
OT12S	special*	BONE	SPECIAL*
OT13	cortical/cancellous	BONE	CORTICAL/SPONGIOUS
OT14	cortical/cancellous	BONE	CORTICAL/SPONGIOUS
SLO-H	cortical/cancellous	BONE	CORTICAL/SPONGIOUS
PL1	cortical/cancellous	BONE	CORTICAL/SPONGIOUS
PL2	cortical/cancellous	BONE	CORTICAL/SPONGIOUS
PL3	cortical/cancellous	BONE	CORTICAL/SPONGIOUS

OSTEOPLASTY





OP1	cortical/cancellous	BONE	CORTICAL/SPONGIOUS
OP2	cortical/cancellous	BONE	CORTICAL/SPONGIOUS
OP3	cortical/cancellous	BONE	CORTICAL/SPONGIOUS
OP3A	cortical/cancellous	BONE	CORTICAL/SPONGIOUS
OP4	cortical/cancellous	BONE	CORTICAL/SPONGIOUS
OP5	perio	ROOT	PERIO
OP5A	perio	ROOT	PERIO
OP6	perio	ROOT	PERIO
OP6A	perio	ROOT	PERIO
OP7	cortical/cancellous	BONE	CORTICAL/SPONGIOUS
OP8	special/perio	ROOT	PERIO
OP9	cortical/cancellous	BONE	CORTICAL/SPONGIOUS
SLC	cortical/cancellous	BONE	CORTICAL/SPONGIOUS

FOR PIEZOSURGERY® INSERTS

INSERT	PIEZOSURGERY® <i>touch</i> PIEZOSURGERY® <i>white</i> FUNCTION	PIEZOSURGERY® 3 MODE POWER	
MINI IMPLANT PREP			
MDI 1.9	implant	IMPL	IMPLANT
MDI 2.2	implant	IMPL	IMPLANT
MDI 2.5	implant	IMPL	IMPLANT
SINUS MEMBRANE ELEVATION			
EL1	endo*	ROOT	ENDO*
EL2	endo*	ROOT	ENDO*
EL3	endo*	ROOT	ENDO*
SLS	special*	BONE	SPECIAL*
SLE1	special*	BONE	SPECIAL*
SLE2	special*	BONE	SPECIAL*
PERIOSTEUM PREPARATION			
PR1	cortical/cancellous	BONE	CORTICAL/SPONGIOUS
PR2	cortical/cancellous	BONE	CORTICAL/SPONGIOUS
ENDO RETRO			
EN1	endo*	ROOT	ENDO*
EN2	endo*	ROOT	ENDO*
EN3	endo*	ROOT	ENDO*
EN4	endo*	ROOT	ENDO*
EN5R	endo*	ROOT	ENDO*
EN5L	endo*	ROOT	ENDO*
EN6R	endo*	ROOT	ENDO*
EN6L	endo*	ROOT	ENDO*
EXTRACTION			
EX1	cortical/cancellous	BONE	CORTICAL/SPONGIOUS
EX2	cortical/cancellous	BONE	CORTICAL/SPONGIOUS
EX3	cortical/cancellous	BONE	CORTICAL/SPONGIOUS

INSERT	PIEZOSURGERY® <i>touch</i> PIEZOSURGERY® <i>white</i> FUNCTION	PIEZOSURGERY® 3 MODE POWER	
EXPLANATION			
EXP3-R	special/cancellous/cortical	BONE	SPECIAL/SPONGIOUS/CORTICAL
EXP3-L	special/cancellous/cortical	BONE	SPECIAL/SPONGIOUS/CORTICAL
EXP4-R	special/cancellous/cortical	BONE	SPECIAL/SPONGIOUS/CORTICAL
EXP4-L	special/cancellous/cortical	BONE	SPECIAL/SPONGIOUS/CORTICAL
PERIO			
PP1	perio	ROOT	PERIO
PS1	perio	ROOT	PERIO
PS2	perio	ROOT	PERIO
PS6	perio	ROOT	PERIO
PP10	perio	ROOT	PERIO
PP11	perio	ROOT	PERIO
PP12	perio	ROOT	PERIO
IMPLANT CLEANING			
ICP + IC1	endo/perio	ROOT	ENDO/PERIO
RESTORATIVE			
DB2	special/perio	BONE	SPECIAL
		ROOT	PERIO

→→→ APPROPRIATE SETTINGS

	→→ MULTIPIEZO PRO →→ MULTIPIEZO <i>touch</i> →→ MULTIPIEZO <i>white</i>			→→ COMBI <i>touch</i>			→→ MICROPIEZO	→→ MICROPIEZO		→→ COMBI	
											
function	endo	perio/ scaler	restorative prosthetics	endo	perio/scaler	restorative	power	endo	perio/ scaler	prosthetics	power
SCALING											
S1-S		1-2**			1-2**		1-2		1-2**		1-2
S1, S2, S3, S4, S5, S6, S7, S8		1-3**			1-3**		1-3		1-3**		1-3
PERIO											
P1, P2, P3, P4, P10, P11, P12, P13, P14		1-3**			1-3**		1-3		1-3**		1-2
P15, P16R, P16L		1-2*			1-2*		2		1-2*		2
IMPLANT CLEANING											
ICS		1-2*			1-2*		1-2		1-2*		1-2
ENDO											
E1, E2	1-6			1-5			1-2	1-2			1
ENDO REVISION											
ER1		2-4			1-5		3-6		1-3		2-4
ER2, ER3, ER4, ER5		1-3			1-3		1-3		1-3		1-2

FOR ULTRASOUND INSERTS

	→ MULTIPIEZO PRO → MULTIPIEZO <i>touch</i> → MULTIPIEZO <i>white</i>			→ COMBI <i>touch</i>			→ MICROPIEZO			→ MICROPIEZO			→ COMBI		
function	endo	perio/ scaler	restorative prosthetics	endo	perio/scaler	restorative	power	endo	perio/ scaler	prosthetics	power				

ENDO RETRO

R1, R2, R3, R4, R5, RD3, RD4, RD5	1-3			1-3			1-4			1-3			1-3		
-----------------------------------	-----	--	--	-----	--	--	-----	--	--	-----	--	--	-----	--	--

CROWN PREP

DB1	4-6			4-5			4-6			⊙**			3-4		
-----	-----	--	--	-----	--	--	-----	--	--	-----	--	--	-----	--	--

CAVITY MARGIN

CM1, CM2, CM3, CM4	2-5			1-4			1-5			⊙**			1-3		
--------------------	-----	--	--	-----	--	--	-----	--	--	-----	--	--	-----	--	--

RESTORATIVE

D1, D2, D4 D3	1-6 4			1-4 1-4			4-6 3-5			⊙**			3-4 2-3		
------------------	----------	--	--	------------	--	--	------------	--	--	-----	--	--	------------	--	--

EXTRACTION (only for units with restorative/prosthetics function)

ME1, ME2, ME3***	6			5						⊙**					
------------------	---	--	--	---	--	--	--	--	--	-----	--	--	--	--	--

* it is recommended the use of "SOFT MODE" function

** can be used with or without "SOFT MODE"-function

*** not available in the United States

MECTRON ONLINE EDUCATION

We are happy to share with you our online education platform.





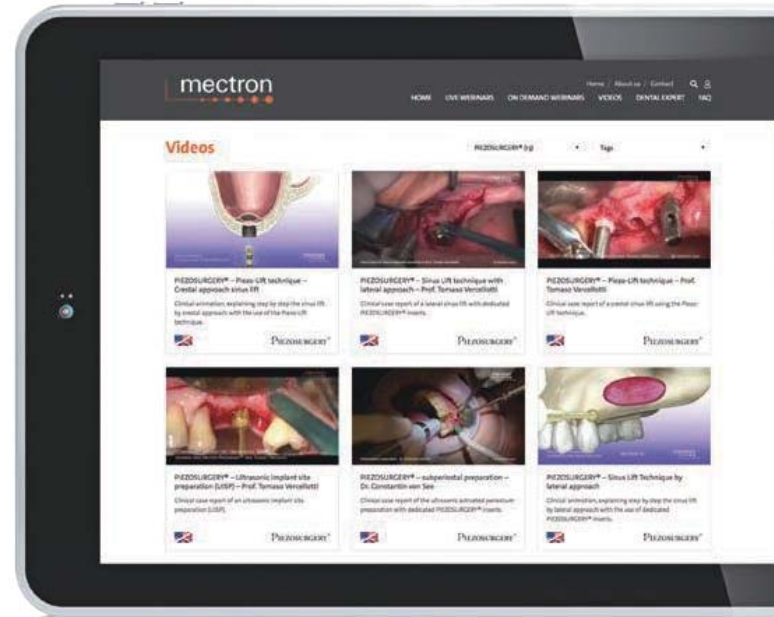

It will allow you to attend free of charge our live and on-demand educational webinars and view our clinical video library.

A fantastic possibility to take a deeper view on clinical opportunities helpful for your daily practice.

Visit our mectron education platform and register to receive notifications about upcoming webinars.





On Demand Webinars

 <p>ON DEMAND WEBINAR</p> <p>Minimally invasive options for implant treatment of reduced bone ridges</p> <p>Speaker: Dr. Claudio Stacci</p> <p>REGISTER NOW</p>	 <p>ON DEMAND WEBINAR</p> <p>New implant shape to simplify narrow ridge treatment</p> <p>Speaker: Prof. Lorenzo Vignallotti</p> <p>REGISTER NOW</p>
 <p>ON DEMAND WEBINAR</p> <p>Evoluzione dei protocolli operativi della terapia parodontale non chirurgica: quali livelli di attenzione?</p> <p>Speaker: Prof. Aggr. Gianna Maria Nardi</p> <p>REGISTER NOW</p> <p>WE PROPHYLAXIS</p>	 <p>ON DEMAND WEBINAR</p> <p>Gain d'articale parodontale. Gain en confiance des patients. Sécurité retrouvée!</p> <p>Speaker: Dr. Maria Sue Buzina</p> <p>REGISTER NOW</p> <p>WE PROPHYLAXIS</p>
 <p>ON DEMAND WEBINAR</p> <p>Opzioni mininvasive per il trattamento implantare delle creste ossee di spessore ridotto</p> <p>Speaker: Dr. Claudio Stacci</p> <p>REGISTER NOW</p>	 <p>ON DEMAND WEBINAR</p> <p>Aplicação clínica da piezocirurgia: benefícios e indicações</p> <p>Speaker: Dr. Robert Canali de Siqueira</p> <p>REGISTER NOW</p> <p>PIEZOSURGERY®</p>



Live Webinars

 <p>LIVE WEBINAR</p> <p>Oral implant management: New technologies and methods</p> <p>Speaker: Dr. Andrea Chiodi</p> <p>REGISTER NOW</p> <p>WE PROPHYLAXIS</p>
 <p>LIVE WEBINAR</p> <p>Praktische Anwendung in der Prophylaxe – up for date</p> <p>Speaker: Susanna Göttsche</p> <p>REGISTER NOW</p> <p>WE PROPHYLAXIS</p>
 <p>LIVE WEBINAR</p> <p>Cerification assisted orthodontics</p> <p>Speaker: Dr. Robert Canali de Siqueira</p> <p>REGISTER NOW</p> <p>PIEZOSURGERY®</p>

Free of charge registration
<https://education.mectron.com/>



DISTRIBUTORS

Please check also our permanently updated distributor list under www.mectron.com.

COUNTRY	DEALER	PHONE	E-MAIL	MECTRON PRODUCTS	PIEZOSURGERY® PRODUCTS
→ ALBANIA	Rodio Pharma	+355 68 2066757	info@rodioharma.al	●	●
→ ALGERIA	Dentina	+213 02 3772515	dentinadental@hotmail.com	●	●
→ ARGENTINA	Biodental – Latinmarket S.A.	+54 11 43825012	jcdescals@biodental.com.ar	●	●
→ AUSTRALIA	BioMeDent Pty Ltd	+61 1300 792624	info@biomedent.com.au	●	●
→ AUSTRIA	mectron Deutschland Vertriebs GmbH	+49 221 492015 0	info@mectron.de	●	●
→ AZERBAIJAN	ADENTAA Dental Supplier	+994 12 5251117	samir.karimov@adentta.az	●	●
→ BELGIUM	Castelbel S.A./N.V.	+32 10 818343	info@castelbel.be	●	●
→ BELGIUM	Dental Promotion & Innovation SA	+32 25 581700	info@dentalpromotion.be	●	●
→ BELGIUM	DENTAL QUALITY SPRL	+591 2 2283927	dentalquality@gmail.com	●	●
→ BOLIVIA	GENTE DENTAL	+32 67 844284	vegadent23@hotmail.com	●	●
→ BOSNIA-HERZEGOVINA	Denta-De D.O.O.	+387 33 210100	dentade@gmail.com	●	●
→ BOSNIA-HERZEGOVINA	Mikodental BH d.o.o.	+381 15 345123	mikodental@gmail.com	●	●
→ BRAZIL	Implantec - Comércio e Assistência Técnica	+55 31 34983326	jarbas@implantecmg.com.br		●
→ BULGARIA	Medical Depot Rik Ood	+359 2 8052500	office@mdrk.bg	●	●
→ CANADA	Piezosurgery® Inc. / Mectron US	+1 614 459 4922	info@piezosurgery.us	●	●
→ CHILE	Berghem	+56 2 2144643	info@berghem.cl	●	●
→ CHINA	Shanghai Tian Ying Medical Instrument Co., Ltd.	+86 21 51060620	sales@tydental.com	●	●
→ COLOMBIA	REPRESENTACIONES A&D LTDA.	+57 9156636	info@ayd.com.co	●	●
→ COSTA RICA	ODONTOWEB PROFESIONAL SA	+506 22 34 31 33	info@odontoweb.com	●	●

COUNTRY	DEALER	PHONE	E-MAIL	MECTRON PRODUCTS	PIEZOSURGERY® PRODUCTS
→ CROATIA	Dental Grupa D.O.O.	+385 52 752106	info@dentalgrupa.hr	●	●
→ CZECH REPUBLIC	mectron.cz s.r.o.	+420 777 761107	info@mectron.cz	●	●
→ DENMARK	Eltident APS	+45 70271747	tina@eltident.com	●	●
→ ECUADOR	PRODENTEC CIA. LTDA.	+593 72831232	ventas@prodentec.com.ec	●	●
→ EGYPT	Vidacare	+20 1110000435	info@vidacare-egypt.com	●	●
→ EGYPT	Zaident for import dental supply	+20 111 222 5076	zaident@link.net	●	●
→ ESTONIA	Prodent OÜ	+372 656 5982	info@prodent.ee	●	●
→ ESTONIA	Retent	+372 7 301 400	retent@retent.ee	●	●
→ FINLAND	Hammasväline Oy	+358 10 588 6011	leila.aalto@hammasvaline.fi	●	
→ FINLAND	Plandent Oy	+358 20 77952210	markku.nappari@plandent.com	●	
→ FINLAND	Implantona Finland OY	+358 9 5306730	olli.kuussaari@implantona.fi		●
→ FRANCE	mectron France	+39 0185 1759069	mectronfrance@mectron.fr	●	●
→ GEORGIA	UNIMEDI LTD	+995 595900344	info@unimedi.ge	●	●
→ GERMANY	mectron Deutschland Vertriebs GmbH	+49 221 492015 0	info@mectron.de	●	●
→ GREECE	medicodent - P. Pretsios s.a	+30 210 5232155	info@medicodent.gr	●	●
→ GUATEMALA	IMFOHSA	+502 2317 2100	info@imfohsa.com	●	●
→ HONG KONG	Denco (HK) Medical Supplies Ltd.	+852 2493 7112	hugo@denco.com.hk	●	●
→ HUNGARY	Dental Unio Kft	+36 96 518047	info@dentalunio.hu	●	
→ HUNGARY	Medi-cont Kft.	+36 96 516360	pharmabog@gmail.com	●	●



DISTRIBUTORS

COUNTRY	DEALER	PHONE	E-MAIL	MECTRON PRODUCTS	PIEZOSURGERY® PRODUCTS
→ HUNGARY	Pharmabog Kft.	+36 30 9488151	pharmabog@t-online.hu	●	
→ HUNGARY	VALID DENTAL-MEDICAL NAGYKERESKEDOHAZ KFT.	+36 1 2100185	dental@valid.hu	●	
→ ICELAND	Dentalvarehuset Spesialistsenter AS	+47 22 333900	thomas@dentalvarehuset.no	●	●
→ INDIA	Mectron Dental India Pvt Ltd.	+91 974 0163433	vincent@mectron.co.in	●	●
→ INDIA	RADION EQUIPMENTS PVT LTD	+91 80 2837 9911	info@radions.in	●	●
→ INDONESIA	PT. Andini Sarana	+62 21 4610515	hadiwira@andini.co.id	●	
→ IRAN	Nik Nam Teb Ayandeh	+98 21 66467007	info@niknamteb.com	●	●
→ IRELAND	General Medical	+44 1380 734990	info@generalmedical.co.uk	●	●
→ ISRAEL	Bicon Isreal	+972 86450479	biconisrael@gmail.com		●
→ ISRAEL	E. Dental Ltd.	+972 36915507	elih@e-dental.co.il	●	
→ ITALY	mectron s.p.a.	+39 0185 35361	mectron@mectron.com	●	●
→ JAPAN	Implatex Co., Ltd	+81 3 58508555	itx@itx.co.jp		●
→ JAPAN	Tokyo Dental Industrial Co. Ltd.	+81 3 38310176	orii@tokyodental.co.jp	●	
→ JORDAN	Ibn Rushd Dental Supplies (IRDS)	+962 655 26162	tareq@irds.jo	●	●
→ KOSOVO	MIKODENTAL d.o.o.	+381 15 345123	mikodental@gmail.com	●	●
→ KUWAIT	Al-Sayafe Medical & Pharmacy Supplies	+965 2245 4924	alsayafe@alsayafemedical.com	●	●
→ LATVIA	Dab Dental Latvia Sia	+371 677 84756	info@dabdental.lv	●	
→ LATVIA	AS "Recipe Plus"	+371 678 1584242	info@recipe.lv	●	
→ LEBANON	Interbio SAL	+961 1 491891	chadi.maroun@interbio.me	●	●
→ LITHUANIA	E.Navicko Medical	+370 41 514164	diana@medica.lt	●	

COUNTRY	DEALER	PHONE	E-MAIL	MECTRON PRODUCTS	PIEZOSURGERY® PRODUCTS
→ LITHUANIA	Jsc Med Grupe	+370 5 2761377	giedre@medgrupe.lt	●	●
→ LITHUANIA	Vilimekso Servisas JSC	+370 5 2796709	info@vilimeksas.lt	●	
→ LUXEMBOURG	T.D.L.s.a.	+352 446881	info@tdlsa.net	●	●
→ MACEDONIA	DENTALSHOP DOEEL	+389 2 2456333	drtasevski@dentalshop.mk	●	●
→ MALAYSIA	Galla Dental Cooperation Sdn Bhd	+603 6259 3800	info@galladental.com		●
→ MALTA	Bart Enterprises Ltd.	+356 21447340	info@bart.com.mt	●	●
→ MEXICO	DENTADEC S.A. DE C.V.	+55 55454520	daniel@dentadec.com		●
→ MOLDOVA	Prodent-Com SRL	+373 22 664922	info@prodent.md	●	●
→ MOLDOVA	VIVODENT SRL CENTRUL STOMATOLOCIC	+373 22 226522	office@vivodent.md	●	●
→ MONTENEGRO	MIKODENTAL d.o.o.	+381 15 345123	mikodental@gmail.com	●	●
→ MOROCCO	Ortho Zenit	+212 5 37 67 45 12	orthozenith@menara.ma	●	●
→ NETHERLANDS	mectron Netherlands	+31 318 529542	info@robouw.nl	●	●
→ NICARAGUA	INDENT S.A.	+505 2223 3517	info@indentsa.com	●	●
→ NORWAY	Dentalvarehuset Spesialistsenter AS	+47 22 333900	thomas@dentalvarehuset.no	●	●
→ NORWAY	Technomedics Norge AS	+47 6988 7920	ek@technomedics.no	●	●
→ OMAN	Majan Medical & Scientific Supplies LLC	+968 96560655	abdullah@majanmedical.com	●	●
→ PAKISTAN	Glow Pak International	+92 42 58460902	info@glowpak.com	●	●
→ POLAND	FM Produkty Dla Stomatologii	+48 12 632 19 27	biuro@fmdental.pl	●	●
→ PORTUGAL	Incotrading S.A.	+34 91 3807490	incotrading@incotrading.net	●	●
→ QATAR	Nagashi Medical & Supplies	+974 40160901	nagashi@nagashimedical.com	●	●



DISTRIBUTORS

COUNTRY	DEALER	PHONE	E-MAIL	MECTRON PRODUCTS	PIEZOSURGERY® PRODUCTS
→ ROMANIA	S.I.T.E.A. Romania Srl	+40 215 280320	fabrizio@sitea.ro	●	●
→ RUSSIA	Anas Ltd	+7 495 626 5455	clients@anas.ru	●	●
→ SAUDIA ARABIA	Cigalah Group	+966 12 6136192	afarrag@cigalah.com.sa	●	●
→ SERBIA	MIKODENTAL Depot	+381 15 345123	mikodental@gmail.com	●	●
→ SINGAPORE	Raydent Supplies (S) Pte Ltd	+65 9665 8987	jeanchng@raydent.com.sg	●	●
→ SLOVAKIA	mectron.cz s.r.o.	+420 777 761107	info@mectron.cz	●	●
→ SLOVENIA	Korum D.O.O.	+386 1 5612533	korum@siol.net	●	●
→ SLOVENIA	Prodent Int. D.O.O.	+386 1 5204800	info@prodent.si	●	●
→ SLOVENIA	SEDENT - Josef Sever S.P.	+386 20508700	dental@sedent.si	●	●
→ SOUTH AFRICA	INTER-AFRICA DENTAL PTY LTD	+27 123428551	veronica@iad.co.za	●	●
→ SOUTH KOREA	MD Safe Co. Ltd.	+82 2 334 2815	jclosa@naver.com	●	●
→ SPAIN	Incotrading S.A.	+34 91 3807490	incotrading@incotrading.net	●	●
→ SRI LANKA	Mectron Dental India Pvt Ltd.	+91 974 0163433	vincent@mectron.co.in	●	●
→ SWEDEN	Dentalmind	+46 346 48800	marcus@dentalmind.com	●	●
→ SWITZERLAND	Bien-Air Dental SA	+41 032 344 64 64	sales-ch@bienair.com	●	●
→ SYRIA	EBDA Engineering & Development	+963 1157 34444	management@ebda-eng.net	●	●
→ TAIWAN	Sudent Corporation	+886 2822 80 861	sudent.co@msa.hinet.net	●	●
→ THAILAND	Udom Medical Equipment Co. Ltd.	+662 322 7124	wisit@udom.co.th	●	●
→ TUNISIA	New Med Plus	+216 31 561 563	newmedplus@gmail.com	●	●
→ TURKEY	Tekmil Tibbi Arac	+90 21 2337837	info@tekmil.com.tr	●	●

COUNTRY	DEALER	PHONE	E-MAIL	MECTRON PRODUCTS	PIEZOSURGERY® PRODUCTS
→ UKRAINE	Galit	+380 352 433807	office@galit.te.ua	●	●
→ UNITED ARAB EMIRATES	Al Thanaya Pharmaceuticals	+971 4 3465001	altpharm@emirates.net.ae	●	●
→ UNITED ARAB EMIRATES	New Al Farwaniya Surgicals & Medical Equipment L.L.C.	+971 26775447	info@alfarwaniya.com	●	●
→ UNITED KINGDOM	General Medical	+44 1380 734990	info@generalmedical.co.uk	●	●
→ USA	Piezosurgery® Inc./Mectron US	+1 614 459 4922	info@piezosurgery.us	●	●
→ VIETNAM	Pacific Dental Supply	+84 8 391121270	customercarehcm@dentalpacific.com.vn	●	●

mectron s.p.a.,
via Loreto 15/A, 16042 Carasco (Ge), Italia,
tel +39 0185 35361, fax +39 0185 351374

→ www.mectron.com or mectron@mectron.com



© Copyright mectron S.p.A., Carasco, Italy
All rights reserved. Texts, pictures and graphics of mectron brochures are protected by copyright and other protection laws. Without written approval of mectron S.p.A. the contents may not be copied, distributed, changed or made available to third parties for commercial purposes.