

# SUPAPURLINS® SUPAZEDS® & SUPACEES®

# LYSAGHT

DESIGN AND INSTALLATION GUIDE  
FOR BUILDING PROFESSIONALS





# Contents

## SECTION 1

### 1.0 Introduction

- 1.1 Preface, Scope & Warranty 5
- 1.2 Purlins: Features, Applications & Benefits 6

## SECTION 2

### 2.0 Product Range

- 2.1 SUPAPURLIN® Product Range 9
- 2.2 Purlin Product Coding 9
- 2.3 Standard Purlin Product Range 9
- 2.4 Non-Standard purlin options 9
- 2.5 Material Specification 10
- 2.6 Holing Of Purlins 10
- 2.7 Accessories 13
- 2.8 HOOK-LOK® II Bridging Members 15
- 2.9 LYSAGHT® Series 300/350 Bridging System 18
- 2.10 Procurement 18
- 2.11 Sample Order Forms 19

## SECTION 3

### 3.0 Assemblies & Installation

- 3.1 Purlin Connections 23
- 3.2 Typical Assemblies With Trimming Brackets 24
- 3.3 Roofing & Walling Assemblies 25
- 3.4 Bridging Assemblies 26
- 3.5 Bridging Installation 27

## SECTION 4

### 4.0 Purlin & Girt Limit State Capacity Tables

- 4.1 Design Notes To Limit State Capacity Tables 30
- 4.2 Index To Limit State Capacity Tables 31
- 4.3 Capacity Tables 32
  - Single Spans 32
  - 2 Span Continuous 42
  - 2 Span Lapped 52
  - 4 Span Lapped 62
- 4.4 Capacity Tables - Other Design Effects 82
  - Design Optimisation 82
  - Stepped Loading 82
  - Point Loads 83
  - Axial Loads 84
  - Specification Statement 84

## SECTION 5

### 5.0 Purlins & Girts - Design Matters

- 5.1 Purlin Orientation 86
- 5.2 SUPAZED® Wide/Narrow Flange Orientation 87
- 5.3 Bridging Design 88
- 5.4 Other Design Matters 93

## SECTION 6

### 6.0 Engineering Data On Purlin & Girt Profiles

- 6.1 Design Principles 97
- 6.2 Traditional Zeds & Cees 98
- 6.3 LYSAGHT SUPAZEDS® & SUPACEES® 99

# SECTION 1

## 1.0 Introduction

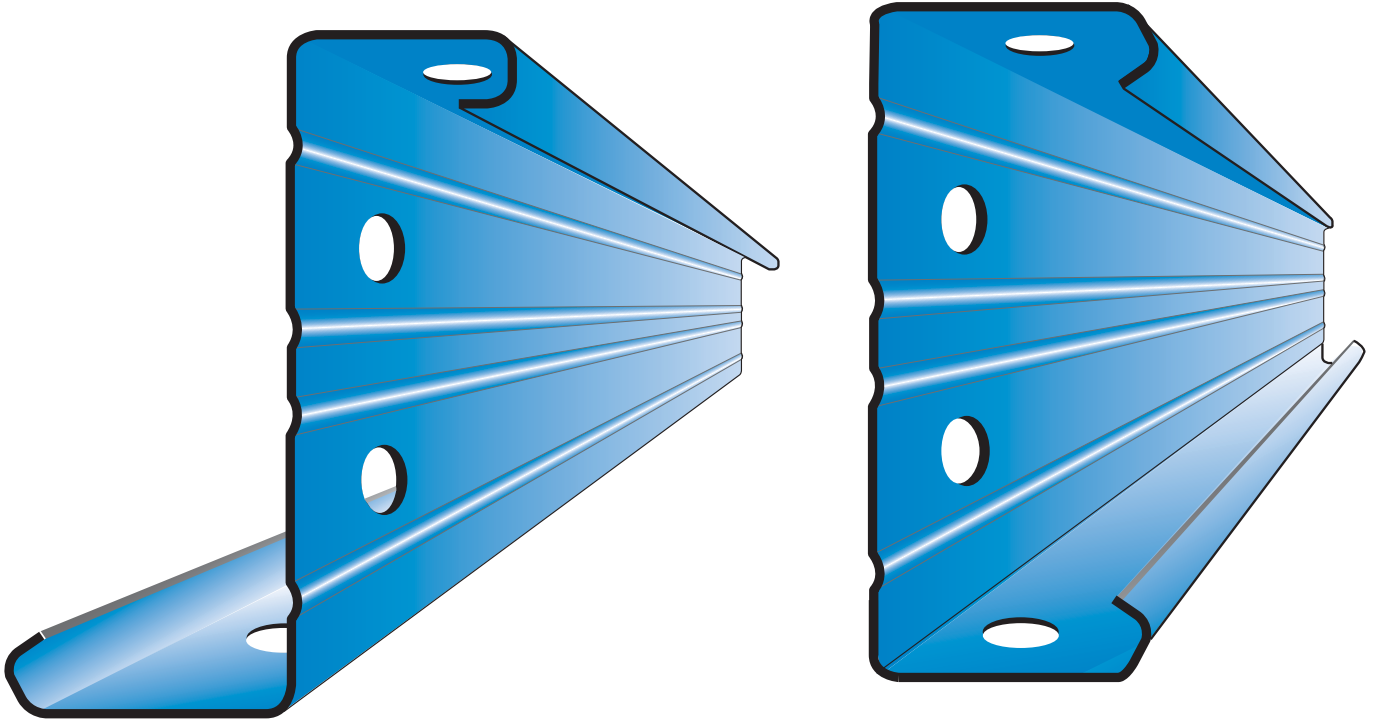

# 1.1 PREFACE, SCOPE & WARRANTY

## PREFACE

Cold-formed steel purlins and girts have been used in Australia for many years. During that time, technology has improved with the design of these sections in accordance with the Australian Standard AS/NZS 4600 Cold-formed steel structures code. However until recently there has been no major step forward in the actual development of the profile from the traditional Zed or Cee.

Since 1987, Lysaght in conjunction with the University of Sydney, has been intensively researching the behaviour of purlin and girt systems utilising the "state of the art" vacuum test rig at the university. The results obtained from this research has been used to develop the design rules for AS/NZS 4600. From this research Lysaght committed itself to further research into performance improvements of the purlin profile. This has lead to the development of the LYSAGHT SUPAZED® and SUPACEE® profile. These profiles released early 2000's are aimed to attain higher capacities without affecting the current industry practices of design detailing and installation.

The SUPAZED® and SUPACEE® profiles are patented and jointly owned by Lysaght and Sydney University.

## SCOPE

This publication has been prepared with a view of providing designers, specifiers, fabricators, builders and erectors the relevant data to enable easy selection, specification and detailing of a roof or wall system using the new SUPAPURLIN® profile range.

The information contained herein includes:

- Product features, applications and benefits
- Product ordering
- Product handling
- Product detailing, installation and assembly
- New format of capacity tables, and an even larger range of configurations.
- More advanced information on design issues including Stepped Loading.
- More detailed information on design, construction and installation issues including profile orientation, bridging, packers, suspended services.
- Product dimensional data and section properties.

The standard range of purlin products available is:

- Traditional Zeds & Cees purlin profiles for 100 deep sections (offer varies by region. Contact your local sales office for product availability).
- SUPAZED® and SUPACEE® purlin profiles for 150, 200, 250, 300 and 350 sections (plus 400 in Queensland and SA only).

These purlin products are available with a wide range of accessories and bridging systems for the full range of purlin profiles.

## WARRANTY

Lysaght has always had the most comprehensive product warranties on the market that cover not only the corrosion performance of the material but also the structural and serviceability performance of a wide range of products. Lysaght can back their products with over 150 years experience and credibility. The Lysaght brand is widely recognised as setting the benchmark on quality products, and is trusted and respected by our customers and competitors nationwide.

This tradition of warranty protection is now available on the new range of LYSAGHT SUPAPURLIN® profiles. This warranty compliments the warranties available for the LYSAGHT® roof and wall cladding profiles that are commonly fixed to the purlins.

Application for a SUPAPURLIN® warranty must be lodged on our 'LYSAGHT SUPAZED® & SUPACEE® Request For Warranty' form, available by contacting the nearest Lysaght Service Centre. The warranty is available subject to application and project size.

Additional warranty periods with additional coating treatments are available subject to enquiry.



## 1.2 PURLINS: FEATURES, APPLICATIONS & BENEFITS

### TERMINOLOGY

In the building industry the terms "purlin" and "girt" apply to the structural member that spans between frames onto which cladding is attached. When the member is used in the roof is called a PURLIN, and when used in the wall it is called a GIRT.

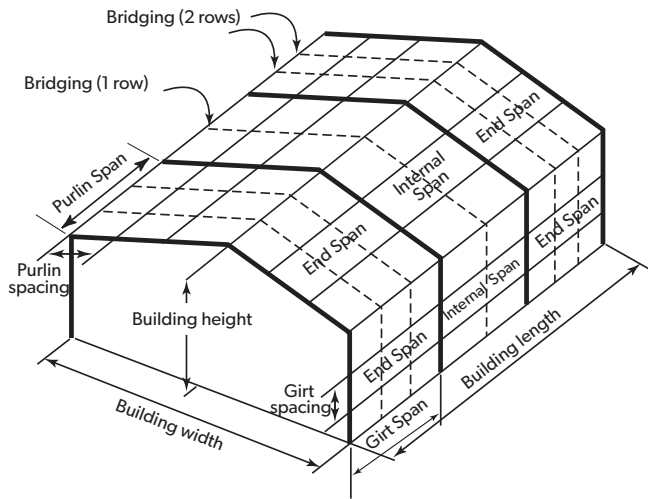

The purlin span horizontally and at right angles to, and spanning across, rafter supports or roof truss supports. The roof cladding is fixed to the outside or top face.

The girt span horizontally and at right angles to, and spanning across, column supports. The cladding is fixed to the outside face. The purlins and girts are traditionally fixed to the fabricated steel frame supports by the use of cleats.

Bridging are stiffening members between the purlins/girts to limit the lateral and rotational movement of the purlins/girts. This movement is a form of buckling, and limitation of this buckling can dramatically increase the load carrying ability.

### APPLICATIONS

LYSAGHT® purlins and girts are commonly used in commercial, industrial and rural buildings, however they are also popular in medium and small structures such as sheds and awnings.

Although the LYSAGHT® purlins and girts sections have been designed for this specific application, due to their versatile shape there is a vast range of other applications where these sections are equally useful and commonly used. Some of these other applications are:

- Structural frame of small and medium sized buildings
- Racking frames
- Wall framing such as stud and plate/track
- Floor joists
- Rafters and beams
- Posts

### TRADITIONAL PURLIN SHAPES

The traditional purlin profiles (shapes) are the traditional Zed and Cee (or channel). These are the most versatile and economic sections to use for purlin and girt applications.

### TRADITIONAL ZED AND CEE SHAPES FEATURES

- Single web
- Top & Bottom flange. The Cee profile has equal flanges. The Zed profile has the flanges facing in opposite direction and one flange is "wide" and one is "narrow" to allow lapping (Cee profiles cannot be lapped).
- Lip stiffeners at the free end, or extremity, of the flange. These lips point back towards the centre of the profile.

#### Cee

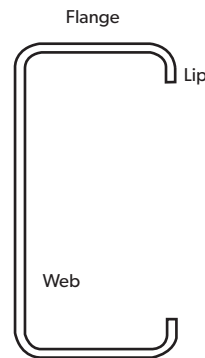

#### Zed

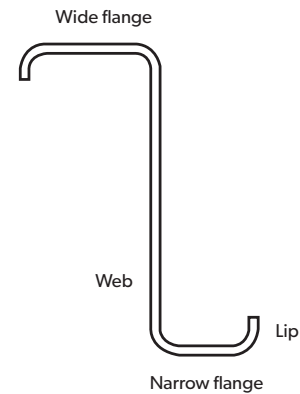

Each of these shapes has benefits that complement each other which satisfy most building needs.

### CEE PROFILE BENEFITS

- The lip stiffener provides significant increased strength compared to no lip stiffener.
- More aesthetic for uses in exposed applications such as carports and awnings. The shape is closed similar to the traditional boxed, tubular or solid shapes.
- Certain detailing is simpler with Cee sections, such as fascia/eaves purlins for gutter installation, edges of roofs, back-to-back or lip-to-lip ("I" or "box") construction.
- Stability during construction is a benefit in some applications such as flooring.

### ZED PROFILE BENEFITS

- The lip stiffener provides significant increased strength compared to no lip stiffener.
- Lapping ability results in greater performance (strength and deflection) and economic design. Continuity and double thickness material at the required location (at support regions) results in greater performance available when used in multi-span configurations. Thus there are considerable economic benefits to be made. Variable thickness can also be designed in each bay to enable even greater economies.
- The nesting ability of Zeds results in considerable reduced volumes. Reduced volume of bundles result in lower transportation costs, lower handling costs and reduced handling times.

## SUPAPURLIN® SHAPES

The SUPAPURLIN® profiles consist of a SUPAZED® and SUPACEE® profile. These SUPAPURLIN® are an advancement of the traditional Zed and Cee profiles. The benefits of the traditional Zed and Cee profiles are retained, however there are substantial added benefits of the new SUPAZED® and SUPACEE® purlin profiles.

The features of the traditional purlins that are the same in the SUPAPURLIN® shapes are:

- Single web.
- Top & Bottom flange. The Cee profile has equal flanges. The Zed profile has the flanges facing in opposite direction and one flange is "wide" and one is "narrow" to allow lapping.
- Lip stiffeners at the free end, or extremity, of the flange. These lips point back towards the centre of the profile.

## ADDITIONAL FEATURES OF THE SUPAPURLIN® SHAPES

- Longitudinal web stiffeners (4 off).
- Lip has an added stiffener at the free end, or extremity, of the lip. These added stiffeners point back towards the centre of the profile.

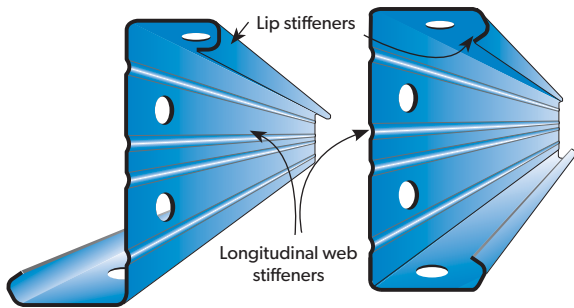

Thus the benefits of the traditional Zeds and Cees are retained and there are a number of added benefits with the SUPAPURLIN® profiles. These added features result in the following added benefits:

- No change to the accepted practices of packaging, marking and handling.
- No change to the accepted traditional practices of installation. The lapping method is unchanged, the cleat fixing is unchanged, the bridging installation is unchanged, the fixing of fly bracing and accessories is unchanged.
- There are added benefits to handling and installation;
- Minimal face-to-face metal contact= minimised staining of surfaces, and no locking of purlins in frozen bundles.
- Purlin nesting results in no wedging/interlocking of purlins in bundles= ease of separation on site.
- Rounded lips= added site safety from handling of sharp edges.
- Rounded corners= added site safety due to ease of sliding of purlins on rafter surfaces, and no damage to surfaces of painted rafters from sliding of purlins during installation.
- Rigidity of purlin= added safety and less labour requirements during the flipping of purlins during installation onto cleats.
- Unique patented profile, which cannot be copied. What is specified is what you get. Thus the design strength is not compromised and the material is guaranteed to be Australian.
- Significant improvement in strength performance can be achieved in many purlin sizes and span configurations. Thus there are considerable further economic benefits to be made.

## OTHER PURLIN SHAPES

Downturned lip purlins are available in Queensland and South Australia only.

There are other steel shapes manufactured by Lysaght that are used for purlins and girts:

- Boxed sections such as LYSAGHT FIRMLOK® Beams. These are commonly used in the Home Improvement Market such as carports and awnings where a more architectural or aesthetic effect is required. Fixing methods are with simple brackets and screw fixing.

Refer to our LYSAGHT FIRMLOK® Beams publication

- "Top hat" type sections such as LYSAGHT TOPSPAN® 120. These are commonly used in applications where the ease of installation is more important than economic profile. These profiles are used where the loads are lighter and spans are shorter. Fixing methods are simple screw fixing and there is no bridging installation.

Refer to our LYSAGHT TOPSPAN® series publications.

## LYSAGHT FIRMLOK® beam

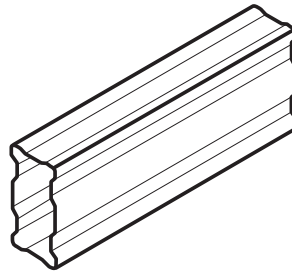

## LYSAGHT TOPSPAN® 120

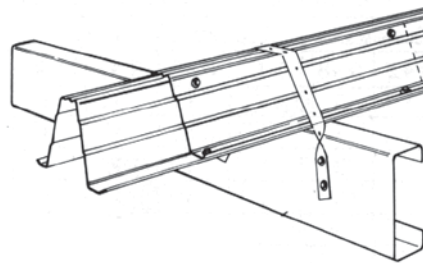

# SECTION 2



## 2.0 Product Range

PURLINS, ACCESSORIES, BRIDGING & PROCUREMENT





## 2.1 SUPAPURLIN® PRODUCT RANGE (NSW, QLD, SA)

Product	Depth (mm)	Thickness (mm)	Bolt Requirements	Purlin Shape and Name	Bridging System					
Z/C10010	102	1.0	M12 Grade 4.6 or 8.8	Traditional Zeds & Cees 	LYSAGHT HOOK-LOK® II Bridging System with Clamp/locator ends or bolted bracket ends					
Z/C10012		1.2								
Z/C10015		1.5								
Z/C10019		1.9								
SZ/SC15010	152	1.0 ▲		M16 Grade 4.6 or 8.8		SUPAZED® 	LYSAGHT® Series 300-350 bridging			
SZ/SC15012		1.2								
SZ/SC15015		1.5								
SZ/SC15019		1.9								
SZ/SC15024		2.4								
SZ/SC20012	203	1.2				M16 Grade 4.6 or 8.8		SUPACEE® 	LYSAGHT® Series 300-350 bridging	
SZ/SC20015		1.5								
SZ/SC20019		1.9								
SZ/SC20024		2.4								
SZ/SC25015	254	1.5	M16 Grade 4.6 or 8.8		LYSAGHT® Series 300-350 bridging					
SZ/SC25019		1.9								
SZ/SC25024		2.4								
SZ/SC30019	300	1.9						M16 Grade 4.6 or 8.8		LYSAGHT® Series 300-350 bridging
SZ/SC30024		2.4								
SZ/SC30030		3.0								
SZ/SC35024*	350	2.4		M16 Grade 4.6 or 8.8			LYSAGHT® Series 300-350 bridging			
SZ/SC35030*		3.0								
SZ/SC40024**	400	2.4								
SZ/SC40030**		3.0								
SZ/SC40032**		3.2								

- Purlins marked \* availability is subject to enquiry. Consult your local Lysaght Service Centre for advice. Extended lead times may apply.
- Purlins marked \*\* are available in QLD and SA only. Consult your local Lysaght Service Centre for advice. Extended lead times may apply.
- Queensland and South Australia are able to manufacture downturned lipped purlins. Available subject to enquiry. Consult your local Lysaght Service Centre for advice. Extended lead times may apply.
- Purlins marked ▲ are subject to enquiry. Consult your local Lysaght Service Centre for advice.

## 2.2 PURLIN PRODUCT CODING

The coding of the purlin products consists of prefix letters followed by a series of numbers.

The prefix letters are for the various purlin shapes and consists of:

- Z for the LYSAGHT® traditional Zed shape
- C for the LYSAGHT® traditional Cee shape
- SZ for the LYSAGHT SUPAZED® shape
- SC for the LYSAGHT SUPACEE® shape

The letter prefix is then followed by a three digit number indicating the section nominal depth in millimetres (not the actual depth). Thus the nominal depths would be 100, 150, 200, 250, 300, 350 or 400.

This is then followed by a two digit number designating section thickness. This would be "10" for 1.0mm BMT, up to "32" for 3.2mm BMT.

For example SZ20012 designates a LYSAGHT SUPAZED® 200 millimetres nominal depth and 1.2 BMT.

Where reference is made to both purlin shapes of the same size then designation such as SZ/SC is used, similarly for other shapes.

## 2.3 STANDARD PURLIN PRODUCT RANGE

The standard range of purlin products and the associated bolts and bridging system to use are detailed above.

## 2.4 NON-STANDARD PURLIN OPTIONS

Non-Standard purlin options are available subject to enquiry. These non-standard options are available on special projects only and will be subject to minimum order quantities and extended lead times.

The non-standard purlin options include:

- variation of material specifications
- variation of profile dimensions
- variation of material thickness

These options could be considered to tailor a profile specifically for project needs.

For special projects please contact your local Lysaght Service Centre and provide all the relevant project details and design information.

## 2.5 MATERIAL SPECIFICATION

LYSAGHT® purlin sections are roll-formed from GALVSPAN® steel complying with AS 1397-2001, in the grades shown. The number prefixed with Z indicates the minimum coating mass in g/m<sup>2</sup>.

BMT (mm)	Grade	Coating Class
1.0	G550	Z350*
1.2	G500	Z350
1.5	G450	Z350
1.9	G450	Z350
2.4	G450	Z350
3.0	G450	Z350
3.2	G450	Z350

\* Coatings for C10010/Z10010 may vary from centre to centre. Contact your local lysaght Service Centre for advice.

## 2.6 HOLING OF PURLINS

### GENERAL

LYSAGHT® purlin profiles can be supplied punched or unpunched.

Where holes are required, these are done to industry standards at cleats supports (where the purlin is bolted through the web to the cleat at end supports and internal supports), at ends of laps and at bridging points.

Non-standard holing may be available subject to enquiry. Negotiation for special projects will be subject to minimum order quantities and extended lead time. This non-standard holing can consist of no holes (un-punched) or some limited variation of:

- Hole size
- Hole location
- Hole quantity
- Hole pattern

### STANDARD HOLE SIZE

The purlin hole sizes are in accordance with the requirements of Australian Standard AS/NZS 4600 Cold Formed Steel Structures.

For the purlin sizes in the nominal range 100 to 250, the holes are elongated with dimensions of 18mm x 22mm suitable for LYSAGHT® M12 Purlin Bolts. The long dimension of 22mm is measured in the direction of the purlin length.

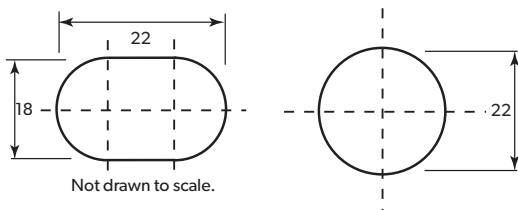

For the larger purlins sizes of nominal depths of 300, 350 and 400, the holes are 22mm diameter suitable for LYSAGHT® M16 Purlin Bolts.

### STANDARD HOLE PATTERNS & LOCATIONS

There are two standard punching patterns available and the locations along the length of the purlin will depend upon the purpose of the holes. The patterns/location of the holes are;

- Two (2) holes in the web located at the gauge lines. This is for fixing of the purlin at cleats and for installation of bridging.
- Two (2) holes in the web located at the gauge lines, and two (2) holes in the flanges (one hole per flange). This is largely for fixing at ends of laps, however this is also the standard hole punching at the ends of all purlins. The minimum edge distance of the holes (add centres) from the ends of purlins is 35mm as shown in diagram at right.

## STANDARD HOLES FOR ZED AND SUPAZED® SECTIONS

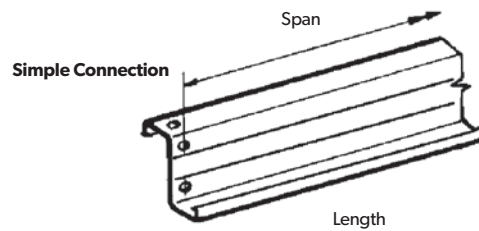
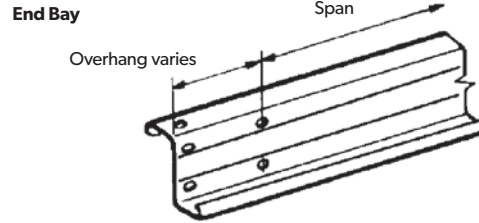
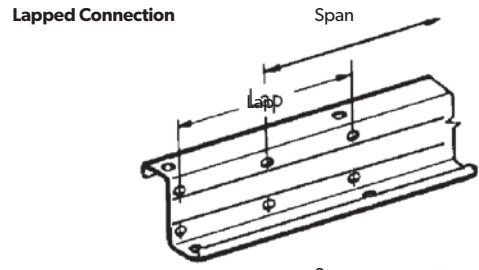

## STANDARD HOLES FOR CEE AND SUPACEE® SECTIONS

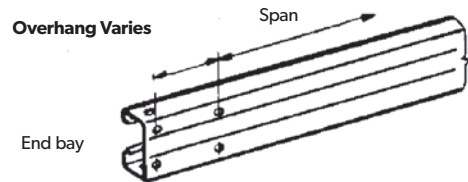
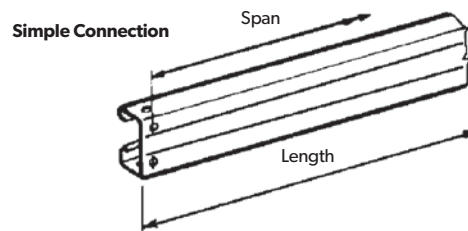

## BRIDGING HOLES AND CLEAT HOLES

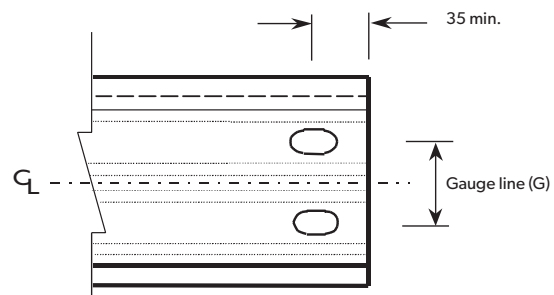
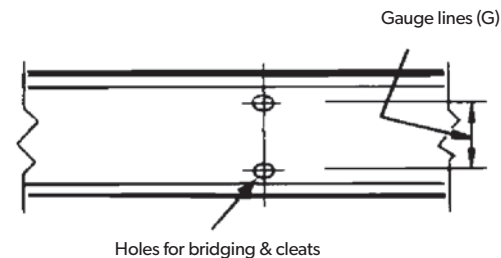

Note: Web stiffeners do not interfere with bolt length, lapped capacities or fitting of laps when SUPAZED® purlins are used on a lapped configuration.

## STANDARD HOLE GAUGE LINES

The holes punched in the webs are located at the accepted industry standard gauge lines. The gauge lines are as detailed below and the holes are equally spaced above and below the centreline of the purlin.

Purlin Nominal Size	Gauge Line (G) mm
Z/C100	40
SZ/SC150	60
SZ/SC200	110
SZ/SC250	160
SZ/SC300	210
SZ/SC350	260
SZ/SC400	310

## SINGLE SPANS

### One row of bridging

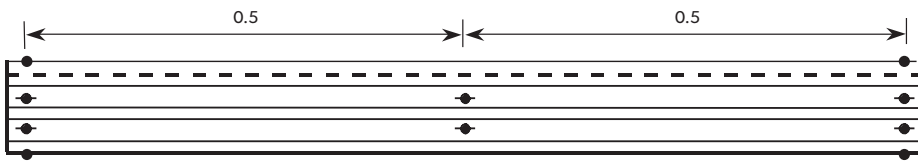

### Two row of bridging

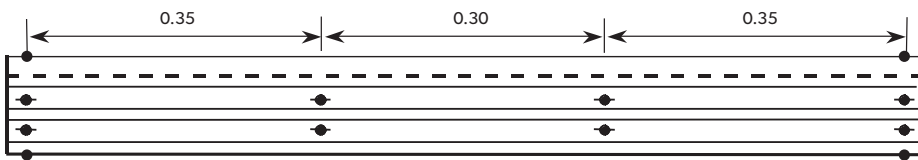

### Three row of bridging

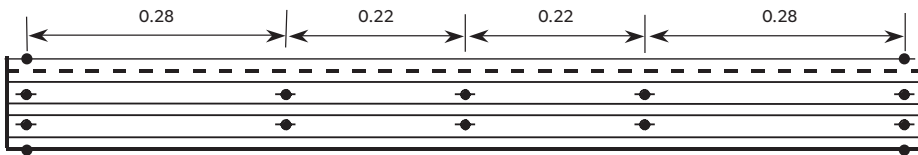

## END SPANS (CONTINUOUS)

### One row of bridging

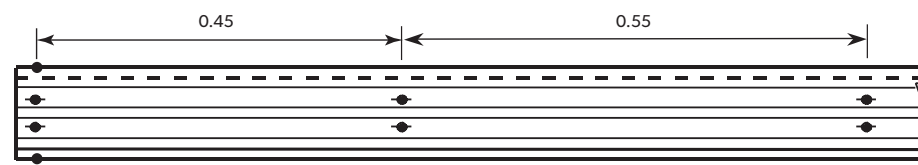

### Two row of bridging

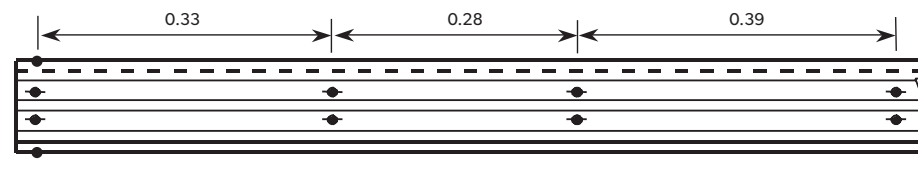

### Three row of bridging

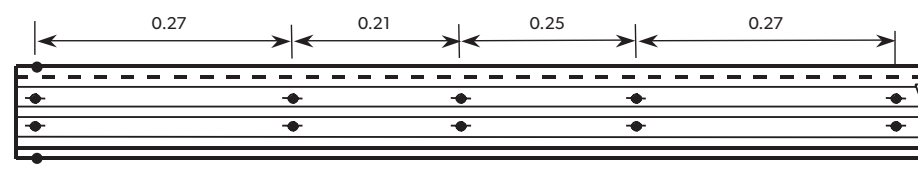

## END SPANS (LAPPED)

### One row of bridging

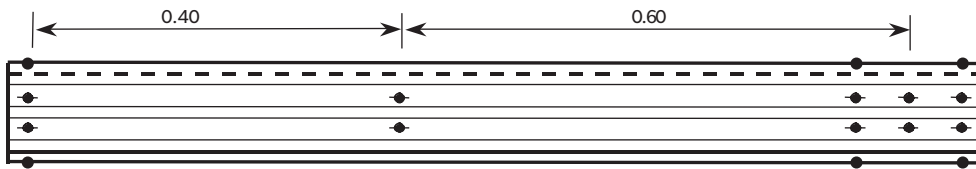

### Two row of bridging

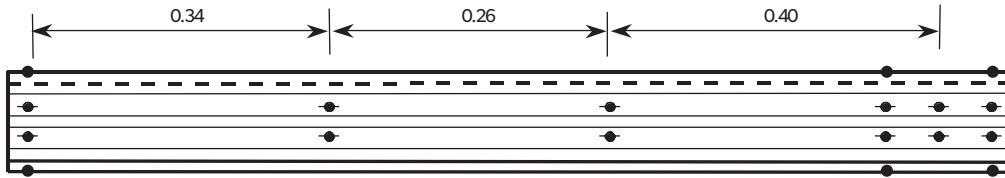

### Three row of bridging

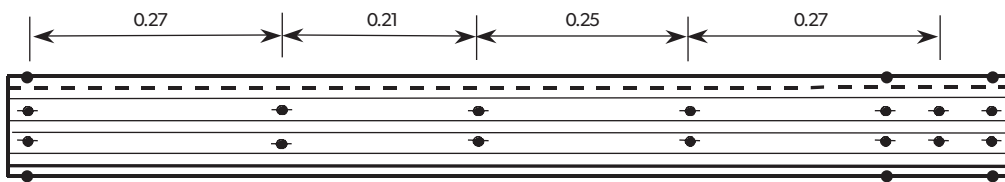

## INTERIOR SPANS (LAPPED AND UNLAPPED)

### One row of bridging

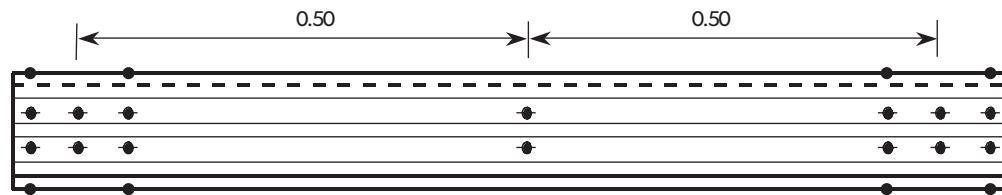

### Two row of bridging

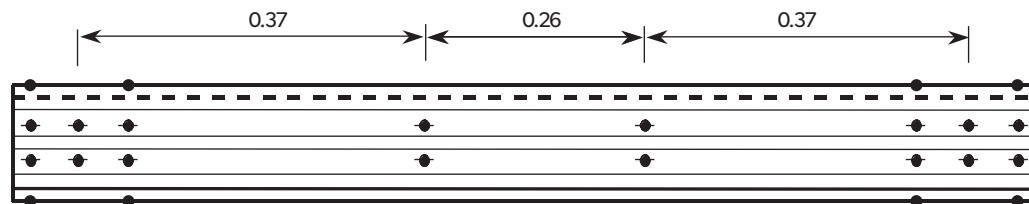

### Three row of bridging

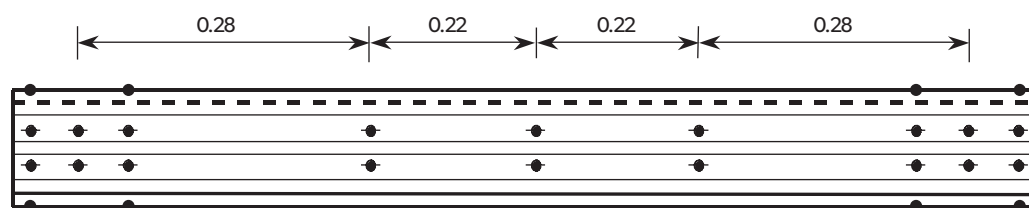

## 2.7 ACCESSORIES

There is a range of LYSAGHT® accessories available for use with the LYSAGHT® purlins. These accessories are an integral part of the LYSAGHT® purlin and girt system. All LYSAGHT® accessories are coated steel.

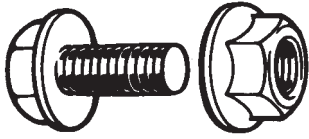

### 1) PURLIN BOLTS

Bolts with integral washers in both the head and nut shall be used for all types of connections described in this manual as required by AS/NZS 4600, Clause 5.3.1.

#### M12 SIZE

PB1230 LYSAGHT® standard purlin bolt (grade 4.6): M12x30mm with nut.

PB1230HS LYSAGHT® high-strength purlin bolt (grade 8.8): M12x30mm with nut.

#### M16 SIZE

PB1645 LYSAGHT® standard purlin bolt (grade 4.6): M16x45mm with nut.

### PURLIN TRIMMING BRACKETS

A variety of brackets are available for trimming around wall and roof penetrations such as doors, windows and services. These brackets are for lightly loaded applications, not for highly loaded structural connections.

### 2) GENERAL PURPOSE BRACKETS

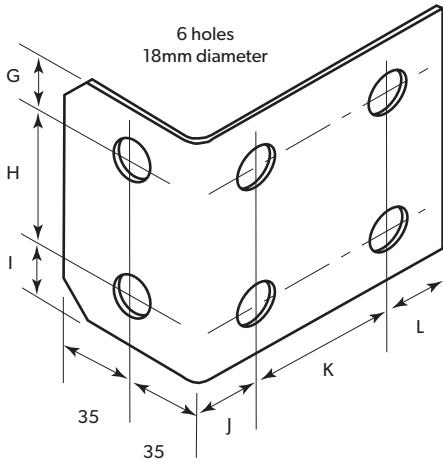

#### BRACKET DIMENSIONS

Bracket Product Code	G (mm)	H (mm)	I (mm)	J (mm)	K (mm)	L (mm)
100GPB	13	40	13	30	54	31
150GPB	22.5	60	22.5	30	67	28
200GPB	22	110	22	36	73	27
250GPB	20	160	20	36	73	27

Accessories for larger purlin range are subject to enquiry.

### 3) ANGLE CONNECTORS

The angle connectors are detailed to allow connections of sections of the same size or one size smaller.

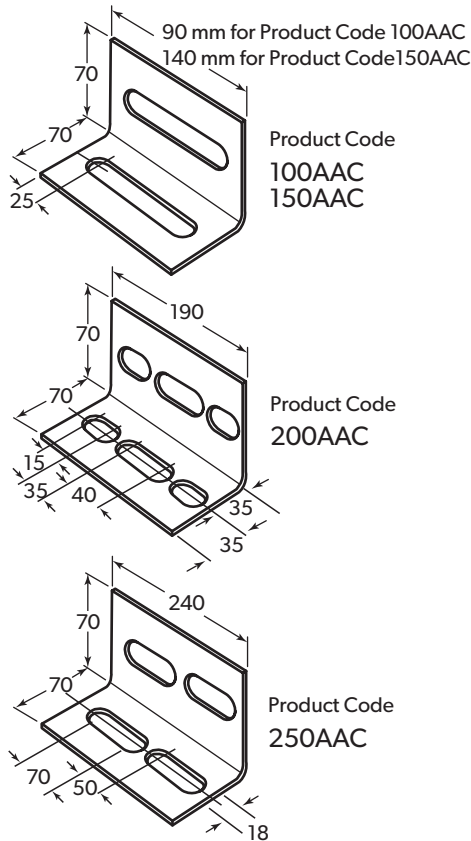

### 4) CLAMP PLATES

Used in conjunction with angle connectors and racking girt bracket to allow connections to the hips of Cee and SUPACEE® purlins.

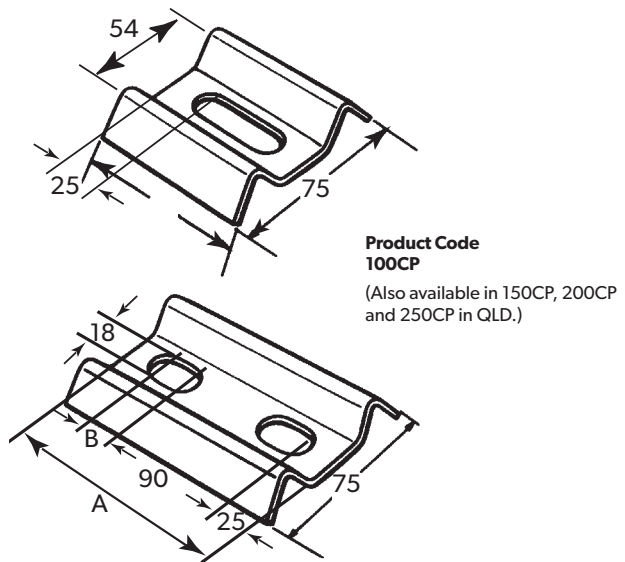

Product Code	A (mm)	B (mm)
150CP	140	15
200CP	190	15
250CP	240	40

(Also available in 100CP in QLD.)

## 5) RAKING GIRT BRACKET

Product Code C100RB

The Raking Girt Bracket is used to attach the ends of the C10015 Raking Girts to the Fascia. Bracket is supplied formed at right angles, as shown, and is formed on-site by the erector to the correct angle to suit to roof slope.

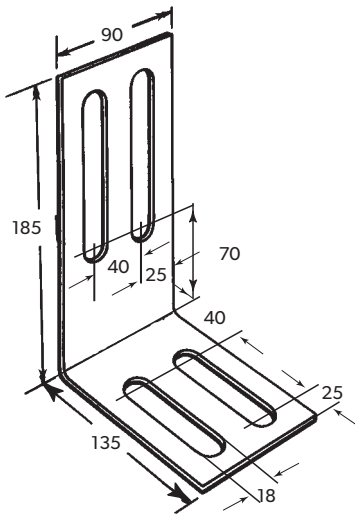

## 6) RAKING GIRT

The raking girt is simply a C10015 purlin profile. The raking girt bracket has been dimensioned to suit this girt.

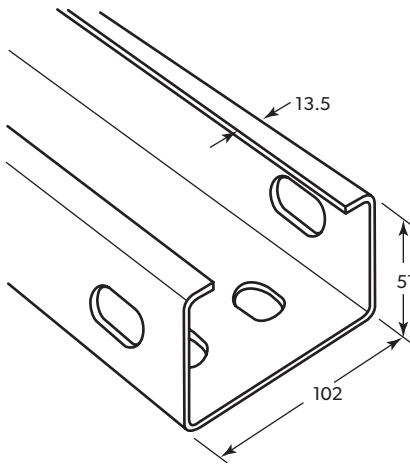

## 7) OTHER ACCESSORIES

There are other accessories that may be available subject to enquiry, and these may be subject to minimum order quantities and extended lead times.

These other accessories may include:

- Purlin bolts (different sizes and grades)
- Flange fixing washers
- Plate cleat and angle cleats. When angle cleats are used the projecting leg may require cropping to avoid interference with purlin lip
- Purlin profiles specifically shaped for fascia application
- Purlin profiles with down-turned bottom lip

## 2.8 HOOK-LOK® II BRIDGING MEMBERS

The HOOK-LOK® Bridging system is the standard and most widely used bridging system available and is suitable for most projects. It is fast and easy to install and can accommodate most construction configurations.

This system is suitable for purlin sizes from 100 to 250.

All components are coated for long life.

### COMPONENTS

The basic components of each HOOK-LOK® II bridging member are the locators and clamps connected at the ends of a length of channel or tie. The locator and clamp firmly lock each purlin or girt in position when simply located and hooked into the bridging holes from opposite sides of the web.

Locators and clamps have hook centres to match the holes punched in the webs of LYSAGHT® purlins and girts. The hole punching in the purlins and girts match the holes for cleat supports of the purlin and girt.

The alternative to the HOOK-LOK® II locator and clamp ends are the HOOK-LOK® II bolted bracket ends. These bolted bracket ends are the traditional ends where the bridging is to be firmly secured to the purlin webs with the use of bolts.

These ends are rigidly fixed to a channel section by means of "clinches".

HOOK-LOK® II components are not sold individually, only as parts/components of a bridging member.

### BRIDGING MEMBERS

Bridging members are supplied in lengths to suit the nominated purlin or girt spacing. There are some limitations on minimum lengths (see table of HOOK-LOK® II Bridging - Minimum lengths).

With the flexibility of component combinations it is possible to make many bridging members. The HOOK-LOK® II components chart shows the typical components that are used to make up a bridging member, and the HOOK-LOK® II Bridging members – Typical component combinations shows the vast array of combinations that are available to make up a bridging member.

Typical bridging members are either "fixed lengths" or "adjustable lengths". In the large proportion of the roof and wall the most commonly used bridging will be the 'fixed length' type.

At any change in direction of the roof/wall, or at ends of bridging runs it will be necessary to have an "adjustable length" of bridging (ridge, expansion joint, fascia, girt foot, etc.). These "adjustable length" bridging members allow the following adjustments to be made;

- Variation of length – by use of a double slotted channel or turnbuckle.
- Allowance for rotation of the end brackets in relation to the channel. Thus a bolted fixing can be supplied with the socketed channel in-lieu of the rigid clinched fixing.
- Allowance for lateral displacement of end brackets with slots. Thus a bolted fixing can be supplied with the socketed channel in-lieu of the rigid clinched fixing.

### PRODUCT CODES

The product codes for HOOK-LOK® II bridging members indicate the purlin size for each end (nominal depth), type of end and type of channel/turnbuckle that the ends are fixed.

How to specify the product code:

#### EXAMPLE 1

When specifying HOOK-LOK® II bridging members:

1. Specify the HOOK-LOK® II prefix H2.
2. Specify left hand end component – always three characters (e.g. C20)
3. Specify the type of bridging channel – always one character (e.g. P)
4. Specify right hand end component – three characters (e.g. L20)

Putting these together, you would get: H2 C20 P L20.

(This example shows ends of equal size.)

#### EXAMPLE 2

An adjustable bridging, with clamp to suit a SC15015 purlin at one end and a bolted bracket to suit a SC20024 purlin at the other end would be: H2 C15 T B20.

(This example shows ends of unequal size.)

#### EXAMPLE 3

Fascia bridging, to span between a SC20024 used as a fascia purlin and SC20015 purlin, would be: H2 F20 D L20.







(This example shows members with ends of equal size.)



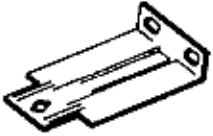

When specifying a Tie Rod then no other bracket or channel is required.

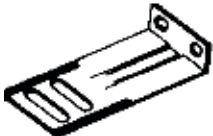
### OTHER BRIDGING MEMBERS

There are other bridging member details that may be available subject to enquiry. These other details may include a variation in the components (channel or bracket ends) or a variation in the fixing method of the bracket ends to the channel (such as bolted fixing).

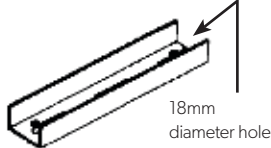
## HOOK-LOK® II COMPONENTS

Ends	Mark No.	
Clamp end CODE C	C10 C15 C20 C25	
Locator End CODE L	L10 L15 L20 L25	
Bolted bracket ends CODE B	B10 B15	
Bolted bracket ends CODE B	B20 B25	
Fascia brakcet end CODE F	F15	
Fascia brakcet end CODE F	F20 F25	
Girt bracket end CODE G		

Channels & Turnbuckles	Mark No.	
Bridging channel: plain CODE P	P	
Bridging channel: slotted CODE S	S	
Bridging channel: double CODE D	D	
Turnbuckle CODE T		
<b>Tie Rods</b>	<b>Mark No.</b>	
Tie rod CODE R	R12 (includes 4 nuts)	



# HOOK-LOK® II BRIDGING MEMBERS - TYPICAL COMPONENT COMBINATIONS

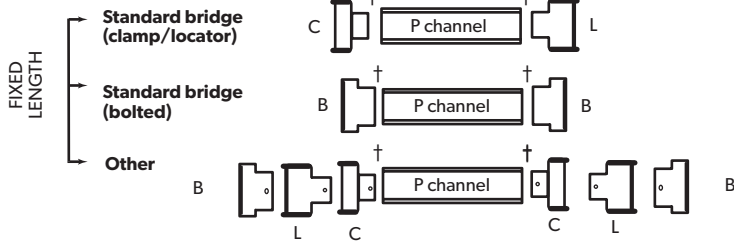

≠ bolt connection  
 † clinched connection  
 ▶ either clinched or bolt connection

**Note:**  
 Where either a clinched connection or bolt connection is available, the clinched connection will be provided unless otherwise requested.

**Legend**

- C = Clamp end bracket
- L = Locator end bracket
- B = Bolted bracket end
- F = Fascia end bracket
- G = Girt end bracket

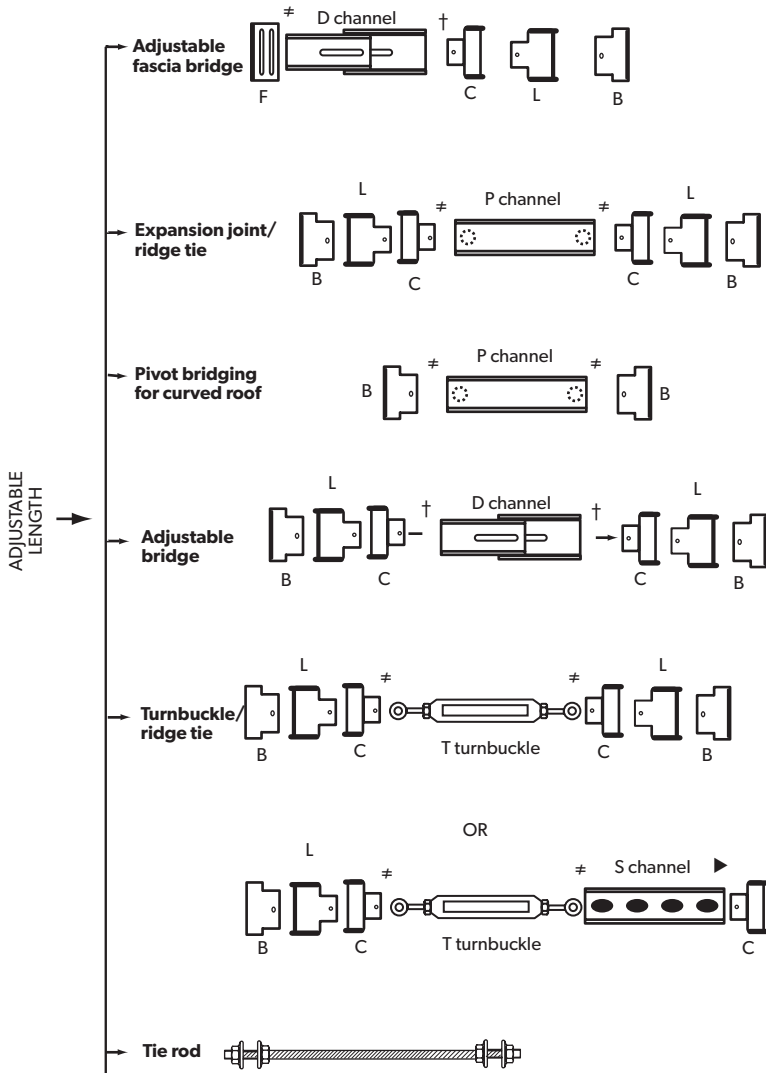

**GIRT BRIDGING OPTIONS**

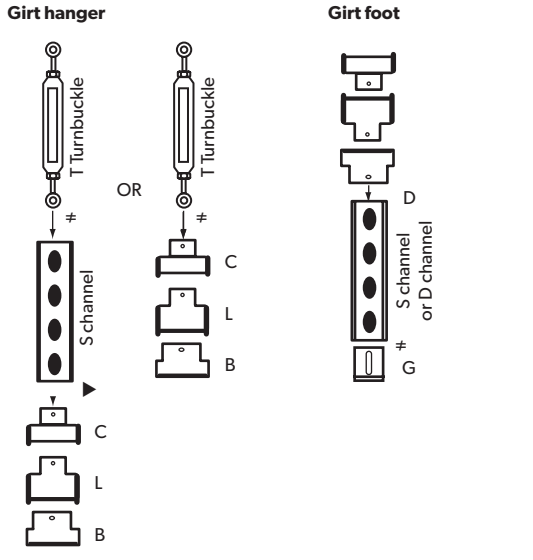

**HOOK-LOK® II BRIDGING - MINIMUM LENGTHS (MM)**

Bridging Member	Purlin Depth			
	100	150	200	250
Standard C-L ends	240	200	200	200
Standard bolted	450	450	200	200
Girt hangers	450	450	450	450
Girt foot	300	300	300	300
Turnbuckle ridge tie	500	500	500	500
Adjustable bridging	500	500	500	500
Tie rod	200	200	200	200

Minimum lengths may vary from state to state or for some component combinations. Please consult your local Lysaght Service Centre for clarification.

## 2.9 LYSAGHT® SERIES 300/350 BRIDGING MEMBERS

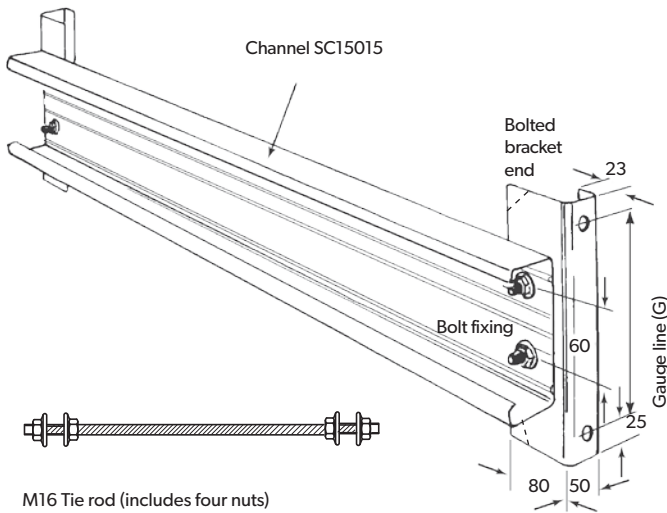

For the larger purlin sizes (300 and 350), a more substantial bridging system is required, due to larger spans and greater loads.

The bridging components are bigger and have additional strength.

The components consist of a SC15015 channel and bolted bracket ends fixed to the channel with LYSAGHT® high strength M12x30mm purlin bolts.

A tie rod is also available of size M16.

All components are coated for longer life.

When ordering, the overall bridging length should be specified, i.e. purlin or girt spacing, less 5mm.

Product codes for the bridging members are:

PBB300 - standard bridging for 300 size purlin

PBB350 - standard bridging for 350 size purlin

R16 - tie rod (3000mm long - please check with your local Lysaght Office for availability).

Where SC/SZ400 purlins are specified, contact Lysaght Technology for advice on 400 series bridging.

Other bridging member details that may be available are subject to enquiry.

## 2.10 PROCUREMENT

### PACKING

The LYSAGHT® purlins are delivered to site in strapped bundles. The actual quantity in each bundle will vary with section size, order and length. The bundle mass is generally one tonne.

LYSAGHT® accessories and bridging are delivered in strapped or wired bundles, bags, or packages as appropriate.

### AVAILABLE LENGTH

LYSAGHT® purlins are available custom-cut in any transportable length, however there are some limitations.

The load tables show spans as low as 2000mm. However in projects where shorter lengths are required, such as for trimmers, smaller lengths can be made available. For the minimum lengths please contact your local Lysaght distributor. For lengths greater than 12000mm suitable transportation and handling facilities will be required. Also the hours of transportation of long loads are restricted by law.

For short lengths and lengths over 12000mm, please contact your nearest Lysaght Service Centre. For SA and Queensland, lengths up to 18000 are available. Contact your local Lysaght Office for transport availability.

### STORAGE ON-SITE

If the purlins and bridging are not required for immediate use then they should be neatly stacked off the ground and on a slight slope so that water can drain away. Purlin sections, accessories and bridging should not be left exposed in the open for extended periods.

### ORDERING

To make ordering of the purlins, bridging and accessories easier, every Lysaght Service Centre has order pads available on request.

Samples of standard order forms are on the following pages.

Customer: \_\_\_\_\_ Date Ordered \_\_\_\_\_ Sheets of \_\_\_\_\_

Delivery Address: \_\_\_\_\_ Date Required \_\_\_\_\_ Customer Order No. \_\_\_\_\_

Detailer Reference \_\_\_\_\_ Detailer Reference \_\_\_\_\_

Please show hole pattern required and progressive location from left to right.

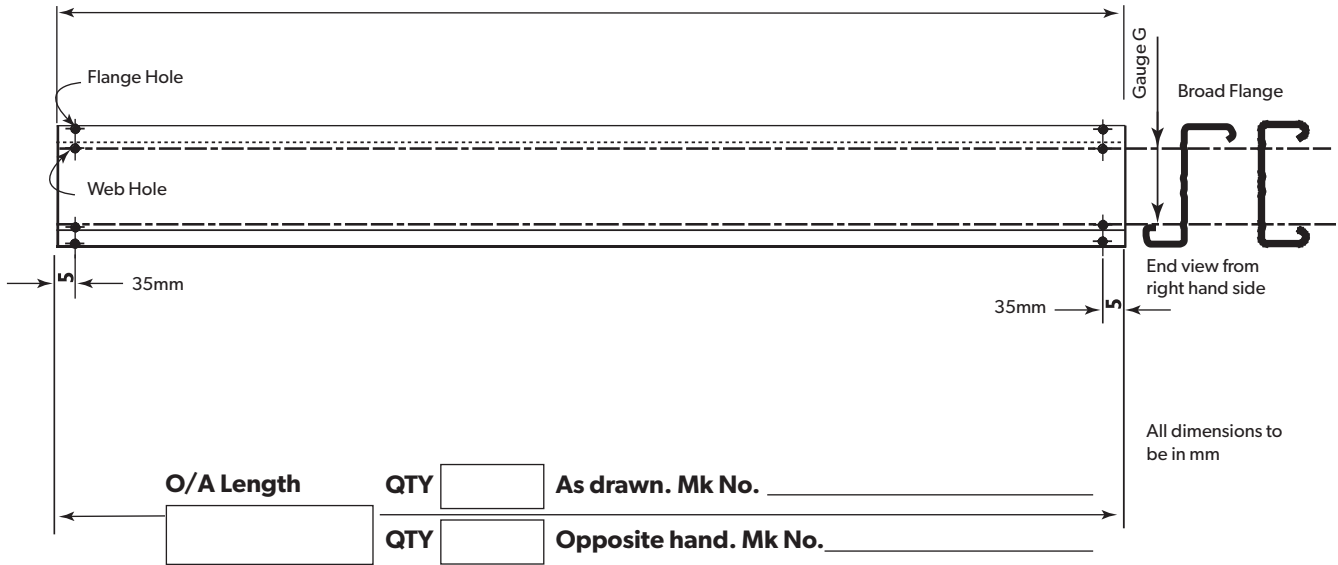

Product Code \_\_\_\_\_ Other special details \_\_\_\_\_

Detailer Reference \_\_\_\_\_ Detailer Reference \_\_\_\_\_

Please show hole pattern required and progressive location from left to right.

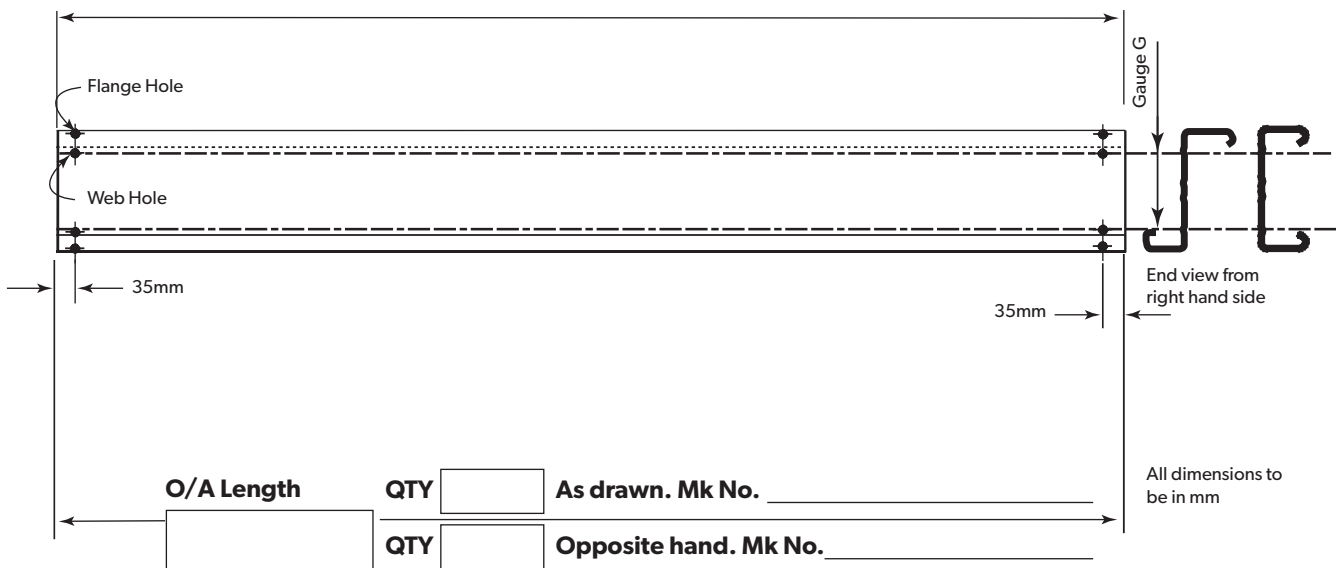

Product Code \_\_\_\_\_ Other Special Details \_\_\_\_\_





## SECTION 3

### 3.0 Assemblies & Installation



Note:

All following assemblies and installation details are equally applicable to the traditional purlins (Zeds & Cees) and the SUPAPURLINS® (SUPAZEDS® & SUPACEES®).

### 3.1 PURLIN CONNECTIONS

#### CLEAT CONNECTIONS

The purlin capacity tables are based on the sections being fastened through the web to cleats so that the load path is via the web of the sections.

The connections may be single section thickness such as in end connections, or the internal support connection of continuous configurations. Connections with double section thickness occur at the internal support of lapped configurations.

Each connection uses two bolts.

Cleats must be detailed to provide a nominal gap between the support and the bottom flange of the purlin. In certain situations a larger gap may be required (e.g. roof cladding expansion joints, downturned lip purlins).

Cleats are to be detailed by the engineer, however it must not be less than shown in the diagrams.

#### Lapped continuous joint with two bolts

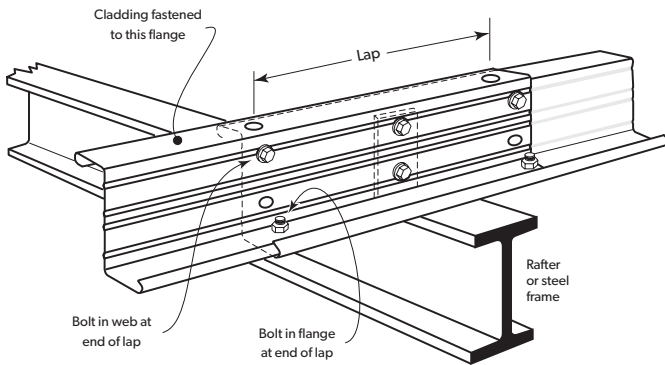

#### LAPPING

The structural lap at the internal supports of lapped configurations must be detailed to provide adequate structural continuity.

Each end of the lap must have one bolt through the flange furthest from the cladding, and one bolt through the webs near the flanges connected to the cladding.

The nominal lap length is the distance between the bolt centres at the end of the laps. In no situation must the lap be less than 10% of the span.

#### DETAILS OF CLEATS

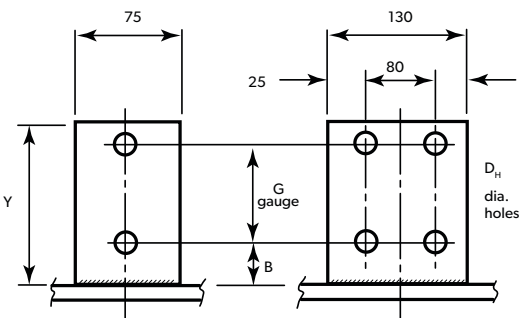

#### CLEAT NOMINAL DIMENSIONS

Nominal Purlin Size (mm)	B	Y	t (thickness)	Gap	D <sub>H</sub>	Gauge
100	40	105	8	10	18	40
150	55	145	8	10	18	60
200	55	195	8	10	18	110
250	55	245	8	10	18	160
300	65	305	12	20	22	210
350	65	355	12	20	22	260
400	65	410	12	20	22	310

#### Butt joint with four bolts

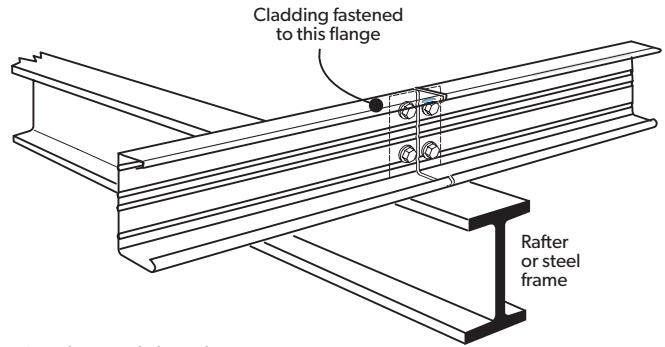

#### Continuous joint with two bolts

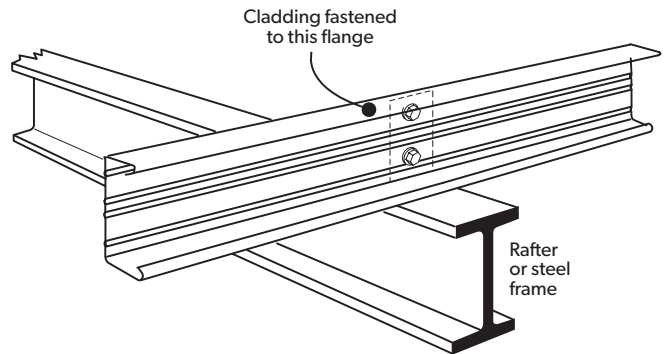

#### STANDARD PURLIN ORIENTATION

The industry standard orientation of purlin and girt fixing to cleats is detailed below. In certain projects the standard orientations may be varied. For the other orientations refer to Section 5 of this manual.

#### FASTENING TO CLEATS (STANDARD MODES)

##### Zed purlins lapped

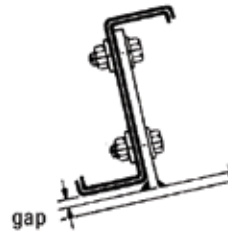

##### Zed girts lapped

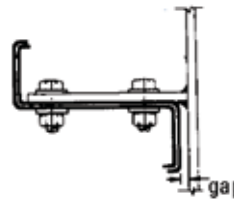

##### Cee purlin

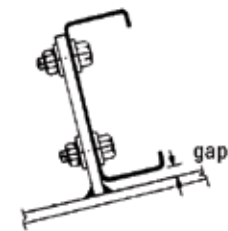

##### Cee girts

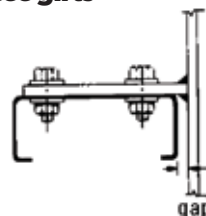

### 3.2 TYPICAL ASSEMBLIES WITH TRIMMING BRACKETS

The various purlin trimming brackets are used for a variety of applications. These applications are for lightly loaded situations.

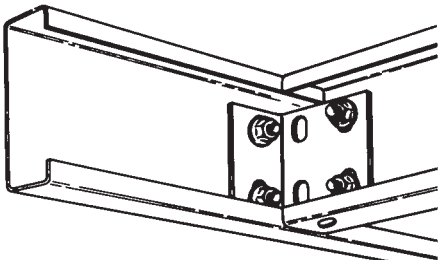

#### GENERAL PURPOSE BRACKET

The general purpose bracket is ideal for making joints of approximately 90° and is usually used for joining sections of the same web depth. Typical applications include lightly loaded heads to openings, trimmers and fascias at gable ends.

#### ANGLE CONNECTOR AND CLAMP PLATE

The Angle Connector can be used in a variety of different ways. The holes allow connection between sections of the same size or one size smaller. Figure A shows the angle connector and clamp plate as a foot mounting for lightly loaded vertical members such as jambs for personnel access doors or windows. It can also be used as a column base in lightly loaded or internal applications. Figure B shows a closed end on a girt. This obviates the need for mitred girts at corners while still providing a satisfactory attachment point for the cladding and corner treatment. Figure C shows a simple mitred 90° joint. Figure D shows the angle connector and clamp plate used as an attachment for trimmers or non-load-bearing heads to openings.

#### RACKING GIRT ASSEMBLY

Shown is one method of fitting racking girts using bolts and clamp plates. The racking girt bracket is used to attach the end of a C10015 racking girt to the fascia purlin.

Alternatively the racking girt can be installed open face down. The clamp plates are deleted and the girt attached with bolts fitted through holes prepunched in the web of the purlin.

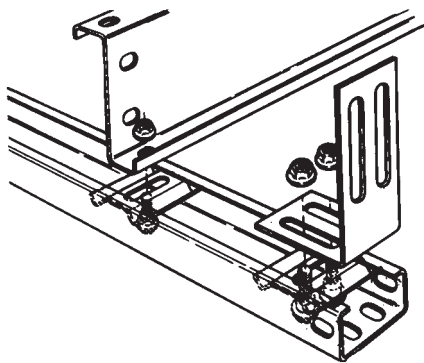

Figure A:

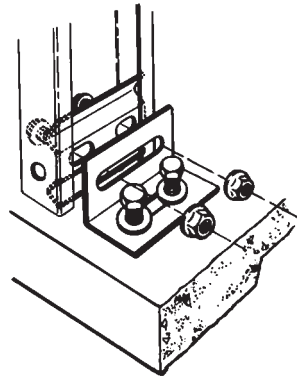

Figure B:

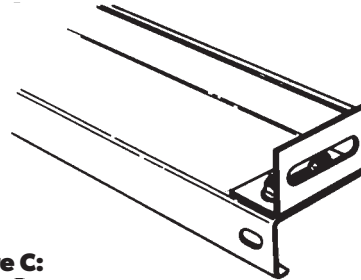

Figure C:

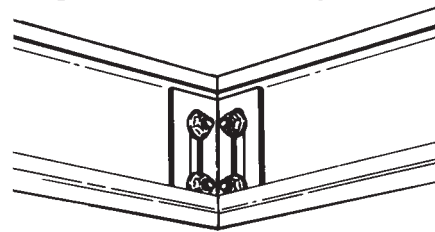
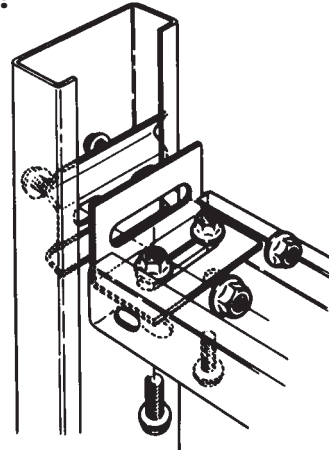

Figure D:





### 3.3 ROOFING & WALLING ASSEMBLIES

Typical assemblies using the LYSAGHT® purlins and girt sections, HOOK-LOK® II bridging and trimming brackets

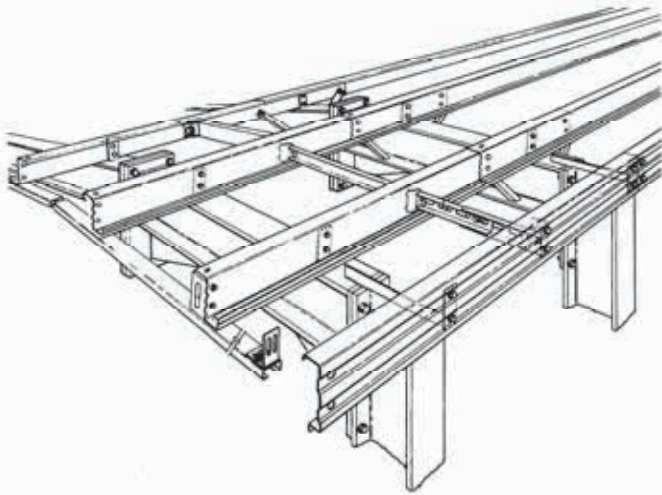

Where fly bracing is used in conjunction with the purlin and girt sections it is important that the bolt requirements for lapping are not compromised.

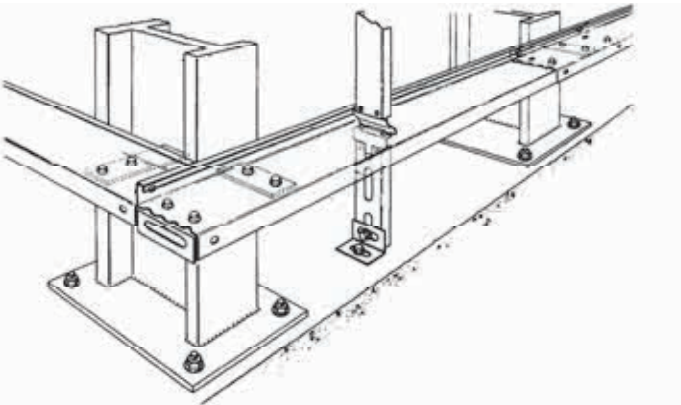

Note: SUPAZED® girt is shown in the non-standard mode. (Refer to Purlin Orientation in Section 5).

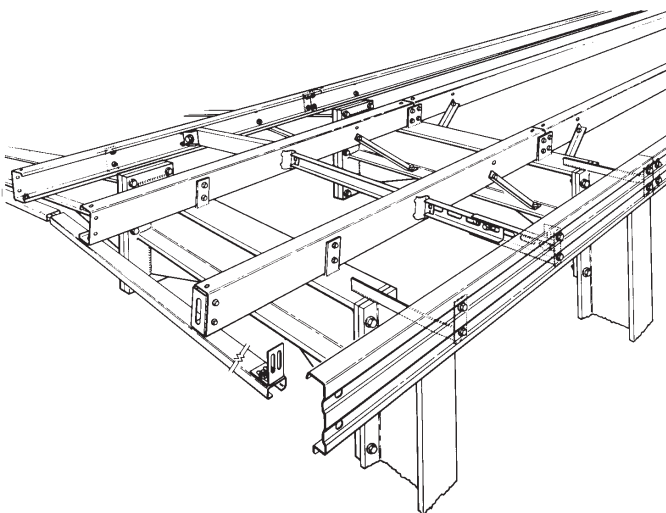

Note: The project supervisor should ensure that the cladding bundles are lifted to the roof and stored over the rafters (not over the mid-span region of the purlins).

### ERECTION NOTES

Care should be taken during the erection of the purlins and the steel frames so as to minimise the compressive forces in the purlins. The designer should consider the possible imposed actual loads during the construction phase. Further more, the installer should consider the construction sequence, so that the purlins and girts are not undergoing construction forces unrestrained. If the construction sequence has the potential to cause compressive forces in the purlins during construction then the designer should be notified.

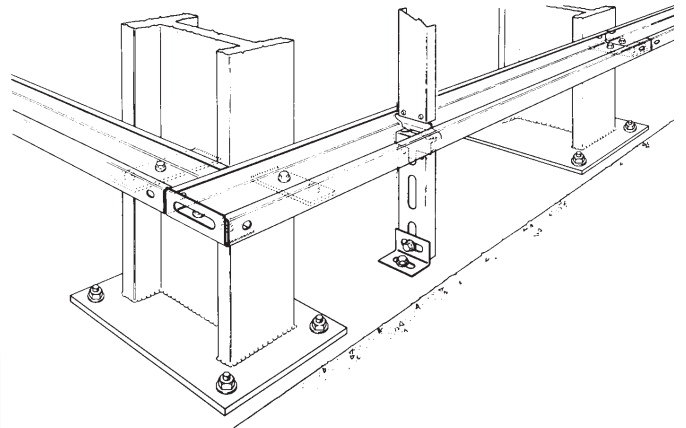

### 3.4 BRIDGING ASSEMBLIES

There are three methods of bridging across the ridge, by far the best method is to use a ridge tie which is comprised of typically bolted ends on a socketted channel. The second method is to use a turnbuckle ridge tie with bolted ends. The third method is to use a threaded rod connecting the top or bottom holes in the purlins. In the case of the threaded rod where the top or bottom holes are left unconnected then the unconnected holes require an M12 bolt.

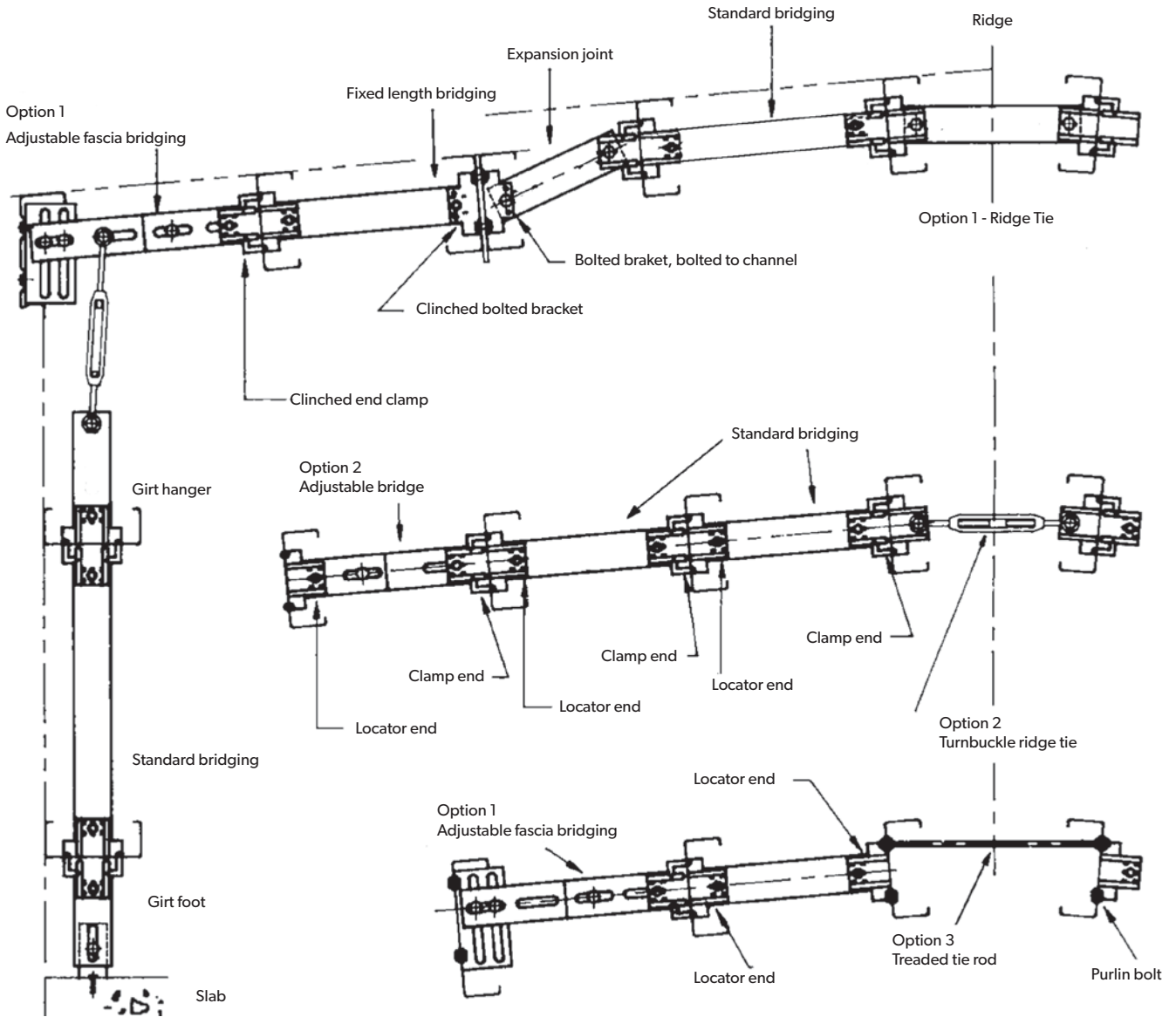

### 3.5 BRIDGING INSTALLATION

The installation method of bridging members, when using bolted ends, is the traditional and accepted method in the industry. The installation method for the HOOK-LOK® II, when using the clamp ends and the locator ends, is also a long standing (over 20 years) and accepted method in the industry, however description is required for the unfamiliar.

The HOOK-LOK® II bridging system relies on a locator end being first inserted into the holes of the purlin web from the previous length of bridging and it is then "locked" into place with the clamp end on the following length of bridging. This clamp end is inserted into the same two holes of the web, but from the other side of the web. This clamp end is inserted from an angle and then swung, or turned, into the correct line to lock the connection together.

#### Eaves start

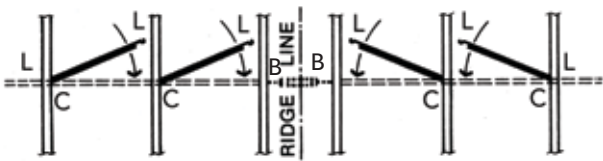

#### Ridge start

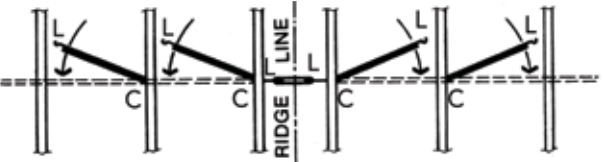

L= HOOK-LOK locator bracket  
C= HOOK-LOK clamp bracket

### PURLIN BRIDGING

The following diagrams and text describe how the installation is completed. Installation of bridging members for roofs (purlins) can be commenced from the eaves or from the ridge (eaves start or ridge start). The following description is for an eaves start.

**Step 1:** Install the fascia bridging member by inserting the locator end into the holes of the first purlin, and bolting the fascia bracket to the fascia purlin.

**Step 2:** Install the standard bridging members working towards, and finishing at, the ridge purlin. Standard bridging members are installed by fitting the clamp end over the previously-installed locator end and swinging the bridging around until the locator end engages in the holes of the next purlin.

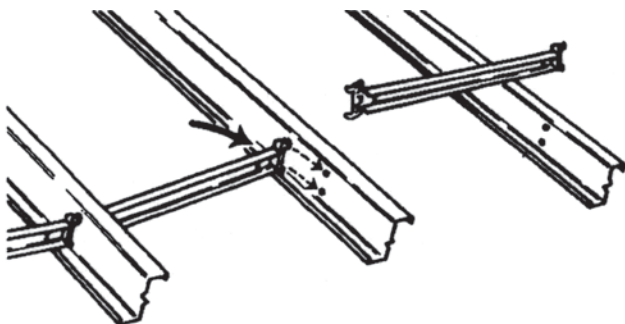

**Step 3:** Where applicable, repeat Steps 1 and 2 for the opposite side of the roof. If appearance is a consideration, the bridging runs on both sides of the roof should be swung into position from the same end of the roof.

**Step 4:** Install the ridge tie member by fitting the clamp ends over the previously installed locator ends and then tightening the bolts of the tie member. When a ridge tie member is not used, the locator(s) of the standard bridging is secured into position with two bolts.

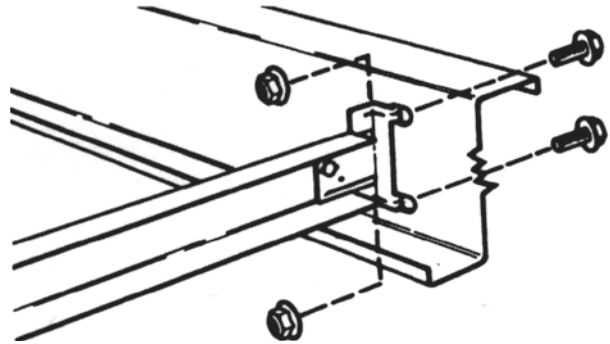

**Step 5:** Where turnbuckles are used in a bridging member, first align the purlins by adjustment of the turnbuckle. Align the fascia purlin using the, adjustment bolts of the fascia bridging member.

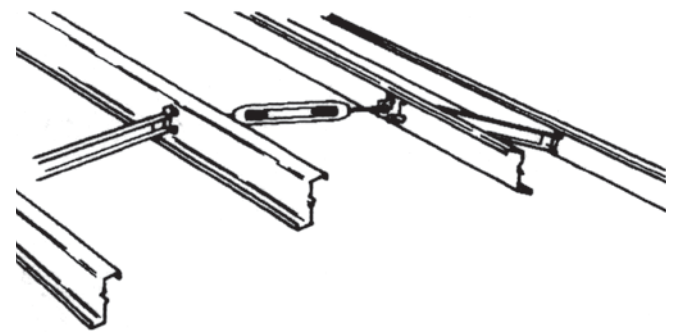

## GIRT BRIDGING

The recommended procedure is to commence at floor level and work towards the eaves. A typical installation procedure is:

**Step 1:** Install the girt foot bridging member by engaging the locator into the holes of the bottom girt. Due to the loads transferred to the bridging from the girts, the girt foot member must be anchored to the slab.

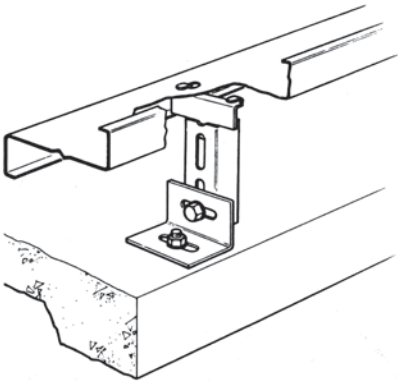

**Step 2:** Adjust the girt foot bridging member to level off the bottom girt. Where the slab is not yet poured, a temporary support is required to keep the bottom girt level.

**Step 3:** Install standard bridging members as described in Step 2 for purlin bridging, working towards the eaves.

**Step 4:** At the top girt, the locator is secured into position with two bolts. If appearance is a consideration ensure the girt and purlin bridging are installed facing the same direction.

Where a girt hanger is used it is installed by fitting the clamp end over the last installed locator end and swinging the bridging around, then bolting the turnbuckle to the fascia bridging.

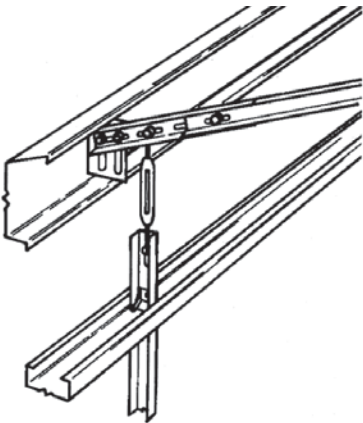

# SECTION 4

## 4.0 Purlin & Girt Limit State Capacity Tables

Purlins - 2 Span Continuous INWARD CAPACITY (kN/m)									
Span	Z/C10012			Z/C10015			Z/C10018		
	0	1	2&3	0	1	2&3	0	1	2&3
2000	4.90	4.32	3.50	6.95	5.40	4.31	9.57	7.42	5.89
2250	4.25	3.68	2.89	5.58	4.31	3.73	8.00	5.89	4.78
2500	3.95	3.04	2.43	4.77	3.52	3.14	6.01	4.78	3.95
2750	3.04	2.07	1.78	3.68	2.92	2.67	4.63	3.31	2.81
3000	2.39	1.77	1.55	2.89	2.46	2.30	3.64	2.81	2.41
3250	1.92	1.56	1.37	2.32	2.10	2.01	2.91	2.41	2.09
3500	1.56	1.32	1.21	1.88	1.81	1.76	2.37	1.95	1.83
3750	1.28	1.07	1.08	1.55	1.57	1.56	1.95	1.63	1.61
4000	1.13	1.00	0.97	1.29	1.38	1.39	1.56	1.37	1.43
4250	1.00	0.89	0.87	1.09	1.22	1.25	1.39	1.17	1.27
4500	0.89	0.80	0.79	0.97	1.08	1.13	1.25	1.00	1.14
4750	0.80	0.72	0.72	0.87	0.97	1.03	1.13	0.86	1.03
5000	0.72	0.65	0.66	0.79	0.87	0.92	1.02	0.75	0.92
5250	0.65	0.60	0.61	0.72	0.79	0.83	0.92	0.66	0.82
5500	0.60	0.54	0.56	0.66	0.72	0.76	0.83	0.56	0.70
5750	0.56	0.50	0.52	0.61	0.66	0.69	0.76	0.48	0.61
6000	0.50	0.46	0.48	0.56	0.61	0.64	0.70	0.45	0.56
6250	0.45	0.43	0.45	0.52	0.56	0.59	0.64	0.42	0.52
6500	0.40	0.40	0.42	0.48	0.52	0.55	0.60	0.42	0.48
6750	0.40	0.40	0.42	0.45	0.48	0.51	0.56	0.42	0.45
7000	0.40	0.40	0.42	0.42	0.45	0.48	0.52	0.42	0.45
7250	0.40	0.40	0.42	0.42	0.45	0.48	0.52	0.42	0.45
7500	0.40	0.40	0.42	0.42	0.45	0.48	0.52	0.42	0.45
7750	0.40	0.40	0.42	0.42	0.45	0.48	0.52	0.42	0.45
8000	0.40	0.40	0.42	0.42	0.45	0.48	0.52	0.42	0.45

0.99 Outside the "200" bridging requirements

12.7 Values in bold type require High Strength bolts (Grade 8.8)

1 The number of rows of bridging

Ws The serviceability capacity for a deflection of Span/150

Connections use M12 bolts. For 300 & 350 deep purlins use M16

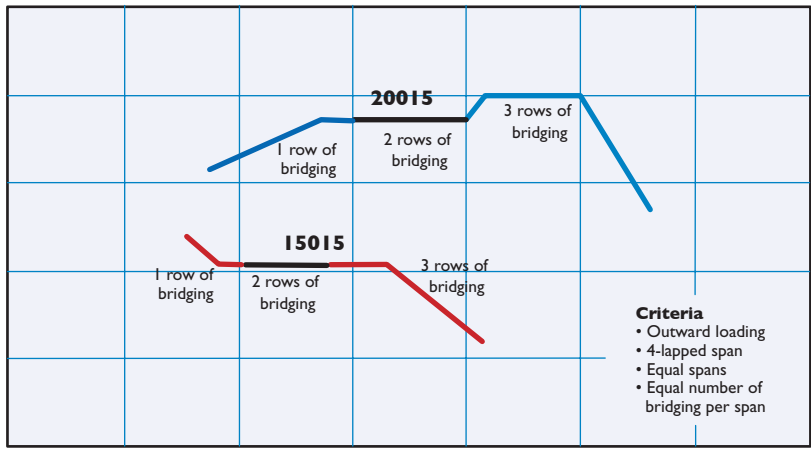

Z/C20012	
1	2&3
0.08	0.08
3.70	3.70
3.37	3.37
3.08	3.08
2.83	2.83
2.61	2.61
2.42	2.42
2.24	2.24
2.08	2.08
1.99	1.99
1.91	1.91
1.83	1.83
1.75	1.75
1.67	1.67
1.59	1.59
1.51	1.51
1.43	1.43
1.35	1.35
1.27	1.27
1.19	1.19
1.11	1.11
1.03	1.03
0.95	0.95
0.87	0.87
0.79	0.79
0.71	0.71
0.63	0.63
0.55	0.55
0.47	0.47
0.39	0.39
0.31	0.31
0.23	0.23
0.15	0.15
0.07	0.07

## 4.1 DESIGN NOTES TO LIMIT STATE CAPACITY TABLES

### DESIGN METHOD

The purlin capacity tables have been compiled using a program that carries out the analysis and design for purlin systems composed of cold-formed members.

The analysis includes an in-plane structural analysis and a finite element lateral buckling analysis of complete purlin systems.

The design for both strength and serviceability limit states is performed according to AS/NZS 4600:2005, including the calculation of section properties.

The finite element flexural torsional buckling analysis assumes that:

- all purlins bend about the axis which is perpendicular to the web
- there is continuity at the laps
- there is minor axis translation and twisting restraint at the bridging points and cleat supports
- the loading is uniform
- the cladding provides lateral restraint to the top flange of the purlin

### DEFLECTIONS

The column in the design tables shows UDL load which results in deflections equal  $\text{Span}/150$ . Other deflection limits may be derived from given values using simple proportions.

### INTERMEDIATE VALUES

Within a given bridging configuration, capacities for intermediate spans may be interpolated linearly.

### PARAMETERS

The values given in the purlin capacity tables are based on the following design criteria and assumptions:

- the tables have been based on the use of approved product manufactured by Lysaght (purlin profile, bridging, purlin bolts and cladding) and installed in accordance with the details set out in this LYSAGHT® Manual;
- cladding is fastened to the top (or outside) flange. Guidance has been given for the reduction of capacity where low restraint cladding is used;
- loads are assumed to be acting via the cladding;
- loads are acting in Outward or Inward direction;
- the capacity given is a uniformly distributed load (UDL) acting Outward or Inward and acting over the whole purlin configuration. Thus all design loads must be converted into an equivalent uniformly distributed value;
- a uniform distributed load (UDL) is given that will produce a deflection of  $\text{Span}/150$  for the critical span of the configuration. These values are the same for both Outward and Inward acting loads. This value is NOT a design capacity;
- span configurations are either Single, Double, Three or Four;
- for multiple span configurations (double, three and four) all span lengths in the configuration are equal;
- lapped span configuration is with a lap at each of the internal supports;
- laps are 15% of the span;
- for three and four lapped configurations with mixed thicknesses are used then the greater thickness is in the end span;
- for three and four lapped configurations where mixed quantities

of bridging is used then the greater number is in the end span;

- all purlin sections are fastened through the web to cleat supports. All connections to cleats are with two purlin bolts (Standard bolt of Grade 4.6, High Strength bolt of Grade 8.8). Where a value is in bold type then the Grade 8.8 bolts are required;

Outward Load

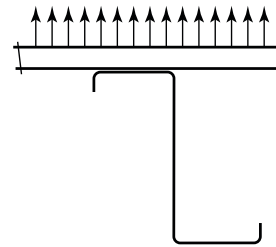

Inward Load

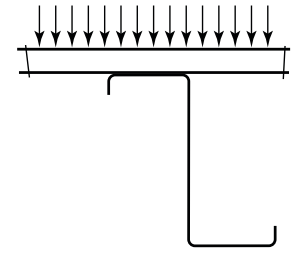

Outward Load is defined as the load to pull the cladding off the flange. Inward Loads are those pushing the cladding onto the flange.

### BRIDGING

In most practical situations it would be necessary to use at least one row of bridging per span. For guidance, unbridged length limited to  $20D$  is suggested (where  $D$  is the section depth). With large spans and deeper sections, a guide of  $15D$  may be more appropriate.

### PERFORMANCE

When comparing the capacity of LYSAGHT® purlins with other purlin profiles care needs to be exercised. Comparisons can only be successfully completed when a "like-for-like" comparison is made. Differences can result from a number of reasons such as the selection of design parameters for cleat restraints, cladding restraints, bridging location, lap lengths, profile dimensions and others.

A like-for-like comparison of traditional LYSAGHT® purlins with LYSAGHT SUPAZED® purlins highlights significant improvement in performance (see comparison chart at the front of Section 4).

In accordance with the latest provisions of AS/NZS 4600 Cold-formed steel structures, the purlin capacities have been calculated for LYSAGHT® sections using approved LYSAGHT® bridging systems, bolts and other accessories. Sections chosen using the data provided in the tables will perform as specified when the design, fabrication and erection are carried out in accordance with Lysaght recommendations and accepted building practice.

### PURLIN DESIGN SOFTWARE

The purlin capacity tables are based on a range of parameters. For variations to these parameters such as cladding restraint, bridging location, span ratios, lap lengths, etc., a computer program is available to carry out a more project specific and economic design (see section on Capacity tables - other design effects, Design Optimisation at the end of the tables).

## 4.2 INDEX TO LIMIT STATE CAPACITY TABLES

Product Code	Single Spans	Continuous Spans	Lapped Continuous Spans	
	1 Span	2 Span	2 Span	4 Span
Z/C10010	Page 32 & 33	Page 42 & 43	Page 52 & 53	Page 62 to 65
Z/C10012	Page 32 & 33	Page 42 & 43	Page 52 & 53	Page 62 to 65
Z/C10015	Page 32 & 33	Page 42 & 43	Page 52 & 53	Page 62 to 65
Z/C10019	Page 32 & 33	Page 42 & 43	Page 52 & 53	Page 62 to 65
SZ/SC15010	Page 34 & 35	Page 44 & 45	Page 54 & 55	Page 66 to 69
SZ/SC15012	Page 34 & 35	Page 44 & 45	Page 54 & 55	Page 66 to 69
SZ/SC15015	Page 34 & 35	Page 44 & 45	Page 54 & 55	Page 66 to 69
SZ/SC15019	Page 34 & 35	Page 44 & 45	Page 54 & 55	Page 66 to 69
SZ/SC15024	Page 34 & 35	Page 44 & 45	Page 54 & 55	Page 66 to 69
SZ/SC20012	Page 36 & 37	Page 46 & 47	Page 56 & 57	Page 70 to 73
SZ/SC20015	Page 36 & 37	Page 46 & 47	Page 56 & 57	Page 70 to 73
SZ/SC20019	Page 36 & 37	Page 46 & 47	Page 56 & 57	Page 70 to 73
SZ/SC20024	Page 36 & 37	Page 46 & 47	Page 56 & 57	Page 70 to 73
SZ/SC25015	Page 38 & 39	Page 48 to 49	Page 58 & 59	Page 74 to 77
SZ/SC25019	Page 38 & 39	Page 48 to 49	Page 58 & 59	Page 74 to 77
SZ/SC25024	Page 38 & 39	Page 48 to 49	Page 58 & 59	Page 74 to 77
SZ/SC30019	Page 40 & 41	Page 50 & 51	Page 60 & 61	Page 78 to 81
SZ/SC30024	Page 40 & 41	Page 50 & 51	Page 60 & 61	Page 78 to 81
SZ/SC30030	Page 40 & 41	Page 50 & 51	Page 60 & 61	Page 78 to 81
SZ/SC35024*	Refer to soft copy (.pdf) of this manual on attached CD.			
SZ/SC35030*				
SZ/SC40024**	Refer to soft copy (.pdf) of this manual on attached CD.			
SZ/SC40030**				
SZ/SC40032**				

Notes:

- All tables are with equal number of bridging per span.
- The electronic version of this manual (called 'soft copy' or .pdf file) is available on the attached CD or via the Lysaght website.
- The 'soft copy' version of this manual has many more capacity tables of configurations, mixed thicknesses, mixed bridging combinations and the full purlin range.
- Other capacities may be generated by use of the SUPAPURLIN® Software. Consult your local Lysaght Service Centre for advice on how to access.
- Purlins marked \* availability is subject to enquiry. Consult your local Lysaght Service Centre for advice. Extended lead times may apply.
- Purlins marked \*\* are available in QLD and SA only. Consult your local Lysaght Service Centre for advice. Extended lead times may apply.

### Single Span

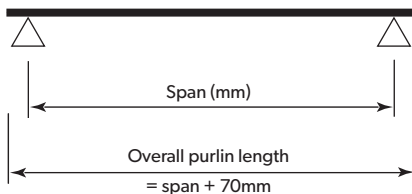

### 2 Span Continuous

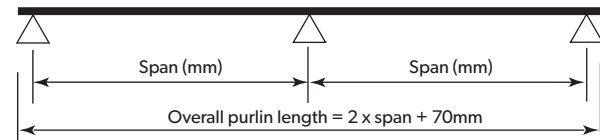

### 3 Span Continuous

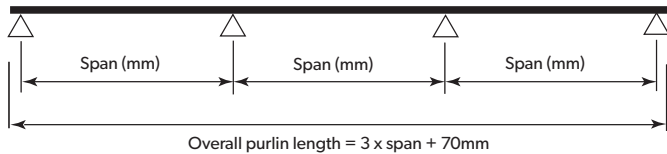

### 4 Span Continuous

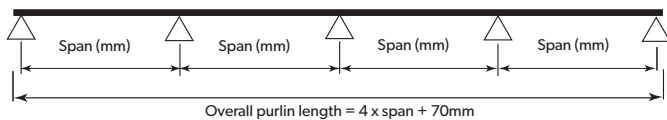

### 2 Span Lapped Continuous

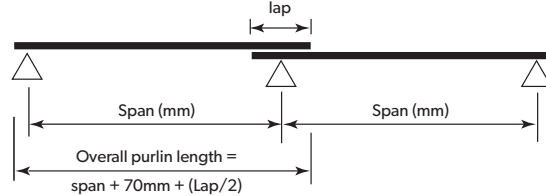

### 3 Span Lapped Continuous

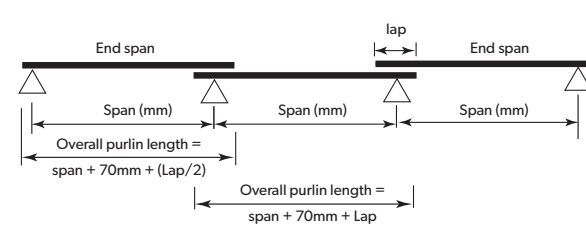

### 4 Span Lapped Continuous

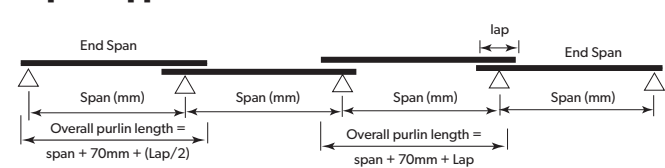

## 4.3 CAPACITY TABLES

### 1 SPAN - INWARD CAPACITY

C/Z10010						C/Z10012						C/Z10015					
Bridging Span	0	1	2	3	L/150	Bridging Span	0	1	2	3	L/150	Bridging Span	0	1	2	3	L/150
2000	4.50	4.50	4.50	4.50	4.27	2000	5.46	5.46	5.46	5.46	5.16	2000	6.96	7.11	7.11	7.11	6.57
2250	3.56	3.56	3.56	3.56	3.00	2250	4.31	4.31	4.31	4.31	3.62	2250	5.45	5.62	5.62	5.62	4.61
2500	2.88	2.88	2.88	2.88	2.19	2500	3.50	3.50	3.50	3.50	2.64	2500	4.39	4.55	4.55	4.55	3.36
2750	2.38	2.38	2.38	2.38	1.64	2750	2.89	2.89	2.89	2.89	1.98	2750	3.60	3.76	3.76	3.76	2.53
3000	2.00	2.00	2.00	2.00	1.27	3000	2.43	2.43	2.43	2.43	1.53	3000	3.01	3.16	3.16	3.16	1.95
3250	1.70	1.70	1.70	1.70	1.00	3250	2.07	2.07	2.07	2.07	1.20	3250	2.55	2.69	2.69	2.69	1.53
3500	1.47	1.47	1.47	1.47	0.80	3500	1.78	1.78	1.78	1.78	0.96	3500	2.19	2.32	2.32	2.32	1.23
3750	1.28	1.28	1.28	1.28	0.65	3750	1.55	1.55	1.55	1.55	0.78	3750	1.90	2.02	2.02	2.02	1.00
4000	1.13	1.13	1.13	1.13	0.53	4000	1.37	1.37	1.37	1.37	0.65	4000	1.67	1.78	1.78	1.78	0.82
4250	1.00	1.00	1.00	1.00	0.45	4250	1.21	1.21	1.21	1.21	0.54	4250	1.47	1.58	1.58	1.58	0.68
4500	0.89	0.89	0.89	0.89	0.38	4500	1.08	1.08	1.08	1.08	0.45	4500	1.31	1.41	1.41	1.41	0.58
4750	0.80	0.80	0.80	0.80	0.32	4750	0.97	0.97	0.97	0.97	0.39	4750	1.17	1.26	1.26	1.26	0.49
5000	0.72	0.72	0.72	0.72	0.27	5000	0.87	0.87	0.87	0.87	0.33	5000	1.05	1.14	1.14	1.14	0.42
5250	0.65	0.65	0.65	0.65	0.24	5250	0.79	0.79	0.79	0.79	0.29	5250	0.95	1.03	1.03	1.03	0.36
5500	0.60	0.60	0.60	0.60	0.21	5500	0.72	0.72	0.72	0.72	0.25	5500	0.87	0.94	0.94	0.94	0.32
5750	0.54	0.54	0.54	0.55	0.18	5750	0.66	0.66	0.66	0.66	0.22	5750	0.79	0.86	0.86	0.86	0.28
6000	0.50	0.50	0.50	0.50	0.16	6000	0.60	0.61	0.61	0.61	0.19	6000	0.73	0.79	0.79	0.79	0.24
6250	0.46	0.46	0.46	0.46	0.14	6250	0.55	0.56	0.56	0.56	0.17	6250	0.67	0.73	0.73	0.73	0.22
6500	0.43	0.43	0.43	0.43	0.12	6500	0.51	0.52	0.52	0.52	0.15	6500	0.62	0.67	0.67	0.67	0.19
6750						6750	0.47	0.48	0.48	0.48	0.13	6750	0.57	0.62	0.62	0.62	0.17
7000						7000	0.44	0.45	0.45	0.45	0.12	7000	0.53	0.58	0.58	0.58	0.15
7500						7500						7500	0.46	0.51	0.51	0.51	0.13
8000						8000						8000	0.40	0.45	0.45	0.45	0.10

C/Z10019					
Bridging Span	0	1	2	3	L/150
2000	9.31	9.95	9.95	9.95	8.48
2250	7.26	7.86	7.86	7.86	5.95
2500	5.82	6.37	6.37	6.37	4.34
2750	4.76	5.26	5.26	5.26	3.26
3000	3.97	4.42	4.42	4.42	2.51
3250	3.36	3.77	3.77	3.77	1.98
3500	2.88	3.25	3.25	3.25	1.58
3750	2.49	2.83	2.83	2.83	1.29
4000	2.18	2.49	2.49	2.49	1.06
4250	1.92	2.20	2.20	2.20	0.88
4500	1.71	1.97	1.97	1.97	0.74
4750	1.52	1.76	1.76	1.76	0.63
5000	1.37	1.59	1.59	1.59	0.54
5250	1.24	1.44	1.44	1.44	0.47
5500	1.12	1.31	1.32	1.32	0.41
5750	1.03	1.19	1.20	1.20	0.36
6000	0.94	1.09	1.11	1.11	0.31
6250	0.86	1.01	1.02	1.02	0.28
6500	0.80	0.93	0.94	0.94	0.25
6750	0.74	0.86	0.87	0.87	0.22
7000	0.68	0.80	0.81	0.81	0.20
7500	0.59	0.69	0.71	0.71	0.16
8000	0.52	0.61	0.62	0.62	0.13

#### LEGEND

--- Values below the dotted line are outside the "20D" guide for bridging requirements.

**7.6** Values in **bold type** require High Strength bolts (Grade 8.8)

For low restraint claddings reduce capacity up to 10%

For low restraint claddings reduce capacity up to 20%

For low restraint claddings reduce capacity over 20%  
In these situations, refer to software.

1 Single number for bridging refers to the number of rows of bridging per span.

2 1 2 Multiple number for bridging refers to the number of rows of bridging in end and inner spans. (e.g. 2 in end spans, 1 in inner spans).



## 1 SPAN - OUTWARD CAPACITY

C/Z10010					C/Z10012					C/Z10015				
Bridging Span	0	1	2	3	Bridging Span	0	1	2	3	Bridging Span	0	1	2	3
2000	4.24	4.50	4.50	4.50	2000	4.99	5.46	5.46	5.46	2000	6.38	7.11	7.11	7.11
2250	3.03	3.56	3.56	3.56	2250	3.63	4.31	4.31	4.31	2250	4.74	5.62	5.62	5.62
2500	2.17	2.88	2.88	2.88	2500	2.65	3.50	3.50	3.50	2500	3.57	4.55	4.55	4.55
2750	1.55	2.38	2.38	2.38	2750	1.95	2.89	2.89	2.89	2750	2.69	3.71	3.76	3.76
3000	1.14	2.00	2.00	2.00	3000	1.45	2.42	2.43	2.43	3000	2.00	3.04	3.16	3.16
3250	0.87	1.70	1.70	1.70	3250	1.11	1.99	2.07	2.07	3250	1.51	2.51	2.69	2.69
3500	0.68	1.40	1.47	1.47	3500	0.86	1.65	1.78	1.78	3500	1.17	2.10	2.32	2.32
3750	0.54	1.15	1.28	1.28	3750	0.67	1.37	1.55	1.55	3750	0.92	1.77	2.02	2.02
4000	0.43	0.95	1.13	1.13	4000	0.53	1.14	1.37	1.37	4000	0.73	1.50	1.76	1.78
4250		0.79	1.00	1.00	4250	0.43	0.96	1.21	1.21	4250	0.59	1.27	1.53	1.58
4500		0.65	0.89	0.89	4500		0.80	1.07	1.08	4500	0.48	1.09	1.34	1.41
4750		0.53	0.80	0.80	4750		0.67	0.93	0.97	4750	0.40	0.93	1.18	1.26
5000		0.45	0.70	0.72	5000		0.56	0.82	0.87	5000		0.78	1.04	1.14
5250			0.61	0.65	5250		0.48	0.72	0.79	5250		0.66	0.93	1.02
5500			0.54	0.60	5500		0.41	0.64	0.72	5500		0.55	0.82	0.92
5750			0.47	0.55	5750			0.56	0.66	5750		0.47	0.74	0.83
6000			0.41	0.50	6000			0.50	0.60	6000		0.41	0.66	0.75
6250				0.46	6250			0.44	0.54	6250			0.59	0.69
6500				0.42	6500				0.49	6500			0.53	0.62
6750					6750				0.45	6750			0.47	0.57
7000					7000				0.41	7000			0.42	0.52
7500					7500					7500				0.44
8000					8000					8000				

C/Z10019				
Bridging Span	0	1	2	3
2000	8.68	9.95	9.95	9.95
2250	6.41	7.86	7.86	7.86
2500	4.81	6.36	6.37	6.37
2750	3.66	5.12	5.26	5.26
3000	2.78	4.18	4.42	4.42
3250	2.10	3.45	3.77	3.77
3500	1.62	2.87	3.25	3.25
3750	1.27	2.41	2.81	2.83
4000	1.02	2.04	2.43	2.49
4250	0.83	1.73	2.11	2.20
4500	0.69	1.47	1.84	1.97
4750	0.58	1.26	1.62	1.76
5000	0.49	1.08	1.43	1.58
5250	0.42	0.92	1.26	1.42
5500		0.78	1.12	1.27
5750		0.66	1.00	1.15
6000		0.57	0.89	1.04
6250		0.49	0.80	0.94
6500		0.42	0.71	0.86
6750			0.64	0.78
7000			0.58	0.71
7500			0.47	0.60
8000				0.50

**LEGEND**

--- Values below the dotted line are outside the "20D" guide for bridging requirements.

**7.6** Values in **bold type** require High Strength bolts (Grade 8.8)

 For low restraint claddings reduce capacity up to 10%

 For low restraint claddings reduce capacity up to 20%

 For low restraint claddings reduce capacity over 20%  
In these situations, refer to software.

1 Single number for bridging refers to the number of rows of bridging per span.

2 1 2 Multiple number for bridging refers to the number of rows of bridging in end and inner spans. (e.g. 2 in end spans, 1 in inner spans).

## 1 SPAN - INWARD CAPACITY

Bridging Span	SC/SZ15010					L/150	Bridging Span	SC/SZ15012					L/150	Bridging Span	SC/SZ15015					L/150
	0	1	2	3	0			1	2	3	0	1			2	3				
2000	6.81	6.81	6.81	6.81	12.3	2000	10.5	10.5	10.5	10.5	15.5	2000	13.5	13.5	13.5	13.5	19.7			
2250	6.05	6.05	6.05	6.05	8.63	2250	8.30	8.30	8.30	8.30	10.9	2250	10.7	10.7	10.7	10.7	13.9			
2500	5.43	5.43	5.43	5.43	6.29	2500	6.72	6.72	6.72	6.72	7.95	2500	8.63	8.63	8.63	8.63	10.1			
2750	4.51	4.51	4.51	4.51	4.73	2750	5.56	5.56	5.56	5.56	5.97	2750	7.13	7.13	7.13	7.13	7.59			
3000	3.79	3.79	3.79	3.79	3.64	3000	4.67	4.67	4.67	4.67	4.60	3000	5.99	5.99	5.99	5.99	5.85			
3250	3.23	3.23	3.23	3.23	2.87	3250	3.98	3.98	3.98	3.98	3.62	3250	5.11	5.11	5.11	5.11	4.60			
3500	2.79	2.79	2.79	2.79	2.29	3500	3.43	3.43	3.43	3.43	2.90	3500	4.40	4.40	4.40	4.40	3.68			
3750	2.43	2.43	2.43	2.43	1.87	3750	2.99	2.99	2.99	2.99	2.35	3750	3.84	3.84	3.84	3.84	2.99			
4000	2.13	2.13	2.13	2.13	1.54	4000	2.63	2.63	2.63	2.63	1.94	4000	3.37	3.37	3.37	3.37	2.47			
4250	1.89	1.89	1.89	1.89	1.28	4250	2.33	2.33	2.33	2.33	1.62	4250	2.97	2.99	2.99	2.99	2.06			
4500	1.69	1.69	1.69	1.69	1.08	4500	2.08	2.08	2.08	2.08	1.36	4500	2.63	2.66	2.66	2.66	1.73			
4750	1.51	1.51	1.51	1.51	0.92	4750	1.86	1.86	1.86	1.86	1.16	4750	2.35	2.39	2.39	2.39	1.47			
5000	1.37	1.37	1.37	1.37	0.79	5000	1.68	1.68	1.68	1.68	0.99	5000	2.11	2.16	2.16	2.16	1.26			
5250	1.24	1.24	1.24	1.24	0.68	5250	1.53	1.53	1.53	1.53	0.86	5250	1.90	1.96	1.96	1.96	1.09			
5500	1.13	1.13	1.13	1.13	0.59	5500	1.39	1.39	1.39	1.39	0.75	5500	1.72	1.78	1.78	1.78	0.95			
5750	1.03	1.03	1.03	1.03	0.52	5750	1.27	1.27	1.27	1.27	0.65	5750	1.57	1.63	1.63	1.63	0.83			
6000	0.95	0.95	0.95	0.95	0.46	6000	1.17	1.17	1.17	1.17	0.58	6000	1.44	1.50	1.50	1.50	0.73			
6250	0.87	0.87	0.87	0.87	0.40	6250	1.08	1.08	1.08	1.08	0.51	6250	1.32	1.38	1.38	1.38	0.65			
6500	0.81	0.81	0.81	0.81	0.36	6500	1.00	1.00	1.00	1.00	0.45	6500	1.22	1.28	1.28	1.28	0.58			
6750	0.75	0.75	0.75	0.75	0.32	6750	0.92	0.92	0.92	0.92	0.40	6750	1.12	1.18	1.18	1.18	0.51			
7000	0.70	0.70	0.70	0.70	0.29	7000	0.86	0.86	0.86	0.86	0.36	7000	1.04	1.10	1.10	1.10	0.46			
7500	0.61	0.61	0.61	0.61	0.23	7500	0.75	0.75	0.75	0.75	0.29	7500	0.90	0.96	0.96	0.96	0.37			
8000	0.53	0.53	0.53	0.53	0.19	8000	0.66	0.66	0.66	0.66	0.24	8000	0.79	0.84	0.84	0.84	0.31			
8500	0.47	0.47	0.47	0.47	0.16	8500	0.58	0.58	0.58	0.58	0.20	8500	0.69	0.75	0.75	0.75	0.26			
9000	0.42	0.42	0.42	0.42	0.14	9000	0.52	0.52	0.52	0.52	0.17	9000	0.62	0.67	0.67	0.67	0.22			
9500						9500	0.47	0.47	0.47	0.47	0.15	9500	0.55	0.60	0.60	0.60	0.18			
10000						10000	0.42	0.42	0.42	0.42	0.12	10000	0.49	0.54	0.54	0.54	0.16			

Bridging Span	SC/SZ15019					L/150	Bridging Span	SC/SZ15024					L/150
	0	1	2	3	0			1	2	3			
2000	18.3	18.7	18.7	18.7	25.2	2000							
2250	14.2	14.8	14.8	14.8	17.7	2250	17.9	22.6					
2500	11.3	12.0	12.0	12.0	12.9	2500	14.2	16.4	16.4	16.4	16.5		
2750	9.19	9.91	9.91	9.91	9.68	2750	11.5	13.5	13.5	13.5	12.4		
3000	7.62	8.33	8.33	8.33	7.46	3000	9.47	11.3	11.4	11.4	9.52		
3250	6.41	7.10	7.10	7.10	5.86	3250	7.94	9.62	9.70	9.70	7.49		
3500	5.47	6.12	6.12	6.12	4.70	3500	6.73	8.25	8.36	8.36	6.00		
3750	4.71	5.33	5.33	5.33	3.82	3750	5.77	7.16	7.29	7.29	4.88		
4000	4.10	4.68	4.68	4.69	3.15	4000	5.00	6.27	6.40	6.40	4.02		
4250	3.60	4.15	4.15	4.15	2.62	4250	4.37	5.53	5.67	5.67	3.35		
4500	3.19	3.70	3.70	3.70	2.21	4500	3.85	4.92	5.06	5.06	2.82		
4750	2.84	3.32	3.32	3.32	1.88	4750	3.42	4.40	4.54	4.54	2.40		
5000	2.54	3.00	3.00	3.00	1.61	5000	3.05	3.95	4.09	4.10	2.06		
5250	2.29	2.72	2.72	2.72	1.39	5250	2.74	3.57	3.70	3.72	1.78		
5500	2.08	2.48	2.48	2.48	1.21	5500	2.48	3.23	3.36	3.39	1.55		
5750	1.89	2.27	2.27	2.27	1.06	5750	2.25	2.94	3.07	3.10	1.35		
6000	1.73	2.08	2.08	2.08	0.93	6000	2.05	2.69	2.81	2.85	1.19		
6250	1.58	1.92	1.92	1.92	0.83	6250	1.87	2.47	2.58	2.62	1.05		
6500	1.46	1.77	1.77	1.77	0.73	6500	1.72	2.27	2.38	2.42	0.94		
6750	1.34	1.64	1.65	1.65	0.66	6750	1.58	2.10	2.21	2.24	0.84		
7000	1.25	1.53	1.53	1.53	0.59	7000	1.46	1.94	2.05	2.08	0.75		
7500	1.08	1.33	1.33	1.33	0.48	7500	1.26	1.68	1.78	1.80	0.61		
8000	0.94	1.16	1.17	1.17	0.39	8000	1.10	1.47	1.56	1.58	0.50		
8500	0.83	1.03	1.04	1.04	0.33	8500	0.96	1.29	1.37	1.39	0.42		
9000	0.73	0.92	0.93	0.93	0.28	9000	0.85	1.15	1.22	1.24	0.35		
9500	0.65	0.82	0.83	0.83	0.24	9500	0.76	1.02	1.09	1.11	0.30		
10000	0.59	0.74	0.75	0.75	0.20	10000	0.68	0.92	0.98	1.00	0.26		

### LEGEND

--- Values below the dotted line are outside the "20D" guide for bridging requirements.

**7.6** Values in **bold type** require High Strength bolts (Grade 8.8)

For low restraint claddings reduce capacity up to 10%

For low restraint claddings reduce capacity up to 20%

For low restraint claddings reduce capacity over 20%  
In these situations, refer to software.

1 Single number for bridging refers to the number of rows of bridging per span.

2 1 2 Multiple number for bridging refers to the number of rows of bridging in end and inner spans. (e.g. 2 in end spans, 1 in inner spans).

## 1 SPAN - OUTWARD CAPACITY

Bridging Span	SC/SZ15010				Bridging Span	SC/SZ15012				Bridging Span	SC/SZ15015			
	0	1	2	3		0	1	2	3		0	1	2	3
2000	6.81	6.81	6.81	6.81	2000	10.5	10.5	10.5	10.5	2000	13.5	13.5	13.5	13.5
2250	6.05	6.05	6.05	6.05	2250	8.18	8.30	8.30	8.30	2250	10.3	10.7	10.7	10.7
2500	5.05	5.43	5.43	5.43	2500	6.36	6.72	6.72	6.72	2500	7.98	8.63	8.63	8.63
2750	<b>3.83</b>	4.51	4.51	4.51	2750	4.96	5.56	5.56	5.56	2750	6.17	7.13	7.13	7.13
3000	<b>2.88</b>	3.79	3.79	3.79	3000	<b>3.81</b>	4.67	4.67	4.67	3000	<b>4.74</b>	5.99	5.99	5.99
3250	<b>2.18</b>	3.23	3.23	3.23	3250	<b>2.91</b>	3.98	3.98	3.98	3250	<b>3.66</b>	5.11	5.11	5.11
3500	<b>1.65</b>	2.79	2.79	2.79	3500	<b>2.24</b>	3.43	3.43	3.43	3500	<b>2.86</b>	4.40	4.40	4.40
3750	<b>1.27</b>	2.42	2.43	2.43	3750	<b>1.73</b>	2.99	2.99	2.99	3750	<b>2.26</b>	3.80	3.84	3.84
4000	<b>1.00</b>	2.08	2.13	2.13	4000	<b>1.36</b>	2.59	2.63	2.63	4000	<b>1.77</b>	3.27	3.37	3.37
4250	<b>0.80</b>	1.79	1.89	1.89	4250	<b>1.09</b>	2.24	2.33	2.33	4250	<b>1.41</b>	2.82	2.99	2.99
4500	<b>0.65</b>	1.54	1.69	1.69	4500	<b>0.88</b>	1.95	2.08	2.08	4500	<b>1.14</b>	2.45	2.66	2.66
4750	<b>0.53</b>	1.32	1.51	1.51	4750	<b>0.72</b>	1.70	1.86	1.86	4750	<b>0.93</b>	2.13	2.39	2.39
5000	<b>0.44</b>	1.12	1.37	1.37	5000	<b>0.59</b>	1.47	1.68	1.68	5000	<b>0.77</b>	1.83	2.16	2.16
5250		0.95	1.24	1.24	5250	<b>0.49</b>	1.27	1.53	1.53	5250	<b>0.64</b>	1.58	1.96	1.96
5500		0.81	1.13	1.13	5500	<b>0.41</b>	1.08	1.39	1.39	5500	<b>0.54</b>	1.36	1.78	1.78
5750		0.69	1.02	1.03	5750		0.93	1.27	1.27	5750	<b>0.46</b>	1.18	1.61	1.63
6000		<b>0.59</b>	0.92	0.95	6000		<b>0.80</b>	1.15	1.17	6000		<b>1.02</b>	1.45	1.50
6250		0.50	0.84	0.87	6250		0.69	1.05	1.08	6250		0.89	1.32	1.38
6500		0.44	0.76	0.81	6500		0.60	0.95	1.00	6500		0.78	1.20	1.28
6750			0.69	0.75	6750		0.52	0.87	0.92	6750		0.68	1.09	1.18
7000			0.62	0.70	7000		0.45	0.79	0.86	7000		0.59	1.00	1.10
7500			0.50	0.60	7500			0.66	0.75	7500		0.45	0.82	0.95
8000			0.40	0.52	8000			0.54	0.64	8000			0.67	0.81
8500				0.44	8500			0.44	0.56	8500			0.55	0.70
9000					9000				0.48	9000			0.46	0.61
9500					9500				0.42	9500				0.52
10000					10000					10000				0.45

Bridging Span	SC/SZ15019				Bridging Span	SC/SZ15024			
	0	1	2	3		0	1	2	3
2000	18.0	18.7	18.7	18.7	2000				
2250	13.7	14.8	14.8	14.8	2250	18.1			
2500	10.5	12.0	12.0	12.0	2500	13.9	16.3	16.4	16.4
2750	8.12	9.91	9.91	9.91	2750	10.8	13.3	13.5	13.5
3000	6.28	8.33	8.33	8.33	3000	8.45	11.1	11.4	11.4
3250	<b>4.89</b>	7.00	7.10	7.10	3250	<b>6.59</b>	9.30	9.70	9.70
3500	<b>3.85</b>	5.94	6.12	6.12	3500	<b>5.18</b>	7.90	8.36	8.36
3750	<b>3.01</b>	5.08	5.33	5.33	3750	<b>4.11</b>	6.77	7.26	7.29
4000	<b>2.37</b>	4.37	4.69	4.69	4000	<b>3.27</b>	5.79	6.34	6.40
4250	<b>1.90</b>	3.76	4.15	4.15	4250	<b>2.63</b>	4.97	5.57	5.67
4500	<b>1.54</b>	3.25	3.70	3.70	4500	<b>2.15</b>	4.30	4.92	5.06
4750	<b>1.26</b>	2.81	3.30	3.32	4750	<b>1.77</b>	3.73	4.38	4.54
5000	<b>1.05</b>	2.43	2.95	3.00	5000	<b>1.48</b>	3.24	3.91	4.08
5250	<b>0.88</b>	2.10	2.64	2.72	5250	<b>1.25</b>	2.83	3.51	3.68
5500	<b>0.75</b>	1.82	2.38	2.48	5500	<b>1.06</b>	2.47	3.17	3.33
5750	<b>0.64</b>	1.58	2.15	2.27	5750	<b>0.92</b>	2.15	2.86	3.03
6000	<b>0.55</b>	<b>1.38</b>	1.95	2.08	6000	<b>0.79</b>	<b>1.87</b>	2.58	2.76
6250	<b>0.48</b>	1.20	1.76	1.90	6250	<b>0.69</b>	1.63	2.33	2.53
6500	<b>0.42</b>	1.05	1.59	1.74	6500	<b>0.61</b>	1.43	2.11	2.32
6750		0.91	1.45	1.60	6750	<b>0.54</b>	1.25	1.91	2.13
7000		0.79	1.31	1.48	7000	<b>0.48</b>	1.10	1.74	1.97
7500		0.61	1.08	1.26	7500		0.86	1.45	1.68
8000		0.48	0.89	1.09	8000		0.67	1.21	1.43
8500			0.74	0.93	8500		0.54	1.00	1.23
9000			0.61	0.80	9000		0.44	0.83	1.06
9500			0.51	0.69	9500			0.70	0.92
10000			0.43	0.60	10000			0.58	0.80

### LEGEND

--- Values below the dotted line are outside the "20D" guide for bridging requirements.

**7.6** Values in **bold type** require High Strength bolts (Grade 8.8)

 For low restraint claddings reduce capacity up to 10%

 For low restraint claddings reduce capacity up to 20%

 For low restraint claddings reduce capacity over 20%  
In these situations, refer to software.

1 Single number for bridging refers to the number of rows of bridging per span.

2 1 2 Multiple number for bridging refers to the number of rows of bridging in end and inner spans. (e.g. 2 in end spans, 1 in inner spans).

## 1 SPAN - INWARD CAPACITY

Bridging Span	SC/SZ20012					L/150	Bridging Span	SC/SZ20015					L/150	Bridging Span	SC/SZ20019					L/150
	0	1	2	3	0			1	2	3	0	1			2	3				
3000	5.76	5.76	5.76	5.76	9.76	3000	8.84	8.84	8.84	8.84	12.6	3000	12.2	12.7	12.7	12.7	16.5			
3250	5.32	5.32	5.32	5.32	7.68	3250	7.53	7.53	7.53	7.53	9.88	3250	10.2	10.8	10.8	10.8	13.0			
3500	4.93	4.93	4.93	4.93	6.15	3500	6.50	6.50	6.50	6.50	7.91	3500	8.69	9.31	9.31	9.32	10.4			
3750	4.40	4.40	4.40	4.40	5.00	3750	5.66	5.66	5.66	5.66	6.43	3750	7.46	8.11	8.11	8.11	8.45			
4000	3.87	3.87	3.87	3.87	4.12	4000	4.95	4.97	4.97	4.97	5.30	4000	6.46	7.13	7.13	7.13	6.96			
4250	3.43	3.43	3.43	3.43	3.43	4250	4.37	4.41	4.41	4.41	4.42	4250	5.64	6.32	6.32	6.32	5.81			
4500	3.06	3.06	3.06	3.06	2.89	4500	3.88	3.93	3.93	3.93	3.72	4500	4.96	5.63	5.63	5.64	4.89			
4750	2.74	2.74	2.74	2.74	2.46	4750	3.47	3.53	3.53	3.53	3.17	4750	4.40	5.06	5.06	5.06	4.16			
5000	2.47	2.47	2.47	2.47	2.11	5000	3.12	3.18	3.18	3.18	2.71	5000	3.93	4.56	4.56	4.56	3.57			
5250	2.24	2.24	2.24	2.24	1.82	5250	2.82	2.89	2.89	2.89	2.34	5250	3.52	4.14	4.14	4.14	3.08			
5500	2.04	2.05	2.05	2.05	1.58	5500	2.56	2.63	2.63	2.63	2.04	5500	3.18	3.77	3.77	3.77	2.68			
5750	1.86	1.87	1.87	1.87	1.39	5750	2.34	2.41	2.41	2.41	1.78	5750	2.88	3.45	3.45	3.45	2.35			
6000	1.71	1.72	1.72	1.72	1.22	6000	2.14	2.21	2.21	2.21	1.57	6000	2.62	3.17	3.17	3.17	2.06			
6250	1.57	1.58	1.58	1.58	1.08	6250	1.97	2.04	2.04	2.04	1.39	6250	2.40	2.92	2.92	2.92	1.83			
6500	1.45	1.46	1.46	1.46	0.96	6500	1.82	1.88	1.88	1.88	1.24	6500	2.20	2.70	2.70	2.70	1.62			
6750	1.34	1.36	1.36	1.36	0.86	6750	1.68	1.75	1.75	1.75	1.10	6750	2.03	2.50	2.50	2.50	1.45			
7000	1.25	1.26	1.26	1.26	0.77	7000	1.56	1.62	1.62	1.62	0.99	7000	1.87	2.33	2.33	2.33	1.30			
7500	1.08	1.10	1.10	1.10	0.63	7500	1.34	1.42	1.42	1.42	0.80	7500	1.61	2.03	2.03	2.03	1.06			
8000	0.95	0.97	0.97	0.97	0.52	8000	1.17	1.24	1.24	1.24	0.66	8000	1.40	1.78	1.78	1.78	0.87			
8500	0.84	0.86	0.86	0.86	0.43	8500	1.03	1.10	1.10	1.10	0.55	8500	1.23	1.58	1.58	1.58	0.73			
9000	0.75	0.76	0.76	0.76	0.36	9000	0.91	0.98	0.98	0.98	0.47	9000	1.08	1.41	1.41	1.41	0.61			
9500	0.67	0.69	0.69	0.69	0.31	9500	0.81	0.88	0.88	0.88	0.40	9500	0.96	1.26	1.26	1.26	0.52			
10000	0.60	0.62	0.62	0.62	0.26	10000	0.73	0.80	0.80	0.80	0.34	10000	0.86	1.14	1.14	1.14	0.45			
10500	0.54	0.56	0.56	0.56	0.23	10500	0.66	0.72	0.72	0.72	0.29	10500	0.77	1.03	1.04	1.04	0.39			
11000	0.49	0.51	0.51	0.51	0.20	11000	0.60	0.66	0.66	0.66	0.26	11000	0.70	0.94	0.94	0.94	0.34			
11500	0.45	0.47	0.47	0.47	0.17	11500	0.54	0.60	0.60	0.60	0.22	11500	0.64	0.86	0.86	0.86	0.29			
12000	0.41	0.43	0.43	0.43	0.15	12000	0.50	0.55	0.55	0.55	0.20	12000	0.58	0.78	0.79	0.79	0.26			

Bridging Span	SC/SZ20024				
	0	1	2	3	L/150
3000	15.3	17.5	17.5	17.5	21.1
3250	12.7	14.9	14.9	14.9	16.6
3500	10.7	12.9	12.9	12.8	13.3
3750	9.09	11.2	11.2	11.2	10.8
4000	7.83	9.84	9.84	9.84	8.91
4250	6.81	8.72	8.72	8.72	7.43
4500	5.97	7.77	7.77	7.77	6.26
4750	5.27	6.98	6.98	6.98	5.32
5000	4.69	6.30	6.30	6.30	4.56
5250	4.18	5.70	5.71	5.71	3.94
5500	3.75	5.18	5.20	5.20	3.43
5750	3.38	4.72	4.76	4.76	3.00
6000	3.06	4.32	4.37	4.37	2.64
6250	2.79	3.97	4.03	4.03	2.34
6500	2.55	3.65	3.73	3.73	2.08
6750	2.33	3.38	3.46	3.46	1.85
7000	2.14	3.13	3.21	3.21	1.66
7500	1.83	2.71	2.80	2.80	1.35
8000	1.58	2.37	2.46	2.46	1.11
8500	1.37	2.08	2.18	2.18	0.93
9000	1.21	1.84	1.94	1.94	0.78
9500	1.07	1.64	1.74	1.74	0.67
10000	0.95	1.47	1.56	1.57	0.57
10500	0.85	1.32	1.41	1.43	0.49
11000	0.77	1.19	1.28	1.30	0.43
11500	0.70	1.09	1.17	1.19	0.38
12000	0.63	0.99	1.07	1.09	0.33

### LEGEND

--- Values below the dotted line are outside the "20D" guide for bridging requirements.

**7.6** Values in **bold type** require High Strength bolts (Grade 8.8)

For low restraint claddings reduce capacity up to 10%

For low restraint claddings reduce capacity up to 20%

For low restraint claddings reduce capacity over 20%  
In these situations, refer to software.

1 Single number for bridging refers to the number of rows of bridging per span.

2 1 2 Multiple number for bridging refers to the number of rows of bridging in end and inner spans. (e.g. 2 in end spans, 1 in inner spans).

## 1 SPAN - OUTWARD CAPACITY

Bridging Span	SC/SZ20012				Bridging Span	SC/SZ20015				Bridging Span	SC/SZ20019			
	0	1	2	3		0	1	2	3		0	1	2	3
3000	5.76	5.76	5.76	5.76	3000	8.47	8.84	8.84	8.84	3000	11.9	12.7	12.7	12.7
3250	5.18	5.32	5.32	5.32	3250	6.96	7.53	7.53	7.53	3250	9.61	10.8	10.8	10.8
3500	4.31	4.93	4.93	4.93	3500	5.75	6.50	6.50	6.50	3500	7.71	9.31	9.31	9.31
3750	<b>3.44</b>	4.40	4.40	4.40	3750	<b>4.58</b>	5.66	5.66	5.66	3750	6.19	8.11	8.11	8.11
4000	<b>2.76</b>	3.87	3.87	3.87	4000	<b>3.66</b>	4.97	4.97	4.97	4000	5.01	7.13	7.13	7.13
4250	<b>2.24</b>	3.43	3.43	3.43	4250	<b>2.94</b>	4.41	4.41	4.41	4250	<b>4.08</b>	6.32	6.32	6.32
4500	<b>1.81</b>	3.06	3.06	3.06	4500	<b>2.39</b>	3.93	3.93	3.93	4500	<b>3.31</b>	5.57	5.63	5.64
4750	<b>1.48</b>	2.72	2.74	2.74	4750	<b>1.94</b>	3.53	3.53	3.53	4750	<b>2.70</b>	4.94	5.06	5.06
5000	<b>1.22</b>	2.41	2.47	2.47	5000	<b>1.60</b>	3.14	3.18	3.18	5000	<b>2.22</b>	4.39	4.56	4.56
5250	<b>1.01</b>	2.15	2.24	2.24	5250	<b>1.32</b>	2.79	2.89	2.89	5250	<b>1.84</b>	3.93	4.14	4.14
5500	<b>0.85</b>	1.92	2.05	2.05	5500	<b>1.11</b>	2.50	2.63	2.63	5500	<b>1.55</b>	3.51	3.77	3.77
5750	<b>0.72</b>	1.72	1.87	1.87	5750	<b>0.94</b>	2.24	2.41	2.41	5750	<b>1.31</b>	3.12	3.45	3.45
6000	<b>0.61</b>	1.52	1.72	1.72	6000	<b>0.80</b>	2.01	2.21	2.21	6000	<b>1.12</b>	2.76	3.17	3.17
6250	<b>0.52</b>	1.35	1.58	1.58	6250	<b>0.68</b>	1.80	2.04	2.04	6250	<b>0.96</b>	2.44	2.92	2.92
6500	<b>0.45</b>	1.19	1.46	1.46	6500	<b>0.59</b>	1.59	1.88	1.88	6500	<b>0.83</b>	2.15	2.69	2.70
6750		1.04	1.36	1.36	6750	<b>0.51</b>	1.39	1.75	1.75	6750	<b>0.72</b>	1.90	2.48	2.50
7000		0.92	1.26	1.26	7000	<b>0.44</b>	1.23	1.62	1.62	7000	<b>0.63</b>	1.68	2.28	2.33
7500		0.72	1.07	1.10	7500		0.96	1.39	1.42	7500	<b>0.49</b>	1.33	1.95	2.03
8000		<b>0.57</b>	0.92	0.97	8000		<b>0.75</b>	1.20	1.24	8000		<b>1.05</b>	1.68	1.78
8500		<b>0.45</b>	0.79	0.86	8500		<b>0.59</b>	1.03	1.10	8500		<b>0.83</b>	1.45	1.58
9000			0.68	0.76	9000		<b>0.48</b>	0.90	0.98	9000		<b>0.67</b>	1.23	1.39
9500			0.58	0.68	9500			0.77	0.88	9500		<b>0.54</b>	1.04	1.23
10000			0.49	0.60	10000			0.65	0.78	10000		<b>0.45</b>	0.88	1.09
10500			0.41	0.53	10500			0.55	0.69	10500			0.75	0.98
11000				0.48	11000			0.46	0.62	11000			0.64	0.87
11500				0.42	11500				0.55	11500			0.55	0.77
12000					12000				0.50	12000			0.47	0.68

Bridging Span	SC/SZ20024			
	0	1	2	3
3000	15.8	17.5	17.5	17.5
3250	12.7	14.9	14.9	14.9
3500	10.2	12.9	12.9	12.9
3750	8.28	11.2	11.2	11.2
4000	<b>6.72</b>	9.80	9.84	9.84
4250	<b>5.45</b>	8.56	8.72	8.72
4500	<b>4.43</b>	7.53	7.77	7.77
4750	<b>3.61</b>	6.65	6.98	6.98
5000	<b>2.98</b>	5.91	6.30	6.30
5250	<b>2.49</b>	5.25	5.71	5.71
5500	<b>2.09</b>	4.65	5.20	5.20
5750	<b>1.78</b>	4.12	4.76	4.76
6000	<b>1.52</b>	3.65	4.36	4.37
6250	<b>1.31</b>	3.24	3.98	4.03
6500	<b>1.14</b>	2.88	3.65	3.73
6750	<b>0.99</b>	2.56	3.35	3.46
7000	<b>0.87</b>	2.27	3.08	3.21
7500	<b>0.68</b>	1.80	2.63	2.80
8000	<b>0.55</b>	<b>1.42</b>	2.25	2.44
8500	<b>0.44</b>	1.13	1.91	2.13
9000		0.91	1.63	1.87
9500		0.74	1.39	1.65
10000		0.61	1.19	1.47
10500		0.51	1.01	1.30
11000		0.43	0.87	1.15
11500			0.74	1.01
12000			0.63	0.90

### LEGEND

--- Values below the dotted line are outside the "20D" guide for bridging requirements.

**7.6** Values in **bold type** require High Strength bolts (Grade 8.8)

 For low restraint claddings reduce capacity up to 10%

 For low restraint claddings reduce capacity up to 20%

 For low restraint claddings reduce capacity over 20%  
In these situations, refer to software.

1 Single number for bridging refers to the number of rows of bridging per span.

2 1 2 Multiple number for bridging refers to the number of rows of bridging in end and inner spans. (e.g. 2 in end spans, 1 in inner spans).

## 1 SPAN - INWARD CAPACITY

Bridging Span	SC/SZ25015					L/150	Bridging Span	SC/SZ25019					L/150	Bridging Span	SC/SZ25024					L/150
	0	1	2	3	0			1	2	3	0	1			2	3				
4000	6.15	6.28	6.28	6.28	8.90	4000	8.44	9.00	9.00	9.00	11.6	4000	10.2	12.6	12.6	12.6	15.1			
4250	5.42	5.56	5.56	5.56	7.42	4250	7.36	7.97	7.97	7.97	9.70	4250	8.78	11.1	11.1	11.1	12.6			
4500	4.82	4.96	4.96	4.96	6.25	4500	6.46	7.11	7.11	7.11	8.17	4500	7.64	9.93	9.93	9.93	10.6			
4750	4.32	4.45	4.45	4.45	5.31	4750	5.73	6.38	6.38	6.38	6.95	4750	6.71	8.92	8.91	8.91	9.04			
5000	3.88	4.02	4.02	4.02	4.56	5000	5.11	5.76	5.76	5.76	5.96	5000	5.93	8.05	8.05	8.05	7.75			
5250	3.51	3.65	3.65	3.65	3.94	5250	4.58	5.22	5.22	5.22	5.15	5250	5.27	7.30	7.30	7.30	6.70			
5500	3.18	3.32	3.32	3.32	3.42	5500	4.13	4.76	4.76	4.76	4.48	5500	4.71	6.65	6.65	6.65	5.82			
5750	2.89	3.04	3.04	3.04	3.00	5750	3.74	4.35	4.35	4.35	3.92	5750	4.23	6.08	6.08	6.08	5.10			
6000	2.65	2.79	2.79	2.79	2.64	6000	3.40	4.00	4.00	4.00	3.45	6000	3.82	5.59	5.59	5.59	4.49			
6250	2.43	2.57	2.57	2.57	2.33	6250	3.10	3.69	3.69	3.69	3.05	6250	3.47	5.15	5.15	5.15	3.97			
6500	2.23	2.38	2.38	2.38	2.07	6500	2.84	3.41	3.41	3.41	2.71	6500	3.16	4.76	4.76	4.76	3.53			
6750	2.06	2.21	2.21	2.21	1.85	6750	2.61	3.16	3.16	3.16	2.42	6750	2.89	4.41	4.41	4.41	3.15			
7000	1.91	2.05	2.05	2.05	1.66	7000	2.41	2.94	2.94	2.94	2.17	7000	2.65	4.10	4.11	4.11	2.83			
7500	1.65	1.79	1.79	1.79	1.35	7500	2.07	2.56	2.56	2.56	1.77	7500	2.26	3.55	3.58	3.58	2.30			
8000	1.44	1.57	1.57	1.57	1.11	8000	1.79	2.25	2.25	2.25	1.46	8000	1.94	3.10	3.14	3.14	1.89			
8500	1.27	1.39	1.39	1.39	0.93	8500	1.56	1.99	1.99	1.99	1.21	8500	1.69	2.73	2.78	2.78	1.58			
9000	1.13	1.24	1.24	1.24	0.78	9000	1.38	1.78	1.78	1.78	1.02	9000	1.48	2.43	2.48	2.48	1.33			
9500	1.01	1.11	1.11	1.11	0.66	9500	1.22	1.60	1.60	1.60	0.87	9500	1.31	2.17	2.23	2.23	1.13			
10000	0.90	1.01	1.01	1.01	0.57	10000	1.09	1.44	1.44	1.44	0.75	10000	1.17	1.94	2.01	2.01	0.97			
10500	0.82	0.91	0.91	0.91	0.49	10500	0.98	1.31	1.31	1.31	0.64	10500	1.05	1.75	1.82	1.82	0.84			
11000	0.74	0.83	0.83	0.83	0.43	11000	0.88	1.19	1.19	1.19	0.56	11000	0.94	1.58	1.66	1.66	0.73			
11500	0.67	0.76	0.76	0.76	0.37	11500	0.80	1.09	1.09	1.09	0.49	11500	0.85	1.44	1.52	1.52	0.64			
12000	0.62	0.70	0.70	0.70	0.33	12000	0.72	1.00	1.00	1.00	0.43	12000	0.78	1.31	1.40	1.40	0.56			
12500	0.57	0.64	0.64	0.64	0.29	12500	0.66	0.92	0.92	0.92	0.38	12500	0.71	1.20	1.29	1.29	0.50			
13500	0.48	0.55	0.55	0.55	0.23	13500	0.56	0.79	0.79	0.79	0.30	13500	0.60	1.02	1.10	1.10	0.39			

### LEGEND

--- Values below the dotted line are outside the "20D" guide for bridging requirements.

**7.6** Values in **bold type** require High Strength bolts (Grade 8.8)

 For low restraint claddings reduce capacity up to 10%

 For low restraint claddings reduce capacity up to 20%

 For low restraint claddings reduce capacity over 20%. In these situations, refer to software.

1 Single number for bridging refers to the number of rows of bridging per span.

2 1 2 Multiple number for bridging refers to the number of rows of bridging in end and inner spans. (e.g. 2 in end spans, 1 in inner spans).

## 1 SPAN - OUTWARD CAPACITY

Bridging Span	SC/SZ25015				Bridging Span	SC/SZ25019				Bridging Span	SC/SZ25024			
	0	1	2	3		0	1	2	3		0	1	2	3
4000	5.05	6.28	6.28	6.28	4000	6.59	9.00	9.00	9.00	4000	8.75	12.6	12.6	12.6
4250	4.10	5.56	5.56	5.56	4250	5.31	7.97	7.97	7.97	4250	7.01	11.1	11.1	11.1
4500	3.29	4.96	4.96	4.96	4500	4.26	7.11	7.11	7.11	4500	5.63	9.93	9.93	9.93
4750	2.67	4.45	4.45	4.45	4750	3.46	6.38	6.38	6.38	4750	4.58	8.77	8.92	8.91
5000	2.19	3.97	4.02	4.02	5000	2.84	5.73	5.76	5.76	5000	3.77	7.77	8.05	8.05
5250	1.81	3.56	3.65	3.65	5250	2.35	5.11	5.22	5.22	5250	3.14	6.92	7.30	7.30
5500	1.51	3.20	3.32	3.32	5500	1.97	4.58	4.76	4.76	5500	2.63	6.18	6.65	6.65
5750	1.27	2.89	3.04	3.04	5750	1.66	4.10	4.35	4.35	5750	2.23	5.50	6.08	6.08
6000	1.08	2.62	2.79	2.79	6000	1.41	3.67	4.00	4.00	6000	1.90	4.86	5.59	5.59
6250	0.92	2.35	2.57	2.57	6250	1.21	3.24	3.69	3.69	6250	1.63	4.30	5.15	5.15
6500	0.80	2.11	2.38	2.38	6500	1.05	2.85	3.41	3.41	6500	1.41	3.81	4.76	4.76
6750	0.69	1.89	2.21	2.21	6750	0.91	2.51	3.16	3.16	6750	1.23	3.37	4.42	4.41
7000	0.60	1.69	2.05	2.05	7000	0.79	2.22	2.94	2.94	7000	1.08	2.98	4.06	4.11
7500	0.46	1.33	1.77	1.79	7500	0.61	1.74	2.55	2.56	7500	0.84	2.32	3.46	3.58
8000		1.04	1.53	1.57	8000	0.48	1.35	2.19	2.25	8000	0.66	1.81	2.96	3.14
8500		0.82	1.33	1.39	8500		1.07	1.89	1.99	8500	0.53	1.43	2.55	2.78
9000		0.65	1.16	1.24	9000		0.85	1.63	1.78	9000	0.44	1.15	2.17	2.47
9500		0.53	1.01	1.11	9500		0.69	1.38	1.60	9500		0.93	1.84	2.18
10000		0.43	0.87	0.99	10000		0.57	1.17	1.42	10000		0.76	1.57	1.93
10500			0.75	0.89	10500		0.47	0.99	1.27	10500		0.63	1.33	1.72
11000			0.64	0.80	11000			0.84	1.14	11000		0.53	1.12	1.53
11500			0.55	0.72	11500			0.71	1.01	11500		0.45	0.95	1.35
12000			0.46	0.65	12000			0.60	0.90	12000			0.81	1.19
12500				0.58	12500			0.51	0.79	12500			0.69	1.05
13500				0.46	13500				0.61	13500			0.51	0.82



### LEGEND

- Values below the dotted line are outside the "20D" guide for bridging requirements.
- 7.6** Values in **bold type** require High Strength bolts (Grade 8.8)
- For low restraint claddings reduce capacity up to 10%
- For low restraint claddings reduce capacity up to 20%
- For low restraint claddings reduce capacity over 20%. In these situations, refer to software.
- 1 Single number for bridging refers to the number of rows of bridging per span.
- 2 1 2 Multiple number for bridging refers to the number of rows of bridging in end and inner spans. (e.g. 2 in end spans, 1 in inner spans).

## 1 SPAN - INWARD CAPACITY

Bridging Span	SC/SZ30019					L/150	Bridging Span	SC/SZ30024					L/150	Bridging Span	SC/SZ30030					L/150
	0	1	2	3	0			1	2	3	0	1			2	3				
4000	11.4	11.4	11.4	11.4	20.0	4000	15.1	16.8	16.8	16.8	26.1	4000	18.5				33.2			
4250	10.2	10.5	10.5	10.5	16.7	4250	13.0	14.9	14.9	14.9	21.7	4250	15.8				27.7			
4500	8.96	9.48	9.48	9.48	14.0	4500	11.3	13.3	13.3	13.3	18.3	4500	13.5	18.3	18.3	18.3	23.3			
4750	7.93	8.51	8.51	8.51	11.9	4750	9.83	11.9	11.9	11.9	15.6	4750	11.7	16.4	16.4	16.4	19.8			
5000	7.07	7.68	7.68	7.68	10.2	5000	8.61	10.8	10.8	10.8	13.3	5000	10.1	14.8	14.8	14.8	17.0			
5250	6.34	6.97	6.97	6.97	8.85	5250	7.60	9.76	9.76	9.76	11.5	5250	8.81	13.4	13.4	13.4	14.7			
5500	5.72	6.35	6.35	6.35	7.69	5500	6.76	8.89	8.89	8.89	10.0	5500	7.74	12.2	12.2	12.2	12.8			
5750	5.16	5.81	5.81	5.81	6.73	5750	6.04	8.13	8.13	8.13	8.77	5750	6.85	11.2	11.2	11.2	11.2			
6000	4.68	5.33	5.33	5.33	5.93	6000	5.42	7.47	7.47	7.47	7.72	6000	6.11	10.3	10.3	10.3	9.84			
6250	4.26	4.92	4.92	4.92	5.24	6250	4.89	6.89	6.89	6.89	6.83	6250	5.48	9.48	9.48	9.48	8.71			
6500	3.89	4.54	4.54	4.55	4.66	6500	4.43	6.37	6.37	6.37	6.07	6500	4.94	8.76	8.76	8.76	7.74			
6750	3.55	4.21	4.21	4.21	4.16	6750	4.03	5.90	5.90	5.90	5.42	6750	4.47	8.13	8.13	8.13	6.91			
7000	3.26	3.92	3.92	3.92	3.73	7000	3.68	5.49	5.49	5.49	4.86	7000	4.07	7.54	7.56	7.56	6.20			
7500	2.77	3.41	3.41	3.41	3.03	7500	3.10	4.78	4.78	4.78	3.95	7500	3.41	6.51	6.58	6.58	5.04			
8000	2.38	3.00	3.00	3.00	2.50	8000	2.64	4.20	4.20	4.20	3.26	8000	2.90	5.68	5.79	5.79	4.15			
8500	2.07	2.66	2.66	2.66	2.08	8500	2.28	3.72	3.72	3.72	2.72	8500	2.50	4.98	5.13	5.13	3.46			
9000	1.81	2.37	2.37	2.37	1.76	9000	1.99	3.32	3.32	3.32	2.29	9000	2.17	4.38	4.57	4.57	2.92			
9500	1.60	2.13	2.13	2.13	1.49	9500	1.74	2.97	2.98	2.98	1.95	9500	1.91	3.88	4.10	4.10	2.48			
10000	1.42	1.92	1.92	1.92	1.28	10000	1.54	2.67	2.69	2.69	1.67	10000	1.69	3.45	3.70	3.70	2.13			
10500	1.27	1.74	1.74	1.74	1.11	10500	1.38	2.40	2.44	2.44	1.44	10500	1.50	3.08	3.36	3.36	1.84			
11000	1.14	1.59	1.59	1.59	0.96	11000	1.24	2.18	2.22	2.22	1.25	11000	1.35	2.76	3.06	3.06	1.60			
11500	1.03	1.45	1.45	1.45	0.84	11500	1.11	1.99	2.03	2.03	1.10	11500	1.21	2.49	2.80	2.80	1.40			
12000	0.93	1.33	1.33	1.33	0.74	12000	1.01	1.82	1.87	1.87	0.97	12000	1.10	2.25	2.56	2.57	1.23			
12500	0.85	1.23	1.23	1.23	0.66	12500	0.92	1.66	1.72	1.72	0.85	12500	1.00	2.05	2.34	2.37	1.09			
13500	0.72	1.05	1.05	1.05	0.52	13500	0.77	1.40	1.48	1.48	0.68	13500	0.84	1.71	1.99	2.03	0.86			
14500	0.61	0.91	0.91	0.91	0.42	14500	0.65	1.20	1.28	1.28	0.55	14500	0.71	1.45	1.70	1.76	0.70			
15500	0.52	0.79	0.80	0.80	0.34	15500	0.56	1.04	1.12	1.12	0.45	15500	0.61	1.24	1.46	1.54	0.57			

**LEGEND**





- Values below the dotted line are outside the "20D" guide for bridging requirements.
- 7.6** Values in **bold type** require High Strength bolts (Grade 8.8)
-  For low restraint claddings reduce capacity up to 10%
-  For low restraint claddings reduce capacity up to 20%
-  For low restraint claddings reduce capacity over 20%. In these situations, refer to software.
- 1 Single number for bridging refers to the number of rows of bridging per span.
- 2 1 2 Multiple number for bridging refers to the number of rows of bridging in end and inner spans. (e.g. 2 in end spans, 1 in inner spans).



## 1 SPAN - OUTWARD CAPACITY

Bridging Span	SC/SZ30019				Bridging Span	SC/SZ30024				Bridging Span	SC/SZ30030			
	0	1	2	3		0	1	2	3		0	1	2	3
4000	11.4	11.4	11.4	11.4	4000	16.2	16.8	16.8	16.8	4000				
4250	10.2	10.5	10.5	10.5	4250	14.1	14.9	14.9	14.9	4250	18.5			
4500	8.92	9.48	9.48	9.48	4500	12.0	13.3	13.3	13.3	4500	15.7	18.3	18.3	18.3
4750	7.68	8.51	8.51	8.51	4750	10.2	11.9	11.9	11.9	4750	13.3	16.4	16.4	16.4
5000	6.57	7.68	7.68	7.68	5000	8.60	10.8	10.8	10.8	5000	11.2	14.8	14.8	14.8
5250	5.62	6.97	6.97	6.97	5250	7.25	9.76	9.76	9.76	5250	9.53	13.4	13.4	13.4
5500	4.76	6.35	6.35	6.35	5500	6.17	8.89	8.89	8.89	5500	8.11	12.2	12.2	12.2
5750	4.04	5.81	5.81	5.81	5750	5.26	8.13	8.13	8.13	5750	6.85	11.2	11.2	11.2
6000	3.44	5.33	5.33	5.33	6000	4.49	7.47	7.47	7.47	6000	5.82	10.3	10.3	10.3
6250	2.95	4.92	4.92	4.92	6250	3.84	6.89	6.89	6.89	6250	4.98	9.39	9.48	9.48
6500	2.54	4.54	4.54	4.55	6500	3.30	6.36	6.37	6.37	6500	4.29	8.59	8.76	8.76
6750	2.21	4.19	4.21	4.21	6750	2.85	5.83	5.90	5.90	6750	3.72	7.89	8.13	8.13
7000	1.92	3.86	3.92	3.92	7000	2.48	5.36	5.49	5.49	7000	3.24	7.26	7.56	7.56
7500	1.47	3.30	3.41	3.41	7500	1.91	4.57	4.78	4.78	7500	2.50	6.07	6.58	6.58
8000	1.15	2.84	3.00	3.00	8000	1.50	3.87	4.20	4.20	8000	1.97	5.07	5.79	5.79
8500	0.91	2.41	2.66	2.66	8500	1.19	3.23	3.72	3.72	8500	1.57	4.21	5.13	5.13
9000	0.73	2.02	2.37	2.37	9000	0.96	2.66	3.32	3.32	9000	1.27	3.50	4.55	4.57
9500	0.60	1.70	2.13	2.13	9500	0.78	2.20	2.98	2.98	9500	1.04	2.91	4.03	4.10
10000	0.49	1.40	1.90	1.92	10000	0.65	1.84	2.65	2.69	10000	0.87	2.43	3.59	3.70
10500	0.41	1.17	1.71	1.74	10500	0.54	1.54	2.37	2.44	10500	0.73	2.01	3.21	3.36
11000		0.98	1.53	1.59	11000	0.46	1.28	2.13	2.22	11000	0.62	1.68	2.83	3.06
11500		0.83	1.38	1.45	11500		1.08	1.91	2.03	11500	0.53	1.42	2.50	2.80
12000		0.70	1.25	1.33	12000		0.91	1.69	1.87	12000	0.45	1.20	2.21	2.56
12500		0.60	1.12	1.23	12500		0.78	1.49	1.72	12500		1.03	1.95	2.34
13500		0.44	0.88	1.04	13500		0.58	1.15	1.45	13500		0.77	1.51	1.96
14500			0.68	0.89	14500		0.44	0.89	1.23	14500		0.58	1.18	1.64
15500			0.53	0.76	15500			0.70	1.04	15500		0.45	0.92	1.36

### LEGEND

-  Values below the dotted line are outside the "20D" guide for bridging requirements.
- 7.6** Values in **bold type** require High Strength bolts (Grade 8.8)
-  For low restraint claddings reduce capacity up to 10%
-  For low restraint claddings reduce capacity up to 20%
-  For low restraint claddings reduce capacity over 20%  
In these situations, refer to software.
- 1 Single number for bridging refers to the number of rows of bridging per span.
- 2 1 2 Multiple number for bridging refers to the number of rows of bridging in end and inner spans. (e.g. 2 in end spans, 1 in inner spans).

## 2 SPAN CONTINUOUS - INWARD CAPACITY

Bridging Span	C/Z10010					L/150	Bridging Span	C/Z10012					L/150	Bridging Span	C/Z10015					L/150
	0	1	2	3	0			1	2	3	0	1			2	3				
2000	4.50	4.50	4.50	4.50	10.3	2000	5.46	5.46	5.46	5.46	12.4	2000	7.04	7.11	7.11	7.11	15.8			
2250	3.56	3.56	3.56	3.56	7.21	2250	4.32	4.31	4.31	4.31	8.71	2250	5.50	5.62	5.62	5.62	11.1			
2500	2.88	2.88	2.88	2.88	5.25	2500	3.50	3.50	3.50	3.50	6.35	2500	4.42	4.55	4.55	4.55	8.08			
2750	2.38	2.38	2.38	2.38	3.95	2750	2.89	2.89	2.89	2.89	4.77	2750	3.62	3.76	3.76	3.76	6.07			
3000	2.00	2.00	2.00	2.00	3.04	3000	2.43	2.43	2.43	2.43	3.67	3000	3.02	3.16	3.16	3.16	4.68			
3250	1.70	1.70	1.70	1.70	2.39	3250	2.07	2.07	2.07	2.07	2.89	3250	2.55	2.69	2.69	2.69	3.68			
3500	1.47	1.47	1.47	1.47	1.92	3500	1.78	1.78	1.78	1.78	2.31	3500	2.18	2.32	2.32	2.32	2.95			
3750	1.28	1.28	1.28	1.28	1.56	3750	1.55	1.55	1.55	1.55	1.88	3750	1.89	2.02	2.02	2.02	2.40			
4000	1.13	1.13	1.13	1.13	1.28	4000	1.35	1.37	1.37	1.37	1.55	4000	1.65	1.78	1.78	1.78	1.97			
4250	1.00	1.00	1.00	1.00	1.07	4250	1.18	1.21	1.21	1.21	1.29	4250	1.45	1.58	1.58	1.58	1.65			
4500	0.89	0.89	0.89	0.89	0.90	4500	1.04	1.08	1.08	1.08	1.09	4500	1.28	1.41	1.41	1.41	1.39			
4750	0.80	0.80	0.80	0.80	0.77	4750	0.93	0.97	0.97	0.97	0.93	4750	1.14	1.26	1.26	1.26	1.18			
5000	0.72	0.72	0.72	0.72	0.66	5000	0.83	0.87	0.87	0.87	0.79	5000	1.02	1.14	1.14	1.14	1.01			
5250	0.65	0.65	0.65	0.65	0.57	5250	0.74	0.79	0.79	0.79	0.69	5250	0.92	1.03	1.03	1.03	0.87			
5500	0.58	0.60	0.60	0.60	0.49	5500	0.67	0.72	0.72	0.72	0.60	5500	0.83	0.94	0.94	0.94	0.76			
5750	0.53	0.55	0.54	0.55	0.43	5750	0.61	0.66	0.66	0.66	0.52	5750	0.75	0.86	0.86	0.86	0.66			
6000	0.48	0.50	0.50	0.50	0.38	6000	0.55	0.61	0.61	0.61	0.46	6000	0.69	0.79	0.79	0.79	0.59			
6250	0.43	0.46	0.46	0.46	0.34	6250	0.50	0.56	0.56	0.56	0.41	6250	0.63	0.73	0.73	0.73	0.52			
6500		0.43	0.43	0.43	0.30	6500	0.46	0.52	0.52	0.52	0.36	6500	0.57	0.67	0.67	0.67	0.46			
6750						6750	0.42	0.48	0.48	0.48	0.32	6750	0.53	0.62	0.62	0.62	0.41			
7000						7000		0.45	0.45	0.45	0.29	7000	0.49	0.58	0.58	0.58	0.37			
7250						7250		0.42	0.42	0.42	0.26	7250	0.45	0.53	0.54	0.54	0.33			
7500						7500						7500	0.41	0.49	0.51	0.51	0.30			
7750						7750						7750		0.46	0.47	0.47	0.27			
8000						8000						8000		0.43	0.45	0.45	0.25			

Bridging Span	C/Z10019				
	0	1	2	3	L/150
2000	9.51	9.95	9.95	9.95	20.4
2250	7.40	7.86	7.86	7.86	14.3
2500	5.92	6.37	6.37	6.37	10.4
2750	4.83	5.26	5.26	5.26	7.84
3000	4.02	4.42	4.42	4.42	6.04
3250	3.39	3.77	3.77	3.77	4.75
3500	2.89	3.25	3.25	3.25	3.80
3750	2.50	2.83	2.83	2.83	3.09
4000	2.18	2.49	2.49	2.49	2.55
4250	1.91	2.20	2.20	2.20	2.12
4500	1.69	1.97	1.97	1.97	1.79
4750	1.50	1.76	1.76	1.76	1.52
5000	1.34	1.59	1.59	1.59	1.31
5250	1.21	1.44	1.44	1.44	1.13
5500	1.09	1.32	1.32	1.32	0.98
5750	0.99	1.20	1.20	1.20	0.86
6000	0.90	1.10	1.11	1.11	0.76
6250	0.82	1.01	1.02	1.02	0.67
6500	0.75	0.93	0.94	0.94	0.59
6750	0.69	0.85	0.87	0.87	0.53
7000	0.64	0.79	0.81	0.81	0.48
7250	0.59	0.73	0.76	0.76	0.43
7500	0.54	0.68	0.71	0.71	0.39
7750	0.50	0.63	0.66	0.66	0.35
8000	0.47	0.59	0.62	0.62	0.32

### LEGEND

--- Values below the dotted line are outside the "20D" guide for bridging requirements.

**7.6** Values in **bold type** require High Strength bolts (Grade 8.8)

For low restraint claddings reduce capacity up to 10%

For low restraint claddings reduce capacity up to 20%

For low restraint claddings reduce capacity over 20%  
In these situations, refer to software.

1 Single number for bridging refers to the number of rows of bridging per span.

2 1 2 Multiple number for bridging refers to the number of rows of bridging in end and inner spans. (e.g. 2 in end spans, 1 in inner spans).

## 2 SPAN CONTINUOUS - OUTWARD CAPACITY

Bridging Span	C/Z10010				Bridging Span	C/Z10012				Bridging Span	C/Z10015			
	0	1	2	3		0	1	2	3		0	1	2	3
2000	4.50	4.50	4.50	4.50	2000	5.46	5.46	5.46	5.46	2000	7.11	7.11	7.11	7.11
2250	3.56	3.56	3.56	3.56	2250	4.31	4.31	4.31	4.31	2250	5.62	5.62	5.62	5.62
2500	2.88	2.88	2.88	2.88	2500	3.50	3.50	3.50	3.50	2500	4.55	4.55	4.55	4.55
2750	2.38	2.38	2.38	2.38	2750	2.89	2.89	2.89	2.89	2750	3.76	3.76	3.76	3.76
3000	2.00	2.00	2.00	2.00	3000	2.43	2.43	2.43	2.43	3000	3.12	3.16	3.16	3.16
3250	1.70	1.70	1.70	1.70	3250	2.07	2.07	2.07	2.07	3250	2.60	2.69	2.69	2.69
3500	1.47	1.47	1.47	1.47	3500	1.75	1.78	1.78	1.78	3500	2.20	2.32	2.32	2.32
3750	1.26	1.28	1.28	1.28	3750	1.48	1.55	1.55	1.55	3750	1.87	2.02	2.02	2.02
4000	1.07	1.13	1.13	1.13	4000	1.26	1.37	1.37	1.37	4000	1.60	1.78	1.78	1.78
4250	0.90	1.00	1.00	1.00	4250	1.07	1.21	1.21	1.21	4250	1.38	1.57	1.58	1.58
4500	0.77	0.89	0.89	0.89	4500	0.92	1.08	1.08	1.08	4500	1.20	1.38	1.41	1.41
4750	0.66	0.80	0.80	0.80	4750	0.79	0.97	0.97	0.97	4750	1.05	1.22	1.26	1.26
5000	0.56	0.72	0.72	0.72	5000	0.68	0.87	0.87	0.87	5000	0.92	1.09	1.14	1.14
5250	0.48	0.65	0.65	0.65	5250	0.59	0.77	0.79	0.79	5250	0.80	0.97	1.03	1.03
5500	0.41	0.58	0.60	0.60	5500	0.51	0.68	0.72	0.72	5500	0.71	0.87	0.94	0.94
5750		0.52	0.54	0.55	5750	0.44	0.61	0.66	0.66	5750	0.62	0.78	0.86	0.86
6000		0.46	0.50	0.50	6000		0.55	0.61	0.61	6000	0.54	0.70	0.78	0.79
6250		0.41	0.46	0.46	6250		0.49	0.56	0.56	6250	0.48	0.64	0.72	0.73
6500			0.43	0.43	6500		0.44	0.52	0.52	6500	0.42	0.58	0.65	0.67
6750					6750			0.48	0.48	6750		0.52	0.60	0.62
7000					7000			0.44	0.45	7000		0.48	0.55	0.58
7250					7250			0.40	0.42	7250		0.43	0.51	0.54
7500					7500					7500			0.47	0.50
7750					7750					7750			0.43	0.47
8000					8000					8000			0.40	0.43

Bridging Span	C/Z10019			
	0	1	2	3
2000	9.95	9.95	9.95	9.95
2250	7.86	7.86	7.86	7.86
2500	6.37	6.37	6.37	6.37
2750	5.23	5.26	5.26	5.26
3000	4.30	4.42	4.42	4.42
3250	3.58	3.77	3.77	3.77
3500	3.01	3.25	3.25	3.25
3750	2.56	2.83	2.83	2.83
4000	2.19	2.49	2.49	2.49
4250	1.89	2.18	2.20	2.20
4500	1.63	1.91	1.97	1.97
4750	1.42	1.69	1.76	1.76
5000	1.25	1.50	1.59	1.59
5250	1.10	1.34	1.44	1.44
5500	0.97	1.20	1.32	1.32
5750	0.86	1.07	1.20	1.20
6000	0.76	0.97	1.09	1.11
6250	0.68	0.87	0.99	1.02
6500	0.60	0.79	0.90	0.94
6750	0.54	0.72	0.83	0.87
7000	0.48	0.65	0.76	0.81
7250	0.43	0.59	0.70	0.75
7500		0.54	0.64	0.70
7750		0.50	0.60	0.65
8000		0.45	0.55	0.60

### LEGEND

--- Values below the dotted line are outside the "20D" guide for bridging requirements.

**7.6** Values in **bold type** require High Strength bolts (Grade 8.8)

 For low restraint claddings reduce capacity up to 10%

 For low restraint claddings reduce capacity up to 20%

 For low restraint claddings reduce capacity over 20%  
In these situations, refer to software.

1 Single number for bridging refers to the number of rows of bridging per span.

2 1 2 Multiple number for bridging refers to the number of rows of bridging in end and inner spans. (e.g. 2 in end spans, 1 in inner spans).

## 2 SPAN CONTINUOUS - INWARD CAPACITY

Bridging Span	SC/SZ15010					L/150	Bridging Span	SC/SZ15012					L/150	Bridging Span	SC/SZ15015					L/150
	0	1	2	3	0			1	2	3	0	1			2	3				
2000	4.89	4.89	4.89	4.89	29.6	2000	7.77	7.77	7.77	7.77	37.3	2000								
2250	4.24	4.24	4.24	4.24	20.8	2250	6.63	6.63	6.63	6.63	26.2	2250	10.2	10.2	10.2	10.2	33.3			
2500	3.72	3.72	3.72	3.72	15.1	2500	5.72	5.72	5.72	5.72	19.1	2500	8.58	8.58	8.58	8.58	24.3			
2750	3.29	3.29	3.29	3.28	11.4	2750	4.99	4.98	4.98	4.98	14.4	2750	7.13	7.13	7.13	7.13	18.2			
3000	2.93	2.93	2.93	2.93	8.76	3000	4.38	4.38	4.38	4.38	11.1	3000	5.99	5.99	5.99	5.99	14.1			
3250	2.62	2.62	2.62	2.62	6.89	3250	3.87	3.87	3.87	3.87	8.69	3250	5.11	5.11	5.11	5.11	11.1			
3500	2.36	2.36	2.36	2.36	5.52	3500	3.43	3.43	3.43	3.43	6.96	3500	4.40	4.40	4.40	4.40	8.85			
3750	2.14	2.14	2.14	2.14	4.48	3750	2.99	2.99	2.99	2.99	5.66	3750	3.84	3.84	3.84	3.84	7.20			
4000	1.95	1.95	1.95	1.95	3.70	4000	2.63	2.63	2.63	2.63	4.66	4000	3.35	3.37	3.37	3.37	5.93			
4250	1.78	1.78	1.78	1.78	3.08	4250	2.33	2.33	2.33	2.33	3.89	4250	2.95	2.99	2.99	2.99	4.94			
4500	1.63	1.63	1.63	1.63	2.60	4500	2.08	2.08	2.08	2.08	3.28	4500	2.61	2.66	2.66	2.66	4.17			
4750	1.49	1.49	1.49	1.49	2.21	4750	1.86	1.86	1.86	1.86	2.79	4750	2.31	2.39	2.39	2.39	3.54			
5000	1.36	1.36	1.36	1.36	1.89	5000	1.68	1.68	1.68	1.68	2.39	5000	2.07	2.16	2.16	2.16	3.04			
5250	1.24	1.24	1.24	1.24	1.63	5250	1.53	1.53	1.53	1.53	2.06	5250	1.85	1.96	1.96	1.96	2.62			
5500	1.13	1.13	1.13	1.13	1.42	5500	1.39	1.39	1.39	1.39	1.79	5500	1.67	1.78	1.78	1.78	2.28			
5750	1.03	1.03	1.03	1.03	1.24	5750	1.27	1.27	1.27	1.27	1.57	5750	1.51	1.63	1.63	1.63	2.00			
6000	0.95	0.95	0.95	0.95	1.10	6000	1.16	1.17	1.17	1.17	1.38	6000	1.37	1.50	1.50	1.50	1.76			
6250	0.87	0.87	0.87	0.87	0.97	6250	1.06	1.08	1.08	1.08	1.22	6250	1.25	1.38	1.38	1.38	1.55			
6500	0.80	0.81	0.81	0.81	0.86	6500	0.97	1.00	1.00	1.00	1.09	6500	1.14	1.28	1.28	1.28	1.38			
6750	0.73	0.75	0.75	0.75	0.77	6750	0.90	0.92	0.92	0.92	0.97	6750	1.05	1.18	1.18	1.18	1.23			
7000	0.68	0.70	0.70	0.70	0.69	7000	0.83	0.86	0.86	0.86	0.87	7000	0.96	1.10	1.10	1.10	1.11			
7250	0.63	0.65	0.65	0.65	0.62	7250	0.76	0.80	0.80	0.80	0.78	7250	0.89	1.03	1.03	1.03	1.00			
7500	0.58	0.61	0.61	0.61	0.56	7500	0.70	0.75	0.75	0.75	0.71	7500	0.82	0.96	0.96	0.96	0.90			
7750	0.54	0.57	0.57	0.57	0.51	7750	0.65	0.70	0.70	0.70	0.64	7750	0.76	0.90	0.90	0.90	0.82			
8000	0.50	0.53	0.53	0.53	0.46	8000	0.60	0.66	0.66	0.66	0.58	8000	0.70	0.84	0.84	0.84	0.74			
8250	0.46	0.50	0.50	0.50	0.42	8250	0.56	0.62	0.62	0.62	0.53	8250	0.65	0.79	0.79	0.79	0.68			
8500	0.42	0.47	0.47	0.47	0.39	8500	0.52	0.58	0.58	0.58	0.49	8500	0.60	0.75	0.75	0.75	0.62			
8750		0.45	0.45	0.45	0.35	8750	0.48	0.55	0.55	0.55	0.45	8750	0.56	0.71	0.71	0.71	0.57			

Bridging Span	SC/SZ15019					L/150	Bridging Span	SC/SZ15024					L/150
	0	1	2	3	0			1	2	3			
2000						2000							
2250						2250							
2500	11.6	12.0	12.0	12.0	31.0	2500	14.7				39.6		
2750	9.41	9.91	9.91	9.91	23.3	2750	11.9	13.5	13.5	13.5	29.7		
3000	7.80	8.33	8.33	8.33	17.9	3000	10.0	11.4	11.4	11.4	22.9		
3250	6.55	7.10	7.10	7.10	14.1	3250	8.24	9.70	9.70	9.70	18.0		
3500	5.58	6.12	6.12	6.12	11.3	3500	7.00	8.36	8.36	8.36	14.4		
3750	4.80	5.33	5.33	5.33	9.18	3750	6.01	7.29	7.29	7.29	11.7		
4000	4.16	4.69	4.69	4.68	7.56	4000	5.20	6.40	6.40	6.40	9.66		
4250	3.64	4.15	4.15	4.15	6.31	4250	4.53	5.67	5.67	5.67	8.05		
4500	3.21	3.70	3.70	3.70	5.31	4500	3.98	5.05	5.06	5.06	6.78		
4750	2.85	3.32	3.32	3.32	4.52	4750	3.53	4.52	4.54	4.54	5.77		
5000	2.54	3.00	3.00	3.00	3.87	5000	3.14	4.06	4.10	4.10	4.95		
5250	2.28	2.72	2.72	2.72	3.35	5250	2.81	3.67	3.72	3.72	4.27		
5500	2.05	2.48	2.48	2.48	2.91	5500	2.53	3.34	3.39	3.39	3.72		
5750	1.86	2.27	2.27	2.27	2.55	5750	2.28	3.04	3.10	3.10	3.25		
6000	1.69	2.08	2.08	2.08	2.24	6000	2.07	2.79	2.85	2.85	2.86		
6250	1.54	1.92	1.92	1.92	1.98	6250	1.88	2.56	2.62	2.62	2.53		
6500	1.40	1.77	1.77	1.77	1.76	6500	1.72	2.36	2.43	2.43	2.25		
6750	1.29	1.65	1.65	1.65	1.57	6750	1.58	2.18	2.25	2.25	2.01		
7000	1.18	1.53	1.53	1.53	1.41	7000	1.45	2.02	2.09	2.09	1.80		
7250	1.09	1.42	1.43	1.43	1.27	7250	1.33	1.88	1.94	1.95	1.62		
7500	1.01	1.33	1.33	1.33	1.15	7500	1.23	1.75	1.81	1.82	1.47		
7750	0.93	1.24	1.25	1.25	1.04	7750	1.14	1.63	1.69	1.71	1.33		
8000	0.86	1.16	1.17	1.17	0.95	8000	1.05	1.52	1.58	1.60	1.21		
8250	0.80	1.08	1.10	1.10	0.86	8250	0.98	1.42	1.48	1.51	1.10		
8500	0.74	1.01	1.04	1.04	0.79	8500	0.91	1.33	1.39	1.42	1.01		
8750	0.69	0.95	0.98	0.98	0.72	8750	0.85	1.24	1.31	1.34	0.92		

**LEGEND**

--- Values below the dotted line are outside the "20D" guide for bridging requirements.

**7.6** Values in **bold type** require High Strength bolts (Grade 8.8)

For low restraint claddings reduce capacity up to 10%

For low restraint claddings reduce capacity up to 20%

For low restraint claddings reduce capacity over 20%  
In these situations, refer to software.

1 Single number for bridging refers to the number of rows of bridging per span.

2 1 2 Multiple number for bridging refers to the number of rows of bridging in end and inner spans. (e.g. 2 in end spans, 1 in inner spans).

## 2 SPAN CONTINUOUS - OUTWARD CAPACITY

Bridging Span	SC/SZ15010				Bridging Span	SC/SZ15012				Bridging Span	SC/SZ15015			
	0	1	2	3		0	1	2	3		0	1	2	3
2000	4.89	4.89	4.89	4.89	2000	7.77	7.77	7.77	7.77	2000				
2250	4.24	4.24	4.24	4.24	2250	6.63	6.63	6.63	6.63	2250	10.2	10.2	10.2	10.2
2500	3.72	3.72	3.72	3.72	2500	5.72	5.72	5.72	5.72	2500	8.58	8.58	8.57	8.58
2750	3.29	3.29	3.29	3.28	2750	4.99	4.98	4.98	4.98	2750	7.13	7.13	7.13	7.13
3000	2.93	2.93	2.93	2.93	3000	4.38	4.38	4.38	4.38	3000	5.99	5.99	5.99	5.99
3250	2.62	2.62	2.62	2.62	3250	3.87	3.87	3.87	3.87	3250	5.11	5.11	5.11	5.11
3500	2.36	2.36	2.36	2.36	3500	3.43	3.43	3.43	3.43	3500	4.40	4.40	4.40	4.40
3750	2.14	2.14	2.14	2.14	3750	2.99	2.99	2.99	2.99	3750	3.84	3.84	3.84	3.84
4000	1.95	1.95	1.95	1.95	4000	2.63	2.63	2.63	2.63	4000	3.37	3.37	3.37	3.37
4250	1.78	1.78	1.78	1.78	4250	2.33	2.33	2.33	2.33	4250	2.94	2.99	2.99	2.99
4500	1.63	1.63	1.63	1.63	4500	2.04	2.08	2.08	2.08	4500	2.57	2.66	2.66	2.66
4750	1.44	1.49	1.49	1.49	4750	1.80	1.86	1.86	1.86	4750	2.26	2.39	2.39	2.39
5000	1.27	1.36	1.36	1.36	5000	1.59	1.68	1.68	1.68	5000	2.00	2.16	2.16	2.16
5250	1.11	1.24	1.24	1.24	5250	1.42	1.53	1.53	1.53	5250	1.77	1.96	1.96	1.96
5500	0.97	1.13	1.13	1.13	5500	1.25	1.39	1.39	1.39	5500	1.55	1.78	1.78	1.78
5750	0.84	1.03	1.03	1.03	5750	1.10	1.27	1.27	1.27	5750	1.37	1.63	1.63	1.63
6000	0.73	0.95	0.95	0.95	6000	0.96	1.17	1.17	1.17	6000	1.20	1.49	1.50	1.50
6250	0.64	0.87	0.87	0.87	6250	0.84	1.08	1.08	1.08	6250	1.06	1.36	1.38	1.38
6500	0.56	0.79	0.81	0.81	6500	0.74	0.98	1.00	1.00	6500	0.94	1.24	1.28	1.28
6750	0.49	0.72	0.75	0.75	6750	0.65	0.90	0.92	0.92	6750	0.83	1.13	1.18	1.18
7000	0.43	0.66	0.70	0.70	7000	0.58	0.82	0.86	0.86	7000	0.74	1.04	1.10	1.10
7250		0.60	0.65	0.65	7250	0.51	0.76	0.80	0.80	7250	0.66	0.96	1.03	1.03
7500		0.55	0.61	0.61	7500	0.45	0.70	0.75	0.75	7500	0.59	0.88	0.96	0.96
7750		0.50	0.57	0.57	7750		0.64	0.70	0.70	7750	0.53	0.81	0.90	0.90
8000		0.45	0.53	0.53	8000		0.59	0.66	0.66	8000	0.47	0.74	0.84	0.84
8250		0.41	0.50	0.50	8250		0.54	0.62	0.62	8250	0.42	0.67	0.79	0.79
8500			0.47	0.47	8500		0.49	0.58	0.58	8500		0.62	0.74	0.75
8750			0.44	0.45	8750		0.45	0.55	0.55	8750		0.56	0.69	0.71

Bridging Span	SC/SZ15019				Bridging Span	SC/SZ15024			
	0	1	2	3		0	1	2	3
2000					2000				
2250					2250				
2500	12.0	12.0	12.0	12.0	2500				
2750	<b>9.91</b>	<b>9.91</b>	<b>9.91</b>	<b>9.91</b>	2750	<b>13.4</b>	<b>13.5</b>	<b>13.5</b>	<b>13.5</b>
3000	<b>8.33</b>	<b>8.33</b>	<b>8.33</b>	<b>8.33</b>	3000	<b>11.1</b>	<b>11.4</b>	<b>11.4</b>	<b>11.4</b>
3250	7.09	7.10	7.10	7.10	3250	<b>9.39</b>	<b>9.70</b>	<b>9.70</b>	<b>9.70</b>
3500	6.03	6.12	6.12	6.12	3500	<b>8.00</b>	<b>8.36</b>	<b>8.36</b>	<b>8.36</b>
3750	5.18	5.33	5.33	5.33	3750	<b>6.89</b>	<b>7.29</b>	<b>7.29</b>	<b>7.29</b>
4000	4.49	4.69	4.69	4.69	4000	<b>5.96</b>	<b>6.39</b>	<b>6.40</b>	<b>6.40</b>
4250	3.92	4.15	4.15	4.15	4250	5.16	<b>5.62</b>	<b>5.67</b>	<b>5.67</b>
4500	3.42	3.70	3.70	3.70	4500	4.50	4.98	5.06	5.06
4750	2.99	3.32	3.32	3.32	4750	3.94	4.43	4.54	4.54
5000	2.63	2.99	3.00	3.00	5000	3.47	3.97	4.10	4.10
5250	2.32	2.69	2.72	2.72	5250	3.06	3.57	3.72	3.72
5500	2.04	2.42	2.48	2.48	5500	2.72	3.23	3.38	3.39
5750	1.81	2.20	2.27	2.27	5750	2.42	2.93	3.08	3.10
6000	1.60	2.00	2.08	2.08	6000	2.16	2.66	2.81	2.85
6250	1.42	1.82	1.92	1.92	6250	1.92	2.42	2.58	2.62
6500	1.26	1.66	1.77	1.77	6500	1.71	2.20	2.37	2.43
6750	1.12	1.52	1.65	1.65	6750	1.53	2.01	2.19	2.25
7000	1.01	1.39	1.52	1.53	7000	1.37	1.84	2.02	2.08
7250	0.90	1.27	1.41	1.43	7250	1.23	1.68	1.87	1.93
7500	0.80	1.16	1.31	1.33	7500	1.10	1.54	1.74	1.80
7750	0.72	1.06	1.22	1.25	7750	0.99	1.42	1.62	1.68
8000	0.64	0.98	1.13	1.17	8000	0.90	1.31	1.51	1.57
8250	0.58	0.90	1.06	1.10	8250	0.81	1.20	1.41	1.47
8500	0.52	0.82	0.99	1.04	8500	0.74	1.11	1.32	1.38
8750	0.47	0.76	0.92	0.97	8750	0.67	1.03	1.23	1.29

### LEGEND

--- Values below the dotted line are outside the "20D" guide for bridging requirements.

**7.6** Values in **bold type** require High Strength bolts (Grade 8.8)

For low restraint claddings reduce capacity up to 10%

For low restraint claddings reduce capacity up to 20%

For low restraint claddings reduce capacity over 20%  
In these situations, refer to software.

1 Single number for bridging refers to the number of rows of bridging per span.



2 1 2 Multiple number for bridging refers to the number of rows of bridging in end and inner spans. (e.g. 2 in end spans, 1 in inner spans).

## 2 SPAN CONTINUOUS - INWARD CAPACITY

Bridging Span	SC/SZ20012					L/150	Bridging Span	SC/SZ20015					L/150	Bridging Span	SC/SZ20019					L/150
	0	1	2	3	0			1	2	3	0	1			2	3				
3000	4.08	4.08	4.08	4.08	23.5	3000	6.98	6.98	6.98	6.98	30.2	3000								
3250	3.70	3.70	3.70	3.70	18.5	3250	6.23	6.23	6.23	6.23	23.8	3250								
3500	3.37	3.37	3.37	3.37	14.8	3500	5.59	5.59	5.59	5.59	19.0	3500								
3750	3.08	3.08	3.08	3.08	12.0	3750	5.04	5.04	5.04	5.04	15.5	3750	<b>7.70</b>	<b>7.99</b>	<b>7.99</b>	<b>7.99</b>	20.3			
4000	2.83	2.83	2.83	2.83	9.90	4000	4.57	4.57	4.57	4.57	12.7	4000	<b>6.67</b>	<b>7.09</b>	<b>7.09</b>	<b>7.09</b>	16.7			
4250	2.61	2.61	2.61	2.61	8.26	4250	4.16	4.16	4.16	4.16	10.6	4250	<b>5.82</b>	<b>6.32</b>	<b>6.32</b>	<b>6.32</b>	14.0			
4500	2.41	2.41	2.41	2.41	6.95	4500	3.80	3.80	3.80	3.80	8.95	4500	5.11	<b>5.63</b>	<b>5.64</b>	<b>5.63</b>	11.8			
4750	2.24	2.24	2.24	2.24	5.91	4750	3.45	3.45	3.45	3.45	7.61	4750	4.52	5.06	5.06	5.06	10.00			
5000	2.08	2.08	2.08	2.08	5.07	5000	3.12	3.14	3.14	3.14	6.52	5000	4.02	4.56	4.56	4.56	8.57			
5250	1.94	1.94	1.94	1.94	4.38	5250	2.81	2.87	2.87	2.87	5.64	5250	3.60	4.14	4.14	4.14	7.41			
5500	1.81	1.81	1.81	1.81	3.81	5500	2.55	2.63	2.63	2.63	4.90	5500	3.23	3.77	3.77	3.77	6.44			
5750	1.70	1.70	1.70	1.70	3.33	5750	2.32	2.41	2.41	2.41	4.29	5750	2.92	3.45	3.45	3.45	5.64			
6000	1.59	1.59	1.59	1.59	2.93	6000	2.12	2.21	2.21	2.21	3.78	6000	2.64	3.17	3.17	3.17	4.96			
6250	1.49	1.49	1.49	1.49	2.60	6250	1.94	2.04	2.04	2.04	3.34	6250	2.40	2.92	2.92	2.92	4.39			
6500	1.40	1.40	1.40	1.40	2.31	6500	1.78	1.88	1.88	1.88	2.97	6500	2.19	2.70	2.70	2.70	3.90			
6750	1.31	1.32	1.32	1.32	2.06	6750	1.64	1.75	1.75	1.75	2.65	6750	2.01	2.50	2.50	2.50	3.49			
7000	1.21	1.24	1.24	1.24	1.85	7000	1.51	1.62	1.62	1.62	2.38	7000	1.85	2.33	2.33	2.33	3.12			
7250	1.12	1.16	1.16	1.16	1.66	7250	1.39	1.51	1.51	1.51	2.14	7250	1.70	2.17	2.17	2.17	2.81			
7500	1.03	1.09	1.09	1.09	1.50	7500	1.28	1.42	1.42	1.42	1.93	7500	1.57	2.03	2.03	2.03	2.54			
7750	0.96	1.03	1.03	1.03	1.36	7750	1.19	1.33	1.33	1.33	1.75	7750	1.46	1.90	1.90	1.90	2.30			
8000	0.89	0.97	0.97	0.97	1.24	8000	1.11	1.24	1.24	1.24	1.59	8000	1.35	1.78	1.78	1.78	2.09			
8250	0.83	0.91	0.91	0.91	1.13	8250	1.03	1.17	1.17	1.17	1.45	8250	1.25	1.68	1.68	1.68	1.91			
8500	0.77	0.86	0.86	0.86	1.03	8500	0.96	1.10	1.10	1.10	1.33	8500	1.16	1.58	1.58	1.58	1.75			
8750	0.72	0.81	0.81	0.81	0.95	8750	0.90	1.04	1.04	1.04	1.22	8750	1.08	1.49	1.49	1.49	1.60			

Bridging Span	SC/SZ20024					L/150
	0	1	2	3		
3000						
3250						
3500						
3750	<b>9.61</b>					26.0
4000	<b>8.27</b>					21.4
4250	<b>7.18</b>	<b>8.72</b>	<b>8.71</b>	<b>8.72</b>		17.9
4500	<b>6.28</b>	<b>7.77</b>	<b>7.77</b>	<b>7.77</b>		15.0
4750	<b>5.54</b>	<b>6.98</b>	<b>6.98</b>	<b>6.98</b>		12.8
5000	<b>4.91</b>	<b>6.30</b>	<b>6.30</b>	<b>6.30</b>		11.0
5250	4.38	<b>5.71</b>	<b>5.71</b>	<b>5.71</b>		9.47
5500	3.93	<b>5.20</b>	<b>5.20</b>	<b>5.20</b>		8.24
5750	3.54	<b>4.76</b>	<b>4.76</b>	<b>4.76</b>		7.21
6000	3.20	<b>4.37</b>	<b>4.37</b>	<b>4.37</b>		6.35
6250	2.90	<b>4.03</b>	<b>4.03</b>	<b>4.03</b>		5.62
6500	2.64	<b>3.73</b>	<b>3.73</b>	<b>3.73</b>		4.99
6750	2.41	3.46	3.46	3.46		4.46
7000	2.20	3.21	3.21	3.21		4.00
7250	2.02	3.00	3.00	3.00		3.60
7500	1.86	2.80	2.80	2.80		3.25
7750	1.71	2.62	2.62	2.62		2.95
8000	1.58	2.45	2.46	2.46		2.68
8250	1.47	2.30	2.31	2.31		2.44
8500	1.36	2.16	2.18	2.18		2.23
8750	1.27	2.03	2.06	2.06		2.05

**LEGEND**

- Values below the dotted line are outside the "20D" guide for bridging requirements.
- 7.6** Values in **bold type** require High Strength bolts (Grade 8.8)
-  For low restraint claddings reduce capacity up to 10%
-  For low restraint claddings reduce capacity up to 20%
-  For low restraint claddings reduce capacity over 20%. In these situations, refer to software.
- 1 Single number for bridging refers to the number of rows of bridging per span.
- 2 1 2 Multiple number for bridging refers to the number of rows of bridging in end and inner spans. (e.g. 2 in end spans, 1 in inner spans).

## 2 SPAN CONTINUOUS - OUTWARD CAPACITY

Bridging Span	SC/SZ20012				Bridging Span	SC/SZ20015				Bridging Span	SC/SZ20019			
	0	1	2	3		0	1	2	3		0	1	2	3
3000	4.08	4.08	4.08	4.08	3000	6.98	6.98	6.98	6.98	3000				
3250	3.70	3.70	3.70	3.70	3250	6.23	6.23	6.23	6.23	3250				
3500	3.37	3.37	3.37	3.37	3500	5.59	5.59	5.59	5.59	3500				
3750	3.08	3.08	3.08	3.08	3750	5.04	5.04	5.04	5.04	3750	<b>7.99</b>	<b>7.99</b>	<b>7.99</b>	<b>7.99</b>
4000	2.83	2.83	2.83	2.83	4000	4.57	4.57	4.57	4.57	4000	<b>7.09</b>	<b>7.09</b>	<b>7.09</b>	<b>7.09</b>
4250	2.61	2.61	2.61	2.61	4250	4.16	4.16	4.16	4.16	4250	<b>6.32</b>	<b>6.32</b>	<b>6.32</b>	<b>6.32</b>
4500	2.41	2.41	2.41	2.41	4500	3.80	3.80	3.80	3.80	4500	<b>5.63</b>	<b>5.63</b>	<b>5.63</b>	<b>5.63</b>
4750	2.24	2.24	2.24	2.24	4750	3.45	3.45	3.45	3.45	4750	5.02	5.06	5.06	5.06
5000	2.08	2.08	2.08	2.08	5000	3.14	3.14	3.14	3.14	5000	4.48	4.56	4.56	4.56
5250	1.94	1.94	1.94	1.94	5250	2.87	2.87	2.87	2.87	5250	4.02	4.14	4.14	4.14
5500	1.81	1.81	1.81	1.81	5500	2.59	2.63	2.63	2.63	5500	3.62	3.77	3.77	3.77
5750	1.70	1.70	1.70	1.70	5750	2.33	2.41	2.41	2.41	5750	3.27	3.45	3.45	3.45
6000	1.59	1.59	1.59	1.59	6000	2.11	2.21	2.21	2.21	6000	2.96	3.17	3.17	3.17
6250	1.45	1.49	1.49	1.49	6250	1.91	2.04	2.04	2.04	6250	2.65	2.92	2.92	2.92
6500	1.33	1.40	1.40	1.40	6500	1.74	1.88	1.88	1.88	6500	2.38	2.70	2.70	2.70
6750	1.20	1.32	1.32	1.32	6750	1.59	1.75	1.75	1.75	6750	2.14	2.50	2.50	2.50
7000	1.08	1.24	1.24	1.24	7000	1.43	1.62	1.62	1.62	7000	1.92	2.32	2.33	2.33
7250	0.97	1.16	1.16	1.16	7250	1.28	1.51	1.51	1.51	7250	1.72	2.15	2.17	2.17
7500	0.87	1.09	1.09	1.09	7500	1.15	1.42	1.42	1.42	7500	1.55	1.99	2.03	2.03
7750	0.78	1.02	1.03	1.03	7750	1.03	1.33	1.33	1.33	7750	1.40	1.85	1.90	1.90
8000	0.70	0.95	0.97	0.97	8000	0.93	1.23	1.24	1.24	8000	1.26	1.72	1.78	1.78
8250	0.63	0.88	0.91	0.91	8250	0.83	1.15	1.17	1.17	8250	1.15	1.61	1.68	1.68
8500	0.57	0.82	0.86	0.86	8500	0.75	1.07	1.10	1.10	8500	1.04	1.50	1.58	1.58
8750	0.51	0.77	0.81	0.81	8750	0.68	1.00	1.04	1.04	8750	0.94	1.40	1.49	1.49

Bridging Span	SC/SZ20024			
	0	1	2	3
3000				
3250				
3500				
3750				
4000				
4250	<b>8.66</b>	<b>8.71</b>	<b>8.72</b>	<b>8.72</b>
4500	<b>7.63</b>	<b>7.77</b>	<b>7.77</b>	<b>7.77</b>
4750	<b>6.77</b>	<b>6.98</b>	<b>6.98</b>	<b>6.98</b>
5000	<b>6.03</b>	<b>6.30</b>	<b>6.30</b>	<b>6.30</b>
5250	<b>5.40</b>	<b>5.71</b>	<b>5.71</b>	<b>5.71</b>
5500	<b>4.85</b>	<b>5.20</b>	<b>5.20</b>	<b>5.20</b>
5750	<b>4.34</b>	<b>4.76</b>	<b>4.76</b>	<b>4.76</b>
6000	<b>3.89</b>	<b>4.37</b>	<b>4.37</b>	<b>4.37</b>
6250	3.49	<b>4.03</b>	<b>4.03</b>	<b>4.03</b>
6500	3.13	<b>3.71</b>	<b>3.73</b>	<b>3.73</b>
6750	2.82	3.41	3.46	3.46
7000	2.54	3.14	3.21	3.21
7250	2.30	2.91	3.00	3.00
7500	2.08	2.69	2.80	2.80
7750	1.88	2.50	2.62	2.62
8000	1.70	2.32	2.46	2.46
8250	1.54	2.16	2.31	2.31
8500	1.39	2.01	2.18	2.18
8750	1.26	1.87	2.05	2.06

### LEGEND

--- Values below the dotted line are outside the "20D" guide for bridging requirements.

**7.6** Values in **bold type** require High Strength bolts (Grade 8.8)

For low restraint claddings reduce capacity up to 10%

For low restraint claddings reduce capacity up to 20%

For low restraint claddings reduce capacity over 20%  
In these situations, refer to software.





1 Single number for bridging refers to the number of rows of bridging per span.

2 1 2 Multiple number for bridging refers to the number of rows of bridging in end and inner spans. (e.g. 2 in end spans, 1 in inner spans).

## 2 SPAN CONTINUOUS - INWARD CAPACITY

Bridging Span	SC/SZ25015					L/150	Bridging Span	SC/SZ25019					L/150	Bridging Span	SC/SZ25024					L/150
	0	1	2	3	0			1	2	3	0	1			2	3				
4000	4.38	4.38	4.38	4.38	21.4	4000	<b>7.74</b>	<b>7.74</b>	<b>7.74</b>	<b>7.74</b>	28.0	4000								
4250	4.03	4.03	4.03	4.03	17.8	4250	<b>7.07</b>	<b>7.07</b>	<b>7.07</b>	<b>7.07</b>	23.3	4250								
4500	3.73	3.73	3.73	3.73	15.0	4500	<b>6.47</b>	<b>6.47</b>	<b>6.47</b>	<b>6.47</b>	19.7	4500	<b>8.15</b>					25.6		
4750	3.46	3.46	3.46	3.46	12.8	4750	<b>5.90</b>	<b>5.95</b>	<b>5.95</b>	<b>5.95</b>	16.7	4750	<b>7.15</b>					21.7		
5000	3.22	3.22	3.22	3.22	11.0	5000	<b>5.23</b>	<b>5.48</b>	<b>5.48</b>	<b>5.48</b>	14.3	5000	<b>6.30</b>					18.6		
5250	3.00	3.00	3.00	3.00	9.46	5250	<b>4.67</b>	<b>5.06</b>	<b>5.06</b>	<b>5.06</b>	12.4	5250	<b>5.59</b>	<b>7.30</b>	<b>7.30</b>	<b>7.30</b>		16.1		
5500	2.80	2.80	2.80	2.80	8.23	5500	4.20	<b>4.67</b>	<b>4.67</b>	<b>4.67</b>	10.8	5500	<b>4.98</b>	<b>6.65</b>	<b>6.65</b>	<b>6.65</b>		14.0		
5750	2.62	2.62	2.62	2.62	7.20	5750	3.78	<b>4.30</b>	<b>4.30</b>	<b>4.30</b>	9.42	5750	<b>4.46</b>	<b>6.08</b>	<b>6.08</b>	<b>6.08</b>		12.3		
6000	2.46	2.46	2.46	2.46	6.34	6000	3.43	3.98	3.98	3.98	8.29	6000	<b>4.01</b>	<b>5.59</b>	<b>5.59</b>	<b>5.59</b>		10.8		
6250	2.31	2.31	2.31	2.31	5.61	6250	3.11	3.69	3.69	3.69	7.34	6250	3.62	<b>5.15</b>	<b>5.15</b>	<b>5.15</b>		9.54		
6500	2.17	2.17	2.17	2.17	4.99	6500	2.84	3.41	3.41	3.41	6.52	6500	3.28	<b>4.76</b>	<b>4.76</b>	<b>4.76</b>		8.48		
6750	2.03	2.05	2.05	2.05	4.45	6750	2.59	3.16	3.16	3.16	5.82	6750	2.98	<b>4.41</b>	<b>4.42</b>	<b>4.41</b>		7.58		
7000	1.88	1.93	1.93	1.93	3.99	7000	2.37	2.94	2.94	2.94	5.22	7000	2.72	<b>4.11</b>	<b>4.11</b>	<b>4.11</b>		6.79		
7250	1.73	1.83	1.83	1.83	3.59	7250	2.18	2.74	2.74	2.74	4.70	7250	2.49	<b>3.83</b>	<b>3.83</b>	<b>3.83</b>		6.11		
7500	1.61	1.73	1.73	1.73	3.25	7500	2.01	2.56	2.56	2.56	4.25	7500	2.28	<b>3.58</b>	<b>3.58</b>	<b>3.58</b>		5.52		
7750	1.49	1.63	1.63	1.63	2.94	7750	1.85	2.40	2.40	2.40	3.85	7750	2.10	<b>3.35</b>	<b>3.35</b>	<b>3.35</b>		5.01		
8000	1.39	1.54	1.54	1.54	2.67	8000	1.71	2.25	2.25	2.25	3.50	8000	1.94	<b>3.14</b>	<b>3.14</b>	<b>3.14</b>		4.55		
8250	1.30	1.45	1.45	1.45	2.44	8250	1.59	2.12	2.12	2.12	3.19	8250	1.79	<b>2.96</b>	<b>2.96</b>	<b>2.96</b>		4.15		
8500	1.21	1.38	1.38	1.38	2.23	8500	1.47	1.99	1.99	1.99	2.92	8500	1.66	2.78	2.78	2.78		3.79		
8750	1.13	1.30	1.30	1.30	2.04	8750	1.36	1.88	1.88	1.88	2.67	8750	1.55	2.63	2.63	2.63		3.48		

**LEGEND**





-  Values below the dotted line are outside the "20D" guide for bridging requirements.
- 7.6** Values in **bold type** require High Strength bolts (Grade 8.8)
-  For low restraint claddings reduce capacity up to 10%
-  For low restraint claddings reduce capacity up to 20%
-  For low restraint claddings reduce capacity over 20%. In these situations, refer to software.
- 1 Single number for bridging refers to the number of rows of bridging per span.
- 2 1 2 Multiple number for bridging refers to the number of rows of bridging in end and inner spans. (e.g. 2 in end spans, 1 in inner spans).



## 2 SPAN CONTINUOUS - OUTWARD CAPACITY

Bridging Span	SC/SZ25015				Bridging Span	SC/SZ25019				Bridging Span	SC/SZ25024			
	0	1	2	3		0	1	2	3		0	1	2	3
4000	4.38	4.38	4.38	4.38	4000	<b>7.74</b>	<b>7.74</b>	<b>7.74</b>	<b>7.74</b>	4000				
4250	4.03	4.03	4.03	4.03	4250	<b>7.07</b>	<b>7.07</b>	<b>7.07</b>	<b>7.07</b>	4250				
4500	3.73	3.73	3.73	3.73	4500	<b>6.47</b>	<b>6.47</b>	<b>6.47</b>	<b>6.47</b>	4500				
4750	3.46	3.46	3.46	3.46	4750	<b>5.95</b>	<b>5.95</b>	<b>5.95</b>	<b>5.95</b>	4750				
5000	3.22	3.22	3.22	3.22	5000	<b>5.48</b>	<b>5.48</b>	<b>5.48</b>	<b>5.48</b>	5000	<b>7.94</b>			
5250	3.00	3.00	3.00	3.00	5250	<b>5.06</b>	<b>5.06</b>	<b>5.06</b>	<b>5.06</b>	5250	<b>7.10</b>	<b>7.30</b>	<b>7.30</b>	<b>7.30</b>
5500	2.80	2.80	2.80	2.80	5500	<b>4.67</b>	<b>4.67</b>	<b>4.67</b>	<b>4.67</b>	5500	<b>6.37</b>	<b>6.65</b>	<b>6.65</b>	<b>6.65</b>
5750	2.62	2.62	2.62	2.62	5750	<b>4.25</b>	<b>4.30</b>	<b>4.30</b>	<b>4.30</b>	5750	<b>5.73</b>	<b>6.08</b>	<b>6.08</b>	<b>6.08</b>
6000	2.46	2.46	2.46	2.46	6000	3.85	3.98	3.98	3.98	6000	<b>5.18</b>	<b>5.59</b>	<b>5.59</b>	<b>5.59</b>
6250	2.31	2.31	2.31	2.31	6250	3.49	3.69	3.69	3.69	6250	<b>4.64</b>	<b>5.15</b>	<b>5.15</b>	<b>5.15</b>
6500	2.17	2.17	2.17	2.17	6500	3.16	3.41	3.41	3.41	6500	<b>4.16</b>	<b>4.76</b>	<b>4.76</b>	<b>4.76</b>
6750	2.01	2.05	2.05	2.05	6750	2.83	3.16	3.16	3.16	6750	<b>3.73</b>	<b>4.41</b>	<b>4.41</b>	<b>4.42</b>
7000	1.86	1.93	1.93	1.93	7000	2.53	2.94	2.94	2.94	7000	<b>3.35</b>	<b>4.11</b>	<b>4.11</b>	<b>4.11</b>
7250	1.69	1.83	1.83	1.83	7250	2.27	2.74	2.74	2.74	7250	<b>3.01</b>	<b>3.83</b>	<b>3.83</b>	<b>3.83</b>
7500	1.54	1.73	1.73	1.73	7500	2.04	2.56	2.56	2.56	7500	2.71	<b>3.54</b>	<b>3.58</b>	<b>3.58</b>
7750	1.40	1.63	1.63	1.63	7750	1.83	2.40	2.40	2.40	7750	2.43	<b>3.29</b>	<b>3.35</b>	<b>3.35</b>
8000	1.26	1.54	1.54	1.54	8000	1.65	2.25	2.25	2.25	8000	2.18	<b>3.05</b>	<b>3.14</b>	<b>3.14</b>
8250	1.14	1.45	1.45	1.45	8250	1.48	2.09	2.12	2.12	8250	1.96	<b>2.97</b>	<b>2.96</b>	<b>2.96</b>
8500	1.03	1.36	1.38	1.38	8500	1.33	1.95	1.99	1.99	8500	1.76	2.64	2.78	2.78
8750	0.93	1.27	1.30	1.30	8750	1.20	1.82	1.88	1.88	8750	1.59	2.47	2.63	2.63

**LEGEND**

-  Values below the dotted line are outside the "20D" guide for bridging requirements.
- 7.6** Values in **bold type** require High Strength bolts (Grade 8.8)
-  For low restraint claddings reduce capacity up to 10%
-  For low restraint claddings reduce capacity up to 20%
-  For low restraint claddings reduce capacity over 20%. In these situations, refer to software.
- 1 Single number for bridging refers to the number of rows of bridging per span.
- 2 1 2 Multiple number for bridging refers to the number of rows of bridging in end and inner spans. (e.g. 2 in end spans, 1 in inner spans).

## 2 SPAN CONTINUOUS - INWARD CAPACITY

Bridging Span	SC/SZ30019					L/150	Bridging Span	SC/SZ30024					L/150	Bridging Span	SC/SZ30030					L/150
	0	1	2	3				0	1	2	3				0	1	2	3		
4000	7.75	7.76	7.75	7.75	48.1	4000					44.0	4250	17.6	20.0	20.0	20.0	66.6			
4250	7.17	7.17	7.17	7.17	40.1	4250					4500	15.1	18.1	18.1	18.1	56.1				
4500	6.65	6.65	6.65	6.65	33.8	4500	11.6	11.6	11.6	11.6	44.0	4500	15.1	18.1	18.1	18.1	56.1			
4750	6.19	6.18	6.18	6.18	28.7	4750	10.6	10.7	10.7	10.7	37.4	4750	13.1	16.4	16.4	16.4	47.7			
5000	5.77	5.77	5.77	5.77	24.6	5000	9.39	9.91	9.91	9.91	32.1	5000	11.5	14.8	14.8	14.8	40.9			
5250	5.39	5.39	5.39	5.39	21.3	5250	8.32	9.18	9.18	9.18	27.7	5250	10.1	13.4	13.4	13.4	35.3			
5500	5.05	5.05	5.05	5.05	18.5	5500	7.39	8.53	8.53	8.53	24.1	5500	8.90	12.2	12.2	12.2	30.7			
5750	4.73	4.73	4.73	4.73	16.2	5750	6.59	7.94	7.94	7.94	21.1	5750	7.87	11.2	11.2	11.2	26.9			
6000	4.45	4.45	4.45	4.45	14.3	6000	5.90	7.38	7.38	7.38	18.6	6000	6.99	10.3	10.3	10.3	23.7			
6250	4.19	4.19	4.19	4.19	12.6	6250	5.31	6.85	6.85	6.85	16.4	6250	6.23	9.48	9.48	9.48	20.9			
6500	3.95	3.95	3.95	3.95	11.2	6500	4.81	6.37	6.37	6.37	14.6	6500	5.59	8.76	8.76	8.76	18.6			
6750	3.69	3.73	3.73	3.73	10.0	6750	4.37	5.90	5.90	5.90	13.0	6750	5.04	8.13	8.13	8.13	16.6			
7000	3.40	3.53	3.53	3.53	8.97	7000	3.97	5.49	5.49	5.49	11.7	7000	4.57	7.56	7.56	7.56	14.9			
7250	3.12	3.34	3.34	3.34	8.08	7250	3.63	5.12	5.12	5.12	10.5	7250	4.15	7.05	7.05	7.05	13.4			
7500	2.87	3.17	3.17	3.17	7.30	7500	3.33	4.78	4.78	4.78	9.51	7500	3.79	6.58	6.58	6.58	12.1			
7750	2.65	3.01	3.01	3.01	6.61	7750	3.06	4.48	4.48	4.48	8.62	7750	3.48	6.17	6.17	6.17	11.0			
8000	2.45	2.86	2.86	2.86	6.01	8000	2.82	4.20	4.20	4.20	7.83	8000	3.20	5.79	5.79	5.79	9.99			
8250	2.27	2.72	2.72	2.72	5.48	8250	2.60	3.95	3.95	3.95	7.14	8250	2.95	5.44	5.44	5.44	9.11			
8500	2.11	2.59	2.59	2.59	5.01	8500	2.41	3.72	3.72	3.72	6.53	8500	2.73	5.13	5.13	5.13	8.33			
8750	1.96	2.45	2.45	2.45	4.60	8750	2.24	3.51	3.51	3.51	5.99	8750	2.53	4.84	4.84	4.84	7.63			

### LEGEND

--- Values below the dotted line are outside the "20D" guide for bridging requirements.

**7.6** Values in **bold type** require High Strength bolts (Grade 8.8)

For low restraint claddings reduce capacity up to 10%

For low restraint claddings reduce capacity up to 20%

For low restraint claddings reduce capacity over 20%. In these situations, refer to software.





1 Single number for bridging refers to the number of rows of bridging per span.

2 1 2 Multiple number for bridging refers to the number of rows of bridging in end and inner spans. (e.g. 2 in end spans, 1 in inner spans).

## 2 SPAN CONTINUOUS - OUTWARD CAPACITY

Bridging Span	SC/SZ30019				Bridging Span	SC/SZ30024				Bridging Span	SC/SZ30030			
	0	1	2	3		0	1	2	3		0	1	2	3
4000	7.75	7.75	7.75	7.75	4000					4000				
4250	7.17	7.17	7.17	7.17	4250					4250	<b>20.0</b>	<b>20.0</b>	<b>20.0</b>	<b>20.0</b>
4500	6.65	6.65	6.65	6.65	4500	<b>11.6</b>	<b>11.6</b>	<b>11.6</b>	<b>11.6</b>	4500	<b>18.1</b>	<b>18.1</b>	<b>18.1</b>	<b>18.1</b>
4750	6.19	6.18	6.18	6.18	4750	<b>10.7</b>	<b>10.7</b>	<b>10.7</b>	<b>10.7</b>	4750	<b>16.4</b>	<b>16.4</b>	<b>16.4</b>	<b>16.4</b>
5000	5.77	5.77	5.77	5.77	5000	<b>9.91</b>	<b>9.91</b>	<b>9.91</b>	<b>9.91</b>	5000	<b>14.8</b>	<b>14.8</b>	<b>14.8</b>	<b>14.8</b>
5250	5.39	5.39	5.39	5.39	5250	<b>9.18</b>	<b>9.18</b>	<b>9.18</b>	<b>9.18</b>	5250	<b>13.4</b>	<b>13.4</b>	<b>13.4</b>	<b>13.4</b>
5500	5.05	5.05	5.05	5.05	5500	<b>8.53</b>	<b>8.53</b>	<b>8.53</b>	<b>8.53</b>	5500	<b>12.2</b>	<b>12.2</b>	<b>12.2</b>	<b>12.2</b>
5750	4.73	4.73	4.73	4.73	5750	7.94	7.94	7.94	7.94	5750	<b>11.2</b>	<b>11.2</b>	<b>11.2</b>	<b>11.2</b>
6000	4.45	4.45	4.45	4.45	6000	7.38	7.38	7.38	7.38	6000	<b>10.3</b>	<b>10.3</b>	<b>10.3</b>	<b>10.3</b>
6250	4.19	4.19	4.19	4.19	6250	6.85	6.85	6.85	6.85	6250	<b>9.48</b>	<b>9.48</b>	<b>9.48</b>	<b>9.48</b>
6500	3.95	3.95	3.95	3.95	6500	6.37	6.37	6.37	6.37	6500	<b>8.69</b>	<b>8.77</b>	<b>8.76</b>	<b>8.76</b>
6750	3.73	3.73	3.73	3.73	6750	5.90	5.90	5.90	5.90	6750	<b>7.99</b>	<b>8.13</b>	<b>8.13</b>	<b>8.13</b>
7000	3.53	3.53	3.53	3.53	7000	5.45	5.49	5.49	5.49	7000	<b>7.36</b>	<b>7.56</b>	<b>7.56</b>	<b>7.56</b>
7250	3.34	3.34	3.34	3.34	7250	5.03	5.12	5.12	5.12	7250	<b>6.80</b>	<b>7.05</b>	<b>7.05</b>	<b>7.05</b>
7500	3.17	3.17	3.17	3.17	7500	4.66	4.78	4.78	4.78	7500	<b>6.30</b>	<b>6.58</b>	<b>6.58</b>	<b>6.58</b>
7750	3.01	3.01	3.01	3.01	7750	4.33	4.48	4.48	4.48	7750	<b>5.78</b>	<b>6.17</b>	<b>6.17</b>	<b>6.17</b>
8000	2.86	2.86	2.86	2.86	8000	4.02	4.20	4.20	4.20	8000	5.31	<b>5.79</b>	<b>5.79</b>	<b>5.79</b>
8250	2.70	2.72	2.72	2.72	8250	3.74	3.95	3.95	3.95	8250	4.89	5.44	5.44	5.44
8500	2.53	2.59	2.59	2.59	8500	3.45	3.72	3.72	3.72	8500	4.50	5.13	5.13	5.13
8750	2.37	2.45	2.45	2.45	8750	3.18	3.51	3.51	3.51	8750	4.14	4.84	4.84	4.84

**LEGEND**

-  Values below the dotted line are outside the "20D" guide for bridging requirements.
- 7.6** Values in **bold type** require High Strength bolts (Grade 8.8)
-  For low restraint claddings reduce capacity up to 10%
-  For low restraint claddings reduce capacity up to 20%
-  For low restraint claddings reduce capacity over 20%. In these situations, refer to software.
- 1 Single number for bridging refers to the number of rows of bridging per span.
- 2 1 2 Multiple number for bridging refers to the number of rows of bridging in end and inner spans. (e.g. 2 in end spans, 1 in inner spans).

## 2 SPAN LAPPED CONTINUOUS - INWARD CAPACITY

Bridging Span	Z10010					L/150	Bridging Span	Z10012					L/150	Bridging Span	Z10015					L/150
	0	1	2	3	0			1	2	3	0	1			2	3				
2000	5.68	5.68	5.68	5.68	11.7	2000	7.39	7.39	7.38	7.39	14.1	2000	9.10	9.62	9.62	9.62	17.9			
2250	4.71	4.71	4.71	4.71	8.19	2250	5.82	5.83	5.83	5.83	9.90	2250	7.09	7.60	7.60	7.60	12.6			
2500	3.90	3.90	3.90	3.90	5.97	2500	4.65	4.73	4.73	4.73	7.22	2500	5.67	6.16	6.16	6.16	9.19			
2750	3.22	3.22	3.22	3.22	4.49	2750	3.80	3.91	3.91	3.91	5.42	2750	4.63	5.09	5.09	5.09	6.90			
3000	2.71	2.71	2.71	2.71	3.46	3000	3.16	3.28	3.28	3.28	4.18	3000	3.85	4.28	4.28	4.28	5.32			
3250	2.31	2.31	2.31	2.31	2.72	3250	2.66	2.80	2.80	2.80	3.28	3250	3.25	3.64	3.64	3.64	4.18			
3500	1.99	1.99	1.99	1.99	2.18	3500	2.27	2.41	2.41	2.41	2.63	3500	2.77	3.14	3.14	3.14	3.35			
3750	1.72	1.73	1.73	1.73	1.77	3750	1.95	2.10	2.10	2.10	2.14	3750	2.39	2.74	2.74	2.74	2.72			
4000	1.49	1.52	1.52	1.52	1.46	4000	1.70	1.85	1.85	1.85	1.76	4000	2.08	2.41	2.41	2.41	2.24			
4250	1.30	1.35	1.35	1.35	1.22	4250	1.48	1.64	1.64	1.64	1.47	4250	1.83	2.13	2.13	2.13	1.87			
4500	1.15	1.20	1.20	1.20	1.02	4500	1.31	1.46	1.46	1.46	1.24	4500	1.62	1.90	1.90	1.90	1.58			
4750	1.01	1.08	1.08	1.08	0.87	4750	1.16	1.31	1.31	1.31	1.05	4750	1.44	1.71	1.71	1.71	1.34			
5000	0.90	0.97	0.97	0.97	0.75	5000	1.03	1.18	1.18	1.18	0.90	5000	1.28	1.54	1.54	1.54	1.15			
5250	0.81	0.88	0.88	0.88	0.65	5250	0.92	1.07	1.07	1.07	0.78	5250	1.15	1.38	1.40	1.40	0.99			
5500	0.72	0.81	0.81	0.81	0.56	5500	0.83	0.98	0.98	0.98	0.68	5500	1.04	1.25	1.27	1.27	0.86			
5750	0.65	0.74	0.74	0.74	0.49	5750	0.75	0.89	0.89	0.89	0.59	5750	0.94	1.14	1.16	1.16	0.76			
6000	0.59	0.68	0.68	0.68	0.43	6000	0.68	0.82	0.82	0.82	0.52	6000	0.85	1.04	1.07	1.07	0.67			
6250	0.53	0.62	0.62	0.62	0.38	6250	0.61	0.76	0.76	0.76	0.46	6250	0.78	0.95	0.99	0.99	0.59			
6500	0.48	0.58	0.58	0.58	0.34	6500	0.56	0.70	0.70	0.70	0.41	6500	0.71	0.87	0.91	0.91	0.52			
6750	0.44	0.53	0.53	0.53	0.30	6750	0.51	0.65	0.65	0.65	0.37	6750	0.65	0.80	0.84	0.84	0.47			
7000		0.50	0.50	0.50	0.27	7000	0.46	0.60	0.60	0.60	0.33	7000	0.60	0.74	0.78	0.79	0.42			
7500		0.43	0.43	0.43	0.22	7500		0.51	0.53	0.53	0.27	7500	0.51	0.63	0.67	0.68	0.34			
8000					0.18	8000		0.44	0.46	0.46	0.22	8000	0.43	0.55	0.58	0.60	0.28			

Bridging Span	Z10019				
	0	1	2	3	L/150
2000	12.1	13.5	13.5	13.5	23.2
2250	9.37	10.6	10.6	10.6	16.3
2500	7.46	8.61	8.61	8.61	11.9
2750	6.07	7.12	7.12	7.12	8.91
3000	5.03	5.98	5.98	5.98	6.86
3250	4.23	5.10	5.10	5.10	5.40
3500	3.60	4.40	4.40	4.40	4.32
3750	3.10	3.83	3.83	3.83	3.51
4000	2.69	3.37	3.37	3.37	2.90
4250	2.36	2.97	2.98	2.98	2.41
4500	2.08	2.63	2.66	2.66	2.03
4750	1.85	2.34	2.39	2.39	1.73
5000	1.65	2.10	2.15	2.15	1.48
5250	1.48	1.89	1.95	1.95	1.28
5500	1.33	1.71	1.78	1.78	1.11
5750	1.21	1.55	1.63	1.63	0.98
6000	1.09	1.41	1.50	1.50	0.86
6250	1.00	1.29	1.38	1.38	0.76
6500	0.91	1.18	1.27	1.27	0.68
6750	0.84	1.09	1.17	1.18	0.60
7000	0.77	1.00	1.08	1.10	0.54
7500	0.65	0.86	0.93	0.96	0.44
8000	0.56	0.74	0.80	0.84	0.36

**LEGEND**

--- Values below the dotted line are outside the "20D" guide for bridging requirements.

**7.6** Values in **bold type** require High Strength bolts (Grade 8.8)

 For low restraint claddings reduce capacity up to 10%

 For low restraint claddings reduce capacity up to 20%

 For low restraint claddings reduce capacity over 20%. In these situations, refer to software.

1 Single number for bridging refers to the number of rows of bridging per span.

2 1 2 Multiple number for bridging refers to the number of rows of bridging in end and inner spans. (e.g. 2 in end spans, 1 in inner spans).

## 2 SPAN LAPPED CONTINUOUS - OUTWARD CAPACITY

Bridging Span	Z10010				Bridging Span	Z10012				Bridging Span	Z10015			
	0	1	2	3		0	1	2	3		0	1	2	3
2000	5.68	5.68	5.68	5.68	2000	7.38	7.39	7.39	7.39	2000	9.62	9.62	9.62	9.62
2250	4.71	4.71	4.71	4.71	2250	5.83	5.83	5.83	5.83	2250	7.60	7.60	7.60	7.60
2500	3.90	3.90	3.90	3.90	2500	4.73	4.73	4.73	4.73	2500	6.16	6.16	6.16	6.16
2750	3.22	3.22	3.22	3.22	2750	3.91	3.91	3.91	3.91	2750	4.99	5.09	5.09	5.09
3000	2.71	2.71	2.71	2.71	3000	3.28	3.28	3.28	3.28	3000	4.10	4.28	4.28	4.28
3250	2.31	2.31	2.31	2.31	3250	2.71	2.80	2.80	2.80	3250	3.41	3.64	3.64	3.64
3500	1.92	1.99	1.99	1.99	3500	2.26	2.41	2.41	2.41	3500	2.86	3.14	3.14	3.14
3750	1.60	1.73	1.73	1.73	3750	1.89	2.10	2.10	2.10	3750	2.42	2.74	2.74	2.74
4000	1.34	1.52	1.52	1.52	4000	1.59	1.85	1.85	1.85	4000	2.06	2.39	2.41	2.41
4250	1.12	1.35	1.35	1.35	4250	1.35	1.64	1.64	1.64	4250	1.77	2.09	2.13	2.13
4500	0.94	1.20	1.20	1.20	4500	1.14	1.46	1.46	1.46	4500	1.52	1.83	1.90	1.90
4750	0.79	1.08	1.08	1.08	4750	0.97	1.29	1.31	1.31	4750	1.32	1.62	1.71	1.71
5000	0.66	0.97	0.97	0.97	5000	0.82	1.14	1.18	1.18	5000	1.14	1.43	1.54	1.54
5250	0.56	0.85	0.88	0.88	5250	0.70	1.00	1.07	1.07	5250	0.98	1.28	1.39	1.40
5500	0.48	0.75	0.81	0.81	5500	0.60	0.89	0.98	0.98	5500	0.84	1.14	1.25	1.27
5750	0.41	0.67	0.74	0.74	5750	0.52	0.79	0.89	0.89	5750	0.72	1.02	1.13	1.16
6000		0.59	0.68	0.68	6000	0.46	0.70	0.82	0.82	6000	0.63	0.92	1.03	1.07
6250		0.52	0.62	0.62	6250	0.40	0.63	0.74	0.76	6250	0.55	0.83	0.94	0.99
6500		0.46	0.58	0.58	6500		0.56	0.67	0.70	6500	0.48	0.74	0.85	0.91
6750		0.41	0.52	0.53	6750		0.50	0.61	0.65	6750	0.43	0.67	0.78	0.83
7000			0.47	0.50	7000		0.45	0.56	0.60	7000		0.61	0.71	0.77
7500				0.43	7500			0.47	0.52	7500		0.50	0.60	0.66
8000					8000				0.45	8000		0.40	0.51	0.56

Bridging Span	Z10019			
	0	1	2	3
2000	13.5	13.5	13.5	13.5
2250	10.6	10.6	10.6	10.6
2500	8.53	8.61	8.61	8.61
2750	6.87	7.12	7.12	7.12
3000	5.62	5.98	5.98	5.98
3250	4.66	5.10	5.10	5.10
3500	3.90	4.40	4.40	4.40
3750	3.29	3.83	3.83	3.83
4000	2.79	3.31	3.37	3.37
4250	2.39	2.88	2.98	2.98
4500	2.06	2.53	2.66	2.66
4750	1.78	2.22	2.39	2.39
5000	1.54	1.97	2.15	2.15
5250	1.34	1.75	1.93	1.95
5500	1.17	1.56	1.73	1.78
5750	1.02	1.39	1.57	1.63
6000	0.89	1.25	1.42	1.50
6250	0.77	1.12	1.29	1.37
6500	0.68	1.01	1.17	1.26
6750	0.60	0.92	1.07	1.15
7000	0.53	0.83	0.98	1.06
7500	0.43	0.68	0.82	0.90
8000		0.56	0.70	0.78

### LEGEND

- Values below the dotted line are outside the "20D" guide for bridging requirements.
- 7.6** Values in **bold type** require High Strength bolts (Grade 8.8)
- For low restraint claddings reduce capacity up to 10%
- For low restraint claddings reduce capacity up to 20%
- For low restraint claddings reduce capacity over 20%  
In these situations, refer to software.
- 1 Single number for bridging refers to the number of rows of bridging per span.
- 2 1 2 Multiple number for bridging refers to the number of rows of bridging in end and inner spans. (e.g. 2 in end spans, 1 in inner spans).

## 2 SPAN LAPPED CONTINUOUS - INWARD CAPACITY

Bridging Span	SZ15010					L/150	Bridging Span	SZ15012					L/150	Bridging Span	SZ15015					L/150
	0	1	2	3	0			1	2	3	0	1			2	3				
2000	5.61	5.61	5.62	5.61	33.6	2000	9.13	9.12	9.13	9.13	42.4	2000	15.1	15.1	15.1	15.1	53.9			
2250	4.90	4.90	4.90	4.90	23.6	2250	7.86	7.86	7.86	7.86	29.8	2250	12.7	12.7	12.7	12.7	37.9			
2500	4.33	4.33	4.33	4.32	17.2	2500	6.85	6.85	6.85	6.85	21.7	2500	10.8	10.8	10.8	10.8	27.6			
2750	3.85	3.85	3.85	3.85	12.9	2750	6.02	6.02	6.02	6.02	16.3	2750	9.24	9.24	9.24	9.24	20.7			
3000	3.45	3.45	3.46	3.45	9.95	3000	5.33	5.33	5.33	5.33	12.6	3000	7.82	8.02	8.02	8.01	16.0			
3250	3.12	3.12	3.12	3.12	7.83	3250	4.75	4.75	4.75	4.75	9.88	3250	6.55	6.97	6.97	6.97	12.6			
3500	2.83	2.83	2.83	2.83	6.27	3500	4.26	4.26	4.26	4.26	7.91	3500	5.55	6.08	6.08	6.08	10.1			
3750	2.58	2.58	2.58	2.58	5.10	3750	3.84	3.84	3.84	3.84	6.43	3750	4.76	5.33	5.33	5.33	8.18			
4000	2.36	2.36	2.36	2.36	4.20	4000	3.47	3.47	3.47	3.47	5.30	4000	4.12	4.69	4.69	4.69	6.74			
4250	2.16	2.16	2.16	2.16	3.50	4250	3.10	3.16	3.16	3.16	4.42	4250	3.60	4.15	4.15	4.15	5.62			
4500	1.99	1.99	1.99	1.99	2.95	4500	2.74	2.85	2.85	2.85	3.72	4500	3.16	3.70	3.70	3.70	4.73			
4750	1.84	1.84	1.84	1.84	2.51	4750	2.43	2.58	2.58	2.58	3.17	4750	2.80	3.32	3.32	3.32	4.03			
5000	1.71	1.71	1.71	1.71	2.15	5000	2.16	2.34	2.34	2.34	2.71	5000	2.49	3.00	3.00	3.00	3.45			
5250	1.59	1.59	1.59	1.59	1.86	5250	1.93	2.12	2.12	2.12	2.34	5250	2.22	2.72	2.72	2.72	2.98			
5500	1.46	1.48	1.48	1.48	1.62	5500	1.74	1.94	1.94	1.94	2.04	5500	2.00	2.48	2.48	2.48	2.59			
5750	1.32	1.38	1.38	1.38	1.41	5750	1.57	1.77	1.77	1.77	1.78	5750	1.80	2.27	2.27	2.27	2.27			
6000	1.20	1.28	1.28	1.28	1.24	6000	1.42	1.63	1.63	1.63	1.57	6000	1.63	2.08	2.08	2.08	2.00			
6250	1.09	1.19	1.19	1.18	1.10	6250	1.29	1.50	1.50	1.50	1.39	6250	1.48	1.92	1.92	1.92	1.77			
6500	0.99	1.10	1.10	1.10	0.98	6500	1.17	1.39	1.39	1.39	1.24	6500	1.34	1.77	1.77	1.77	1.57			
6750	0.90	1.02	1.02	1.02	0.87	6750	1.07	1.28	1.28	1.28	1.10	6750	1.23	1.64	1.65	1.65	1.40			
7000	0.82	0.95	0.95	0.95	0.78	7000	0.97	1.19	1.19	1.19	0.99	7000	1.12	1.52	1.53	1.53	1.26			
7500	0.68	0.83	0.83	0.83	0.64	7500	0.81	1.04	1.04	1.04	0.80	7500	0.95	1.31	1.33	1.33	1.02			
8000	0.58	0.73	0.73	0.73	0.53	8000	0.68	0.91	0.91	0.91	0.66	8000	0.80	1.14	1.17	1.17	0.84			
8500	0.49	0.65	0.65	0.65	0.44	8500	0.58	0.80	0.81	0.81	0.55	8500	0.68	0.99	1.04	1.04	0.70			
9000	0.41	0.57	0.58	0.58	0.37	9000	0.49	0.70	0.72	0.72	0.47	9000	0.58	0.87	0.92	0.93	0.59			
9500		0.50	0.52	0.52	0.31	9500	0.42	0.62	0.65	0.65	0.40	9500	0.50	0.77	0.82	0.83	0.50			
10000		0.45	0.47	0.47	0.27	10000		0.55	0.58	0.59	0.34	10000	0.44	0.69	0.73	0.75	0.43			

Bridging Span	SZ15019					L/150	Bridging Span	SZ15024					L/150
	0	1	2	3	0			1	2	3			
2000						2000							
2250	18.4	19.4	19.4	19.4	48.3	2250							
2500	14.5	16.1	16.1	16.1	35.2	2500							
2750	11.7	13.5	13.5	13.5	26.5	2750	14.7				33.8		
3000	9.61	11.4	11.4	11.4	20.4	3000	12.0	15.4	15.4	15.4	26.0		
3250	8.01	9.74	9.74	9.74	16.0	3250	9.89	13.1	13.1	13.1	20.5		
3500	6.77	8.40	8.40	8.40	12.8	3500	8.30	11.2	11.3	11.3	16.4		
3750	5.79	7.32	7.32	7.32	10.4	3750	7.05	9.72	9.85	9.85	13.3		
4000	5.00	6.43	6.43	6.43	8.60	4000	6.05	8.50	8.66	8.66	11.0		
4250	4.35	5.70	5.70	5.70	7.17	4250	5.24	7.49	7.67	7.67	9.15		
4500	3.82	5.06	5.08	5.08	6.04	4500	4.57	6.65	6.84	6.84	7.71		
4750	3.38	4.52	4.56	4.56	5.13	4750	4.02	5.94	6.14	6.14	6.56		
5000	3.00	4.06	4.12	4.12	4.40	5000	3.56	5.34	5.54	5.54	5.62		
5250	2.67	3.67	3.73	3.73	3.80	5250	3.16	4.82	5.03	5.03	4.86		
5500	2.39	3.33	3.40	3.40	3.31	5500	2.83	4.35	4.58	4.58	4.22		
5750	2.15	3.03	3.11	3.11	2.89	5750	2.54	3.95	4.19	4.19	3.70		
6000	1.94	2.77	2.86	2.86	2.55	6000	2.29	3.60	3.84	3.85	3.25		
6250	1.76	2.54	2.63	2.63	2.25	6250	2.08	3.29	3.52	3.55	2.88		
6500	1.59	2.34	2.44	2.44	2.00	6500	1.89	3.02	3.25	3.28	2.56		
6750	1.45	2.16	2.26	2.26	1.79	6750	1.72	2.77	3.00	3.04	2.29		
7000	1.33	1.99	2.10	2.10	1.60	7000	1.57	2.56	2.78	2.83	2.05		
7500	1.11	1.71	1.82	1.83	1.30	7500	1.33	2.19	2.40	2.46	1.67		
8000	0.94	1.48	1.58	1.61	1.07	8000	1.13	1.90	2.09	2.16	1.37		
8500	0.81	1.28	1.39	1.42	0.90	8500	0.97	1.65	1.84	1.90	1.14		
9000	0.69	1.13	1.23	1.27	0.76	9000	0.85	1.45	1.63	1.68	0.96		
9500	0.60	0.99	1.09	1.13	0.64	9500	0.74	1.28	1.44	1.50	0.82		
10000	0.53	0.88	0.97	1.01	0.55	10000	0.65	1.13	1.28	1.34	0.70		

### LEGEND

--- Values below the dotted line are outside the "20D" guide for bridging requirements.

**7.6** Values in **bold type** require High Strength bolts (Grade 8.8)

For low restraint claddings reduce capacity up to 10%

For low restraint claddings reduce capacity up to 20%

For low restraint claddings reduce capacity over 20%  
In these situations, refer to software.

1 Single number for bridging refers to the number of rows of bridging per span.

2 1 2 Multiple number for bridging refers to the number of rows of bridging in end and inner spans. (e.g. 2 in end spans, 1 in inner spans).

## 2 SPAN LAPPED CONTINUOUS - OUTWARD CAPACITY

Bridging Span	SZ15010				Bridging Span	SZ15012				Bridging Span	SZ15015			
	0	1	2	3		0	1	2	3		0	1	2	3
2000	5.61	5.61	5.61	5.62	2000	9.13	9.12	9.13	9.13	2000	15.1	15.1	15.1	15.1
2250	4.90	4.90	4.90	4.90	2250	7.86	7.86	7.86	7.86	2250	<b>12.7</b>	<b>12.7</b>	<b>12.7</b>	<b>12.7</b>
2500	4.33	4.33	4.32	4.32	2500	6.85	6.85	6.85	6.85	2500	<b>10.8</b>	<b>10.8</b>	<b>10.8</b>	<b>10.8</b>
2750	3.85	3.85	3.85	3.85	2750	6.02	6.02	6.02	6.02	2750	<b>9.24</b>	<b>9.24</b>	<b>9.24</b>	<b>9.24</b>
3000	3.45	3.45	3.45	3.45	3000	5.33	5.33	5.33	5.33	3000	<b>8.02</b>	<b>8.02</b>	<b>8.02</b>	<b>8.02</b>
3250	3.12	3.12	3.12	3.12	3250	4.75	4.75	4.75	4.75	3250	6.97	6.97	6.97	6.97
3500	2.83	2.83	2.83	2.83	3500	4.26	4.26	4.26	4.26	3500	6.01	6.08	6.08	6.08
3750	2.58	2.58	2.58	2.58	3750	3.84	3.84	3.84	3.84	3750	5.14	5.33	5.33	5.33
4000	2.36	2.36	2.36	2.36	4000	3.47	3.47	3.47	3.47	4000	4.42	4.69	4.69	4.69
4250	2.16	2.16	2.16	2.16	4250	3.05	3.16	3.16	3.16	4250	3.84	4.15	4.15	4.15
4500	1.99	1.99	1.99	1.99	4500	2.67	2.85	2.85	2.85	4500	3.34	3.70	3.70	3.70
4750	1.76	1.84	1.84	1.84	4750	2.34	2.58	2.58	2.58	4750	2.91	3.32	3.32	3.32
5000	1.55	1.71	1.71	1.71	5000	2.04	2.34	2.34	2.34	5000	2.52	2.99	3.00	3.00
5250	1.35	1.59	1.59	1.59	5250	1.78	2.12	2.12	2.12	5250	2.19	2.69	2.72	2.72
5500	1.16	1.48	1.48	1.48	5500	1.53	1.92	1.94	1.94	5500	1.90	2.42	2.48	2.48
5750	1.00	1.38	1.38	1.38	5750	1.32	1.73	1.77	1.77	5750	1.65	2.18	2.27	2.27
6000	0.86	1.26	1.28	1.28	6000	1.15	1.57	1.63	1.63	6000	1.45	1.98	2.08	2.08
6250	0.74	1.14	1.19	1.18	6250	1.00	1.42	1.50	1.50	6250	1.27	1.79	1.92	1.92
6500	0.64	1.04	1.10	1.10	6500	0.87	1.29	1.39	1.39	6500	1.12	1.63	1.77	1.77
6750	0.56	0.94	1.02	1.02	6750	0.76	1.19	1.28	1.28	6750	0.99	1.49	1.64	1.65
7000	0.49	0.85	0.95	0.95	7000	0.66	1.08	1.19	1.19	7000	0.87	1.36	1.51	1.53
7500		0.69	0.82	0.83	7500	0.52	0.90	1.02	1.04	7500	0.67	1.13	1.29	1.33
8000		0.56	0.70	0.73	8000	0.41	0.75	0.88	0.91	8000	0.53	0.93	1.11	1.17
8500		0.46	0.61	0.65	8500		0.61	0.76	0.81	8500	0.43	0.77	0.96	1.03
9000			0.52	0.58	9000		0.50	0.66	0.72	9000		0.64	0.83	0.90
9500			0.45	0.51	9500		0.41	0.58	0.63	9500		0.53	0.72	0.80
10000			0.45		10000			0.50	0.56	10000		0.45	0.62	0.71

Bridging Span	SZ15019				Bridging Span	SZ15024			
	0	1	2	3		0	1	2	3
2000					2000				
2250	<b>19.4</b>	<b>19.4</b>	<b>19.4</b>	<b>19.4</b>	2250				
2500	<b>16.1</b>	<b>16.1</b>	<b>16.1</b>	<b>16.1</b>	2500				
2750	<b>13.5</b>	<b>13.5</b>	<b>13.5</b>	<b>13.5</b>	2750				
3000	<b>11.2</b>	<b>11.4</b>	<b>11.4</b>	<b>11.4</b>	3000	<b>14.8</b>	<b>15.4</b>	<b>15.4</b>	<b>15.4</b>
3250	<b>9.41</b>	<b>9.74</b>	<b>9.74</b>	<b>9.74</b>	3250	<b>12.5</b>	<b>13.1</b>	<b>13.1</b>	<b>13.1</b>
3500	<b>7.98</b>	<b>8.40</b>	<b>8.40</b>	<b>8.40</b>	3500	<b>10.6</b>	<b>11.3</b>	<b>11.3</b>	<b>11.3</b>
3750	<b>6.83</b>	<b>7.32</b>	<b>7.32</b>	<b>7.32</b>	3750	<b>9.02</b>	<b>9.81</b>	<b>9.85</b>	<b>9.85</b>
4000	5.88	<b>6.43</b>	<b>6.43</b>	<b>6.43</b>	4000	<b>7.72</b>	<b>8.56</b>	<b>8.66</b>	<b>8.66</b>
4250	5.06	<b>5.68</b>	<b>5.70</b>	<b>5.70</b>	4250	<b>6.65</b>	<b>7.52</b>	<b>7.67</b>	<b>7.67</b>
4500	4.38	5.02	5.08	5.08	4500	<b>5.76</b>	<b>6.65</b>	<b>6.84</b>	<b>6.84</b>
4750	3.80	4.46	4.56	4.56	4750	<b>5.01</b>	<b>5.92</b>	<b>6.14</b>	<b>6.14</b>
5000	3.31	3.98	4.12	4.12	5000	<b>4.38</b>	<b>5.29</b>	<b>5.52</b>	<b>5.54</b>
5250	2.88	3.58	3.73	3.73	5250	3.85	<b>4.76</b>	<b>4.98</b>	<b>5.03</b>
5500	2.51	3.22	3.40	3.40	5500	3.37	<b>4.29</b>	<b>4.51</b>	<b>4.58</b>
5750	2.20	2.91	3.10	3.11	5750	2.95	<b>3.87</b>	<b>4.10</b>	<b>4.19</b>
6000	1.93	2.64	2.82	2.86	6000	2.59	3.49	3.75	3.85
6250	1.70	2.40	2.58	2.63	6250	2.28	3.16	3.43	3.53
6500	1.49	2.17	2.37	2.44	6500	2.02	2.87	3.15	3.25
6750	1.31	1.97	2.18	2.26	6750	1.79	2.61	2.90	3.00
7000	1.16	1.79	2.01	2.10	7000	1.59	2.38	2.68	2.78
7500	0.91	1.49	1.72	1.80	7500	1.26	1.99	2.29	2.39
8000	0.72	1.24	1.48	1.57	8000	1.01	1.67	1.96	2.08
8500	0.58	1.03	1.28	1.37	8500	0.82	1.40	1.69	1.82
9000	0.48	0.86	1.10	1.20	9000	0.68	1.18	1.46	1.61
9500		0.73	0.96	1.06	9500	0.57	0.99	1.27	1.42
10000		0.61	0.83	0.95	10000	0.48	0.84	1.11	1.25

### LEGEND

--- Values below the dotted line are outside the "20D" guide for bridging requirements.

**7.6** Values in **bold type** require High Strength bolts (Grade 8.8)

For low restraint claddings reduce capacity up to 10%

For low restraint claddings reduce capacity up to 20%

For low restraint claddings reduce capacity over 20%  
In these situations, refer to software.

1 Single number for bridging refers to the number of rows of bridging per span.

2 1 2 Multiple number for bridging refers to the number of rows of bridging in end and inner spans. (e.g. 2 in end spans, 1 in inner spans).

## 2 SPAN LAPPED CONTINUOUS - INWARD CAPACITY

Bridging Span	SZ20012					L/150	Bridging Span	SZ20015					L/150	Bridging Span	SZ20019					L/150
	0	1	2	3	0			1	2	3	0	1			2	3				
3000	4.70	4.70	4.70	4.70	26.7	3000	<b>8.32</b>	<b>8.32</b>	<b>8.32</b>	<b>8.32</b>	34.3	3000	<b>14.5</b>	<b>14.5</b>	<b>14.5</b>	<b>14.5</b>	45.1			
3250	4.28	4.28	4.28	4.28	21.0	3250	<b>7.48</b>	<b>7.48</b>	<b>7.48</b>	<b>7.47</b>	27.0	3250	<b>12.8</b>	<b>12.8</b>	<b>12.8</b>	<b>12.8</b>	35.5			
3500	3.92	3.92	3.92	3.92	16.8	3500	6.76	6.76	6.76	6.76	21.6	3500	<b>10.8</b>	<b>11.4</b>	<b>11.4</b>	<b>11.4</b>	28.4			
3750	3.61	3.61	3.60	3.60	13.7	3750	6.14	6.14	6.14	6.13	17.6	3750	<b>9.18</b>	<b>10.3</b>	<b>10.3</b>	<b>10.2</b>	23.1			
4000	<b>3.33</b>	<b>3.33</b>	<b>3.33</b>	<b>3.33</b>	11.3	4000	5.60	5.60	5.60	5.60	14.5	4000	<b>7.86</b>	<b>9.23</b>	<b>9.23</b>	<b>9.23</b>	19.0			
4250	3.08	3.08	3.08	3.08	9.38	4250	5.12	5.12	5.12	5.12	12.1	4250	<b>6.80</b>	<b>8.32</b>	<b>8.32</b>	<b>8.32</b>	15.9			
4500	2.87	2.87	2.87	2.87	7.90	4500	4.70	4.70	4.70	4.70	10.2	4500	<b>5.94</b>	<b>7.49</b>	<b>7.49</b>	<b>7.49</b>	13.4			
4750	2.67	2.67	2.67	2.67	6.72	4750	4.27	4.33	4.33	4.33	8.65	4750	<b>5.23</b>	<b>6.78</b>	<b>6.78</b>	<b>6.78</b>	11.4			
5000	2.50	2.49	2.49	2.50	5.76	5000	3.82	4.00	4.00	4.00	7.42	5000	<b>4.62</b>	<b>6.16</b>	<b>6.16</b>	<b>6.16</b>	9.74			
5250	2.34	2.34	2.34	2.34	4.98	5250	3.41	3.71	3.71	3.71	6.41	5250	4.10	<b>5.61</b>	<b>5.60</b>	<b>5.61</b>	8.42			
5500	2.19	2.19	2.19	2.19	4.33	5500	3.07	3.44	3.44	3.44	5.57	5500	3.66	<b>5.11</b>	<b>5.11</b>	<b>5.11</b>	7.32			
5750	2.06	2.06	2.06	2.06	3.79	5750	2.77	<b>3.18</b>	3.18	3.18	4.88	5750	3.28	<b>4.67</b>	<b>4.67</b>	<b>4.67</b>	6.41			
6000	1.94	1.94	1.94	1.94	3.34	6000	2.51	<b>2.94</b>	2.94	2.94	4.29	6000	2.96	<b>4.29</b>	<b>4.29</b>	<b>4.29</b>	5.64			
6250	1.83	<b>1.83</b>	1.83	1.83	2.95	6250	2.28	<b>2.73</b>	2.73	2.73	3.80	6250	2.67	<b>3.96</b>	<b>3.96</b>	<b>3.96</b>	4.99			
6500	1.71	1.73	1.73	1.73	2.62	6500	2.08	<b>2.54</b>	2.54	2.54	3.38	6500	2.42	<b>3.66</b>	<b>3.66</b>	<b>3.66</b>	4.44			
6750	1.57	<b>1.63</b>	1.63	1.63	2.34	6750	1.90	2.36	2.36	2.36	3.01	6750	2.20	3.39	3.39	3.39	3.96			
7000	1.44	1.55	1.55	1.55	2.10	7000	1.73	2.20	2.20	2.20	2.70	7000	2.01	3.15	3.15	3.15	3.55			
7500	1.23	1.39	1.39	1.39	1.71	7500	1.46	1.91	1.91	1.91	2.20	7500	1.69	2.73	2.75	2.75	2.89			
8000	1.05	<b>1.26</b>	1.26	1.26	1.41	8000	1.24	<b>1.68</b>	1.68	1.68	1.81	8000	1.43	<b>2.38</b>	2.41	2.41	2.38			
8500	0.90	1.14	1.14	1.14	1.17	8500	1.07	1.49	1.49	1.49	1.51	8500	1.23	2.09	2.14	2.14	1.98			
9000	0.78	1.02	1.02	1.02	0.99	9000	0.92	1.33	1.33	1.33	1.27	9000	1.06	1.85	1.91	1.91	1.67			
9500	0.68	0.93	<b>0.93</b>	0.93	0.84	9500	0.80	1.19	<b>1.19</b>	1.19	1.08	9500	0.93	1.65	<b>1.71</b>	1.71	1.42			
10000	0.60	0.84	<b>0.84</b>	0.84	0.72	10000	0.70	1.07	<b>1.08</b>	1.08	0.93	10000	0.81	1.48	<b>1.55</b>	1.55	1.22			
10500	0.52	0.75	0.76	0.76	0.62	10500	0.61	0.96	<b>0.98</b>	0.98	0.80	10500	0.72	1.32	<b>1.40</b>	1.40	1.05			
11000	0.46	0.68	0.69	0.69	0.54	11000	0.54	0.87	<b>0.89</b>	0.89	0.70	11000	0.64	1.18	<b>1.28</b>	1.28	0.92			
11500	0.41	0.61	0.63	0.63	0.47	11500	0.48	0.79	<b>0.81</b>	0.81	0.61	11500	0.57	1.06	1.16	1.17	0.80			
12000		0.56	<b>0.58</b>	0.58	0.42	12000	0.43	0.71	<b>0.75</b>	0.75	0.54	12000	0.51	0.95	<b>1.06</b>	1.07	0.71			
12500		0.51	0.54	<b>0.54</b>	0.37	12500		0.65	0.69	0.69	0.48	12500	0.45	0.86	0.97	<b>0.99</b>	0.62			
13500		0.42	0.45	<b>0.46</b>	0.29	13500		0.54	0.58	<b>0.59</b>	0.38	13500		0.70	0.81	<b>0.85</b>	0.50			
14500					0.24	14500		0.45	0.50	<b>0.51</b>	0.30	14500		0.58	0.69	<b>0.73</b>	0.40			
15500					0.19	15500			0.42	<b>0.45</b>	0.25	15500		0.48	0.59	0.63	0.33			

Bridging Span	SZ20024				
	0	1	2	3	L/150
3000					
3250					
3500					
3750	<b>11.2</b>				29.5
4000	<b>9.54</b>				24.3
4250	<b>8.16</b>				20.3
4500	<b>7.03</b>	<b>10.5</b>	<b>10.5</b>	<b>10.5</b>	17.1
4750	<b>6.11</b>	<b>9.43</b>	<b>9.43</b>	<b>9.43</b>	14.5
5000	<b>5.35</b>	<b>8.52</b>	<b>8.52</b>	<b>8.52</b>	12.5
5250	<b>4.72</b>	<b>7.72</b>	<b>7.72</b>	<b>7.72</b>	10.8
5500	<b>4.19</b>	<b>7.02</b>	<b>7.04</b>	<b>7.04</b>	9.37
5750	3.74	<b>6.40</b>	<b>6.44</b>	<b>6.44</b>	8.20
6000	3.36	<b>5.84</b>	<b>5.91</b>	<b>5.91</b>	7.21
6250	3.03	<b>5.36</b>	<b>5.45</b>	<b>5.45</b>	6.38
6500	2.75	<b>4.93</b>	<b>5.04</b>	<b>5.04</b>	5.67
6750	2.50	<b>4.55</b>	<b>4.67</b>	<b>4.67</b>	5.07
7000	2.29	<b>4.21</b>	<b>4.34</b>	<b>4.34</b>	4.54
7500	1.93	<b>3.63</b>	<b>3.78</b>	<b>3.78</b>	3.69
8000	1.64	<b>3.15</b>	<b>3.33</b>	<b>3.33</b>	3.04
8500	1.41	<b>2.74</b>	<b>2.95</b>	<b>2.95</b>	2.54
9000	1.23	2.40	<b>2.63</b>	<b>2.63</b>	2.14
9500	1.07	2.12	2.36	2.36	1.82
10000	0.95	1.88	2.12	2.13	1.56
10500	0.84	1.67	1.90	1.93	1.35
11000	0.75	1.49	1.72	1.76	1.17
11500	0.67	1.34	1.56	1.61	1.02
12000	0.60	1.21	1.42	1.48	0.90
12500	0.54	1.09	1.30	1.36	0.80
13500	0.44	0.89	1.09	1.15	0.63
14500		0.74	0.91	0.98	0.51
15500		0.61	0.77	0.85	0.42

### LEGEND

--- Values below the dotted line are outside the "20D" guide for bridging requirements.

**7.6** Values in **bold type** require High Strength bolts (Grade 8.8)

For low restraint claddings reduce capacity up to 10%

For low restraint claddings reduce capacity up to 20%

For low restraint claddings reduce capacity over 20%  
In these situations, refer to software.

1 Single number for bridging refers to the number of rows of bridging per span.

2 1 2 Multiple number for bridging refers to the number of rows of bridging in end and inner spans. (e.g. 2 in end spans, 1 in inner spans).



## 2 SPAN LAPPED CONTINUOUS - OUTWARD CAPACITY

Bridging Span	SZ20012				Bridging Span	SZ20015				Bridging Span	SZ20019			
	0	1	2	3		0	1	2	3		0	1	2	3
3000	4.70	4.70	4.70	4.70	3000	<b>8.32</b>	<b>8.32</b>	<b>8.32</b>	<b>8.32</b>	3000	<b>14.5</b>	<b>14.5</b>	<b>14.5</b>	<b>14.5</b>
3250	4.28	4.28	4.28	4.28	3250	<b>7.48</b>	<b>7.48</b>	<b>7.48</b>	<b>7.47</b>	3250	<b>12.8</b>	<b>12.8</b>	<b>12.8</b>	<b>12.8</b>
3500	3.92	3.92	3.92	3.92	3500	6.76	6.76	6.76	6.76	3500	<b>11.4</b>	<b>11.4</b>	<b>11.4</b>	<b>11.4</b>
3750	3.61	3.61	3.60	3.60	3750	6.14	6.14	6.14	6.13	3750	<b>10.3</b>	<b>10.3</b>	<b>10.3</b>	<b>10.2</b>
4000	<u>3.33</u>	<u>3.33</u>	3.33	3.33	4000	<u>5.60</u>	5.60	5.60	5.60	4000	<b>9.23</b>	<b>9.23</b>	<b>9.23</b>	<b>9.23</b>
4250	3.08	3.08	3.08	3.08	4250	5.12	5.12	5.12	5.12	4250	<b>8.32</b>	<b>8.32</b>	<b>8.32</b>	<b>8.32</b>
4500	2.87	2.87	2.87	2.87	4500	4.70	4.70	4.70	4.70	4500	<b>7.48</b>	<b>7.49</b>	<b>7.49</b>	<b>7.49</b>
4750	2.67	2.67	2.67	2.67	4750	4.33	4.33	4.33	4.33	4750	<b>6.63</b>	<b>6.78</b>	<b>6.78</b>	<b>6.78</b>
5000	2.50	2.49	2.49	2.50	5000	4.00	4.00	4.00	4.00	5000	<b>5.91</b>	<b>6.16</b>	<b>6.16</b>	<b>6.16</b>
5250	2.34	2.34	2.34	2.33	5250	3.71	3.71	3.71	3.71	5250	<b>5.29</b>	<b>5.61</b>	<b>5.60</b>	<b>5.61</b>
5500	2.19	2.19	2.19	2.19	5500	<b>3.37</b>	3.44	3.44	3.44	5500	<b>4.72</b>	<b>5.11</b>	<b>5.11</b>	<b>5.11</b>
5750	2.06	2.06	2.06	2.06	5750	<b>3.03</b>	3.18	3.18	3.18	5750	<b>4.18</b>	<b>4.67</b>	<b>4.67</b>	<b>4.67</b>
6000	<b>1.94</b>	1.94	1.94	1.94	6000	<b>2.73</b>	2.94	2.94	2.94	6000	<b>3.70</b>	<b>4.29</b>	<b>4.29</b>	<b>4.29</b>
6250	1.78	1.83	1.83	1.83	6250	<b>2.46</b>	2.73	2.73	2.73	6250	3.29	<b>3.96</b>	<b>3.96</b>	<b>3.95</b>
6500	1.63	1.73	1.73	1.73	6500	2.19	2.54	2.54	2.54	6500	2.92	<b>3.64</b>	<b>3.66</b>	<b>3.66</b>
6750	1.46	1.63	1.63	1.63	6750	1.93	2.36	2.36	2.36	6750	2.59	3.35	3.39	3.39
7000	1.30	1.55	1.55	1.55	7000	1.71	2.20	2.20	2.20	7000	2.31	3.09	3.15	3.15
7500	1.03	1.39	1.39	1.39	7500	1.35	1.89	1.91	1.91	7500	1.85	2.65	2.75	2.75
8000	0.82	1.25	1.26	1.26	8000	1.08	1.63	1.68	1.68	8000	1.48	2.29	2.41	2.41
8500	0.66	1.08	1.14	1.14	8500	0.86	1.40	1.49	1.49	8500	1.19	1.97	2.14	2.14
9000	0.53	0.93	1.02	1.02	9000	0.70	1.22	1.33	1.33	9000	0.96	1.68	1.88	1.91
9500	0.44	<b>0.79</b>	0.92	0.93	9500	0.57	<b>1.06</b>	1.19	1.19	9500	0.79	1.43	1.67	1.71
10000		<b>0.67</b>	0.82	0.84	10000	0.47	<b>0.90</b>	1.06	1.08	10000	0.66	<b>1.22</b>	1.49	1.55
10500		<b>0.57</b>	0.73	0.76	10500		<b>0.76</b>	0.95	0.98	10500	0.55	<b>1.04</b>	1.33	1.40
11000		<b>0.49</b>	0.65	0.69	11000		<b>0.65</b>	0.84	0.89	11000	0.47	<b>0.89</b>	1.19	1.27
11500		<b>0.42</b>	0.58	0.63	11500		<b>0.55</b>	0.76	0.81	11500		<b>0.77</b>	1.06	1.15
12000			0.52	0.57	12000		<b>0.47</b>	<b>0.68</b>	0.74	12000		<b>0.66</b>	<b>0.94</b>	1.04
12500			0.46	0.52	12500		<b>0.41</b>	0.61	0.68	12500		<b>0.57</b>	0.83	0.95
13500				0.43	13500			0.47	0.56	13500		<b>0.43</b>	0.65	0.79
14500					14500				0.47	14500			0.51	0.65
15500					15500					15500			0.41	0.54

Bridging Span	SZ20024			
	0	1	2	3
3000				
3250				
3500				
3750				
4000				
4250				
4500	<b>10.1</b>	<b>10.5</b>	<b>10.5</b>	<b>10.5</b>
4750	<b>8.90</b>	<b>9.43</b>	<b>9.43</b>	<b>9.43</b>
5000	<b>7.90</b>	<b>8.52</b>	<b>8.52</b>	<b>8.52</b>
5250	<b>6.98</b>	<b>7.72</b>	<b>7.72</b>	<b>7.72</b>
5500	<b>6.17</b>	<b>7.04</b>	<b>7.04</b>	<b>7.04</b>
5750	<b>5.47</b>	<b>6.44</b>	<b>6.44</b>	<b>6.44</b>
6000	<b>4.86</b>	<b>5.88</b>	<b>5.91</b>	<b>5.91</b>
6250	<b>4.33</b>	<b>5.38</b>	<b>5.45</b>	<b>5.45</b>
6500	<b>3.86</b>	<b>4.93</b>	<b>5.04</b>	<b>5.04</b>
6750	<b>3.44</b>	<b>4.53</b>	<b>4.67</b>	<b>4.67</b>
7000	<b>3.08</b>	<b>4.17</b>	<b>4.34</b>	<b>4.34</b>
7500	2.46	<b>3.56</b>	<b>3.78</b>	<b>3.78</b>
8000	1.97	<b>3.04</b>	<b>3.31</b>	<b>3.33</b>
8500	1.58	<b>2.60</b>	<b>2.90</b>	<b>2.95</b>
9000	1.29	2.22	2.55	<b>2.63</b>
9500	1.07	1.90	2.25	2.36
10000	0.89	1.63	2.00	2.12
10500	0.75	1.40	1.78	1.90
11000	0.64	<b>1.21</b>	1.58	1.71
11500	0.55	<b>1.04</b>	1.40	1.55
12000	0.47	<b>0.90</b>	<b>1.24</b>	1.40
12500	0.41	<b>0.77</b>	1.10	1.28
13500		<b>0.58</b>	0.88	1.05
14500		<b>0.45</b>	0.70	0.87
15500			0.55	0.72

**LEGEND**

--- Values below the dotted line are outside the "20D" guide for bridging requirements.

**7.6** Values in **bold type** require High Strength bolts (Grade 8.8)

 For low restraint claddings reduce capacity up to 10%

 For low restraint claddings reduce capacity up to 20%

 For low restraint claddings reduce capacity over 20%. In these situations, refer to software.



1 Single number for bridging refers to the number of rows of bridging per span.

2 1 2 Multiple number for bridging refers to the number of rows of bridging in end and inner spans. (e.g. 2 in end spans, 1 in inner spans).

## 2 SPAN LAPPED CONTINUOUS - INWARD CAPACITY

Bridging Span	S225015					L/150	Bridging Span	S225019					L/150	Bridging Span	S225024					L/150
	0	1	2	3				0	1	2	3				0	1	2	3		
4000	5.14	5.14	5.14	5.14	24.3	4000	<b>9.39</b>	<b>9.39</b>	<b>9.39</b>	<b>9.39</b>	31.8	4000								
4250	4.77	4.77	4.77	4.76	20.3	4250	<b>8.54</b>	<b>8.62</b>	<b>8.62</b>	<b>8.62</b>	26.5	4250	<b>10.1</b>						34.5	
4500	4.43	4.43	4.43	4.43	17.1	4500	<b>7.60</b>	<b>7.94</b>	<b>7.94</b>	<b>7.94</b>	22.3	4500	<b>8.70</b>						29.1	
4750	4.13	4.13	4.13	4.13	14.5	4750	<b>6.64</b>	<b>7.33</b>	<b>7.33</b>	<b>7.33</b>	19.0	4750	<b>7.53</b>						24.7	
5000	3.86	3.86	3.85	3.86	12.4	5000	<b>5.84</b>	<b>6.79</b>	<b>6.79</b>	<b>6.79</b>	16.3	5000	<b>6.58</b>						21.2	
5250	3.61	3.61	3.61	3.61	10.8	5250	<b>5.16</b>	<b>6.31</b>	<b>6.31</b>	<b>6.30</b>	14.1	5250	<b>5.79</b>						18.3	
5500	3.39	3.39	3.39	3.39	9.35	5500	<b>4.58</b>	<b>5.87</b>	<b>5.87</b>	<b>5.87</b>	12.2	5500	<b>5.14</b>						15.9	
5750	3.18	3.18	3.18	3.18	8.18	5750	<b>4.09</b>	<b>5.47</b>	<b>5.47</b>	<b>5.47</b>	10.7	5750	<b>4.59</b>	<b>8.23</b>	<b>8.23</b>	<b>8.23</b>	<b>8.23</b>		13.9	
6000	3.00	3.00	3.00	3.00	7.20	6000	3.67	<b>5.12</b>	<b>5.12</b>	<b>5.12</b>	9.42	6000	<b>4.12</b>	<b>7.56</b>	<b>7.56</b>	<b>7.56</b>	<b>7.56</b>		12.3	
6250	2.83	2.83	2.83	2.83	6.37	6250	3.31	<b>4.79</b>	<b>4.79</b>	<b>4.79</b>	8.34	6250	<b>3.71</b>	<b>6.96</b>	<b>6.96</b>	<b>6.96</b>	<b>6.96</b>		10.8	
6500	2.64	2.67	2.67	2.67	5.67	6500	3.00	<b>4.49</b>	<b>4.49</b>	<b>4.49</b>	7.41	6500	3.36	<b>6.44</b>	<b>6.44</b>	<b>6.44</b>	<b>6.44</b>		9.64	
6750	2.43	2.52	2.52	2.52	5.06	6750	2.73	<b>4.20</b>	<b>4.20</b>	<b>4.20</b>	6.62	6750	3.06	<b>5.97</b>	<b>5.97</b>	<b>5.97</b>	<b>5.97</b>		8.61	
7000	2.22	2.39	2.39	2.39	4.54	7000	2.49	<b>3.93</b>	<b>3.93</b>	<b>3.93</b>	5.94	7000	2.79	<b>5.52</b>	<b>5.55</b>	<b>5.55</b>	<b>5.55</b>		7.72	
7500	1.88	2.15	2.15	2.15	3.69	7500	2.09	<b>3.46</b>	<b>3.46</b>	<b>3.46</b>	4.83	7500	2.35	<b>4.75</b>	<b>4.84</b>	<b>4.84</b>	<b>4.84</b>		6.28	
8000	1.60	1.95	1.95	1.95	3.04	8000	1.78	<b>3.04</b>	<b>3.04</b>	<b>3.04</b>	3.98	8000	2.00	<b>4.13</b>	<b>4.25</b>	<b>4.25</b>	<b>4.25</b>		5.17	
8500	1.37	1.77	1.77	1.77	2.53	8500	1.52	2.69	2.69	2.69	3.32	8500	1.72	<b>3.62</b>	<b>3.77</b>	<b>3.77</b>	<b>3.77</b>		4.31	
9000	1.18	1.61	1.61	1.61	2.13	9000	1.32	2.40	2.40	2.40	2.79	9000	1.49	<b>3.18</b>	<b>3.36</b>	<b>3.36</b>	<b>3.36</b>		3.63	
9500	1.03	1.47	1.47	1.47	1.82	9500	1.15	2.13	2.16	2.16	2.37	9500	1.31	<b>2.80</b>	<b>3.01</b>	<b>3.01</b>	<b>3.01</b>		3.09	
10000	0.90	1.34	1.34	1.34	1.56	10000	1.01	1.91	1.95	1.95	2.04	10000	1.15	<b>2.48</b>	<b>2.72</b>	<b>2.72</b>	<b>2.72</b>		2.65	
10500	0.80	1.21	1.22	1.22	1.34	10500	0.89	1.71	1.77	1.77	1.76	10500	1.02	<b>2.20</b>	<b>2.47</b>	<b>2.47</b>	<b>2.47</b>		2.29	
11000	0.70	1.09	1.12	1.12	1.17	11000	0.79	1.55	1.61	1.61	1.53	11000	0.91	1.96	<b>2.25</b>	<b>2.25</b>	<b>2.25</b>		1.99	
11500	0.62	0.99	1.03	1.03	1.02	11500	0.70	1.39	1.47	1.47	1.34	11500	0.81	1.75	<b>2.05</b>	<b>2.06</b>	<b>2.06</b>		1.74	
12000	0.55	0.91	0.94	0.94	0.90	12000	0.63	1.25	1.35	1.35	1.18	12000	0.73	1.58	1.86	1.89	1.89		1.53	
12500	0.49	0.83	0.87	0.87	0.80	12500	0.56	1.12	1.25	1.25	1.04	12500	0.65	1.42	1.70	1.74	1.74		1.36	
13500		0.69	0.74	0.75	0.63	13500	0.46	0.92	1.06	1.07	0.83	13500	0.54	1.15	1.43	1.49	1.49		1.08	
14500		0.58	0.63	0.65	0.51	14500		0.75	0.90	0.93	0.67	14500	0.45	0.94	1.21	1.29	1.29		0.87	
15500		0.49	0.54	0.57	0.42	15500		0.62	0.77	0.81	0.55	15500		0.77	1.01	1.11	1.11		0.71	



**LEGEND**

- Values below the dotted line are outside the "20D" guide for bridging requirements.
- 7.6** Values in **bold type** require High Strength bolts (Grade 8.8)
-  For low restraint claddings reduce capacity up to 10%
-  For low restraint claddings reduce capacity up to 20%
-  For low restraint claddings reduce capacity over 20%. In these situations, refer to software.
- 1 Single number for bridging refers to the number of rows of bridging per span.
- 2 1 2 Multiple number for bridging refers to the number of rows of bridging in end and inner spans. (e.g. 2 in end spans, 1 in inner spans).

## 2 SPAN LAPPED CONTINUOUS - OUTWARD CAPACITY

Bridging Span	SZ25015				Bridging Span	SZ25019				Bridging Span	SZ25024			
	0	1	2	3		0	1	2	3		0	1	2	3
4000	5.14	5.14	5.14	5.14	4000	<b>9.39</b>	<b>9.39</b>	<b>9.39</b>	<b>9.39</b>	4000				
4250	4.77	4.77	4.77	4.77	4250	<b>8.62</b>	<b>8.62</b>	<b>8.62</b>	<b>8.62</b>	4250				
4500	4.43	4.43	4.43	4.43	4500	<b>7.94</b>	<b>7.94</b>	<b>7.94</b>	<b>7.94</b>	4500				
4750	4.13	4.13	4.13	4.12	4750	<b>7.33</b>	<b>7.33</b>	<b>7.33</b>	<b>7.33</b>	4750				
5000	3.86	3.86	3.85	3.86	5000	<b>6.79</b>	<b>6.79</b>	<b>6.79</b>	<b>6.79</b>	5000				
5250	3.61	3.61	3.61	3.61	5250	<b>6.31</b>	<b>6.31</b>	<b>6.31</b>	<b>6.31</b>	5250				
5500	3.39	3.39	3.39	3.39	5500	<b>5.87</b>	<b>5.87</b>	<b>5.87</b>	<b>5.87</b>	5500	<b>8.26</b>			
5750	3.18	3.18	3.18	3.18	5750	<b>5.39</b>	<b>5.47</b>	<b>5.47</b>	<b>5.48</b>	5750	<b>7.30</b>	<b>8.23</b>	<b>8.23</b>	<b>8.23</b>
6000	3.00	3.00	3.00	3.00	6000	<b>4.88</b>	<b>5.12</b>	<b>5.12</b>	<b>5.12</b>	6000	<b>6.47</b>	<b>7.56</b>	<b>7.56</b>	<b>7.56</b>
6250	2.83	2.83	2.83	2.82	6250	<b>4.36</b>	<b>4.79</b>	<b>4.79</b>	<b>4.79</b>	6250	<b>5.74</b>	<b>6.96</b>	<b>6.96</b>	<b>6.96</b>
6500	2.67	2.67	2.67	2.67	6500	<b>3.85</b>	<b>4.49</b>	<b>4.49</b>	<b>4.49</b>	6500	<b>5.09</b>	<b>6.44</b>	<b>6.44</b>	<b>6.44</b>
6750	2.50	2.52	2.52	2.52	6750	<b>3.42</b>	<b>4.20</b>	<b>4.20</b>	<b>4.19</b>	6750	<b>4.53</b>	<b>5.97</b>	<b>5.97</b>	<b>5.97</b>
7000	2.29	2.39	2.39	2.39	7000	<b>3.04</b>	<b>3.93</b>	<b>3.92</b>	<b>3.92</b>	7000	<b>4.01</b>	<b>5.49</b>	<b>5.55</b>	<b>5.55</b>
7500	1.86	2.15	2.15	2.15	7500	2.40	<b>3.45</b>	<b>3.46</b>	<b>3.46</b>	7500	<b>3.15</b>	<b>4.68</b>	<b>4.84</b>	<b>4.84</b>
8000	1.48	1.95	1.95	1.95	8000	1.90	<b>2.97</b>	<b>3.04</b>	<b>3.04</b>	8000	2.49	<b>4.01</b>	<b>4.25</b>	<b>4.25</b>
8500	1.19	1.77	1.77	1.77	8500	1.51	2.57	2.69	2.69	8500	2.00	<b>3.46</b>	<b>3.77</b>	<b>3.77</b>
9000	0.96	1.57	1.61	1.61	9000	1.22	2.22	2.40	2.40	9000	1.62	<b>2.95</b>	<b>3.36</b>	<b>3.36</b>
9500	0.79	1.38	1.47	1.47	9500	1.00	1.89	2.16	2.16	9500	1.33	<b>2.52</b>	<b>2.97</b>	<b>3.01</b>
10000	0.65	1.20	1.34	1.34	10000	0.83	1.61	1.94	1.95	10000	1.11	<b>2.15</b>	<b>2.63</b>	<b>2.72</b>
10500	0.54	1.04	1.20	1.22	10500	0.69	1.37	1.73	1.77	10500	0.93	1.84	<b>2.34</b>	<b>2.47</b>
11000	0.45	0.89	1.08	1.12	11000	0.58	1.17	1.55	1.61	11000	0.79	1.56	<b>2.09</b>	<b>2.25</b>
11500		0.77	0.98	1.03	11500	0.50	1.00	1.39	1.47	11500	0.67	1.33	1.86	2.04
12000		0.65	0.89	0.94	12000	0.42	0.85	1.24	1.35	12000	0.58	1.13	1.65	1.85
12500		0.56	0.80	0.86	12500		0.72	1.10	1.24	12500	0.50	0.97	1.46	1.68
13500		0.42	0.64	0.72	13500		0.54	0.85	1.03	13500		0.73	1.15	1.39
14500			0.51	0.61	14500		0.41	0.67	0.86	14500		0.56	0.90	1.15
15500			0.40	0.52	15500			0.52	0.71	15500		0.43	0.70	0.95



**LEGEND**

- Values below the dotted line are outside the "20D" guide for bridging requirements.
- 7.6** Values in **bold type** require High Strength bolts (Grade 8.8)
-  For low restraint claddings reduce capacity up to 10%
-  For low restraint claddings reduce capacity up to 20%
-  For low restraint claddings reduce capacity over 20%. In these situations, refer to software.
- 1 Single number for bridging refers to the number of rows of bridging per span.
- 2 1 2 Multiple number for bridging refers to the number of rows of bridging in end and inner spans. (e.g. 2 in end spans, 1 in inner spans).

## 2 SPAN LAPPED - INWARD CAPACITY

Bridging Span	SZ30019					Bridging Span	SZ30024					Bridging Span	SZ30030				
	0	1	2	3	L/150		0	1	2	3	L/150		0	1	2	3	L/150
4000	9.04	9.04	9.04	9.03	54.7	4000	16.6	16.6	16.6	16.6	71.2	4000					
4250	8.39	8.39	8.39	8.39	45.6	4250	15.3	15.3	15.3	15.3	59.4	4250	19.7				75.7
4500	7.82	7.82	7.82	7.82	38.4	4500	13.6	14.1	14.1	14.1	50.0	4500	16.5				63.8
4750	7.30	7.30	7.30	7.30	32.6	4750	11.8	13.1	13.1	13.1	42.5	4750	14.0				54.2
5000	6.84	6.84	6.84	6.84	28.0	5000	10.3	12.1	12.1	12.1	36.5	5000	12.0				46.5
5250	6.42	6.42	6.42	6.42	24.2	5250	8.96	11.3	11.3	11.3	31.5	5250	10.4				40.2
5500	6.04	6.04	6.04	6.04	21.0	5500	7.87	10.6	10.6	10.6	27.4	5500	9.11	16.4	16.4	16.4	34.9
5750	5.69	5.69	5.69	5.69	18.4	5750	6.95	9.87	9.87	9.87	24.0	5750	8.02	15.1	15.1	15.1	30.6
6000	5.31	5.37	5.37	5.37	16.2	6000	6.18	9.25	9.24	9.25	21.1	6000	7.11	14.0	14.0	14.0	26.9
6250	4.85	5.07	5.07	5.07	14.3	6250	5.53	8.68	8.68	8.67	18.7	6250	6.35	13.0	13.0	13.0	23.8
6500	4.38	4.80	4.80	4.80	12.7	6500	4.97	8.16	8.16	8.16	16.6	6500	5.70	12.0	12.0	12.0	21.2
6750	3.97	4.55	4.55	4.55	11.4	6750	4.49	7.68	7.68	7.68	14.8	6750	5.14	11.1	11.1	11.1	18.9
7000	3.61	4.32	4.32	4.32	10.2	7000	4.07	7.25	7.24	7.24	13.3	7000	4.66	10.3	10.3	10.3	16.9
7500	3.03	3.91	3.91	3.91	8.29	7500	3.40	6.42	6.42	6.42	10.8	7500	3.87	8.91	9.00	9.00	13.8
8000	2.57	3.55	3.55	3.55	6.83	8000	2.87	5.71	5.71	5.71	8.90	8000	3.27	7.76	7.91	7.91	11.3
8500	2.20	3.23	3.23	3.23	5.70	8500	2.46	5.10	5.10	5.10	7.42	8500	2.79	6.81	7.01	7.01	9.46
9000	1.91	2.96	2.96	2.96	4.80	9000	2.13	4.51	4.55	4.55	6.25	9000	2.41	6.02	6.25	6.25	7.97
9500	1.67	2.72	2.72	2.72	4.08	9500	1.85	4.01	4.08	4.08	5.32	9500	2.11	5.32	5.61	5.61	6.78
10000	1.47	2.50	2.50	2.50	3.50	10000	1.63	3.59	3.68	3.68	4.56	10000	1.85	4.73	5.06	5.06	5.81
10500	1.30	2.30	2.30	2.30	3.02	10500	1.44	3.23	3.34	3.34	3.94	10500	1.64	4.21	4.59	4.59	5.02
11000	1.15	2.11	2.11	2.11	2.63	11000	1.28	2.93	3.05	3.05	3.42	11000	1.46	3.77	4.18	4.18	4.37
11500	1.03	1.94	1.95	1.95	2.30	11500	1.15	2.66	2.79	2.79	3.00	11500	1.31	3.38	3.83	3.83	3.82
12000	0.93	1.77	1.80	1.80	2.02	12000	1.03	2.41	2.56	2.56	2.64	12000	1.18	3.04	3.52	3.52	3.36
12500	0.84	1.62	1.67	1.67	1.79	12500	0.93	2.18	2.36	2.36	2.33	12500	1.07	2.74	3.24	3.24	2.98
13500	0.69	1.38	1.43	1.43	1.42	13500	0.77	1.81	2.02	2.02	1.85	13500	0.88	2.26	2.77	2.78	2.36
14500	0.57	1.17	1.24	1.24	1.15	14500	0.64	1.52	1.75	1.75	1.50	14500	0.74	1.87	2.37	2.41	1.91
15500	0.48	1.00	1.08	1.08	0.94	15500	0.55	1.28	1.53	1.53	1.22	15500	0.63	1.57	2.05	2.11	1.56



**LEGEND**

- Values below the dotted line are outside the "20D" guide for bridging requirements.
- 7.6** Values in **bold type** require High Strength bolts (Grade 8.8)
-  For low restraint claddings reduce capacity up to 10%
-  For low restraint claddings reduce capacity up to 20%
-  For low restraint claddings reduce capacity over 20%. In these situations, refer to software.
- 1 Single number for bridging refers to the number of rows of bridging per span.
- 2 1 2 Multiple number for bridging refers to the number of rows of bridging in end and inner spans. (e.g. 2 in end spans, 1 in inner spans).

## 2 SPAN LAPPED - OUTWARD CAPACITY

Bridging Span	SZ30019				Bridging Span	SZ30024				Bridging Span	SZ30030			
	0	1	2	3		0	1	2	3		0	1	2	3
4000	9.04	9.04	9.04	9.03	4000	<b>16.6</b>	<b>16.6</b>	<b>16.6</b>	<b>16.6</b>	4000				
4250	8.39	8.39	8.39	8.39	4250	<b>15.3</b>	<b>15.3</b>	<b>15.3</b>	<b>15.3</b>	4250				
4500	7.82	7.82	7.82	7.82	4500	<b>14.1</b>	<b>14.1</b>	<b>14.1</b>	<b>14.1</b>	4500				
4750	7.30	7.30	7.30	7.30	4750	<b>13.1</b>	<b>13.1</b>	<b>13.1</b>	<b>13.1</b>	4750				
5000	6.84	6.84	6.84	6.84	5000	<b>12.1</b>	<b>12.1</b>	<b>12.1</b>	<b>12.1</b>	5000				
5250	6.42	6.42	6.42	6.42	5250	<b>11.3</b>	<b>11.3</b>	<b>11.3</b>	<b>11.3</b>	5250				
5500	6.04	6.04	6.04	6.04	5500	<b>10.6</b>	<b>10.6</b>	<b>10.6</b>	<b>10.6</b>	5500	<b>16.4</b>	<b>16.4</b>	<b>16.4</b>	<b>16.4</b>
5750	5.69	5.69	5.69	5.69	5750	<b>9.87</b>	<b>9.87</b>	<b>9.87</b>	<b>9.87</b>	5750	<b>15.1</b>	<b>15.1</b>	<b>15.1</b>	<b>15.1</b>
6000	5.37	5.37	5.37	5.37	6000	<b>9.25</b>	<b>9.25</b>	<b>9.25</b>	<b>9.25</b>	6000	<b>13.7</b>	<b>14.0</b>	<b>14.0</b>	<b>14.0</b>
6250	5.07	5.07	5.07	5.07	6250	<b>8.68</b>	<b>8.68</b>	<b>8.68</b>	<b>8.67</b>	6250	<b>12.5</b>	<b>13.0</b>	<b>13.0</b>	<b>13.0</b>
6500	4.80	4.80	4.80	4.80	6500	<b>8.16</b>	<b>8.16</b>	<b>8.16</b>	<b>8.16</b>	6500	<b>11.5</b>	<b>12.0</b>	<b>12.0</b>	<b>12.0</b>
6750	4.55	4.55	4.55	4.55	6750	<b>7.68</b>	<b>7.68</b>	<b>7.68</b>	<b>7.68</b>	6750	<b>10.5</b>	<b>11.1</b>	<b>11.1</b>	<b>11.1</b>
7000	4.32	4.32	4.32	4.32	7000	<b>7.14</b>	<b>7.25</b>	<b>7.24</b>	<b>7.24</b>	7000	<b>9.57</b>	<b>10.3</b>	<b>10.3</b>	<b>10.3</b>
7500	3.91	3.91	3.91	3.91	7500	<b>6.10</b>	<b>6.42</b>	<b>6.42</b>	<b>6.42</b>	7500	<b>7.94</b>	<b>9.00</b>	<b>9.00</b>	<b>9.00</b>
8000	3.55	3.55	3.55	3.55	8000	5.09	<b>5.71</b>	<b>5.71</b>	<b>5.71</b>	8000	<b>6.59</b>	<b>7.91</b>	<b>7.91</b>	<b>7.91</b>
8500	3.16	3.23	3.23	3.23	8500	4.23	5.10	5.10	5.10	8500	<b>5.48</b>	<b>7.00</b>	<b>7.01</b>	<b>7.01</b>
9000	2.71	2.96	2.96	2.96	9000	3.51	4.55	4.55	4.55	9000	<b>4.56</b>	<b>6.17</b>	<b>6.25</b>	<b>6.25</b>
9500	2.28	2.72	2.72	2.72	9500	2.92	4.05	4.08	4.08	9500	3.81	<b>5.47</b>	<b>5.61</b>	<b>5.61</b>
10000	1.90	2.50	2.50	2.50	10000	2.45	3.60	3.68	3.68	10000	3.18	<b>4.87</b>	<b>5.06</b>	<b>5.06</b>
10500	1.59	2.30	2.30	2.30	10500	2.07	3.22	3.34	3.34	10500	2.66	<b>4.36</b>	<b>4.59</b>	<b>4.59</b>
11000	1.35	2.09	2.11	2.11	11000	1.74	2.90	3.05	3.05	11000	2.24	3.88	<b>4.18</b>	<b>4.19</b>
11500	1.15	1.89	1.95	1.94	11500	1.48	2.61	2.79	2.79	11500	1.91	3.44	3.82	<b>3.83</b>
12000	0.98	1.71	1.80	1.80	12000	1.26	2.33	2.56	2.56	12000	1.63	3.05	3.48	3.52
12500	0.84	1.54	1.67	1.67	12500	1.09	2.07	2.35	2.36	12500	1.41	2.71	3.17	3.24
13500	0.63	1.23	1.41	1.43	13500	0.82	1.62	1.97	2.02	13500	1.07	2.13	2.67	2.78
14500	0.49	0.98	1.20	1.24	14500	0.63	1.27	1.67	1.75	14500	0.83	1.68	2.25	2.39
15500		0.77	1.03	1.08	15500	0.50	1.00	1.43	1.53	15500	0.66	1.32	1.88	2.06

### LEGEND

- Values below the dotted line are outside the "20D" guide for bridging requirements.
- 7.6** Values in **bold type** require High Strength bolts (Grade 8.8)
-  For low restraint claddings reduce capacity up to 10%
-  For low restraint claddings reduce capacity up to 20%
-  For low restraint claddings reduce capacity over 20%. In these situations, refer to software.
- 1 Single number for bridging refers to the number of rows of bridging per span.
- 2 1 2 Multiple number for bridging refers to the number of rows of bridging in end and inner spans. (e.g. 2 in end spans, 1 in inner spans).

## 4 SPAN LAPPED - INWARD CAPACITY

Bridging Span	Z10010					L/150	Bridging Span	Z10012					L/150	Bridging Span	Z10015					L/150
	0	1	2	3	0			1	2	3	0	1			2	3				
2000	6.49	6.49	6.49	6.49	9.40	2000	8.44	8.60	8.60	8.60	11.4	2000	10.3	11.2	11.2	11.2	14.5			
2250	5.44	5.44	5.44	5.44	6.60	2250	6.56	6.80	6.80	6.80	7.98	2250	8.01	8.85	8.85	8.85	10.2			
2500	4.54	4.54	4.54	4.54	4.81	2500	5.23	5.51	5.51	5.51	5.82	2500	6.39	7.17	7.17	7.17	7.41			
2750	3.75	3.75	3.75	3.75	3.62	2750	4.26	4.55	4.55	4.55	4.37	2750	5.21	5.93	5.93	5.93	5.56			
3000	3.11	3.15	3.15	3.15	2.79	3000	3.54	3.82	3.82	3.82	3.37	3000	4.33	4.98	4.98	4.98	4.29			
3250	2.62	2.69	2.69	2.69	2.19	3250	2.97	3.26	3.26	3.26	2.65	3250	3.64	4.24	4.24	4.24	3.37			
3500	2.22	2.31	2.31	2.31	1.75	3500	2.53	2.81	2.81	2.81	2.12	3500	3.11	3.66	3.66	3.66	2.70			
3750	1.91	2.02	2.02	2.02	1.43	3750	2.17	2.45	2.45	2.45	1.72	3750	2.68	3.19	3.19	3.19	2.19			
4000	1.66	1.77	1.77	1.77	1.18	4000	1.89	2.15	2.15	2.15	1.42	4000	2.33	2.80	2.80	2.80	1.81			
4250	1.44	1.57	1.57	1.57	0.98	4250	1.65	1.91	1.91	1.91	1.18	4250	2.04	2.48	2.48	2.48	1.51			
4500	1.27	1.40	1.40	1.40	0.83	4500	1.45	1.70	1.70	1.70	1.00	4500	1.80	2.21	2.21	2.21	1.27			
4750	1.12	1.26	1.26	1.26	0.70	4750	1.28	1.53	1.53	1.53	0.85	4750	1.60	1.99	1.99	1.99	1.08			
5000	0.99	1.13	1.13	1.13	0.60	5000	1.14	1.38	1.38	1.38	0.73	5000	1.42	1.79	1.79	1.79	0.93			
5250	0.88	1.03	1.03	1.03	0.52	5250	1.01	1.25	1.25	1.25	0.63	5250	1.28	1.62	1.63	1.63	0.80			
5500	0.79	0.94	0.94	0.94	0.45	5500	0.91	1.14	1.14	1.14	0.55	5500	1.15	1.46	1.48	1.48	0.70			
5750	0.70	0.86	0.86	0.86	0.40	5750	0.81	1.04	1.04	1.04	0.48	5750	1.04	1.33	1.36	1.36	0.61			
6000	0.63	0.79	0.79	0.79	0.35	6000	0.73	0.96	0.96	0.96	0.42	6000	0.94	1.22	1.25	1.25	0.54			
6250	0.57	0.73	0.73	0.73	0.31	6250	0.66	0.88	0.88	0.88	0.37	6250	0.85	1.12	1.15	1.15	0.47			
6500	0.51	0.67	0.67	0.67	0.27	6500	0.60	0.81	0.81	0.81	0.33	6500	0.78	1.02	1.06	1.06	0.42			
6750	0.46	0.62	0.62	0.62	0.25	6750	0.54	0.76	0.76	0.76	0.30	6750	0.71	0.94	0.98	0.98	0.38			
7000	0.42	0.58	0.58	0.58	0.22	7000	0.49	0.70	0.70	0.70	0.27	7000	0.64	0.87	0.92	0.92	0.34			
7500		0.50	0.50	0.50	0.18	7500	0.41	0.60	0.61	0.61	0.22	7500	0.54	0.75	0.79	0.80	0.27			
8000		0.44	0.44	0.44	0.15	8000		0.52	0.54	0.54	0.18	8000	0.45	0.65	0.69	0.70	0.23			

Bridging Span	Z10019				
	0	1	2	3	L/150
2000	13.6	15.7	15.7	15.7	18.7
2250	10.5	12.4	12.4	12.4	13.1
2500	8.32	10.0	10.0	10.0	9.56
2750	6.75	8.29	8.29	8.29	7.18
3000	5.58	6.97	6.97	6.97	5.53
3250	4.68	5.94	5.94	5.94	4.35
3500	3.98	5.12	5.12	5.12	3.48
3750	3.42	4.46	4.46	4.46	2.83
4000	2.97	3.91	3.92	3.92	2.33
4250	2.60	3.45	3.47	3.47	1.95
4500	2.29	3.05	3.10	3.10	1.64
4750	2.03	2.72	2.78	2.78	1.39
5000	1.81	2.44	2.51	2.51	1.20
5250	1.62	2.20	2.28	2.28	1.03
5500	1.46	1.99	2.07	2.07	0.90
5750	1.32	1.81	1.90	1.90	0.79
6000	1.20	1.65	1.74	1.74	0.69
6250	1.09	1.51	1.61	1.61	0.61
6500	0.99	1.39	1.48	1.48	0.54
6750	0.91	1.28	1.37	1.38	0.49
7000	0.83	1.18	1.27	1.28	0.44
7500	0.70	1.01	1.09	1.11	0.35
8000	0.59	0.87	0.94	0.98	0.29

**LEGEND**

--- Values below the dotted line are outside the "20D" guide for bridging requirements.

**7.6** Values in **bold type** require High Strength bolts (Grade 8.8)

 For low restraint claddings reduce capacity up to 10%

 For low restraint claddings reduce capacity up to 20%

 For low restraint claddings reduce capacity over 20%. In these situations, refer to software.

1 Single number for bridging refers to the number of rows of bridging per span.

2 1 2 Multiple number for bridging refers to the number of rows of bridging in end and inner spans. (e.g. 2 in end spans, 1 in inner spans).

#### 4 SPAN LAPPED - OUTWARD CAPACITY

Bridging Span	Z10010				Bridging Span	Z10012				Bridging Span	Z10015			
	0	1	2	3		0	1	2	3		0	1	2	3
2000	6.49	6.49	6.49	6.49	2000	8.60	8.60	8.60	8.60	2000	11.2	11.2	11.2	11.2
2250	5.44	5.44	5.44	5.44	2250	6.80	6.80	6.80	6.80	2250	8.79	8.85	8.85	8.85
2500	4.54	4.54	4.54	4.54	2500	5.51	5.51	5.51	5.51	2500	6.93	7.17	7.17	7.17
2750	3.75	3.75	3.75	3.75	2750	4.42	4.55	4.55	4.55	2750	5.56	5.93	5.93	5.93
3000	3.03	3.15	3.15	3.15	3000	3.56	3.82	3.82	3.82	3000	4.52	4.98	4.98	4.98
3250	2.44	2.69	2.69	2.69	3250	2.89	3.26	3.26	3.26	3250	3.71	4.24	4.24	4.24
3500	1.97	2.31	2.31	2.31	3500	2.35	2.81	2.81	2.81	3500	3.07	3.63	3.66	3.66
3750	1.59	2.02	2.02	2.02	3750	1.93	2.45	2.45	2.45	3750	2.56	3.10	3.19	3.19
4000	1.29	1.77	1.77	1.77	4000	1.58	2.14	2.15	2.15	4000	2.14	2.68	2.80	2.80
4250	1.04	1.57	1.57	1.57	4250	1.30	1.84	1.91	1.91	4250	1.79	2.32	2.48	2.48
4500	0.85	1.35	1.40	1.40	4500	1.07	1.59	1.70	1.70	4500	1.48	2.02	2.21	2.21
4750	0.71	1.17	1.26	1.26	4750	0.90	1.38	1.53	1.53	4750	1.23	1.77	1.96	1.99
5000	0.59	1.01	1.13	1.13	5000	0.76	1.21	1.38	1.38	5000	1.03	1.56	1.75	1.79
5250	0.50	0.88	1.03	1.03	5250	0.64	1.05	1.25	1.25	5250	0.87	1.38	1.56	1.63
5500	0.43	0.76	0.94	0.94	5500	0.54	0.92	1.11	1.14	5500	0.75	1.22	1.40	1.48
5750		0.66	0.85	0.86	5750	0.47	0.80	1.00	1.04	5750	0.64	1.08	1.26	1.35
6000		0.57	0.76	0.79	6000	0.40	0.70	0.89	0.96	6000	0.55	0.96	1.14	1.22
6250		0.49	0.68	0.73	6250		0.61	0.80	0.88	6250	0.48	0.85	1.03	1.11
6500		0.43	0.61	0.67	6500		0.54	0.72	0.81	6500	0.41	0.75	0.93	1.02
6750			0.55	0.62	6750		0.47	0.65	0.74	6750		0.66	0.85	0.93
7000			0.49	0.58	7000		0.42	0.59	0.68	7000		0.58	0.77	0.85
7500				0.48	7500			0.48	0.57	7500		0.45	0.64	0.72
8000				0.40	8000				0.48	8000			0.54	0.62

Bridging Span	Z10019			
	0	1	2	3
2000	15.7	15.7	15.7	15.7
2250	12.1	12.4	12.4	12.4
2500	9.52	10.0	10.0	10.0
2750	7.60	8.29	8.29	8.29
3000	6.14	6.97	6.97	6.97
3250	5.02	5.93	5.94	5.94
3500	4.14	5.02	5.12	5.12
3750	3.44	4.28	4.46	4.46
4000	2.88	3.68	3.92	3.92
4250	2.42	3.18	3.47	3.47
4500	2.04	2.77	3.07	3.10
4750	1.70	2.42	2.71	2.78
5000	1.43	2.12	2.41	2.51
5250	1.20	1.87	2.15	2.28
5500	1.03	1.65	1.92	2.06
5750	0.88	1.46	1.73	1.86
6000	0.76	1.30	1.56	1.69
6250	0.67	1.15	1.41	1.54
6500	0.58	1.03	1.27	1.40
6750	0.52	0.91	1.15	1.28
7000	0.46	0.81	1.05	1.17
7500		0.63	0.87	0.99
8000		0.50	0.73	0.84

**LEGEND**

--- Values below the dotted line are outside the "20D" guide for bridging requirements.

**7.6** Values in **bold type** require High Strength bolts (Grade 8.8)

 For low restraint claddings reduce capacity up to 10%

 For low restraint claddings reduce capacity up to 20%

 For low restraint claddings reduce capacity over 20%  
In these situations, refer to software.



1 Single number for bridging refers to the number of rows of bridging per span.

2 1 2 Multiple number for bridging refers to the number of rows of bridging in end and inner spans. (e.g. 2 in end spans, 1 in inner spans).

#### 4 SPAN LAPPED - MIXED GAUGES - INWARD CAPACITY

Bridging Span	Z10010/Z10012					L/150	Bridging Span	Z10012/Z10015					L/150	Bridging Span	Z10015/Z10019					L/150
	0	1	2	3				0	1	2	3				0	1	2	3		
2000	6.80	6.80	6.80	6.80	11.1	2000	8.73	8.84	8.84	8.84	14.0	2000	10.7	11.5	11.5	11.5	18.0			
2250	5.64	5.63	5.63	5.63	7.78	2250	6.78	6.99	6.99	6.99	9.82	2250	8.31	9.11	9.11	9.11	12.6			
2500	4.64	4.64	4.64	4.64	5.67	2500	5.41	5.66	5.66	5.66	7.16	2500	6.64	7.38	7.38	7.38	9.22			
2750	3.83	3.83	3.83	3.83	4.26	2750	4.41	4.68	4.68	4.68	5.38	2750	5.42	6.10	6.10	6.10	6.93			
3000	3.19	3.22	3.22	3.22	3.28	3000	3.66	3.93	3.93	3.93	4.14	3000	4.50	5.13	5.13	5.13	5.34			
3250	2.68	2.75	2.75	2.75	2.58	3250	3.07	3.35	3.35	3.35	3.26	3250	3.79	4.37	4.37	4.37	4.20			
3500	2.28	2.37	2.37	2.37	2.07	3500	2.62	2.89	2.89	2.89	2.61	3500	3.23	3.76	3.76	3.76	3.36			
3750	1.96	2.06	2.06	2.06	1.68	3750	2.25	2.51	2.51	2.51	2.12	3750	2.79	3.28	3.28	3.28	2.73			
4000	1.70	1.81	1.81	1.81	1.38	4000	1.95	2.21	2.21	2.21	1.75	4000	2.42	2.88	2.88	2.88	2.25			
4250	1.48	1.61	1.61	1.61	1.15	4250	1.71	1.96	1.96	1.96	1.46	4250	2.12	2.55	2.55	2.55	1.88			
4500	1.30	1.43	1.43	1.43	0.97	4500	1.50	1.75	1.75	1.75	1.23	4500	1.87	2.28	2.28	2.28	1.58			
4750	1.15	1.29	1.29	1.29	0.83	4750	1.33	1.57	1.57	1.57	1.04	4750	1.66	2.04	2.04	2.04	1.34			
5000	1.02	1.16	1.16	1.16	0.71	5000	1.18	1.42	1.42	1.42	0.90	5000	1.49	1.85	1.85	1.85	1.15			
5250	0.91	1.05	1.05	1.05	0.61	5250	1.05	1.28	1.28	1.28	0.77	5250	1.33	1.67	1.67	1.67	1.00			
5500	0.81	0.96	0.96	0.96	0.53	5500	0.94	1.17	1.17	1.17	0.67	5500	1.20	1.52	1.52	1.52	0.87			
5750	0.73	0.88	0.88	0.88	0.47	5750	0.85	1.07	1.07	1.07	0.59	5750	1.08	1.39	1.40	1.40	0.76			
6000	0.65	0.81	0.81	0.81	0.41	6000	0.77	0.98	0.98	0.98	0.52	6000	0.98	1.27	1.28	1.28	0.67			
6250	0.59	0.74	0.74	0.74	0.36	6250	0.69	0.91	0.91	0.91	0.46	6250	0.89	1.16	1.18	1.18	0.59			
6500	0.53	0.69	0.69	0.69	0.32	6500	0.63	0.84	0.84	0.84	0.41	6500	0.82	1.07	1.09	1.09	0.52			
6750	0.48	0.64	0.64	0.64	0.29	6750	0.57	0.78	0.78	0.78	0.36	6750	0.74	0.99	1.01	1.01	0.47			
7000	0.43	0.59	0.59	0.59	0.26	7000	0.52	0.72	0.72	0.72	0.33	7000	0.68	0.91	0.94	0.94	0.42			
7500		0.52	0.52	0.52	0.21	7500	0.43	0.63	0.63	0.63	0.27	7500	0.57	0.78	0.82	0.82	0.34			
8000		0.45	0.45	0.45	0.17	8000		0.55	0.55	0.55	0.22	8000	0.48	0.68	0.72	0.72	0.28			

**LEGEND**

- Values below the dotted line are outside the "20D" guide for bridging requirements.
- 7.6** Values in **bold type** require High Strength bolts (Grade 8.8)
-  For low restraint claddings reduce capacity up to 10%
-  For low restraint claddings reduce capacity up to 20%
-  For low restraint claddings reduce capacity over 20%. In these situations, refer to software.
- 1 Single number for bridging refers to the number of rows of bridging per span.
- 2 1 2 Multiple number for bridging refers to the number of rows of bridging in end and inner spans. (e.g. 2 in end spans, 1 in inner spans).



#### 4 SPAN LAPPED - MIXED GAUGES - OUTWARD CAPACITY

Bridging Span	Z10010/Z10012				Bridging Span	Z10012/Z10015				Bridging Span	Z10015/Z10019			
	0	1	2	3		0	1	2	3		0	1	2	3
2000	6.80	6.80	6.80	6.80	2000	8.84	8.84	8.84	8.84	2000	11.5	11.5	11.5	11.5
2250	5.64	5.63	5.63	5.63	2250	6.99	6.99	6.99	6.99	2250	9.11	9.11	9.11	9.11
2500	4.64	4.64	4.64	4.64	2500	5.66	5.66	5.66	5.66	2500	7.34	7.38	7.38	7.38
2750	3.83	3.83	3.83	3.83	2750	4.68	4.68	4.68	4.68	2750	5.92	6.10	6.10	6.10
3000	3.22	3.22	3.22	3.22	3000	3.85	3.93	3.93	3.93	3000	4.85	5.13	5.13	5.13
3250	2.62	2.75	2.75	2.75	3250	3.16	3.35	3.35	3.35	3250	4.02	4.37	4.37	4.37
3500	2.14	2.37	2.37	2.37	3500	2.62	2.89	2.89	2.89	3500	3.37	3.76	3.76	3.76
3750	1.76	2.06	2.06	2.06	3750	2.18	2.51	2.51	2.51	3750	2.84	3.28	3.28	3.28
4000	1.45	1.81	1.81	1.81	4000	1.82	2.21	2.21	2.21	4000	2.42	2.85	2.88	2.88
4250	1.19	1.61	1.61	1.61	4250	1.53	1.96	1.96	1.96	4250	2.07	2.48	2.55	2.55
4500	0.98	1.43	1.43	1.43	4500	1.29	1.73	1.75	1.75	4500	1.78	2.18	2.28	2.28
4750	0.81	1.26	1.29	1.29	4750	1.09	1.51	1.57	1.57	4750	1.53	1.92	2.04	2.04
5000	0.68	1.10	1.16	1.16	5000	0.92	1.33	1.42	1.42	5000	1.32	1.70	1.85	1.85
5250	0.58	0.96	1.05	1.05	5250	0.79	1.17	1.28	1.28	5250	1.13	1.51	1.66	1.67
5500	0.50	0.84	0.96	0.96	5500	0.68	1.04	1.17	1.17	5500	0.97	1.35	1.50	1.52
5750	0.43	0.74	0.88	0.88	5750	0.59	0.92	1.07	1.07	5750	0.84	1.21	1.35	1.40
6000		0.64	0.81	0.81	6000	0.52	0.82	0.97	0.98	6000	0.73	1.08	1.23	1.28
6250		0.56	0.73	0.74	6250	0.45	0.72	0.88	0.91	6250	0.64	0.98	1.11	1.18
6500		0.49	0.66	0.69	6500		0.64	0.80	0.84	6500	0.57	0.88	1.02	1.08
6750		0.43	0.59	0.64	6750		0.57	0.72	0.78	6750	0.50	0.79	0.93	0.99
7000			0.54	0.59	7000		0.51	0.66	0.72	7000	0.45	0.72	0.85	0.92
7500			0.44	0.52	7500		0.41	0.55	0.62	7500		0.59	0.72	0.78
8000				0.44	8000			0.46	0.53	8000		0.47	0.61	0.67

#### LEGEND

--- Values below the dotted line are outside the "20D" guide for bridging requirements.

**7.6** Values in **bold type** require High Strength bolts (Grade 8.8)

 For low restraint claddings reduce capacity up to 10%

 For low restraint claddings reduce capacity up to 20%

 For low restraint claddings reduce capacity over 20%  
In these situations, refer to software.

1 Single number for bridging refers to the number of rows of bridging per span.

2 1 2 Multiple number for bridging refers to the number of rows of bridging in end and inner spans. (e.g. 2 in end spans, 1 in inner spans).

### 4 SPAN LAPPED - INWARD CAPACITY

Bridging Span	SZ15010					L/150	Bridging Span	SZ15012					L/150	Bridging Span	SZ15015					L/150
	0	1	2	3	0			1	2	3	0	1			2	3				
2000	5.95	5.95	5.95	5.95	27.1	2000	9.84	9.84	9.84	9.84	34.2	2000	16.9	16.9	16.9	16.9	43.5			
2250	5.22	5.22	5.22	5.22	19.0	2250	8.55	8.55	8.54	8.54	24.0	2250	14.3	14.3	14.3	14.3	30.5			
2500	4.63	4.63	4.63	4.63	13.9	2500	7.51	7.50	7.50	7.50	17.5	2500	12.3	12.3	12.3	12.3	22.3			
2750	4.15	4.15	4.15	4.15	10.4	2750	6.65	6.64	6.64	6.64	13.1	2750	10.4	10.7	10.7	10.7	16.7			
3000	3.74	3.74	3.74	3.74	8.02	3000	5.93	5.93	5.93	5.93	10.1	3000	8.64	9.33	9.33	9.33	12.9			
3250	3.39	3.40	3.39	3.39	6.31	3250	5.32	5.32	5.32	5.32	7.97	3250	7.21	8.16	8.16	8.16	10.1			
3500	3.09	3.09	3.09	3.09	5.05	3500	4.80	4.80	4.80	4.80	6.38	3500	6.09	7.09	7.10	7.09	8.11			
3750	2.84	2.84	2.83	2.82	4.11	3750	4.35	4.35	4.35	4.33	5.19	3750	5.21	6.21	6.21	6.21	6.59			
4000	2.61	2.61	2.61	2.60	3.39	4000	3.88	3.97	3.97	3.96	4.27	4000	4.49	5.46	5.46	5.46	5.43			
4250	2.41	2.41	2.41	2.41	2.82	4250	3.42	3.63	3.63	3.63	3.56	4250	3.91	4.83	4.83	4.83	4.53			
4500	2.23	2.23	2.23	2.23	2.38	4500	3.00	3.31	3.31	3.31	3.00	4500	3.43	4.31	4.31	4.31	3.82			
4750	2.07	2.07	2.07	2.07	2.02	4750	2.65	3.01	3.01	3.01	2.55	4750	3.02	3.87	3.87	3.87	3.24			
5000	1.93	1.93	1.93	1.93	1.73	5000	2.36	2.73	2.73	2.73	2.19	5000	2.68	3.49	3.49	3.49	2.78			
5250	1.78	1.80	1.80	1.80	1.50	5250	2.10	2.47	2.47	2.47	1.89	5250	2.39	3.17	3.17	3.17	2.40			
5500	1.60	1.68	1.68	1.68	1.30	5500	1.88	2.25	2.25	2.25	1.64	5500	2.14	2.89	2.89	2.89	2.09			
5750	1.43	1.57	1.57	1.57	1.14	5750	1.68	2.06	2.06	2.06	1.44	5750	1.92	2.64	2.64	2.64	1.83			
6000	1.29	1.48	1.48	1.48	1.00	6000	1.51	1.89	1.89	1.89	1.27	6000	1.74	2.43	2.43	2.43	1.61			
6250	1.16	1.37	1.37	1.37	0.89	6250	1.36	1.75	1.75	1.75	1.12	6250	1.57	2.24	2.24	2.24	1.42			
6500	1.05	1.28	1.28	1.28	0.79	6500	1.23	1.61	1.61	1.61	1.00	6500	1.42	2.07	2.07	2.07	1.27			
6750	0.95	1.19	1.19	1.19	0.70	6750	1.12	1.50	1.50	1.50	0.89	6750	1.29	1.92	1.92	1.92	1.13			
7000	0.86	1.11	1.11	1.11	0.63	7000	1.01	1.39	1.39	1.39	0.80	7000	1.18	1.78	1.78	1.78	1.01			
7500	0.71	0.97	0.97	0.97	0.51	7500	0.84	1.21	1.21	1.21	0.65	7500	0.98	1.54	1.55	1.55	0.82			
8000	0.59	0.85	0.85	0.85	0.42	8000	0.70	1.07	1.07	1.07	0.53	8000	0.82	1.34	1.36	1.36	0.68			
8500	0.50	0.75	0.75	0.75	0.35	8500	0.59	0.94	0.94	0.94	0.45	8500	0.70	1.17	1.21	1.21	0.57			
9000	0.42	0.67	0.67	0.67	0.30	9000	0.51	0.83	0.84	0.84	0.38	9000	0.60	1.03	1.08	1.08	0.48			
9500		0.59	0.60	0.60	0.25	9500	0.43	0.73	0.76	0.76	0.32	9500	0.51	0.92	0.96	0.97	0.41			
10000		0.53	0.54	0.54	0.22	10000		0.65	0.68	0.68	0.27	10000	0.44	0.82	0.86	0.87	0.35			

Bridging Span	SZ15019					L/150	Bridging Span	SZ15024					L/150
	0	1	2	3	0			1	2	3			
2000						2000							
2250						2250							
2500	16.1	18.9	18.9	18.9	28.4	2500							
2750	12.9	15.8	15.8	15.8	21.3	2750	16.0				27.2		
3000	10.5	13.3	13.3	13.3	16.4	3000	12.9				21.0		
3250	8.75	11.3	11.3	11.3	12.9	3250	10.6	15.2	15.3	15.3	16.5		
3500	7.36	9.78	9.78	9.78	10.3	3500	8.87	13.0	13.2	13.2	13.2	13.2	
3750	6.27	8.52	8.52	8.52	8.41	3750	7.48	11.3	11.5	11.5	10.7		
4000	5.39	7.49	7.49	7.49	6.93	4000	6.39	9.86	10.1	10.1	8.85		
4250	4.66	6.62	6.64	6.64	5.78	4250	5.50	8.69	8.94	8.94	7.38		
4500	4.06	5.88	5.92	5.92	4.87	4500	4.78	7.71	7.97	7.97	6.22		
4750	3.56	5.26	5.31	5.31	4.14	4750	4.18	6.89	7.15	7.15	5.28		
5000	3.15	4.72	4.79	4.79	3.55	5000	3.68	6.19	6.46	6.46	4.53		
5250	2.79	4.27	4.35	4.35	3.07	5250	3.27	5.57	5.86	5.86	3.91		
5500	2.49	3.87	3.96	3.96	2.67	5500	2.92	5.03	5.32	5.33	3.40		
5750	2.23	3.53	3.62	3.62	2.33	5750	2.62	4.56	4.86	4.88	2.98		
6000	2.01	3.23	3.33	3.33	2.05	6000	2.36	4.16	4.45	4.48	2.62		
6250	1.81	2.96	3.07	3.07	1.82	6250	2.14	3.81	4.09	4.13	2.32		
6500	1.64	2.73	2.84	2.84	1.62	6500	1.94	3.49	3.77	3.82	2.06		
6750	1.49	2.52	2.63	2.63	1.44	6750	1.77	3.21	3.49	3.54	1.84		
7000	1.36	2.33	2.45	2.45	1.29	7000	1.62	2.97	3.23	3.29	1.65		
7500	1.15	2.00	2.12	2.13	1.05	7500	1.37	2.55	2.80	2.86	1.34		
8000	0.97	1.73	1.85	1.87	0.87	8000	1.17	2.21	2.45	2.50	1.11		
8500	0.83	1.51	1.62	1.66	0.72	8500	1.01	1.93	2.15	2.21	0.92		
9000	0.72	1.33	1.44	1.48	0.61	9000	0.88	1.69	1.90	1.96	0.78		
9500	0.62	1.17	1.28	1.32	0.52	9500	0.77	1.50	1.69	1.75	0.66		
10000	0.54	1.04	1.14	1.18	0.44	10000	0.68	1.33	1.50	1.56	0.57		

**LEGEND**

- Values below the dotted line are outside the "20D" guide for bridging requirements.
- 7.6** Values in **bold type** require High Strength bolts (Grade 8.8)
- For low restraint claddings reduce capacity up to 10%
- For low restraint claddings reduce capacity up to 20%
- For low restraint claddings reduce capacity over 20%. In these situations, refer to software.
- 1 Single number for bridging refers to the number of rows of bridging per span.
- 2 1 2 Multiple number for bridging refers to the number of rows of bridging in end and inner spans. (e.g. 2 in end spans, 1 in inner spans).

#### 4 SPAN LAPPED - OUTWARD CAPACITY

Bridging Span	SZ15010				Bridging Span	SZ15012				Bridging Span	SZ15015			
	0	1	2	3		0	1	2	3		0	1	2	3
2000	5.95	5.95	5.95	5.95	2000	9.84	9.84	9.84	9.84	2000	<b>16.9</b>	<b>16.9</b>	<b>16.9</b>	<b>16.9</b>
2250	5.22	5.22	5.22	5.22	2250	8.55	8.55	8.54	8.54	2250	<b>14.3</b>	<b>14.3</b>	<b>14.3</b>	<b>14.3</b>
2500	4.63	4.63	4.63	4.63	2500	7.50	7.50	7.50	7.50	2500	<b>12.3</b>	<b>12.3</b>	<b>12.3</b>	<b>12.3</b>
2750	4.15	4.15	4.15	4.15	2750	6.65	6.64	6.64	6.64	2750	<b>10.7</b>	<b>10.7</b>	<b>10.7</b>	<b>10.7</b>
3000	3.74	3.74	3.74	3.74	3000	5.93	5.93	5.93	5.93	3000	<b>9.33</b>	<b>9.33</b>	<b>9.33</b>	<b>9.33</b>
3250	3.39	3.40	3.39	3.39	3250	5.32	5.32	5.32	5.32	3250	<b>7.93</b>	<b>8.16</b>	<b>8.16</b>	<b>8.16</b>
3500	3.09	3.09	3.09	3.09	3500	4.80	4.80	4.80	4.80	3500	6.66	7.09	7.10	7.09
3750	2.84	2.84	2.83	2.82	3750	4.28	4.35	4.35	4.33	3750	5.65	6.21	6.21	6.21
4000	2.61	2.61	2.61	2.60	4000	3.74	3.97	3.97	3.96	4000	4.82	5.46	5.46	5.46
4250	2.31	2.41	2.41	2.41	4250	3.24	3.63	3.63	3.63	4250	4.06	4.83	4.83	4.83
4500	2.01	2.23	2.23	2.23	4500	2.77	3.31	3.31	3.31	4500	3.42	4.27	4.31	4.31
4750	1.76	2.07	2.07	2.07	4750	2.32	3.00	3.01	3.01	4750	2.89	3.77	3.87	3.87
5000	1.48	1.93	1.93	1.93	5000	1.96	2.66	2.73	2.73	5000	2.45	3.35	3.49	3.49
5250	1.23	1.80	1.80	1.80	5250	1.65	2.37	2.47	2.47	5250	2.09	2.99	3.17	3.17
5500	1.04	1.66	1.68	1.68	5500	1.40	2.12	2.25	2.25	5500	1.79	2.67	2.89	2.89
5750	0.88	1.51	1.57	1.57	5750	1.19	1.91	2.06	2.06	5750	1.54	2.40	2.64	2.64
6000	0.75	1.35	1.48	1.48	6000	1.02	1.72	1.89	1.89	6000	1.32	2.16	2.40	2.43
6250	0.65	1.21	1.37	1.37	6250	0.88	1.55	1.74	1.75	6250	1.13	1.94	2.19	2.24
6500	0.56	1.07	1.27	1.28	6500	0.76	1.39	1.59	1.61	6500	0.98	1.73	2.00	2.07
6750	0.49	0.94	1.17	1.19	6750	0.66	1.25	1.45	1.50	6750	0.85	1.55	1.83	1.92
7000	0.43	0.83	1.07	1.11	7000	0.58	1.11	1.33	1.39	7000	0.74	1.38	1.68	1.78
7500		0.66	0.90	0.97	7500	0.45	0.88	1.13	1.21	7500	0.58	1.11	1.42	1.53
8000		0.51	0.76	0.84	8000		0.70	0.97	1.05	8000	0.45	0.89	1.21	1.32
8500		0.41	0.63	0.73	8500		0.56	0.82	0.91	8500		0.73	1.03	1.15
9000			0.53	0.64	9000		0.45	0.70	0.79	9000		0.59	0.87	1.00
9500			0.44	0.55	9500			0.58	0.70	9500		0.48	0.73	0.88
10000				0.48	10000			0.49	0.61	10000			0.62	0.77

Bridging Span	SZ15019				Bridging Span	SZ15024			
	0	1	2	3		0	1	2	3
2000					2000				
2250					2250				
2500	<b>18.9</b>	<b>18.9</b>	<b>18.9</b>	<b>18.9</b>	2500				
2750	<b>15.4</b>	<b>15.8</b>	<b>15.8</b>	<b>15.8</b>	2750				
3000	<b>12.7</b>	<b>13.3</b>	<b>13.3</b>	<b>13.3</b>	3000				
3250	<b>10.6</b>	<b>11.3</b>	<b>11.3</b>	<b>11.3</b>	3250	<b>14.0</b>	<b>15.2</b>	<b>15.3</b>	<b>15.3</b>
3500	<b>8.86</b>	<b>9.78</b>	<b>9.78</b>	<b>9.78</b>	3500	<b>11.6</b>	<b>13.0</b>	<b>13.2</b>	<b>13.2</b>
3750	<b>7.44</b>	<b>8.48</b>	<b>8.52</b>	<b>8.52</b>	3750	<b>9.80</b>	<b>11.2</b>	<b>11.5</b>	<b>11.5</b>
4000	<b>6.29</b>	<b>7.37</b>	<b>7.49</b>	<b>7.49</b>	4000	<b>8.29</b>	<b>9.77</b>	<b>10.1</b>	<b>10.1</b>
4250	5.32	<b>6.45</b>	<b>6.64</b>	<b>6.64</b>	4250	<b>7.05</b>	<b>8.57</b>	<b>8.93</b>	<b>8.94</b>
4500	4.51	<b>5.68</b>	<b>5.92</b>	<b>5.92</b>	4500	<b>6.03</b>	<b>7.55</b>	<b>7.91</b>	<b>7.97</b>
4750	3.83	5.03	5.31	5.31	4750	<b>5.14</b>	<b>6.70</b>	<b>7.05</b>	<b>7.15</b>
5000	3.26	4.48	4.77	4.79	5000	<b>4.38</b>	<b>5.95</b>	<b>6.32</b>	<b>6.46</b>
5250	2.80	4.00	4.29	4.35	5250	3.74	<b>5.28</b>	<b>5.69</b>	<b>5.86</b>
5500	2.39	3.56	3.88	3.96	5500	3.22	<b>4.71</b>	<b>5.14</b>	<b>5.30</b>
5750	2.05	3.18	3.51	3.62	5750	2.77	<b>4.21</b>	<b>4.67</b>	<b>4.83</b>
6000	1.76	2.85	3.20	3.33	6000	2.40	3.77	<b>4.25</b>	<b>4.41</b>
6250	1.51	2.55	2.92	3.05	6250	2.08	3.39	<b>3.89</b>	<b>4.04</b>
6500	1.31	2.29	2.67	2.80	6500	1.81	3.05	3.56	3.71
6750	1.14	2.05	2.45	2.58	6750	1.58	2.75	3.25	3.42
7000	1.00	1.84	2.25	2.38	7000	1.39	2.48	2.98	3.16
7500	0.78	1.48	1.89	2.04	7500	1.09	2.01	2.50	2.71
8000	0.62	1.20	1.60	1.76	8000	0.88	1.63	2.12	2.35
8500	0.50	0.98	1.36	1.53	8500	0.71	1.34	1.81	2.03
9000	0.41	0.79	1.15	1.34	9000	0.59	1.10	1.54	1.77
9500		0.65	0.98	1.16	9500	0.49	0.91	1.32	1.54
10000		0.54	0.83	1.02	10000	0.42	0.75	1.13	1.35

**LEGEND**

--- Values below the dotted line are outside the "20D" guide for bridging requirements.

**7.6** Values in **bold type** require High Strength bolts (Grade 8.8)

 For low restraint claddings reduce capacity up to 10%

 For low restraint claddings reduce capacity up to 20%

 For low restraint claddings reduce capacity over 20%. In these situations, refer to software.

1 Single number for bridging refers to the number of rows of bridging per span.

2 1 2 Multiple number for bridging refers to the number of rows of bridging in end and inner spans. (e.g. 2 in end spans, 1 in inner spans).

#### 4 SPAN LAPPED - MIXED GAUGES - INWARD CAPACITY

Bridging Span	SZ15010/SZ15012					L/150	Bridging Span	SZ15012/SZ15015					L/150	Bridging Span	SZ15015/SZ15019					L/150
	0	1	2	3				0	1	2	3				0	1	2	3		
2000	6.77	6.77	6.77	6.76	33.0	2000	11.0	11.0	11.0	11.0	42.1	2000	18.2	18.2	18.2	18.2	53.9			
2250	5.91	5.90	5.90	5.90	23.2	2250	9.47	9.47	9.47	9.47	29.6	2250	15.2	15.2	15.2	15.2	37.9			
2500	5.21	5.21	5.21	5.21	16.9	2500	8.25	8.25	8.25	8.25	21.6	2500	13.0	13.0	13.0	13.0	27.6			
2750	4.64	4.64	4.64	4.64	12.7	2750	7.25	7.25	7.25	7.24	16.2	2750	10.9	11.1	11.1	11.1	20.7			
3000	4.16	4.16	4.16	4.16	9.79	3000	6.42	6.42	6.42	6.42	12.5	3000	9.02	9.64	9.64	9.64	16.0			
3250	3.75	3.75	3.75	3.75	7.70	3250	5.72	5.72	5.72	5.72	9.81	3250	7.53	8.38	8.38	8.38	12.6			
3500	3.40	3.39	3.40	3.39	6.17	3500	5.12	5.11	5.12	5.11	7.86	3500	6.36	7.29	7.29	7.29	10.1			
3750	3.10	3.10	3.10	3.09	5.01	3750	4.58	4.62	4.61	4.60	6.39	3750	5.44	6.40	6.40	6.40	8.18			
4000	2.84	2.83	2.84	2.84	4.13	4000	4.05	4.18	4.18	4.18	5.26	4000	4.70	5.62	5.62	5.62	6.74			
4250	2.60	2.60	2.60	2.60	3.44	4250	3.53	3.79	3.79	3.79	4.39	4250	4.09	4.98	4.98	4.98	5.62			
4500	2.39	2.39	2.39	2.39	2.90	4500	3.11	3.42	3.42	3.41	3.70	4500	3.58	4.44	4.44	4.44	4.74			
4750	2.21	2.21	2.21	2.21	2.47	4750	2.75	3.09	3.10	3.10	3.14	4750	3.16	3.99	3.99	3.99	4.03			
5000	2.05	2.05	2.05	2.05	2.12	5000	2.44	2.81	2.80	2.81	2.70	5000	2.81	3.60	3.60	3.60	3.45			
5250	1.85	1.90	1.90	1.90	1.83	5250	2.18	2.54	2.54	2.54	2.33	5250	2.50	3.27	3.27	3.27	2.98			
5500	1.66	1.77	1.77	1.77	1.59	5500	1.95	2.32	2.32	2.32	2.03	5500	2.24	2.97	2.97	2.97	2.59			
5750	1.49	1.65	1.65	1.65	1.39	5750	1.75	2.12	2.12	2.12	1.77	5750	2.02	2.72	2.72	2.72	2.27			
6000	1.34	1.53	1.53	1.53	1.22	6000	1.58	1.95	1.95	1.95	1.56	6000	1.82	2.50	2.50	2.50	2.00			
6250	1.21	1.42	1.42	1.42	1.08	6250	1.42	1.80	1.80	1.80	1.38	6250	1.65	2.30	2.30	2.30	1.77			
6500	1.09	1.32	1.32	1.32	0.96	6500	1.29	1.66	1.66	1.66	1.23	6500	1.50	2.13	2.13	2.13	1.57			
6750	0.99	1.22	1.22	1.23	0.86	6750	1.17	1.54	1.54	1.54	1.10	6750	1.37	1.97	1.97	1.97	1.40			
7000	0.90	1.14	1.14	1.14	0.77	7000	1.06	1.43	1.43	1.43	0.98	7000	1.25	1.84	1.84	1.84	1.26			
7500	0.75	0.99	0.99	0.99	0.63	7500	0.88	1.25	1.25	1.25	0.80	7500	1.04	1.60	1.60	1.60	1.02			
8000	0.62	0.87	0.87	0.87	0.52	8000	0.74	1.10	1.10	1.10	0.66	8000	0.88	1.40	1.41	1.41	0.84			
8500	0.52	0.77	0.77	0.77	0.43	8500	0.62	0.97	0.97	0.97	0.55	8500	0.74	1.23	1.25	1.25	0.70			
9000	0.44	0.69	0.69	0.69	0.36	9000	0.53	0.86	0.87	0.87	0.46	9000	0.63	1.08	1.11	1.11	0.59			
9500		0.62	0.62	0.62	0.31	9500	0.46	0.77	0.78	0.78	0.39	9500	0.55	0.96	1.00	1.00	0.50			
10000		0.55	0.56	0.56	0.26	10000		0.68	0.70	0.70	0.34	10000	0.47	0.86	0.90	0.90	0.43			

Bridging Span	SZ15019/SZ15024				
	0	1	2	3	L/150
2000					
2250					
2500	17.0	19.4	19.4	19.4	35.2
2750	13.6	16.2	16.2	16.2	26.5
3000	11.1	13.7	13.7	13.7	20.4
3250	9.23	11.7	11.7	11.7	16.0
3500	7.77	10.1	10.1	10.1	12.8
3750	6.63	8.78	8.78	8.78	10.4
4000	5.71	7.72	7.72	7.72	8.60
4250	4.96	6.84	6.84	6.84	7.17
4500	4.32	6.09	6.09	6.09	6.04
4750	3.80	5.45	5.47	5.47	5.14
5000	3.36	4.90	4.94	4.94	4.40
5250	2.99	4.43	4.48	4.48	3.80
5500	2.67	4.02	4.08	4.08	3.31
5750	2.39	3.67	3.73	3.73	2.90
6000	2.15	3.36	3.43	3.43	2.55
6250	1.95	3.08	3.16	3.16	2.25
6500	1.76	2.84	2.92	2.92	2.00
6750	1.61	2.62	2.71	2.71	1.79
7000	1.47	2.43	2.52	2.52	1.61
7500	1.23	2.10	2.19	2.19	1.31
8000	1.04	1.83	1.92	1.93	1.08
8500	0.89	1.60	1.69	1.71	0.90
9000	0.77	1.41	1.50	1.52	0.76
9500	0.67	1.25	1.33	1.37	0.64
10000	0.58	1.11	1.19	1.23	0.55

**LEGEND**

--- Values below the dotted line are outside the "20D" guide for bridging requirements.

**7.6** Values in **bold type** require High Strength bolts (Grade 8.8)

 For low restraint claddings reduce capacity up to 10%

 For low restraint claddings reduce capacity up to 20%

 For low restraint claddings reduce capacity over 20%. In these situations, refer to software.

1 Single number for bridging refers to the number of rows of bridging per span.

2 1 2 Multiple number for bridging refers to the number of rows of bridging in end and inner spans. (e.g. 2 in end spans, 1 in inner spans).

#### 4 SPAN LAPPED - MIXED GAUGES - OUTWARD CAPACITY

Bridging Span	SZ15010/SZ15012				Bridging Span	SZ15012/SZ15015				Bridging Span	SZ15015/SZ15019			
	0	1	2	3		0	1	2	3		0	1	2	3
2000	6.77	6.77	6.76	6.76	2000	11.0	11.0	11.0	11.0	2000	<b>18.2</b>	<b>18.2</b>	<b>18.2</b>	<b>18.2</b>
2250	5.91	5.90	5.90	5.90	2250	9.47	9.47	9.47	9.47	2250	<b>15.2</b>	<b>15.2</b>	<b>15.2</b>	<b>15.2</b>
2500	5.21	5.21	5.21	5.21	2500	8.25	8.25	8.25	8.25	2500	<b>13.0</b>	<b>13.0</b>	<b>13.0</b>	<b>13.0</b>
2750	4.64	4.64	4.64	4.64	2750	7.25	7.25	7.25	7.24	2750	<b>11.1</b>	<b>11.1</b>	<b>11.1</b>	<b>11.1</b>
3000	4.16	4.16	4.16	4.16	3000	6.42	6.42	6.42	6.42	3000	<b>9.64</b>	<b>9.64</b>	<b>9.64</b>	<b>9.64</b>
3250	3.75	3.75	3.75	3.75	3250	5.72	5.72	5.72	5.72	3250	<b>8.38</b>	<b>8.38</b>	<b>8.38</b>	<b>8.38</b>
3500	3.40	3.39	3.40	3.39	3500	5.12	5.11	5.12	5.11	3500	7.15	7.29	7.29	7.29
3750	3.10	3.10	3.10	3.09	3750	4.61	4.62	4.61	4.60	3750	6.11	6.40	6.40	6.40
4000	2.84	2.83	2.84	2.84	4000	4.07	4.18	4.18	4.18	4000	5.26	5.62	5.62	5.62
4250	2.60	2.60	2.60	2.60	4250	3.58	3.79	3.79	3.79	4250	4.55	4.98	4.98	4.98
4500	2.28	2.39	2.39	2.39	4500	3.11	3.42	3.42	3.41	4500	3.95	4.44	4.44	4.44
4750	1.99	2.21	2.21	2.21	4750	2.69	3.09	3.10	3.10	4750	3.40	3.99	3.99	3.99
5000	1.76	2.05	2.05	2.05	5000	2.30	2.81	2.81	2.80	5000	2.93	3.58	3.60	3.60
5250	1.52	1.90	1.90	1.90	5250	1.96	2.52	2.54	2.54	5250	2.53	3.21	3.27	3.26
5500	1.30	1.77	1.77	1.77	5500	1.68	2.27	2.32	2.32	5500	2.19	2.89	2.97	2.97
5750	1.12	1.63	1.65	1.65	5750	1.44	2.04	2.12	2.12	5750	1.90	2.60	2.72	2.72
6000	0.96	1.47	1.53	1.53	6000	1.24	1.85	1.95	1.95	6000	1.66	2.36	2.50	2.50
6250	0.83	1.33	1.42	1.42	6250	1.07	1.67	1.80	1.80	6250	1.45	2.14	2.30	2.30
6500	0.72	1.20	1.32	1.32	6500	0.93	1.53	1.66	1.66	6500	1.28	1.95	2.13	2.13
6750	0.63	1.08	1.22	1.23	6750	0.82	1.39	1.54	1.54	6750	1.12	1.78	1.96	1.97
7000	0.55	0.98	1.14	1.14	7000	0.72	1.26	1.42	1.43	7000	0.98	1.62	1.81	1.84
7500	0.43	0.80	0.97	0.99	7500	0.56	1.04	1.21	1.25	7500	0.76	1.33	1.54	1.60
8000		0.65	0.83	0.87	8000	0.44	0.84	1.04	1.10	8000	0.61	1.09	1.33	1.41
8500		0.53	0.71	0.77	8500		0.68	0.90	0.97	8500	0.49	0.90	1.15	1.23
9000		0.43	0.61	0.68	9000		0.56	0.78	0.85	9000	0.40	0.75	1.00	1.08
9500			0.52	0.60	9500		0.46	0.68	0.75	9500		0.62	0.87	0.95
10000			0.45	0.53	10000			0.58	0.66	10000		0.52	0.75	0.85

Bridging Span	SZ15019/SZ15024			
	0	1	2	3
2000				
2250				
2500	<b>19.4</b>	<b>19.4</b>	<b>19.4</b>	<b>19.4</b>
2750	<b>16.2</b>	<b>16.2</b>	<b>16.2</b>	<b>16.2</b>
3000	<b>13.4</b>	<b>13.7</b>	<b>13.7</b>	<b>13.7</b>
3250	<b>11.2</b>	<b>11.7</b>	<b>11.7</b>	<b>11.7</b>
3500	<b>9.50</b>	<b>10.1</b>	<b>10.1</b>	<b>10.1</b>
3750	<b>8.13</b>	<b>8.78</b>	<b>8.78</b>	<b>8.78</b>
4000	<b>6.97</b>	<b>7.72</b>	<b>7.72</b>	<b>7.72</b>
4250	<b>5.99</b>	<b>6.79</b>	<b>6.84</b>	<b>6.84</b>
4500	5.17	<b>5.99</b>	<b>6.09</b>	<b>6.09</b>
4750	4.48	5.33	5.47	5.47
5000	3.89	4.76	4.94	4.94
5250	3.38	4.27	4.48	4.48
5500	2.94	3.84	4.08	4.08
5750	2.57	3.47	3.71	3.73
6000	2.26	3.15	3.38	3.43
6250	1.99	2.85	3.09	3.16
6500	1.75	2.58	2.83	2.92
6750	1.54	2.34	2.61	2.71
7000	1.36	2.13	2.40	2.51
7500	1.07	1.77	2.06	2.16
8000	0.86	1.47	1.77	1.87
8500	0.70	1.22	1.53	1.64
9000	0.58	1.03	1.32	1.44
9500	0.48	0.87	1.15	1.27
10000	0.41	0.73	1.00	1.13

#### LEGEND

--- Values below the dotted line are outside the "20D" guide for bridging requirements.

**7.6** Values in **bold type** require High Strength bolts (Grade 8.8)

 For low restraint claddings reduce capacity up to 10%

 For low restraint claddings reduce capacity up to 20%

 For low restraint claddings reduce capacity over 20%  
In these situations, refer to software.

1 Single number for bridging refers to the number of rows of bridging per span.

2 1 2 Multiple number for bridging refers to the number of rows of bridging in end and inner spans. (e.g. 2 in end spans, 1 in inner spans).

**4 SPAN LAPPED - INWARD CAPACITY**

SZ20012						SZ20015						SZ20019					
Bridging Span	0	1	2	3	L/150	Bridging Span	0	1	2	3	L/150	Bridging Span	0	1	2	3	L/150
3000	5.00	5.00	5.00	5.00	21.5	3000	9.08	9.08	9.08	9.08	27.7	3000	16.4	16.4	16.4	16.4	36.4
3250	4.57	4.57	4.57	4.57	16.9	3250	8.21	8.21	8.21	8.21	21.8	3250	14.0	14.6	14.6	14.6	28.6
3500	4.20	4.19	4.20	4.20	13.5	3500	7.46	7.46	7.46	7.46	17.4	3500	11.7	13.1	13.1	13.1	22.9
3750	3.87	3.87	3.86	3.85	11.0	3750	6.82	6.82	6.80	6.78	14.2	3750	9.85	11.8	11.8	11.8	18.6
4000	3.60	3.60	3.60	3.59	9.07	4000	6.26	6.26	6.26	6.24	11.7	4000	8.40	10.7	10.7	10.7	15.3
4250	3.34	3.34	3.34	3.34	7.56	4250	5.76	5.76	5.76	5.76	9.73	4250	7.21	9.71	9.71	9.71	12.8
4500	3.12	3.12	3.12	3.12	6.37	4500	5.23	5.31	5.31	5.31	8.20	4500	6.25	8.75	8.75	8.75	10.8
4750	2.92	2.92	2.91	2.92	5.42	4750	4.63	4.92	4.91	4.92	6.97	4750	5.45	7.92	7.92	7.92	9.16
5000	2.74	2.74	2.73	2.74	4.65	5000	4.10	4.57	4.56	4.57	5.98	5000	4.78	7.20	7.20	7.20	7.86
5250	2.57	2.57	2.57	2.57	4.01	5250	3.65	4.25	4.25	4.25	5.16	5250	4.22	6.53	6.53	6.53	6.79
5500	2.42	2.42	2.42	2.42	3.49	5500	3.25	3.96	3.96	3.96	4.49	5500	3.75	5.95	5.95	5.95	5.90
5750	2.29	2.28	2.28	2.28	3.05	5750	2.92	3.69	3.69	3.69	3.93	5750	3.35	5.44	5.44	5.44	5.16
6000	2.16	2.16	2.16	2.16	2.69	6000	2.63	3.42	3.42	3.42	3.46	6000	3.01	5.00	5.00	5.00	4.55
6250	2.02	2.04	2.04	2.04	2.38	6250	2.38	3.18	3.18	3.18	3.06	6250	2.72	4.61	4.61	4.61	4.02
6500	1.84	1.94	1.94	1.94	2.11	6500	2.16	2.97	2.97	2.97	2.72	6500	2.46	4.26	4.26	4.26	3.58
6750	1.69	1.84	1.84	1.83	1.89	6750	1.97	2.75	2.75	2.75	2.43	6750	2.24	3.95	3.95	3.95	3.19
7000	1.54	1.75	1.75	1.75	1.69	7000	1.80	2.56	2.56	2.56	2.18	7000	2.05	3.67	3.67	3.67	2.86
7500	1.30	1.58	1.58	1.58	1.38	7500	1.51	2.23	2.23	2.23	1.77	7500	1.72	3.17	3.20	3.20	2.33
8000	1.11	1.44	1.44	1.44	1.13	8000	1.28	1.96	1.96	1.96	1.46	8000	1.47	2.77	2.81	2.81	1.92
8500	0.95	1.31	1.31	1.31	0.95	8500	1.10	1.73	1.74	1.74	1.22	8500	1.26	2.44	2.49	2.49	1.60
9000	0.82	1.19	1.19	1.19	0.80	9000	0.95	1.55	1.55	1.55	1.03	9000	1.09	2.16	2.22	2.22	1.35
9500	0.71	1.08	1.08	1.08	0.68	9500	0.82	1.39	1.39	1.39	0.87	9500	0.95	1.93	1.99	1.99	1.15
10000	0.62	0.97	0.97	0.97	0.58	10000	0.72	1.25	1.25	1.25	0.75	10000	0.83	1.73	1.80	1.80	0.98
10500	0.54	0.88	0.88	0.88	0.50	10500	0.63	1.13	1.14	1.14	0.65	10500	0.74	1.55	1.63	1.63	0.85
11000	0.47	0.80	0.81	0.81	0.44	11000	0.55	1.02	1.04	1.04	0.56	11000	0.65	1.39	1.49	1.49	0.74
11500	0.42	0.72	0.74	0.74	0.38	11500	0.49	0.93	0.95	0.95	0.49	11500	0.58	1.25	1.36	1.36	0.65
12000		0.66	0.68	0.68	0.34	12000	0.43	0.84	0.87	0.87	0.43	12000	0.52	1.13	1.24	1.25	0.57
12500		0.60	0.62	0.62	0.30	12500		0.77	0.80	0.80	0.38	12500	0.47	1.02	1.13	1.15	0.50
13500		0.50	0.53	0.54	0.24	13500		0.65	0.69	0.69	0.30	13500		0.84	0.96	0.99	0.40
14500		0.42	0.45	0.46	0.19	14500		0.54	0.58	0.60	0.25	14500		0.70	0.82	0.85	0.32
15500			0.40		0.16	15500		0.45	0.50	0.52	0.20	15500		0.58	0.70	0.73	0.26

SZ20024					
Bridging Span	0	1	2	3	L/150
3000					
3250					
3500	14.2				29.3
3750	11.8				23.8
4000	9.87				19.6
4250	8.38				16.4
4500	7.19				13.8
4750	6.23	11.0	11.0	11.0	11.7
5000	5.45	9.92	9.92	9.92	10.0
5250	4.81	8.98	9.00	9.00	8.68
5500	4.27	8.13	8.19	8.19	7.55
5750	3.81	7.41	7.50	7.50	6.61
6000	3.43	6.77	6.89	6.89	5.82
6250	3.09	6.21	6.35	6.35	5.14
6500	2.81	5.71	5.87	5.87	4.57
6750	2.56	5.27	5.44	5.44	4.08
7000	2.34	4.88	5.06	5.06	3.66
7500	1.97	4.20	4.41	4.41	2.98
8000	1.68	3.63	3.87	3.87	2.45
8500	1.45	3.17	3.43	3.43	2.05
9000	1.26	2.78	3.06	3.06	1.72
9500	1.11	2.45	2.75	2.75	1.47
10000	0.98	2.18	2.47	2.48	1.26
10500	0.86	1.94	2.22	2.25	1.09
11000	0.77	1.74	2.01	2.05	0.94
11500	0.69	1.57	1.83	1.88	0.83
12000	0.62	1.42	1.66	1.72	0.73
12500	0.56	1.28	1.52	1.59	0.64
13500	0.46	1.06	1.28	1.34	0.51
14500		0.89	1.08	1.14	0.41
15500		0.74	0.91	0.98	0.34

**LEGEND**

--- Values below the dotted line are outside the "20D" guide for bridging requirements.

**7.6** Values in **bold type** require High Strength bolts (Grade 8.8)

 For low restraint claddings reduce capacity up to 10%

 For low restraint claddings reduce capacity up to 20%

 For low restraint claddings reduce capacity over 20%. In these situations, refer to software.

1 Single number for bridging refers to the number of rows of bridging per span.

2 1 2 Multiple number for bridging refers to the number of rows of bridging in end and inner spans. (e.g. 2 in end spans, 1 in inner spans).

**4 SPAN LAPPED - OUTWARD CAPACITY**

SZ20012					SZ20015					SZ20019				
Bridging Span	0	1	2	3	Bridging Span	0	1	2	3	Bridging Span	0	1	2	3
3000	5.00	5.00	5.00	5.00	3000	<b>9.08</b>	<b>9.08</b>	<b>9.08</b>	<b>9.08</b>	3000	<b>16.4</b>	<b>16.4</b>	<b>16.4</b>	<b>16.4</b>
3250	4.57	4.57	4.57	4.57	3250	<b>8.21</b>	<b>8.21</b>	<b>8.21</b>	<b>8.21</b>	3250	<b>14.6</b>	<b>14.6</b>	<b>14.6</b>	<b>14.6</b>
3500	4.20	4.20	4.19	4.20	3500	<b>7.46</b>	<b>7.46</b>	<b>7.46</b>	<b>7.46</b>	3500	<b>13.1</b>	<b>13.1</b>	<b>13.1</b>	<b>13.1</b>
3750	3.87	3.87	3.86	3.85	3750	6.82	6.82	6.80	6.78	3750	<b>11.8</b>	<b>11.8</b>	<b>11.8</b>	<b>11.8</b>
4000	3.60	3.60	3.60	3.59	4000	6.26	6.26	6.26	6.24	4000	<b>10.7</b>	<b>10.7</b>	<b>10.7</b>	<b>10.7</b>
4250	3.34	3.34	3.34	3.34	4250	5.76	5.76	5.76	5.76	4250	<b>9.56</b>	<b>9.71</b>	<b>9.71</b>	<b>9.71</b>
4500	3.12	3.12	3.12	3.12	4500	5.31	5.31	5.31	5.31	4500	<b>8.38</b>	<b>8.75</b>	<b>8.75</b>	<b>8.75</b>
4750	2.92	2.92	2.91	2.92	4750	4.92	4.92	4.91	4.92	4750	<b>7.34</b>	<b>7.92</b>	<b>7.92</b>	<b>7.92</b>
5000	2.74	2.74	2.73	2.74	5000	4.48	4.57	4.56	4.57	5000	<b>6.36</b>	<b>7.20</b>	<b>7.20</b>	<b>7.20</b>
5250	2.57	2.57	2.57	2.57	5250	4.03	4.25	4.25	4.25	5250	<b>5.52</b>	<b>6.53</b>	<b>6.53</b>	<b>6.53</b>
5500	2.42	2.42	2.42	2.42	5500	3.58	3.96	3.96	3.96	5500	<b>4.79</b>	<b>5.95</b>	<b>5.95</b>	<b>5.95</b>
5750	2.20	2.28	2.28	2.28	5750	3.09	3.69	3.69	3.69	5750	<b>4.16</b>	<b>5.40</b>	<b>5.44</b>	<b>5.44</b>
6000	1.99	2.16	2.16	2.16	6000	2.68	3.42	3.42	3.42	6000	3.62	<b>4.91</b>	<b>5.00</b>	<b>5.00</b>
6250	1.76	2.04	2.04	2.04	6250	2.32	3.18	3.18	3.18	6250	3.17	<b>4.48</b>	<b>4.61</b>	<b>4.61</b>
6500	1.54	1.94	1.94	1.94	6500	2.02	2.93	2.97	2.97	6500	2.78	<b>4.10</b>	<b>4.26</b>	<b>4.26</b>
6750	1.34	1.84	1.84	1.83	6750	1.76	2.68	2.75	2.75	6750	2.44	<b>3.76</b>	<b>3.95</b>	<b>3.95</b>
7000	1.17	1.75	1.75	1.75	7000	1.54	2.46	2.56	2.56	7000	2.12	3.46	<b>3.67</b>	<b>3.67</b>
7500	0.91	1.55	1.58	1.58	7500	1.19	2.08	2.23	2.23	7500	1.64	2.90	3.19	3.20
8000	0.72	1.33	1.44	1.44	8000	0.93	1.77	1.96	1.96	8000	1.29	2.40	2.77	2.81
8500	0.57	1.10	1.31	1.31	8500	0.74	1.47	1.72	1.74	8500	1.03	1.99	2.41	2.49
9000	0.46	0.91	1.16	1.19	9000	0.60	1.21	1.51	1.55	9000	0.83	1.65	2.12	2.22
9500		0.76	1.02	1.08	9500	0.49	1.00	1.32	1.39	9500	0.68	1.38	1.86	1.98
10000		0.63	0.90	0.97	10000	0.40	0.83	1.17	1.25	10000	0.57	1.16	1.63	1.77
10500		0.52	0.78	0.87	10500		0.69	1.03	1.13	10500	0.47	0.97	1.42	1.58
11000		0.44	0.68	0.78	11000		0.58	0.91	1.01	11000		0.81	1.23	1.42
11500			0.59	0.70	11500		0.49	0.78	0.91	11500		0.69	1.07	1.28
12000			0.51	0.63	12000		0.42	0.68	0.82	12000		0.58	0.93	1.16
12500			0.44	0.57	12500			0.59	0.74	12500		0.50	0.81	1.03
13500				0.45	13500			0.44	0.61	13500			0.62	0.82
14500					14500				0.48	14500			0.47	0.65
15500					15500					15500				0.52

SZ20024				
Bridging Span	0	1	2	3
3000				
3250				
3500				
3750				
4000				
4250				
4500	<b>11.1</b>			
4750	<b>9.63</b>	<b>11.0</b>	<b>11.0</b>	<b>11.0</b>
5000	<b>8.36</b>	<b>9.92</b>	<b>9.92</b>	<b>9.92</b>
5250	<b>7.28</b>	<b>8.95</b>	<b>9.00</b>	<b>9.00</b>
5500	<b>6.34</b>	<b>8.06</b>	<b>8.19</b>	<b>8.19</b>
5750	<b>5.53</b>	<b>7.30</b>	<b>7.50</b>	<b>7.50</b>
6000	<b>4.83</b>	<b>6.63</b>	<b>6.89</b>	<b>6.89</b>
6250	<b>4.23</b>	<b>6.04</b>	<b>6.35</b>	<b>6.35</b>
6500	<b>3.69</b>	<b>5.51</b>	<b>5.87</b>	<b>5.87</b>
6750	3.22	<b>5.05</b>	<b>5.44</b>	<b>5.44</b>
7000	2.82	<b>4.60</b>	<b>5.04</b>	<b>5.06</b>
7500	2.19	<b>3.82</b>	<b>4.32</b>	<b>4.41</b>
8000	1.73	<b>3.19</b>	<b>3.73</b>	<b>3.88</b>
8500	1.38	2.66	<b>3.25</b>	<b>3.43</b>
9000	1.12	2.23	<b>2.84</b>	<b>3.02</b>
9500	0.93	1.87	2.47	2.68
10000	0.77	1.56	2.15	2.38
10500	0.65	1.31	1.88	2.13
11000	0.55	1.10	1.64	1.91
11500	0.47	0.93	1.43	1.71
12000	0.41	0.79	1.25	1.53
12500		0.68	1.09	1.37
13500		0.51	0.84	1.09
14500			0.64	0.88
15500			0.50	0.71

**LEGEND**

--- Values below the dotted line are outside the "20D" guide for bridging requirements.

**7.6** Values in **bold type** require High Strength bolts (Grade 8.8)

 For low restraint claddings reduce capacity up to 10%

 For low restraint claddings reduce capacity up to 20%

 For low restraint claddings reduce capacity over 20%. In these situations, refer to software.

1 Single number for bridging refers to the number of rows of bridging per span.

2 1 2 Multiple number for bridging refers to the number of rows of bridging in end and inner spans. (e.g. 2 in end spans, 1 in inner spans).

#### 4 SPAN LAPPED - MIXED GAUGES - INWARD CAPACITY

Bridging Span	SZ20012/SZ20015					L/150	Bridging Span	SZ20015/SZ20019					L/150	Bridging Span	SZ20019/SZ20024					L/150
	0	1	2	3				0	1	2	3				0	1	2	3		
3000	5.67	5.67	5.67	5.67	26.7	3000	10.0	10.0	10.0	10.0	35.1	3000	17.5	17.5	17.5	17.5	45.2			
3250	5.17	5.17	5.16	5.16	21.0	3250	9.03	9.03	9.02	9.02	27.6	3250	14.8	15.5	15.5	15.5	35.5			
3500	4.72	4.71	4.72	4.71	16.8	3500	8.15	8.13	8.14	8.14	22.1	3500	12.3	13.7	13.8	13.7	28.4			
3750	4.34	4.35	4.34	4.33	13.7	3750	7.40	7.40	7.40	7.38	18.0	3750	10.4	12.3	12.3	12.3	23.1			
4000	4.01	4.01	4.01	4.01	11.3	4000	6.75	6.75	6.75	6.75	14.8	4000	8.89	11.1	11.1	11.1	19.1			
4250	3.72	3.72	3.72	3.71	9.39	4250	6.16	6.18	6.18	6.17	12.3	4250	7.66	10.0	10.0	10.0	15.9			
4500	3.45	3.45	3.45	3.44	7.91	4500	5.52	5.66	5.66	5.66	10.4	4500	6.63	8.99	8.99	8.99	13.4			
4750	3.22	3.21	3.21	3.22	6.73	4750	4.86	5.22	5.22	5.22	8.85	4750	5.80	8.14	8.14	8.14	11.4			
5000	3.01	3.01	3.00	3.00	5.77	5000	4.31	4.83	4.82	4.82	7.58	5000	5.10	7.40	7.40	7.40	9.76			
5250	2.81	2.81	2.81	2.81	4.98	5250	3.84	4.47	4.47	4.47	6.55	5250	4.50	6.73	6.73	6.73	8.43			
5500	2.64	2.64	2.63	2.63	4.33	5500	3.43	4.15	4.14	4.14	5.70	5500	3.99	6.13	6.13	6.13	7.33			
5750	2.48	2.48	2.48	2.48	3.79	5750	3.08	3.83	3.83	3.83	4.99	5750	3.57	5.61	5.61	5.61	6.42			
6000	2.31	2.33	2.33	2.33	3.34	6000	2.77	3.54	3.54	3.54	4.39	6000	3.20	5.15	5.15	5.15	5.65			
6250	2.10	2.20	2.20	2.20	2.95	6250	2.51	3.29	3.29	3.29	3.88	6250	2.89	4.75	4.75	4.75	5.00			
6500	1.91	2.08	2.07	2.07	2.63	6500	2.27	3.06	3.06	3.06	3.45	6500	2.62	4.39	4.39	4.39	4.44			
6750	1.75	1.96	1.97	1.96	2.34	6750	2.07	2.84	2.84	2.84	3.08	6750	2.38	4.07	4.07	4.07	3.97			
7000	1.60	1.86	1.86	1.86	2.10	7000	1.89	2.64	2.64	2.64	2.76	7000	2.18	3.78	3.78	3.78	3.56			
7500	1.35	1.67	1.67	1.67	1.71	7500	1.59	2.30	2.30	2.30	2.25	7500	1.83	3.30	3.30	3.30	2.89			
8000	1.15	1.52	1.52	1.52	1.41	8000	1.35	2.02	2.02	2.02	1.85	8000	1.56	2.88	2.90	2.90	2.38			
8500	0.99	1.36	1.36	1.36	1.17	8500	1.16	1.79	1.79	1.79	1.54	8500	1.34	2.54	2.57	2.57	1.99			
9000	0.85	1.23	1.23	1.23	0.99	9000	1.00	1.60	1.60	1.60	1.30	9000	1.16	2.25	2.29	2.29	1.67			
9500	0.74	1.11	1.11	1.11	0.84	9500	0.87	1.43	1.43	1.43	1.11	9500	1.01	2.01	2.05	2.05	1.42			
10000	0.64	1.00	1.00	1.00	0.72	10000	0.76	1.29	1.29	1.29	0.95	10000	0.89	1.80	1.85	1.85	1.22			
10500	0.56	0.91	0.91	0.91	0.62	10500	0.67	1.17	1.17	1.17	0.82	10500	0.78	1.62	1.68	1.68	1.05			
11000	0.50	0.83	0.83	0.83	0.54	11000	0.59	1.07	1.07	1.07	0.71	11000	0.70	1.47	1.53	1.53	0.92			
11500	0.44	0.76	0.76	0.76	0.47	11500	0.52	0.97	0.98	0.98	0.62	11500	0.62	1.33	1.40	1.40	0.80			
12000		0.69	0.70	0.70	0.42	12000	0.46	0.89	0.90	0.90	0.55	12000	0.55	1.21	1.29	1.29	0.71			
12500		0.63	0.64	0.64	0.37	12500	0.41	0.81	0.83	0.83	0.49	12500	0.50	1.10	1.18	1.19	0.63			
13500		0.53	0.55	0.55	0.29	13500		0.68	0.71	0.71	0.39	13500	0.40	0.91	1.00	1.02	0.50			
14500		0.45	0.47	0.48	0.24	14500		0.58	0.61	0.62	0.31	14500		0.76	0.85	0.88	0.40			
15500			0.41	0.42	0.19	15500		0.50	0.53	0.54	0.26	15500		0.64	0.74	0.76	0.33			

**LEGEND**

--- Values below the dotted line are outside the "20D" guide for bridging requirements.

**7.6** Values in **bold type** require High Strength bolts (Grade 8.8)

 For low restraint claddings reduce capacity up to 10%

 For low restraint claddings reduce capacity up to 20%

 For low restraint claddings reduce capacity over 20%. In these situations, refer to software.

1 Single number for bridging refers to the number of rows of bridging per span.



2 1 2 Multiple number for bridging refers to the number of rows of bridging in end and inner spans. (e.g. 2 in end spans, 1 in inner spans).



#### 4 SPAN LAPPED - MIXED GAUGES - OUTWARD CAPACITY

Bridging Span	SZ20012/SZ20015				Bridging Span	SZ20015/SZ20019				Bridging Span	SZ20019/SZ20024			
	0	1	2	3		0	1	2	3		0	1	2	3
3000	5.67	5.67	5.67	5.67	3000	<b>10.0</b>	<b>10.0</b>	<b>10.0</b>	<b>10.0</b>	3000	<b>17.5</b>	<b>17.5</b>	<b>17.5</b>	<b>17.5</b>
3250	5.17	5.17	5.16	5.16	3250	<b>9.03</b>	<b>9.03</b>	<b>9.02</b>	<b>9.02</b>	3250	<b>15.5</b>	<b>15.5</b>	<b>15.5</b>	<b>15.5</b>
3500	4.72	4.71	4.72	4.71	3500	<b>8.15</b>	<b>8.13</b>	<b>8.14</b>	<b>8.14</b>	3500	<b>13.8</b>	<b>13.7</b>	<b>13.8</b>	<b>13.7</b>
3750	4.34	4.35	4.35	4.32	3750	<b>7.40</b>	<b>7.40</b>	<b>7.40</b>	<b>7.38</b>	3750	<b>12.3</b>	<b>12.3</b>	<b>12.3</b>	<b>12.3</b>
4000	4.01	4.01	4.01	4.01	4000	<b>6.75</b>	<b>6.75</b>	<b>6.75</b>	<b>6.75</b>	4000	<b>11.1</b>	<b>11.1</b>	<b>11.1</b>	<b>11.1</b>
4250	3.72	3.72	3.72	3.71	4250	<b>6.18</b>	<b>6.18</b>	<b>6.18</b>	<b>6.17</b>	4250	<b>10.0</b>	<b>10.0</b>	<b>10.0</b>	<b>10.00</b>
4500	3.45	3.45	3.45	3.44	4500	5.67	5.66	5.66	5.66	4500	<b>8.91</b>	<b>8.99</b>	<b>8.99</b>	<b>8.99</b>
4750	3.22	3.21	3.21	3.22	4750	5.22	5.22	5.22	5.22	4750	<b>7.89</b>	<b>8.14</b>	<b>8.14</b>	<b>8.14</b>
5000	3.01	3.01	3.00	3.00	5000	4.83	4.83	4.82	4.82	5000	<b>7.03</b>	<b>7.40</b>	<b>7.40</b>	<b>7.40</b>
5250	2.81	2.81	2.81	2.81	5250	4.43	4.47	4.47	4.47	5250	<b>6.26</b>	<b>6.73</b>	<b>6.73</b>	<b>6.73</b>
5500	2.64	2.64	2.63	2.63	5500	4.00	4.15	4.14	4.14	5500	<b>5.53</b>	<b>6.13</b>	<b>6.13</b>	<b>6.13</b>
5750	2.48	2.48	2.48	2.48	5750	3.58	3.83	3.83	3.83	5750	<b>4.88</b>	<b>5.61</b>	<b>5.61</b>	<b>5.61</b>
6000	2.27	2.33	2.33	2.33	6000	3.23	3.54	3.54	3.54	6000	<b>4.31</b>	<b>5.15</b>	<b>5.15</b>	<b>5.15</b>
6250	2.06	2.20	2.20	2.20	6250	2.88	3.29	3.29	3.29	6250	<b>3.81</b>	<b>4.74</b>	<b>4.75</b>	<b>4.75</b>
6500	1.83	2.08	2.07	2.07	6500	2.54	3.06	3.06	3.06	6500	3.37	<b>4.35</b>	<b>4.39</b>	<b>4.39</b>
6750	1.62	1.96	1.97	1.96	6750	2.24	2.84	2.84	2.84	6750	2.98	<b>4.00</b>	<b>4.07</b>	<b>4.07</b>
7000	1.43	1.86	1.86	1.86	7000	1.98	2.64	2.64	2.64	7000	2.66	3.69	<b>3.78</b>	<b>3.78</b>
7500	1.12	1.67	1.67	1.67	7500	1.56	2.26	2.30	2.30	7500	2.12	3.15	3.30	3.30
8000	0.89	1.47	1.52	1.52	8000	1.24	1.94	2.02	2.02	8000	1.68	2.72	2.90	2.90
8500	0.71	1.27	1.36	1.36	8500	1.00	1.67	1.79	1.79	8500	1.35	2.32	2.56	2.57
9000	0.58	1.07	1.23	1.23	9000	0.81	1.45	1.60	1.60	9000	1.10	1.97	2.25	2.29
9500	0.47	0.90	1.09	1.11	9500	0.66	1.26	1.43	1.43	9500	0.90	1.68	2.00	2.05
10000		0.76	0.97	1.00	10000	0.55	1.06	1.27	1.29	10000	0.75	1.42	1.78	1.85
10500		0.64	0.86	0.91	10500	0.46	0.90	1.13	1.17	10500	0.63	1.21	1.59	1.68
11000		0.55	0.77	0.83	11000		0.77	1.01	1.07	11000	0.54	1.05	1.42	1.51
11500		0.46	0.68	0.75	11500		0.66	0.91	0.98	11500	0.46	0.90	1.26	1.37
12000			0.60	0.68	12000		0.56	0.82	0.89	12000		0.77	1.11	1.24
12500			0.53	0.62	12500		0.48	0.74	0.81	12500		0.66	0.98	1.13
13500			0.41	0.51	13500			0.57	0.67	13500		0.50	0.77	0.94
14500				0.42	14500			0.45	0.56	14500			0.61	0.78
15500					15500				0.48	15500			0.49	0.64



#### LEGEND

- Values below the dotted line are outside the "20D" guide for bridging requirements.
- 7.6** Values in **bold type** require High Strength bolts (Grade 8.8)
-  For low restraint claddings reduce capacity up to 10%
-  For low restraint claddings reduce capacity up to 20%
-  For low restraint claddings reduce capacity over 20%. In these situations, refer to software.
- 1 Single number for bridging refers to the number of rows of bridging per span.
- 2 1 2 Multiple number for bridging refers to the number of rows of bridging in end and inner spans. (e.g. 2 in end spans, 1 in inner spans).

**4 SPAN LAPPED - INWARD CAPACITY**

Bridging Span	SZ25015					L/150	Bridging Span	SZ25019					L/150	Bridging Span	SZ25024					L/150
	0	1	2	3				0	1	2	3				0	1	2	3		
4000	5.55	5.55	5.55	5.54	19.6	4000	<b>10.3</b>	<b>10.4</b>	<b>10.4</b>	<b>10.4</b>	25.6	4000	<b>12.2</b>				33.4			
4250	5.16	5.16	5.16	5.16	16.3	4250	<b>9.07</b>	<b>9.60</b>	<b>9.60</b>	<b>9.60</b>	21.4	4250	<b>10.3</b>				27.8			
4500	4.82	4.82	4.82	4.82	13.8	4500	<b>7.80</b>	<b>8.88</b>	<b>8.88</b>	<b>8.88</b>	18.0	4500	<b>8.83</b>				23.4			
4750	4.51	4.51	4.50	4.51	11.7	4750	<b>6.77</b>	<b>8.25</b>	<b>8.24</b>	<b>8.25</b>	15.3	4750	<b>7.65</b>				19.9			
5000	4.23	4.23	4.22	4.23	10.0	5000	<b>5.93</b>	<b>7.67</b>	<b>7.67</b>	<b>7.68</b>	13.1	5000	<b>6.68</b>				17.1			
5250	3.97	3.97	3.97	3.97	8.67	5250	<b>5.23</b>	<b>7.16</b>	<b>7.16</b>	<b>7.16</b>	11.3	5250	<b>5.89</b>				14.8			
5500	3.74	3.74	3.74	3.74	7.54	5500	<b>4.64</b>	<b>6.69</b>	<b>6.69</b>	<b>6.69</b>	9.86	5500	<b>5.22</b>				12.8			
5750	3.53	3.53	3.53	3.52	6.60	5750	4.15	<b>6.27</b>	<b>6.27</b>	<b>6.26</b>	8.63	5750	<b>4.66</b>				11.2			
6000	3.33	3.34	3.33	3.34	5.81	6000	3.73	<b>5.89</b>	<b>5.88</b>	<b>5.89</b>	7.60	6000	<b>4.19</b>	<b>8.80</b>	<b>8.80</b>	<b>8.80</b>	9.88			
6250	3.04	3.16	3.16	3.16	5.14	6250	3.36	<b>5.53</b>	<b>5.53</b>	<b>5.53</b>	6.72	6250	3.78	<b>8.11</b>	<b>8.11</b>	<b>8.11</b>	8.74			
6500	2.76	2.99	2.99	2.99	4.57	6500	3.05	<b>5.21</b>	<b>5.21</b>	<b>5.21</b>	5.98	6500	3.42	<b>7.49</b>	<b>7.50</b>	<b>7.50</b>	7.77			
6750	2.51	2.84	2.84	2.83	4.08	6750	2.77	<b>4.88</b>	<b>4.88</b>	<b>4.88</b>	5.34	6750	3.11	<b>6.91</b>	<b>6.95</b>	<b>6.95</b>	6.94			
7000	2.30	2.70	2.70	2.70	3.66	7000	2.53	<b>4.58</b>	<b>4.58</b>	<b>4.57</b>	4.78	7000	2.85	<b>6.39</b>	<b>6.47</b>	<b>6.47</b>	6.22			
7500	1.93	2.45	2.45	2.45	2.97	7500	2.13	<b>4.03</b>	<b>4.03</b>	<b>4.03</b>	3.89	7500	2.40	<b>5.50</b>	<b>5.63</b>	<b>5.63</b>	5.06			
8000	1.65	2.23	2.23	2.23	2.45	8000	1.81	<b>3.54</b>	<b>3.54</b>	<b>3.54</b>	3.21	8000	2.05	<b>4.79</b>	<b>4.95</b>	<b>4.95</b>	4.17			
8500	1.41	2.04	2.04	2.04	2.04	8500	1.56	<b>3.14</b>	<b>3.14</b>	<b>3.14</b>	2.67	8500	1.76	<b>4.20</b>	<b>4.38</b>	<b>4.38</b>	3.48			
9000	1.22	1.87	1.87	1.87	1.72	9000	1.35	2.80	2.80	2.80	2.25	9000	1.53	<b>3.68</b>	<b>3.91</b>	<b>3.91</b>	2.93			
9500	1.06	1.71	1.71	1.71	1.46	9500	1.17	2.49	2.51	2.51	1.91	9500	1.34	<b>3.24</b>	<b>3.51</b>	<b>3.51</b>	2.49			
10000	0.93	1.56	1.56	1.56	1.25	10000	1.03	2.23	2.27	2.27	1.64	10000	1.18	<b>2.87</b>	<b>3.17</b>	<b>3.17</b>	2.14			
10500	0.81	1.42	1.43	1.43	1.08	10500	0.91	2.01	2.06	2.06	1.42	10500	1.05	<b>2.56</b>	<b>2.87</b>	<b>2.87</b>	1.84			
11000	0.72	1.28	1.31	1.31	0.94	11000	0.81	1.81	1.87	1.87	1.23	11000	0.93	<b>2.29</b>	<b>2.62</b>	<b>2.62</b>	1.60			
11500	0.63	1.17	1.20	1.20	0.83	11500	0.72	1.65	1.71	1.71	1.08	11500	0.83	2.05	<b>2.40</b>	<b>2.40</b>	1.40			
12000	0.56	1.06	1.10	1.10	0.73	12000	0.64	1.49	1.58	1.58	0.95	12000	0.75	1.85	<b>2.19</b>	<b>2.20</b>	1.24			
12500	0.50	0.97	1.01	1.01	0.64	12500	0.57	1.34	1.45	1.45	0.84	12500	0.67	1.67	2.00	2.03	1.09			
13500	0.40	0.82	0.86	0.87	0.51	13500	0.47	1.10	1.24	1.24	0.67	13500	0.55	1.37	1.68	1.74	0.87			
14500		0.69	0.74	0.75	0.41	14500		0.91	1.06	1.08	0.54	14500	0.46	1.13	1.42	1.51	0.70			
15500		0.58	0.64	0.66	0.34	15500		0.76	0.91	0.94	0.44	15500		0.94	1.21	1.29	0.57			





**LEGEND**

- Values below the dotted line are outside the "20D" guide for bridging requirements.
- 7.6** Values in **bold type** require High Strength bolts (Grade 8.8)
-  For low restraint claddings reduce capacity up to 10%
-  For low restraint claddings reduce capacity up to 20%
-  For low restraint claddings reduce capacity over 20%. In these situations, refer to software.
- 1 Single number for bridging refers to the number of rows of bridging per span.
- 2 1 2 Multiple number for bridging refers to the number of rows of bridging in end and inner spans. (e.g. 2 in end spans, 1 in inner spans).

#### 4 SPAN LAPPED - OUTWARD CAPACITY

Bridging Span	SZ25015				Bridging Span	SZ25019				Bridging Span	SZ25024			
	0	1	2	3		0	1	2	3		0	1	2	3
4000	5.55	5.55	5.55	5.54	4000	<b>10.4</b>	<b>10.4</b>	<b>10.4</b>	<b>10.4</b>	4000				
4250	5.16	5.16	5.16	5.16	4250	<b>9.60</b>	<b>9.60</b>	<b>9.60</b>	<b>9.60</b>	4250				
4500	4.82	4.82	4.82	4.82	4500	<b>8.88</b>	<b>8.88</b>	<b>8.88</b>	<b>8.88</b>	4500				
4750	4.51	4.51	4.50	4.51	4750	<b>8.25</b>	<b>8.25</b>	<b>8.24</b>	<b>8.25</b>	4750				
5000	4.23	4.23	4.22	4.23	5000	<b>7.68</b>	<b>7.67</b>	<b>7.67</b>	<b>7.68</b>	5000				
5250	3.97	3.97	3.97	3.97	5250	<b>7.00</b>	<b>7.16</b>	<b>7.16</b>	<b>7.16</b>	5250				
5500	3.74	3.74	3.74	3.74	5500	<b>6.26</b>	<b>6.69</b>	<b>6.69</b>	<b>6.69</b>	5500	<b>8.41</b>			
5750	3.53	3.53	3.53	3.52	5750	<b>5.51</b>	<b>6.27</b>	<b>6.27</b>	<b>6.26</b>	5750	<b>7.30</b>			
6000	3.34	3.34	3.33	3.34	6000	<b>4.79</b>	<b>5.89</b>	<b>5.88</b>	<b>5.89</b>	6000	<b>6.33</b>	<b>8.75</b>	<b>8.80</b>	<b>8.80</b>
6250	3.06	3.16	3.16	3.16	6250	<b>4.16</b>	<b>5.53</b>	<b>5.53</b>	<b>5.53</b>	6250	<b>5.48</b>	<b>7.96</b>	<b>8.11</b>	<b>8.11</b>
6500	2.77	2.99	2.99	2.99	6500	<b>3.62</b>	<b>5.21</b>	<b>5.21</b>	<b>5.21</b>	6500	<b>4.75</b>	<b>7.26</b>	<b>7.50</b>	<b>7.50</b>
6750	2.44	2.84	2.84	2.83	6750	3.13	<b>4.88</b>	<b>4.88</b>	<b>4.88</b>	6750	<b>4.12</b>	<b>6.64</b>	<b>6.95</b>	<b>6.95</b>
7000	2.14	2.70	2.70	2.70	7000	2.73	<b>4.50</b>	<b>4.58</b>	<b>4.57</b>	7000	<b>3.60</b>	<b>6.08</b>	<b>6.47</b>	<b>6.47</b>
7500	1.66	2.45	2.45	2.45	7500	2.10	<b>3.81</b>	<b>4.03</b>	<b>4.03</b>	7500	2.77	<b>5.10</b>	<b>5.63</b>	<b>5.63</b>
8000	1.30	2.22	2.23	2.23	8000	1.64	<b>3.20</b>	<b>3.54</b>	<b>3.54</b>	8000	2.18	<b>4.24</b>	<b>4.92</b>	<b>4.95</b>
8500	1.03	1.95	2.04	2.04	8500	1.31	2.64	<b>3.14</b>	<b>3.14</b>	8500	1.74	<b>3.52</b>	<b>4.28</b>	<b>4.38</b>
9000	0.83	1.65	1.87	1.87	9000	1.06	2.19	2.76	2.80	9000	1.41	<b>2.93</b>	<b>3.74</b>	<b>3.91</b>
9500	0.67	1.39	1.70	1.71	9500	0.86	1.81	2.43	2.51	9500	1.16	<b>2.42</b>	<b>3.28</b>	<b>3.51</b>
10000	0.55	1.16	1.51	1.56	10000	0.71	1.51	2.14	2.27	10000	0.96	2.00	<b>2.87</b>	<b>3.14</b>
10500	0.46	0.96	1.34	1.43	10500	0.59	1.25	1.88	2.06	10500	0.80	1.66	<b>2.50</b>	<b>2.80</b>
11000		0.81	1.19	1.29	11000	0.50	1.04	1.63	1.85	11000	0.68	1.39	<b>2.17</b>	<b>2.51</b>
11500		0.68	1.05	1.16	11500	0.42	0.87	1.41	1.67	11500	0.58	1.17	1.89	<b>2.26</b>
12000		0.58	0.92	1.06	12000		0.74	1.22	1.51	12000	0.50	1.00	1.64	<b>2.03</b>
12500		0.49	0.81	0.96	12500		0.63	1.06	1.36	12500	0.43	0.85	1.42	1.82
13500			0.62	0.79	13500		0.47	0.80	1.09	13500		0.64	1.07	1.45
14500			0.47	0.65	14500			0.61	0.86	14500		0.49	0.81	1.16
15500				0.52	15500			0.47	0.69	15500			0.63	0.92





#### LEGEND

-  Values below the dotted line are outside the "20D" guide for bridging requirements.
- 7.6** Values in **bold type** require High Strength bolts (Grade 8.8)
-  For low restraint claddings reduce capacity up to 10%
-  For low restraint claddings reduce capacity up to 20%
-  For low restraint claddings reduce capacity over 20%. In these situations, refer to software.
- 1 Single number for bridging refers to the number of rows of bridging per span.
- 2 1 2 Multiple number for bridging refers to the number of rows of bridging in end and inner spans. (e.g. 2 in end spans, 1 in inner spans).

#### 4 SPAN LAPPED - MIXED GAUGES - INWARD CAPACITY

Bridging Span	SZ25015/SZ25019					L/150	Bridging Span	SZ25019/SZ25024					L/150
	0	1	2	3				0	1	2	3		
4000	6.21	6.20	6.21	6.21		24.6	4000	<b>11.0</b>	<b>11.3</b>	<b>11.3</b>	<b>11.3</b>		32.2
4250	5.75	5.75	5.75	5.74		20.5	4250	<b>9.65</b>	<b>10.4</b>	<b>10.4</b>	<b>10.4</b>		26.8
4500	5.33	5.33	5.33	5.32		17.3	4500	<b>8.30</b>	<b>9.55</b>	<b>9.54</b>	<b>9.54</b>		22.6
4750	4.97	4.97	4.97	4.98		14.7	4750	<b>7.19</b>	<b>8.82</b>	<b>8.82</b>	<b>8.83</b>		19.2
5000	4.65	4.65	4.65	4.64		12.6	5000	<b>6.29</b>	<b>8.18</b>	<b>8.18</b>	<b>8.18</b>		16.5
5250	4.35	4.35	4.35	4.35		10.9	5250	<b>5.54</b>	<b>7.59</b>	<b>7.59</b>	<b>7.59</b>		14.2
5500	4.08	4.08	4.07	4.07		9.48	5500	<b>4.92</b>	<b>7.06</b>	<b>7.05</b>	<b>7.05</b>		12.4
5750	3.82	3.83	3.83	3.83		8.29	5750	<b>4.39</b>	<b>6.59</b>	<b>6.58</b>	<b>6.59</b>		10.8
6000	3.50	3.61	3.61	3.61		7.30	6000	3.94	<b>6.16</b>	<b>6.16</b>	<b>6.15</b>		9.53
6250	3.17	3.40	3.40	3.40		6.46	6250	3.55	<b>5.77</b>	<b>5.77</b>	<b>5.77</b>		8.43
6500	2.87	3.21	3.21	3.20		5.74	6500	3.22	<b>5.40</b>	<b>5.40</b>	<b>5.39</b>		7.50
6750	2.62	3.04	3.04	3.04		5.13	6750	2.93	<b>5.04</b>	<b>5.04</b>	<b>5.04</b>		6.69
7000	2.39	2.88	2.88	2.88		4.60	7000	2.67	<b>4.72</b>	<b>4.72</b>	<b>4.72</b>		6.00
7500	2.01	2.59	2.59	2.59		3.74	7500	2.25	<b>4.15</b>	<b>4.15</b>	<b>4.15</b>		4.88
8000	1.71	2.34	2.34	2.34		3.08	8000	1.91	<b>3.65</b>	<b>3.65</b>	<b>3.65</b>		4.02
8500	1.47	2.13	2.13	2.13		2.57	8500	1.64	<b>3.23</b>	<b>3.23</b>	<b>3.23</b>		3.35
9000	1.27	1.94	1.94	1.94		2.16	9000	1.42	<b>2.89</b>	<b>2.89</b>	<b>2.89</b>		2.82
9500	1.11	1.76	1.76	1.76		1.84	9500	1.24	2.59	2.59	2.59		2.40
10000	0.97	1.61	1.61	1.61		1.58	10000	1.09	2.33	2.34	2.34		2.06
10500	0.85	1.47	1.47	1.47		1.36	10500	0.96	2.10	2.12	2.12		1.78
11000	0.75	1.33	1.35	1.35		1.18	11000	0.85	1.90	1.93	1.93		1.55
11500	0.66	1.21	1.23	1.23		1.04	11500	0.76	1.72	1.77	1.77		1.35
12000	0.59	1.10	1.13	1.13		0.91	12000	0.68	1.57	1.62	1.62		1.19
12500	0.53	1.01	1.04	1.04		0.81	12500	0.61	1.44	1.50	1.50		1.05
13500	0.43	0.86	0.89	0.89		0.64	13500	0.49	1.19	1.28	1.28		0.84
14500		0.73	0.77	0.78		0.52	14500	0.41	0.99	1.11	1.11		0.68
15500		0.62	0.66	0.68		0.42	15500		0.83	0.95	0.97		0.55





**LEGEND**

-  Values below the dotted line are outside the "20D" guide for bridging requirements.
- 7.6** Values in **bold type** require High Strength bolts (Grade 8.8)
-  For low restraint claddings reduce capacity up to 10%
-  For low restraint claddings reduce capacity up to 20%
-  For low restraint claddings reduce capacity over 20%. In these situations, refer to software.
- 1 Single number for bridging refers to the number of rows of bridging per span.
- 2 1 2 Multiple number for bridging refers to the number of rows of bridging in end and inner spans. (e.g. 2 in end spans, 1 in inner spans).

#### 4 SPAN LAPPED - MIXED GAUGES - OUTWARD CAPACITY

SZ25015/SZ25019					SZ25019/SZ25024				
Bridging Span	0	1	2	3	Bridging Span	0	1	2	3
4000	6.21	6.20	6.21	6.21	4000	<b>11.3</b>	<b>11.3</b>	<b>11.3</b>	<b>11.3</b>
4250	5.75	5.75	5.75	5.74	4250	<b>10.4</b>	<b>10.4</b>	<b>10.4</b>	<b>10.4</b>
4500	5.33	5.33	5.33	5.32	4500	<b>9.55</b>	<b>9.55</b>	<b>9.54</b>	<b>9.54</b>
4750	4.97	4.97	4.97	4.98	4750	<b>8.83</b>	<b>8.82</b>	<b>8.82</b>	<b>8.83</b>
5000	4.65	4.65	4.65	4.64	5000	<b>8.18</b>	<b>8.18</b>	<b>8.18</b>	<b>8.18</b>
5250	4.35	4.35	4.35	4.35	5250	<b>7.59</b>	<b>7.59</b>	<b>7.59</b>	<b>7.59</b>
5500	4.08	4.08	4.07	4.07	5500	<b>7.01</b>	<b>7.06</b>	<b>7.05</b>	<b>7.05</b>
5750	3.83	3.83	3.83	3.83	5750	<b>6.32</b>	<b>6.59</b>	<b>6.58</b>	<b>6.59</b>
6000	3.61	3.61	3.61	3.61	6000	<b>5.69</b>	<b>6.16</b>	<b>6.16</b>	<b>6.15</b>
6250	3.40	3.40	3.40	3.40	6250	<b>5.00</b>	<b>5.77</b>	<b>5.77</b>	<b>5.77</b>
6500	<b>3.10</b>	3.21	3.21	3.20	6500	<b>4.41</b>	<b>5.40</b>	<b>5.40</b>	<b>5.39</b>
6750	<b>2.82</b>	3.04	3.04	3.04	6750	<b>3.90</b>	<b>5.04</b>	<b>5.04</b>	<b>5.04</b>
7000	<b>2.55</b>	2.88	2.88	2.88	7000	<b>3.45</b>	<b>4.72</b>	<b>4.72</b>	<b>4.72</b>
7500	<b>2.01</b>	2.59	2.59	2.59	7500	2.70	<b>4.09</b>	<b>4.15</b>	<b>4.15</b>
8000	<b>1.59</b>	2.34	2.34	2.34	8000	2.13	<b>3.52</b>	<b>3.65</b>	<b>3.65</b>
8500	<b>1.28</b>	2.08	2.13	2.13	8500	1.70	<b>3.03</b>	<b>3.23</b>	<b>3.23</b>
9000	<b>1.03</b>	1.84	1.94	1.94	9000	1.37	2.60	<b>2.89</b>	<b>2.89</b>
9500	<b>0.84</b>	1.58	1.76	1.76	9500	1.13	2.20	2.59	2.59
10000	<b>0.69</b>	1.36	1.59	1.61	10000	0.93	1.86	2.31	2.34
10500	<b>0.58</b>	1.16	1.42	1.47	10500	0.78	1.58	2.06	2.12
11000	<b>0.49</b>	0.99	1.28	1.35	11000	0.66	1.35	1.84	1.93
11500	<b>0.41</b>	0.84	1.15	1.22	11500	0.56	1.15	1.65	1.77
12000		0.72	1.04	1.11	12000	0.49	0.97	1.47	1.62
12500		0.62	0.92	1.01	12500	0.42	0.83	1.29	1.47
13500		0.46	0.73	0.85	13500		0.62	1.01	1.23
14500			0.58	0.72	14500		0.48	0.79	1.02
15500			0.45	0.60	15500			0.62	0.84



#### LEGEND

-  Values below the dotted line are outside the "20D" guide for bridging requirements.
- 7.6** Values in **bold type** require High Strength bolts (Grade 8.8)
-  For low restraint claddings reduce capacity up to 10%
-  For low restraint claddings reduce capacity up to 20%
-  For low restraint claddings reduce capacity over 20%. In these situations, refer to software.
- 1 Single number for bridging refers to the number of rows of bridging per span.
- 2 1 2 Multiple number for bridging refers to the number of rows of bridging in end and inner spans. (e.g. 2 in end spans, 1 in inner spans).

## 4 SPAN LAPPED - INWARD CAPACITY

Bridging Span	SZ30019					L/150	Bridging Span	SZ30024					L/150	Bridging Span	SZ30030					L/150
	0	1	2	3				0	1	2	3				0	1	2	3		
4000	9.69	9.69	9.69	9.66	44.1	4000	18.2	18.2	18.2	18.2	57.4	4000								
4250	9.03	9.03	9.03	9.03	36.7	4250	16.4	16.9	16.9	16.9	47.9	4250								
4500	8.44	8.44	8.44	8.44	30.9	4500	14.3	15.6	15.6	15.6	40.3	4500	16.9					51.4		
4750	7.92	7.92	7.90	7.91	26.3	4750	12.2	14.6	14.5	14.6	34.3	4750	14.4					43.7		
5000	7.44	7.43	7.43	7.44	22.6	5000	10.5	13.6	13.6	13.6	29.4	5000	12.3					37.5		
5250	7.01	7.01	7.01	7.00	19.5	5250	9.14	12.7	12.7	12.7	25.4	5250	10.7					32.4		
5500	6.61	6.61	6.61	6.61	16.9	5500	8.00	11.9	11.9	11.9	22.1	5500	9.31					28.2		
5750	6.12	6.24	6.24	6.24	14.8	5750	7.06	11.2	11.2	11.2	19.3	5750	8.19	17.6	17.6	17.6		24.6		
6000	5.51	5.92	5.92	5.92	13.1	6000	6.28	10.5	10.5	10.5	17.0	6000	7.26	16.4	16.4	16.4		21.7		
6250	4.95	5.61	5.61	5.61	11.6	6250	5.61	9.91	9.91	9.91	15.0	6250	6.48	15.1	15.1	15.1		19.2		
6500	4.47	5.33	5.33	5.33	10.3	6500	5.04	9.35	9.35	9.35	13.4	6500	5.81	14.0	14.0	14.0		17.1		
6750	4.05	5.07	5.07	5.06	9.17	6750	4.56	8.84	8.84	8.82	11.9	6750	5.24	12.9	12.9	12.9		15.2		
7000	3.69	4.83	4.83	4.82	8.22	7000	4.14	8.37	8.36	8.36	10.7	7000	4.75	11.9	12.0	12.0		13.7		
7500	3.09	4.39	4.39	4.39	6.68	7500	3.45	7.47	7.47	7.47	8.71	7500	3.95	10.3	10.5	10.5		11.1		
8000	2.62	4.01	4.01	4.01	5.51	8000	2.92	6.66	6.66	6.66	7.18	8000	3.33	8.97	9.22	9.22		9.15		
8500	2.25	3.68	3.68	3.68	4.59	8500	2.50	5.90	5.94	5.94	5.98	8500	2.85	7.87	8.16	8.16		7.63		
9000	1.94	3.38	3.38	3.38	3.87	9000	2.16	5.22	5.30	5.30	5.04	9000	2.46	6.92	7.28	7.28		6.43		
9500	1.70	3.12	3.12	3.12	3.29	9500	1.89	4.64	4.75	4.75	4.29	9500	2.15	6.10	6.53	6.53		5.46		
10000	1.49	2.89	2.89	2.89	2.82	10000	1.66	4.16	4.29	4.29	3.67	10000	1.89	5.40	5.90	5.90		4.68		
10500	1.32	2.67	2.67	2.67	2.44	10500	1.47	3.74	3.89	3.89	3.17	10500	1.67	4.80	5.35	5.35		4.05		
11000	1.17	2.46	2.46	2.46	2.12	11000	1.31	3.39	3.55	3.55	2.76	11000	1.49	4.29	4.87	4.87		3.52		
11500	1.05	2.25	2.27	2.27	1.85	11500	1.17	3.06	3.24	3.24	2.42	11500	1.34	3.84	4.46	4.46		3.08		
12000	0.94	2.06	2.10	2.10	1.63	12000	1.05	2.77	2.98	2.98	2.13	12000	1.21	3.45	4.09	4.10		2.71		
12500	0.85	1.89	1.94	1.94	1.44	12500	0.95	2.51	2.75	2.75	1.88	12500	1.09	3.12	3.75	3.77		2.40		
13500	0.70	1.60	1.66	1.66	1.15	13500	0.79	2.09	2.35	2.35	1.49	13500	0.91	2.56	3.18	3.24		1.90		
14500	0.59	1.37	1.44	1.44	0.93	14500	0.66	1.75	2.04	2.04	1.21	14500	0.76	2.14	2.74	2.81		1.54		
15500	0.49	1.18	1.26	1.26	0.76	15500	0.56	1.49	1.78	1.79	0.99	15500	0.65	1.80	2.37	2.45		1.26		





**LEGEND**

- Values below the dotted line are outside the "20D" guide for bridging requirements.
- 7.6** Values in **bold type** require High Strength bolts (Grade 8.8)
-  For low restraint claddings reduce capacity up to 10%
-  For low restraint claddings reduce capacity up to 20%
-  For low restraint claddings reduce capacity over 20%. In these situations, refer to software.
- 1 Single number for bridging refers to the number of rows of bridging per span.
- 2 1 2 Multiple number for bridging refers to the number of rows of bridging in end and inner spans. (e.g. 2 in end spans, 1 in inner spans).

#### 4 SPAN LAPPED - OUTWARD CAPACITY

Bridging Span	SZ30019				Bridging Span	SZ30024				Bridging Span	SZ30030			
	0	1	2	3		0	1	2	3		0	1	2	3
4000	9.69	9.69	9.69	9.66	4000	<b>18.2</b>	<b>18.2</b>	<b>18.2</b>	<b>18.2</b>	4000				
4250	9.03	9.03	9.03	9.03	4250	<b>16.9</b>	<b>16.9</b>	<b>16.9</b>	<b>16.9</b>	4250				
4500	8.44	8.44	8.44	8.44	4500	<b>15.6</b>	<b>15.6</b>	<b>15.6</b>	<b>15.6</b>	4500				
4750	7.92	7.92	7.90	7.91	4750	<b>14.6</b>	<b>14.6</b>	<b>14.5</b>	<b>14.6</b>	4750				
5000	7.44	7.43	7.43	7.44	5000	<b>13.6</b>	<b>13.6</b>	<b>13.6</b>	<b>13.6</b>	5000				
5250	7.01	7.00	7.00	7.00	5250	<b>12.7</b>	<b>12.7</b>	<b>12.7</b>	<b>12.7</b>	5250				
5500	6.61	6.61	6.61	6.61	5500	<b>11.9</b>	<b>11.9</b>	<b>11.9</b>	<b>11.9</b>	5500	<b>18.6</b>			
5750	6.25	6.24	6.24	6.24	5750	<b>11.2</b>	<b>11.2</b>	<b>11.2</b>	<b>11.2</b>	5750	<b>17.0</b>	<b>17.6</b>	<b>17.6</b>	<b>17.6</b>
6000	5.92	5.92	5.92	5.92	6000	<b>10.5</b>	<b>10.5</b>	<b>10.5</b>	<b>10.5</b>	6000	<b>15.4</b>	<b>16.4</b>	<b>16.4</b>	<b>16.4</b>
6250	5.61	5.61	5.61	5.61	6250	<b>9.91</b>	<b>9.91</b>	<b>9.91</b>	<b>9.91</b>	6250	<b>13.8</b>	<b>15.1</b>	<b>15.1</b>	<b>15.1</b>
6500	5.33	5.33	5.33	5.33	6500	<b>9.19</b>	<b>9.35</b>	<b>9.35</b>	<b>9.35</b>	6500	<b>12.4</b>	<b>14.0</b>	<b>14.0</b>	<b>14.0</b>
6750	5.07	5.07	5.07	5.06	6750	<b>8.46</b>	<b>8.84</b>	<b>8.84</b>	<b>8.82</b>	6750	<b>11.1</b>	<b>12.9</b>	<b>12.9</b>	<b>12.9</b>
7000	4.83	4.83	4.83	4.82	7000	<b>7.67</b>	<b>8.37</b>	<b>8.36</b>	<b>8.36</b>	7000	<b>9.95</b>	<b>12.0</b>	<b>12.0</b>	<b>12.0</b>
7500	4.39	4.39	4.39	4.39	7500	<b>6.15</b>	<b>7.47</b>	<b>7.47</b>	<b>7.47</b>	7500	<b>8.00</b>	<b>10.5</b>	<b>10.5</b>	<b>10.5</b>
8000	3.78	4.01	4.01	4.01	8000	4.93	<b>6.66</b>	<b>6.66</b>	<b>6.66</b>	8000	<b>6.45</b>	<b>9.06</b>	<b>9.22</b>	<b>9.22</b>
8500	3.10	3.68	3.68	3.68	8500	4.01	<b>5.85</b>	<b>5.94</b>	<b>5.94</b>	8500	<b>5.22</b>	<b>7.91</b>	<b>8.16</b>	<b>8.16</b>
9000	2.51	3.38	3.38	3.38	9000	3.26	5.13	5.30	5.30	9000	4.21	<b>6.95</b>	<b>7.28</b>	<b>7.28</b>
9500	2.05	3.12	3.12	3.12	9500	2.66	4.53	4.75	4.75	9500	3.43	<b>6.08</b>	<b>6.53</b>	<b>6.53</b>
10000	1.70	2.88	2.89	2.89	10000	2.19	4.02	4.29	4.29	10000	2.83	<b>5.29</b>	<b>5.89</b>	<b>5.90</b>
10500	1.42	2.59	2.67	2.67	10500	1.82	3.52	3.89	3.89	10500	2.36	<b>4.61</b>	<b>5.28</b>	<b>5.35</b>
11000	1.19	2.29	2.46	2.46	11000	1.53	3.07	3.53	3.55	11000	1.98	4.00	<b>4.76</b>	<b>4.87</b>
11500	1.00	2.01	2.27	2.27	11500	1.29	2.66	3.19	3.24	11500	1.68	3.48	<b>4.31</b>	<b>4.46</b>
12000	0.85	1.76	2.08	2.10	12000	1.10	2.30	2.89	2.98	12000	1.44	3.02	3.91	<b>4.10</b>
12500	0.73	1.54	1.89	1.94	12500	0.95	1.99	2.63	2.75	12500	1.24	2.63	3.56	3.76
13500	0.55	1.16	1.59	1.66	13500	0.71	1.51	2.19	2.35	13500	0.94	1.99	2.88	3.17
14500	0.42	0.88	1.33	1.43	14500	0.55	1.16	1.79	1.99	14500	0.72	1.51	2.34	2.70
15500		0.69	1.09	1.23	15500	0.43	0.89	1.44	1.71	15500	0.57	1.17	1.89	2.31

**LEGEND**

-  Values below the dotted line are outside the "20D" guide for bridging requirements.
- 7.6** Values in **bold type** require High Strength bolts (Grade 8.8)
-  For low restraint claddings reduce capacity up to 10%
-  For low restraint claddings reduce capacity up to 20%
-  For low restraint claddings reduce capacity over 20%. In these situations, refer to software.
- 1 Single number for bridging refers to the number of rows of bridging per span.
- 2 1 2 Multiple number for bridging refers to the number of rows of bridging in end and inner spans. (e.g. 2 in end spans, 1 in inner spans).

#### 4 SPAN LAPPED - MIXED GAUGES - INWARD CAPACITY

Bridging Span	SZ30019/SZ30024					Bridging Span	SZ30024/SZ30030				
	0	1	2	3	L/150		0	1	2	3	L/150
4000	10.9	10.9	10.9	10.9	55.3	4000	<b>20.0</b>	<b>20.0</b>	<b>20.0</b>	<b>20.0</b>	70.9
4250	10.1	10.1	10.1	10.1	46.1	4250	<b>17.8</b>	<b>18.4</b>	<b>18.4</b>	<b>18.4</b>	59.1
4500	9.42	9.42	9.41	9.40	38.8	4500	<b>15.5</b>	<b>17.0</b>	<b>17.0</b>	<b>16.9</b>	49.8
4750	8.81	8.79	8.80	8.81	33.0	4750	<b>13.2</b>	<b>15.7</b>	<b>15.7</b>	<b>15.7</b>	42.3
5000	8.25	8.25	8.25	8.24	28.3	5000	<b>11.4</b>	<b>14.6</b>	<b>14.6</b>	<b>14.6</b>	36.3
5250	7.74	7.74	7.74	7.74	24.4	5250	<b>9.89</b>	<b>13.6</b>	<b>13.6</b>	<b>13.6</b>	31.4
5500	7.21	7.27	7.26	7.25	21.3	5500	<b>8.65</b>	<b>12.7</b>	<b>12.7</b>	<b>12.7</b>	27.3
5750	6.56	6.85	6.84	6.85	18.6	5750	7.62	<b>11.9</b>	<b>11.9</b>	<b>11.9</b>	23.9
6000	5.85	6.47	6.46	6.46	16.4	6000	6.76	<b>11.1</b>	<b>11.1</b>	<b>11.1</b>	21.0
6250	5.24	6.11	6.11	6.11	14.5	6250	6.03	<b>10.4</b>	<b>10.4</b>	<b>10.4</b>	18.6
6500	4.72	5.78	5.77	5.77	12.9	6500	5.42	<b>9.80</b>	<b>9.79</b>	<b>9.78</b>	16.5
6750	4.28	5.48	5.48	5.48	11.5	6750	4.89	<b>9.23</b>	<b>9.23</b>	<b>9.23</b>	14.8
7000	3.89	5.20	5.21	5.21	10.3	7000	4.43	<b>8.70</b>	<b>8.71</b>	<b>8.71</b>	13.2
7500	3.26	4.70	4.70	4.70	8.38	7500	3.69	<b>7.70</b>	<b>7.70</b>	<b>7.70</b>	10.8
8000	2.76	4.27	4.27	4.27	6.91	8000	3.12	<b>6.85</b>	<b>6.85</b>	<b>6.85</b>	8.86
8500	2.36	3.89	3.89	3.89	5.76	8500	2.67	<b>6.11</b>	<b>6.11</b>	<b>6.11</b>	7.39
9000	2.04	3.56	3.56	3.56	4.85	9000	2.30	<b>5.43</b>	<b>5.45</b>	<b>5.45</b>	6.22
9500	1.78	3.27	3.26	3.26	4.12	9500	2.01	4.83	4.89	4.89	5.29
10000	1.57	3.01	3.01	3.01	3.54	10000	1.77	4.33	4.41	4.41	4.54
10500	1.39	2.76	2.76	2.76	3.06	10500	1.56	3.90	4.00	4.00	3.92
11000	1.23	2.54	2.54	2.54	2.66	11000	1.39	3.53	3.65	3.65	3.41
11500	1.10	2.34	2.34	2.34	2.33	11500	1.25	3.21	3.34	3.34	2.98
12000	0.99	2.14	2.16	2.16	2.05	12000	1.12	2.93	3.07	3.07	2.63
12500	0.90	1.96	2.00	2.00	1.81	12500	1.01	2.67	2.83	2.83	2.32
13500	0.74	1.67	1.71	1.71	1.44	13500	0.84	2.23	2.42	2.42	1.84
14500	0.62	1.43	1.49	1.49	1.16	14500	0.70	1.88	2.10	2.10	1.49
15500	0.52	1.24	1.30	1.30	0.95	15500	0.60	1.60	1.84	1.84	1.22

#### LEGEND

--- Values below the dotted line are outside the "20D" guide for bridging requirements.

**7.6** Values in **bold type** require High Strength bolts (Grade 8.8)

 For low restraint claddings reduce capacity up to 10%

 For low restraint claddings reduce capacity up to 20%

 For low restraint claddings reduce capacity over 20%  
In these situations, refer to software.

1 Single number for bridging refers to the number of rows of bridging per span.





2 1 2 Multiple number for bridging refers to the number of rows of bridging in end and inner spans. (e.g. 2 in end spans, 1 in inner spans).



#### 4 SPAN LAPPED - MIXED GAUGES - OUTWARD CAPACITY

SZ30019/SZ30024					SZ30024/SZ30030				
Bridging Span	0	1	2	3	Bridging Span	0	1	2	3
4000	10.9	10.9	10.9	10.9	4000	<b>20.0</b>	<b>20.0</b>	<b>20.0</b>	<b>20.0</b>
4250	10.1	10.1	10.1	10.1	4250	<b>18.4</b>	<b>18.4</b>	<b>18.4</b>	<b>18.4</b>
4500	9.42	9.42	9.41	9.40	4500	<b>17.0</b>	<b>17.0</b>	<b>17.0</b>	<b>16.9</b>
4750	8.81	8.79	8.80	8.81	4750	<b>15.7</b>	<b>15.7</b>	<b>15.7</b>	<b>15.7</b>
5000	8.25	8.25	8.25	8.24	5000	<b>14.6</b>	<b>14.6</b>	<b>14.6</b>	<b>14.6</b>
5250	7.74	7.74	7.74	7.74	5250	<b>13.6</b>	<b>13.6</b>	<b>13.6</b>	<b>13.6</b>
5500	7.27	7.27	7.26	7.25	5500	<b>12.7</b>	<b>12.7</b>	<b>12.7</b>	<b>12.7</b>
5750	6.86	6.85	6.84	6.85	5750	<b>11.9</b>	<b>11.9</b>	<b>11.9</b>	<b>11.9</b>
6000	6.47	6.47	6.46	6.46	6000	<b>11.1</b>	<b>11.1</b>	<b>11.1</b>	<b>11.1</b>
6250	6.11	6.11	6.11	6.11	6250	<b>10.4</b>	<b>10.4</b>	<b>10.4</b>	<b>10.4</b>
6500	5.78	5.78	5.77	5.77	6500	<b>9.80</b>	<b>9.80</b>	<b>9.79</b>	<b>9.78</b>
6750	5.48	5.48	5.48	5.48	6750	<b>9.13</b>	<b>9.23</b>	<b>9.23</b>	<b>9.23</b>
7000	5.20	5.20	5.20	5.20	7000	<b>8.45</b>	<b>8.70</b>	<b>8.71</b>	<b>8.71</b>
7500	4.70	4.70	4.70	4.70	7500	<b>7.10</b>	<b>7.70</b>	<b>7.70</b>	<b>7.70</b>
8000	4.23	4.27	4.27	4.27	8000	<b>5.86</b>	<b>6.85</b>	<b>6.85</b>	<b>6.85</b>
8500	3.64	3.89	3.89	3.89	8500	4.81	<b>6.11</b>	<b>6.11</b>	<b>6.11</b>
9000	3.06	3.56	3.56	3.56	9000	3.96	<b>5.43</b>	<b>5.45</b>	<b>5.45</b>
9500	2.53	3.27	3.26	3.26	9500	3.30	4.80	4.89	4.89
10000	2.10	3.01	3.01	3.01	10000	2.75	4.27	4.41	4.41
10500	1.75	2.75	2.76	2.76	10500	2.30	3.82	4.00	4.00
11000	1.48	2.47	2.54	2.54	11000	1.94	3.43	3.65	3.65
11500	1.26	2.23	2.34	2.34	11500	1.64	3.06	3.34	3.34
12000	1.08	2.01	2.16	2.16	12000	1.41	2.71	3.06	3.07
12500	0.92	1.78	1.99	2.00	12500	1.21	2.39	2.79	2.83
13500	0.69	1.41	1.68	1.71	13500	0.91	1.85	2.34	2.42
14500	0.53	1.10	1.43	1.49	14500	0.71	1.45	1.98	2.10
15500	0.42	0.86	1.22	1.30	15500	0.56	1.14	1.68	1.81

#### LEGEND

-  Values below the dotted line are outside the "20D" guide for bridging requirements.
- 7.6** Values in **bold type** require High Strength bolts (Grade 8.8)
-  For low restraint claddings reduce capacity up to 10%
-  For low restraint claddings reduce capacity up to 20%
-  For low restraint claddings reduce capacity over 20%. In these situations, refer to software.
- 1 Single number for bridging refers to the number of rows of bridging per span.
- 2 1 2 Multiple number for bridging refers to the number of rows of bridging in end and inner spans. (e.g. 2 in end spans, 1 in inner spans).

## 4.4 CAPACITY TABLES - OTHER DESIGN EFFECTS

### DESIGN OPTIMISATION

The purlin capacity tables provide economic design solutions for a wide range of purlin configurations typical of most projects.

The LYSAGHT® purlin software is available carry out project specific designs to obtain more economic design solutions. The software carries out the analysis and design for the purlin system and has the flexibility to incorporate variations in the configurations and loads.

For project specific designs the LYSAGHT® purlin software can optimise the design by the variation of:

- variation span quantity - up to 12
- variation of any or all span lengths - non equal spans
- variation of purlin thickness in any or all spans - non equal thickness
- nesting of purlins at the end spans
- inclusion of cantilever(s)
- variation of bridging quantity in each span - non equal quantity per span
- variation of bridging location in each span - non standard position
- variation of lap lengths at any or all supports - non standard lapping
- variation of bolting quantity/grade/size for the configuration
- availability to inserting other loads - step, pattern, axial, point and moment
- insertion of load cases
- variation of cladding restraint
- numerous other features of variability

For special projects, where design assistance is required that is beyond the capacity tables or software, please contact your local Lysaght Service Centre and provide all the relevant project details and design information. Lysaght have an in-house version of the software which is capable of investigating many other options, including non-standard purlin profiles.

### STEPPED LOADING

Stepped loads on purlins can occur from a wide range of reasons such as:

- variations in dead loads - such as differing ceilings from say cool rooms;
- roof top mechanical equipment;
- roof top walk ways;
- wind local pressure factors.

Over the years there has been many methods of determining the effect of stepped loading on purlins by use of simple reduction factors. This approach is of benefit in structures where the LYSAGHT® purlin software is unavailable. The most familiar is the equivalent UDL method. Lysaght has carried out a sensitivity analysis on the purlins under stepped loads and determined new modification factors.

Tables of modification factors have been determined for two types of typical stepped loads. One is for a stepped load located at the end span commencing at the end support and extending into the end span for a distance up to the first internal support or further. This is termed a "fixed location". The other is for a stepped load located anywhere along a span. This load can be located in any of the spans. This is termed a "variable location".

**Table 1**

Modification factor stepped load along ridges or eaves.

a/L	w <sub>2</sub> /w <sub>1</sub>		
	1.5	2	2.5
0.25	1.31	1.63	1.94
0.5	1.53	2.06	2.58
0.75	1.65	2.29	2.94
1	1.68	2.37	3.05

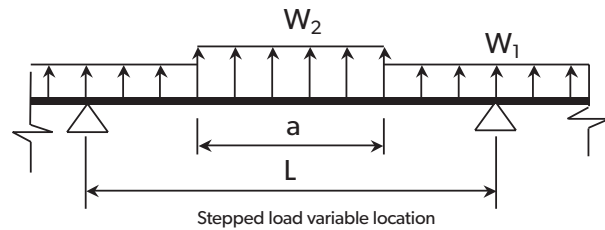

**Table 2**

Modification factor stepped load with fixed location.

a/L	w <sub>2</sub> /w <sub>1</sub>		
	1.5	2	2.5
0.25	1.22	1.44	1.66
0.5	1.43	1.86	2.29
0.75	1.62	2.25	2.87
1	1.68	2.37	3.05

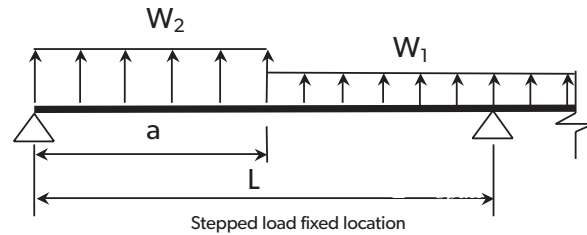

Note:

1. Interpolation is permitted
2. For a/L bigger than 1, it shall be taken as 1

To determine the "equivalent UDL" for the stepped load configuration simply multiply the "general UDL" with the appropriate modification factor from the table.

These modification factors are conservative and can be applied to any multi-span configuration that is lapped or unlapped:

$$w_3 = w_1 \times \mu$$

where w<sub>3</sub> = equivalent UDL

w<sub>1</sub> = UDL on roof (wall) due to load combinations which may include wind, dead and live loads

w<sub>2</sub> = stepped load

Wind local pressure zones as given in AS/NZS 1170.2:2011, Figure 5.3 as shown below is an example of stepped loads.

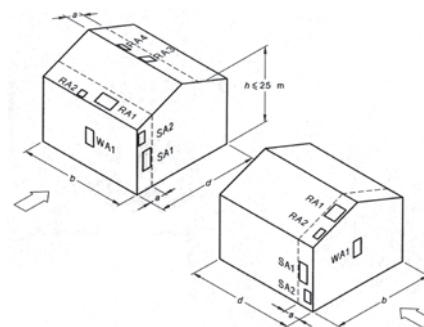

**EXAMPLE:**

Determine  $w_3$  (equivalent design UDL) for the purlins located along eaves or ridge (stepped load variable location). The length of the span of a continuous purlin is 5m,  $a=2.5$  m ( $K_1=1.5$ )

- $w_1 = 1.6$  kN/m (due to  $W + 0.9G$  load combination)
  - $w_2 = 2.6$  kN/m (due to  $W + 0.9G$  load combination with  $K_1=1.5$ )
  - $a/L = 2.5 / 5 = 0.5$
  - $w_2/w_1 = 2.6 / 1.6 = 1.625$
  - $\mu = 1.66$  (from Table 1 with interpolation)
  - $w_3 = 1.6 \times 1.66 = 2.66$  kN/m
- Thus select a purlin configuration to carry a load of 2.66 kN/m.

- $P$  = single point load (kN)
- $L$  = span (m)
- $a$  = larger distance from support (m)
- $b$  = smaller distance from support (m)
- $w$  = equivalent uniform load (kN/m)
- $N$  = number of point loads over one span (for 6 or more loads)

**POINT LOADS**

The values in the capacity tables assume uniformly distributed loading. However, in many applications (like the mounting of services and maintenance equipment) the loads applied to a structure are point loads. Thus, to use these tables for point loading, the loads must be converted to an 'equivalent' UDL in a similar fashion as applied to stepped loads.







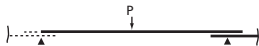

The following table gives conversion formulae for loads on single spans and continuous lapped spans. They have been derived from commonly published moment and shear forces data, and give conservative conversions.

For single spans the formulae are straight forward. For continuous lapped spans the formulae depend on the number of spans, the position of the span and the lapping ratio; thus the worst-case configuration has been used, and the values may be safely used for end spans, internal spans and any lapping ratio greater than 10%.

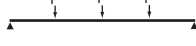

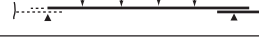
Formulae for loads on continuous unlapped configurations, and for deflections in all configurations, are not given but may be derived similarly.

**Conversion of point loads into equivalent uniform loads**

**Symmetrical equidistant point loads**

Loading condition		Conversion formula
SINGLE LOAD	Simple 	$w = 2P/L$
	Lapped 	$w = 2.22P/L$
2 LOADS	Simple 	$w = 2.67P/L$
	Lapped 	$w = 3.16P/L$
3 LOADS	Simple 	$w = 4P/L$
	Lapped 	$w = 3.78P/L$
4 LOADS	Simple 	$w = 4.80P/L$
	Lapped 	$w = 5.12P/L$
5 LOADS	Simple 	$w = 6P/L$
	Lapped 	$w = 6.65P/L$
6 OR MORE LOADS	Simple 	$w = 1.14NP/L$
	Lapped 	$w = 1.22NP/L$

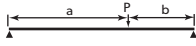
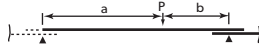
**Single eccentric and two symmetrical point loads**

Loading condition		Conversion formula
SINGLE ECCENTRIC POINT LOAD	Simple 	$w = 8abP/L^3$
	Lapped 	$w = 17.76ab^2P/L^4$
2 SYMMETRICAL POINT LOADS	Simple 	$w = 8bP/L^2$
	Lapped 	$w = 9.45b(2L-3b)P/L^3$

## AXIAL LOADS

Where a section is not loaded to its full capacity in bending, it has a reserve of strength to carry some axial load. This reserve in purlins and girts can be used to transmit forces due to wind loading on end walls, or to resist forces due to bracing of wall and roof structures.

Where required, the axial load capacity should be calculated using AS/NZS 4600 Cold-formed steel structures.

The LYSAGHT® purlin software has the capability of investigating purlin configurations with a variety of loads including axial loads.

## SPECIFICATION STATEMENT

SUPAPURLINS® (SUPAZED® and SUPACEE®) are manufactured using genuine BlueScope® GALVSPAN®. This guarantees you strength and corrosion-resistant coating consistency which leads to a long product service life.

It is very important that the correct specifications of the purlins, girts and bridging is maintained. With the improved performance of the SUPAPURLINS® (SUPAZED® and SUPACEE®) the so-called 'equivalent' product is not valid with traditional purlin shapes. Even with traditional purlin profiles, small changes in specifications (overall dimensions, radii, lip lengths, material etc.) can lead to substantive reduction in capacity. Below is a typical specification on LYSAGHT SUPAPURLIN® and accessories.

The purlins/girts shall be comprised of the LYSAGHT SUPAPURLIN® section with a coating class of Z350. The bridging system for the purlins/girts shall be the LYSAGHT HOOK-LOK® II bridging system. The bolts used for the purlins/girts and bridging (where applicable) shall be with LYSAGHT® purlin Bolts of Grade 4.6 or Grade 8.8, the bolt size and grade as detailed on the drawings.

If alternative purlin/girt sections, bridging systems or bolts are proposed, then written permission must be sought from the design engineer. The alternative proposal shall be submitted with all relevant details of the alternative products including capacity of the purlin/girt section calculated in accordance with AS/NZS 4600 Cold Formed Steel Structures code. Any proposed alternative to the bolts must be with bolts compliant to AS/NZS 4600 Cold Formed Steel Structures code.

## SECTION 5

### 5.0 Purlin & Girts - Design Matters



Failures can result when the design issues detailed in this chapter are not applied correctly.

## 5.1 PURLIN ORIENTATION

### TOP FLANGE ORIENTATION

There is no right or wrong in the orientation of purlins and girts, however there are some considerations that need attention in determining the most appropriate orientation for individual projects. There are preferences based on general industry practice and experience to minimise installation issues or to minimise in-service issues. The pros and cons of the various orientations are given below.

#### PURLINS

##### 1) Cee purlin on high side of cleat

Installation and layout of purlins is simple. Good stability during construction. Difficult to clean out. Standard mode.

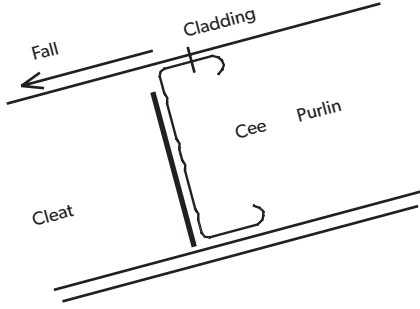

##### 2) Zed purlin on high side of cleat

Installation and layout of purlins is simple, but difficult on steeper roofs. Poor stability during construction. Difficult to clean out.

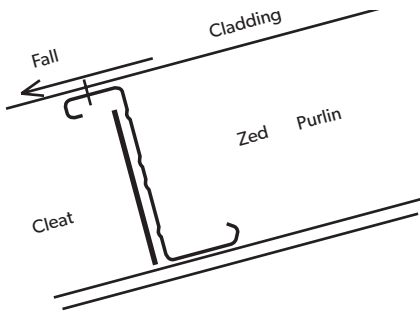

##### 3) Cee purlin on low side of cleat

Installation and layout of purlins is difficult. Poor stability during construction. Easy to clean out.

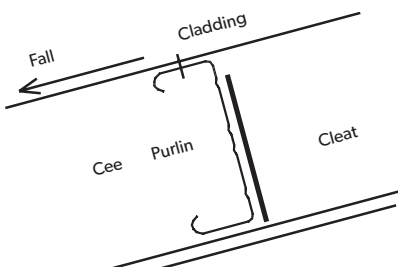

##### 4) Zed purlin on low side of cleat

Installation and layout of purlins is simple. Good stability during construction. Easier to clean out. Standard mode.

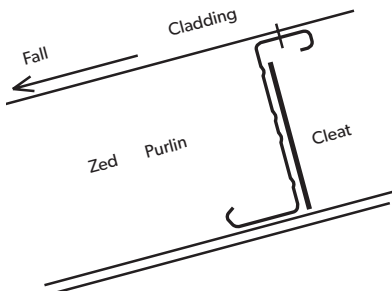

#### GIRTS

##### 1) Cee girt under cleat

Installation and layout of girts is difficult. Easy to clean out. No screened 'mouse runs'. Standard mode.

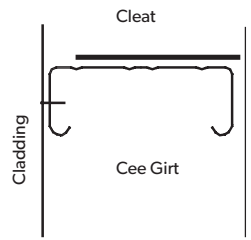

##### 2) Zed girt under cleat

Installation and layout of girts is difficult. Easy to clean out. No screened 'mouse runs'. Standard mode.

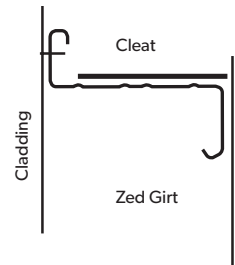

##### 3) Cee girt atop of cleat

Installation and layout of girts is simple. Difficult to clean out. Screened 'mouse runs'.

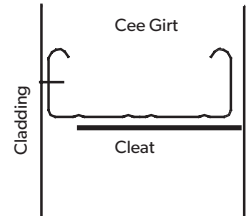

##### 4) Zed girt atop of cleat

Installation and layout of girts is simple. Difficult to clean out. Screened 'mouse runs'.

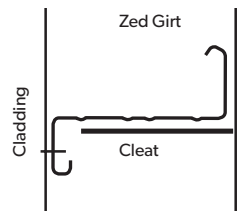

## PROPENSITY FOR TWISTING

With regard to purlin installation it is necessary to consider stability issues during construction. The stability issue arises from the purlin's propensity for twisting.

Purlins have the following properties:

- thin walled sections resulting in a low torsional stiffness
- generally monosymmetric (such as 'C' purlins), resulting in the shear centre being eccentric from their centroid.

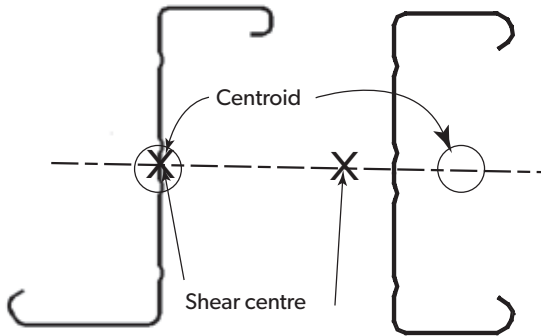

Any loading which is eccentric from the axis of shear centre will result in torsional deformation, as well as flexural deformation.

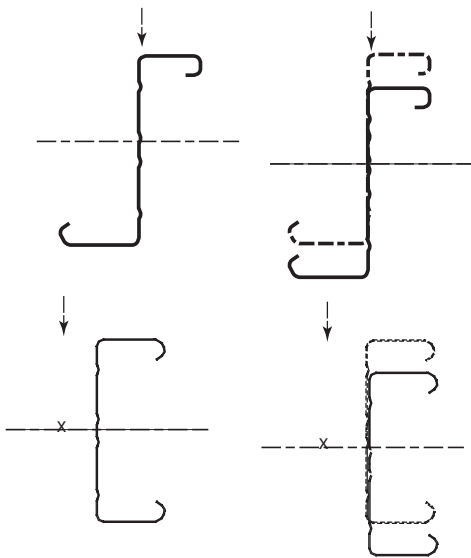

Loading through shear centre results in flexural deformation only

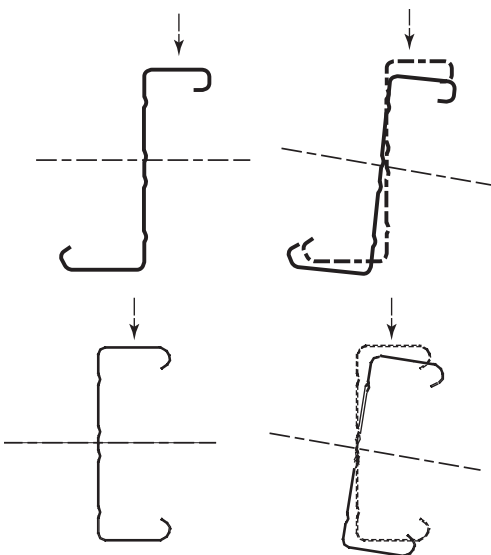

Loading away from shear centre results in flexural and torsional deformation

So in practice it is best to reduce eccentric loading by reducing the lever arm or eccentricity "e" from the shear centre. Thus it is best to have the top flanges of purlins pointing towards the apex of building.

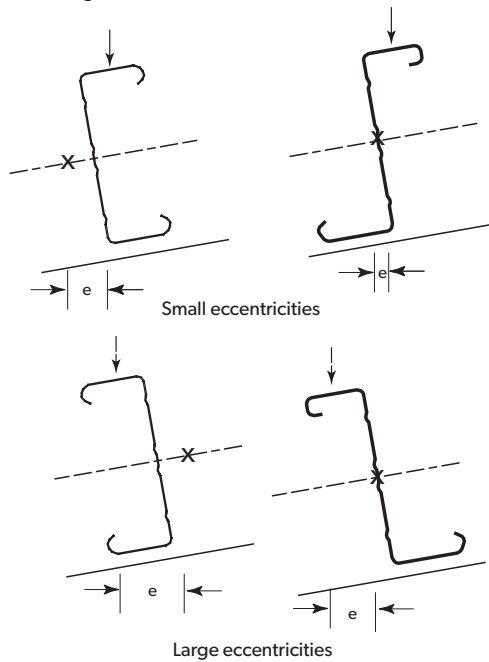

Generally the vertical load is due to self weights (e.g. purlins and sheeting) and live loads. These would be of concern during erection, especially during installation of sheeting.

Note: If purlins are twisted during the cladding installation and fixed in this twisted state then the capacity of the purlins could be considerably reduced.

In service the major loading is from wind and this acts normal to the plane of the sheeting. Thus during in-service loading there is no preference which way the purlins are placed.

## 5.2 SUPAZED® WIDE/NARROW FLANGE ORIENTATION

On special projects it may be possible to obtain greater strength from SUPAZED® profiles by selection of the purlin orientation (wide/narrow flange orientation) in particular spans.

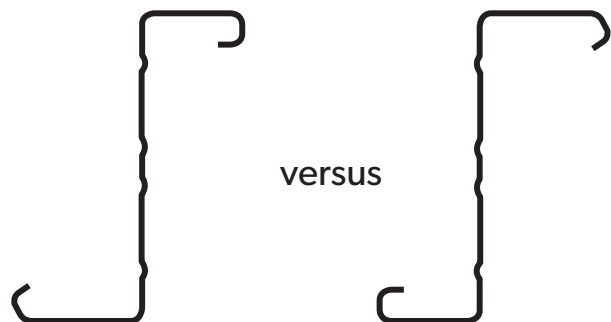

In projects where the SUPAZED® purlin orientation has been incorporated as part of the design it will be necessary for the construction drawings to be clear as to the necessary details and also for site management to be vigilant to ensure that the orientation is correct.

For special projects where orientation may be a consideration please contact your local Lysaght Service Centre and provide all the relevant project details and design information.

## 5.3 BRIDGING DESIGN

### GENERAL

The design of a traditional roof/wall system consists of a cladding, purlins/girts and bridging. In the past the designer has not been fully aware of the importance of the bridging system to the overall performance of the roof/wall systems. The designer understood that they needed to specify the number of rows of bridging, however the type of bridging, detailing of bridging, location of bridging, etc. was often neglected. Thus it was often left to the detailer, fabricator and builder to detail, supply and erect a suitable bridging system. From recent developments and investigation in the performance of roof/wall systems by Lysaght, we have identified the need for a more detailed approach for the selection and design of the bridging system.

The following sections allow the designer to understand the issues involved in the design of roof/wall systems and thus appropriately select and design the bridging system to suit their application.

In projects where further guidance is required it is suggested that the details of the project be forwarded to our nearest Lysaght Service Centre.

### OVERVIEW OF PURLIN DESIGN

The design of purlins and girts consists of section design and connections and member design. The section design is a function of the overall profile shape, profile stiffeners, profile dimensions, bend radii, thickness of material and strength (yield) of the material. The designer should be aware that any change to these parameters can have a significant effect on the overall capacity of the profiles. This warning is also applicable to traditional purlin profiles since there are differences in the purlin profile between the manufacturers.

The member design involves both deflections ("in-plane" movement) and strength. The strength is increased by the inclusion of restraint to either minimise or prevent the lateral and rotational movement of the member often referred to as flexural-torsional buckling ("out-of-plane" movement).

The "in-plane" movement or deflection occurs in the  $y'-y'$  axis (vertically) and 'out-of-plane' movement occurs in the  $x'-x'$  axis (horizontally) and/or rotation in the  $x'-y'$  plane.

### "IN-PLANE" DEFLECTION

This deflection is typically designed for by the structural engineer and is typically limited to a span/deflection ratio limit or limited to a deflection value based on a design load (usually a service load). This is easily accommodated by use of proprietary capacity tables for typical purlin span configurations.

### "OUT-OF-PLANE" MOVEMENT - DURING CONSTRUCTION

During construction it is important to ensure that the purlins and girts are installed in the straight position. Excessive "out-of-straightness" can result in induced eccentric loads thus reducing the load carrying capacity of the purlin sections. The codes provide some guidance as to the acceptable "out-of-straightness" (referred to as tolerances) for structural members and erection placement.

Bridging is required in the construction stage to ensure that the purlins and girts are installed in a straight or aligned condition. Adjustable bridging sections are required to provide site adjustment to line up the purlins and girts. This is readily seen in walls, where there is a tendency for the girts to sag, however this is also applicable on steep roofs or where there is a tendency for slender purlins to roll. In roof installations this roll or sag is exacerbated when the purlins are loaded with bundles of cladding and when subjected to roof traffic while laying the cladding.

As a guide the suggested maximum bridging spacing of 20 times the section depth (20D) has been successfully adopted in the industry. With large spans and deeper sections a guide of 15D may be more appropriate. For practical considerations this results in the use of at least one row of bridging in each span.

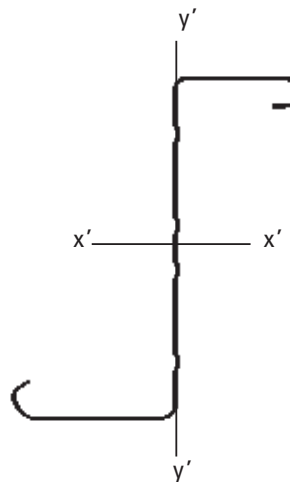

### "OUT-OF-PLANE" MOVEMENT - IN SERVICE

The "out-of-plane" movement is a natural tendency for slender members and thin walled purlin sections. The restriction of the "out-of-plane" movement can significantly increase the member capacity of the purlin section. This is accomplished by including rows of bridging in conjunction with fixing of the cladding to the outside flange of the purlin.

The limitation of this movement is taken into account by the structural engineer by simply nominating the number of rows of bridging (1, 2 or 3 rows of bridging) that is required to achieve the desired load. This is easily accommodated by use of proprietary capacity tables for typical purlin span configurations.

### OVERVIEW OF BRIDGING SYSTEMS

The "out-of-plane" movement (both lateral and rotational) of purlins and girts is controlled by providing a restraint. This restraint is provided by both the cladding and bridging members.



## CLADDING

The cladding provides restraint at the attached flange only. The restraint available from cladding is only available during the “in service” stage whereas during the construction stage (no cladding) only bridging members are available to provide this restraint. The cladding provides continuous restraint along the length of the purlin or girt.

## BRIDGING

A bridging system consists of a continuous series of members located between each set of roof purlins or wall girts. The bridging system consists of solid bridging members and ties. The bridging provides point restraint to the purlin or girt. These points are located within the span of the purlin or girt at locations to provide the maximum benefit (e.g. one row of bridging located at mid-span).

Ties, as the name suggests, are only loaded in tension and are usually threaded rods with nuts, turnbuckles, or some other adjustable method. Installation of threaded tie rods is labour intensive and is not easily done. Tie rods are ideal to accommodate site adjustment to align purlins and girts during erection and to hold roof/wall panels aligned during the installation of the cladding. Ties are generally located at eaves, ridge and expansion joints.

The industry trend for bridging systems consists largely of solid bridging members with the ties located at a few locations to allow for site alignment. This system saves considerable time and effort during erection and thus is the most economic system.

Solid bridging members are designed to provide suitable restraint in compression, tension and bending. The features of a suitable solid bridging member are:

- stiff channel between the purlins/girts. For fixed bridging members a single channel is used;
- brackets at both ends of the channel. These brackets are securely fixed to the channel to prevent differential movement;
- each bracket is designed to provide attachment to the web of the purlin/girt at two locations. The locations are as close to the flanges as is practically possible. The industry has standard “gauge lines” which are commonly accepted as a practical location;
- the brackets attach to the web of the purlin/girt and securely lock the web from rotation and “out-of-plane” movement;
- each bridging member (channel and end brackets) needs to be sufficiently robust to minimise damage during handling and erection. Damage can result in the assembly giving ineffective strength for restraint.

A bridging system consisting of only ties, will require both ends of the bridging run to be anchored to a suitable structure (rafter, structural beam, etc.) to carry the loads - termed “tie-back”. A bridging system consisting of the solid bridging assemblies generally do not require a “tie-back” at the ends of the run.

In certain projects where a cladding is used which does NOT provide sufficient flange restraint, then it may be necessary to provide a series of “tie-backs”.

## DESIGN STAGES FOR BRIDGING

As stated earlier there are two stages that need to be catered for where bridging has an important part and thus needs to be considered in the design process of purlins/girts. The stages are “during construction” and “in service”.

## DURING CONSTRUCTION - PRIOR TO FIXING OF CLADDING

At this stage the bridging needs to be designed to carry the induced loads from:

- restraining the purlins/girts in the correct alignment from self weight deflections (vertical sagging in wall, lateral sagging and rotation in roofs);
- restraining the purlins/girts in the correct alignment when carrying wind loads prior to the installation of the cladding;
- restraining the purlins in the correct alignment when carrying the vertical construction loads on the roof. These construction loads are due to live loads of erectors and self weight of the bundled roof cladding. These loads can be severe on steep slopes.

## DURING CONSTRUCTION - FIXING OF CLADDING

The installation of most LYSAGHT® claddings will immediately provide rigidity to the roof or wall system, by diaphragm action, and thus ease loads on the bridging resulting from the self weight of the purlins and girts, cladding and construction loads. However, in wall and steep roof applications where reduced cladding rigidity is installed (clip fixed claddings, shallow walling profiles, translucent cladding, battens, packers and the like), there needs to be some additional attention given to minimise this load on the bridging resulting from self weight. This can be achieved by a number of ways:

- fixing the high end of each sheet of the clip fixed cladding to a stiff member;
- supporting each sheet of the cladding from the bottom;

Otherwise the bridging will need to be designed to carry these self weight loads from the wall system.

## IN SERVICES

These loads occur once the cladding is fixed to the outside flange. In this stage the bridging needs to be designed to carry the induced loads from:

- restraining the purlins in the correct alignment from the self weight of the roof system (purlins, cladding, insulation, services, etc.), foot traffic resulting from construction/maintenance loads, and wind loads;
- restraining the girts in the correct alignment from the wind loads only - for screw fixed cladding;
- restraining the girts in the correct alignment from the combination of wind loads and self weight of the wall system (girts, cladding, insulation, services, etc.) - for clip fixed cladding where no alternative means has been used to carry these loads (see above).

## AVAILABLE BRIDGING SYSTEMS

There are two types of proprietary bridging systems that are to be considered for use with LYSAGHT® purlins and girts:

- the LYSAGHT HOOK-LOK® II bridging system
- Series 300 & 350 bridging system.

The selection of which system to be used is dependent upon the purlin size required (refer to Section 2 of this Manual).

These two types of bridging systems are adequate to carry the various loads induced during construction and in in-service. Use of bridging systems other than that specified could render the calculated purlin capacity inappropriate.

## TIE-BACKS

Tie-backs (usually a threaded rod or turnbuckle) may be used in conjunction with the LYSAGHT® bridging system to limit the accumulation of loads imposed on the bridging members. The loads that need to be limited could result from “out-of-plane” movement during construction such as the accumulated sag of a number of rows of girts; similarly in steep roofs, change of pitch roofs and curved roofs.

For walls the bridging design must consider the “out-of-plane” loads generated by the dead weight of the girts.

For a wall design where a clip fixed cladding is to be used, the designer needs to consider the cumulative dead load from the girts and cladding, as well as the cumulative compression or tension force from the wind pressures. For this reason clip fixed claddings are rarely used as wall cladding unless special details are included to ensure the cladding is supported in some fashion, such as fixed off to a stiff member. (See Design stages for bridging)

Thus consideration may need to be given as to the possible inclusion of special designed bridging or the inclusion of tie-backs at regular intervals. Tie-backs are anchored to a structural member suitably sized to carry the loads.

From industry experience tie-backs at intervals of 10m have been successfully used. As a guide the following tie-back spacings could be considered.

## TIE-BACK SPACING GUIDE

Girt Size	Girt Spacing	
	2.5m	1.25m
15012	30m	30m
15024	30m	15m
20015	30m	15m
20024	20m	10m
25015	20m	10m
25024	15m	

Notes to guide:

1. Wall girt situations. For steep roof situations the spacings can be increased.
2. The bridging spacing guide of 20D as a maximum has been used.
3. No allowance has been made for additional live load resulting from construction access by workers.
4. The spacings are based on the self weight sag of the girts.
5. For lighter and smaller girt sections the spacings are well in excess of 30m.
6. Does not include cladding weight.
7. Assumes the bridging is continuous and secured at top and bottom of run.

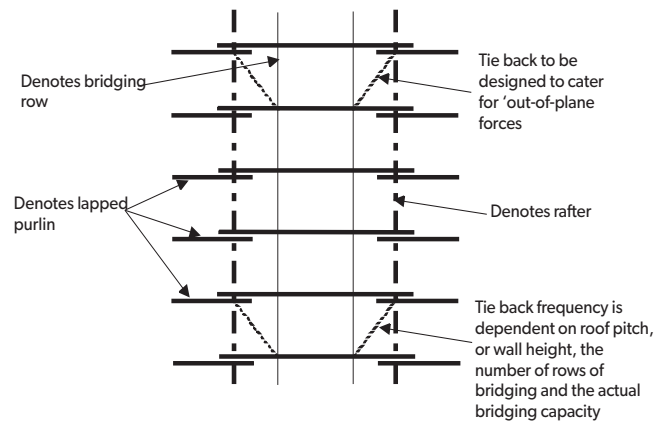
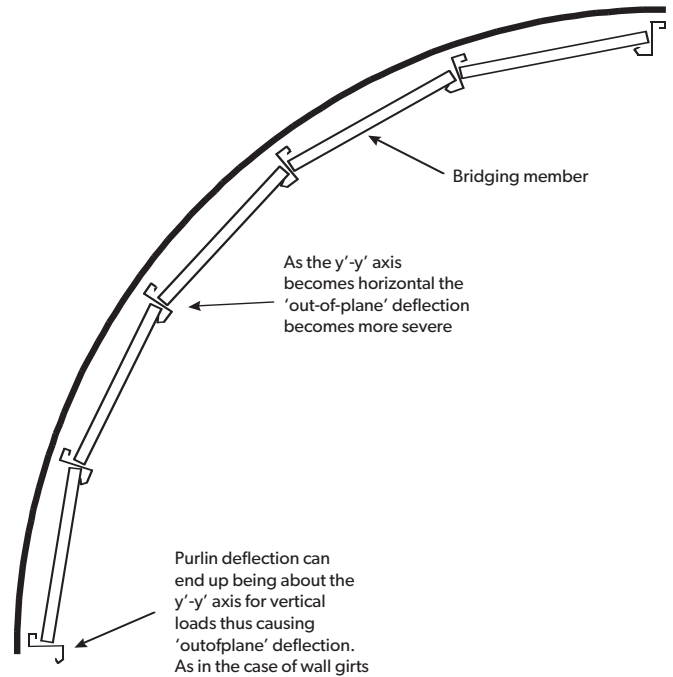

## CURVED ROOFS BRIDGING DETAILS

When a curved roof is to be constructed careful consideration must be given to the selection of the bridging system. The LYSAGHT HOOK-LOK® II can be used to follow the curved roof. For curved roofs it is easier to use bolted bracket ends.

One method is for the HOOK-LOK® II bracket ends to be bolted to the bridging channel. These brackets must not be pre-fixed (with clinches) to the bridging channel, but must be with a loose bolt connection to allow site installation to the required angle. It is important to ensure that the bridging ends are locked or secured off properly when installed so as to provide the required lateral and rotational restraint.

Alternatively the standard bridging assembly with bolted brackets pre-fixed (with clinches) to the channel may be used and the required angle between adjacent purlins can be achieved by the use of spacers/packers placed between the bridging bracket and the web of the purlin. These spacers/packers may be washers of a suitable thickness.

A third alternative is to have special bridging brackets fabricated to suit the roof curvature.

As an alternative to the solid bridging system the use of threaded rods used in a 'herringbone' pattern has been used successfully in some projects. This method will require the purlin profiles to be punched with two sets of holes (total of four holes) at each bridging location rather than the normal of one set of two holes.

Lysaght do not have any recommendations on the design of such a system.

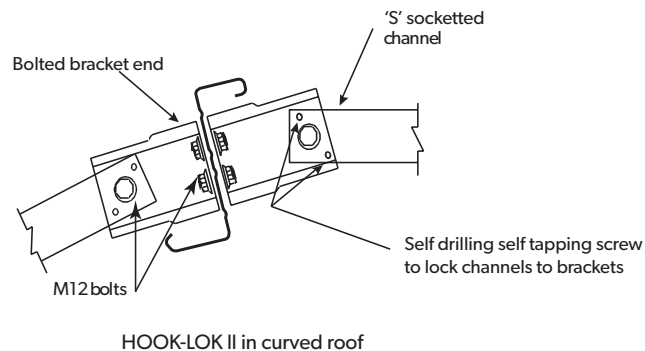
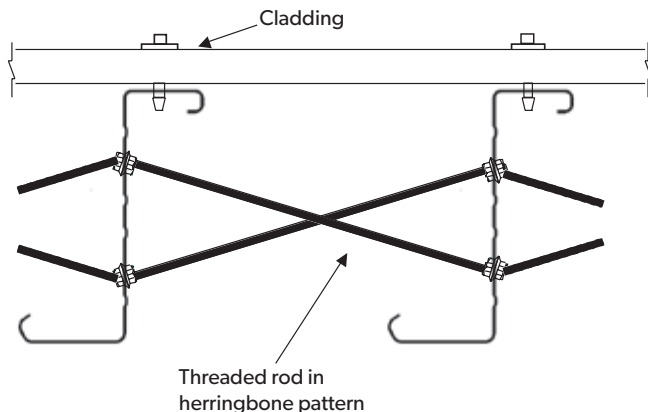

### HOOK-LOK II in curved roof using spacers

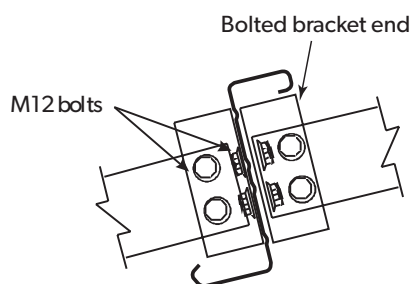
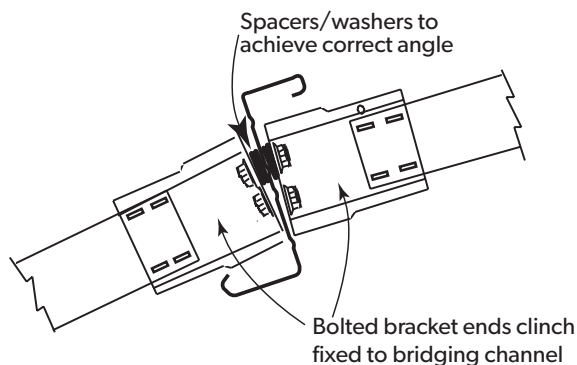

Special bridging fabricated to match the curvature of the roof

## BRIDGING OF "OPPOSITE HAND" PURLINS

The accepted industry practice is to have all the purlins and girts facing in the same direction. However it is possible to minimise the amount of bridging required by using the purlins to counter each others "out-of-plane" movements. This is possible as one section rotates it is counteracted by the other section wanting to rotate in the opposite direction.

It should also be noted that the bridging will need to be with bolted end brackets.

The designer should be aware that there may be construction and aesthetic issues that would need to be addressed. Some issues to consider are:

- on-site handling and installation - every second purlin is opposite hand and thus some purlin bundles will need to be rotated when lifted onto the roof;
- lines of cladding fasteners will not be evenly spaced;
- pairs of "opposite hand" purlins will need to be tied together during construction to prevent the pairs from moving laterally when loaded;
- detailing of hole locations (at laps and non-symmetric bridging locations such as end spans) needs careful attention to allow for the rotation of purlins.

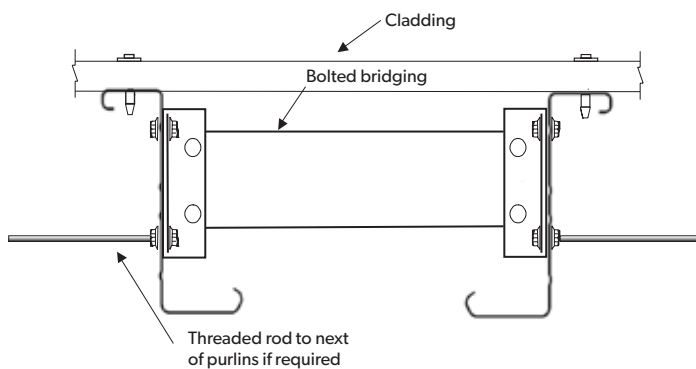

## FASCIA PURLIN

In certain configurations of wall design, the loads imposed on the fascia purlin by the girt hanger may be large. This demands an increase in the fascia purlin capacity to prevent excessive twisting and may result in a structural member being required.

## 5.4 OTHER DESIGN MATTERS

### SUSPENSION OF SERVICES

We recommend that all hanging loads are adequately detailed at the design stage.

Where the loads are heavy then it is strongly recommended that these hanging loads are attached only to the web of the purlin. There are brackets available from manufacturers which can be screw fixed into the web of the purlin. Lysaght can also pre-punch web holes for bolted connections. Consideration should be given to the value of this hanging load so that there is adequate purlin capacity to carry the high concentrated load and also a check on the bearing capacity of the material. Consideration, with regard to reduced purlin capacity, should also be given to the size, quantity and location of additional holes in the web (refer to Holing of Webs).

For lighter loads it is recommended that the load is attached to the web of the purlin, however where this is not practical then attachment in the bottom flange as close as practical to the web may be suitable.

We recommend that hanging loads from the lips be avoided. If such loading cannot be avoided then these loads should be minimised (value and quantity) and preferably provided with detailing to minimise the possibility of profile or flange rotation.

In the building industry it is common practice to attach hanging loads from the lip of the bottom flange of a purlin using clips. This practice is normally for lightly hanging loads such as the small fire service piping, light suspended ceilings, electrical cabling, lighting, etc.

We do not have any knowledge of any problems due to such method of attachment for light loads, however any loading on the purlin lip edge would have to be only light. The value of this light load will vary depending upon numerous factors such as purlin profile (Cee or Zed), purlin orientation, purlin dimensions (thickness, depth, width), slenderness ratio of dimensions, span, span configuration, number of bridging, proximity of load to bridging and supports, roof slope, purlin service loads, cladding stiffness, etc.

Lysaght do not have any recommendations as to an acceptable limit to these loads. There are some recommendations for such limits from some overseas manufacturers for their purlin profiles. This information should be treated with care since these overseas profiles, materials, and construction details used for the profiles differ to those in Australia.

This practice of hanging from the lips induces twist into the purlins, which in turn can reduce the purlin performance below the published design values. However where the purlin has been provided with sufficient rotational restraint then there would be minimal concerns with light loads.

Rotational restraint needs to be provided for the purlin profile and of the lower flange of the purlin. The roof cladding and the bridging provide rotational restraint of the purlin profile. The greater the restraint (such as a number of rows of bridging per span) the less likelihood of rotation.

Rotational restraint to the lower flange is achieved by various means. One approach is by providing stiffened elements to the underside of the lower flange. These stiffened elements (angle, channel, uni-strut, etc.) would need to be conventionally and securely attached to the bottom flange (using screws or bolts) of at least two adjacent purlins and also extend past the flanges. These stiffeners would need to be regularly spaced along the length of the purlins depending upon the actual load to be hung off the lips and the stiffness of the purlin. It is recommended that the hanging load be located at this stiffener or as close as possible to the stiffener.

Other approaches for providing restraint to the lower flange are:

- Installation of web/flange stiffener bracket
- Installation of web/lip strap
- "herring-bone" strapping

For existing projects where loading on the lips has been constructed and an estimate of the problem needs to be made then a visual inspection is usually sufficient to determine if any rotation has occurred. This rotation could be of the flange in relation to the web of the purlin, or it could be an overall rotation of the purlin. For light loads it is likely that such rotation would be negligible. The visual inspection would be by viewing along the length of the purlin to observe undulations of the lip edge and twist along the length of the purlin, and also of checking the squareness of the flange/web angle. This inspection should be compared with other local unloaded purlins to determine the severity of rotations.

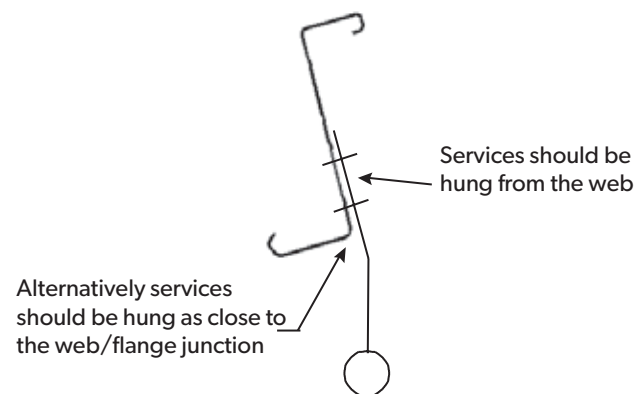

## HOLING OF WEBS

Holing of the webs of purlins and girts is standard practice and is necessary for connection to cleats, connection at end of laps and for the installation of bridging. The holes for these applications are kept to a minimum and located specifically in the areas required. These holes are at locations of added restraint via bridging, cleats or thicker section capacity (lapped sections). Where these holes are bolted the flanged bolts provide suitable load re-distribution. Holing at these locations has negligible effect on the capacity of the profile.

In situations where additional holing (additional and more regular than the above standard requirements) is considered then it may result in some reduction to the capacity of the profile. The actual reduction will be dependent on a number of factors such as hole size, location of hole in the web, number of holes, location along the length of the purlin, restraint provide, inclusion of re-distribution of load, etc. To minimize the reduction in capacity the following guides are offered:

- Restrict hole sizes. Do not exceed the size used for standard holes.
- No more than two holes per set and located at the gauge lines - as for normal hole punching details.
- Each set of holes to be spaced apart at a distance greater than the profile depth "D".
- Locate the holes away from areas of high stresses resulting from bending, shear and combined bending & shear.
- Provide added restraint and a path for re-distribution of loads.

It is not possible to give an exact answer as to the value of capacity reduction, however with the above guides it is likely that there will be minimal reductions. In situations where considerable holing is detailed, and the above guides are complied with, it would be prudent to allow some reduction in capacity. As a conservative "rule of thumb" the reduction in capacity up to 10% or 15% should be considered. Purlins that are detailed with holing outside the above guides should be appropriately designed by an engineer experienced in "cold-formed thin walled structures".

Additional holing may be required for:

- Hanging loads
- Ventilation
- Services in the plane of the purlins
- Site flexibility for cleat connections, bridging location and hanging loads

## REDUCED/LOW CLADDING RESTRAINT

The design capacity of the purlin is dependant upon the top flange being provided with adequate lateral restraint commonly provided by the cladding. In certain projects the cladding restraint may be reduced and thus there is potential of the purlin capacity being reduced.

Situations where this may occur are:

- Shallow cladding profiles or weak cladding design – some wall profiles are quite weak and longer spans of cladding result in greater flexibility.
- Low restraint clip-fixed claddings.
- Cladding installed with deep, low rigidity thermal packers sandwiched between the purlin and the cladding. This often results in increased fastener lengths.
- Claddings with elongated holes to allow for thermal movement, e.g. polycarbonate and fibreglass.
- Thick &/or high density insulation blanket and insulation boards that result in increased fastener lengths.
- Fabric – such as sails and shade screens in-lieu of traditional cladding.
- Cladding not fixed directly to the purlin flange – cross battens fixed to the purlin flange at large spacings, with the cladding fixed to the battens.

For such situations the designer must determine if there is a need for providing additional purlin capacity to compensate. This additional capacity may be achieved in various ways such as additional bridging, increased purlin thickness, reduced purlin spans, reduced purlin spacing or increased lap length.

With regard to thermal packers some issues that the designer may need to consider are:

- Packer depth – should be minimised.
- Packer material stiffness and long term durability - should be maximised.
- Cladding fasteners – length of the fastener may need to be increased and thus the availability of suitably longer fasteners will need to be considered.
- Bridging details – tie-backs to rigid supports at regular intervals may need to be considered, or more rigid bridging may be required.

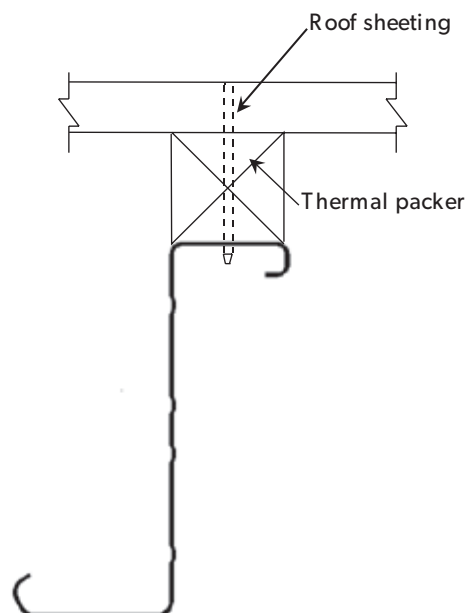

## FLY BRACING

Where fly bracing is detailed by the designer it is recommended that the fly bracing is attached to the web of the purlin at the ends of laps. If the design lap length is short of where the fly brace connection is to be located, then this lap should be extended.

Connection of the fly brace to the purlin should be through the free bolt hole in the lower portion of the web. The standard bolting requirements at the ends of purlin laps, as detailed elsewhere, should not be compromised.

The fly brace loads should be minimised since the purlin capacity tables do not take account of such additional loading. For situations where fly bracing is required the designer must determine if there is a need for providing additional purlin capacity to compensate for the additional loads imposed by the fly bracing.

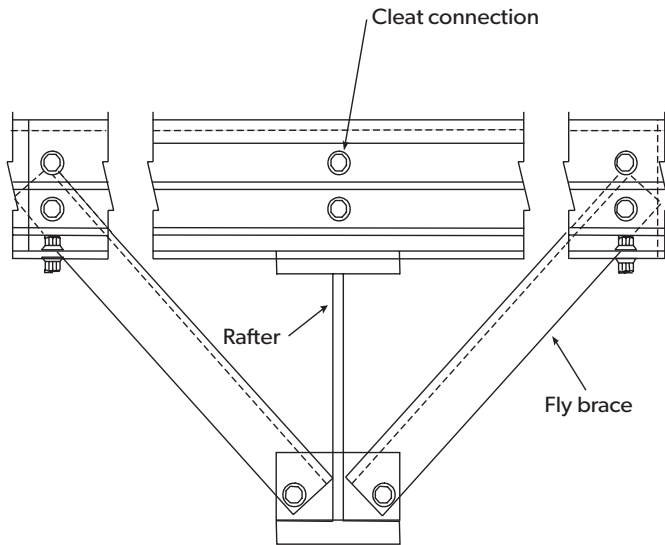

## MINIMUM ROOF SLOPE

Reference should be made to the LYSAGHT® Roofing and Walling Manual regarding the shallow roof slope. Although shallow roof slope may be desired there may be practical limitations to consider, ensuring that a suitable roof slope is achieved to allow adequate roof drainage.

With regard to shallow roof slopes particular consideration should be given to the purlins and structural frame design/selection with regard to the manufacturing tolerances, construction tolerance, deflection differences between purlin thickness/profile/spans/configurations (particularly under load; local load variations such as roof-top mounted equipment). As an example the eave purlin design (or construction process) results in a rigid and level support, whereas the adjacent purlin deflects due to greater flexibility resulting in a local roofing depression.

## FLANGE FIXING

The purlin capacity tables have been generated based on the sections being fastened through the web (cleat connections).

Fixing of purlins through the bottom flange of the purlin (cleat-less connections) is used in some forms of construction. The purlin capacity tables should not be used for these types of connections.

For these type of connections there are other design issues that need to be considered (both from a strength and serviceability perspective). There are also construction matters that need to be considered.

Contact your local Lysaght Service Centre to get more information.

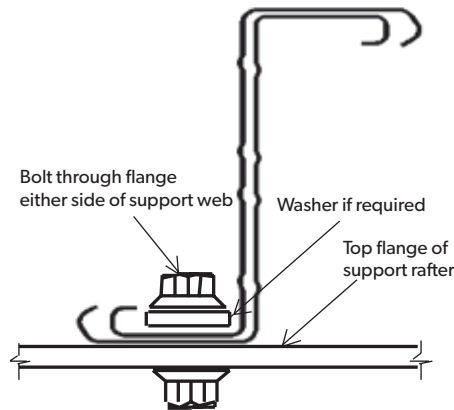

## CORROSION PROTECTION & MATERIAL COMPATIBILITY

Some building materials and environmental conditions can be detrimental to coated steel products. These include contact with or exposure to runoff from:

- industrial, agricultural, marine or other aggressive atmospheric conditions;
- incompatible metals, like lead or copper;
- building materials subject to cycles of dryness and wetness, or which have excessive moisture content such as improperly seasoned timber;
- materials which have been treated with preservatives, like CCA or tanalith-treated timber.

A zinc coating of Z350 (350 g/m<sup>2</sup> minimum coating mass) is the standard coating class provided with LYSAGHT SUPAPURLIN® sections. This will provide a long and trouble-free life for enclosed buildings and open-sided rural buildings, in a non-aggressive environment.

A non-aggressive environment is 1000 m from rough surf, 750 m from industrial emission and fossil fuel combustion, and 300 m from calm salt waters. Consideration must be given to the nature of activities performed within the building.

For more severe corrosive environments a Z450 (450 g/m<sup>2</sup> minimum coating mass) will be required. This heavier coating mass will be available in special circumstances and is subject to a minimum order quantity and extended lead times.

Direct contact of incompatible materials with the coating must be avoided. In such applications, and in very corrosive environments, suitable paint systems may be obtained from paint manufacturers.

In applications where particular attention is required for corrosion, or the build up of substances like dust or grain, then consideration should be given to the shape of the sections, orientation of the sections, and coating class.

Further information is available from your nearest Lysaght Service Centre.

# SECTION 6

## 6.0 Engineering Data on Purlin & Girt Profiles

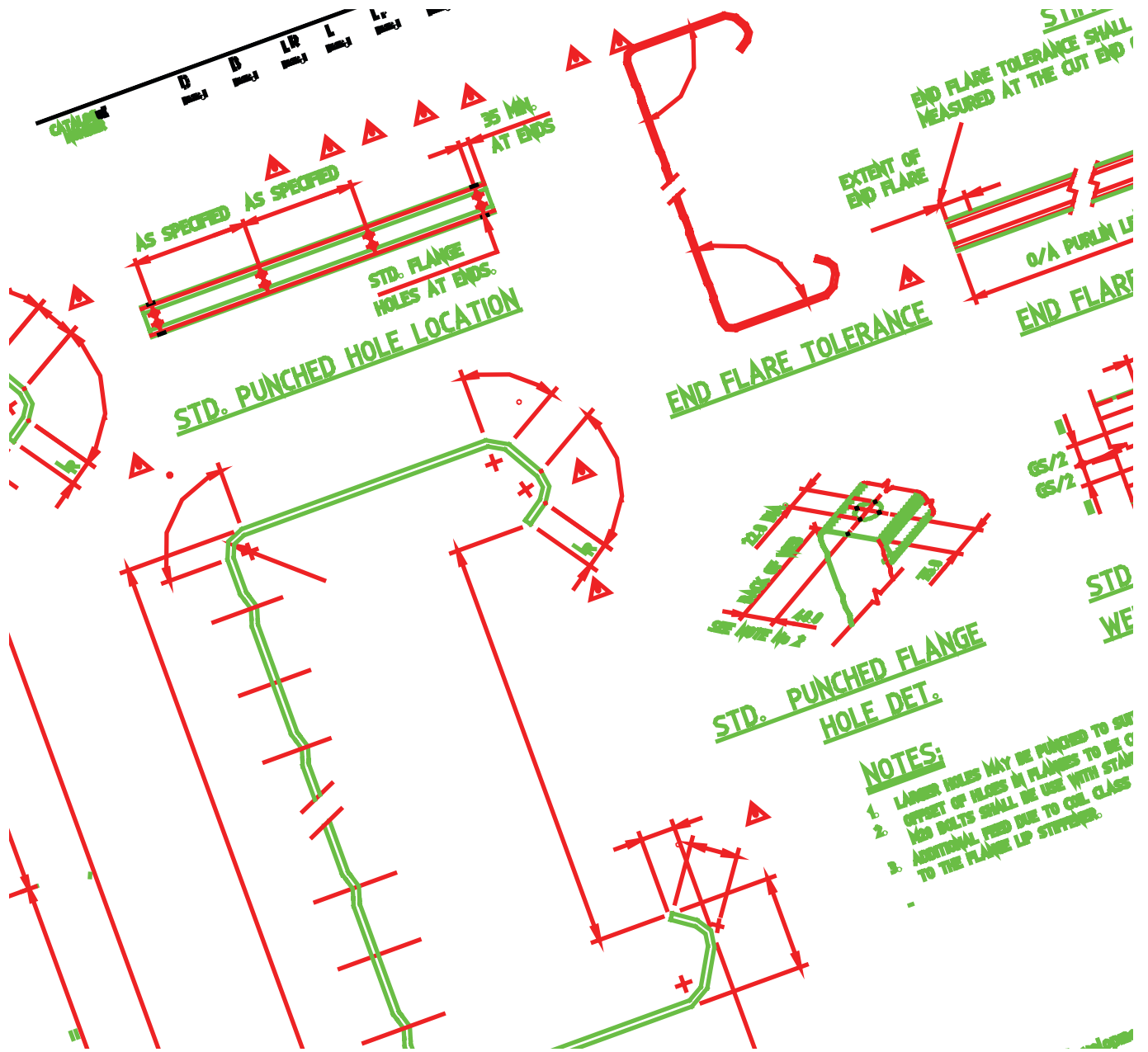

**NOTES:**

1. LARGER HOLES MAY BE PUNCHED TO SUIT
2. OFFSET OF HOLES IN FLANGES TO BE C
3. WED BOLTS SHALL BE USE WITH STIFF
4. ADDITIONAL FEED DUE TO COIL CLASS
5. TO THE FLANGE LIP STIFFENERS.



## 6.1 DESIGN PRINCIPLES

In the design of “thin walled” sections and members it is necessary to consider a variety of possible strength modes. Some form of buckling will govern many of these strength modes. Consequently it is not always possible to use the section properties as a guide to the capacity of the section or member.

There are various buckle modes that can result in reduced capacities and thus it is important to check for each of these buckle modes to determine the governing mode. The various buckle modes that need to be considered with regard to purlin design that could govern the capacity of a purlin section or member are;

- Flexural Torsional Buckling - the whole member buckles laterally between points of restraint (cleats and/or bridging points). In these situations it is possible to increase the capacity by increasing the number of restraints or decrease the distance between restraints, e.g. provide added bridging, reduce spans.
- Local Buckling - where there is a small buckle in the flange and/or web of the purlin, which effectively reduces the amount of steel that can be used to carry load, and thus reduction in the section capacity. The size of buckle, and consequently the value of reduction, will depend upon the stress in the flange and/or web at that load, i.e. the higher the stress the more the buckle and thus greater reduction in the effective steel. In this situation it is not possible to provide any restraint to increase the capacity. Often an indication of this reduction can be given by providing the “effective section properties”. For SUPAPURLINS® the slight reduction in the flat of the flange and the added web stiffeners result in this capacity being increased.
- Distortional Buckle - where the lip of the purlin buckles which dramatically reduces the section capacity. In this situation it is not possible to provide any restraint to increase the capacity. This form of buckle is often, but not always, the limiting strength mode. For SUPAPURLINS® the increased lip stiffeners result in this capacity being increased.
- Web Shear & Bending - where there is a small buckle in the web of the purlin resulting from combined stresses, and usually occurs at or near the supports of single thickness purlins (purlins continuous over supports or at end of laps). This is similar to local buckling. For SUPAPURLINS® the added web stiffeners result in this capacity being increased.

Consequently using the “full section property” or the ‘effective section property’ of any profile should be used with caution. Using these values does not necessarily give the correct capacity of the section or member.

Adjacent are some diagrams to illustrate these concepts.

**Flexural-torsional buckle  
(Lateral buckle)**

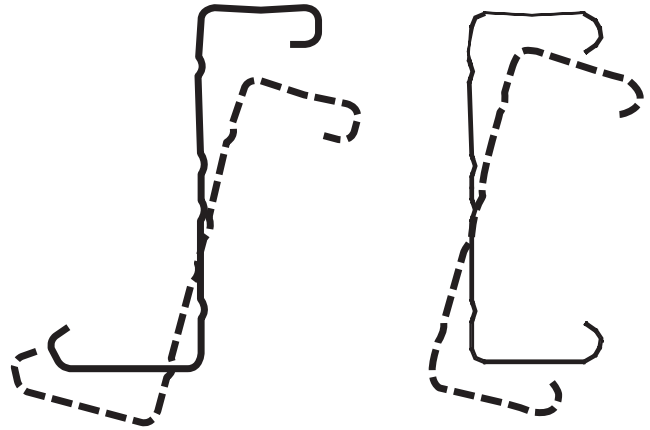

**Local buckle**

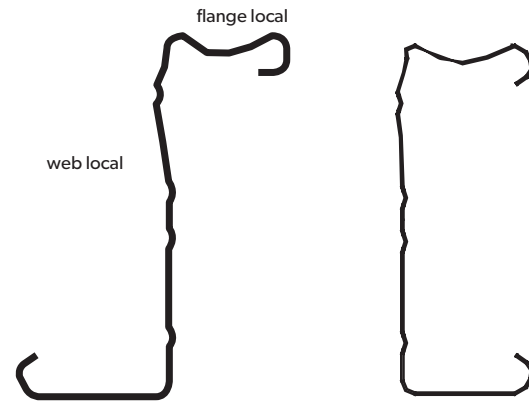

**Flange distortional buckle**

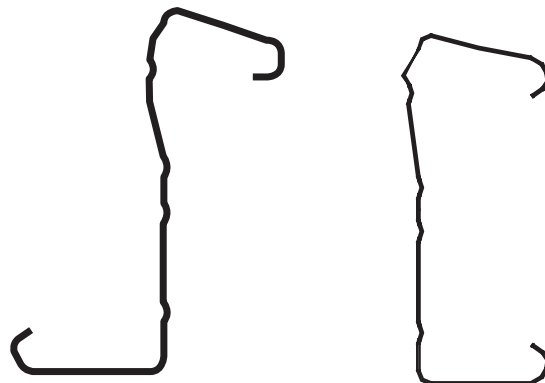

## 6.2 TRADITIONAL ZEDS & CEES

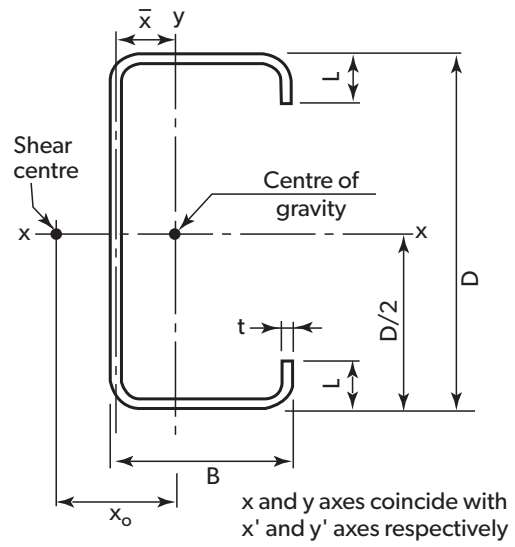
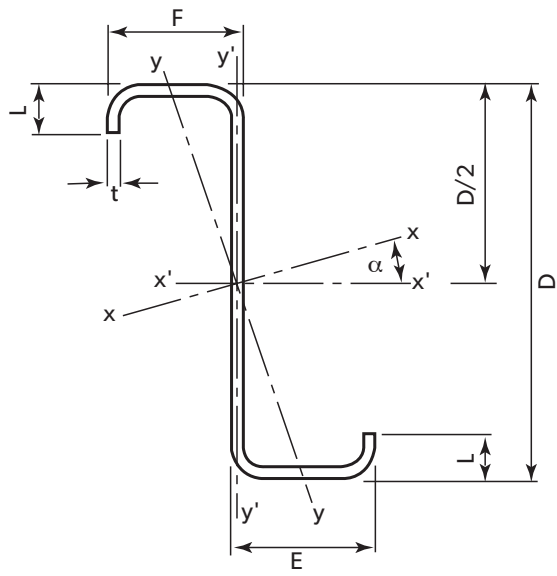

Product Code	t mm	D mm	Zeds Dimensions			Cees Dimensions		Mass per unit length kg/m
			E mm	F mm	L mm	B mm	L mm	
Z/C10010	1.0	102	53	49	13	51	13	1.77
Z/C10012	1.2	102	53	49	13	51	13	2.10
Z/C10015	1.5	102	53	49	14	51	14	2.61
Z/C10019	1.9	1.2	53	49	15	51	15	3.29

Note: Dimensions have been rounded off to the nearest 1.0mm. Refer to traditional Zeds & Cees Manual for more information.

### 6.3 LYSAGHT SUPAZEDS® & SUPACEES®

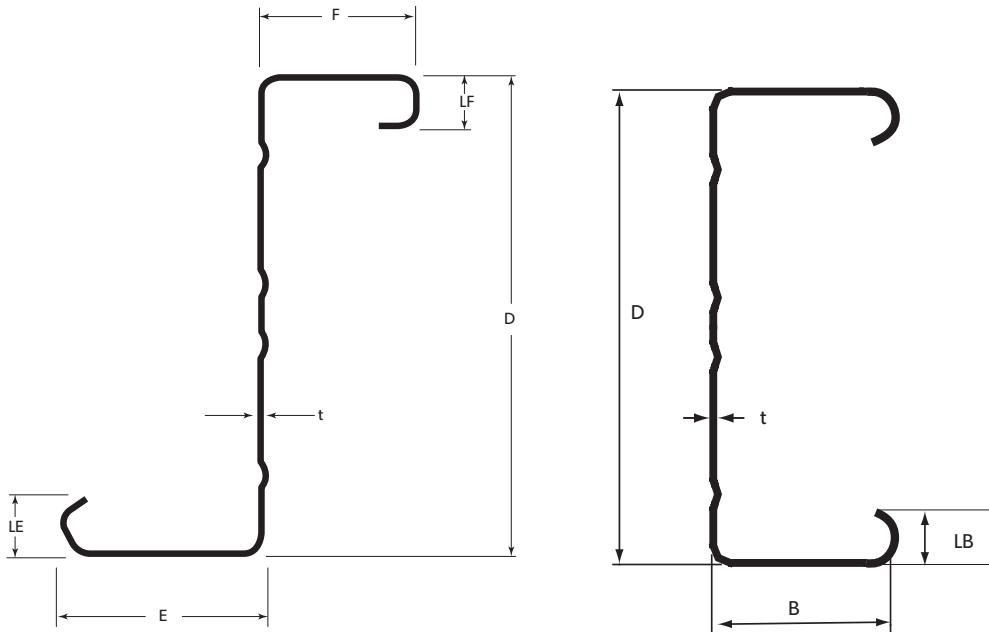

Product Code	t mm	D mm	SUPAZEDS® Dimensions				Product Code	SUPACEES® Dimensions		Mass per unit length kg/m
			E mm	LE mm	F mm	LF mm		B mm	LB mm	
SZ15010	1.0	152	63	17	48	16	SC15010	57.5	17.5	2.38
SZ15012	1.2	152	66	18.5	49	16.5	SC15012	60.5	18	2.89
SZ15015	1.5	152	66.5	18.5	49.5	17	SC15015	61	18.5	3.58
SZ15019	1.9	152	67.5	19	50.5	18	SC15019	62	19	4.51
SZ15024	2.4	152	70	20	52	19	SC15024	63	20	5.67
SZ20012	1.2	203	76	19.5	62	19.5	SC20012	70	21	3.62
SZ20015	1.5	203	77	20	63	20	SC20015	70.5	21.5	4.49
SZ20019	1.9	203	79.5	21.5	63.5	21	SC20019	73	23	5.73
SZ20024	2.4	203	81.5	22	65	22	SC20024	74.5	24	7.20
SZ25015	1.5	254	78.5	19.5	67	20	SC25015	72	22.5	5.16
SZ25019	1.9	254	78.5	21	65	21	SC25019	72.5	23	6.50
SZ25024	2.4	254	80.5	22	66	22	SC25024	74	24	8.16
SZ30019	1.9	300	103.5	25	88	26	SC30019	97.5	27.5	8.02
SZ30024	2.4	300	104.5	26.5	87.5	27	SC30024	99	28.5	10.09
SZ30030	3.0	300	106.5	28	88	28	SC30030	100.5	29.5	12.56
SZ35024	2.4	350	131.5	28.5	114	31	SC35024	124	33.5	12.20
SZ35030	3.0	350	134	30	115	31	SC35030	125.5	34.5	15.19
SZ40024	2.4	400	131.5	28.5	114	31	SC40024	124	33.5	13.16
SZ40030	3.0	400	134	30	115	31	SC40030	125.5	34.5	16.39
SZ40032	3.2	400	134.5	30.5	115.5	31	SC40032	126.5	34.5	17.46

Note: Dimensions have been rounded off to the nearest 0.5mm.

**SUPAZED® PROFILE - SECTION PROPERTIES**

Product Code	Area mm <sup>2</sup> (Gross area)	Full Section Properties										Effective Section Properties at yield stress					
		Principal Axes					Axes perpendicular and parallel to web					Section Modulus Z <sub>y</sub> <sup>1</sup> 10 <sup>3</sup> mm <sup>3</sup> (Bending)	Section Area A <sub>e</sub> mm <sup>2</sup> (Compression)				
		I <sub>x</sub> 10 <sup>6</sup> mm <sup>4</sup>	I <sub>y</sub> 10 <sup>6</sup> mm <sup>4</sup>	Slope α degree	I <sub>x</sub> <sup>1</sup> 10 <sup>6</sup> mm <sup>4</sup>	I <sub>y</sub> <sup>1</sup> 10 <sup>6</sup> mm <sup>4</sup>	I <sub>x</sub> <sup>1,1</sup> 10 <sup>6</sup> mm <sup>4</sup>	I <sub>y</sub> <sup>1,1</sup> 10 <sup>6</sup> mm <sup>4</sup>	Z <sub>x</sub> <sup>1</sup> 10 <sup>3</sup> mm <sup>3</sup>	Z <sub>y</sub> <sup>1</sup> 10 <sup>3</sup> mm <sup>3</sup>	Warping Constant I <sub>w</sub> 10 <sup>6</sup> mm <sup>6</sup> (column property)			Torsion Constant J mm <sup>4</sup> (column property)	Radius of Gyration r <sub>x</sub> <sup>1</sup> mm	r <sub>y</sub> <sup>1</sup> mm	β <sub>x</sub> mm
SZ-15010	290	1.14	0.081	-19.9	1.02	0.204	0.339	13.5	3.73	59.2	26.5	94.2	771	44.4	-42.6	10.6	173
SZ-15012	354	1.41	0.108	-21.0	1.24	0.275	0.436	16.6	4.86	59.3	27.9	165	1003	52.8	-49.6	14.5	229
SZ-15015	442	1.76	0.134	-21.1	1.55	0.345	0.547	20.7	6.11	59.2	27.9	321	1262	51.1	-48.9	19.2	318
SZ-15019	560	2.24	0.174	-21.5	1.96	0.452	0.706	26.3	7.84	59.2	28.4	648	1653	47.7	-47.4	24.9	438
SZ-15024	708	2.84	0.230	-22.2	2.47	0.602	0.914	33.3	10.2	59.1	29.2	1294	2154	50.1	-50.3	32.4	608
SZ-20012	444	3.02	0.188	-17.6	2.76	0.447	0.816	27.4	6.57	78.8	31.7	209	3173	40.3	-37.5	20.8	245
SZ-20015	555	3.78	0.239	-17.9	3.44	0.572	1.03	34.3	8.30	78.8	32.1	406	4037	39.6	-37.6	28.9	332
SZ-20019	712	4.89	0.323	-18.6	4.42	0.788	1.38	44.2	11.2	78.8	33.3	831	5477	46.1	-43.2	39.9	466
SZ-20024	900	6.19	0.422	-19.0	5.58	1.04	1.78	56.0	14.5	78.7	33.9	1662	7123	46.5	-44.4	52.3	658
SZ-25015	637	6.30	0.286	-13.6	5.97	0.621	1.38	47.4	8.7	96.8	31.2	468	7203	36.2	-32.4	35.7	328
SZ-25019	807	7.94	0.359	-13.7	7.52	0.782	1.74	60.0	11.1	96.5	31.1	947	8978	48.3	-41.5	51.5	462
SZ-25024	1020	10.0	0.467	-14.0	9.49	1.03	2.24	76.0	14.3	96.5	31.7	1892	11652	51.9	-44.7	71.4	664
SZ-30019	997	14.4	0.786	-15.7	13.4	1.78	3.55	90.1	18.9	116	42.3	1174	28377	39.6	-36.1	68.6	524
SZ-30024	1260	18.1	1.00	-15.9	16.8	2.28	4.51	113.8	24.2	116	42.6	2353	36024	47.9	-42.8	97.6	728
SZ-30030	1575	22.7	1.28	-16.1	21.0	2.93	5.70	142.3	30.8	115	43.1	4568	45769	52.1	-46.7	130.1	1019
SZ-35024	1524	31.2	1.95	-17.6	28.5	4.62	8.42	164.5	38.1	137	55.1	2860	98112	33.6	-35.2	121	783
SZ-35030	1905	39.0	2.49	-17.9	35.6	5.92	10.7	205.9	48.3	137	55.7	5557	124274	43.7	-42.7	169	1067
SZ-40024	1644	41.5	2.09	-14.7	38.9	4.62	9.68	197.0	38.2	154	53.0	3088	131751	39.6	-38.3	138	786
SZ-40030	2055	51.9	2.66	-14.9	48.7	5.93	12.3	246.5	48.4	154	53.7	6005	167037	51.1	-46.6	192	1073
SZ-40032	2192	55.4	2.86	-14.9	51.9	6.37	13.1	263.1	51.8	154	53.9	7282	179051	52.9	-47.7	212.4	1179

NOTE: Section properties published in this table are for reference only. Refer to SUPAPURLIN® software for actual values.

**SUPACEE® PROFILE - SECTION PROPERTIES**

Product Code	Full Section Properties										Effective Section Properties at yield stress			
	Area mm <sup>2</sup> (Gross area)	Second Moment of Area I <sub>x</sub> 10 <sup>6</sup> mm <sup>4</sup> I <sub>y</sub> 10 <sup>6</sup> mm <sup>4</sup>	Section Modulus Z <sub>x</sub> 10 <sup>3</sup> mm <sup>3</sup> Z <sub>y</sub> 10 <sup>3</sup> mm <sup>3</sup>	Radius of Gyration r <sub>x</sub> mm r <sub>y</sub> mm	Centroid x	Shear Centre x <sub>0</sub>	Torsion Constant J mm <sup>4</sup> (Column property)	Warping Constant I <sub>w</sub> 10 <sup>6</sup> mm <sup>6</sup> (Column property)	Monosymmetry Constant β <sub>y</sub> mm	Section Modulus Z <sub>xe</sub> 10 <sup>3</sup> mm <sup>3</sup> (Bending)	Area mm <sup>2</sup> (Compression)			
SC-15010	290	1.02 0.128	13.5 3.19	59.4 21.0	16.8	43.0	94.8	631	163	10.7	174.3			
SC-15012	354	1.26 0.172	16.7 4.11	59.6 22.0	17.9	45.5	166	847	165	14.9	235.0			
SC-15015	442	1.57 0.219	20.9 5.19	59.6 22.2	18.1	46.1	322	1080	165	19.3	316.5			
SC-15019	560	1.98 0.284	26.5 6.68	59.5 22.5	18.5	46.9	649	1405	165	25.4	442.6			
SC-15024	708	2.49 0.368	33.4 8.57	59.3 22.8	18.9	47.8	1298	1827	165	33.5	628.1			
SC-20012	444	2.75 0.282	27.3 5.65	78.7 25.2	19.2	50.0	209	2435	214	21.0	247.8			
SC-20015	555	3.43 0.358	34.1 7.12	78.7 25.4	19.4	50.5	406	3092	214	31.2	357.5			
SC-20019	712	4.42 0.498	44.1 9.64	78.8 26.4	20.6	53.3	832	4346	214	41.9	494.3			
SC-20024	900	5.57 0.643	55.7 12.3	78.7 26.7	20.9	54.1	1666	5618	213	54.9	698.3			
SC-25015	637	5.93 0.406	47.1 7.61	96.5 25.2	17.7	47.4	468	5310	270	39.2	361.6			
SC-25019	807	7.51 0.526	59.8 9.77	96.4 25.5	18.0	48.1	946	6878	269	55.6	497.3			
SC-25024	1020	9.47 0.680	75.6 12.5	96.3 25.8	18.3	48.9	1897	8889	267	74.9	708.2			
SC-30019	997	13.4 1.18	89.8 16.5	116 34.4	25.0	65.8	1175	21654	315	73.6	562.9			
SC-30024	1260	16.8 1.52	113.5 21.0	116 34.7	25.3	66.6	2356	27816	315	102.5	762.8			
SC-30030	1575	21.0 1.94	142.1 26.7	115 35.1	25.8	67.7	4574	35599	314	133.1	1048			
SC-35024	1524	28.3 2.96	163.5 32.9	136 44.1	33.0	85.9	2862	74051	370	134.6	871.7			
SC-35030	1905	35.4 3.76	204.5 41.6	136 44.4	33.4	87.0	5562	94231	370	182.7	1152			
SC-40024	1644	38.8 3.08	196.1 33.4	153.7 43.3	30.6	81.3	3090	98887	423	153.6	874.9			
SC-40030	2055	48.5 3.92	245.2 42.2	153.6 43.7	31.0	82.3	6012	125638	422	207.4	1159			
SC-40032	2192	51.7 4.23	261.8 45.2	153.6 43.9	31.2	82.8	7285	135150	422	226.5	1254			

NOTE: Section properties published in this table are for reference only. Refer to SUPAPURLIN® software for actual values.

# DISCOVER LYSAGHT SUPAPURLIN® DESIGN SOFTWARE

Lysaght are proud to announce the Design Software for SUPAZED® and SUPACEE® purlins and girts.

The software has been developed for Lysaght by Sydney University. Registration, security and commercial arrangements apply. The software incorporates the following features:

- User friendly, Microsoft Windows® based.
- Single screen input for design configuration (loads, spans, bridging, etc.).
- Diagrammatic configuration changes automatically based on input, to enable you to see your input exactly.
- Up to 12 spans.
- Option for inclusion of cantilever(s) - cantilevers are treated as a span, thus 10 spans and 2 cantilevers or 11 spans and 1 cantilever equate to 12 spans.
- Uniform loads, stepped loads, pattern loads, point loads, moments, axial loads can be input.
- Up to 8 load cases can be input.
- Selection of load position on purlin (top, middle, bottom).
- Variation for each span – length, bridging quantity (max 3 per span), bridging location.
- Selection of lap by percentage or by length (mm).
- Selection of different lap at each support.
- Selection from the standard range of purlins (C/Z100s, SC/SZ150s to SC/SZ400s)
- Selection of different section thickness for each span.
- Option of nested Zed purlins in both end spans.
- Selection of cleat connection or flange fixed for the input configuration.
- Selection of bolt size (M12, M16), grade (4.6, 8.8) and quantity (1 to 5) for the input configuration.
- Variation of cladding restraint.
- Detailed design report output file that can be edited.
- File saving options.
- Compliant to the latest AS4600 code.

**To access download of the Design Software, go to:  
<http://www.lysaght.com/supapurlinsoftware>**



## PRODUCT DESCRIPTIONS

- All descriptions, specifications, illustrations, drawings, data, dimensions and weights contained in this catalogue, all technical literature and websites containing information from Lysaght are approximations only. They are intended by Lysaght to be a general description for information and identification purposes and do not create a sale by description. Lysaght reserves the right at any time to:

- (a) supply Goods with such minor modifications from its drawings and specifications as it sees fit; and
- (b) alter specifications shown in its promotional literature to reflect changes made after the date of such publication.

## DISCLAIMER, WARRANTIES AND LIMITATION OF LIABILITY

- This publication is intended to be an aid for all trades and professionals involved with specifying and installing Lysaght products and not to be a substitute for professional judgement.
- Terms and conditions of sale available at local Lysaght sales offices.
- Except to the extent to which liability may not lawfully be excluded or limited, BlueScope Steel Limited will not be under or incur any liability to you for any direct or indirect loss or damage (including, without limitation, consequential loss or damage such as loss of profit or anticipated profit, loss of use, damage to goodwill and loss due to delay) however caused (including, without limitation, breach of contract, negligence and/or breach of statute), which you may suffer or incur in connection with this publication.

© Copyright BlueScope Steel Limited 23 March 2017

**WWW.LYSAGHT.COM**

**Technical enquiries:**  
**steeldirect@bluescopesteel.com or call 1800 641 417**

LYSAGHT®, ZINCALUME®, SUPAPURLIN®, HOOK-LOK®, SUPAZED®, SUPACEE®, TOPSPAN® and BlueScope® are registered trademarks of BlueScope Steel Limited, ABN 16 000 011 058. The LYSAGHT® range of products is exclusively made by or for BlueScope Steel Limited trading as Lysaght.



LYT0056 23:03:17