

**Design of Electronic Control Unit (ECU)  
for Automobiles -  
Electronic Engine Management system**

**M. Tech. Project first stage report (EE 696)**

(Design Requirements, analysis and Proposed ideas  
for design of Electronic Engine Management ECU)

by

**Vineet P. Aras**

(Roll No. 03307411)

under the guidance of

**Prof. Kavi Arya**

**Prof. Dinesh Sharma**



Department of Electrical Engineering  
Indian Institute of Technology Bombay

July 2004

## **Acknowledgement**

I express my gratitude to my guides, Prof. Kavi Arya and Prof. Dinesh Sharma, for their invaluable help, guidance and motivation, which effectively contributed in successful completion of the first stage of this project. The regular meetings and discussions with Prof. Kavi Arya helped a lot in carrying out a focused work. They were instrumental in providing technical, moral and administrative support. It is a privilege to work under their guidance. I also thank other professors including Prof Shashikanth Suryanarayanan, for their cooperation extended.

## **Abstract**

This report presents a detailed explanation of the Design requirements of Electronic control Unit (ECU) for Engine Management. Due to the regulations demanding lower emissions, together with the need for better performance, fuel economy, continuous diagnosis, Electronic systems form an inevitable part of Engine management. A systems design approach has been used to break down the whole Engine management into three main categories, namely Electronic Charging, Alternator, and Engine starting system; Electronic Ignition system; Electronic Fuel system. Design requirements of each of these sections of engine management are explained thoroughly. The electronic starter is used to start the engine. Once started, appropriate air-fuel mixture quantity is injected into the cylinder through proper electronic control, which depend on various factors like engine speed, load, temperature, battery voltage, throttle position. Additionally, the electronic ignition system should provide the spark to ignite the air-fuel vapour with proper timing depending on speed, load, temperature etc. Moreover, the exhaust emissions should be kept at check and the fuel consumption should be minimum. Through out the report a designer's approach has been used by proposing self designed circuits, block diagrams and flowcharts, which would form the basis for design. Towards the end of the report, the actual design process of the ECU is started by designing the Input / Output circuit for Electronic Engine Management, which would be the basis for designing the actual electronic system in the next stages of this project.

# CONTENTS

<b>1 INTRODUCTION</b>	<b>6</b>
1.1 Electronic Systems Design approach.....	6
<b>2 ELECTRONIC CHARGING, ALTERNATOR AND ENGINE STARTING SYSTEM</b>	<b>9</b>
2.1 Battery.....	9
2.2 Electronic Charging circuit and system .....	9
2.3 Electronic Engine Starting circuit and system .....	11
<b>3 ELECTRONIC IGNITION SYSTEM'S DESIGN REQUIREMENTS</b>	<b>15</b>
3.1 Basic terms and types of Ignition systems .....	15
3.2 Proposed Block diagram and Design requirements of Electronically programmed and distributed ignition system.....	17
3.2.1 Ignition switch .....	18
3.2.2 Ignition or Spark generation - Inductive / Capacitor Discharge type.....	18
3.2.3 Electronic Voltage Regulator.....	19
3.2.4 Pulse Generator – Crankshaft / Hall effect / optical type.....	19
3.2.5 Pulse Shaping circuit.....	20
3.2.6 Electronic Dwell control - Constant / Open loop / Constant Energy closed loop type.....	20
3.2.7 Electronics Spark Advance (ESA) timing control- speed, load, temperature, knock, idle, phase, anti-jerk and warm-up conditions.....	22
3.2.8 Analog and Digital Electronics Hardware and Proposed Flow Chart.....	24
3.2.9 Driving and output Switching.....	26
3.2.10 Electronic Distribution - Distributorless / Direct Ignition type.....	26
3.2.11 Spark Plug and High Voltage cables.....	27
<b>4 ELECTRONIC FUEL SYSTEM'S DESIGN REQUIREMENTS</b>	<b>28</b>
4.1 Air-fuel mixture and Exhaust Emissions.....	28
4.2 Electronic fuel system's Design requirements.....	29
4.2.1 Main relay operation.....	30

4.2.2	Air mass flow measurement – Flap / Hot wire type.....	30
4.2.3	Engine speed measurement – Idle, Overrun and Overspeed conditions...	30
4.2.4	Temperature Measurements – Engine, Fuel (Hot start) and Air.....	31
4.2.5	Throttle position measurement – Idle, Accelerate, Decelerate and Full load conditions.....	32
4.2.6	Exhaust gas oxygen (EGO) measurement – Closed loop Lambda control and Catalytic converter .....	33
4.2.7	Battery Voltage correction.....	34
4.2.8	Idle or fast idle control – idle air control motor actuator.....	34
4.2.9	Exhaust gas recirculation (EGR).....	34
4.2.10	Fuel supply – tank, pump, pressure regulator and tank emissions.....	35
4.2.11	Fuel Injection – Simultaneous / Sequential / Gasoline Direct Injection (GDI).....	36
4.2.12	Calculation of basic Injection time - Air flow / Speed - density method..	40
4.2.13	Proposed Electronic Fuel Injection system Flow Chart .....	40
4.2.14	Other fuel injections – DMI / Diesel / alternative fuels.....	42

<b>5</b>	<b>ELECTRONIC ENGINE MANAGEMENT ECU WITH ON-BOARD DIAGNOSTICS - DESIGN PROCESS STARTED</b>	<b>43</b>
5.1	Proposed ‘Engine Management ECU’s’ Input / Output circuit diagram.....	43
5.2	On – Board Diagnostics (OBD).....	45
5.3	Designed and tested EGO Lambda Control ADC circuit module.....	46
<b>6</b>	<b>CONCLUSIONS AND WORK AHEAD.....</b>	<b>48</b>
	<b>REFERENCES.....</b>	<b>50</b>

# Chapter 1

## INTRODUCTION

Since the electronics explosion in the automotive field, electronic solutions have proven to be reliable over time and have enabled to solve problems otherwise unsolvable. The electronics in today's vehicles have made the transition from simple components to complex semiconductor chips, incorporating in the process the interfacing capability of analog electronics, and proven reliability and flexibility of digital electronics. The content and complexity of electronics for circuit design, processing, power control sensing, signal conditioning and transient suppression are destined to increase even more in future vehicles.

Automobile electronic systems can be broken down into four main categories 'Powertrain Drive' consisting of electronic engine management, electronic transmission, electronic networks; 'Safety systems' such as Antilock Brake systems, air bag triggering, anti-theft, suspension, steering, skid systems; 'Comfort body systems' such as Air conditioner, seat adjusting, dashboard displays; 'Communication systems' such as Global positioning system, radio reception, information systems. Each of these systems requires Electronic Control Unit (ECU) for efficient performance.

'Electronic Engine Management' is the science of electronically equipping, controlling and calibrating an engine to maintain top performance and fuel economy while achieving cleanest possible exhaust stream, and continuously diagnosing system faults. Due to the requirement of lower emissions, together with the need for better performance, Electronic systems form an important part of Engine management [1].

### **1.1 The Electronic Systems design approach**

Electronic Systems can be defined as a group of electronic and electrical devices working to perform a specific task, with optimum and efficient results. The steps in the design of an Electronic System are surveying the Design Requirements, Analysis and Conceptualization of design i.e. proposing ideas for design, followed by actual design based on the proposed ideas, verification, implementation and testing. In the I stage of

this project, the Design Requirements, Analysis and proposing ideas for design have been completed. And the actual design has also started.

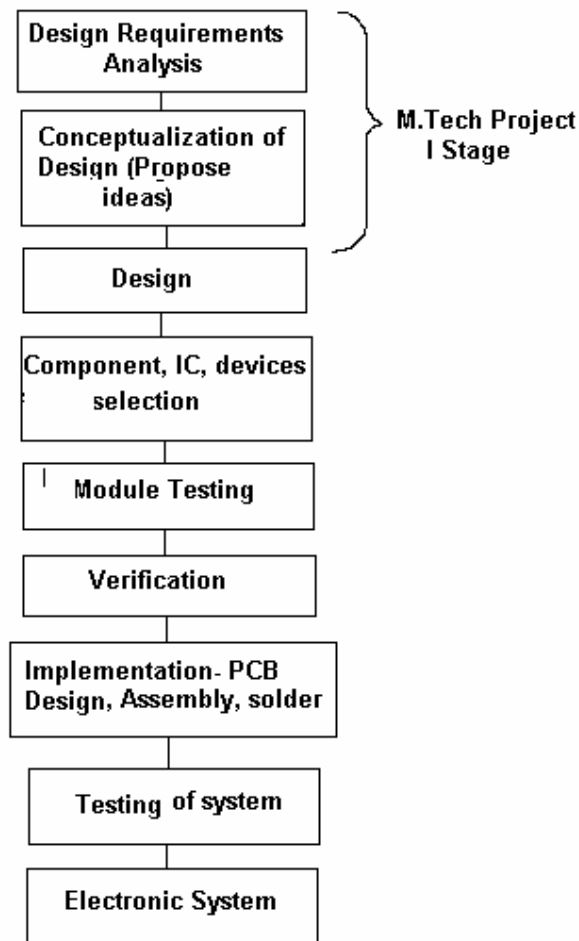

Fig.1. Steps in the design of an Electronic system

The Electronic Systems design approach at the earliest stages will provide reduced design cycle time and cost-performance optimization to enable Electronically operated vehicles [7]. In this approach an Electronic system is broken into parts for ease of design. System boundaries may or may not overlap. Thus the Engine management ECU can be thought as an electronic system comprising of the following sections.

- (1) Electronic Charging, Alternator, and Engine starting system
- (2) Electronic Ignition system
- (3) Electronic Fuel system

The design would incorporate both analog and digital design. The main processing and controlling would be done using microcontroller technology that improves reliability, efficiency, accuracy and control. There would be other interfacing circuits for both analog and digital hardware. Thus after the design of Engine management ECU, this single Printed Circuit Board (PCB) when connected to the required sensors and actuators would be used as engine starter, ignition and fuel system to provide optimum and efficient Electronic engine management.

Through out the report a designer's approach has been used by proposing self designed circuits, block diagrams and flowcharts, which would be the basis for design of the electronic system in the next stages. In Chapter 2, the electronic charging, alternator and engine starting has been discussed. Chapter 3 defines the design requirements for the Electronic Ignition system. In Chapter 4, requirements for design of the Electronic Fuel system are explained. In Chapter 5 the actual design process of Electronic Engine management is started by designing the ECU Input / output circuit. Summary and work needed to be done in further stages is discussed in the last section.



## **Chapter 2**

# **ELECTRONIC CHARGING, ALTERNATOR AND ENGINE STARTING SYSTEM**

### **2.1 Battery**

The vehicle battery is used as a source of energy when the engine, and hence the alternator is not running. It is a power storage device required to operate the engine starter motor.

Types of batteries are lead-acid, alkaline, ZEBRA, Ultra-capacitors, cells, sodium sulphur, swing batteries. The lead-acid batteries have been the most suitable choice. Some of battery ratings are in Ampere hour (AH) capacity, Reserve capacity, cold cranking capacity. Some characteristics are internal resistance, efficiency and self-discharge. The nominal 12V battery consists of six 2V cells connected in series [2].

### **2.2 Electronic Charging circuit and system**

The charging is done by the alternator of the vehicle, which produces voltage when engine is running, supplied to battery and loads. When engine is not running current flows from battery to loads. The state of charge should not fall below 70 %, to prevent difficult recharging. Constant voltage charging is done where the charger is at a constant level and the state of charge will determine how much current flows. Typically  $14.2 \pm 0.2$  V is accepted constant voltage for 12 V batteries. In boost charging, the battery temperature should not exceed 43°C [6].

The alternator is a generator producing 3-phase AC voltage when the electromagnetic rotor (initially magnetized by battery when start relay switch closed by starting system) rotates between the three stator windings connected in Star (or Delta). The frequency is  $f = pn / 60$ , where  $p$  = number of poles,  $n$  = alternator speed rev/min.

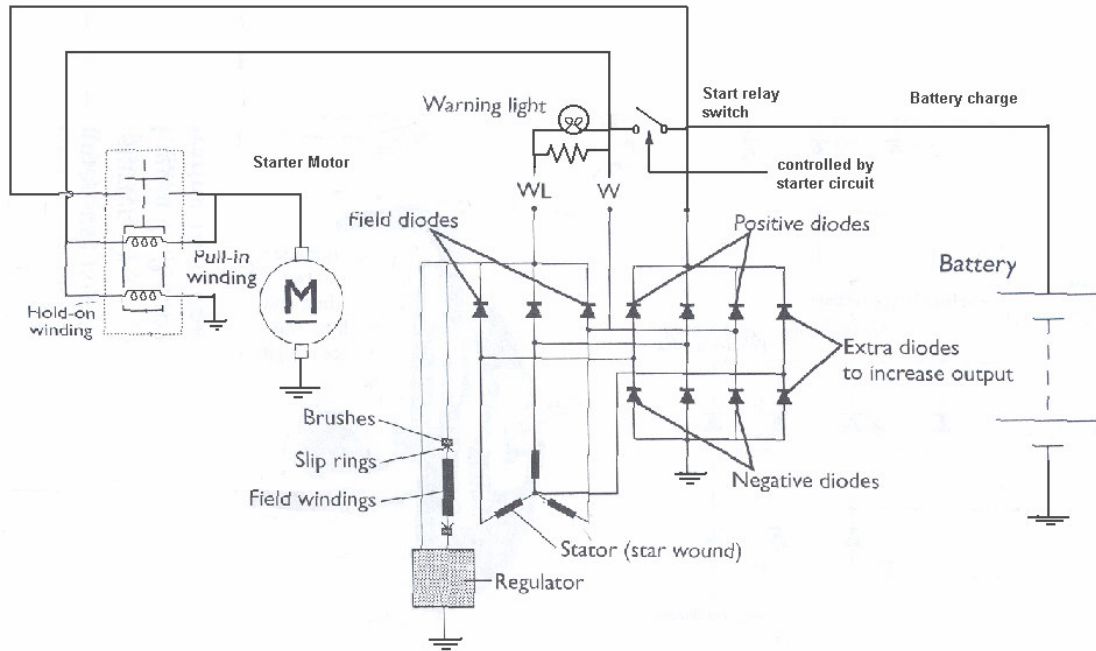

Fig.2. Electronic Charging and Engine Starting circuit diagram

There could be third harmonic( $3f$ ) at the neutral point. There is a fixed drive ratio of alternator speed to engine speed determined from maximum allowable alternator speed to maximum allowable engine speed, sometimes 3:1.

This AC is rectified by a 3-phase full wave diode bridge rectifier circuit, to produce DC used for charging the battery and running electronic circuits. Charge warning light bulb indicates charging in progress. This charge warning light is extinguished when the battery charges to the alternator DC voltage, as equipotential.

Additional three diodes along with negative diodes form another 3-phase full wave diode bridge rectifier circuit, which produce DC voltage used for rotor electromagnetization (now battery not used for magnetization). Two extra diodes are employed to remove third harmonic.

Overvoltage protection can be provided by a zener diode across the field winding will prevent voltage from exceeding limit (20V)

Voltage Regulator IC is used to obtain constant voltage irrespective of changes in load, supply, temperature and also have overload and overvoltage protections.

### **Charging system demands and solutions**

The loads on the alternator can be classified as continuous, prolonged and intermittent, which keep increasing, thus increasing the power supply demand of the alternator. Iron losses, copper losses and mechanical friction lead to inefficiency. There are various solutions for the high power demand [8].

Larger alternator is the easiest, or alternators with higher maximum speed, thus allowing greater drive ratio.

Power management technique is used wherein certain loads like headlights, fog lights are switched off when vehicle not moving [19].

Two-speed drive technique, which uses a drive ratio of 5:1 for engine speeds under 1200 rev/min and 2.5 at higher speeds [4].

Increase Idle speed but this increases fuel consumption and emissions.

Dual power supply technique is used wherein, each of two 12 V supplies are used for smaller loads, while both 12 V, i.e. 24 V is used for heavier loads [18].

Water-cooled and Integrated alternators / starters called 'dynastart' are also being used.

## **2.3 Electronic Engine Starting circuit and system**

In order to start the engine a minimum starting speed (typically about 100 rev/min) should be achieved. This is achieved with the help of an engine starter. Once this is achieved the engine would use the combustible mixture, compression stroke and ignition to continue running. The starting torque should be more than the engine torque at the time of starting. As the speed increases, and after the cranking speed, the engine torque takes over, and the starter is disengaged mechanically. The cranking speed decreases with increase in temperature [5].

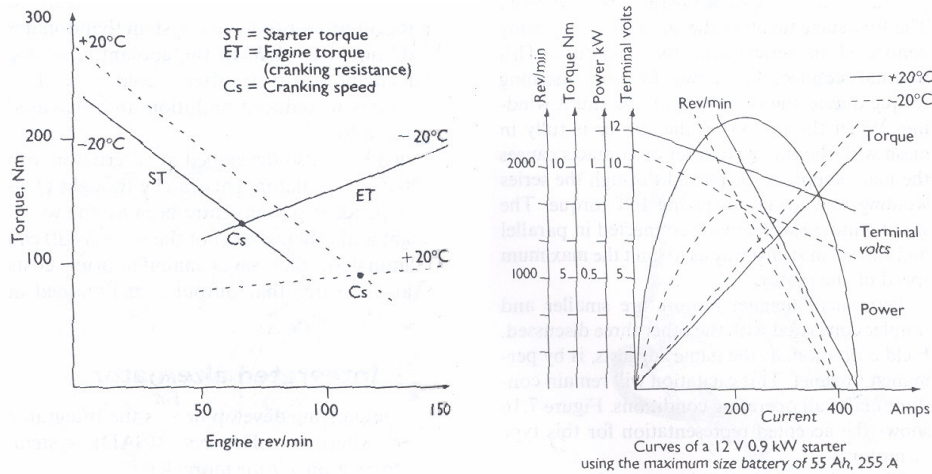

Fig.3. Starting, engine torque and Starter Motor Characteristics [4]

A typical cranking current of 150A to 500A is required to provide the initial stalled torque. In a motor, when current is passed through the armature coil rotor (typically wave wound) placed in magnetic field stator (typically four-pole four-brush), a force is created acting on rotor coils, causing it to rotate. A series wound DC motor, wherein the field winding (electromagnet) is in series with the armature, is used for starting, because it has a high initial torque (produced due to high current, low resistance and no back EMF), which is required to overcome the stall torque. Sometime, shunt wound, compound wound or permanent magnet DC motors can also be used [1].

Different types of starters are used like Inertia, Pre-engaged, Permanent magnet (small size) starters. Owing to the very high speeds at no load (0A), there is possibility of damage. Maximum power is at mid range speed and maximum torque at zero speed. Stall torque  $T = BilrZ$ , where,  $B$  = magnetic field in  $Wb/m^2$ ,  $I$  = Current (V- EMF)/R,  $l$  = length of conductor in field in m,  $r$  = armature radius in m,  $Z$  = number of armature conductors [2].

Power consumed  $P = \text{Torque} \times \text{angular velocity}$ . Typical efficiency is 60 %.

The starter motor is the main load on the battery, thus to prevent power loss heavy conductors are used, with less voltage drop.

### Electronic engine starting circuit diagram

The circuit diagram is same as shown in the charging system. When the starter relay switch closes, the hold-on and pull-in windings of the relay are energized. The current

through pull-in winding flows through the starter motor, which slowly engages itself with the engine, and at same, time the main contact to the starter motor closes. Thus the motor is now supplied by battery voltage, thus rotating and starting the engine. The pull in winding switches off as equipotential. When the engine starts and start relay switch is released, the main contact opens and starter motor stops rotating and the starter is disengaged from engine. This is the control circuit for the start relay switch.

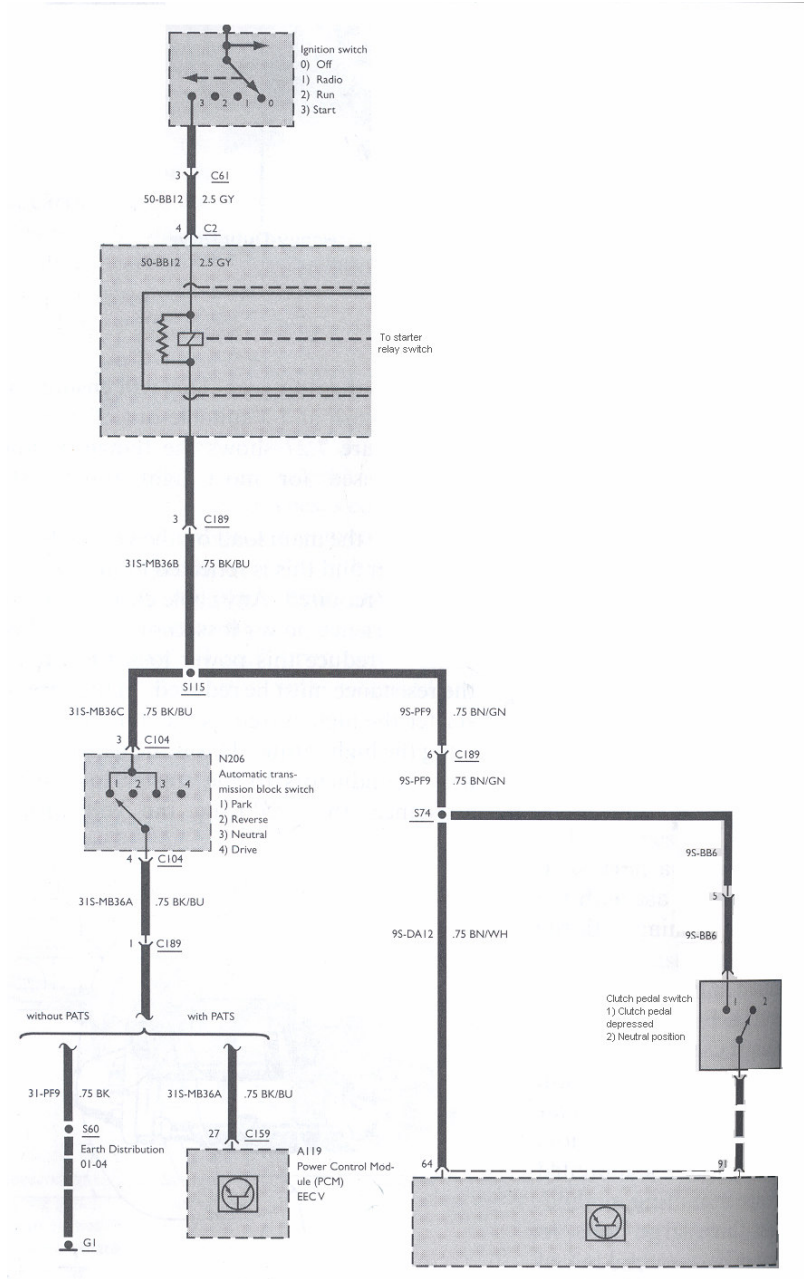

Fig.5. Circuit for controlling the start relay switch (used by Ford Motor Company Ltd) [8]

The start relay switch (i.e. the starter) turns on only when the Ignition switch is at the start position and either the Automatic transmission switch is at Park, Neutral position or the Clutch pedal switch is at depressed position. Only under the above conditions will the relay coil activating the start relay switch is connected to earth through the Electronic transistorized Power control module (PCM). To prevent start operation when engine is on, the PCM does not complete the earth path.

ECU controlled starter will have features such as starter torque evaluated in real time to tell the precise instant of starting, so as to shut starter off after cranking speed, so as to reduce unnecessary wear and tear. The ECU will provide thermal and short circuit protection.

## **Chapter 3**

# **ELECTRONIC IGNITION SYSTEM'S DESIGN REQUIREMENTS**

Here it has been tried to propose a block diagram (which would be the basis on which the electronic circuit would be designed) and flow chart, and hence the requirements, for the design of Ignition system section of Engine Management ECU. The fundamental purpose of ignition systems is to supply a spark inside the cylinder , near the end of the compression stroke to ignite the compressed charge of air- fuel vapour.

### **3.1 Basic terms and types of Ignition systems**

Following are the four main factors considered for broadly classifying types of Ignition systems.

#### **Ignition coil and generation of High Tension (HT)**

For a spark to jump across an air gap of 0.6 mm in an engine cylinder under compression, a voltage of 2 to 3 kV is required. For higher compression ratios and weaker mixtures, voltage up to 20 kV or even 40 kV is required. Thus the ignition system has to transform the normal battery voltage of 12 V to approximately 8 to 20 kV and in addition, has to deliver this high voltage to the right cylinder at the right time. By transformer action, primary winding of a coil is switched on and off causing a high voltage to be induced in the secondary winding with more number of turns than the primary coil. The value of this mutually induced voltage depends on the primary current, turns ratio and rate of change of magnetism [4].

#### **Advance angle (timing)**

The ignition timing (or the time at which the spark occurs) has a significant effect on fuel consumption, torque, drivability and exhaust emissions. For optimum efficiency the ignition advance angle should be such as to cause the maximum combustion pressure to occur just after the Top Dead Centre (TDC) i.e. when the engine piston is at maximum compression point [2]. The graph shows the effect of timing changes on emissions,

performance and consumption. The quality of the spark determines its ability to ignite the mixture. The stronger the spark, the less the likelihood of a misfire, which can cause massive increase in production of hydrocarbons. It is clear from the graph that a compromise on fuel consumption and emissions has to be done while choosing the advance timing. The ideal ignition timing is dependent on factors to be discussed later.

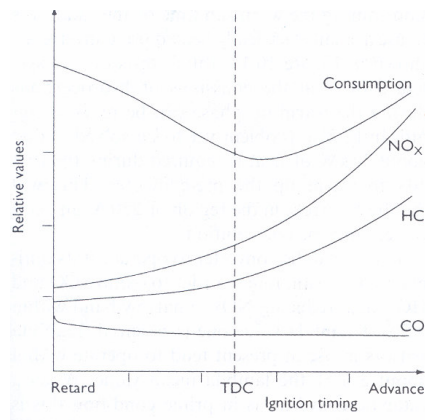

Fig.6. Effect of changes in ignition timing.

### Dwell

The energy storage takes place in the ignition coil in the form of magnetic field. The charge on the coil before ignition point depend on dwell period. Ignition spark occurs is at the end of dwell period. The term dwell is a measure of the tike during which the ignition coil is charging i.e. the primary current is flowing. It is often expressed as a percentage of one charge – discharge cycle.

### Distribution

Directs the spark from the secondary coil to each cylinder in a pre-set sequence. In a 4 stroke 4 cylinder engine, it will distribute four sparks, one to each cylinder in two revolutions.

Thus depending on these factors the ignition system can be broadly classified as



Type	Conventional	Electronic	Electronically Programmed	Electronically Programmed – Electronically Distributed
Ignition	Inductive	Inductive / Capacitive	Inductive / Capacitive	Inductive / Capacitive
Dwell control	Mechanical	Electronic	Electronic	Electronic
Advance control	Mechanical	Mechanical	Electronic	Electronic
Distribution	Mechanical	Mechanical	Mechanical	Electronic

### 3.2 Proposed Block diagram and Design requirements of Electronically programmed and distributed ignition system

For obtaining the design requirements of ECU – Engine Management, we will consider the Electronically Programmed and Distributed Ignition systems. The following is the proposed block diagram for designing the Ignition system part of the Engine Management ECU. This diagram would be the basis on which the electronic circuit would be designed.

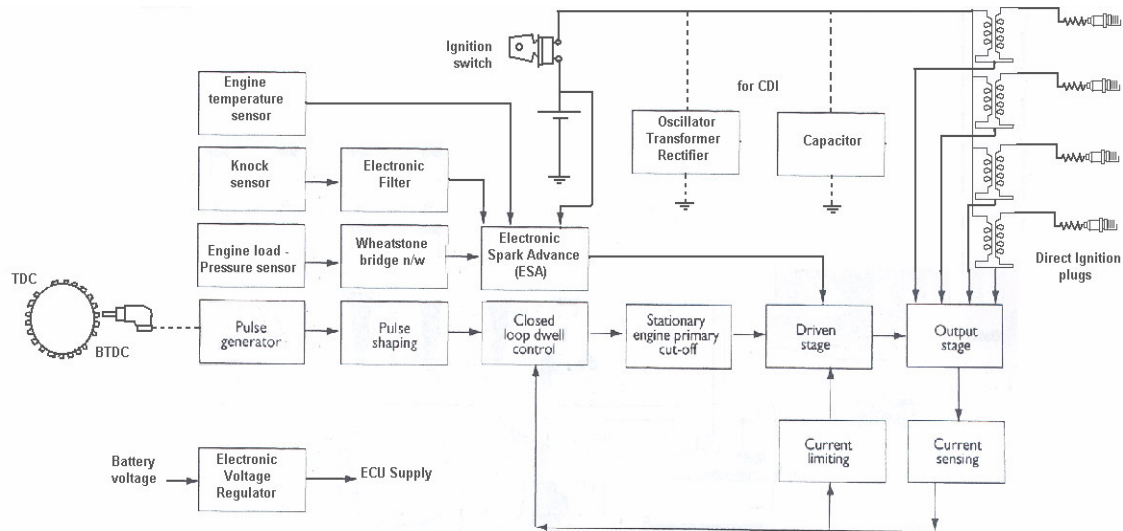

Fig.7. Proposed Block diagram of Electronically Programmed and Distributed Ignition System

### 3.2.1 Ignition switch

Provides driver control of the ignition system and is also used for starting the engine in starting phase.

### 3.2.2 Ignition or Spark generation - Inductive / Capacitor Discharge type

Types of spark generation

#### 1. Inductive Charging of Ignition coil

The ignition coil stores energy in the form of magnetism. The instantaneous value of primary current is given by

$$i = \frac{V}{R} (1 - e^{-Rt/L})$$

Where  $i$  = instantaneous primary current,  $R$  = total primary resistance,  $L$  = inductance of primary winding,  $t$  = instantaneous time.

The energy stored in the magnetic field of the ignition coil is given by

$$E = \frac{1}{2} (L \times i^2)$$

where  $E$  = energy,  $L$  = inductance of primary winding,  $I$  = instantaneous primary current.

The rate of increase of primary current determines the value of current when the circuit is broken in order to produce the collapse of the magnetic field, thereby producing a high voltage spike at the secondary.

#### 2. Capacitor discharge ignition (CDI)

The CDI works by first stepping up the battery voltage to about 400 V DC, using an DC to AC converter (oscillator), amplifying it with a transformer, followed by a rectifier to obtain high voltage DC. This high voltage charges the capacitor, which is discharged at the point of ignition through the primary coil by a thyristor, producing a high voltage spike at the secondary. The disadvantage is that since the spark duration is short, it can cause problems during starting, overcome by multi-sparking [9].

### 3.2.3 Electronic Voltage Regulator

This circuit is used to provide a constant voltage supply to the ECU irrespective of the changes in the supply and load, so as to provide accurate ignition control.

### 3.2.4 Pulse Generator – Crankshaft / Hall effect / optical type

A pulse generator is used to provide the timing signal in correspondence to the speed and position of the engine, so as to accurately control the turning on and off of the primary coil, thereby providing spark at the desired time. Types of Pulse generators are

#### 1. Inductive pulse generator (Engine speed and position – crankshaft sensor)

This device consists of a magnet, a winding and a soft iron core. It is mounted in proximity to the reluctor disc, which has 34 teeth, spaced  $10^\circ$  intervals around the periphery of the disc as shown in the block diagram. It has two missing teeth,  $180^\circ$  apart at known positions before TDC and BTDC. As a tooth from the reluctor coupled with the engine passes the core of the sensor, it induces a voltage in the winding, the frequency of the waveform being proportional to the engine speed. The missing tooth causes a no pulse at those positions, so that the ECU can determine the engine positions.

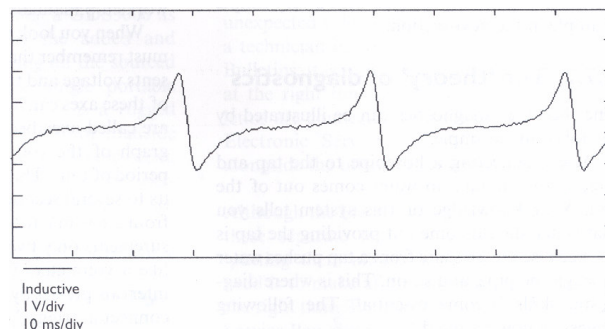

Fig.8. Typical inductive pulse generator (Engine speed and position crankshaft sensor) output [10]

#### 2. Hall effect pulse generator

The principle of working of a Hall effect transducer is that if a strip of conducting material carries a current in the presence of a transverse magnetic field, a difference of potential is produced between the opposite edges of the conductor.

$E_H = K_H IB/t$  , where  $K_H$  = Hall effect coefficient;  $Vm^3/Awb$ , I = current, B = magnetic field, t = thickness of hall strip

As the engine rotates, the vanes attached under the rotor arm alternately covers and uncovers the hall chip. Thus the chip produces almost a square wave output (0 to 7 V), which can easily be used to switch further electronic circuits.

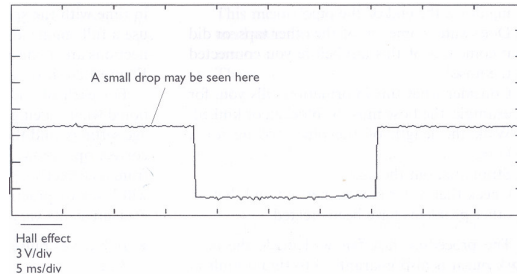

Fig.9. Hall effect pulse output [10]

### 3. Optical pulse generator

This involves a focused beam of light from an LED and sensed by a phototransistor. The rotating vane coupled with the engine interrupts the light, thereby forming a square wave output

#### 3.2.5 Pulse Shaping circuit

A circuit within the ECU ( Schmitt trigger) converts the pulse generator signal into a pure square wave.

#### 3.2.6 Electronic Dwell control - Constant / Open loop / Constant Energy closed loop type

Types of Dwell control

##### 1. Constant Dwell systems

In this type, the dwell percentage or dwell angle (ratio of the time for which the primary is on to the time for which it is off) remains constant. Now as engine speed increases, the

actual on and off times reduce, thus the time available to charge the coil reduces, thereby producing a lower power spark.

## 2. Open loop Dwell control

In this type the dwell increases with engine speed. This will only be benefit, if the ignition coil can charge up to its full capacity in very short time. This figure shows the circuit diagram of a transistorized ignition module.

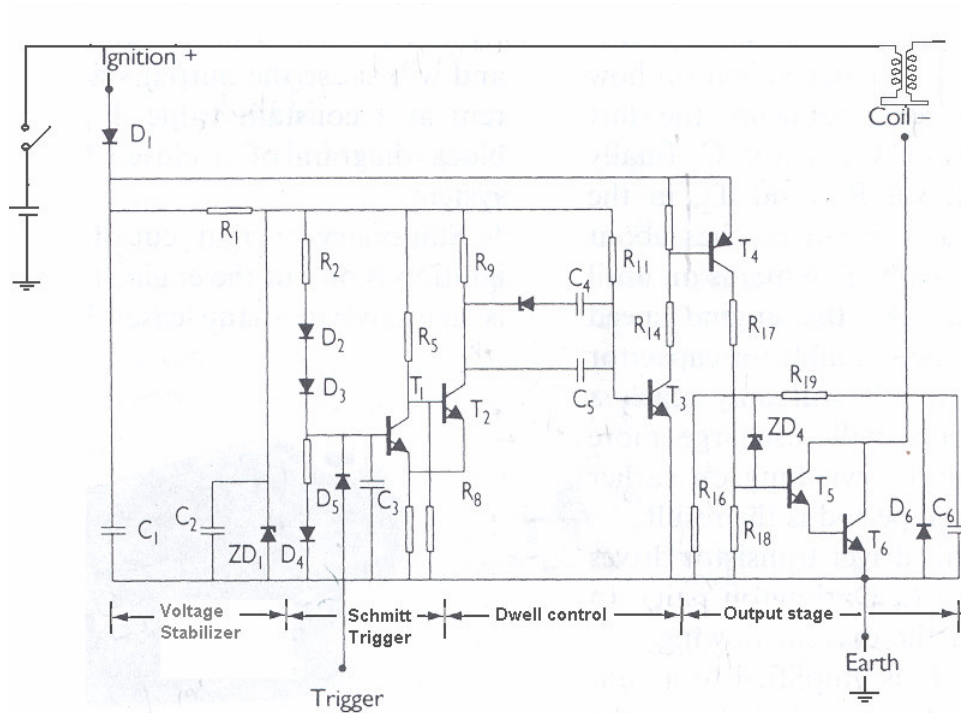

Fig.10. Circuit diagram of a transistorized ignition ECU module [9]

Diode  $D_1$  acts a reverse polarity protection. The first part is a voltage stabilizer. Zener diode  $ZD_1$  provides a constant known voltage for the rest of the circuit. The pulse generator output is given as the trigger input to the Schmitt Trigger pulse shaping circuit. The diode  $D_4$ , Transistors  $T_1$  and  $T_2$  act as a Schmitt trigger providing a square wave at the collector of  $T_2$  with pulse position and frequency same as the pulse generated input, thus providing information of the position and speed of the engine. When  $T_2$  is off, capacitor  $C_5$  charges via  $R_9$  and  $T_3$ . At low engine speed the capacitor has sufficient time to charge.  $T_3$ ,  $T_4$ ,  $T_5$ ,  $T_6$  turn on, so is the ignition coil.  $T_5$ ,  $T_6$  is a Darlington pair output switching stage. At ignition point,  $T_2$  switches on, and  $C_5$  discharges and ignition coil is

switched off suddenly thereby inducing a spike at secondary. As engine speed increases, the charge time available for  $C_5$  decreases, thus reaching a lower voltage and discharging quickly, thus increasing dwell.  $ZD_4$  and  $D_6$  protect against back EMF of coil.

### **3. Constant energy Closed loop system**

This is the type shown in the block diagram. Constant energy means that, within limits, the energy available to the spark plug remains constant under all operating conditions.

#### **Stationary engine primary cut-off**

Due to the high-energy nature of constant energy ignition coils, the coil cannot be allowed to remain switched on for more than a certain time, as when the ignition is switched on but the engine is not running. This is known as 'Stationary engine primary current cut-off' achieved by a timer. The sensing of current causes the feedback [14].

#### **Current limiting**

A very low resistance, high power precision resistor is connected in series with the power transistor and primary of ignition coil, that causes the output stage to hold the primary current at a constant value after the current exceeds a preset value.

#### **Battery voltage correction**

Correction to dwell settings, stored in the memory, is required if battery voltage falls, as larger dwell is required. A three dimensional graph of the dwell against speed (for constant energy output) and battery voltage is stored.

### **3.2.7 Electronics Spark Advance (ESA) timing control - speed, load, temperature, knock, idle, phase, anti-jerk, warm-up conditions**

The problems of mechanical centrifugal advance and vacuum advance are overcome by using Digital electronics programmed timing advance. The ideal ignition timing to ensure maximum pressure in the cylinder just after TDC, depends on two main factors, engine speed and engine load followed by many other corrections.

#### **Engine speed and position**

At higher engine speeds the time taken for the piston to travel the same distance (i.e. point of ignition) reduces. Advancing the time of the spark ensures full burning is achieved.

Similarly at lower speeds spark timing is retarded. The ECU uses the pulse generator (crankshaft sensor) to obtain engine speed and position inputs

### **Engine load measurement– manifold absolute pressure (MAP) sensor**

Weaker mixture is used on low load conditions, which burn at slower rate and requires further ignition advance. Similarly for lower loads, richer mixtures, retardation is required as the mixture burns rapidly. Engine load is proportional to manifold absolute pressure. Thus Load / Pressure sensor connected to the ECU, is a silicon diaphragm with piezoresistors connected in a Wheatstone Bridge and filter arrangement, to sense pressure. A lot of information is held in the ROM. The basic timing three-dimensional graph consists of the correct ignition advance for 16 engine speeds and 16 engine load conditions.

### **Engine temperature measurement – coolant sensor**

Coolant temperature measurement is carried out by a thermistor, which is also used by the Electronic fuel system. Timing may be retarded when the engine is cold to assist in more rapid warm up. A three dimensional graph is used that has 8 speed and 8 temperature to the timing settings.

### **Detonation detection – knock sensor**

Detonation is caused due to the pressure wave traveling at high velocity causing impact on the cylinder walls setting them into vibration or ringing knock [8]. These knock are sensed by the knock sensor, which generate piezoelectric voltage when the seismic mass vibrates. The resonant frequency is given as

$$F = 1/(2\pi)(k/m)^{1/2}, \text{ where } f = \text{frequency, } k = \text{spring constant, } m = \text{seismic mass}$$

The vehicle knock sensor has a frequency response of 15 kHz and a sensitivity of 20 mV/g. The engine will run at its most efficient when the timing is advanced as far as possible, but just below the knock range. To achieve this, the ECU responds to signals from the knock sensor (accelerometer) in the engines knock window for each cylinder, i.e. just a few degrees each side of TDC. This signal is filtered and integrated to remove unwanted noise. The sensor is tuned at 5 to 10 kHz. The resonant frequency of the sensor is 25 kHz. This signal is compared with the knock range data stored in memory. If detonation is detected, the timing is retarded on the fourth ignition pulse after detection in

steps until engine comes out of knock range. The timing is then advanced slowly in steps of  $1^\circ$ . until the maximum advance required is restored.

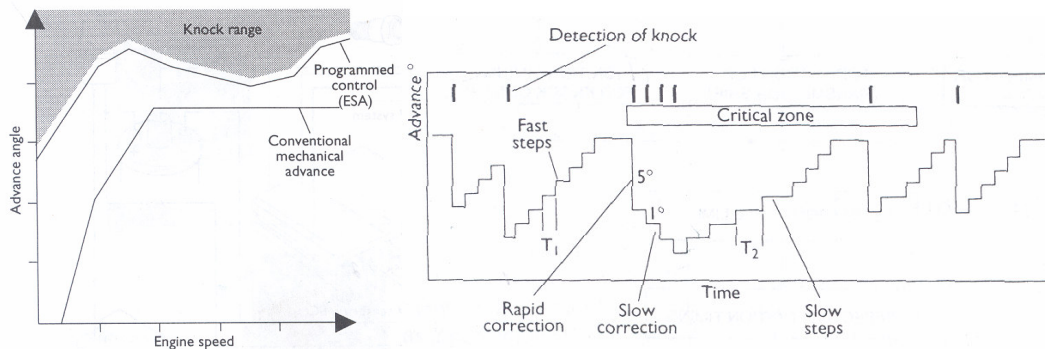

Fig.11. Knock range and Timing variation in response to knock

### Idle condition – throttle sensor

The throttle input is also used to determine timing, under idle conditions. It is a potentiometer type of sensor, providing varied voltage corresponding to position of the throttle / wiper. At idle, the throttle is at one end. Ignition timing is moved very quickly to vary idle speed [20].

### Phase correction – phase sensor

Phase correction is when the ECU adjusts the timing to take into account the time taken for the HT pulse to reach spark plugs.

### Anti – jerk function

This operates to correct the ignition timing in relation to the instantaneous engine speed and a filtered speed so as to stabilize the engine rotation

### Warm up phase

The ignition timing is slightly retarded during warm up phase to heat the engine quickly

## 3.2.8 Analog and Digital Electronics Hardware and Proposed Flow Chart

For the ECU, Digital Hardware design is used to obtain optimum results. Microcontroller with on chip RAM, Flash EEPROM is used for control and calculation of various parameters, along with other interfacing circuits for both analog and digital hardware.



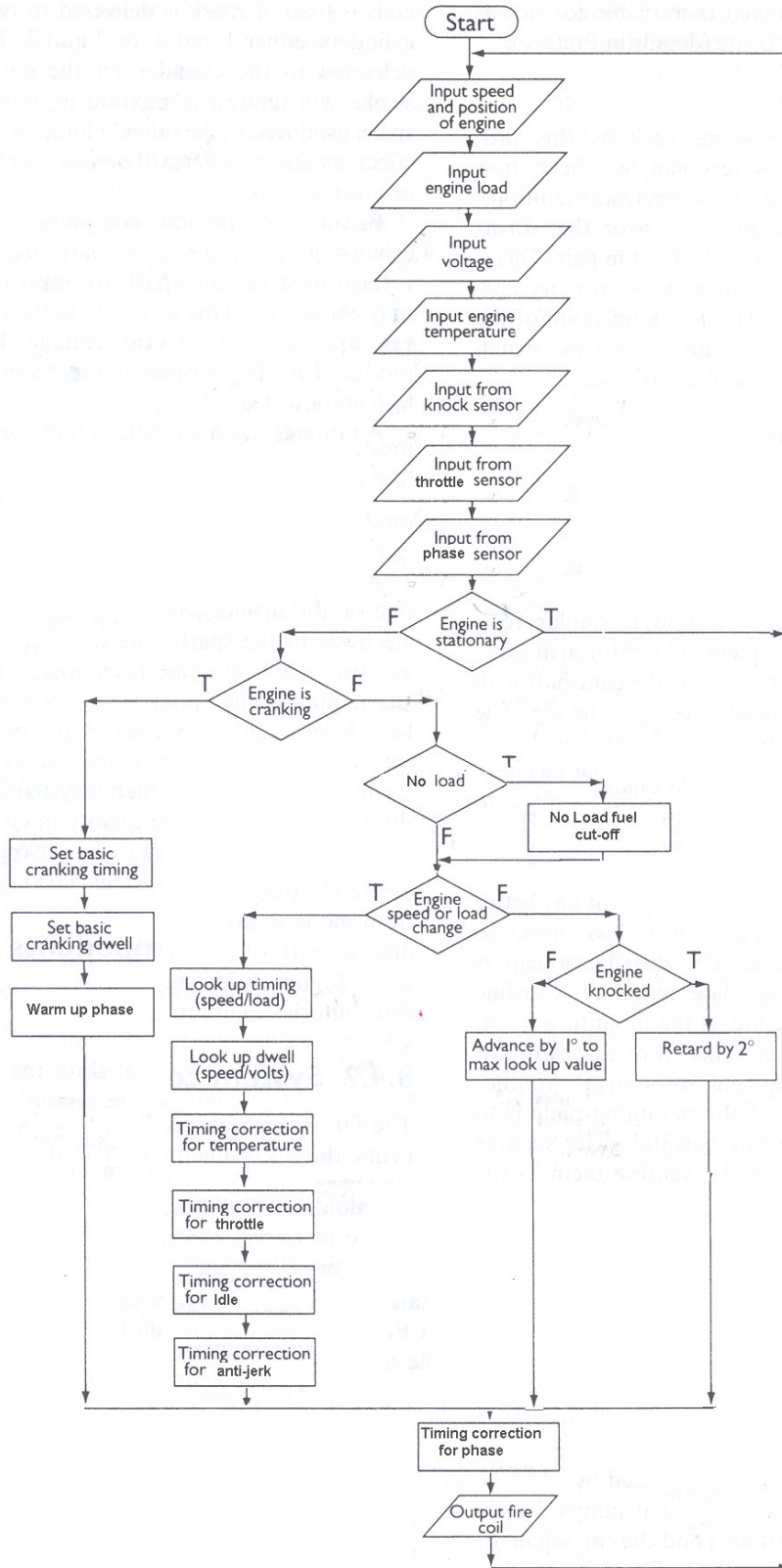

Fig.12. Proposed 'Electronic Ignition system' flow chart for ignition timing and dwell calculations

Inputs from sensors are converted by ADC into digital signals used by the microcontroller to calculate the ignition timing and dwell. Further corrections are added for temperature, knock, battery etc. As soon as the missing pulse appears, after the ignition timing, the coil is switched off. Similarly the dwell number is used to determine the switch on point.

### 3.2.9 Driving and output Switching

The problems of using the mechanical contact breakers is overcome by using an electronic power transistor that turns the primary winding on and off to cause a high voltage spike at the secondary . It uses a Darlington-type amplifier. Care must be taken that the interference caused by switching does not cause problems within the ECU.

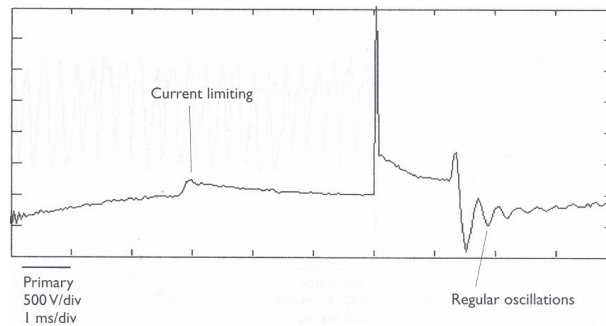

Fig.13. Primary circuit pattern [10]

### 3.2.10 Electronic Distribution - Distributorless / Direct Ignition type

Types of Electronic Distribution

#### 1. Distributorless Ignition

In mechanical distributors, only one ignition coil's secondary spike output is sequentially distributed to each spark plug using High Tension distributor. Whereas in case of electronic distributing or Distributorless Ignition systems (DIS), there is no distributor i.e. the distribution is achieved by two double-ended coils, which are fired alternately by the ECU [9]. When one coil is fired, a spark is delivered to two engines, either 1 and 4, or 2 and 3. The cylinder on compression stroke will ignite the mixture as normal, while the other cylinder will have no effect called 'lost spark'. The spark on one cylinder will jump from earth electrode to spark plug center.

## 2. Direct Ignition

This system utilizes a coil for each cylinder. These coils are mounted on the spark plugs. This voltage can exceed 400 kV, providing efficient combustion under cold start and weak mixtures. CDI is sometimes used. Camshaft sensor is used to provide information as to which cylinder is on compression. If no sensor is used, then the ECU fires all the coils. Measuring current through each spark indicate which cylinder is on compression, as burning mixture has lower resistance. In case of fuel flooding when engine cranks excessively, the plugs are all fired with multisparks for some time with dwell period of 5 secs to burn excess fuel. During difficult starting, multisparking is used at 70° before TDC.

### 3.2.11 Spark Plug and High Voltage cables

The spark plug must allow a spark to form within the combustion chamber, to initiate burning. He spark jumps across the least path of resistance. The spark plug and cables must withstand severe voltages, temperatures, vibrations, and chemical environment. A method of accessing plug temperature is the thermocouple spark plug, which allows accurate measurement of the temperature . Another method of ionic current measurement is starting to be used as feedback to engine management systems for accurate electronic control.

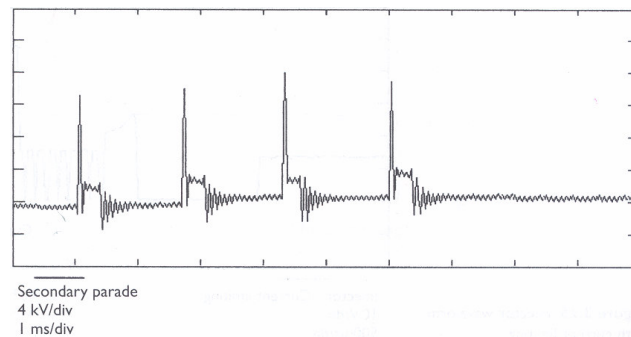

Fig.14. Secondary spark pattern – four cylinders [10]

# Chapter 4

## ELECTRONIC FUEL SYSTEM'S DESIGN

### REQUIREMENTS

Here it has been tried to propose a flowchart, a self-designed and tested lambda control circuit module and hence the requirements, for the design of Electronic Fuel system section of the Engine Management ECU. Due to the requirement of lower emissions, together with the need for better performance, engine fuelling and exhaust emissions control are an important part of Engine management.

#### 4.1 Air-fuel mixture and Exhaust Emissions

##### Mixture strength and performance

Air-Fuel ratio (AFR) = Air mass ( $A_m$ ) / Fuel quantity (F)

The ideal stoichiometric air-fuel ratio by mass for complete fuel combustion is 14.7:1, known as a lambda value ( $\lambda$ ) of 1. This figure is calculated by number of oxygen atoms required to completely oxidize hydrocarbon atoms in fuel [16]. This mixture ratio provides maximum power (12:1) and minimum consumption (16:1). The air-fuel ratio is altered under certain operating conditions, discussed later, to improve performance, consumptions and emissions.

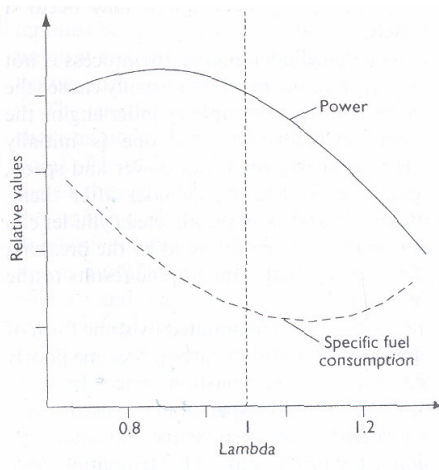

Fig.15. Effect of varying air-fuel ratio on power output and fuel consumption [6]

## Exhaust emissions

The burning of hydrocarbons in the presence of air, results in unwanted exhausts.

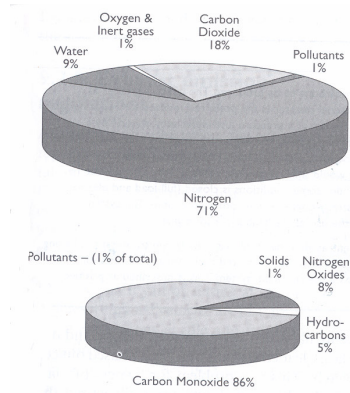

Fig.16. Composition of exhaust [4]

## 4.2 Electronic fuel system's Design requirements

Electronic control is being used for effectively controlling the air-fuel mixture and exhaust emissions. The basic principle of fuel injection is that , at a constant differential pressure, the amount of fuel injected should be directly proportional to the electronically controlled injector open time.

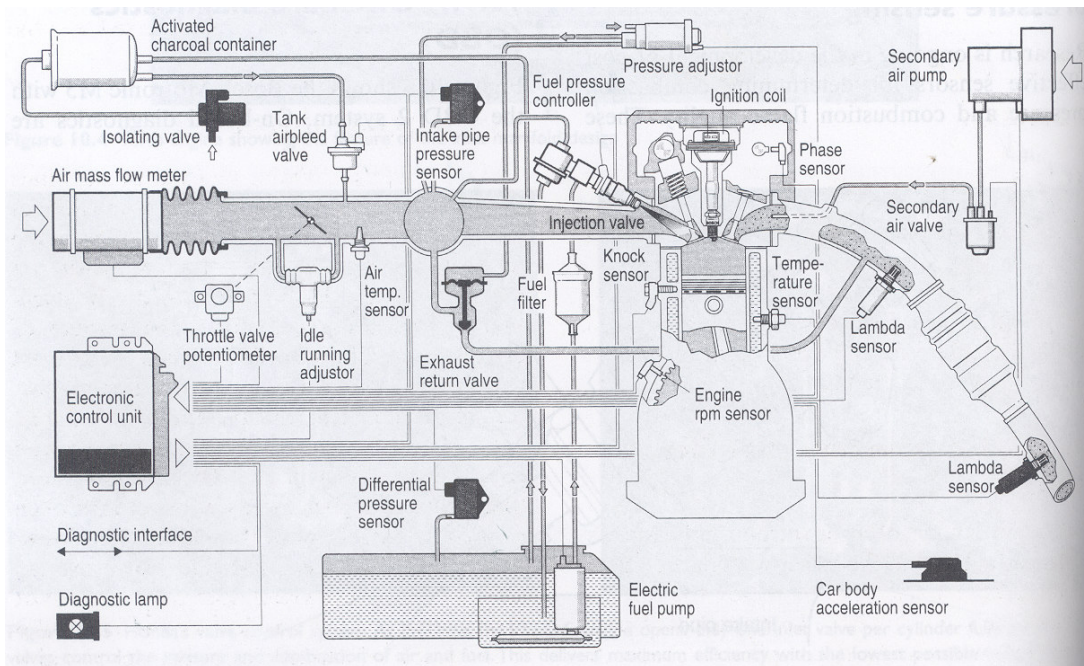

Fig.17. Electronic Control Unit (ECU) - Engine Management (Electronic Ignition and Fuel systems) with On-Board Diagnostics (OBD) [3]

### 4.2.1 Main relay operation

Here is a main relay controlled by the ECU to power on the injection system only when ignition pulses are sensed.

### 4.2.2 Air mass flow measurement – Flap / Hot wire type

Types of air flow measurement are

#### 1. Flap type air flow sensor

The engine load is proportional to the quantity of air drawn by the engine. The air flow sensor measures the flow of air passing through it that moves the flap wiper of the embedded potentiometer [10]. To reduce the fluctuations a compensation flap is also connected. Thus the output voltage is proportional to air quantity and engine load.

#### 2. Hot wire air flow sensor

As air passes over a hot wire it tries to cool it. If a circuit is created such as to increase the current through the wire in order to keep the temperature constant, the current is proportional to the air flow. Another wire is incorporated for temperature compensation used in bridge configuration. Heating the wire every time the engine is switched off prevents wire from being dirty.

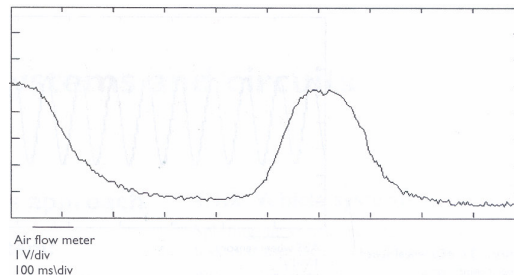

Fig.18. Air flow meter output [10]

### 4.2.3 Engine speed measurement – Idle, Overrun and Overspeed conditions

This sensor is the same as the pulse generator in the ignition system. The injection open time is calculated from the three-dimensional look up graph of speed and load against injection time or  $\lambda$ .

### Idle speed

At idle position of throttle potentiometer, this speed is adjusted, by varying the bypass air through the idle actuator.

### Overrun fuel cut off

The injection is completely cut off when the engine is warm, throttle is closed and engine speed above set level 6900 rev / min. If throttle is pressed or speed falls the fuel is reinstated gradually for smooth take up.

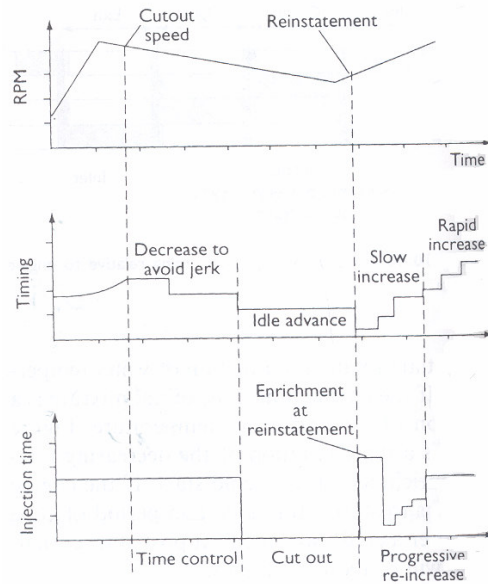

Fig.19. Overrun fuel cut off and reinstatement

### Overspeed fuel cut-off

Above a set excess speed, ECU cuts off the injectors, and reinstates once speed falls below

## 4.2.4 Temperature Measurements – Engine, Fuel (Hot start) and Air

### 1. Engine / Coolant Temperature measurement

A thermistor is used as stated in ignition systems. At cold engine temperature rich mixture .i.e. more fuel is required.

## **2. Hot start enrichment - Fuel Temperature sensor**

This is also a thermistor to inform the ECU about hot starting to counteract effects of fuel evaporation, i.e. a short period of extra enrichment, which decays gradually to assist hot start [11].

## **3. Air temperature measurements**

An air temperature sensor is used to inform the ECU of the inlet air temperature . If this temperature decreases, density increases and hence the quantity of fuel injected must be increased.

### **4.2.5 Throttle position measurement –**

#### **Idle, Accelerate, Decelerate and Full load conditions**

This is a potentiometer type of sensor. At idle, the output should be 325mV and at full load 4.8 V. Output voltage = supply (angle moved / total angle possible)

#### **Idling phase**

The idle position is detected from throttle position at idle. The air flow is adjusted by adjusting the idle actuator to cause a very low idle speed. The fuel injection is also adjusted.

#### **Acceleration enrichment**

When the ECU detects a rising voltage, pulse length is increased over a number of ignitions to achieve a smooth response. The enrichment value is determined from coolant temperature and pressure variations the inlet. The width is again reduced over a number of ignitions. Acceleration enrichment doesn't occur if engine speed is above 5000 rev/ min or at idle [15].

#### **Deceleration weakening**

The ECU detects this condition from a falling throttle voltage and the pulse length is shortened to reduce fuel consumption and exhaust emissions. If the ECU detects manifold pressure is greater than 30 mbar, the mixture is weakened.

#### **Full load enrichment**



Fuel injection is increased to a maximum of AFR 1:1 for maximum power output, taking care of knock.

#### 4.2.6 Exhaust gas oxygen (EGO) measurement – Closed loop Lambda control and Catalytic converter

These sensors operate above 300°C. There is a zirconium dioxide in between two plates one exposed to atmosphere with more oxygen, more electrons, thus negative and other plate to exhaust gas with less oxygen, less electrons, thus positive. the zirconium dioxide conducts oxygen ions proportional to AFR. Wide linear range lambda sensors are available with AFR 12:1 to 24:1.

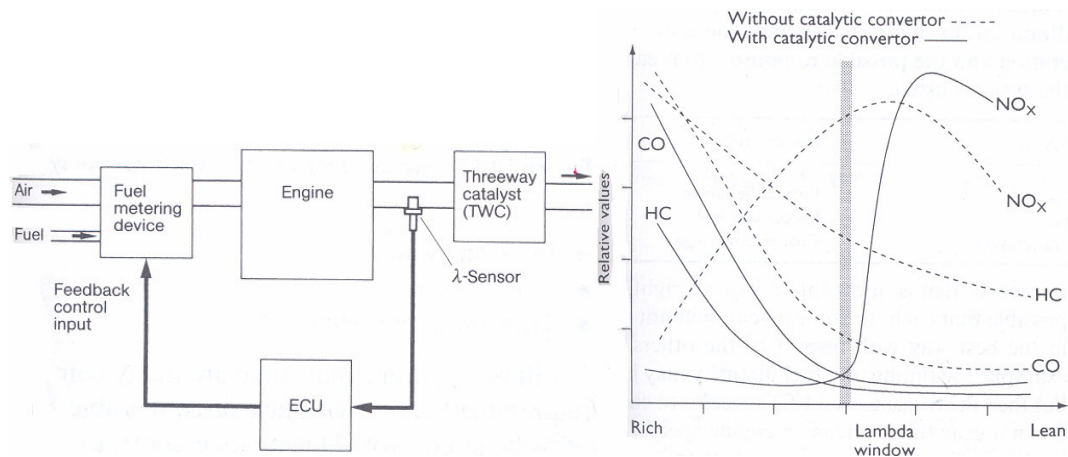

Fig.20. Closed loop lambda control and Effect of AFR on exhaust

These alterations should not be sudden or else engine would buck. So ECU has an integrator which also has to take into account the delay (dead time) between mixture formation to exhaust gas measurement due to engine speed, inlet mixture speed, exhaust speed, sensor response time [19]. As engine speed increases this delay decreases. The lambda control has to function so as to keep the mixture in the lambda window (0.97 to 1.03) in which the catalytic converter is most efficient, wherein the catalyst chemically converts the pollutants into CO<sub>2</sub>, H<sub>2</sub>O and N<sub>2</sub>, thus reducing pollutants . A further technique to reduce emissions during warm up phase is to use a small electrically heated pre converter. A second sensor s fitted to ensure ideal operation. If the change has to be

maintained for a long period then new values are stored in memory. As a new development, in cylinder catalysts result in better exhaust control.

#### **4.2.7 Battery Voltage correction**

Pulse length is increased if the voltage falls to compensate for slower reaction time of injectors due to inductance coil in solenoid injector.

#### **4.2.8 Idle or fast idle control – idle air control motor actuator**

Idle speed is a very low speed to prevent stalling and creeping to improve economy and reduce emissions [12]. A bimetal or stepper motor actuators are used. The ECU controls this actuator to control idle speed depending on idle sense from throttle sensor during warm up period. The rotary action of the stepper motor controlled by the ECU digital output, acts on a screw thread moving the valve linearly, progressively opening and closing an aperture, thereby controlling the air bypassing the throttle valve. The air that it allows is set by the open/ close ratio of the valve. Some calculations of stepper motor control are

Step angle =  $360 / \text{steps per revolution}$

Step frequency =  $\text{RPM} \times \text{steps per revolution} / 60$

Angular velocity =  $\text{Step frequency} \times 2\pi / \text{steps per revolution}$

#### **Adaptive idle control**

In adaptive control, the lowest idle value is set depending on the engine temperature, speed, load, altitude and engine drift during its life to reduce fuel consumption and exhaust emissions [13].

#### **4.2.9 Exhaust gas recirculation (EGR)**

This technique is used to primarily reduce the production of  $\text{NO}_x$ . EGR can be internal due to valve overlap, or external via a simple arrangement of pipes and a valve controlled by the ECU from data in ROM, to control the percentage of recirculation.

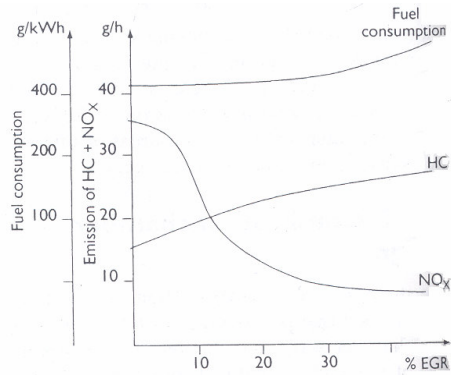

Fig.21. Effect of EGR on emissions and fuel consumption. [12]

#### 4.2.10 Fuel supply –

##### tank, pump, pressure regulator and tank emissions

###### 1. Fuel tank

The fuel tank has a swirl pot to ensure that the pick up pipe is covered in fuel at all times, preventing air being drawn into the fuel lines.

###### 2. Fuel pump and relay

Fuel is collected from the tank via a paper filter immersed in it or outside. The fuel pump typically has resistance 0.8 ohms, voltage of 12 V, current of 10.5 A, delivery of 120 litres/ hour at 3 bar pressure. The fuel pump is controlled by the ECU via a fuel pump relay. When the ignition is first switched on, the pump runs for a short time to ensure the system, is at correct pressure [16]. The pump will then only run when the engine is cranked or is running. An inertia switch is usually located, which cuts the supply to the fuel in case of a collision, to prevent fuel spillage.

###### 3. Fuel pressure regulator

The differential pressure across the injectors should be constant for correct pulse width control, typically at 3 bar. When the manifold pressure exceeds the preset value (of the spring) a valve is opened and the excess fuel is returned to the tank.

###### 4. Fuel tank emissions

The inputs from pipe pressure sensor, Isolating valve (controlled by ECU from pipe pressure), emissions from fuel tank and differential pressure sensor cause activated

charcoal container to send charcoal to tank air bleed valve so as to control the emissions from fuel tank.

## 5. Valve timing

The valve timing has considerable effect on exhaust emissions. The valve overlap time i.e. the time when the inlet valve opens and outlet valve closes determines the amount of exhaust gas left in the cylinder when the exhaust valve finally closes. At higher speeds a longer inlet open period increases the power developed. This causes a greater valve overlap and at idle, increases the emissions [14]. Valve timing can be controlled electronically by the data from the memory. Variable inlet tract is used to improve efficiency. The secondary air pump and air valve send controlled air to exhaust output.

### 4.2.11 Fuel Injection – Simultaneous / Sequential / Gasoline Direct Injection (GDI) type

The injector has a winding (16 ohms) which when energized, attracts the core and fuel is delivered.

$I = V/R (1 - e^{-Rt/L})$ , where I = instantaneous current, V = supply voltage, R = resistance, L = inductance, t = time current is flowing

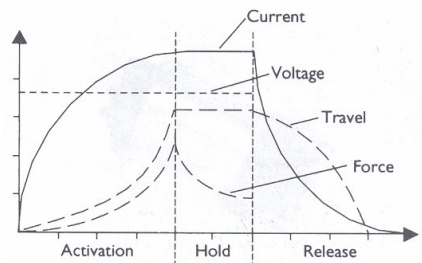

Fig.22. Solenoid- operated injection [15]

The fuel injection is controlled by controlling the solenoid on, off operation. Provided the pressure across the injector is constant, the quantity of fuel injected is proportional to on time.

Injection time = fuel quantity / rate of fuel injection (typical time is 1.5 to 10 ms)

Thus accurate fuel injection can be controlled by duty cycle on-off method. Air Shrouding is used for improved dispersion of fuel. Current limiting is sometimes used to prevent coil from damage [13].

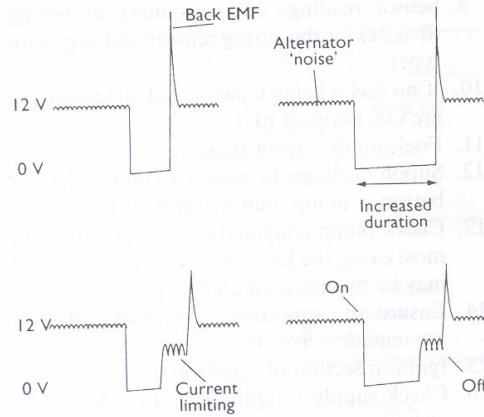

Fig. 23 Injector signals [10]

Types of Injection are

### 1. Simultaneous Injection

Fuel injection could be single point or multipoint as shown.

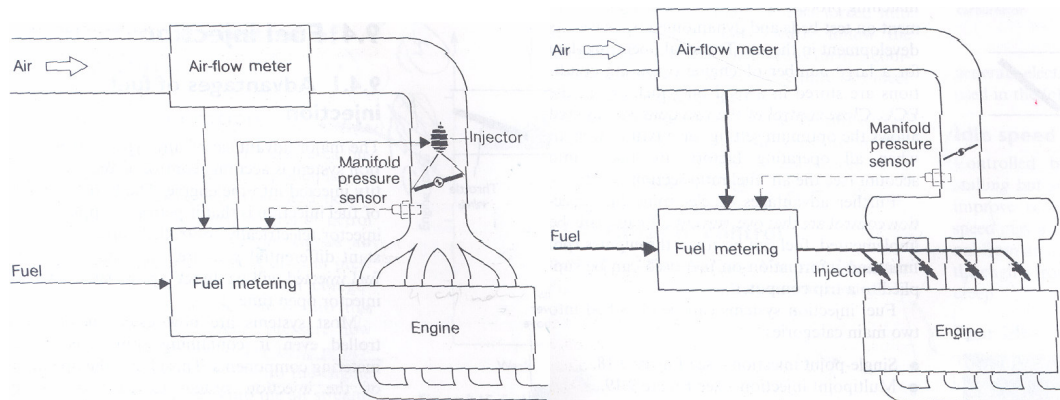

Fig.24. Single point and Multi point Fuel Injection [3]

### 2. Sequential Injection

A sequential injection system injects fuel on the induction stroke of each cylinder in the engine firing order, allowing an overall weaker charge.

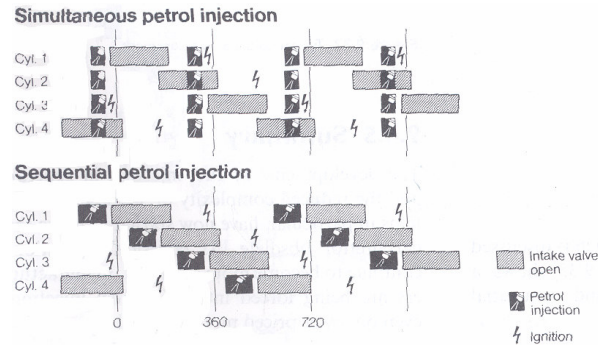

Fig.25. Comparison of Simultaneous Multi point and Sequential injection [3]

### 3. Gasoline Direct Injection (GDI) and Lean burn Technology

When the AFR is above 14.7:1 by introducing more air, the combustion of such a mixture is called lean burn. Fuel economy is maximized when the ratio is 20 to 22:1 range. If the charge mixture can be inducted into the cylinder in such a way that a richer mixture is in the proximity of the spark plug, then overall charge is much weaker called charge stratification [12]. Mitsubishi developed an engine where gasoline is directly injected into the cylinder. This has provided higher efficiency and higher performance than Multi point engines, with precise electronic fuel injection. Two combustion modes lead to lower fuel consumption than diesel engines.

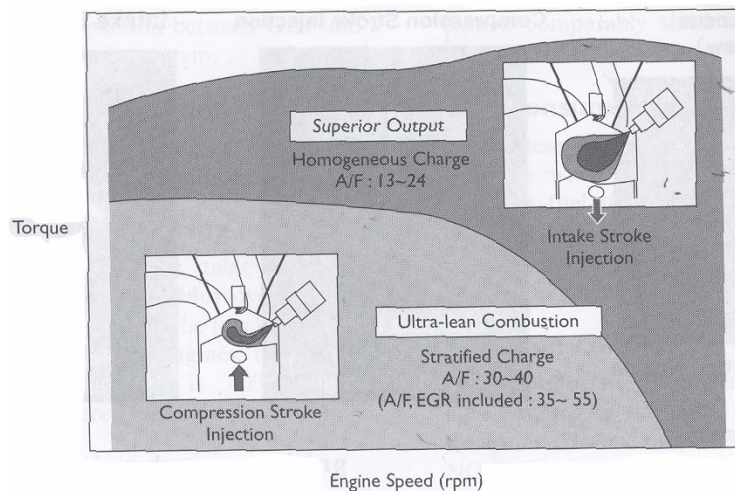

Fig.26. Two combustion modes.

### Ultra lean combustion mode

Under most normal driving conditions, i.e. up to speeds of 120 km/h the engine operates in ultra-lean combustion mode, resulting in lower fuel consumption. The electronic Fuel injection occurs at the latter stage of compression stroke. Due to curved top piston, mixture injected late in compression stroke is carried towards spark plug before dispersion for charge stratification. Electronic ignition occurs at an ultra lean AFR of 30 to 40:1 (35 to 55:1, including EGR)

### Superior output mode

At higher speeds or loads, fuel injection takes place during intake stroke. This optimizes combustion by ensuring a homogeneous, cooler AFR, which minimizes the possibility of engine knocking.

The ECU has to accordingly change the injection n times for the two modes depending in the look up table of speed, load and injection timing. Following are the methods used for optimal results. Upright straight intake ports are used for optimal air flow and improved efficiency. High-pressure swirl injectors provide fuel atomization and ideal spray pattern to match engine modes. The curved top piston maintains a compact air-fuel mixture. The GDI provides stable combustion with EGR of 30% resulting in lower emissions. Following is the comparison (fuel consumption, emissions and engine performance) between the GDI system and Multi point system.

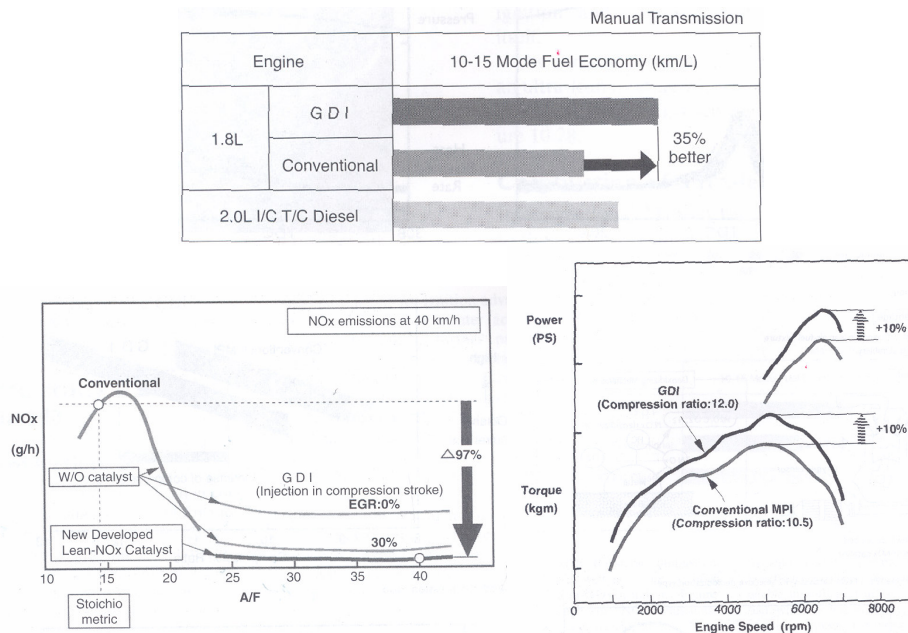

Fig.27. Fuel economy, emissions and engine performance comparison.

## 4.2.12 Calculation of basic Injection time – Air flow / Speed - density method

### 1. Air flow method

If air flow sensor is used, then once Air mass flow is known, air mass ( $A_m$ ) and thus fuel quantity can be obtained by, Fuel quantity ( $F$ ) =  $A_m / AFR$

[16]. Thus, basic Injection pulse width ( $T$ ) = Fuel quantity ( $F$ ) / Fuel Injector delivery rate ( $R_f$ )

### 2. Speed-density method

If air flow sensor is not used, then the MAP sensor, speed sensor, EGR, and Temperature sensors are used for calculating the basic injection time.

$$A_v = [ (RPM / 60)(D / 2) V_e ] - EGR_v$$

where  $A_v$  = air volume flow rate (litres/sec),  $V_e$  = volumetric efficiency (from look up table),  $EGR_v$  = EGR volume (litres),  $D$  = displacement of engine (litres)

$$\text{Thus density of air in inlet manifold } d_a = d_o (p_i / p_o) (T_o / T_i)$$

where  $p_i$  = intake pressure,  $T_i$  = intake temperature,  $d_o$ ,  $p_o$ ,  $T_o$  = density, pressure, temperature at sea level.

$$\text{Air mass flow rate } A_m = d_a \times A_v$$

$$A_m = d_a \{ [ (RPM / 60)(D / 2) V_e ] - EGR_v \}$$

$$F = A_m / AFR$$

$$\text{basic Injection pulse width } (T) = F / R_f$$

## 4.2.13 Proposed Electronic Fuel Injection system Flow Chart

Note that the actual fuel injection depends on other corrections as explained before and summarized in the flow chart.



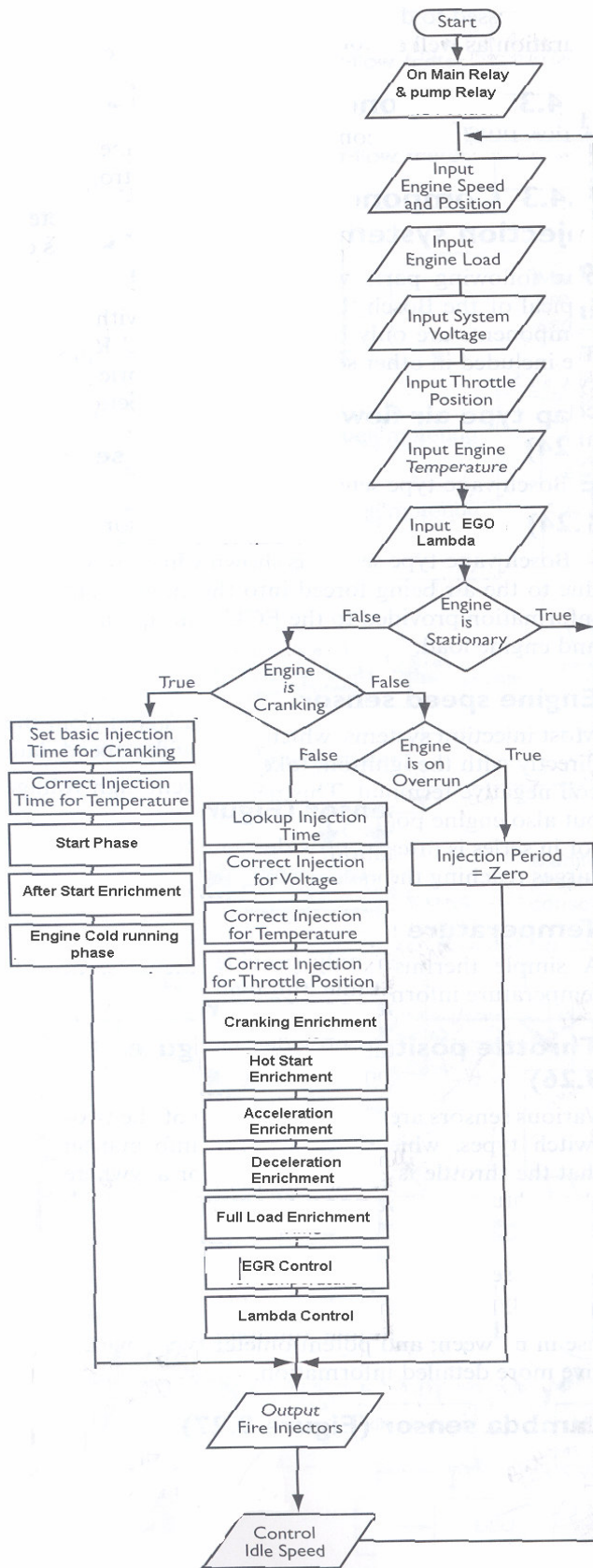

Fig. 28. Proposed 'Electronic Fuel Injection system' Flow Chart

An interpolative method can be used to find the issued pulse width i.e. if the pulse width is too small i.e. below 1.5 ms, it is an unstable range. So all the points around the chosen ideal point are worked upon.

#### **4.2.14 Other fuel injections – DMI / Diesel / alternative fuels**

##### **1. Direct mixture injection (DMI)**

This system involves loading a small mixing chamber above the cylinder with fuel with lambda values of 8 to 10, during the compression stroke and start of combustion, resulting in 30% reduction in fuel consumption. It is injected in the vicinity of spark plug [13].

##### **2. Diesel fuel injection**

It is a compression ignition and the mixture formation takes place in the cylinder combustion chamber as the fuel is injected under very high pressure. The mixture formation is influenced by following factors of solenoid-operated injection controlled by ECU using Electronic unit injection (EUI). Start of delivery and start of actual injection, increases carbon if too early, and increases hydrocarbon if too late. Spray duration (in ms) and fuel quantity (or rate of discharge). Injection pressure, Injection direction and number of jets. Idle speed control [11].

Diesel engine generally operates at excess AFR. The throttle directly acts on fuel quantity. The ideal values of fuel quantity and timing are stored in the e memory look up table. The quantity is calculated from accelerator position and engine speed. The start of injection is determined from fuel quantity, Engine speed, and engine temperature and air pressure. The exhaust emissions from diesel are far lower than petrol by EGR controlled by engine speed, temperature and quantity. The Common rail system is used to further reduce emissions where a series of injectors is connected to the rail, and each injector is opened or closed by ECU, facilitating free independent use of quantity and timing.

##### **3. Alternative fuels**

Gas powered vehicles, hydrogen powered vehicles and electric powered vehicles give lower emissions but are still in the early stages. By use of other fuels, mostly the kind of changes required in an ECU is generally only in the look-up table data stored in the ROM. The hardware and the electronic system remain same.

## Chapter 5

# **ELECTRONIC ENGINE MANAGEMENT ECU WITH ON-BOARD DIAGNOSTICS – DESIGN PROCESS STARTED**

Here the Engine Management ECU's Input / output circuit diagram and the EGO Lambda control ADC circuit module are designed, and hence the requirements, for the design of complete Electronic engine management system. This diagram would be used as basis on which the Electronic circuit board would be designed. Smart sensors and actuators can be used, wherein the transducer would be equipped with signal condition and in Intelligent sensors and actuators even with processing power. The Electronic Engine management ECU incorporates the three sections i.e. Engine starting, Ignition system and Fuel system.

### **Other Aspects of Automobile**

Complete vehicle ECU can control all aspects of vehicle including engine management, transmission system , ABS, traction, suspension control all in one ECU. But the electronic system becomes extremely complex making it less feasible. So in reality, many ECUs communicate with each other using Controller area network data bus, which used multiplex wiring system [20]. Here all messages are sent to all units. Fibre optics used for multiplexed databus will make the system resistant to electromagnetic interference. But the destination address unit will only respond. Serial port communication can be used for diagnosis. Networking can be used for diagnosis from remote center.

### **5.1 Proposed 'Engine Management ECU's' Input / Output circuit diagram.**

The design of Engine management ECU would require the use of both analog and digital hardware. Digital Hardware design is used to obtain optimum results. Microcontroller with on-chip RAM, Flash EEPROM is used for control and calculation of various parameters, along with other interfacing circuits for both analog and digital hardware. Inputs from sensors are converted by ADC into digital signals used by the microcontroller

to calculate various parameters. The following is the designed Engine Management ECU's Input / output circuit diagram.

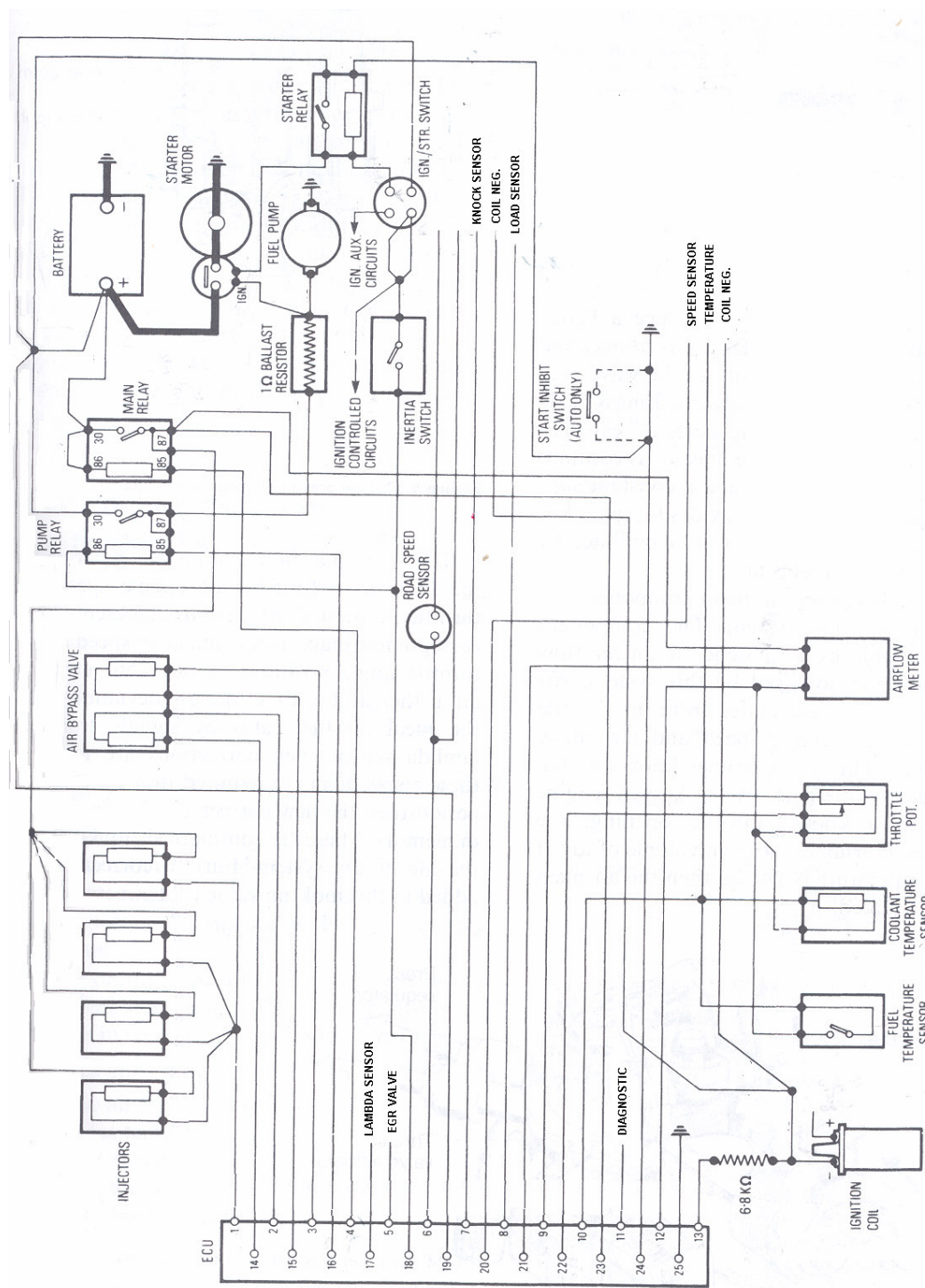

Fig.29. Proposed 'Engine Management ECU's' Input / Output circuit diagram.

This circuit diagram shows the I/O circuit of Engine management with following sections:

- (1) Electronic Starting system (the starting and charging system circuit diagram is same as shown previously), consisting of battery, starter motor, starter relay, starter / ignition switch, main relay to switch on the ECU controlled injection system.
- (2) Electronic ignition I/O circuit – consisting of ignition coil (distributor and spark plugs circuit is same as shown previously)
- (3) Electronic fuel I/O circuit – rest of the circuit, consisting of sensors, relay, Idle bypass valve, injectors, inertia switch, fuel pump etc.

The Engine management ECU would perform the following function.

1. Sense ignition on (input -pin18), then turn on the main relay (output -pin 4), acknowledgement received at (input -pin23).
2. Turn on the pump relay (output -pin 16)
3. Turn on the sensors (output -pin 12)
4. Fire ignition at appropriate time (output -pin 13)
5. Send supply voltage to Throttle sensor (output -pin9)
6. Sense air flow meter voltage (input -pin 21)
7. Sense throttle voltage (input -pin 22)
8. Sense temperature sensor voltage (input -pin 10)
9. Adjust idle speed by sending pulses to stepper motor of idle adjuster (output –pins 14, 2, 15, 3)
10. Turn on fuel injectors at appropriate time (output - pin 1)

## **5.2 On – Board Diagnostics (OBD)**

The different tools used in diagnosis are multimeter, oscilloscopes and engine analysers. Diagnosis tools such as dedicated equipment that can break in to the ECU wiring can be used. A further development could be the use of on-board diagnosis, with self-diagnosis circuits. The ECU monitors its inputs and outputs. This is done by both hardware circuits specially designed for diagnosis and programs for operating on the hardware signals. Signal ranges or values are allocated to all operating states of the sensors and actuators. If the signals deviate from normal, the ECU stores standard fault codes for both serious and

minor faults. In case of serious fault, a warning lamp will also be illuminated to alert the driver.

### Fault reading and erasing

Faults can be read as two digit numbers by shorting the diagnosis wire to earth for more than 2.5 seconds but less than 10 seconds. Earthing the wire for more than 10 secs will erase the fault memory, as does removing of the battery. These codes can be read out and the test procedure corresponding to that code be followed for faultfinding. Often, if the fault is not detected again for 50 starts of engine, the ECU erases the code automatically.

### Emergency / Default mode

In case of certain system failure fault detected by hardware circuit (Watchdog circuit), there will be an emergency mode, in which missing information is substituted with pre-programmed default values for safe operation.

## 5.3 Designed and Tested ‘Exhaust Gas Oxygen (EGO) Lambda Control’ Analog to Digital (ADC) circuit module

The lambda sensor produces a voltage proportional to oxygen content , i.e. proportional to AFR. At ideal AFR = 14.7:1 ( $\lambda = 1$ ), the output voltage = 475 mV. This is the self-designed circuit to convert the analog lambda voltage into digital signal to be handled by the microcontroller.

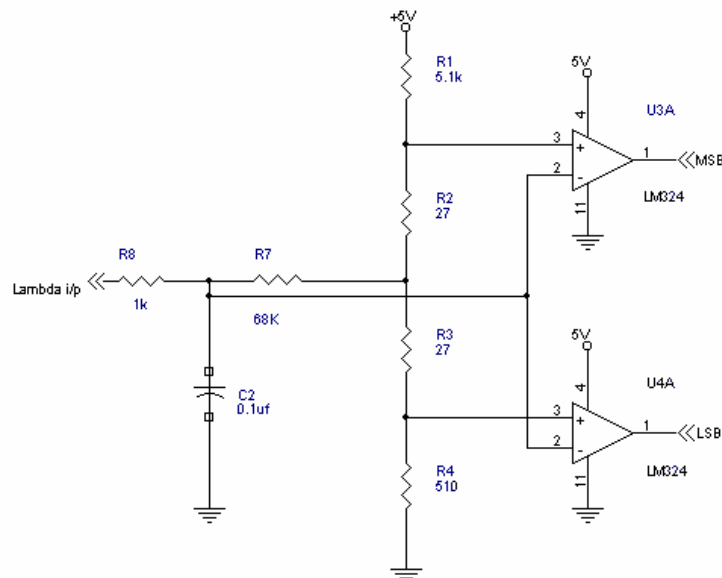

Mixture type	Lambda voltage	Circuit output voltage		Binary output
		Output MSB	Output LSB	
Rich	>0.5 V	0 V	0V	00
In between	0.45 V to 0.5 V	5V	0V	10
Lean	< 0.45 V	5V	5V	11

Fig.30. Self-designed (using OrCAD) and tested circuit diagram for conversion of analog lambda voltage into digital classification (i.e. rich, in between, lean)

The input is analog from lambda sensor, passed through a Low pass filter to remove noise above 1 Hz. There is a voltage divider network producing 0.45 V and 0.5 V as reference for the op-amp comparators. This leaves a  $\pm 25\text{mV}$  wide window between lean and rich. The outputs can interrupt the microcontroller. The control is done in following way. Starting with a slightly lean condition, the output is  $11_{\text{binary}}$ . The fuel is increased while changes in the output is monitored. As the output changes to  $10_{\text{binary}}$ , we enter the 50mV neutral area and continue incrementing the fuel level. When the output changes to  $00_{\text{binary}}$ , the fuel incrementing stops. There is a wait period. After the wait period is passed, the fuel level is decreased incrementally from  $00_{\text{binary}}$ , passing through  $10_{\text{binary}}$ , and  $11_{\text{binary}}$  and again it stops for a wait period. This cycle continues endlessly.

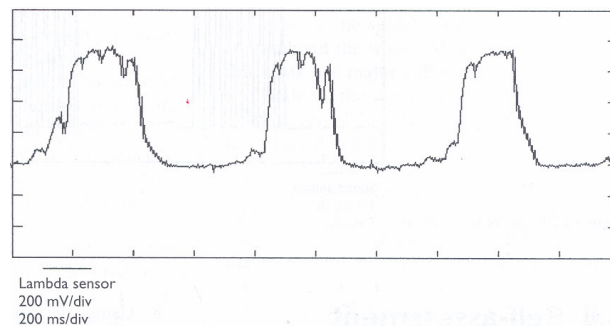

Fig.31. Lambda sensor output due to Lambda control.

## Chapter 6

### CONCLUSIONS AND WORK AHEAD

Thus it can be concluded that 'Electronic Engine Management' is the science of electronically equipping, controlling and calibrating an engine to maintain top performance and fuel economy while achieving cleanest possible exhaust stream, and continuously diagnosing system faults. The systems approach design indeed provide reduced design cycle time and cost-performance optimization., based on which the Engine management ECU is termed as an electronic system comprising of the following sections.

- (1) Electronic Charging, Alternator, and Engine starting system
- (2) Electronic Ignition system
- (3) Electronic Fuel system

These sections require use of both Analog and Digital Electronics for its realization. The various parameters not only depend on the basic factors but also on various other factors depending on the operational characteristics.

#### Work Ahead

After having completed the Design requirements, Analysis and proposing ideas for the design of Engine Management ECU, and also starting with the actual design in this I stage of the project, the following are the plans to be accomplished in the next stages

- 1) **Actual Electronic Hardware design** - The design would incorporate both analog interfacing and digital design. The proposed self designed and tested circuits, I/O circuit diagram of the ECU, and block diagrams would be the basis for design of the electronic circuits.
- 2) **Choosing the right microcontroller and Analog / Digital ICs** – Surveying various component and IC datasheets to chose proper microcontroller and other Interfacing ICs (Multiplexers, ADCs, Memory etc.) for best performance.
- 3) **Microcontroller** is used when the system requires many input / output operations, as in this ECU, because a microcontroller is designed to handle I/O with I/O ports.



The main processing and controlling would be done using microcontroller technology.

- 4) **Verification** – Verify the obtained outputs with the required outputs
- 5) **Testing hardware modules** – Each of the designed hardware modules would be tested for accurate performance
- 6) **Implementation** - Design of Printed Circuit Board (PCB) layout, artwork to achieve small size using SMD technology for microhybrid ECUs
- 7) **Microcontroller programming** based on the proposed flow charts
- 8) **Testing** – Testing the entire system for accurate performance
- 9) **Operation** - Thus after the design of Engine management ECU, this single Printed Circuit Board (PCB) connected to Input / output circuit would be used as engine starter, ignition and fuel system to provide optimum and efficient Electronic engine management.

## REFERENCES

- [1] Ronald Jurgen, *Automotive Electronics Handbook*, New York: Mc Graw Hill, 1999
- [2] Shuji Mizutani, *Car Electronics*, Japan: Nippondenso Co., Ltd., 1992
- [3] Robert Brady, *Automotive Electronics and Digital Instrumentation*, New Jersey: Printice Hall, Inc.,1988
- [4] Dick King, *Computerized Engine Controls*, New York: Delmar Publishers Inc.,1987
- [5] Tom Weathers and Claud Hunter, *Automotive Computers and Control systems*, New Jersey: Printice Hall, Inc.,1984
- [6] Tom Denton, *Automobile Electrical and Electronic Systems*, Warrendale: The Engineering Society for Advanced Mobility Land Sea Air and Space, SAE International, 2000
- [7] Joseph Gormley and Donald MacIsaac, “The systems design approach (better late than not at all)”, *IEEE Trans. on Electronic Applications in Transportation*, pp.401-412, Jan. 1989.
- [8] Thomas Beck, “Current trends in the Design of Automotive Electronic Systems”, *Proc. IEEE-SAE International Congress on Transportation Electronics*, pp.624-632, Aug. 2001
- [9] Richard Kovener, “A low cost Electronic Ignition system with microcontroller”, *Convergence '82*, vol. p-104, SAE 820256, 1982
- [10] M.P. Kraska, “Digital Linearization & Display of Non-Linear Analog (Sensors) Signals”, *IEEE Trans. on Electronic Applications in Transportation*, pp.45-52, Aug. 1988.
- [11] Brian Forster, “A Microprocessor controlled Overdrive for optimization of Fuel consumption”, *Convergence '82*, vol. p-104, SAE 820391, 1982

- [12] Tullio Cuatto, Claudia Passerone, Luciano Lavagno et al, "A case study in Embedded System Design: an Engine Control Unit", *IEEE Proceedings Of the International Workshop on Hardware Software Codesign*, pp.804-808, Jan. 1998.
- [13] Robert Straub, "Automotive Electronics IC Reliability", *IEEE Conference on Custom Integrated Circuits*, vol: 2, pp.19.2.1-19.2.4, Dec.1990
- [14] Luigi Glielmo, Francesco Vasca and Carlo Rossi, "Architecture for Electronic Control Unit tasks in Automotive Engine Control", *Proc. IEEE International Symposium on Computer-aided Control System Design, Alaska*, pp.42-48, Sept. 25-27, 2000
- [15] Y. Ohshima, M Ohsuga, T. Nogi and T. Minowa, "A Injection pattern system in a Spark Ignition Engine", SAE paper 910080 .1991
- [16] Myoungcho Sunwoo, Hansub Sim and Kangyune Lee, "Design and Development of an ECU and its Air-Fuel Ratio Control scheme", *Proc. IEEE-SAE International Congress on Transportation Electronics, Dearborn, MI*, pp.508-514, Jun. 1998
- [17] Koichi Murakami, Masahiko Shimamura and Norio Fujiki, "Development of a Digital Input Interface IC for Automotive Electronic Control Unit", *IEEE Trans. on Electronic Devices*, pp.124-128, Apr.1990
- [18] Wolfgang Ziebart, "Future Automotive Electronic Systems and their impact on solid-state circuits", *IEEE Conference on Solid-state Circuits*, pp. 20-23, 1992
- [19] John Kassakain, "Automotive Electronic systems – The Power Electronics of Future", *Proc. IEEE Conference on Industrial Electronics*, vol. 3, pp.3-10, Apr 2000
- [20] A. Balluchi, L.venuti, M.Di Benedetto et al, "Hybrid Systems and the Design of Electronic Controllers for Automotive Engine Management", *Proc. IEEE International Conference on Decision and Control*, vol. 2, pp.2656-2662, Dec 1998