

# **Desktop Systems**

# Spare parts for JavaStation Desktop

## Configuration Overview

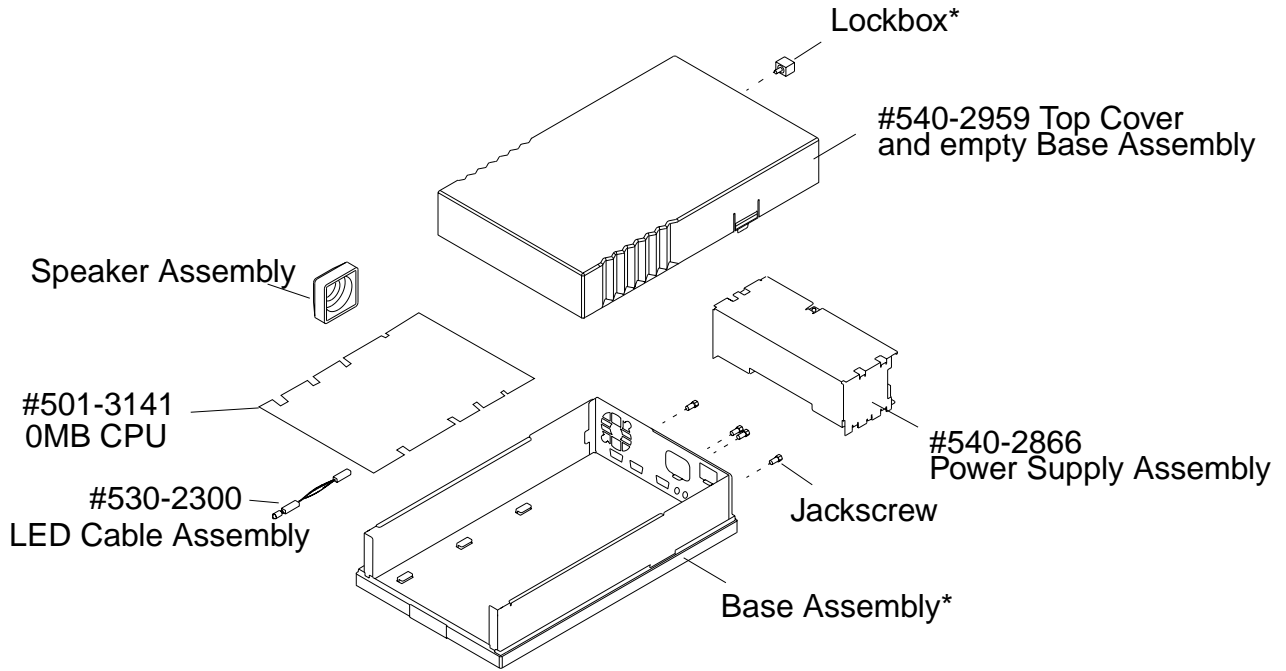

\* Spare not available

## Spare parts for JavaStation Desktop Model JJ-XX

Description	Order Number	Stocking Level		
		25	100	500
<b>System Boards and Modules</b>				
PCB, JAVA STATION	#501-3141	1	1	1
<b>Memory</b>				
JAVASTATION 32MB MEMORY	#501-4639	1	1	1
SIMM,4MB,60NS,JAVASTATION1+	#501-4188	1	1	1
SIMM,16MB,60NS,JAVASTATION 1+	#501-4216	1	1	1
<b>Monitors</b>				
14 DECAF JAVA MONITOR	#365-1388	1	1	1
MONITOR, 17 IN, 15PIN	#365-1354	1	1	1
14" COLOR MON, HD15 LOGOLESS	#365-1351	1	1	1
14 DECAF MONITOR LOGOLESS	#365-1389	1	1	1
MON,17CLR 15PIN VGA LOGOLESS	#365-1355	1	1	1
<b>Chassis, Cables and Accessories</b>				
CABLE, MON ADPTER HD15F/13W3M	#130-3034	1	1	1
CBL,MON ADAPTER,15HDM/13W3F	#530-2357	1	1	1
FLOPPY DC PWR FLTR CBL, 76MM	#530-2316	1	1	1
POWER SUPPLY, JAVA STN, JJ-xx	#540-2866	1	1	1
<b>Country Kits</b>				
MOUSE,PC	#370-2308	1	1	1
KEYBOARD, JAVA STATION US	#320-1256	1	1	1

**General Note**

Refer to the Reburished website <http://www.sun.com/ibb> for Remanufactured Parts List.

# Spare parts for JavaStation Tower

## Configuration Overview

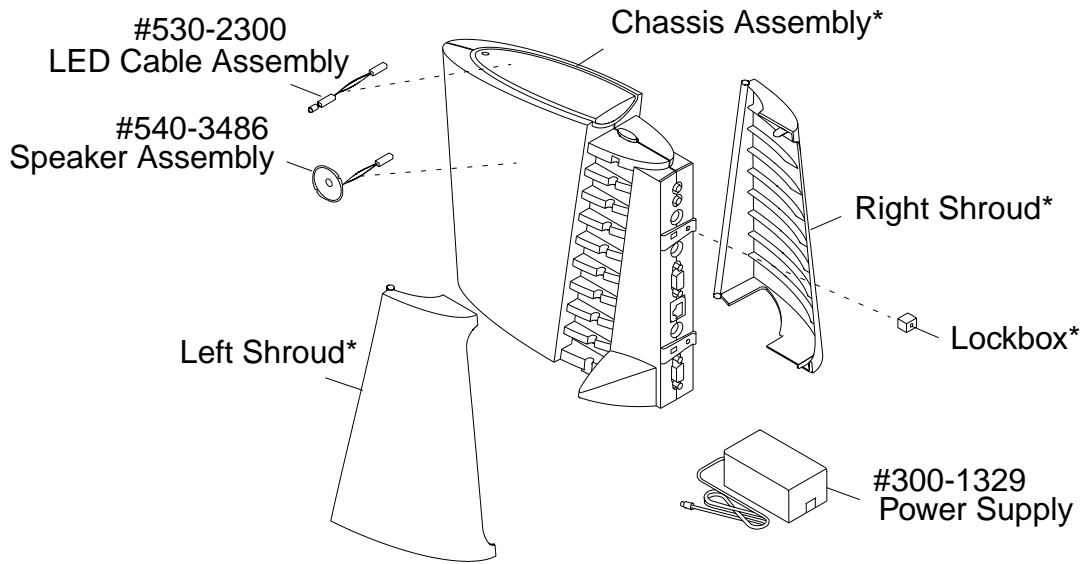

\* Spare not available

## Spare parts for JavaStation Tower Model JK-XX

Description	Order Number	Stocking Level		
		25	100	500
<b>System Boards and Modules</b>				
0MB CPU JAVAStation, JK-xx	#501-4267	1	1	1
<b>Memory and Mass Storage</b>				
JAVASTATION TOWER, 32MB,0MB FL	#595-4516	1	1	1
JAVASTN TWR, 32MB & 8MBFL	#595-4518	1	1	1
JavaStation FRU, 64MB, 0MB FL	#595-4519	1	1	1
JavaStation FRU, 64MB & 8MB FL	#595-4521	1	1	1
JAVASTATION 8MB FLASH MEMORY	#501-4732	1	1	1
JAVASTATION 32MB MEMORY	#501-4639	1	1	1
MEMORY,16MB DIMM,EDO-6,UNBFRD	#501-4637	1	1	1
FLASH-SIMM,4MB,3.3V,150NS	#501-4733	1	1	1
<b>Monitors</b>				
14 DECAF JAVA MONITOR	#365-1388	1	1	1
MONITOR, 17 IN, 15PIN	#365-1354	1	1	1
14" COLOR MON, HD15 LOGOLESS	#365-1351	1	1	1
MON,17CLR 15PIN VGA LOGOLESS	#365-1355	1	1	1
MONITOR, 19 INCH COLOR	#365-1380	1	1	1
14 DECAF MONITOR LOGOLESS	#365-1389	1	1	1
MON,17 ENTRY COLOR, 15-PIN	#365-1396	1	1	1
KEYBOARD, JAVA STATION US	#320-1256	1	1	1
KEYBOARD,PC,UK	#320-1257	1	1	1
KEYBOARD,PC,SWEDISH	#320-1258	1	1	1
KEYBOARD,PC,JAPANESE LOGOLESS	#320-1259	1	1	1
KEYBOARD,PC,JAPANESE,LOGOFUL	#320-1267	1	1	1
KEYBOARD,PC,GERMAN	#320-1260	1	1	1
KEYBOARD,PC,FRENCH	#320-1262	1	1	1
KEYBOARD,PC,ITALIAN	#320-1263	1	1	1
KEYBOARD,PC,TAIWANESE(CHINESE)	#320-1264	1	1	1
KEYBOARD,PC,SPANISH	#320-1265	1	1	1
KEYBOARD,PC,KOREAN	#320-1266	1	1	1
MOUSE,PC	#370-2308	1	1	1
<b>Chassis, Cables and Accessories</b>				
ASSY,SPEAKER/FRU,JAVAStn,JK-xx	#540-3486	1	1	1
PWR SUPPLY, JAVASTATION, JK-xx	#300-1329	1	1	1
JAVASTATION 8MB FLASH MEMORY	#501-4732	1	1	1
AC POWER CORD 115V US Sys-Mon	#180-1097	1	1	1
10/100 BASE-T CABLE,RJ45-RJ45	#530-1871	1	1	1
CABLE, MON ADPTER HD15F/13W3M	#130-3034	1	1	1
CBL,MON ADAPTER,15HDM/13W3F	#530-2357	1	1	1
FLOPPY DC PWR FLTR CBL, 76MM	#530-2316	1	1	1

### General Note

Refer to the Rebuilt website <http://www.sun.com/ibb> for Remanufactured Parts List.

# Spare parts for SPARCstation 4

## Configuration Overview

SS4 Netrai4 Netrai400 Netraj4  
1-Slot SBus Logic Enclosure

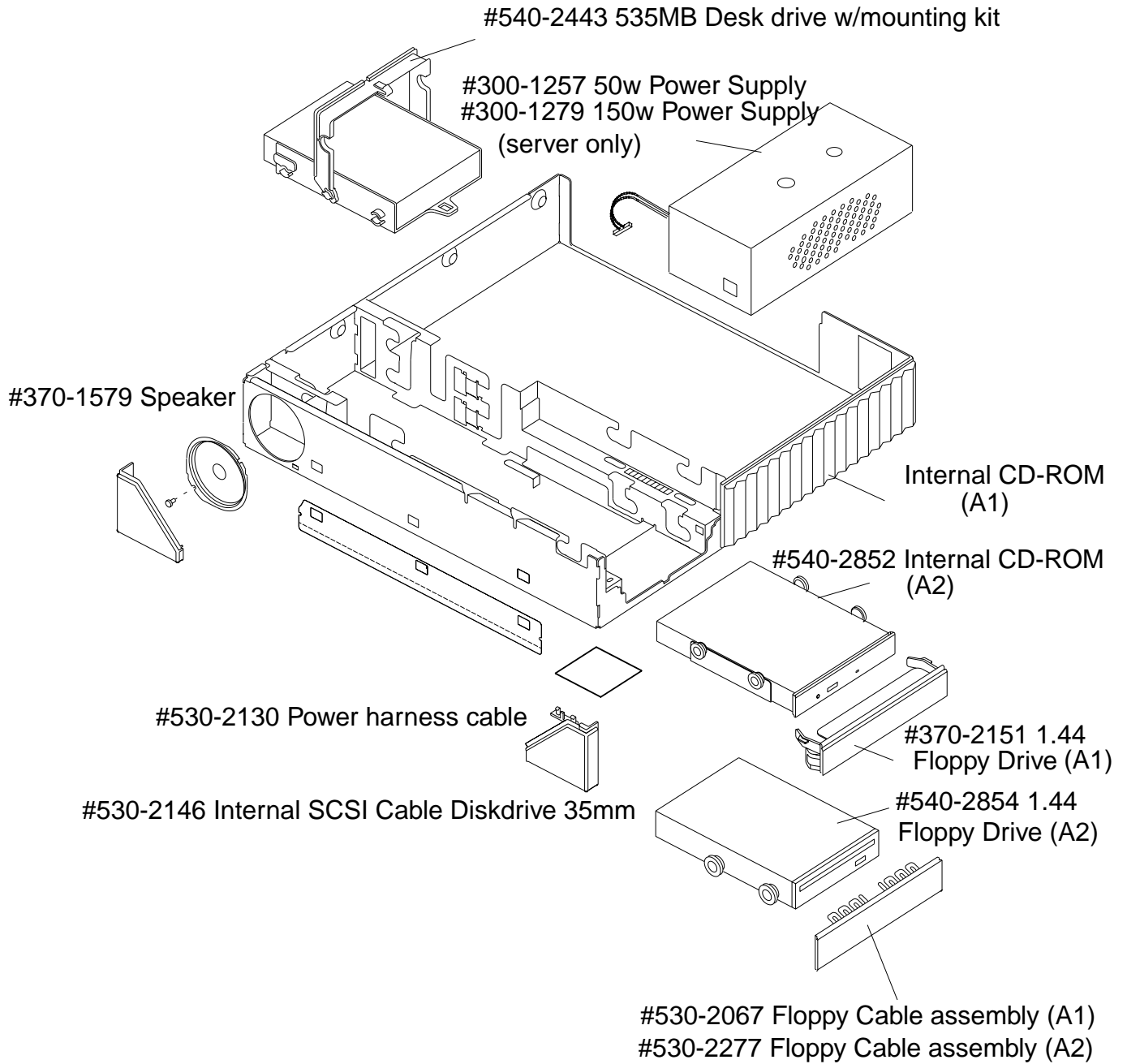

A1 = Old Chassis (through Nov/Dec 1996)  
A2 - New Chassis (phased in July 1996)

Notes: 1 SBus slot only  
No MBus modules (onboard CPU)

## Spare parts for SPARCstation 4 (continued)

Description	Order Number	Stocking Level		
		25	100	500
<b>System Boards and Modules</b>				
S4 0MB 70MHZ CPU BOARD	#501-3002	1	5	7
S4 0MB 85MHZ CPU BOARD	#501-2928	1	3	7
S4 0MB 110MHZ CPU BOARD	#501-3134	1	3	7
<b>Graphics</b>				
TURBOGX GRAPHICS BOARD	#501-2922	1	1	2
RFB TGX FRAMEBUFFER	RFB501-2325	1	1	2
TURBOGXPLUS GRAPHICS BOARD	#501-2955	1	1	2
RFB 4MB TGX+ FRAMEBUFFER	RFB501-2253	1	1	2
<b>Memory and Mass Storage and Accessories</b>				
32MB SIMM, 4MX66DEPOP	#501-2471	1	1	3
535MB SINGLE CONNETOR W/KIT	#540-2443	1	1	3
1GB Q DRV VIBRATION KIT,SS4	#540-3346	2	6	26
3D FLOPPY DRIVE	#370-3212	1	2	6
1.44MB, 3.5 INCH THIN FLOPPY	#540-2854	1	2	6
SUN4 CDROM DRIVE, AURORA2	#540-2852	1	2	6
SWIS/S SINGLE-ENDED SCSI2 ADAP	#370-1703	1	2	6
<b>Monitors</b>				
20" COLOR MONITOR W/13W3 CABLE	#365-1335	1	2	10
MONITOR, 19 INCH COLOR	#365-1380	1	3	12
MONITOR, 17 IN, 15PIN	#365-1354	1	3	12
<b>Country Kits</b>				
FRU,KYBD,TYPE 6,SUN I/O,US	#320-1270	1	2	6
COMPACT MOUSE	#370-1586	1	2	6
RUBBER MOUSE PAD	#370-2038	1	1	1
ELECTRO CONDENSOR MICROPHONE	#370-1678	1	1	1

### General Note

Refer to the Reburished website <http://www.sun.com/ibb> for Remanufactured Parts List.

## Spare parts for SPARCstation 4 *(continued)*

Description	Order Number	Stocking Level		
		25	100	500
<b>Chassis, Cables and Accessories</b>				
50W POWER SUPPLY	#300-1257	1	2	6
150W POWER SUPPLY	#300-1279	1	2	6
PERIPHERAL POWER HARNESS CBL	#530-2130	1	1	1
FLOPPY CABLE ASSEMBLY	#530-2067	1	1	1
AC POWER CORD 115V US Sys-Mon	#180-1097	1	1	1
SPEAKER	#370-1579	1	1	1
NVRAM, S4/S5	#525-1369	1	1	1
10/100 BASE-T CABLE,RJ45-RJ45	#530-1871	1	1	1
AUDIO CABLE FOR SS5	#530-2079	1	1	1
SPEAKER/LED POWER CABLE	#530-2080	1	1	1
INT. SCSI CBL, DISK DR.,33MM	#530-2146	1	1	1
AUDIO MODULE, SS4/XTERM 1	#501-2592	1	1	1
INT SCSI CBL, CD-ROM, 350MM	#530-2129	1	1	1
CABLE, FLOPPY, INT, 350MM	#530-2277	1	1	1
CLB, DC WIRE HARNESS, SS4	#530-2302	1	1	1
CD ROM TO CPU AUDIO CBL,435MM	#530-2280	1	1	1
SPEAKER 7 LED WIRE HARNESS	#530-2341	1	1	1



# Spare parts for SPARCstation 5

## Configuration Overview

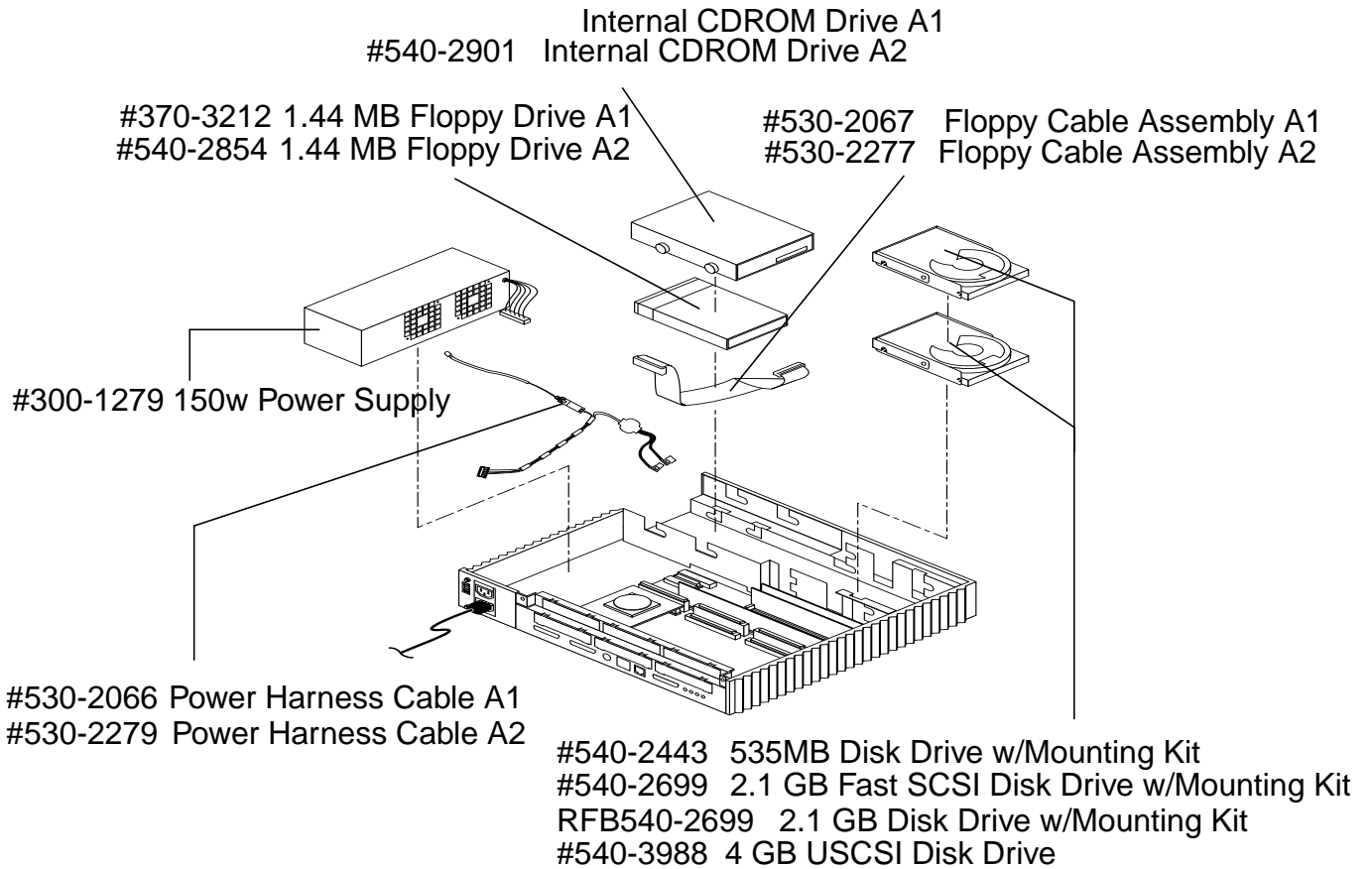

A1 = Old Chassis (through Nov/Dec 1996)

A2 - New Chassis (phased in July 1996)

Notes: 3 SBus slot only  
No MBus modules (onboard CPU)

**Spare parts for SPARCstation 5** *(continued)*

Description	Order Number	Stocking Level		
		25	100	500
<b>System Boards and Modules</b>				
S5+ 0MB 170MHZ CPU BOARD	#501-3059	1	3	10
S5 0MB 110MHZ CPU BOARD	#501-2778	1	3	14
SS5 0MB 85MHZ CPU BOARD	#501-2815	1	3	14
<b>Graphics</b>				
TURBOGX GRAPHICS BOARD	#501-2922	1	1	2
RFB TGX FRAMEBUFFER	RFB501-2325	1	1	2
TURBOGXPLUS GRAPHICS BOARD	#501-2955	1	1	2
RFB 4MB TGX+ FRAMEBUFFER	RFB501-2253	1	1	2
S24 FRAMEBUFFER CARD	#501-2337	1	2	9
S5 CG3 COLOR FRAMEBUFFER	#501-2691	1	1	2
ZX FRAME BUFFER BOARD	#501-1845	1	2	9
<b>Memory and Mass Storage and Accessories</b>				
32MB SIMM, 4MX66DEPOP	#501-2471	1	1	3
535MB SINGLE CONNETOR W/KIT	#540-2443	1	1	3
RFB 2.1GB SCSI DRIVE W/KIT	RFB540-2699	1	1	3
3D FLOPPY DRIVE	#370-3212	1	2	6
12X CD-ROM LIGHT GREY	#370-2816	1	2	6
CDROM 12X, INT WITH BRACKET A2	#540-2901	1	2	6
8MB SIMM,1MX72	#501-2470	1	2	6
1.44MB, 3.5 INCH THIN FLOPPY	#540-2854	1	2	6
SUN4 CDROM DRIVE, AURORA2	#540-2852	1	2	6
4GB 1,USCSI,W/AURORA BKT,FRU	#540-3988	1	2	6
9GB Disk Dr,Fujitsu MAB3091SC	#370-3413	1	2	6
SWIS/S SINGLE-ENDED SCSI2 ADAP	#370-1703	1	2	6
<b>Monitors</b>				
MONITOR, 17 IN, 15PIN	#365-1354	1	2	10
20" COLOR MONITOR W/13W3 CABLE	#365-1335	1	2	10
MONITOR, 19 INCH COLOR	#365-1380	1	3	12
MONITOR, 21 IN COLOR W/ CABLE	#365-1383	1	3	12
RFB 15" COLOR MONITOR, DB13W3	RFB365-1286	2	6	27
CABLE, MON ADPTER HD15F/13W3M	#130-3034	1	1	1
<b>Country Kits</b>				
FRU,KYBD,TYPE 6,SUN I/O,US	#320-1270	1	2	6
RUBBER MOUSE PAD	#370-2038	1	1	1
COMPACT MOUSE	#370-1586	1	2	6
ELECTRO CONDENSOR MICROPHONE	#370-1678	1	1	1

**General Note**

Refer to the Reburished website <http://www.sun.com/ibb> for Remanufactured Parts List.

## Spare parts for SPARCstation 5 *(continued)*

Description	Order Number	Stocking Level		
		25	100	500
<b>Chassis, Cables and Accessories</b>				
150W POWER SUPPLY	#300-1279	1	2	6
DC WIRE HARNESS CABLE ASSY	#530-2066	1	1	1
FLOPPY CABLE ASSEMBLY	#530-2067	1	1	1
AC POWER CORD 115V US Sys-Mon	#180-1097	1	1	1
NVRAM, S4/S5	#525-1369	1	1	1
10/100 BASE-T CABLE,RJ45-RJ45	#530-1871	1	1	1
AUDIO CABLE FOR SS5	#530-2079	1	1	1
SPEAKER	#370-1579	1	1	1
S5/S20 SCSI BOARD	#501-2462	1	1	1
SPEAKER/LED POWER CABLE	#530-2080	1	1	1
SS20/SS5 SCSI CABLE, 660MM	#530-2053	1	1	1
CABLE, FLOPPY, INT, 350MM	#530-2277	1	1	1
SCSI CBL, 485MM, SS5/SS20	#530-2278	1	1	1
PWR DC HARNES, SS5/SS20	#530-2279	1	1	1
CD ROM TO CPU AUDIO CBL,435MM	#530-2280	1	1	1
SPEAKER 7 LED WIRE HARNESS	#530-2341	1	1	1
FLOPPY DC PWR FLTR CBL, 76MM	#530-2316	1	1	1

# Spare parts for SPARCstation 10

## Configuration Overview

Parts will transition off the Spares Pricebook November 2000

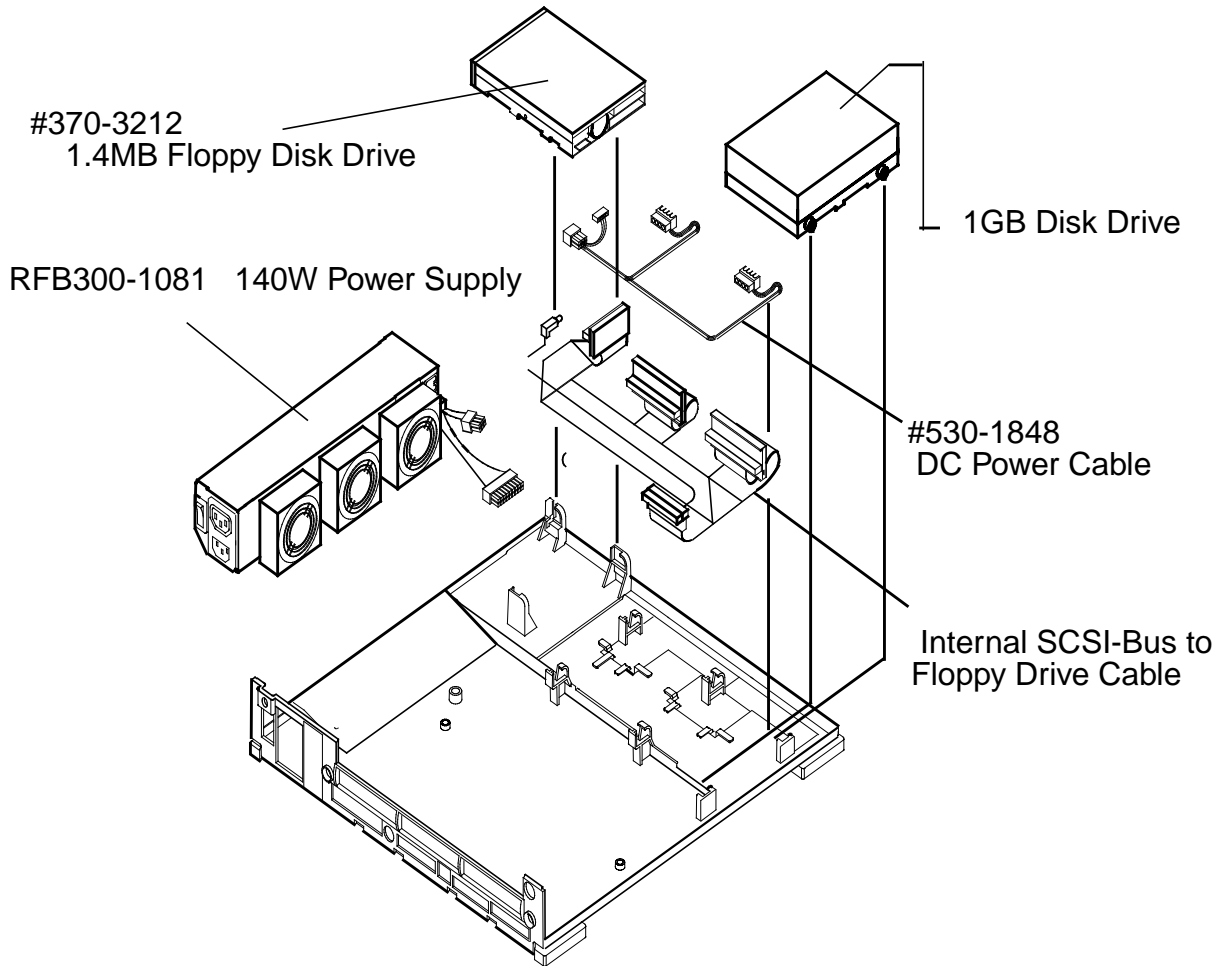

## Spare parts for SPARCstation 10 *(continued)*

Description	Order Number	Stocking Level		
		25	100	500
<b>System Boards and Modules</b>				
SM51 SPARC MODULE	#501-2754	1	1	2
SM512 SPARC MODULE	#501-2780	1	1	2
SM61 SPARC MODULE	#501-2825	1	1	2
150MHZ HYPERSPARC MODULE	#370-2162	1	1	2
HS21 125MHZ MODULE	#370-1865	1	1	2
HS11 100MHZ HYPERSPARC MODULE	#370-1866	1	1	2
<b>Graphics</b>				
RFB CG6 FRM BFR,DB13W3,66/76HZ	RFB501-1996	1	1	2
ZX FRAME BUFFER BOARD	#501-1845	1	2	6
TURBOGX GRAPHICS BOARD	#501-2922	1	1	2
RFB TGX FRAMEBUFFER	RFB501-2325	1	1	2
TURBOGXPLUS GRAPHICS BOARD	#501-2955	1	1	2
RFB 4MB TGX+ FRAMEBUFFER	RFB501-2253	1	1	2
4MB VSIMM	#501-2306	1	1	2
NVRAM SIMM, 2MB, SS-10 TSTD	#501-2001	1	1	2
<b>Memory and Mass Storage</b>				
RFB 64MB SIMM, SS10	RFB501-1930	1	3	3
MEMORY,DSIMM,64MB,60NS,S10/S20	#501-2480	1	1	2
3D FLOPPY DRIVE	#370-3212	1	1	1
MEMORY,DSIMM,16MB,60NS,S20	#501-2479	1	1	3

**General Note**

Refer to the Reburished website <http://www.sun.com/ibb> for Remanufactured Parts List.

## Spare parts for SPARCstation 10 *(continued)*

Description	Order Number	Stocking Level		
		25	100	500
<b>Monitors</b>				
20" COLOR MONITOR W/13W3 CABLE	#365-1335	1	2	10
MONITOR, 19 INCH COLOR	#365-1380	1	3	12
MONITOR, 17 IN, 15PIN	#365-1354	1	3	12
RFB 15" COLOR MONITOR, DB13W3	RFB365-1286	1	2	6
<b>Country Kits</b>				
FRU,KYBD,TYPE 6,SUN I/O,US	#320-1270	1	2	6
RUBBER MOUSE PAD	#370-2038	1	1	1
COMPACT MOUSE	#370-1586	1	2	6
ELECTRO CONDENSOR MICROPHONE	#370-1678	1	1	1
<b>Chassis, Cables and Accessories</b>				
RFB 140W POWER SUPPLY	RFB300-1081	1	2	6
DC POWER HARNESS	#530-1848	1	1	1
AC POWER CORD 115V US Sys-Mon	#180-1097	1	1	1
BOOT PROM KIT, SS10	#525-1183	1	1	1
NVRAM KIT FOR SS10	#525-1184	1	1	1
BOOT PROM KIT, S10, HS11/21	#525-1383	1	1	1
SHIP KIT, FILLER PANEL S10/S20	#560-1937	1	1	1

**General Note**

Refer to the Reburished website <http://www.sun.com/ibb> for Remanufactured Parts List.

# Spare parts for SPARCstation 20

## Configuration Overview

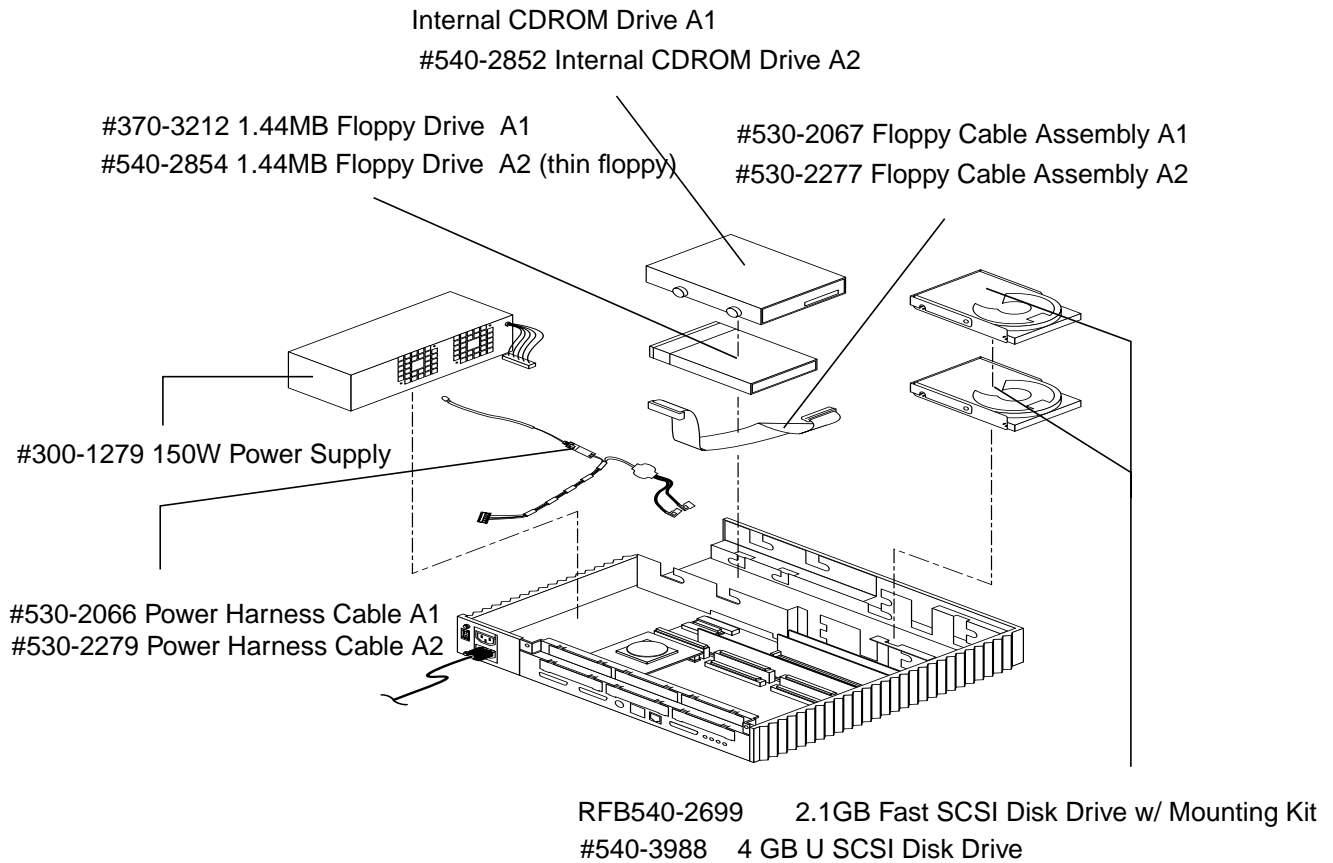

A1 = Old Chassis (through Nov/Dec 1996)  
A2 - New Chassis (phased in July 1996)

## Spare parts for SPARCstation 20 (continued)

Description	Order Number	Stocking Level		
		25	100	500
<b>System Boards and Modules</b>				
0MB/0CPU SYSTEM BOARD, SS20	#501-2924	1	2	10
SM50 SUPERSPARC MODULE	#501-2708	1	1	2
SM51 SPARC MODULE	#501-2754	1	1	2
SM61 SPARC MODULE	#501-2825	1	1	2
SM512 SPARC MODULE	#501-2780	1	1	2
SM71 SUPERSPARC MODULE	#501-2925	1	1	2
150MHZ HYPERSPARC MODULE	#370-2162	1	1	2
HS21 125MHZ MODULE	#370-1865	1	1	2
HS11 100MHZ HYPERSPARC MODULE	#370-1866	1	1	2
MODULE, 85MHZ, 1MB, SS1000E	#501-4810	1	1	2
<b>Graphics</b>				
TURBOGX GRAPHICS BOARD	#501-2922	1	1	2
RFB TGX FRAMEBUFFER	RFB501-2325	1	1	2
TURBOGXPLUS GRAPHICS BOARD	#501-2955	1	1	2
RFB 4MB TGX+ FRAMEBUFFER	RFB501-2253	1	1	2
ZX FRAME BUFFER BOARD	#501-1845	1	2	9
AUX VIDEO BOARD	#501-2488	1	1	2
<b>Memory and Mass Storage and Accessories</b>				
4GB 1,USCSI,W/AURORA BKT,FRU	#540-3988	1	1	3
MEM,DSIMM,32MB,60NS,S20,S10	#501-2622	1	1	3
9GB Disk Dr,Fujitsu MAB3091SC	#370-3413	1	1	3
RFB 32MB SIMM, 60NS, S20	RFB501-2622	1	1	3
MEMORY,DSIMM,64MB,60NS,S10/S20	#501-2480	1	1	2
RFB 2.1GB SCSI DRIVE W/KIT	RFB540-2699	1	1	3
NVRAM SIMM, 2MB, SS-10 TSTD	#501-2001	1	1	2
1.44MB, 3.5 INCH THIN FLOPPY	#540-2854	1	2	6
3D FLOPPY DRIVE	#370-3212	1	2	6
SUN4 CDROM DRIVE, AURORA2	#540-2852	1	2	6
SWIS/S SINGLE-ENDED SCSI2 ADAP	#370-1703	1	2	6
FLOPPY FILLER PANEL W/CUTOUT	#540-2552	1	2	6

### General Note

Refer to the Rebuilt website <http://www.sun.com/ibb> for Remanufactured Parts List.



## Spare parts for SPARCstation 20 *(continued)*

Description	Order Number	Stocking Level		
		25	100	500
<b>Monitors</b>				
20" COLOR MONITOR W/13W3 CABLE	#365-1335	1	2	10
MONITOR, 19 INCH COLOR	#365-1380	1	3	12
MONITOR, 17 IN, 15PIN	#365-1354	1	3	12
RFB 15" COLOR MONITOR, DB13W3	RFB365-1286	2	6	27
<b>Country Kits</b>				
FRU,KYBD,TYPE 6,SUN I/O,US	#320-1270	1	2	6
COMPACT MOUSE	#370-1586	1	2	6
ELECTRO CONDENSOR MICROPHONE	#370-1678	1	1	1
RUBBER MOUSE PAD	#370-2038	1	1	1
<b>Chassis, Cables and Accessories</b>				
150W POWER SUPPLY	#300-1279	1	2	6
AC POWER CORD 115V US Sys-Mon	#180-1097	1	1	1
SPEAKER	#370-1579	1	1	1
SPARCSTATION20 BOOT PROM KIT	#525-1377	1	1	1
DC WIRE HARNESS CABLE ASSY	#530-2066	1	1	1
TURBOZX CABLE ASSY	#530-2165	1	1	1
S5/S20 SCSI BOARD	#501-2462	1	1	1
SPEAKER/LED POWER CABLE	#530-2080	1	1	1
SS20/SS5 SCSI CABLE, 660MM	#530-2053	1	1	1
S20 DISK DRIVE FAN CABLE	#530-2159	1	1	1
SS20 FAN ASSY, 4CFM	#540-2640	1	2	6
CABLE, FLOPPY, INT, 350MM	#530-2277	1	1	1
SCSI CBL, 485MM, SS5/SS20	#530-2278	1	1	1
PWR DC HARNES, SS5/SS20	#530-2279	1	1	1
CD ROM TO CPU AUDIO CBL,435MM	#530-2280	1	1	1
FLOPPY DC PWR FLTR CBL, 76MM	#530-2316	1	1	1

**General Note**

Refer to the Reurbished website <http://www.sun.com/ibb> for Remanufactured Parts List.

# Spare parts for SPARCstation Voyager

## Configuration Overview

Parts will transition off the Spares Pricebook November 2000

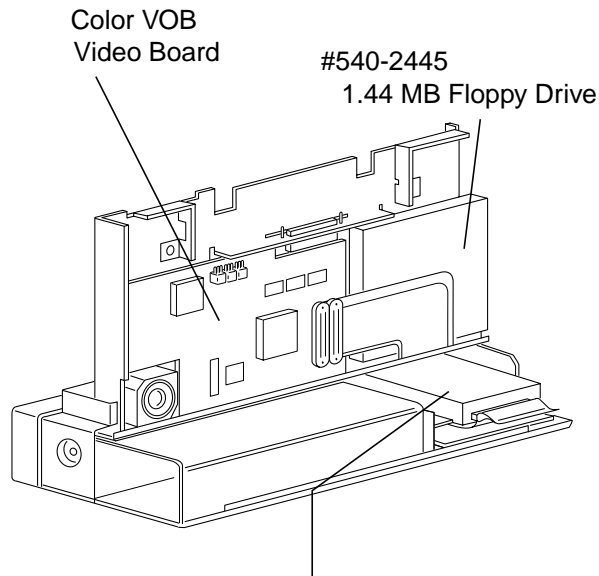
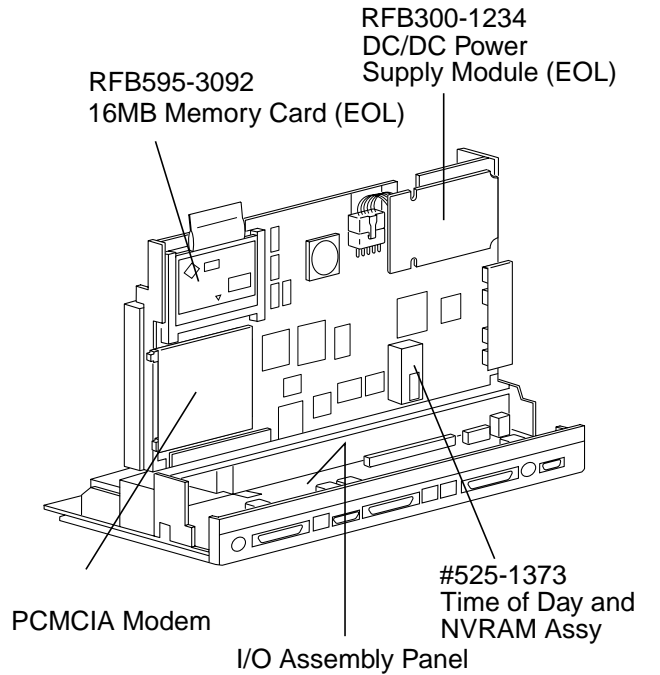

## Spare parts for SPARCstation Voyager *(continued)*

Description	Order Number	Stocking Level		
		25	100	500
<b>System Boards and Modules</b>				
VOYAGER CPU W/16MB MEMORY	#501-2685	2	8	38
<b>Memory and Mass Storage</b>				
1.44MB FLOPPY DRIVE	#540-2445	1	5	11
<b>Monitors</b>				
AMLCD COLOR DISPLAY	#540-2452	1	1	2
AMLCD MONOCHROME DISPLAY	#540-2453	1	1	2
MONITOR, 19 INCH COLOR	#365-1380	1	3	12
<b>Country Kits</b>				
FRU,KYBD,TYPE 6,SUN I/O,US	#320-1270	1	2	6
COMPACT MOUSE	#370-1586	1	1	1
RUBBER MOUSE PAD	#370-2038	1	1	1
<b>Chassis, Cables and Accessories</b>				
1.5M KEYBOARD CABLE	#530-2123	1	1	1
VOYAGER POWER CABLE, US	#530-2076	1	1	1
ELECTRO CONDENSOR MICROPHONE	#370-1678	1	1	1
10/100 BASE-T CABLE,RJ45-RJ45	#530-1871	1	1	1
NVRAM/TOD ASSY, VOYAGER	#525-1373	1	1	1
HARD DRIVE CABLE	#530-2062	1	1	1
FLEXIBLE CIRCUIT CABLE	#530-2049	1	1	1
EXTERNAL DC POWER CABLE	#530-2063	1	1	1

**General Note**

Refer to the Rebuilt website <http://www.sun.com/ibb> for Remanufactured Parts List.

# Spare parts for Sun Ultra 1 Models 140/170

## Configuration Overview 3 Slot SBus Logic Enclosure

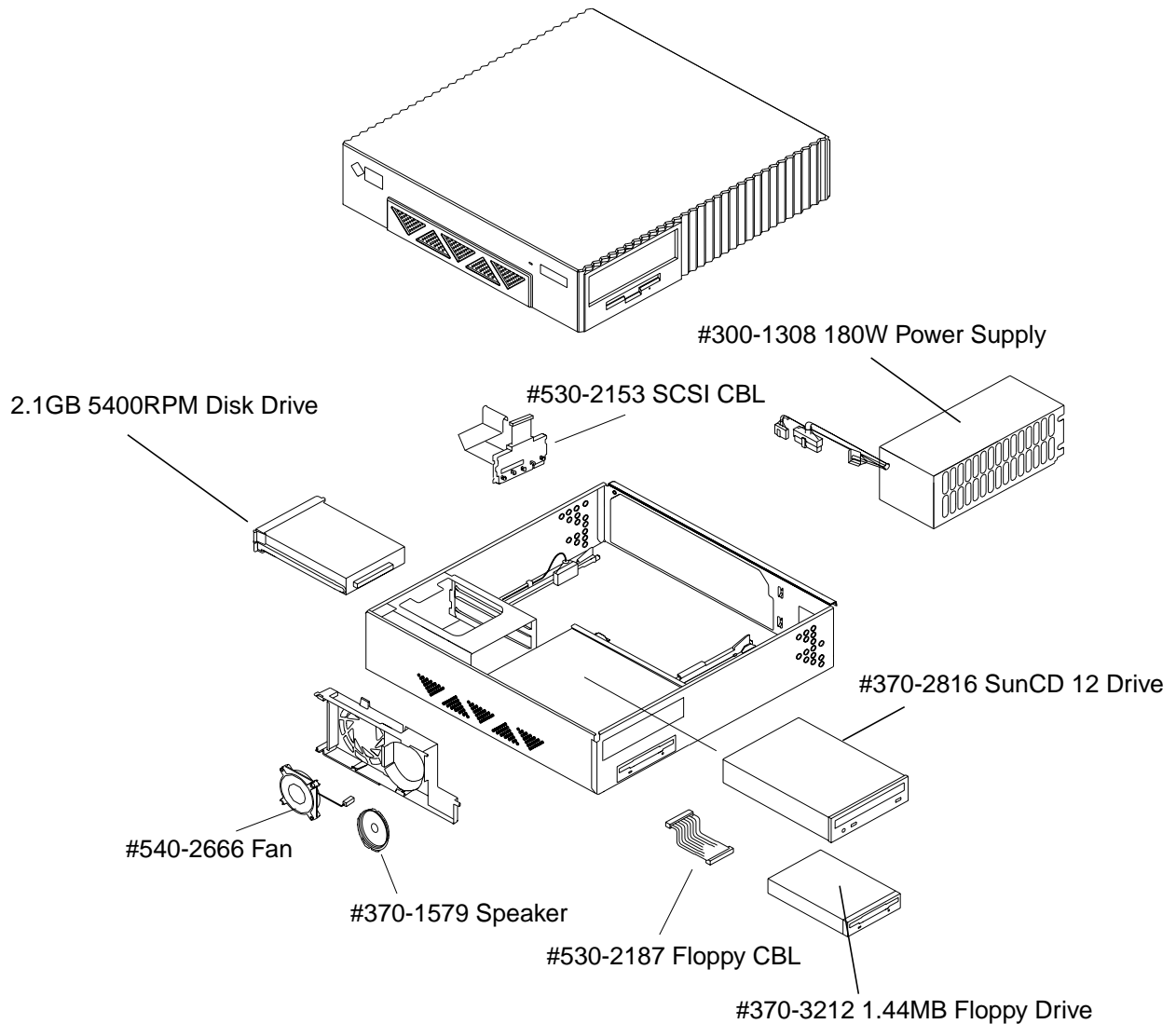

# Spare parts for Sun Ultra 1 Models 140 and 170 (A11)

(continued)

Description	Order Number	Stocking Level		
		25	100	500
<b>System Boards and Modules</b>				
0MB ULTRA1 MODEL 170 SYSTEM BD	#501-3082	1	2	6
<b>Graphics</b>				
TURBOGX GRAPHICS BOARD	#501-2922	1	1	1
RFB TGX FRAMEBUFFER	RFB501-2325	1	1	1
TURBOGXPLUS GRAPHICS BOARD	#501-2955	1	1	1
CAMERA II ASSY, US/NTSC	#595-3723	1	1	1
ZX ULTRA1 KIT	#595-4072	1	1	1
TURBOGXPLUS GRAPHICS BOARD	#501-2955	1	1	2
TURBOGX GRAPHICS BOARD	#501-2922	1	1	2
<b>Memory and Mass Storage and Accessories</b>				
7-14GB 8MM TAPE DRIVE	#370-2881	1	1	2
MEM,DSIMM,32MB,60NS,S20,S10	#501-2622	1	1	3
RFB 32MB SIMM, 60NS, S20	RFB501-2622	1	1	3
MEMORY,DSIMM,64MB,60NS,S10/S20	#501-2480	1	1	3
128MB DIMM, 60NS, ULTRA2	#501-3136	1	1	3
2.1GB 7200RPM DISK DRIVE ASSY	#540-2936	1	1	3
2.1GB 5400RPM DISK DRIVE ASSY	#540-3171	1	1	3
2.5GB 1/4in QIC TAPE DRIVE	#370-2018	1	1	2
12/24GB 4mm DDS3 TAPE DRIVE	#370-2377	1	1	2
12X CD-ROM LIGHT GREY	#370-2816	1	4	18
DRV,4/8GB DDS2-CR TAPE,LT GREY	#370-2375	1	1	1
14GB, 8MM 1/2 HI GREY TAPE	#370-1857	1	1	3
3D FLOPPY DRIVE	#370-3212	1	1	3
SWIS/S SINGLE-ENDED SCSI2 ADAP	#370-1703	1	1	3
4.2GB 7200RPM Disk Drive Assy	#540-2938	1	1	3
2.1GB 7200RPM DISK DRIVE ASSY	#540-2936	1	1	3
<b>Monitors</b>				
CABLE, MON ADPTER HD15F/13W3M	#130-3034	1	1	1
20" COLOR MONITOR W/13W3 CABLE	#365-1335	1	1	1
MONITOR, 17 IN, 15PIN	#365-1354	1	2	6
MONITOR, 19 INCH COLOR	#365-1380	1	2	6
125VAC POWER CORD,6FT US JAPAN	#180-1179	1	1	10
CLR EXT CBL,3M,DB13W3M-DB13W3F	#530-2020	1	1	6
<b>Country Kits</b>				
FRU,KYBD,TYPE 6,SUN I/O,US	#320-1270	1	2	6
COMPACT MOUSE	#370-1586	1	1	1
RUBBER MOUSE PAD	#370-2038	1	1	1
TYPE 5/6 KYBD EXTENDER CABLE	#530-2154	1	2	6

**General Note**Refer to the Rebuilt website <http://www.sun.com/ibb> for Remanufactured Parts List.

## Spare parts for Sun Ultra 1 Models 140 and 170 (A11)

(continued)

Description	Order Number	Stocking Level		
		25	100	500
<b>Chassis, Cables and Accessories</b>				
180W POWER SUPPLY E150 & ULTRA	#300-1308	1	1	1
PWR SUPPLY,350W,ULTRA2,A14	#300-1342	1	1	1
ULTRA 1/30 TIMEKEEPER PROM	#525-1430	1	1	1
PERIPHERAL DATA CABLE, 410MM	#530-2153	1	1	1
ULTRA SPEAKER/LED WIRE HRNESS	#530-2175	1	1	1
PERIPHERAL & FAN WIRE HRNESS	#530-2176	1	1	1
FLOPPY DATA CBL, 205MM ULTRA 1	#530-2187	1	1	1
FLOPPY CABLE, 320MM, ULTRA 2	#530-2138	1	1	1
INTERNAL SCSI CABLE, 660mm	#530-2137	1	1	1
CPU SHROUD ASSY/FRU	#540-2603	1	1	1
ULTRA DRIVE FAN ASSEMBLY	#540-2666	1	1	2
ULTRA 1 CPU MODULE FAN ASSY	#540-2761	1	1	2
10/100 BASE-T CABLE,RJ45-RJ45	#530-1871	1	1	1
SPEAKER	#370-1579	1	1	1
CDROM FILLER PANEL	#540-2701	1	1	1
SPEAKER ASSEMBLY, ULTRA 1	#540-2710	1	1	1

# Spare parts for Sun Ultra 1 Models 140E, 170E and 200E (A12)

## Configuration Overview 2 Slot SBus Logic Enclosure

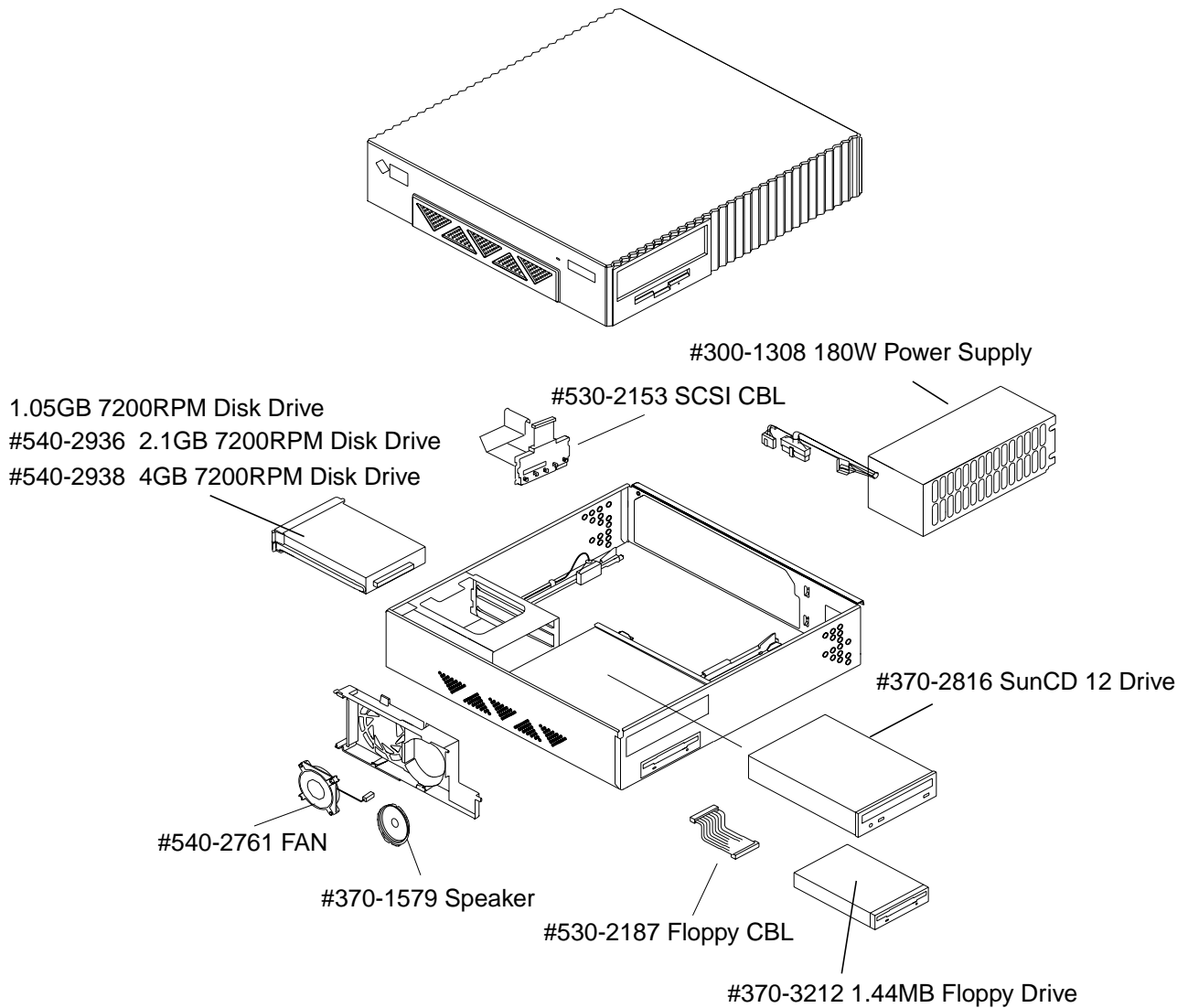

## Spare parts for Sun Ultra 1 Models 140E, 170E and 200E (A12) *(continued)*

Description	Order Number	Stocking Level		
		25	100	500
<b>System Boards and Modules</b>				
0MB SYSTEM BOARD, 200MHZ, A12	#501-4358	1	1	2
0MB SYSTEM BOARD, 167MHZ A12	#501-4676	1	1	2
0MB ULTRA1 MODEL 170 SYSTEM BD	#501-3082	1	1	2
<b>Graphics</b>				
FFB2,DBZ-HORIZONTAL	#501-4173	1	1	1
CREATOR 3D GRAPHIS, SPEEDSORT	#501-3129	1	1	1
CREATOR3D GRAPHICS FRAMEBUFFER	#501-4126	1	1	1
CREATOR GRAPHICS FRAMEBUFFER	#501-4127	1	1	1
CAMERA II ASSY, US/NTSC	#595-3723	1	1	1
ZX ULTRA1 KIT	#595-4072	1	1	1
TURBOGXPLUS GRAPHICS BOARD	#501-2955	1	1	2
TURBOGX GRAPHICS BOARD	#501-2922	1	1	2
<b>Memory and Mass Storage</b>				
7-14GB 8MM TAPE DRIVE	#370-2881	1	1	2
12/24GB 4mm DDS3 TAPE DRIVE	#370-2377	1	1	2
MEM,DSIMM,32MB,60NS,S20,S10	#501-2622	1	1	3
RFB 32MB SIMM, 60NS, S20	RFB501-2622	1	1	3
MEMORY,DSIMM,64MB,60NS,S10/S20	#501-2480	1	1	3
2.1GB 7200RPM DISK DRIVE ASSY	#540-2936	1	1	1
2.1GB 5400RPM DISK DRIVE ASSY	#540-3171	1	1	3
4.2GB 7200RPM Disk Drive Assy	#540-2938	1	1	3
3D FLOPPY DRIVE	#370-3212	2	6	10
12X CD-ROM LIGHT GREY	#370-2816	1	4	18
DRV,4/8GB DDS2-CR TAPE,LT GREY	#370-2375	1	1	1
128MB DIMM, 60NS, ULTRA2	#501-3136	1	1	1
<b>Monitors</b>				
MONITOR, 21 IN COLOR W/ CABLE	#365-1383	1	1	1
CABLE, MON ADPTER HD15F/13W3M	#130-3034	1	1	1
20" COLOR MONITOR W/13W3 CABLE	#365-1335	1	1	1
MONITOR, 17 IN, 15PIN	#365-1354	1	2	6
MONITOR, 19 INCH COLOR	#365-1380	1	2	6
125VAC POWER CORD,6FT US JAPAN	#180-1179	1	1	10
CLR EXT CBL,3M,DB13W3M-DB13W3F	#530-2020	1	1	6
<b>Country Kits</b>				
FRU,KYBD,TYPE 6,SUN I/O,US	#320-1270	1	2	6
COMPACT MOUSE	#370-1586	1	1	1
RUBBER MOUSE PAD	#370-2038	1	1	1
TYPE 5/6 KYBD EXTENDER CABLE	#530-2154	1	2	6

**General Note**

Refer to the Rebuilt website <http://www.sun.com/ibb> for Remanufactured Parts List.



## Spare parts for Sun Ultra 1 Models 140E, 170E and 200E (A12) *(continued)*

Description	Order Number	Stocking Level		
		25	100	500
<b>Chassis, Cables and Accessories</b>				
180W POWER SUPPLY E150 & ULTRA	#300-1308	1	1	1
ULTRA 1/30 TIMEKEEPER PROM	#525-1430	1	1	1
PERIPHERAL DATA CABLE, 410MM	#530-2153	1	1	1
ULTRA SPEAKER/LED WIRE HRNESS	#530-2175	1	1	1
PERIPHERAL & FAN WIRE HRNESS	#530-2176	1	1	1
FLOPPY DATA CBL, 205MM ULTRA 1	#530-2187	1	1	1
ULTRA DRIVE FAN ASSEMBLY	#540-2666	1	1	2
ULTRA 1 CPU MODULE FAN ASSY	#540-2761	1	1	2
10/100 BASE-T CABLE,RJ45-RJ45	#530-1871	1	1	1
SPEAKER	#370-1579	1	1	1
CDROM FILLER PANEL	#540-2701	1	1	1
SPEAKER ASSEMBLY, ULTRA 1	#540-2710	1	1	1
SWIS/S SINGLE-ENDED SCSI2 ADAP	#370-1703	1	1	1

# Spare parts for Sun Ultra 2 and Ultra Enterprise 2 Models 1170, 2170, 1200, 2200, 1300 and 2300 (A14)

## Configuration Overview 4 Slot SBus Logic Enclosure

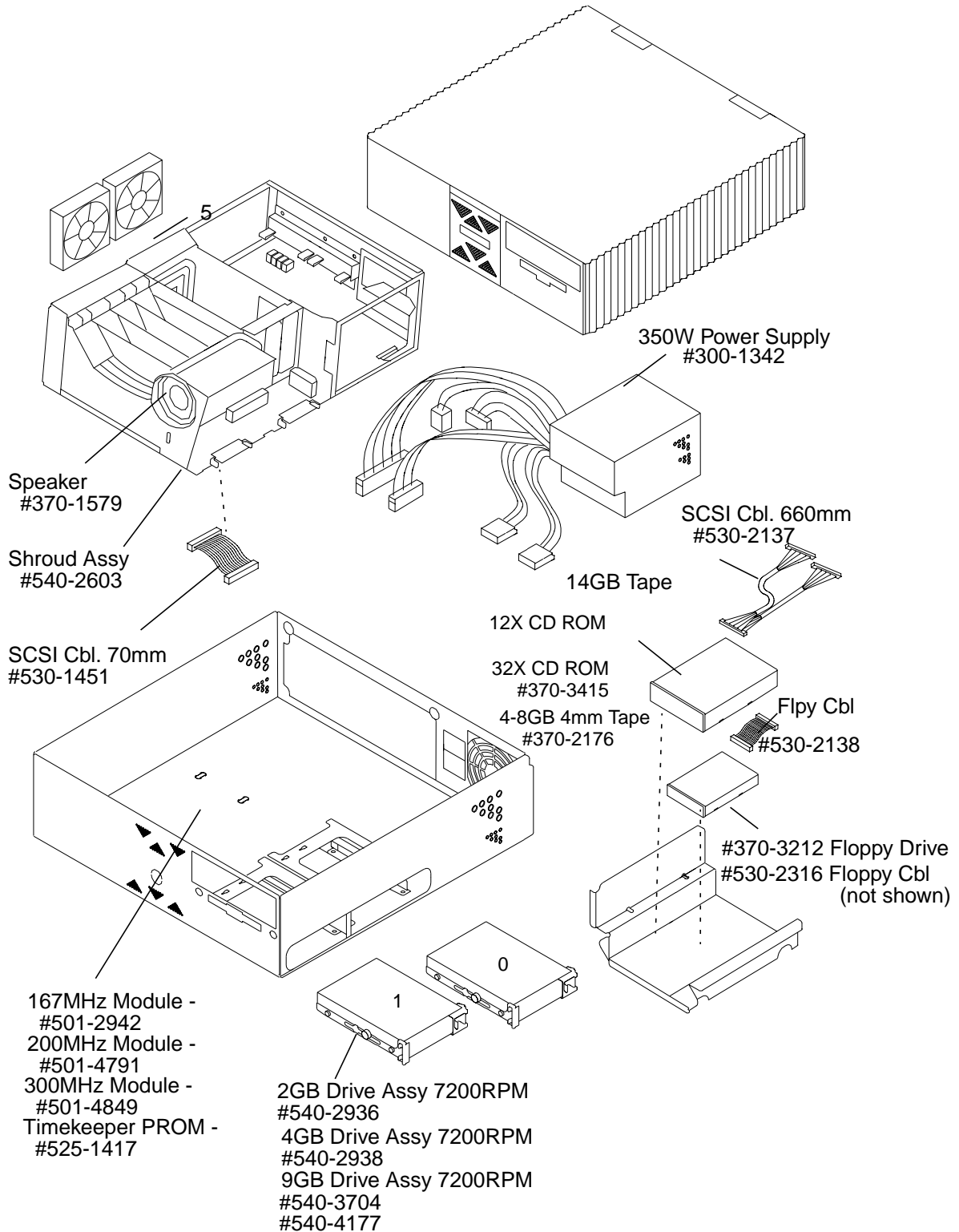

## Spare parts for Sun Ultra 2 and Ultra Enterprise 2 Models 1170, 2170, 1200, 2200, 1300 and 2300 (A14) *(continued)*

Description	Order Number	Stocking Level		
		25	100	500
<b>System Boards and Modules</b>				
Module 300MHZ UltraSPARC II	#501-4849	1	1	1
Module,167MHz ULTRASPARC	#501-2942	1	1	1
0MB CPU FRU, ULTRA 2	#501-3132	1	1	1
Module, 200MHZ ULTRASPARC II	#501-4791	1	1	1
FRU, 400MHz/2MB processor	#501-5445	1	1	2
<b>Graphics</b>				
FFB2,DBZ-HORIZONTAL	#501-4173	1	1	2
CREATOR3D GRAPHICS FRAMEBUFFER	#501-4126	1	1	2
CREATOR GRAPHICS FRAMEBUFFER	#501-4127	1	1	2
ELITE3D M6 HORIZONTAL GRAPHIC	#540-3058	1	1	2
CREATOR 3D GRAPHIS, SPEEDSORT	#501-3129	1	1	2
TURBOGXPLUS GRAPHICS BOARD	#501-2955	1	1	2
TURBOGX GRAPHICS BOARD	#501-2922	1	1	2
BOARD,FFB2+,DBZ-HORIZONTAL	#501-4790	1	1	2
FRAMEBUFFER, AFB-H, LOWPROFILE	#540-3979	1	1	2
<b>Memory and Mass Storage</b>				
7-14GB 8MM TAPE DRIVE	#370-2881	1	1	2
12/24GB 4mm DDS3 TAPE DRIVE	#370-2377	1	1	2
MEM,DSIMM,32MB,60NS,S20,S10	#501-2622	1	1	3
MEMORY,DSIMM,64MB,60NS,S10/S20	#501-2480	1	1	3
128MB DIMM, 60NS, ULTRA2	#501-3136	1	1	3
3D FLOPPY DRIVE	#370-3212	1	1	2
2.5GB 1/4in QIC TAPE DRIVE	#370-2018	1	1	2
DRV,4/8GB DDS2-CR TAPE,LT GREY	#370-2375	1	1	2
14GB, 8MM 1/2 HI GREY TAPE	#370-1857	1	1	3
12X CD-ROM LIGHT GREY	#370-2816	1	4	18
32X CD-ROM Drive, 1.6IN HEIGHT	#370-3415	1	1	3
2.1GB 7200RPM DISK DRIVE ASSY	#540-2936	1	1	3
2.1GB 5400RPM DISK DRIVE ASSY	#540-3171	1	1	3
4.2GB 7200RPM Disk Drive Assy	#540-2938	1	1	3
9.1GB 7200RPM Disk Drive Assy	#540-3704	1	1	2
ASSY,HOST ADAPTER,PHOTON	#501-5266	1	1	2
GIGABIT ETHERNET, SBUS MULTI	#501-4375	1	1	2
SWIS/S SINGLE-ENDED SCSI2 ADAP	#370-1703	1	1	2
9GB Disk Dr,Fujitsu MAB3091SC	#370-3413	1	1	2
FRU,Int Disk 18.2GB/10k USCSI	#540-4177	1	1	2

**General Note**

Refer to the Rebuilt website <http://www.sun.com/ibb> for Remanufactured Parts List.

## Spare parts for Sun Ultra 2 and Ultra Enterprise 2 Models 1170, 2170, 1200, 2200, 1300 and 2300 (A14) *(continued)*

Description	Order Number	Stocking Level		
		25	100	500
<b>Monitors</b>				
CABLE, MON ADPTER HD15F/13W3M	#130-3034	1	1	10
20" COLOR MONITOR W/13W3 CABLE	#365-1335	1	1	10
MONITOR, 19 INCH COLOR	#365-1380	1	1	6
MONITOR, 17 IN, 15PIN	#365-1354	1	2	6
MONITOR, 21 IN COLOR W/ CABLE	#365-1383	1	2	6
125VAC POWER CORD,6FT US JAPAN	#180-1179	1	1	10
CLR EXT CBL,3M,DB13W3M-DB13W3F	#530-2020	1	1	6
<b>Chassis, Cables and Accessories</b>				
PWR SUPPLY,350W,ULTRA2,A14	#300-1342	1	1	2
SPEAKER	#370-1579	1	1	1
SBUS NVRAM CARD 32MB	#375-0012	1	1	1
ULTRA 2 TIMEKEEPER PROM	#525-1417	1	1	1
INTERNAL SCSI CABLE, 660mm	#530-2137	1	1	1
FLOPPY CABLE, 320MM, ULTRA 2	#530-2138	1	1	1
CPU SHROUD ASSY/FRU	#540-2603	1	1	1
MODULE, UPA SLOT TERMINATOR	#501-4843	1	1	2
TYPE 5/6 KYBD EXTENDER CABLE	#530-2154	1	2	6
FLOPPY DC PWR FLTR CBL, 76MM	#530-2316	1	2	2
5.25 INCH FILLER PANEL	#330-1841	1	2	2
CABLE, MON ADPTER HD15F/13W3M	#130-3034	1	2	2
10/100 BASE-T CABLE,RJ45-RJ45	#530-1871	1	2	2
INTERNAL SCSI CABLE, 70mm	#530-1451	1	2	2
ELECTRO CONDENSOR MICROPHONE	#370-1678	1	2	2

**General Note**

Refer to the Reurbished website <http://www.sun.com/ibb> for Remanufactured Parts List.

# Spare parts for Sun Ultra 5 (A21)

## Configuration Overview 3 Slot PCI Logic Enclosure

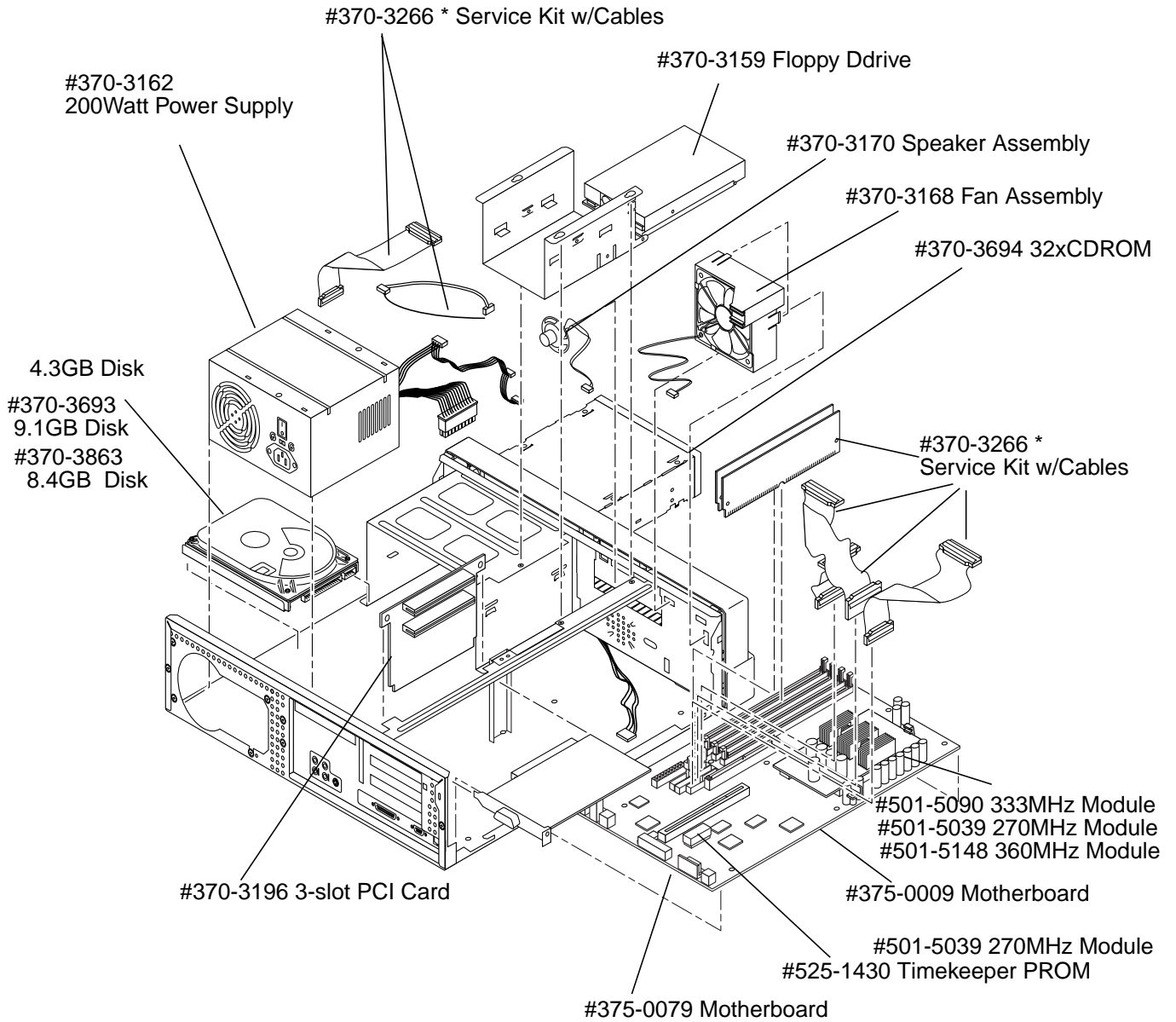

\* = Service Kit #370-3266  
includes:  
Memory DIMM, Disk Drive Cable,  
Hard Drive Cable, CD-ROM Drive  
Cable, Audio Cable

## Spare parts for Sun Ultra 5 (A21) *(continued)*

Description	Order Number	Stocking Level		
		25	100	500
<b>System Boards and Modules</b>				
FRU,ASSY,OEM,BOARD,Ultra5,10+	#375-0066	1	1	1
MOTHERBOARD,DARWIN	#375-0009	1	1	1
FRU,OEM,BOARD,SUNPCI,64MB	#375-0075	1	1	1
Module, 270MHz UltraSPARC Ii	#501-5039	1	1	1
333MHz ULTRASPARC Ii MODULE	#501-5090	1	1	1
ASY,SPPHR-RED,360MHZ,0.5MB,MDL	#501-5148	1	1	1
333MHz UltraSparc Ii Module	#501-5568	1	1	1
FRU,ASSY,OEM,BOARD,U5, U10	#375-0079	1	1	1
<b>Graphics</b>				
PGX COLOR FRAME BUFFER	#370-2256	1	1	2
<b>Memory and Mass Storage</b>				
FLOPPY DRIVE, ULTRA 5	#370-3159	1	1	2
DISK DRIVE,9.1GB,7200RPM,D	#370-3693	1	1	3
32XCDROM, Ultra 5,10	#370-3694	1	1	2
DIMM,32MB,50NS,ULTRA5,10	#370-3796	1	1	2
DIMM,64MB,50NS,ULTRA 5 ,10	#370-3797	2	6	26
DIMM,128MB,50NS,ULTRA 5, 10	#370-3798	1	1	2
DIMM,256MB,50NS,ULTRA 5, 10	#370-3799	1	1	2
FRU,DISK DRIVE,8.4GB	#370-3863	1	1	2
<b>Monitors</b>				
MONITOR, 21 IN COLOR W/ CABLE	#365-1383	1	1	2
20" COLOR MONITOR W/13W3 CABLE	#365-1335	1	1	2
MONITOR, 17 IN, 15PIN	#365-1354	1	1	2
MONITOR, 19 INCH COLOR	#365-1380	1	1	2

### General Note

Refer to the Rebuilt website <http://www.sun.com/ibb> for Remanufactured Parts List.

**Spare parts for Sun Ultra 5 (A21) (continued)**

Description	Order Number	Stocking Level		
		25	100	500
<b>Chassis, Cables and Accessories</b>				
CABLE, MON ADPTER HD15F/13W3M	#130-3034	1	1	2
ELECTRO CONDENSOR MICROPHONE	#370-1678	1	1	2
COMPACT MOUSE	#370-1586	1	1	2
AC POWER CORD 115V US Sys-Mon	#180-1097	1	1	2
200WATT POWER SUPPLY, ULTRA5	#370-3162	1	1	1
ASSY, FAN 8CM ULTRA 5	#370-3168	1	1	1
SPEAKER ASSEMBLY, ULTRA 5	#370-3170	1	1	1
3-SLOT PCI RISER CARD, ULTRA5	#370-3196	1	1	1
ULTRA 5 CABLE SERVICE KIT	#370-3266	1	1	2
ULTRA 1/30 TIMEKEEPER PROM	#525-1430	1	1	1
6' KEYBOARD CABLE M TO M	#530-1442	1	1	2
10/100 BASE-T CABLE,RJ45-RJ45	#530-1871	1	1	2
CBL,MON ADAPTER,15HDM/13W3F	#530-2357	1	1	2
FRU,BEZEL,A21	#370-3689	1	1	2

# Spare parts for Sun Ultra 10 (A22)

## Configuration Overview 4 Slot PCI Logic Enclosure

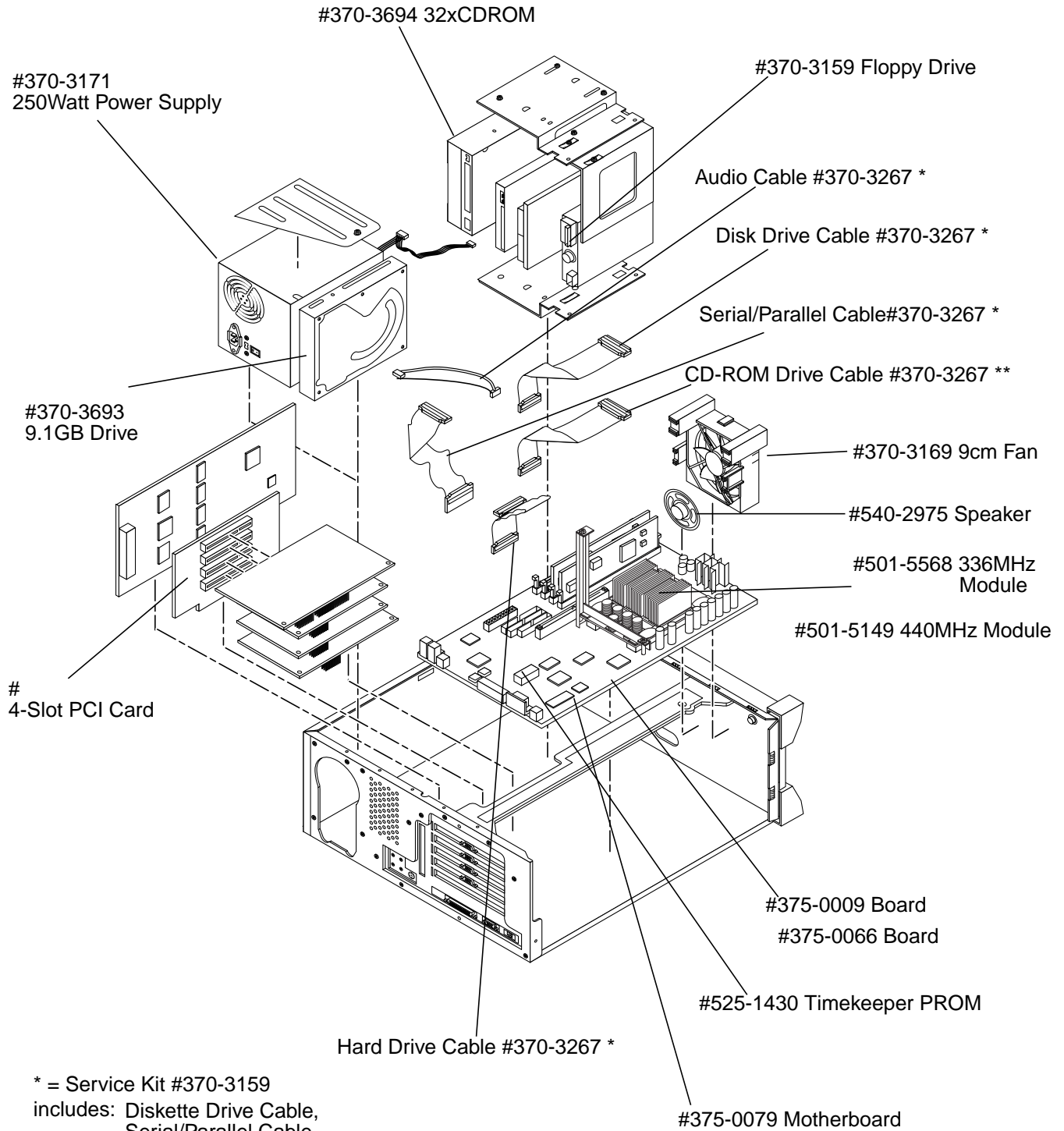

\* = Service Kit #370-3159  
includes: Diskette Drive Cable,  
Serial/Parallel Cable,  
CD-ROM Drive Cable,  
Hard Drive Cable



**Spare parts for Sun Ultra 10 (A22)** *(continued)*

Description	Order Number	Stocking Level		
		25	100	500
<b>System Boards and Modules</b>				
MOTHERBOARD,DARWIN	#375-0009	1	1	1
FRU,ASSY,OEM,BOARD,Ultra5,10+	#375-0066	1	1	1
FRU,ASSY,OEM,BOARD,U5, U10	#375-0079	1	1	1
Module, 270MHz UltraSPARC Ii	#501-5039	1	1	1
360MHz ULTRASPARC Ii Module	#501-5222	1	1	1
333MHz ULTRASPARC Ii MODULE	#501-5090	1	1	1
FRU,ASY,Ultra 10,440MHZ,2MB	#501-5149	1	1	1
333MHz UltraSparc Ii Module	#501-5568	1	1	1
<b>Graphics</b>				
ASSY,FFB2+,SB-VERTICAL,TSTD	#501-4789	1	1	2
FRU,ASSY,AFB-V,3.14 TSTD	#501-5268	1	1	2
FRU,Creator3D, Series 3 E-STAR	#501-5690	1	1	2
FRU,ASSY,AFBLITE	#501-4860	1	1	2
PGX COLOR FRAME BUFFER	#370-2256	1	1	2
FRU,ASSY,AFBV-REGULATED,	#501-5484	1	1	2
FRU,ASSY,AFB-V,REGULATED	#540-3902	1	1	2
<b>Memory and Mass Storage</b>				
FLOPPY DRIVE, ULTRA 5	#370-3159	1	1	2
DISK DRIVE,4.3GB,5400RPM U5,10	#370-3692	1	1	2
DISK DRIVE,9.1GB,7200RPM,D	#370-3693	1	1	3
32XCDROM, Ultra 5,10	#370-3694	1	1	2
DIMM,32MB,50NS,ULTRA5,10	#370-3796	1	1	2
DIMM,64MB,50NS,ULTRA 5 ,10	#370-3797	2	6	26
DIMM,128MB,50NS,ULTRA 5, 10	#370-3798	1	1	2
DIMM,256MB,50NS,ULTRA 5, 10	#370-3799	1	1	2
<b>Monitors</b>				
MONITOR, 21 IN COLOR W/ CABLE	#365-1383	1	1	2
20" COLOR MONITOR W/13W3 CABLE	#365-1335	1	1	2
MONITOR, 17 IN, 15PIN	#365-1354	1	1	2
MONITOR, 24 HDTV COLOR	#365-1352	1	1	2
MONITOR, 19 INCH COLOR	#365-1380	1	1	2

**General Note**

Refer to the Rebuilt website <http://www.sun.com/ibb> for Remanufactured Parts List.

## Spare parts for Sun Ultra 10 (A22) *(continued)*

Description	Order Number	Stocking Level		
		25	100	500
<b>Chassis, Cables and Accessories</b>				
CABLE, MON ADPTER HD15F/13W3M	#130-3034	1	1	2
ELECTRO CONDENSOR MICROPHONE	#370-1678	1	1	2
COMPACT MOUSE	#370-1586	1	1	2
AC POWER CORD 115V US Sys-Mon	#180-1097	1	1	2
250WATT POWER SUPPLY	#370-3171	1	1	1
SPEAKER ASSEMBLY, ULTRA 10	#370-3264	1	1	1
ULTRA 10 CABLE SERVICE KIT	#370-3267	1	1	2
ULTRA 1/30 TIMEKEEPER PROM	#525-1430	1	1	1
6' KEYBOARD CABLE M TO M	#530-1442	1	1	2
CBL,MON ADAPTER,15HDM/13W3F	#530-2357	1	1	2
ULTRA 1/30 TIMEKEEPER PROM	#525-1430	1	1	2
COMPACT MOUSE	#370-1586	1	1	1
RUBBER MOUSE PAD	#370-2038	1	1	2
10/100 BASE-T CABLE,RJ45-RJ45	#530-1871	1	1	1
BRACKET,HARD DRIVE,PRIMARYBRAC	#370-3721	1	1	2
FRU,BEZEL,A22,FRONT,TOP	#370-3690	1	1	2
ASSY,SERIAL PORT CABLE AFB-V	#530-2672	1	1	2
ASSY,AFBLITE W/DAUGHTERCARD	#540-3623	1	1	2
FRU,ASSY,AFB-V,3.14 TSTD	#501-5268	1	1	2
FRU,U10 RISER CRD W/STIF &	#540-4228	1	1	2
FRU,U10 RISER CRD W/STIFFE	#370-3982	1	1	2
FRU,CD FILLER PANEL, U10	#370-4101	1	1	2
FRU,MOUSE,CROSSBOW,3B,LOGOFUL	#370-3631	1	1	2

# Spare parts for Sun Ultra 30 (A16)

## Configuration Overview 4 Slot PCI Logic Enclosure

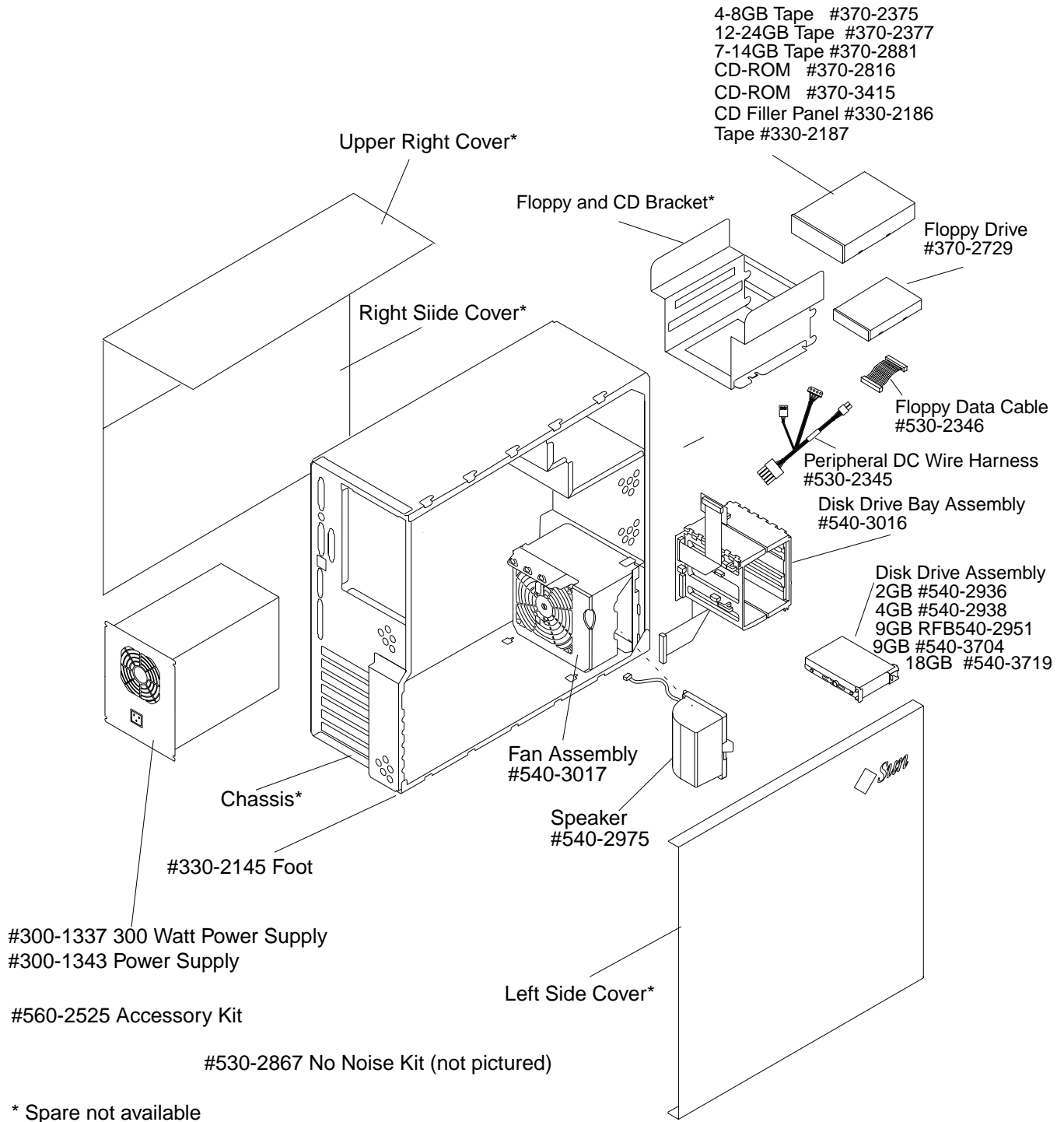

**Spare parts for Sun Ultra 30 (A16)** *(continued)*

Description	Order Number	Stocking Level		
		25	100	500
<b>System Boards and Modules</b>				
0MB SYSTEM BOARD QUARK	#501-3139	1	1	1
Module 300MHZ UltraSPARC II	#501-4849	1	1	1
MODULE 250MHZ 1MBCACH USPARCII	#501-4857	1	1	1
<b>Graphics</b>				
FRU,Creator3D, Series 3 E-STAR	#501-5690	1	1	2
PGX COLOR FRAME BUFFER	#370-2256	1	1	2
ASSY,FFB2+,SB-VERTICAL,TSTD	#501-4789	1	1	2
FBUFFER, FFB2,DBZ-VERTICAL	#501-4172	1	1	1
<b>Memory and Mass Storage</b>				
7-14GB 8MM TAPE DRIVE	#370-2881	1	1	2
2.5GB 1/4in QIC TAPE DRIVE	#370-2018	1	1	2
DRV,4/8GB DDS2-CR TAPE,LT GREY	#370-2375	1	1	3
12/24GB 4mm DDS3 TAPE DRIVE	#370-2377	1	1	3
Manual Eject FLOPPY DRIVE	#370-2729	1	1	3
12X CD-ROM LIGHT GREY	#370-2816	1	1	2
4-8GB 1/4in SLR TAPE DRIVE	#370-3279	1	1	2
MEMORY,DSIMM,16MB,60NS,S20	#501-2479	2	6	26
MEMORY,DSIMM,64MB,60NS,S10/S20	#501-2480	1	1	2
MEM,DSIMM,32MB,60NS,S20,S10	#501-2622	1	1	2
128MB DIMM, 60NS, ULTRA2	#501-3136	1	1	3
2.1GB 7200RPM DISK DRIVE ASSY	#540-2936	1	4	18
4.2GB 7200RPM Disk Drive Assy	#540-2938	1	1	3
18.2GB 7200RPM Dsk Dr FRU Assy	#540-3719	1	1	3
DISK DRIVE BAY FRU ASSY	#540-3016	1	1	1
RFB 9.1GB 7200RPM Disk Drive	RFB540-2951	1	1	3
<b>Monitors</b>				
MONITOR, 21 IN COLOR W/ CABLE	#365-1383	1	1	2
20" COLOR MONITOR W/13W3 CABLE	#365-1335	1	1	2
MONITOR, 24 HDTV COLOR	#365-1352	1	1	2
TYPE 5/6 KYBD EXTENDER CABLE	#530-2154	1	1	2
CLR EXT CBL,3M,DB13W3M-DB13W3F	#530-2020	1	1	2
125VAC POWER CORD,6FT US JAPAN	#180-1179	1	1	2
CABLE, MON ADPTER HD15F/13W3M	#130-3034	1	1	2
<b>Chassis, Cables and Accessories</b>				
POWER SUPPLY, ULTRA 60	#300-1343	1	1	2
POWER SUPPLY 300W, Ultra 30	#300-1337	1	1	2
CHASSIS FOOT, ULTRA 30/60	#330-2145	1	1	1
5-1/4 IN DEV EXT FILLER PANEL	#330-2186	1	1	1
3-1/2in DEV EXT FILLER PANEL	#330-2187	1	1	1
AUDIO MODULE, ULTRA 30 & 60	#501-4155	1	1	1
ULTRA 1/30 TIMEKEEPER PROM	#525-1430	1	1	1
10/100 BASE-T CABLE,RJ45-RJ45	#530-1871	1	1	2
PERIPHERAL DC WIRE HARNESS	#530-2345	1	1	1
FLOPPY DATA CABLE	#530-2346	1	1	1
CABLE ULTRA SCSI 68PIN, .8M	#530-2383	1	1	1
CABLE ULTRA SCSI 68PIN 2M	#530-2384	1	1	1
SPEAKER FRU ASSEMBLY	#540-2975	1	1	1
SYS BRD FAN & SHROUD ASSEMBLY	#540-2986	1	1	1
ON/OFF SWITCH & CBL-U30/U60	#540-2991	1	1	1

**General Note**Refer to the Rebuilt website <http://www.sun.com/ibb> for Remanufactured Parts List.

**Spare parts for Sun Ultra 30 (A16) (continued)**

Description	Order Number	Stocking Level		
		25	100	500
<b>Chassis, Cables and Accessories (continued)</b>				
FAN FRU ASSEMBLY	#540-3017	1	1	1
ULTRA 1/30 TIMEKEEPER PROM	#525-1430	1	1	1
32X CD-ROM Drive, 1.6IN HEIGHT	#370-3415	1	1	1
POWER SUPPLY 300W, Ultra 30	#300-1337	1	1	2
CHASSIS FOOT, ULTRA 30/60	#330-2145	1	1	1
5-1/4 IN DEV EXT FILLER PANEL	#330-2186	1	1	1
3-1/2in DEV EXT FILLER PANEL	#330-2187	1	1	1
AUDIO MODULE, ULTRA 30 & 60	#501-4155	1	1	1
ULTRA 1/30 TIMEKEEPER PROM	#525-1430	1	1	1
10/100 BASE-T CABLE,RJ45-RJ45	#530-1871	1	1	2
PERIPHERAL DC WIRE HARNESS	#530-2345	1	1	1
FLOPPY DATA CABLE	#530-2346	1	1	1
CABLE ULTRA SCSI 68PIN, .8M	#530-2383	1	1	1
CABLE ULTRA SCSI 68PIN 2M	#530-2384	1	1	1
SPEAKER FRU ASSEMBLY	#540-2975	1	1	1
SYS BRD FAN & SHROUD ASSEMBLY	#540-2986	1	1	1
ON/OFF SWITCH & CBL-U30/U60	#540-2991	1	1	1
Accessory kit for Ultra 30/60	#560-2525	1	1	1
FRU,NO NOISE KIT,ULTRA30/60	#530-2867	1	1	1

# Spare parts for Sun Ultra 60 (A23)

## Configuration Overview 4 Slot PCI Logic Enclosure

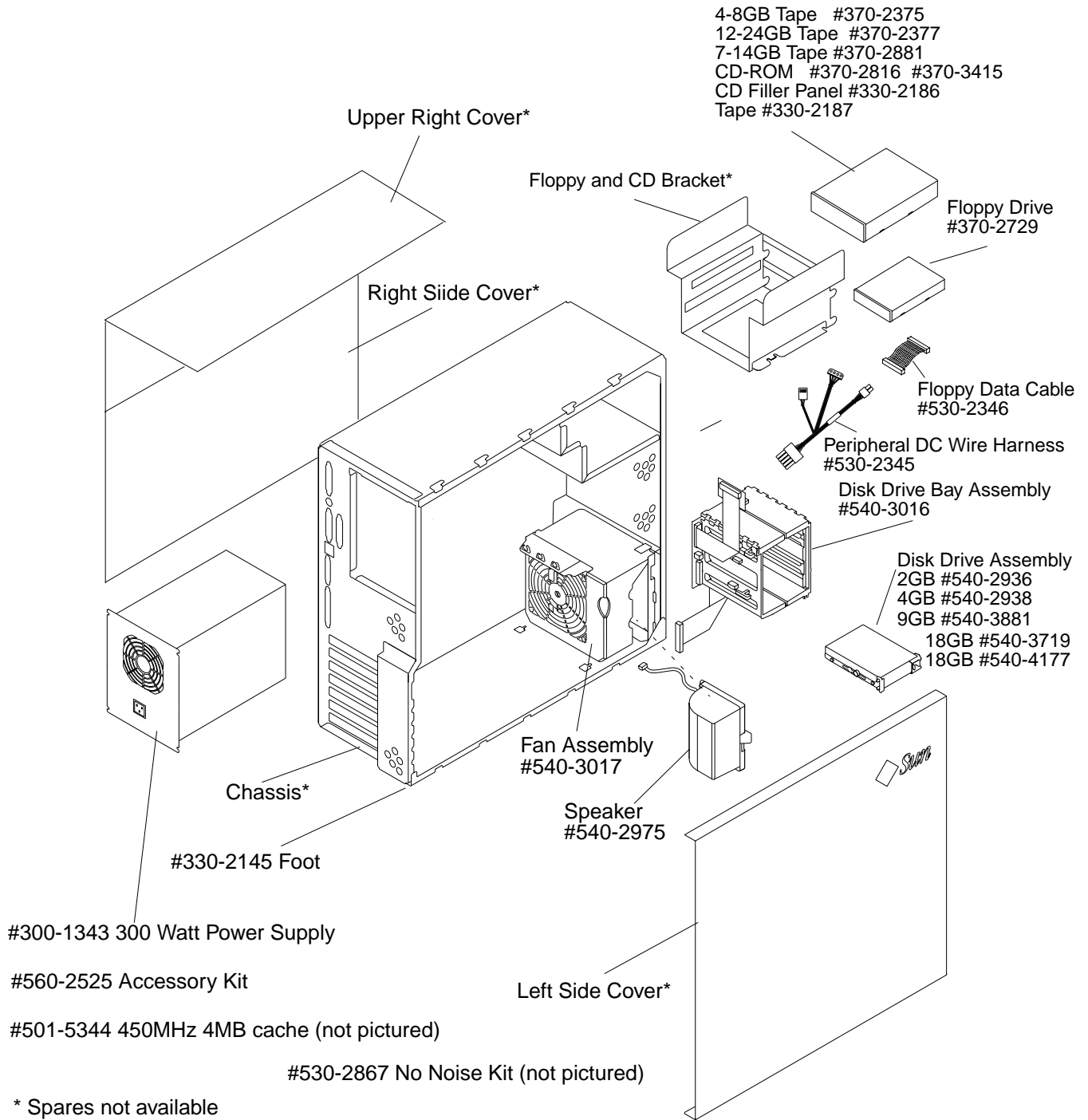

**Spare parts for Sun Ultra 60 (A23) (continued)**

Description	Order Number	Stocking Level		
		25	100	500
<b>System Boards and Modules</b>				
MOTHERBOARD, ULTRA 60	#501-4450	1	1	1
Module 300MHZ UltraSPARC II	#501-4849	1	1	1
MODULE 250MHZ 1MBCACH USPARCII	#501-4857	1	1	1
ASSY,SAPPHIRE,4MB,360MHZ	#501-4781	1	1	1
FRU OPT PROC. US 360MHZ/4MB	#501-5552	1	1	1
FRU, PROCESSOR US 450MHZ/4MB	#501-5539	1	1	1
<b>Graphics</b>				
PGX COLOR FRAME BUFFER	#370-2256	1	1	2
ASSY,FFB2+,SB-VERTICAL,TSTD	#501-4789	1	1	2
FBUFFER, FFB2,DBZ-VERTICAL	#501-4172	1	1	1
<b>Memory and Mass Storage</b>				
MEM,DSIMM,32MB,60NS,S20,S10	#501-2622	1	1	2
128MB DIMM, 60NS, ULTRA2	#501-3136	1	1	2
4.2GB 7200RPM Disk Drive Assy	#540-2938	1	1	2
MEMORY,DSIMM,64MB,60NS,S10/S20	#501-2480	1	1	3
9.1GB 7200RPM Disk Drive Assy	#540-3704	1	1	3
18.2GB 7200RPM Dsk Dr FRU Assy	#540-3719	1	1	3
INT DISK 9.1GB/10K USCSI	#540-3881	1	1	1
FRU,Int Disk 18.2GB/10k USCSI	#540-4177	1	1	1
<b>Monitors</b>				
CABLE, MON ADPTER HD15F/13W3M	#130-3034	1	1	2
125VAC POWER CORD,6FT US JAPAN	#180-1179	1	1	2
20" COLOR MONITOR W/13W3 CABLE	#365-1335	1	1	2
MONITOR, 24 HDTV COLOR	#365-1352	1	1	2
MONITOR, 21 IN COLOR W/ CABLE	#365-1383	1	1	2
TYPE 5/6 KYBD EXTENDER CABLE	#530-2154	1	1	2
CLR EXT CBL,3M,DB13W3M-DB13W3F	#530-2020	1	1	2

**General Note**

Refer to the Rebuilt website <http://www.sun.com/ibb> for Remanufactured Parts List.

## Spare parts for Sun Ultra 60 (A23) *(continued)*

Description	Order Number	Stocking Level		
		25	100	500
<b>Chassis, Cables and Accessories <i>(continued)</i></b>				
FAN ASSEMBLY, ULTRA 30/60	#540-3428	1	1	2
ASSY, SHROUD, 1 CPU, ULTRA 60	#540-3427	1	1	1
ASSY, SHROUD, 2 CPU, ULTRA 60	#330-2376	1	1	1
POWER SUPPLY, ULTRA 60	#300-1343	1	1	1
AUDIO MODULE, ULTRA 30 & 60	#501-4155	1	1	1
PERIPHERAL DC WIRE HARNESS	#530-2345	1	1	1
SPEAKER FRU ASSEMBLY	#540-2975	1	1	2
ON/OFF SWITCH & CBL-U30/U60	#540-2991	1	1	1
CHASSIS FOOT, ULTRA 30/60	#330-2145	1	1	1
5-1/4 IN DEV EXT FILLER PANEL	#330-2186	1	1	1
3-1/2in DEV EXT FILLER PANEL	#330-2187	1	1	1
Manual Eject FLOPPY DRIVE	#370-2729	1	1	1
ULTRA 1/30 TIMEKEEPER PROM	#525-1430	1	1	1
32X CD-ROM Drive, 1.6IN HEIGHT	#370-3415	1	1	1
DUAL DIFF ADPTR ULTRA SCSI/PCI	#375-0006	1	1	1
FLOPPY DATA CABLE	#530-2346	1	1	1
Accessory kit for Ultra 30/60	#560-2525	1	1	1
10/100 BASE-T CABLE,RJ45-RJ45	#530-1871	1	1	1
SPEAKER	#370-1579	1	1	1
FAN FRU ASSEMBLY	#540-3017	1	1	1
AUDIO MODULE, ULTRA 30 & 60	#501-4155	1	1	1
FRU,NO NOISE KIT,ULTRA30/60	#530-2867	1	1	1

**General Note**

Refer to the Rebuilt website <http://www.sun.com/ibb> for Remanufactured Parts List.



## Spare parts for Sun Ultra 80 (A27)

Description	Order Number	Stocking Level		
		25	100	500
<b>System Boards and Modules</b>				
FRU, PROCESSOR US 450MHZ/4MB	#501-5539	1	1	1
FRU,ASSY, MOTHERBOARD	#501-5168	1	1	1
<b>Memory and Mass Storage</b>				
FRU,Int Disk 18.2GB/10k USCSI	#540-4177	1	1	1
FRU,ASSY, MEMORY RISER	#501-5218	1	1	3
ASSY,DSIMM,64MB,60NS,TSTD, SIMM,256MB,60NS,E450	#501-5691	1	1	1
	#501-4743	1	1	1
<b>Chassis Cable and Accessories</b>				
FRU,SWITCH,ON/OFF	#150-3112	1	1	2
FRU,SWITCH,INTERLOCK,A28	#150-3114	1	1	2
DC/DC CONVERTER,125 W,D122	#300-1407	1	1	2
PWR SUPPLY,A119-U,	#300-1357	1	1	2
FILLER,CPU AIRDAM,A28	#330-2805	1	1	2
FRU,CABLE,DC POWER,A28	#530-2582	1	1	2
PGX32 CARD-24-BIT	#370-3753	1	1	2
AUDIO MODULE, ULTRA 30 & 60	#501-4155	1	1	2
FRU,CABLE,COMBINED,A28	#530-2583	1	1	2
Accessory kit for Ultra 30/60	#560-2525	1	1	2
SCSI ASSEMBLY, Ultra 80	#530-2691	1	1	2
DRIVER,TORQUE INDICATING T	#340-6091	1	1	2
FRU,FAN,120X38MM,JAPAN SERVO	#370-3718	1	1	2

### General Note

Refer to the Rebuilt website <http://www.sun.com/ibb> for Remanufactured Parts List.

# Spare parts for SPARC Xterminal 1

## Configuration Overview

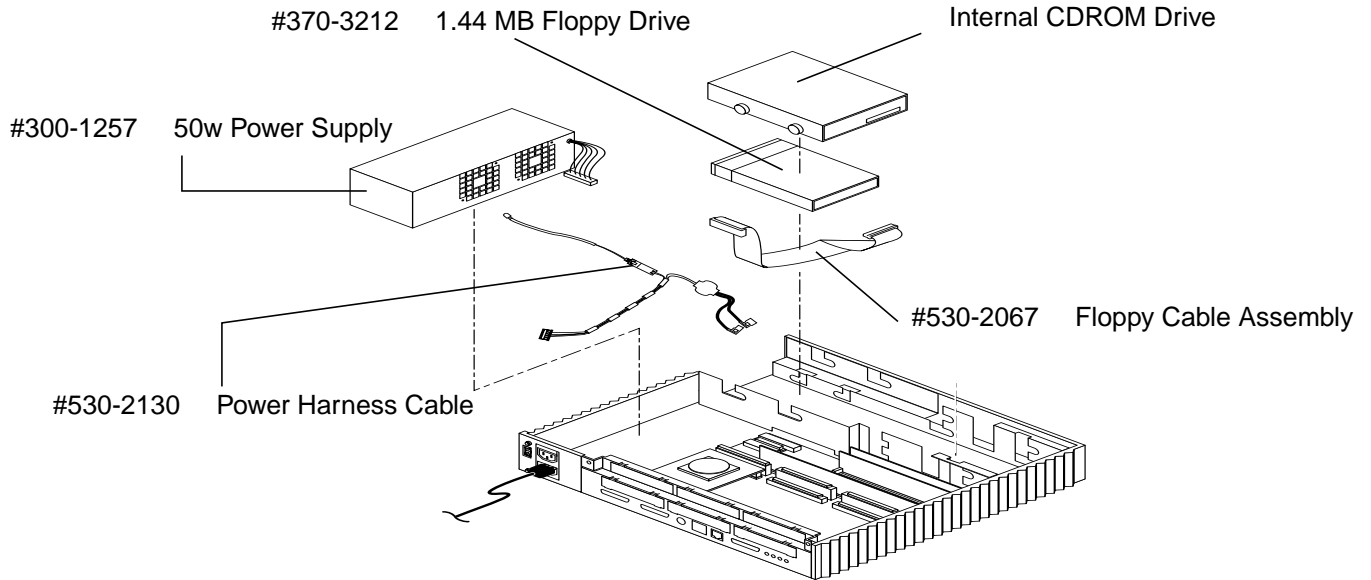

- Notes:
- 1 SBus Slot only
  - No MBus Modules (onboard CPU)

## Spare parts for SPARC Xterminal 1 *(continued)*

Description	Order Number	Stocking Level		
		25	100	500
<b>System Boards and Modules</b>				
X-TERM, 0MB, 50MHZ, S114	#501-3025	1	3	7
<b>Graphics</b>				
TURBOGX GRAPHICS BOARD	#501-2922	1	1	2
RFB TGX FRAMEBUFFER	RFB501-2325	1	1	2
TURBOGXPLUS GRAPHICS BOARD	#501-2955	1	1	2
RFB 4MB TGX+ FRAMEBUFFER	RFB501-2253	1	1	2
S24 FRAMEBUFFER CARD	#501-2337	1	2	9
<b>Memory and Mass Storage</b>				
32MB SIMM, 4MX66DEPOP	#501-2471	1	1	3
3D FLOPPY DRIVE	#370-3212	1	2	6
<b>Monitors</b>				
20" COLOR MONITOR W/13W3 CABLE	#365-1335	1	2	10
MONITOR, 19 INCH COLOR	#365-1380	1	3	12
RFB 15" COLOR MONITOR, DB13W3	RFB365-1286	2	6	27
<b>Country Kits</b>				
FRU,KYBD,TYPE 6,SUN I/O,US	#320-1270	1	2	6
COMPACT MOUSE	#370-1586	1	1	1
RUBBER MOUSE PAD	#370-2038	1	1	1
COMPACT MOUSE	#370-1586	1	2	6
ELECTRO CONDENSOR MICROPHONE	#370-1678	1	1	1
<b>Chassis, Cables and Accessories</b>				
50W POWER SUPPLY	#300-1257	1	2	6
PERIPHERAL POWER HARNESS CBL	#530-2130	1	1	1
FLOPPY CABLE ASSEMBLY	#530-2067	1	1	1
AC POWER CORD 115V US Sys-Mon	#180-1097	1	1	1
NVRAM, S4/S5	#525-1369	1	1	1
10/100 BASE-T CABLE,RJ45-RJ45	#530-1871	1	1	1
AUDIO CABLE FOR SS5	#530-2079	1	1	1
SPEAKER	#370-1579	1	1	1
SPEAKER/LED POWER CABLE	#530-2080	1	1	1
AUDIO MODULE, SS4/XTERM 1	#501-2592	1	1	1
INT SCSI CBL, CD-ROM, 350MM	#530-2129	1	1	1

**General Note**

Refer to the Rebuilt website <http://www.sun.com/ibb> for Remanufactured Parts List.