



## DF200A/200AP SPECIFICATIONS

MODEL	DF200AT	DF200AZ <sup>*2</sup>	DF200AP
<b>RECOMMENDED TRANSOM HEIGHT mm (in.)</b>	L:508 (20) X:635 (25)	X:635 (25)	L:508 (20) X:635 (25)
<b>STARTING SYSTEM</b>	Electric		
<b>WEIGHT kg (lbs.)<sup>*1</sup></b>	L:226 (498) X:231 (509)	X:231 (509)	L:228 (502) X:233 (514)
<b>ENGINE TYPE</b>	DOHC 16-Valve		
<b>FUEL DELIVERY SYSTEM</b>	Multi-Point Sequential Electronic Fuel Injection		
<b>NO. OF CYLINDERS</b>	In-Line 4		
<b>PISTON DISPLACEMENT cm<sup>3</sup> (cu.in.)</b>	2,867 (174.9)		
<b>BORE × STROKE m/m (in.)</b>	97 × 97 (3.81 × 3.81)		
<b>MAXIMUM OUTPUT kW (PS)</b>	147.0 (200)/5,800rpm		
<b>FULL THROTTLE OPERATING RANGE rpm</b>	5,500-6,100rpm		
<b>STEERING</b>	Remote		
<b>OIL PAN CAPACITY ℓ (U.S./Imp. qt.)</b>	8.0 (8.5/7.0)		
<b>IGNITION SYSTEM</b>	Fully-transistorized		
<b>ALTERNATOR</b>	12V 44A		
<b>ENGINE MOUNTING</b>	Shear Mount		
<b>TRIM METHOD</b>	Power Trim and Tilt		
<b>GEAR RATIO</b>	2.50:1		
<b>GEAR SHIFT</b>	F-N-R		
<b>EXHAUST</b>	Through Prop Hub Exhaust		
<b>PROPELLER SELECTION (Pitch)</b> All propellers are the 3-blade type Optional <sup>*1</sup> Please inquire at your local dealer for details of the propeller.	3×16×17-27.5	3×16×18.5-24.5 (C/R)	3×16×17-27.5 3×16×18.5-24.5 (C/R)

\*1: Dry Weight: Including battery cable, not including propeller and engine oil.

\*2: DF200AZ: Counter Rotation Model.

Boats and motors come in a large variety of combinations. See your authorized dealer for correct prop. selection to meet recommended RPM range at W.O.T. Please read your owners manual carefully. Remember, boating and alcohol or other drugs don't mix. Please operate your outboard safely and responsibly. Suzuki encourages you to operate your boat safely and with respect for the marine environment.

Specifications, appearances, equipment, colors, materials and other items of "SUZUKI" products shown on this catalogue are subject to change by manufacturers at any time without notice and they may vary depending on local conditions or requirements. Some models are not available in some territories. Each model might be discontinued without notice. Please inquire at your local dealer for details of any such changes. Actual body color might differ from the colors in this brochure.

## DIMENSIONS

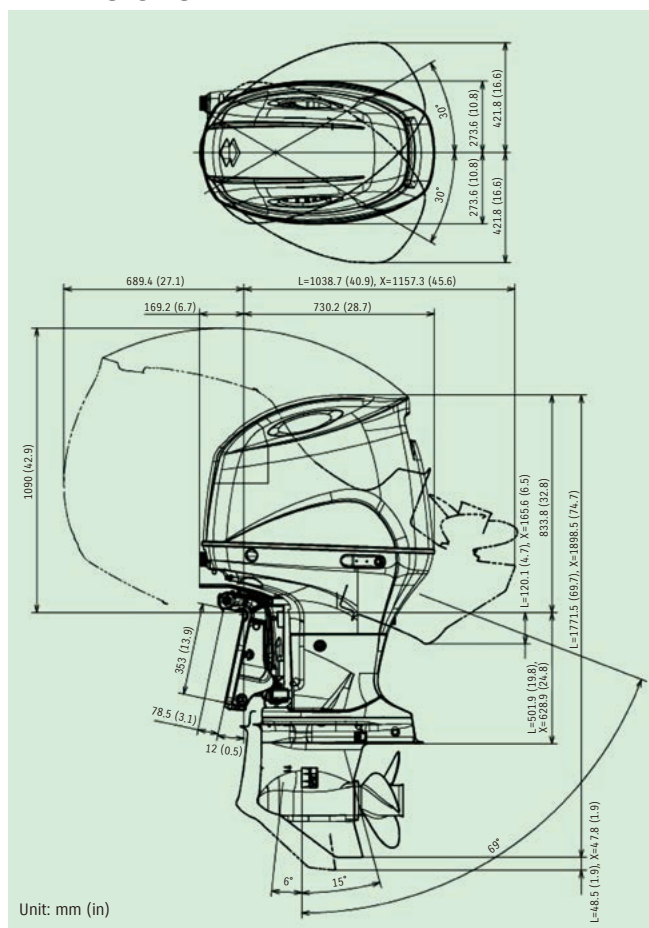

**SUZUKI MOTOR CORPORATION**

300 TAKATUKA-CHO, MINAMI-KU, HAMAMATSU CITY, JAPAN 432-8611

99999-C2055-001 DF200/AP PRODUCT INFORMATION © Printed in Japan 1409



# PRODUCT INFORMATION



LEAN BURN 

# DF200A/200AP



SUZUKI

Way of Life!



# Lightweight Design—Heavyweight Power

Power and performance come at a cost, that being weight. So when it comes to selecting an outboard for your boat, the balance of power and weight becomes an important issue in making the right choice. Until now, powering your boat with a 147kW (200PS) class outboard meant V6 power. That has all changed with Suzuki's DF200A.

With the DF200A, our goal was to build an outboard that provides all of the power and performance of a 147kW (200PS) class V6 outboard using a lighter, more compact four-cylinder configuration. To deliver that level of performance our engineers used an in-line four-cylinder engine with a 2.9-liter "Big-Block" displacement and a higher 10.2:1 compression ratio to generate impressive acceleration and low-end torque. A specially designed cowl and semi-direct air intake system were designed to provide cooler air to the tuned long-track intake manifold while a four valve per cylinder DOHC powerhead with Variable Valve Timing lets the engine breathe more efficiently increasing acceleration and top end speed. Added to that are a fuel injection system and Suzuki's Lean Burn Technology for improved fuel economy.

The DF200A weighs 30kg less and is more compact than the V6 version. That, and its excellent balance when mounted on the transom make it the perfect choice for powering lightweight boats. It's also great for breathing new life into older boats still rigged with lighter two-stroke engines, giving them the latest in four-stroke technology and economy without sacrificing on weight or power.

Other features include a knock sensor, O<sub>2</sub> sensor, and water detecting system to provide superior reliability. Found only on the DF200AP is Suzuki Precision Control digital control system, and Suzuki Selective Rotation for multi-engine applications. A convenient keyless start system that also functions as an immobilizer to help deter theft is available\*\* with the DF200AP.



## Main Features of the New DF200A/200AP\*

- 2,867cm<sup>3</sup> in-line four-cylinder "Big Block" engine and a high compression ratio delivers 147kW (200PS) for impressive acceleration and low-end torque.
- Suzuki Lean Burn Control combined with Suzuki Precision Control delivers remarkable fuel economy over a wide operating range and smooth power transitions when power is required.
- Semi direct air intake system supplies cooler airflow for greater power output.
- Knock and O<sub>2</sub> sensors plus a water detecting system offer increased engine reliability.
- Intake Resonator keeps outboard operation quiet.
- Variable Valve Timing System delivers superior low to mid range torque for greater acceleration.
- Multi-Stage Induction System produces great top-end performance.
- Keyless Start System\*\* offers simple, stress-free starting and functions as an immobilizer to help deter theft. (DF200AP only)
- Suzuki Selective Rotation allows the same engine to operate in either regular or counter-rotation modes. (DF200AP only)

\*DF200AP production is scheduled to start in February 2015. \*\*Availability may differ in some regions. Please contact your local Suzuki dealer for more information.

## Advanced Technology for Performance

### Suzuki Lean Burn Control System

The Suzuki Lean Burn Control System is an intelligent fuel delivery system that achieves remarkable improvements in fuel consumption making fuel-efficient four-stroke outboards even more economical. Monitoring engine performance and operating conditions in real time, the system uses the 32-bit onboard ECM to predict fuel needs and deliver a leaner, more precise fuel mixture across the outboard's operating range. The results show significant improvements in fuel economy across the entire powerband, including the cruising range where the engine is used a majority of the time. Comparing the new DF200A with the original V6 DF200, tests show up to a 19% increase in fuel efficiency mainly in the cruising range (around 70% of its maximum speed).

**LEAN BURN**

### O<sub>2</sub> Sensor Feedback Control System

Like many of Suzuki's high-end outboards, the DF200A features an O<sub>2</sub> Sensor Feedback Control system that helps maintain optimum engine efficiency. The system monitors engine operating conditions to provide input to the ECM allowing it to manage the fuel/air mixture for maximum performance across the engine's full operating range.

### Semi-Direct Air Intake System

The cover on the new DF200A has a modern upswept design giving it an innovative look. Underneath the looks though, the design is all about function. Incorporated into the cowl is a semi-direct air intake system that delivers cooler air directly to the engine's tuned multi-stage induction module. Engines breathing cooler air are able to increase operating efficiency resulting in greater acceleration and top-end speed.

The cover's design also helps reducing the temperature inside of the engine with ports that allow the rotating flywheel to push warm air inside of the cover to the outside.

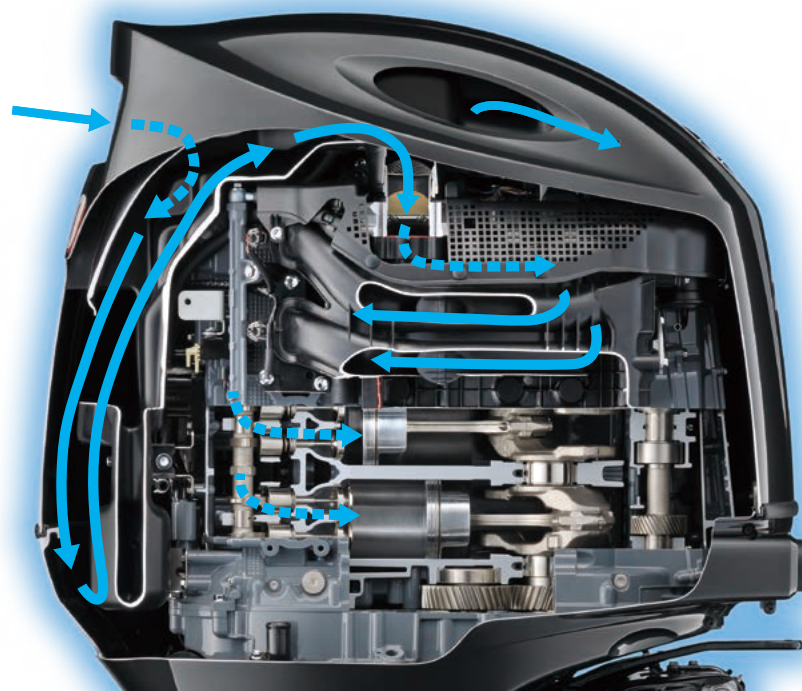

 Air Flow

### Comparison of Fuel Efficiency per Liter (New DF200A vs. V6 DF200)

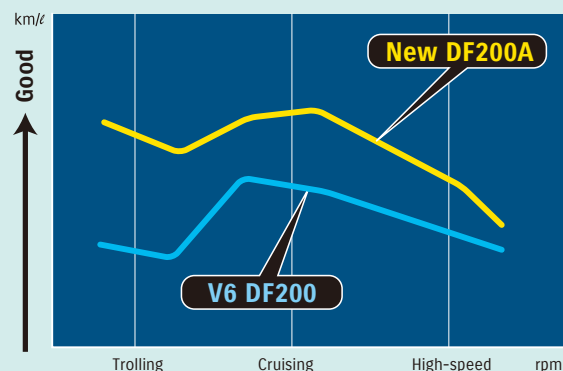

Compared to the original V6 DF200, the new DF200A delivers up to a 19% increase in fuel efficiency mainly in the cruising range (around 70% of its maximum speed).

\* Data used in the graphs were obtained through "In-House Suzuki Testing" under uniformed conditions. Results will vary depending upon operating conditions (boat design, size, weight, weather, etc.)

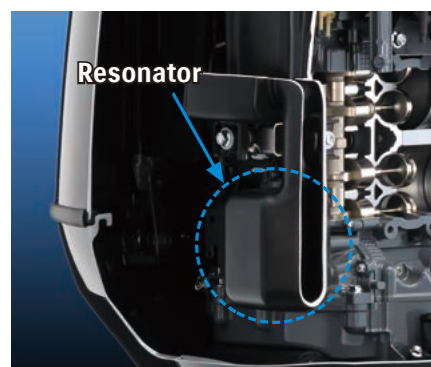

### Resonator

The engine's exhaust system is a well-known source of engine noise, but another, often overlooked source is the intake manifold. Air being sucked at high velocities into the intake manifold can generate a harsh sound. The DF200A incorporates an air intake resonator that reduces such noise keeping operation exceptionally quiet.



## Big Block—High Performance Engine

The design goal for the new DF200A was to provide boaters with the performance of a V6 DF200 outboard from a more compact, lighter weight four-cylinder engine. For this, Suzuki engineers started with the 2.9-liter straight-four block used on DF150/175, updating the “Big Block” design with a DOHC four-valve per cylinder powerhead and a 10.2:1 compression ratio. In addition, the engine incorporates Variable Valve Timing, Multi-stage Induction, and a 32-bit onboard computer. The end result is an engine that weighs 30kg less than the its V6 version making it an excellent choice for powering bass boats and other lightweight vessels. It’s also an excellent choice for those wanting to upgrade older boats fitted with V6 two-strokes.

## Higher Compression Ratio 10.2:1

Drawing upon our experience building race engines for motorsports, Suzuki engineers have designed the DF200A’s in-line four-cylinder engine with a higher compression ratio of 10.2:1. The higher compression ratio delivers a noticeable improvement in performance and power output from the engine’s 2,867cm<sup>3</sup> displacement.

## Largest Displacement In Its Class

Displacement has a direct effect on acceleration and torque. Generally speaking, the more the higher. For that reason, the DF200A is designed with a 2,867cm<sup>3</sup> displacement making it the largest available in the 147kW (200PS) four-cylinder four-stroke class.

## VVT (Variable Valve Timing)

Variable Valve Timing is utilized on many of Suzuki’s high-end outboards to deliver high performance across the outboard’s full powerband while retaining the benefits that four-stroke technology provides. The system starts with an innovative cam profile designed for delivering maximum output and performance at high rpm. Variable Valve Timing is used to vary intake timing with the camshaft to optimize timing for low to mid-range operation. This allows the engine to deliver maximum power output across its entire operating range producing greater low to mid-range torque for powerful acceleration. The entire process happens automatically leaving you to enjoy the power and performance.

## Multi-Stage Induction (MSI)

Getting the right amount of air into the cylinder has a great impact on performance. High-speed operation typically requires a greater volume of air, low-speed less. Suzuki’s Multi-Stage Induction system meets these needs by utilizing two intake manifold pipes per cylinder to ensure the engine gets the right amount of air. At low rpm, air enters the combustion chamber through a longer, curved manifold pipe designed to improve combustion and boost low-end torque. As rpm increases, the valves open on the direct intake pipes. Shorter and lacking resistance, these pipes allow a greater volume of air into the chamber, increasing the engine’s ability to breathe efficiently at high rpm resulting in higher power output during high-speed operation.

Air Flow in Multi-Stage Induction Module

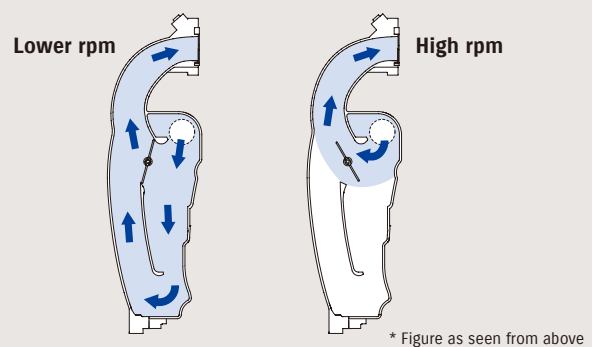

## Smooth Operation

### Counter Balancer System

One of the inherent characteristics common to in-line four cylinder engines when operating at high rpm is a secondary vibration that is directionally in line with the piston’s movements. To neutralize this vibration, Suzuki engineers utilize a secondary balancer system that counters the piston’s movement with a horizontal motion. To achieve this, the balancer is divided into left and right sections each rotating in an opposite direction at twice the speed of the crankshaft, effectively countering the secondary vibrations and producing smoother engine operation.

### Thrust Mount System

The new DF200A incorporates a combination of soft type and high thrust rubber mounts on both the upper and lower mounts to reduce engine vibration and provide stable operation. Soft type rubber mounts are used to absorb vibrations generated in the idling through 2,000 rpm range while high thrust rubber mounts deliver stable operation under high loads increasing power and performance.

### Quiet Operation

Suzuki four-stroke outboards have long been noted for their exceptionally quiet operation. Suzuki engineers go to great lengths incorporating methods designed to keep outboard operation as quiet as possible. In a noise comparison test between the DF200A and a competing 147kW (200PS) in-line four-stroke outboard, the results clearly show that the DF200A runs quieter than its competitor.



## Offset Drive Shaft

Pioneered by Suzuki, the use of the offset drive shaft on four-stroke outboards has long been utilized to reduce the size of the outboard. Found on all Suzuki four-strokes from the DF70A and up, this design positions the crankshaft in front of the drive shaft simultaneously moving the outboard's center of gravity forward. While the design contributes greatly to the outboard's overall compactness and increased power performance, it also moves the engine's axis of inertia, the point where engine vibrations are at a minimum, up over the upper engine mount, thus greatly reducing vibration. These outboards also incorporate two-stage gear reduction designed to take maximum advantage of the power produced by these high performance engines. Providing a final drive ratio of 2.50:1—the largest you can find in either of these outboard classes—it delivers powerful torque for quick acceleration and great top-end speed.

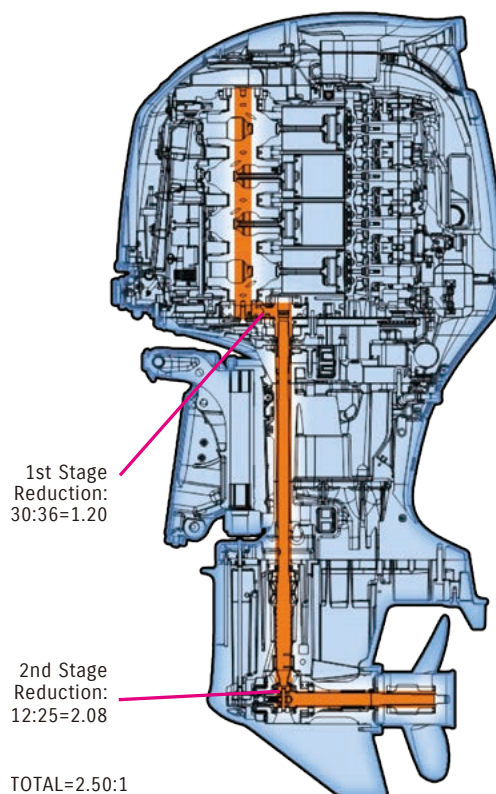

## Advanced Features Only Found On The DF200AP\*

\*DF200AP production is scheduled to start in February 2015.

### Suzuki Selective Rotation

Large boats equipped with multi-outboard installations generally pair a standard rotation outboard with a counter-rotation model to keep the boat traveling in a straight line and on an even keel. Once requiring the purchase of a dedicated counter-rotation model, Suzuki's innovative Suzuki Selective Rotation eliminates that need by incorporating a special, unified design of gears, shaft, and bearings in the lower unit that allow the outboard to operate reliably and efficiently in either direction. Available only on the DF200AP, counter-rotation operation requires an optional activation switch that connects to a circuit inside of the engine compartment plus the installation of a counter-rotation propeller\*.

**SUZUKI  
SELECTIVE ROTATION**

\* Consult with your dealer before changing Standard Rotation to Counter-Rotation (or vice versa).

The optional switch and additional propeller are needed to change the outboards rotation.

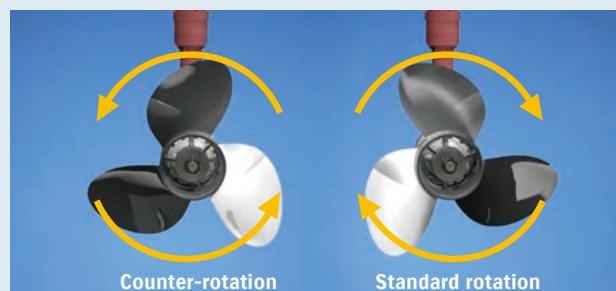

### Suzuki Precision Control (Electronic Throttle and Shift System)

Only available with the DF200AP version, Suzuki Precision Control is a computer-based throttle and shift system that replaces mechanical control cables with a digital fly-by-wire system to eliminate friction and resistance in the controls. The system provides smooth and precise control along with crisp, immediate shifting which are particularly helpful during low rpm operation and when maneuvering. Combined with Suzuki's Lean Burn Control System, the system also helps to improve fuel efficiency over a wide operating range.

Suzuki Precision Control also features safeguards that help protect the engine and drive against damage due to mishandling and is compatible with single, twin, or triple installations as well as dual station operation.

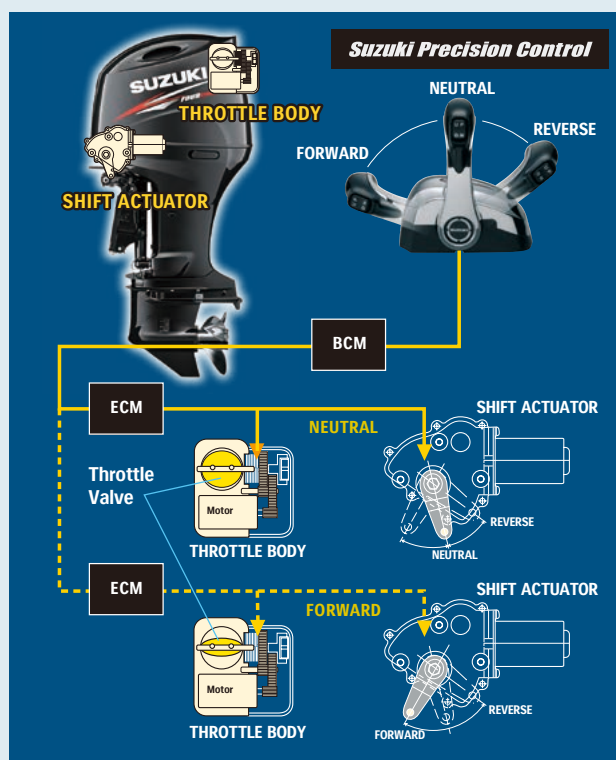

# Advanced Electronics

## 32-Bit ECM (Engine Control Module)

The DF200A is equipped with a 32-bit ECM (Engine Control Module) that provides precision control over motor operation, particularly the ignition and fuel delivery systems. This powerful onboard computer monitors and processes key data gathered in real-time from a series of sensors placed in areas crucial to engine operation. Those sensors include the Manifold Absolute Pressure Sensor, Crankshaft Position Sensor, Intake Air Temperature Sensor, Shift Position Sensor, Throttle Position Sensor, Cylinder Wall Temperature Sensor, Camshaft Position Sensor, and Exhaust Manifold Temperature Sensor. Using these data the computer delivers precision control of the engine's ignition and fuel systems maintaining an optimal spark and fuel supply under all operating conditions.

## Multi-Point Sequential Electronic Fuel Injection

Suzuki pioneered the use of electronic fuel injection in four-stroke outboards with the launch of its original DF70/60 in 1997. Suzuki's Multi-Point Sequential Electronic Fuel Injection supplies each of the engine's cylinders with an optimized mixture of fuel and air that is injected into the cylinder at high pressure according to commands from

the ECM's 32-bit computer. The system delivers improved fuel economy, crisp acceleration and reduced emissions that meet emissions regulations. It also conforms to the Recreational Craft Directive (RCD) Standards, Directive 2003/44EC of the European Parliament and of the Council, and has received a three-star rating from the California Air Resource Board (CARB).

## High Output Alternators

These days boats are equipped with a wide array of electronics that demand an ample flow of power to keep them running. On the other hand, the DF200A is equipped with an alternator engineered to produce a majority of its maximum output of 44A (12V) with the motor running at a low 1,000 rpm—ample for most circumstances.

Alternator Output

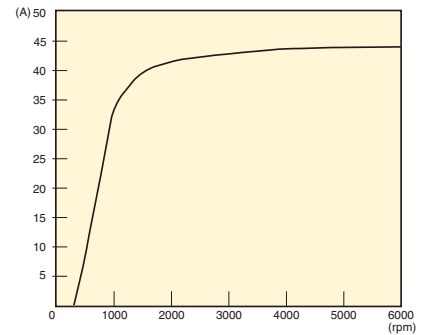

## Multi Point Sequential Electronic Fuel Injection

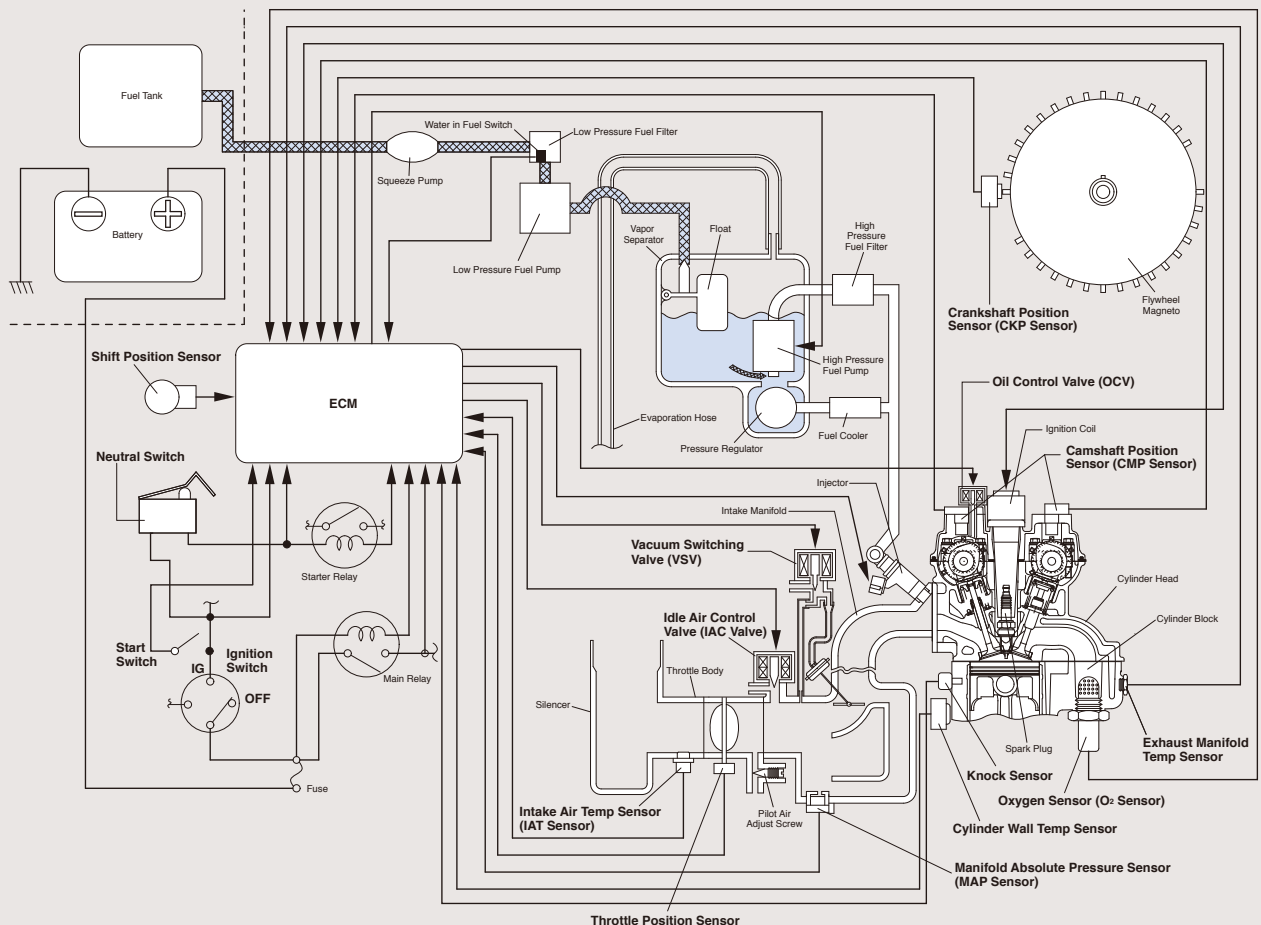



## Designed with Convenience in Mind

### Suzuki Keyless Start System\*\* (DF200AP only)

Suzuki's new Keyless Start system utilizes a proximity key-fob that transmits an access code to the engine's starting system. As long as you have the key-fob on your person, all you need to do is stand within one meter of the console, connect the emergency switch code, turn on the main switch, then start the outboard with a push of a button. With the key remaining safely in your pocket, the system offers simple, stress-free operation while reducing the risk of a lost key. The system also makes for an excellent theft deterrent since the outboard will not start without the proper access code. The key-fob also floats so should it ever go overboard you can retrieve it.



### Tilt Limit System

To protect the boat and motor from damage that can occur when tilting the motor, both outboards incorporate a user adjustable tilt limit switch that prevents the outboard from tilting beyond a predetermined point.



Tilt Limit System

### Knock Sensor

Found on some of our V6 outboards, the knock sensor monitors combustion to provide the ECM with information needed for precise management of engine timing for optimum performance. In addition to maximizing power output, the system also helps increase engine durability.

### Suzuki Water Detecting System

Water in the fuel can lead to problems that include poor combustion, lower power output, and corrosion. The Suzuki Water Detecting System is designed to help protect the engine from moisture in the fuel utilizing a water detecting fuel filter to alert the operator with both visual and audio warnings when water is present in the fuel. The filter is also designed to let you check for water visually.



### Water-cooled Voltage Regulator with Isolator

Water-cooled voltage regulators incorporated on both outboards dissipate heat in the regulator to enhance durability. The battery charging system also incorporates an isolator function that allows the use of two batteries. The system splits electric current into two circuits and is designed to safeguard the main battery in the event that the sub battery becomes drained.

### Fuse Box

Fuses for the outboard's electrical system are housed in a single fuse box located on the side of the outboard motor. This design keeps the outboard's exterior clean while providing convenient access.

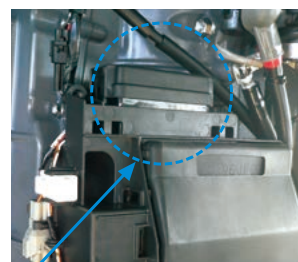

Fuse Box

### Dual Engine Flush Ports

Over time, salt, sand, and dirt buildup can restrict flow in the cooling system causing damage. To help prevent such buildup, both outboards are equipped with two freshwater flush ports that make flushing the cooling system as easy as possible. With one port located on the port side of the down housing and a second on the front panel, you'll always have easy access to the flushing system whether the boat is in or out of the water.



## Durability and Reliability

### Suzuki's Anti-Corrosion Finish

To guard against corrosion, Suzuki protects its outboards with its own specially formulated Suzuki Anti-Corrosion Finish. Applied directly to the outboard's aluminum alloy, this finish provides maximum bonding of the finish to the aluminum surface. Layering an epoxy primer undercoat, black metallic finish, and clear acrylic fiber finish on top of this forms an effective treatment against corrosion, protecting those parts of the outboard's aluminum alloy that are constantly exposed to saltwater.

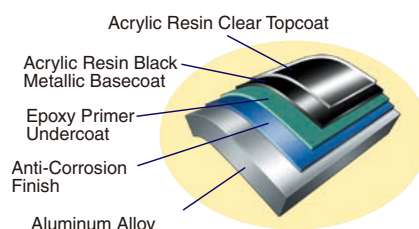

\*\*Availability may differ in some regions. Please contact your local Suzuki dealer for more information.