

Diagrammatic Reasoning by Propagating Constraints Through Geometric Objects: An Application to Truss Analysis

Yoshiteru Ishida

Nara Institute of Science and Technology,
8916-5 Takayama, Ikoma, Nara 630-01 Japan
phone: +81-7437-2-5351 fax: +81-7437-2-5359
E-mail: ishida@is.aist-nara.ac.jp

Abstract: A diagrammatic reasoning for structural analysis on trusses is proposed and demonstrated on many examples. In the reasoning, deflected shape of a substructure is drawn at first then it is reasoned how the remaining substructure is affected by the deflection. By identifying the elongated parts are in tension and shortened parts are in compression, a qualitative stress analysis can be done diagrammatically. The method is implemented on a graphical tool that allows direct operation on geometrical objects constraining with each other by geometric constraints. Some theoretical correspondence between drawing diagram and qualitative determinacy of a stress is also addressed.

1 Introduction

There has been a long debate on whether picture metaphor [Kosslyn 80] or verbal metaphor [Pylyshyn 75] is close to the mental representation and processing of human. Other than the cognitive privilege of diagrams, [Larkin & Simon 87] demonstrated the computational advantage of diagrams coming from the characteristic of the way a diagrammatic information is represented. That is, a diagrammatic information is represented in two dimensions as opposed to the verbal information is represented sequentially in one dimension.

Based on the observation that a diagram has several advantages as a knowledge representation scheme and as a platform for reasoning, diagrammatic reasoning has been proposed [Iwasaki et al 92], and is receiving increasing attention in artificial intelligence research in not only its fundamental exploration by application to many fields [Narayanan Eds 92]. This work is also based on this line.

Motivations behind this work are two folds; (1) As in [Fruchter et al 91], supporting the early design stage of structure, where exact data are not available for a designer, (2) Expanding the conventional CAD system capability by introducing diagrammatic reasoning on the graphical data, which are only used for spatial configurations so far.

Although many applications to structural analysis by qualitative reasoning have been proposed ([Fruchter et al 91] and those cited in this paper), relatively few researches have been done [Iwasaki et al 92] on applying diagrammatic reasoning to the field. This work follows the same line as the latter. That is, rather than symbolically process the qualitative equations we more heavily depend on diagrammatic reasoning for the qualitative analysis of the structures. In this diagrammatic reasoning, the target objects, (truss¹ structures in this report), are represented by diagrams, and several diagrammatic operations (deflection of substructure as stated in the next section) are directly performed on the diagrams.

In qualitative structural analysis on trusses, we are interested in figuring out whether a bar is in tension or in compression (not exact value of the internal forces) given the qualitative geometry of trusses where only qualitative value of angles (acute, right, obtuse) are preserved. Our goal is to carry out the qualitative structural analysis on the truss structure using geometrical shape of the truss (geometrical data of an

¹ In general, a truss is a structure composed of axially stressed bars, some of which are in tension and some in compression, and which the bars are arranged to form one or more triangles (quoted from [Chajes 90]). For other technicalities regarding structural analysis, refer to the books about structural analysis such as [Timoshenko & Young 65].

instance of the qualitatively same class) and heuristic knowledge (which will be discussed in detail in the next section) related to the shape.

2 Basic Ideas

The method is what we call *Drawing Deflected Shape* reasoning. Given the diagram of a truss, the reasoning goes on as follows:

- 1 Draw the deflected truss on the original truss diagram.
- 2 Compare the deflected truss with the original one. If the bar is elongated it is in tension, if it is shortened it is in compression.

Example 1

Fig. 1 shows the example of truss (solid line) and its deflected shape (dotted line) under given loads (arrow). It is almost evident whether each bar is in tension or in compression by the diagram. Deflected shape put on the original shape appeals to our visual perception not only from static viewpoints but also from kinematic viewpoints. In variable trusses such as found in space structure in which the length of each bar is controlled, it must be analyzed how the goal shape can be attained from the current shape by elongating (or shortening) each bar. This problem also can be solved in the *Draw Deflected Shape Reasoning*.

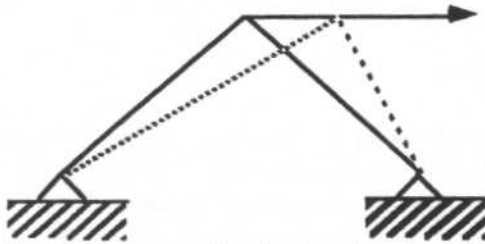

Fig. 1 An example of a structure (arch) and its virtual deflected shape

In this deflection, we assume that only the length of each bars and angles among bars are variable. We call this deflection involving the change of length of bars as well as the angles among bars *angle-length deflection*, and distinguish it from *angle deflection* where only angles are changed. In the implementation in section 3, we focus on angle deflection where the bars assumed to be rigid do not change the length, and the bars assumed to be not rigid are removed.

Since the diagrammatic reasoning adopted here is straightforward, it may be expected that it has intuitive explanatory and anticipatory power when presented graphically on screens.

2.1 Drawing deflected shape

From the structural viewpoint of static determinacy, there are three types of trusses; determinate, indeterminate, and unstable structure. The first two, have enough reactions to be fixed under loads. However, the last type (unstable structure) does not have enough number of reactions to prevent motion (in case of externally unstable) or deflection (in case of internally unstable). Hereafter, we use the term unstable meaning internally unstable unless otherwise specified. The following procedure for obtaining deflected shape is based on this observation.

1. Given the original diagram of truss and loads, remove some bars to make it unstable.
2. Draw a deflected shape of the unstable truss.
3. Continue the same procedure if there is a different unstable substructure in the original truss.

Removing one bar, in general, does not result in unstable structure. However, in simple trusses, removing one bar always turn out to be unstable structure².

In the first step of obtaining unstable substructure, many types of heuristics are used. Basically, searching for simple unstable substructure such as square works well. Since we could know whether it is elongated or shortened for removed bars, as many bars as possible including those of interest should be removed in the first step for efficiency. In the second step of drawing the deflected shape, *angle deflection* is carried out for the remained substructure. Removing one bar will create one degree of freedom, hence two mode of deflections (one shortening the removed bar and another elongating the removed bar). Among these two geometrically possible deflection modes, we must

² Let j and m be the number of joints and bars in a truss. Then, it is known that the relation $m=2j$, $m>2j$, and $m<2j$ hold for determinate, indeterminate and unstable case respectively. Since $m=2j$ holds for a simple truss constrained in a plane, removing one bar always results in unstable structure.

select one physically possible mode; we must select a deflection mode which has at least one joint whose displacement is the same as the load. When no displacement is obtained for a loaded bar, then the bar is inactive (i.e., the bar do not carry either tension or compression).

The next example shows how the deflected shape is obtained.

Example 2

In the truss shown in solid line in Fig.2, first, two internal crossing bars are removed. Then it is easily imagined that the remained square will be deflected as shown in dotted line. Since the bar 1 will be shortened and bar 2 will be elongated in this deflection, their internal force will be compression and tension respectively.

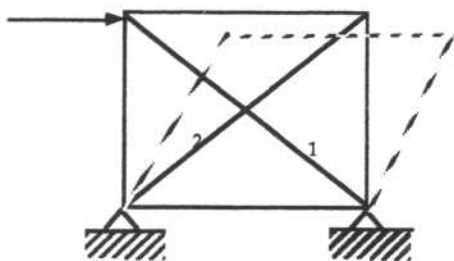

Fig. 2 Deflected shape of a truss

3 Implementation by Constraint Propagation Through Geometric Objects

3.1. Primitives of Geometric Objects and Geometric Constraints

Commercial software³ is already available, which allow to draw simple geometric objects such as circles, lines, and points that are geometrically constrained with each other. Two different types of geometric constraints may be used. One is the hierarchical relation that a child geometric object constrained by its parent geometric object. For example, if a point is the child of a line, then the point can be moved only on the line (i.e. constrained by the line). The other is the geometric relations that maps one object (or a set of objects) to the other object (or a set of objects). For example, a triangle consisting of three lines can generate its mirror image through an axis of symmetry. Other than axial symmetry, rotation and dilation can be used to generate the image of the original object. Other

³We used *The Geometer's Sketchpad* by Dynamic Geometry.

geometric relations include perpendicular, middle point, intersection point, etc.

3.2. Primitives for Constructing Trusses

Construction of physical objects such as trusses by the primitives of geometric objects is not straightforward. Consider a triangle of three rigid bars whose one joint is fixed hence can be rotated around the joint, that is, the triangle has one degree of freedom (rotation around the joint). Fig. 3 shows all the objects for the geometric constraints. The point D is a child of the circle 1 (hence constrained on the circle). The point D' is the image generated by rotating D 45 degree around the point A. The point H is the intersection of the circle 2 and the extended line of AD'. The rigid triangle ADH fixed around the point A can be constructed in this manner.

We have prepared these primitives for constructing 2-dimensional simple trusses. The trusses can be constructed by relating these primitives with two types of geometric constraints mentioned above.

This triangle is stiff which is fixed the rotation center A. Drag D around A

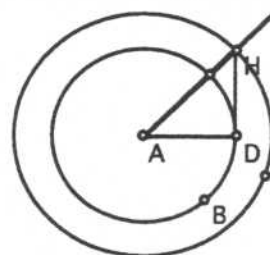

Fig. 3 Physical Object of the Rigid Triangle Constructed by Primitives of Geometric Objects and Constraints (Hidden geometric objects used for geometric constraints are also shown.).

3.3. Truss Construction and Stress Analysis

As discussed in the previous section, we need to determine which bars are of interest for stress analysis. All the other bars are then assumed to be rigid (the length is fixed). The construction of the truss for stress analysis depends upon which bars are assumed to be rigid, since degree of freedom and types of freedom (such as rotation, translation) depend upon the assumption. The path of how the geometric constraints propagate reflects one of possible multiple paths of how the forces propagate. Thus, the truss for stress

analysis must be constructed in different ways based on the different set of rigid bars.

Fig. 4a and Fig. 4b show two deflected shape of the part of the common truss. The right figures for Figs. 4a and 4b show all the hidden objects used for geometric constraints. In Fig. 4a, the rigid triangle ADH fixed around the joint A (with one degree of freedom; rotation around A) is connected to the rigid bar DD' constrained on the horizontal line through D. A' and H' are mirror image of A and H by the axis of vertical line through the middle point of DD'. The bar HH' is the child obtained by simply connecting H and H'

so far obtained. By the deflected shape, the length of HH' is known to be shortened.

In Fig. 4b, the rigid bars AD and AH are connected to the rigid bars DD' and HH', which again connected to the rigid bars A'D' and A'H'. The triangle ADH in this figure is constructed as follows. The point D is constrained on the circle whose center is A. H is the intersection of the vertical line through D and circle of the radius AH whose center is again A. This triangle ADH is connected to the same primitive as that of Fig. 4a. As known from the deflected shape, DH (and D'H') is known to be elongated.

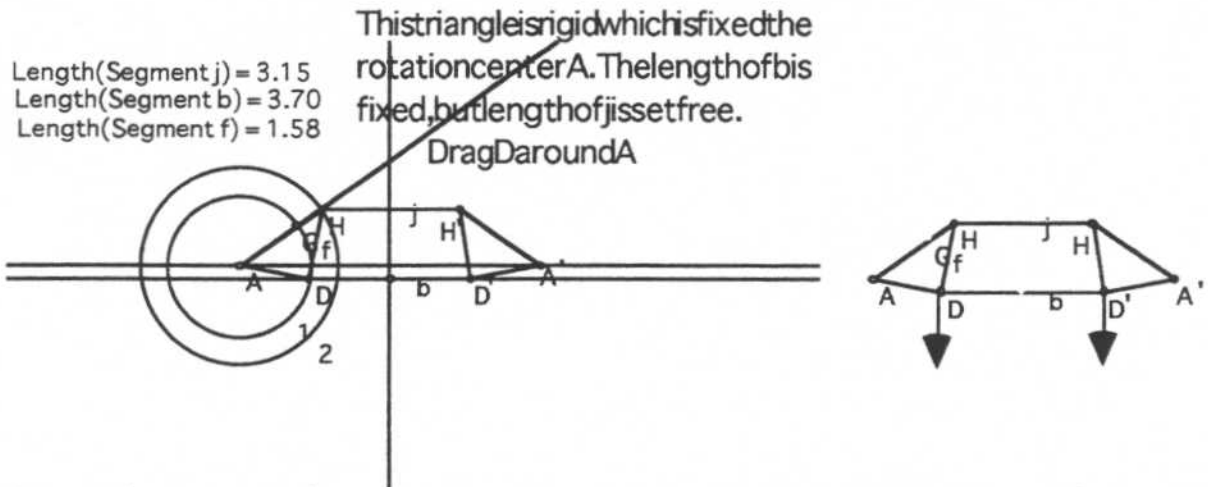

Fig. 4a The Deflected Shape of A Part of Simple Truss. Triangles ADH, A'D'H' and the bar DD' are assumed to be rigid. A is center of rotation for the triangle ADH and A' is constrained on the horizontal line through A. Left figure shows all the hidden objects. Arrows in right figure show the load.

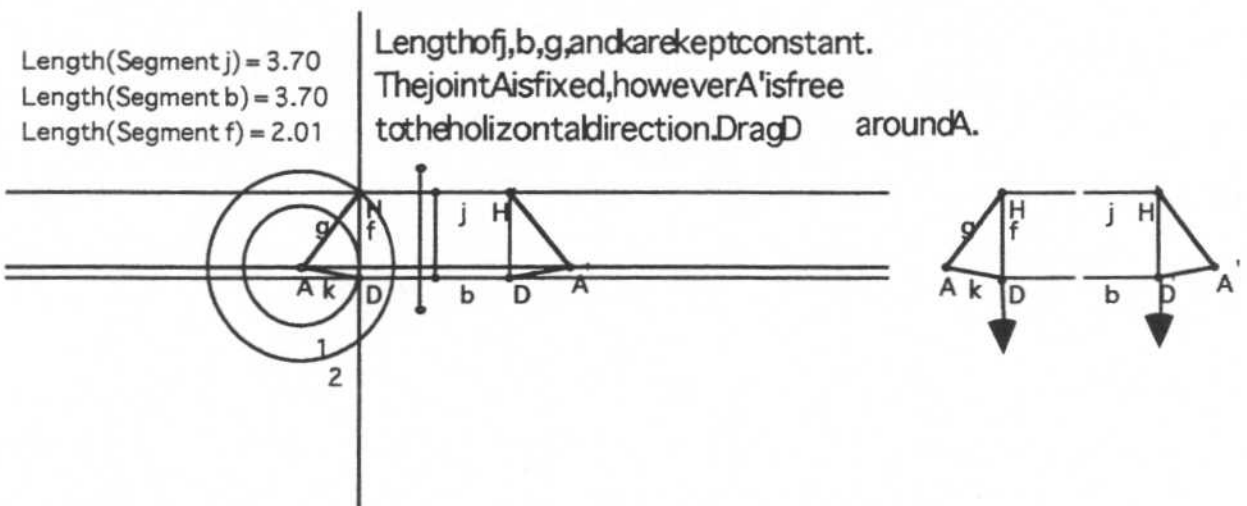

Fig. 4b The Deflected Shape of A Part of Simple Truss. The bars AD, AH, A'D', A'H', HH' and DD' are assumed to be rigid. A is center of rotation for the bars AD, AH. DD', HH' and A' is constrained in the same manner as that of Fig. 4a. Left figure shows all the hidden objects. Arrows in right figure show the load.

4 Qualitative Analysis and Classification on Simple Trusses

In order to know whether the results of the above *Drawing Deflected Shape* reasoning are valid for that specific instance or for all the instances of the same qualitative structure, we have to know that the substructure obtained by removing bar(s) has qualitatively invariant pattern of shortened or elongated for all the instances of the same qualitative structures. The complete characterization of the structure having such qualitative invariant pattern has not yet been known. However, we have characterized some typical structures which can

be proved to have the qualitative invariant pattern of deflection. Whether or not the structure have a qualitative invariant pattern depends also on how the load is applied. We assume here that the load is only in the vertical direction.

4.1 Simple trusses

In case of simple trusses, substructure obtained by removing a bar has the structure of two rigid parts connected in the following ways:

- (a) Two rigid parts connected by a joint (Fig. 5 (a)).
- (b) Two rigid parts connected by a joint and two bars (Fig. 5 (b)).
- (c) Two rigid parts connected by two bars (Fig. 5 (c)).

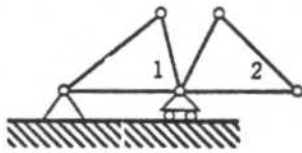

(1) Rigid part 1 is fixed.

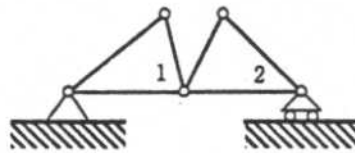

(2) Neither of the rigid parts is fixed.

- (a) Two rigid parts 1 and 2 are connected by a joint.

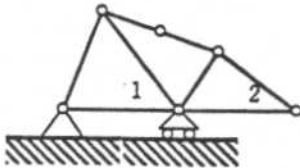

(1) Rigid part 1 is fixed.

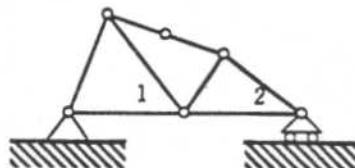

(2) Neither of the rigid parts is fixed.

- (b) Two rigid parts 1 and 2 are connected by a joint and two bars.

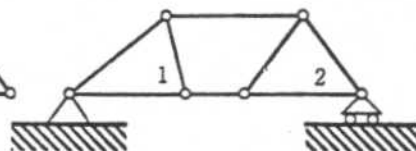
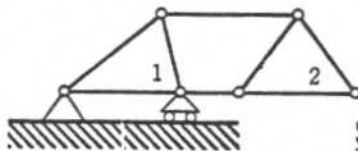

Fig. 5 Classification of the substructure by removing a bar from simple trusses.

Among the cases shown in Fig. 5, the following cases have a qualitative invariant pattern of deflection no matter to which joints the vertical loads are applied. (Proofs are rather lengthy and omitted here.)

- (a) Two rigid parts connected by a joint (Fig. 5 (a)).
- (b)-(1) Two rigid parts connected by a joint and two bars where one rigid part is fixed (Fig. 5 (b)-(1)).
- (b)-(2)' Two rigid parts connected by a joint and two bars where neither of the rigid parts is fixed and that the two bars connecting the rigid parts form a line (Fig. 6 (b)-(2)').
- (c)-(1)' Two rigid parts connected by two bars where one rigid part is fixed and the two bars connecting the rigid parts are in parallel (Fig. 6(c)-(1)').
- (c)-(1)" Two rigid parts connected by two bars where one rigid part is fixed and the two

bars connecting the rigid parts crosses on the point of the joint of the rigid part (Fig. 6 (c)-(1)").

- (c)-(2)' Two rigid parts connected by two bars where neither of the rigid part is fixed and the two bars connecting the rigid parts are in parallel (Fig. 6 (c)-(2)').
- (c)-(2)" Two rigid parts connected by two bars where neither of the rigid part is fixed and the two bars connecting the rigid parts crosses on the point of the hinge of the rigid part (Fig. 6 (c)-(2)").

In other words, the substructure obtained by removing a bar in simple trusses does not generally (except case (a) and (b)-(1)) have the qualitative invariant pattern of deflection, hence the results by *Drawing Deflected Shape* reasoning is valid only for the instance corresponding to that specific diagram.

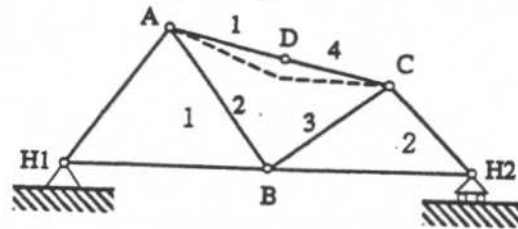

(2)' Neither of the rigid parts is fixed and that the two bars connecting the rigid parts form a line.

(b) Two rigid parts 1 and 2 are connected by a joint and two bars.

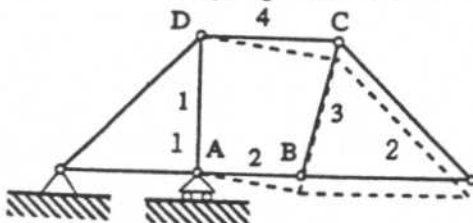

(1)' Rigid part 1 is fixed and the two bars connecting the rigid parts are in parallel.

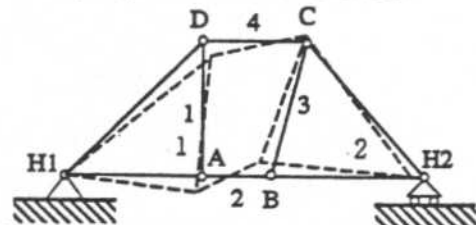

(2)' Neither of the rigid parts is fixed and the two bars connecting the rigid parts are in parallel.

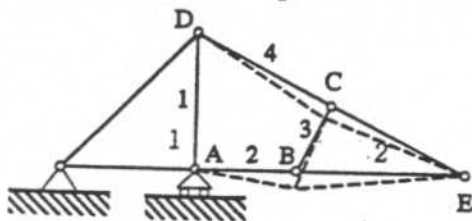

(1)" Rigid part 1 is fixed and the two bars connecting the rigid parts crosses on the point of the joint of the rigid part.

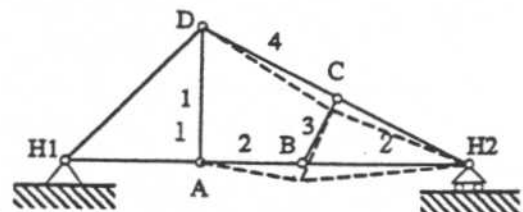

(2)" Neither of the rigid parts is fixed and the two bars connecting the rigid parts crosses on the point of the hinge of the rigid part.

(c) Two rigid parts 1 and 2 are connected by two bars.

Fig. 6 Substructure of simple trusses having qualitative invariant pattern of deflection.

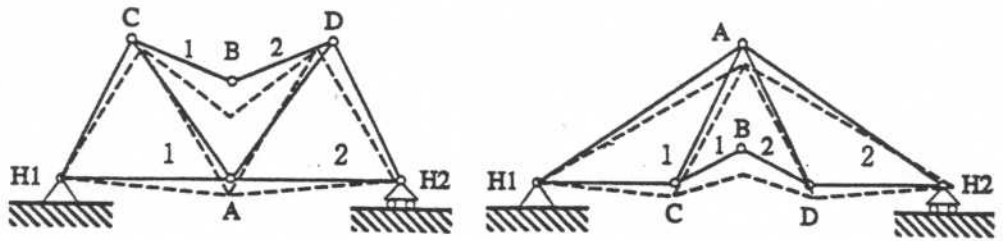

- (i) Two rigid parts connected by a joint and two bars where two joints of the two bars connecting the rigid parts are inside between two hinges and the sum of internal angles of the square formed by two connecting bars and one connecting joint is greater than π .

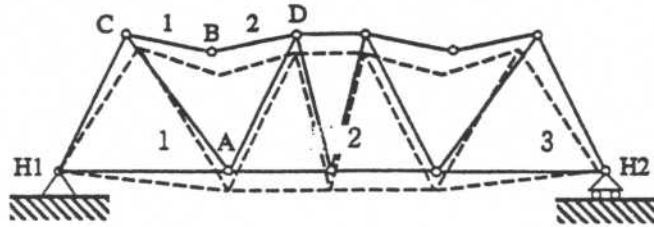

- (ii) Both pair of rigid parts 1, 2 and 2, 3 are connected by a joint and two bars where two joints of the two bars connecting the rigid parts are inside between two hinges and the sum of internal angles of the square formed by two connecting bars and one connecting joint is greater than π for each square.

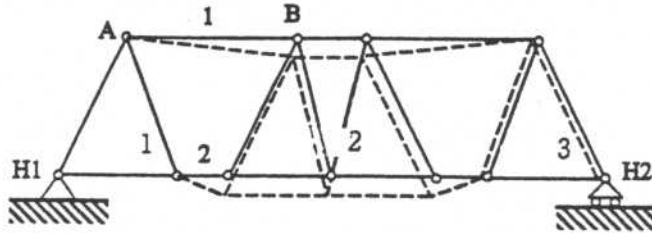

- (iii) Both pair of rigid parts 1, 2 and 2, 3 are connected by two bars where each pair of bars connecting rigid parts are in parallel.

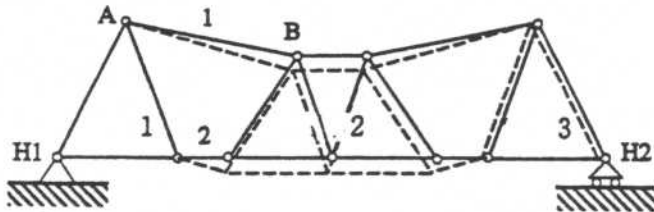

- (iv) Both pair of rigid parts 1, 2 and 2, 3 are connected by two bars where joints of upper connecting bar is inside between two hinges and the angle (measured from horizontal line) of the upper connecting bar is smaller than that of lower connecting bar.

Fig. 7 Trusses with bilateral symmetry having the qualitative invariant pattern of deflection.

4.2 Trusses with bilateral symmetry

Other than simple trusses, trusses with bilateral symmetry are important since they often appear in the real structures. We have characterized some typical structures with bilateral symmetry that have the qualitative invariant pattern of deflection. We present some results without lengthy proofs.

- The following structure have the qualitative invariant pattern of deflection when one central bar is removed.
 - (i) Two rigid parts connected by a joint and two bars where two joints of the two bars connecting the rigid parts are inside between two hinges and the sum of internal angles of the square formed by two connecting bars and one connecting joint is greater than π (Fig. 7 (i)).
- The following structure have the qualitative invariant pattern of deflection when two bars of symmetrical position are removed. In this case the trusses will have three rigid parts and we name them 1, 2 and 3 from the left to the right.
 - (ii) Both pair of rigid parts 1, 2 and 2, 3 are connected by a joint and two bars where two joints of the two bars connecting the rigid parts are inside between two hinges and the sum of internal angles of the square formed by two connecting bars and one connecting joint is greater than π for each square (Fig. 7 (ii)).
 - (iii) Both pair of rigid parts 1, 2 and 2, 3 are connected by two bars where each pair of bars connecting rigid parts are in parallel (Fig. 7 (iii)).
 - (iv) Both pair of rigid parts 1, 2 and 2, 3 are connected by two bars where joints of upper connecting bar is inside between two hinges and the angle (measured from horizontal line) of the upper connecting bar is smaller than that of lower connecting bar (Fig. 7 (iii)).

5 Conclusion

We proposed a diagrammatic reasoning for structural analysis on trusses. It is based on drawing the deflected shape of a substructure and reasoning the effects of the deflection on the other parts. Since the method is straightforward and appealing to human visual perception, it could provide intuitive explanatory and anticipatory power when interactively presented on graphic interface. The system is implemented

on the graphical tool which allows directly operating geometrical objects constrained with each other. Library for constructing 2-dimensional simple trusses is constructed. The results associating drawing a diagram with qualitative determinacy of stress pattern are also presented. That is, if a part is qualitatively under compression (tension) the part can be drawn only in shortened (elongated) manner. When the part is qualitatively indeterminate, however, multiple drawings exist.

References

- Iwasaki, Y., Tessler, S. and Law, K. "Diagrammatic Reasoning in Problem Solving" Knowledge System Laboratory, KSL 92-12, 1992.
- Fruchter, R., Law, K. and Iwasaki, Y. "QStruc: An Approach for Qualitative Structural Analysis" KSL 91-80, 1991.
- Fruchter, R., Law, K. Law, K. and Iwasaki, Y. "Generating Qualitative Models for Structural Engineering Analysis and Design" KSL 91-21, 1991.
- Narayanan, N.H. Eds, AAAI Spring Symposium on Reasoning with Diagrammatic Representations, 1992
- Larkin, J.H. and Simon, H. A. "Why a diagram is (sometimes) worth ten thousands words" *Cognitive Science*, Vol. 11, 1987.
- Kosslyn, S.M. *Image and Mind* Harvard University Press, 1980.
- Pylyshyn, Z. W. "Do we need images and analogues?", *Proc of the Conference on Theoretical Issues in Natural Language Processing* MIT 1975
- Fleming, J.F. *Computer Analysis of Structural Systems*, McGraw-Hill, 1989.
- Chajes, A. *Structural Analysis*, Prentice Hall, 1990.
- Timoshenko, S. P. and Young, D. H. *Theory of Structures*, McGraw-Hill, 1965.