

Diamond Series LED UHDTV

DM65USR 65" Class

DM85UXR 85" Class



DM65USR

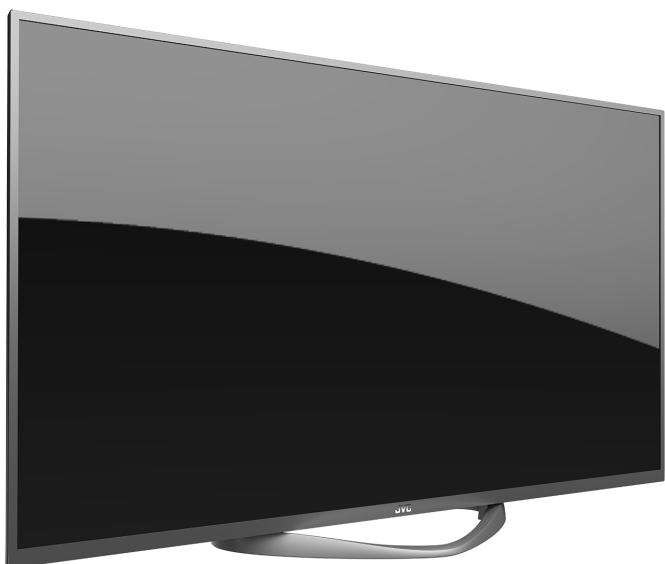

DM85UXR

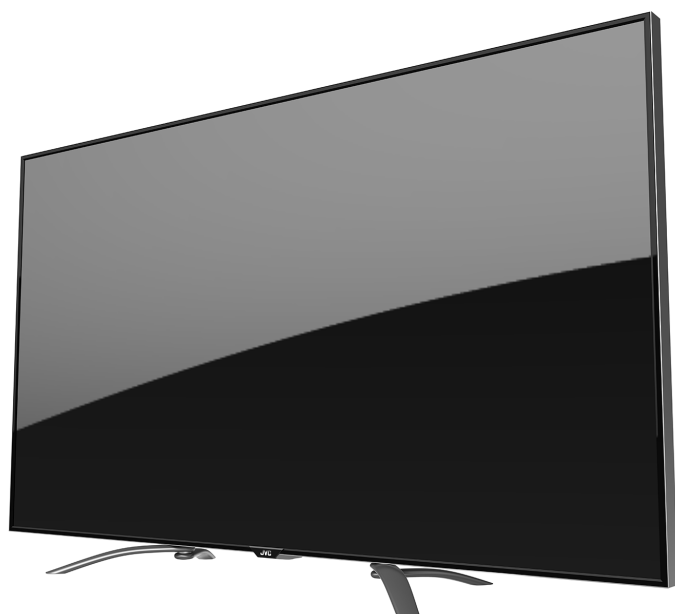

Before operating your LED TV, please read this manual thoroughly.

(*Images shown in this user manual are for illustration purposes only.)

WE ARE HERE TO HELP!



FOR HELP WITH TELEVISION SUPPORT:

1-855-868-1928

WE CAN HELP YOU WITH:

DAMAGED PACKAGE • MISSING PARTS • TECHNICAL SUPPORT

FOR HELP WITH ROKU® STREAMING STICK™:

CALL ROKU CUSTOMER SUPPORT: 1-88-600-7658 (ROKU)

WWW.ROKU.COM/SUPPORT

JVC

Contents

Congratulations on purchasing your new JVC LED TV. To get the most out of your JVC LED TV, read these instructions before making any adjustments, and retain them for future reference.

For assistance, call the JVC Customer Support and Service Center 1-855-868-1928 or visit our website: <http://jvc-tv.com/support>

We recommend that you register your JVC LED TV either at our website: <http://jvc-tv.com/support> or fill out and mail the Product Registration Card on the back of the manual.

Retain your purchase receipt and write down the model and serial number located at the back of your LED TV for easy reference when obtaining service support.

Serial Number: _____

Model Number: _____



MHL, Mobile High-Definition Link and the MHL Logo are trademarks or registered trademarks of the MHL, LLC.



The terms HDMI and HDMI High-Definition Multimedia Interface, and the HDMI Logo are trademarks or registered trademarks of HDMI Licensing LLC in the United States and other countries.



Manufactured under license from Dolby Laboratories. Dolby and the double-D symbol are trademarks of Dolby Laboratories.

THE TRADEMARKS SHOWN HEREIN ARE THE PROPERTY OF THEIR RESPECTIVE OWNERS; IMAGES USED ARE FOR ILLUSTRATION PURPOSES ONLY. JVC, THE JVC LOGO, AND OTHER JVC TRADEMARKS ARE THE INTELLECTUAL PROPERTY OF JVC KENWOOD Corporation. PRODUCT SPECIFICATIONS ARE SUBJECT TO CHANGE WITHOUT NOTICE.

Copyrights © 2014 AmTRAN Video Corporation. ALL RIGHTS RESERVED.

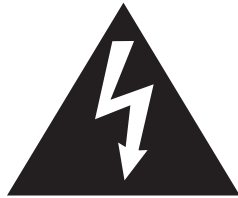

CAUTION
RISK OF ELECTRIC SHOCK
DO NOT OPEN



CAUTION: To Reduce The Risk Of Electric Shock, Do Not Remove Cover (Or Back). No User-Serviceable Parts Inside. Refer Servicing To Qualified Service Personnel.



The lightning flash with arrowhead symbol, within an equilateral triangle is intended to alert the user to the presence of uninsulated dangerous voltage within the product's enclosure that may be of sufficient magnitude to constitute a risk of electric shock.



The exclamation point within an equilateral triangle is intended to alert the user to the presence of important operating and maintenance (servicing) instructions in the literature accompanying the appliance.

WARNING: TO PREVENT FIRE OR SHOCK HAZARD, DO NOT EXPOSE THIS APPLIANCE TO RAIN OR MOISTURE. TO PREVENT THE SPREAD OF FIRE, KEEP CANDLES OR OPEN FLAMES AWAY FROM THIS PRODUCT AT TIMES.

CAUTION: TO PREVENT ELECTRIC SHOCK. DO NOT USE THIS POLARIZED PLUG WITH AN EXTENSION CORD, RECEPTACLE OR OTHER OUTLET UNLESS THE BLADES CAN BE FULLY INSERTED TO PREVENT BLADE EXPOSURE.

WARNING: This device complies with Part 15 of the FCC Rules. Operation is subject to the following two conditions: (1) this device may not cause harmful interference, and (2) this device must accept any interference received, including interference that may cause undesired operation. Note: This equipment has been tested and found to comply with the limits for a Class B digital device, pursuant to Part 15 of the FCC Rules. These limits are designed to provide reasonable protection against harmful interference in a residential installation. This equipment generates, uses, and can radiate radio frequency energy and, if not installed and used in accordance with the instructions, may cause harmful interference to radio communications. However, there is no guarantee that interference will not occur in a particular installation. If this equipment does cause harmful interference to radio or television reception, which can be determined by turning the equipment off and on, the user is encouraged to try to correct the interference by one of the following measures: - Reorient or relocate the receiving antenna. - Increase the separation between the equipment and receiver. - Connect the equipment into an outlet on a circuit different from that to which the receiver is connected. - Consult the dealer or an experienced radio/TV technician for help. FCC Caution: To assure continued compliance, (example – use only shielded interface cables when connecting to computer or peripheral devices). Any changes or modifications not expressly approved by the party responsible for compliance could void the user's authority to operate this equipment.

Responsible Party: AmTRAN Video Corporation
Address: 9 Goddard, Irvine, CA 92618 USA
Telephone No: 1-855-868-1926

CAUTION: Changes or modifications not expressly approved by the party responsible for compliance with the FCC Rules could void the user's authority to operate this equipment.

Location of the required Marking

The rating sheet and the safety caution are on the rear of the unit.

Important Safety Instructions

- 1) Read these instructions.
- 2) Keep these instructions.
- 3) Heed all warnings.
- 4) Follow all instructions.
- 5) Do not use this apparatus near water.
- 6) Clean only with dry cloth.
- 7) Do not block any ventilation openings. Install in accordance with manufacturer's instructions.
- 8) Do not install near any heat sources such as radiators, heat registers, stoves, or other apparatus (including amplifiers) that produce heat.
- 9) Do not defeat the safety purpose of the polarized or grounding-type plug. A polarized plug has two blades with one wider than the other. A grounding-type plug has two blades and a third grounding prong. The wide blade or the third prong are provided for your safety. If the provided plug does not fit into your outlet, consult an electrician for replacement of the obsolete outlet.
- 10) Protect the power cord from being walked on or pinched, particularly at plugs, convenience receptacles, and the point where they exit from the apparatus.
- 11) Only use attachments/accessories specified by the manufacturer.
- 12) Use only with the cart, stand, tripod, bracket, or table specified by the manufacturer, or sold with the apparatus. When a cart is used, use caution when moving the cart/apparatus combination to avoid injury from tip-over.
- 13) Unplug this apparatus during lightning storms or when unused for long periods of time.
- 14) Refer all servicing to qualified service personnel. Servicing is required when the apparatus has been damaged in any way, such as power-supply cord or plug is damaged, liquid has been spilled or objects have fallen into the apparatus, the apparatus has been exposed to rain or moisture, does not operate normally, or has been dropped.
- 15) Apparatus should not be exposed to dripping or splashing, and objects filled with liquids, such as vases, should not be placed on the apparatus.
- 16) An outside antenna system should not be located in the vicinity of overhead power lines or other electric light or power circuits, or where it can fall into such power lines or circuits. When installing an outside antenna system, extreme care should be taken to keep from touching such power lines or circuits, as contact with them might be fatal.
- 17) Do not overload wall outlets and extension cords, as this can result in a risk of fire or electric shock.
- 18) Do not push objects through any openings in this unit, as they may touch dangerous voltage points or short out parts that could result in fire or electric shock. Never spill or spray any type of liquid into the unit.
- 19) If an outside antenna or cable system is connected to the unit, be sure the antenna or cable system is grounded to provide some protection against voltage surges and built-up static charges, Section 810 of the National Electrical Code, ANSI/NFPA 70, provides information with respect to proper grounding of the mast and supporting structure, grounding of the lead-in wire to an antenna discharge unit, size of grounding conductors, location of antenna discharge unit, connection to grounding electrodes, and requirements for the grounding electrode.
- 20) When replacement parts are required, be sure the service technician uses replacement parts specified by the manufacturer or those that have the same characteristics as the original part. Unauthorized substitutions may result in fire, electric shock or other hazards.



Important Safety Instructions

- 21) Upon completion of any service or repairs to this unit, ask the service technician to perform safety checks to determine that the unit is in proper operating condition.
- 22) When you connect the product to other equipment, turn off the power and unplug all of the equipment from the wall outlet. Failure to do so may cause an electric shock and serious personal injury. Read the owner's manual of the other equipment carefully and follow the instructions when making any connections.
- 23) Sudden high volume sound may cause hearing or speaker damage. When you use headphones, (if the unit is equipped with a headphone jack) keep the volume at a moderate level. If you use headphones continuously with high volume sound, it may cause hearing damage.
- 24) Do not allow the product to output distorted sound for an extended period of time. It may cause speaker overheating and fire.
- 25) This reminder is provided to call the cable TV system installer's attention to Article 820-40 of the NEC that provides guidelines for proper grounding and, in particular, specifies that the cable ground shall be connected to the grounding system of the building, as close to the point of cable entry as practical.
- 26) The socket-outlet must be installed near the unit and easily accessible.

CHILD SAFETY:

It Makes A Difference How and Where You Use TV

Congratulations on your purchase! As you enjoy your new product, please keep these safety tips in mind:

THE ISSUE

The home theater entertainment experience is a growing trend and larger TVs are popular purchases. However, TVs are not always supported on the proper stands or installed according to the manufacturer's recommendations.

TVs that are inappropriately situated on dressers, bookcases, shelves, desks, speakers, chests or carts may fall over and cause injury.

THIS MANUFACTURER CARES!

The consumer electronics industry is committed to making home entertainment enjoyable and safe.

TUNE INTO SAFETY

One size does NOT fit all. Follow the manufacturer's recommendations for the safe installation and use of your TV.

Carefully read and understand all enclosed instructions for proper use of this product.

Don't allow children to climb on or play with furniture and television sets.

Don't place TVs on furniture that can easily be used as steps, such as a chest of drawers.

Remember that children can become excited while watching a program, especially on a "larger than life" TV. Care should be taken to place or install the display where it cannot be pushed, pulled over, or knocked down.

Care should be taken to route all cords and cables connected to the TV so that they cannot be pulled or grabbed by curious children.

Important Safety Instructions

CONDENSATION

Moisture will form in the operating section of the unit if the unit is brought from cool surroundings into a warm room or if the temperature of the room rises suddenly. When this happens, unit's performance will be impaired. To prevent this, let the unit stand in its new surroundings for about an hour before switching it on, or make sure that the room temperature rises gradually. Condensation may also form during the summer if the unit is exposed to the breeze from an air conditioner. In such cases, change the location of the unit.

HOW TO HANDLE THE LED PANEL

- Do not press hard or jolt the LED panel. It may cause the LED panel glass to break and injury may occur.
- If the LED panel is broken, make absolutely sure that you do not touch the liquid in the panel. This may cause skin inflammation.
- If the liquid gets in your mouth, immediately gargle and consult with your doctor. Also if the liquid gets in your eyes or touches your skin, consult with your doctor after rinsing for at least 15 minutes or longer in clean water.

Possible Adverse Effects on LED Panel:

If a fixed (non-moving) pattern remains on the LED Panel for long periods of time, the image can become permanently ingrained in the LED Panel and cause subtle but permanent ghost images. This type of damage is **NOT COVERED BY YOUR WARRANTY**. Never leave your TV on for long periods of time while it is displaying the following formats or images:

- Fixed Images, such as stock tickers, video game patterns, TV station logos, and website.
- Special Formats that do not use the entire screen. For example, viewing letterbox style (16:9) media on a normal (4:3) display (black bars at top and bottom of screen); or viewing normal style (4:3) media on a widescreen (16:9) display (black bars on left and right sides of screen).

The following symptoms are not signs of malfunction but technical limitation.

- LED Panels are manufactured using an extremely high level of precision technology, however sometimes parts of the screen may be missing picture elements or have luminous spots. This is not a sign of a malfunction.
- Do not install the TV near electronic equipment that produces electromagnetic waves. Some equipment placed too near this unit may cause interference.
- Effect on infrared devices – There may be interference while using infrared devices such as infrared cordless headphones.

Important Safety Instructions

Television Antenna Connection Protection

External Television Antenna Grounding

If an outside antenna/satellite dish or cable system is to be connected to the TV, make sure that the antenna or cable system is electrically grounded to provide some protection against voltage surges and static charges.

Article 810 of the National Electrical Code, ANSI/NFPA 70, provides information with regard to proper grounding of the mast and supporting structure, grounding of the lead-in wire to an antenna discharge unit, size of the grounding conductors, location of antenna discharge unit, connection to grounding electrodes, and requirements of the grounding electrode.

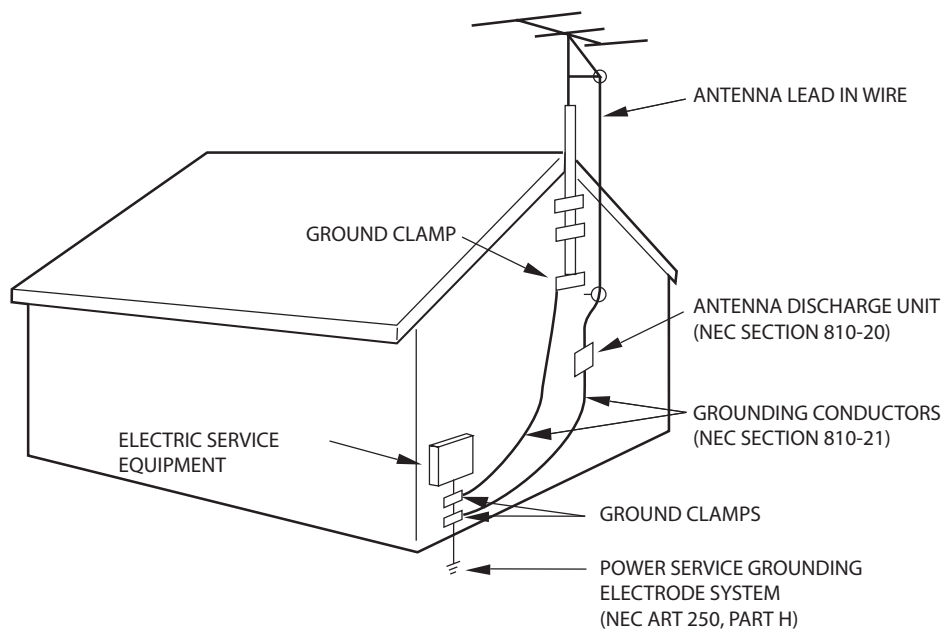

Lightning Protection

For added protection of the TV during a lightning storm or when it is left unattended or unused for long periods of time, unplug the TV from the wall outlet and disconnect the antenna or cable system.

Power Lines

Do not mount the antenna near overhead light or power circuits, or where it could fall into such power lines or circuits.

Important Safety Instructions

DTV Transition Advisory

As of June 12, 2009, all U.S. television stations have switched to digital broadcasting. As a result, owners of analog television sets must connect a digital-to-analog converter box to the television set or subscribe to cable or satellite TV to receive over-the-air TV. Analog-only TVs continue to work as before to receive low power, Class A or translator television stations and with cable and satellite TV services, gaming consoles, VCRs, DVD players, and similar products.

For more information about the DTV transition, visit www.dtv.gov.

FCC's Consumer Center

Email: dtvinfo@fcc.gov

Phone: 1-888-CALL-FCC (1-888-225-5322)

Fax: 1-866-418-0232; or writing to:

Mail: Federal Communications Commission

Consumer and Governmental Affairs Bureau

Consumer Inquiries and Complaints Division

445 12th Street, SW

Washington, DC 20554

Attaching the Stand

The stand installation varies depending on model. Perform the installation according to the instructions of your TV model.

Unpacking the TV

- 1 Remove TV accessories and protective foam.
- 2 Remove TV from the box and place it on a flat and clean surface with TV screen facing down.
- 3 Attach the metal bracket to the stand using the provided screws. (DM65USR model only)
- 4 Attach the stand to TV using the provided screws.

Removing the Stand

When the TV needs to be transported, remove the stand and pack the TV back in the carton.

To remove the stand, perform the assemble steps in reverse order according to your TV model.

DM65USR Base Assembly

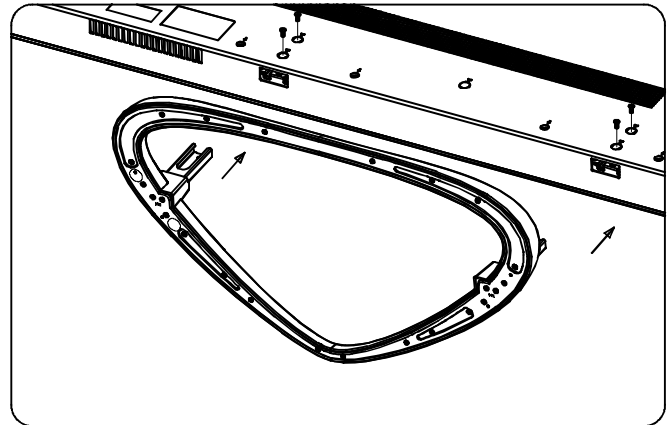
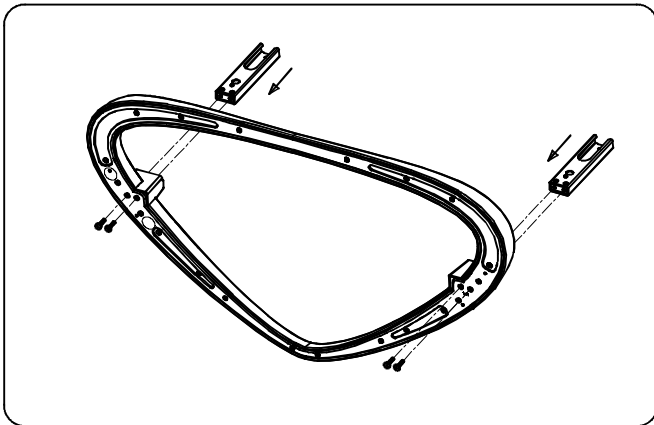

DM85UXR Base Assembly

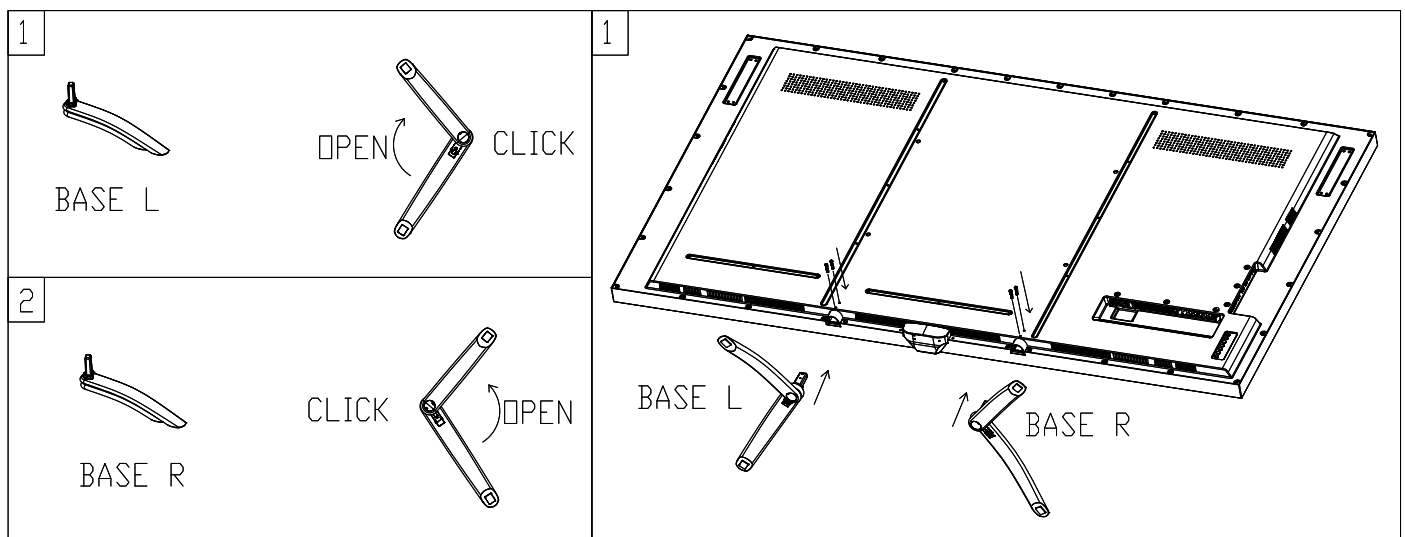

Package Contents

Check if the following items are included in your package.

Ultra High Definition TV

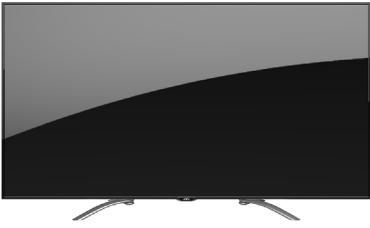

Remote Control



Batteries

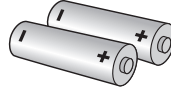

Power Cord



Quick Start Guide



Roku® Streaming Stick™
(Roku Ready® Version)



Safety Strap / Screw & Washer
(Included in DM85UXR only)



DOWNLOAD FULL VERSION USER MANUAL
<http://jvc-tv.com/support>

Remote Control Batteries

1 Push the tab, then lift to open the cover.

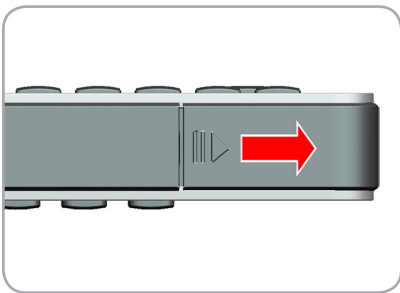

3 Close the battery cover.

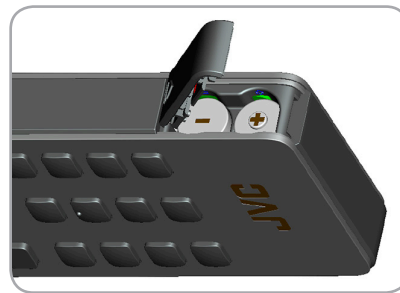

2 Insert the batteries, making sure the [+] and [-] polarities are correct.

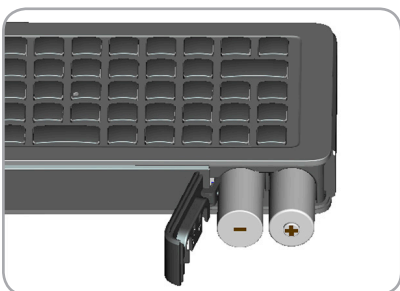

Battery Precautions:

Be sure to follow the correct polarity. Incorrect installation may cause battery leakage or damage the remote control.

Always replace batteries in pair. Do not combine a used battery with a new one.

Do not use different battery types together (e.g. "Alkaline" and "Carbon-zinc").

If the remote control is not to be used for a long period of time, remove the batteries to prevent battery leakage.

Parts and Functions

DM65USR

Front View

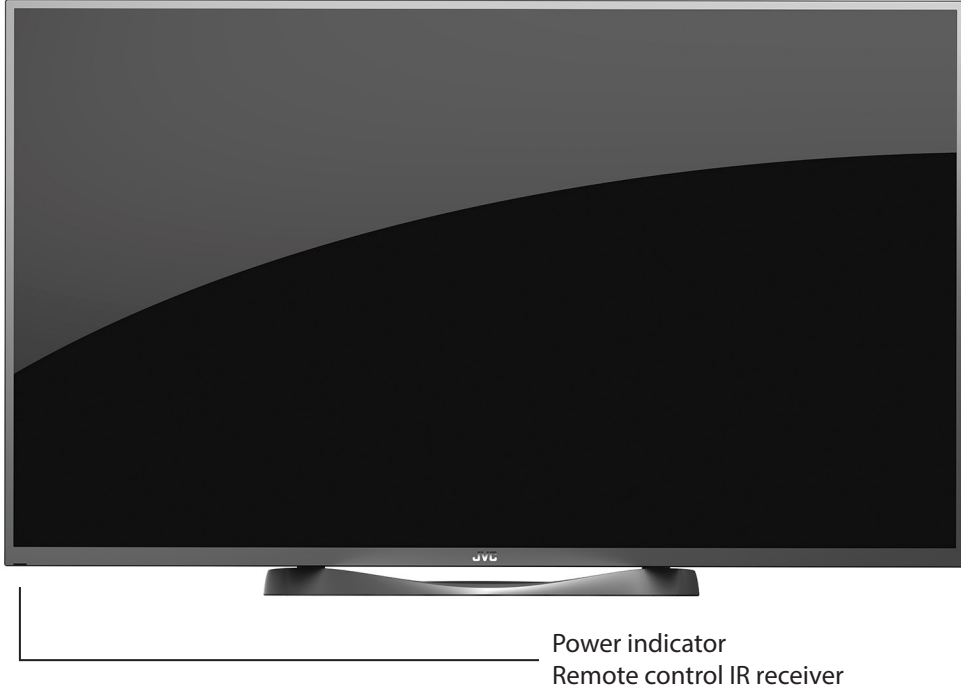

Rear View

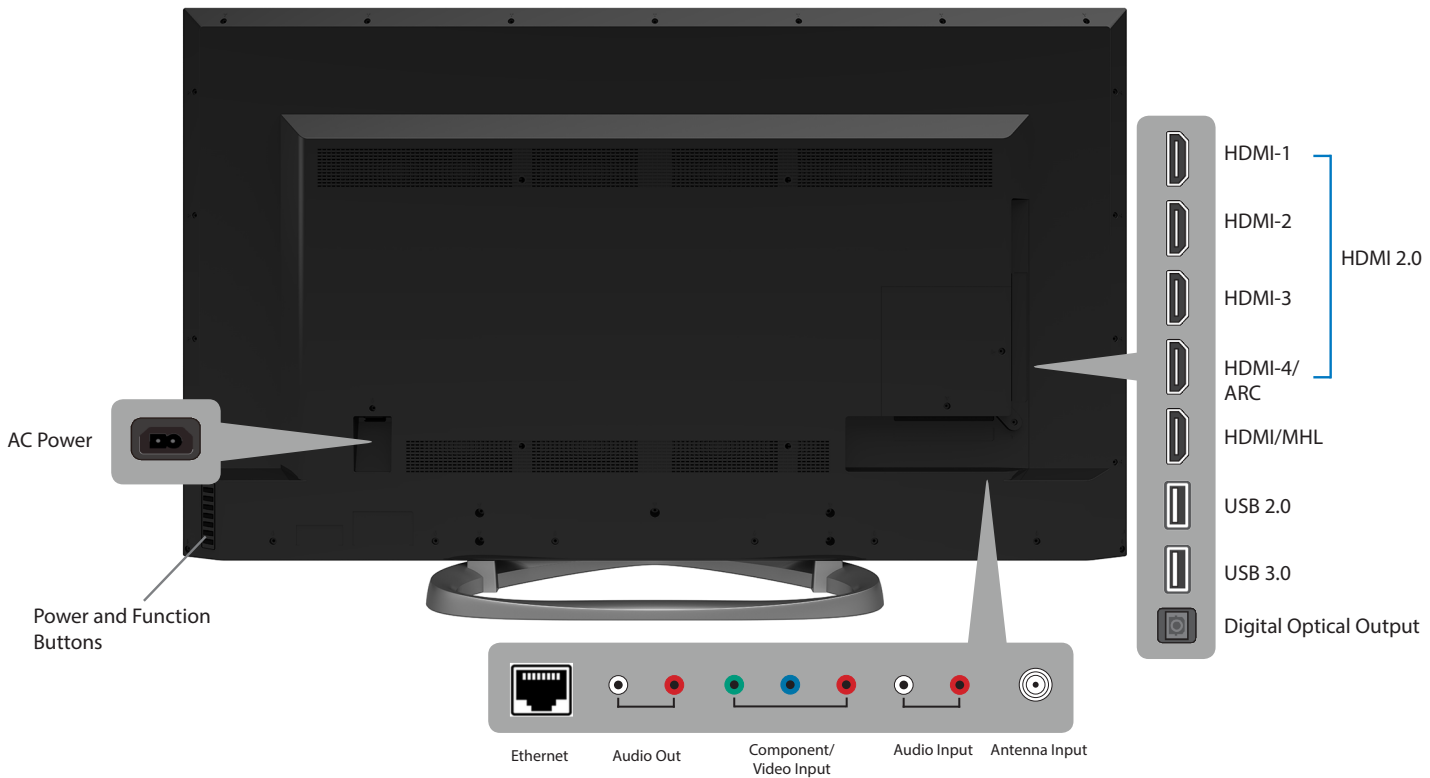

DM85UXR

Front View

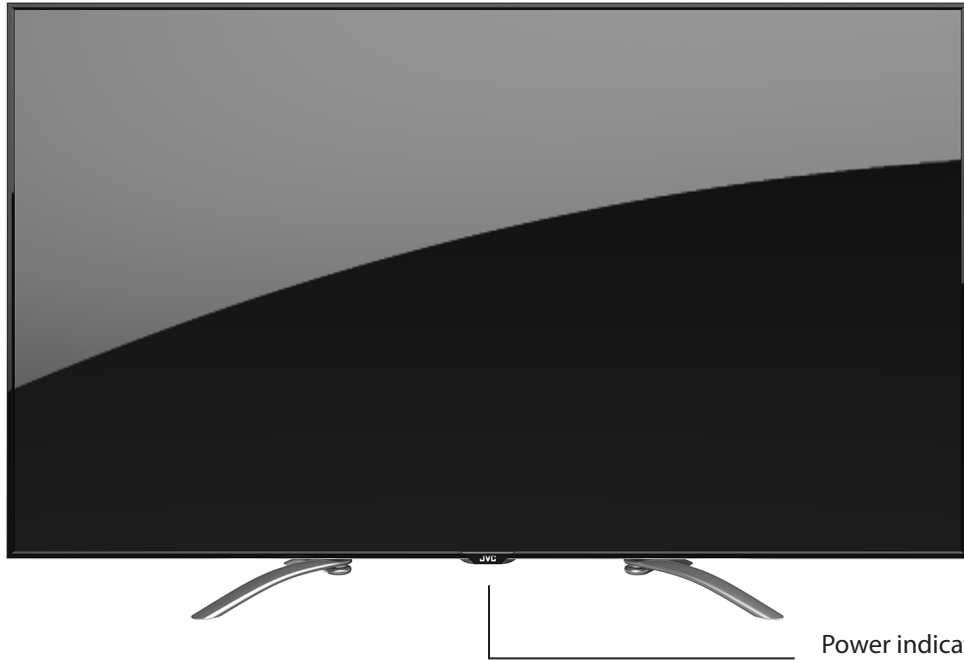

Power indicator
Remote control IR receiver

Rear View







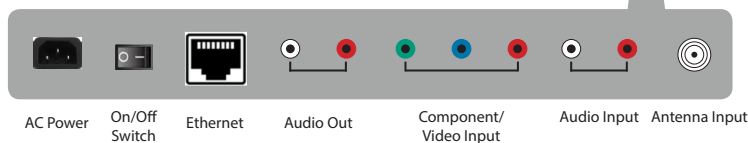

- HDMI-1
 - HDMI-2
 - HDMI-3
 - HDMI-4/
ARC
 - HDMI/MHL
 - USB 2.0
 - USB 3.0
 - Digital Optical Output
- HDMI 2.0

Power and
Function
Buttons



AC Power On/Off Switch Ethernet Audio Out Component/Video Input Audio Input Antenna Input

Remote Control

- 1 IR Transmitter:** Sends remote control signal to the TV.
- 2 POWER button:** Turns the TV on or off.
- 3 INPUT button:** Changes the input source.
- 4 Remote Control LED:** LED lights on when a button is pressed.
- 5 Playback controls:** The buttons are used for Photo, Music, Video, HDMI CEC enabled devices and HDMI MHL enabled devices. **ROKU**
- 6 ROKU HOME button /INFO* button  / ←RETURN button **: Press to display ROKU home screen/ to obtain more information or access special options/ return to previous menu or screen while ROKU streaming stick is in use. **ROKU**
- 7 Directional buttons  /  /  / **: Navigate the menu, select options, or adjust settings value.
- 8 OK button:** Enter a menu or confirm an option.
- 9 MUTE button:** Turns the TV audio off or on.
- 10 Global return button:** Returns to previous page.
- 11 MENU button:** Displays the MENU screen.
- 12 VOL (Volume) buttons:** Press **VOL+** to increase volume or **VOL-** to decrease volume.
- 13 JVC Home button:** Press to enter JVC home screen.
- 14 CH (Channel) buttons:** Use **CH+** to increase the channel number or **CH-** to decrease the channel number.
- 15 Number pad (0~9, -):** Use the number keys to directly change channel.
- 16 Instant Replay/Last button:** Replays last 10 seconds of video. Switch back to previous channel.
- 17 Touch pad:** Touch to navigate the cursor.
- 18 Qwerty Keyboard:** Provides you the ability to enter text quickly.

Notes: To obtain best results, use the remote control with a proper distance from the TV and ensure that there are no obstacles between them.

Aim the remote control transmitter to the remote control sensor on the TV.

Do not expose the remote control to direct sunlight. This may affect the performance of the remote control.

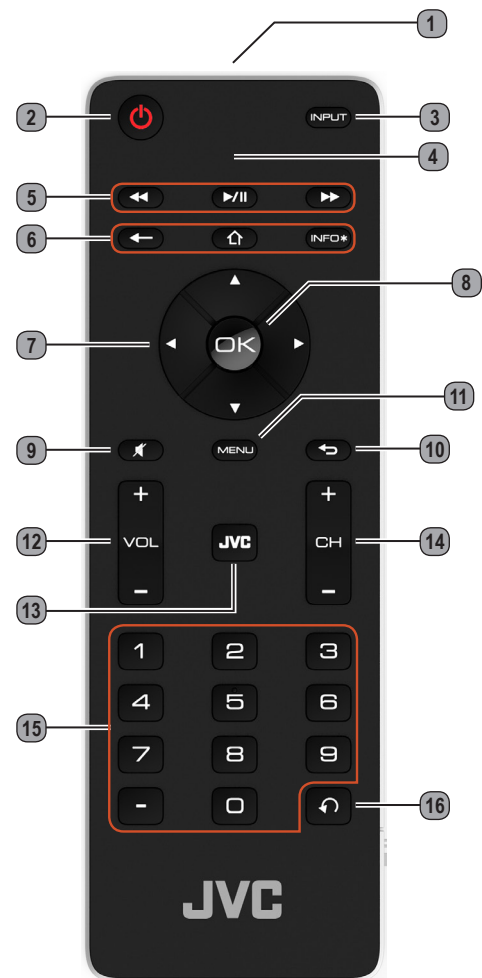

Making Connections

Connecting Antenna / Cable

Connect the 75 ohm coaxial cable directly to the DTV/TV Cable/Antenna jack of the TV.

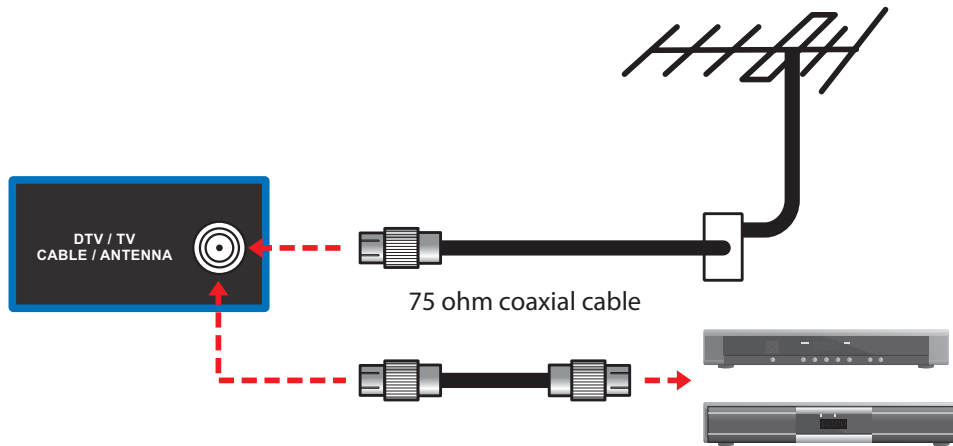

Connecting HD Devices

You can connect different devices to the TV using HDMI, Composite, or Component connections. Check the type of connection available on your device.

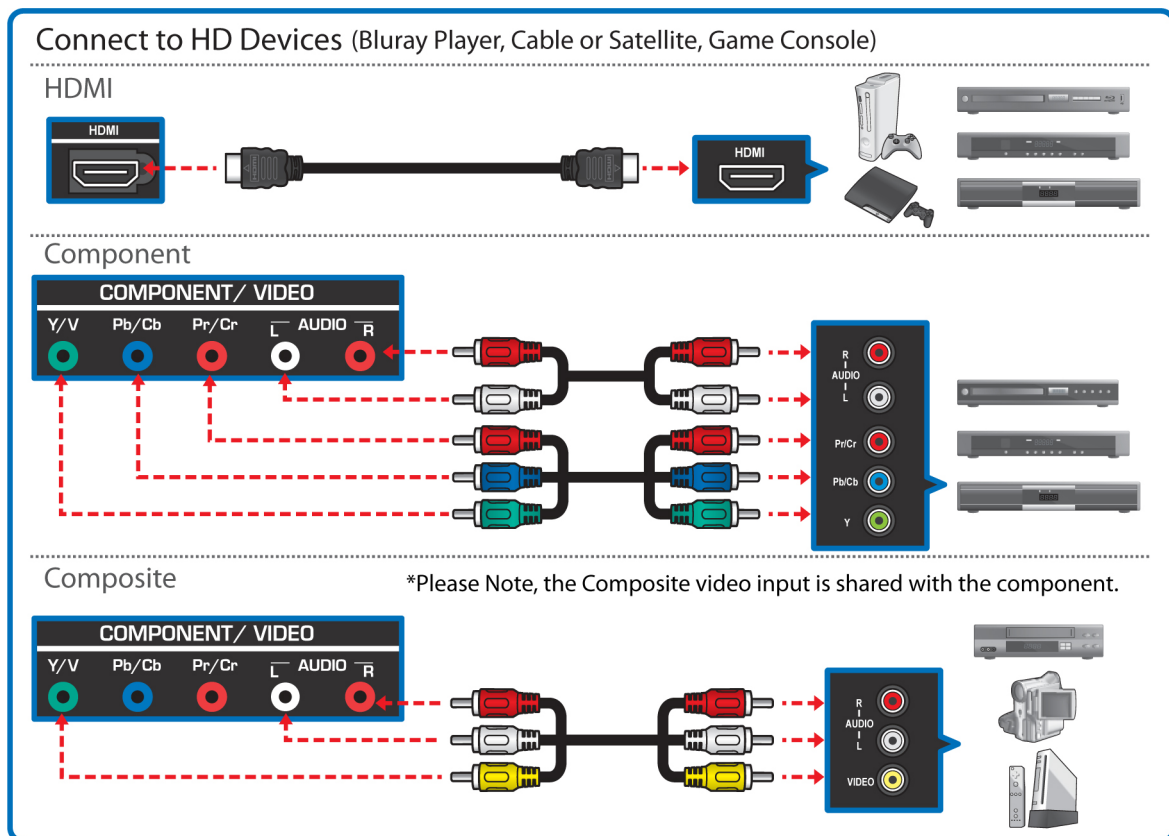

Making Connections

Connecting External Speakers / Soundbar / AV Receivers

Digital Connection

Connect the SPDIF/Optical audio cable to the Audio OUT optical port of the TV and the optical port of the soundbar, AV receiver, or audio system.

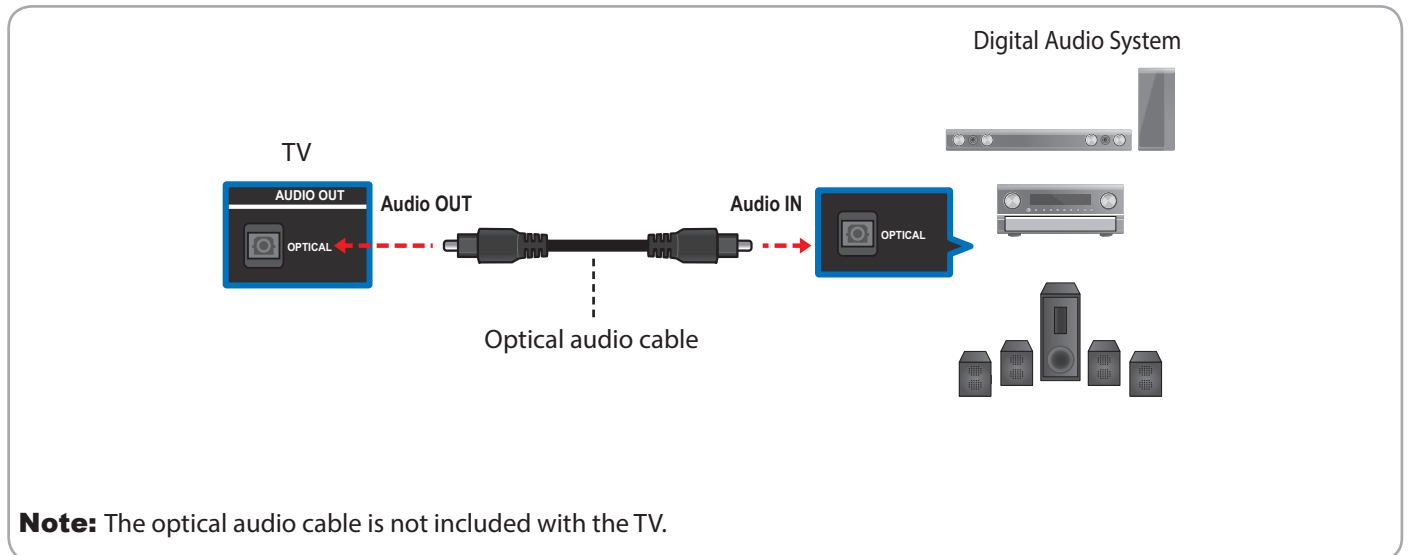

Analog Audio Connection

Connect the audio cable to the Audio OUT port of the TV and the analog Audio IN port of the soundbar, AV receiver, or audio system.

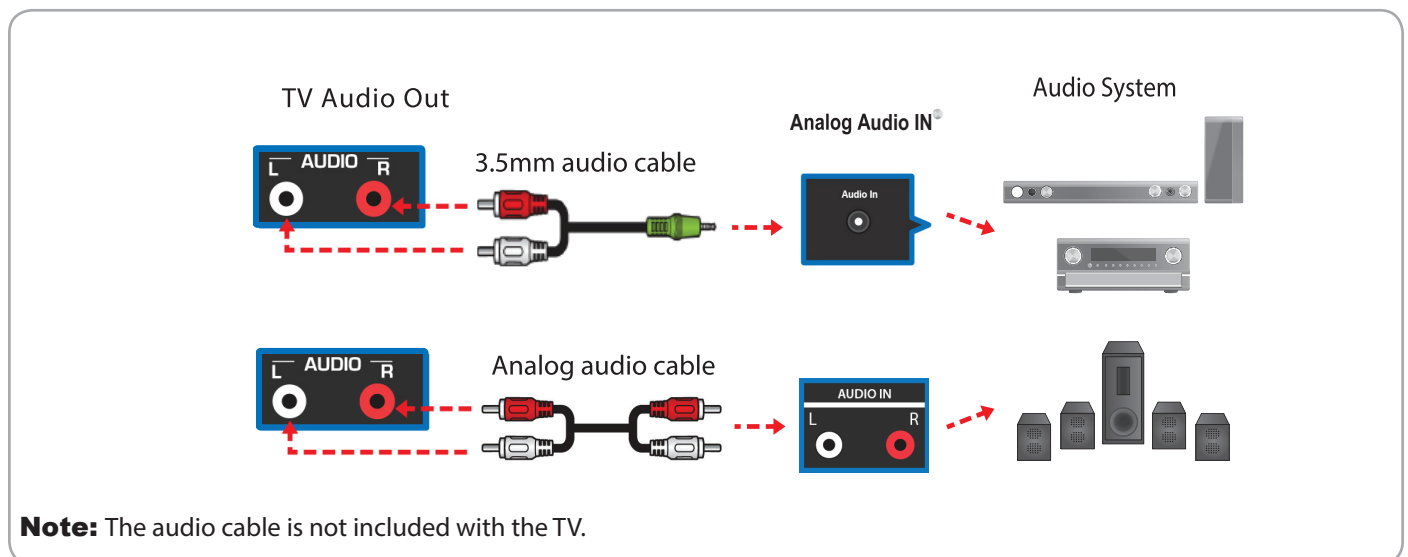

Basic Operations

Setup Wizard

The Setup Wizard will assist you with setting up your TV for the first time. Please follow the instructions carefully.

Note: If you would like to setup over-the-air or cable programming, make sure the antenna or cable TV system is connected.

- 1 When you turn on the TV for the first time, the Setup Wizard screen will appear. Select the menu language, then press **OK**.



- 2 Remote pairing.

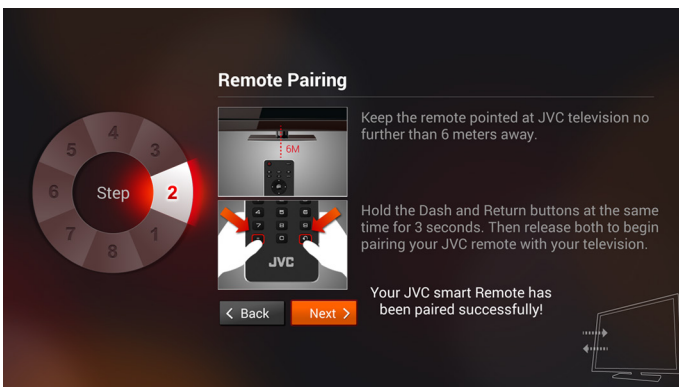
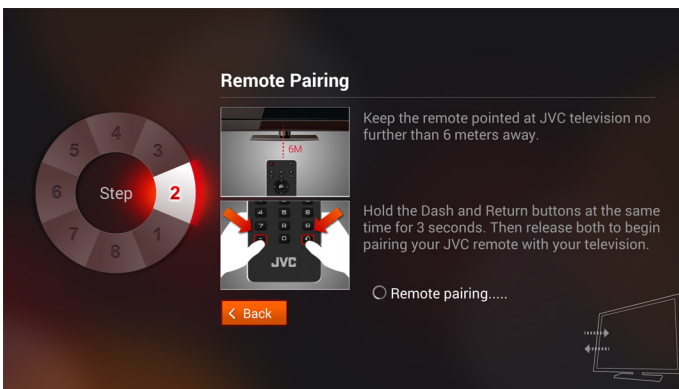

Note: Remote pairing can be performed at any time when TV is on.

- 3 Select the TV Mode, then press **OK**.

TV Mode options:

Home Use: Select this mode for in home use.

Retail Demo: Select this mode for in store demo.

Note: Store Demo is for retailers only.

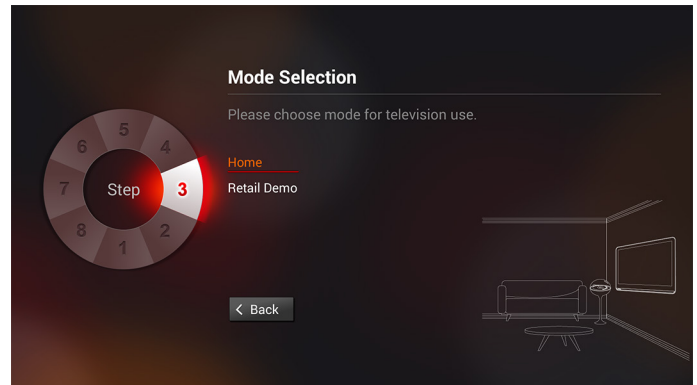

- 4 Select the Network Setup, then press **OK**.

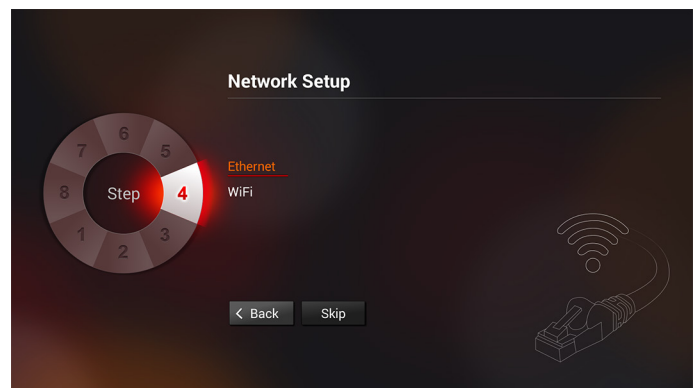

- 5 Enter Zip Code.

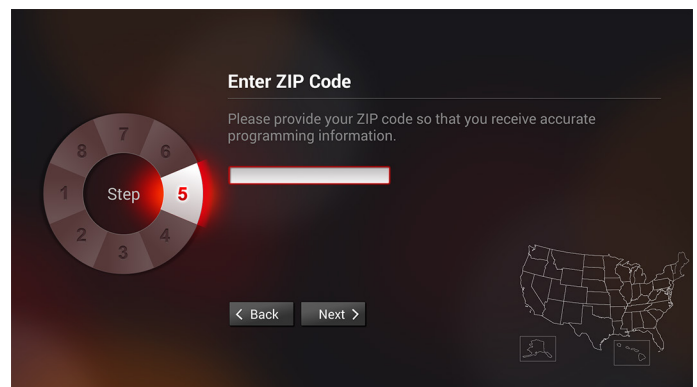

Basic Operations

6 Select Time Zone.

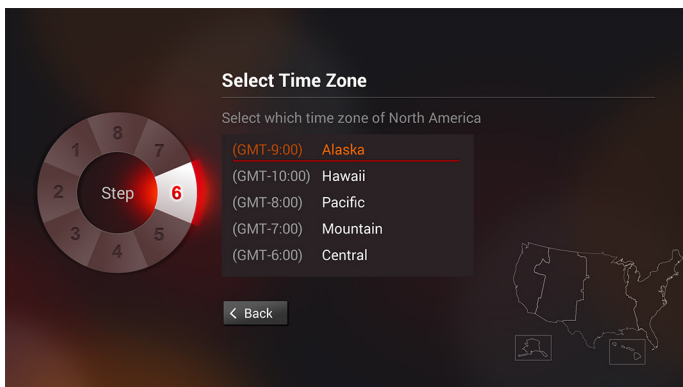

Changing Channel/Volume

Press the number buttons to directly select channels.

Note: After pressing the number buttons, there will be a few seconds delay before the TV changes channel. To change to the channel right away, press **OK** after pressing the number buttons.

To Browse Channel

Press the Channel **+/-** buttons on the remote control.



To Adjust Volume

Press the Volume **+/-** buttons on the remote control.

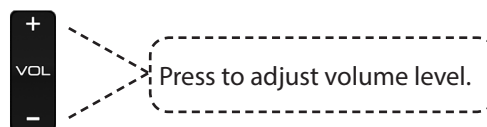

7 Select Auto Channel Scan.

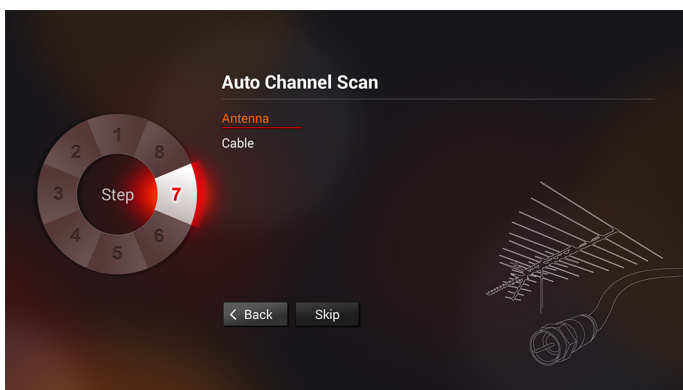

Note: Scanning may take some time to complete. Select Stop Scan to cancel the auto scan at any time.

To Select Analog Channels

- 1~9 Press 1~9 as needed.
Example, to select channel 2, press **2**, then press **OK**.
- 10~99 Press the 2 digits in order.
Example, to select channel 15, press **1, 5**, then **OK**.
- 100~135: Press the 3 digits in order,
Example, to select channel 130, press **1, 3, 0**, then press **OK**.

8 Finish.

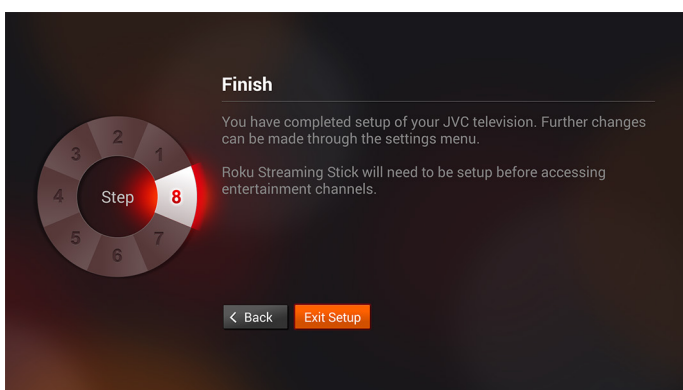

Basic Operations

Input Menu

Select the input source signal by pressing the **Input** button.

- **TV:** To watch analog or digital TV channels.
- **Video:** To use VCRs, camcorders, or game consoles connected via composite connection.
- **Component:** To use VCRs, camcorders, or game consoles connected via component connection.
- **HDMI-1~4 :** To connect HD/UHD devices via HDMI 2.0 Connection.
- **HDMI/MHL:** To connect HD/UHD and MHL devices via HDMI/MHL Connection.

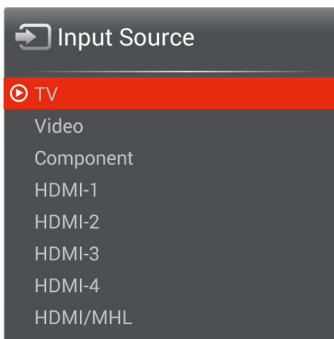

To Select Digital Channels

Press the first 3 digits, then press **-**, followed by the remaining number.

Example, to select channel 15-1, press **1, 5, - , 1**, then press **OK**.

To Select by Channel List

All channels found from channel scan are listed on the Channel List screen. You can select channels from this screen.

- 1** Press **OK** to display the Channel List screen.
- 2** Press **▲** or **▼** to select a channel number, then press **OK**.
- 3** Press **GLOBAL RETURN** button **↩** to close the Channel List.

Mute Volume

Press **MUTE** to turn the sound off. To turn the sound back on, press MUTE again or any of the **VOL** buttons.

Set Aspect Ratio

- 1** Press **Menu** to display the Quick Setup menu.
- 2** Go to **Wide** and press **OK** to select Aspect Ratio options, then press **OK**.

Normal

When watching a 4:3 content, the TV displays a standard picture with black side bars. When viewing a 16:9 content, it displays a full picture.

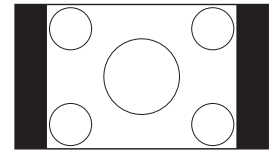

Wide

When displaying a 4:3 content, the picture is stretched horizontally to fill the width of the screen. When watching a 16:9 content, the image is slightly overscan.

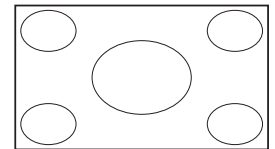

Zoom

The entire picture is uniformly enlarged to retain its original proportion. However, some parts of the picture may be hidden.

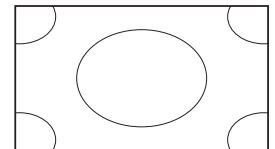

Stretch

The picture is stretched horizontally on the left and right sides.

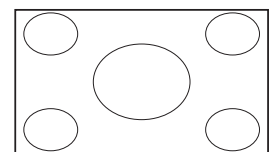

Note: Panoramic mode is only available on 4:3 contents. Stretch is only available on 16:9 contents.

Basic Operations

Multimedia Mode

The TV Allows you to play image slide shows from a USB memory stick.

Note: Due to the wide variety of multimedia file formats some formats may not be supported.

Playing Multimedia Files

- 1 Insert the USB memory stick into the USB slot of the TV.

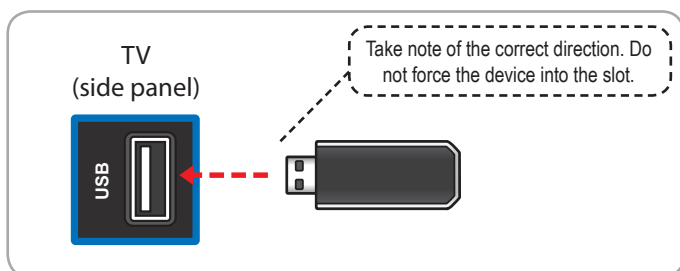

- 2 A message box will appear on the screen. Press **<** or **>** to select **OK**.
- 3 Press **^** or **v** to select the USB source, then press **OK**.
- 4 Press **^**, **v**, **<** or **>** to select a file or function, then press **OK**.

Basic Operations

Wall Mount

Installing Wall Mount

The wall mount kit allows you to mount the TV on the wall. For detailed information on installing the wall mount, see the instructions provided with the wall mount kit.

Note: The wall mount kit is not included with the product.



For product protection and safety reasons, JVC strongly recommends contacting a technician or professional for assistance installing the wall mount and setting up the TV. If you decide to install the wall mount and TV without the assistance of a technician or professional, JVC will not be responsible for any damage to the product or injury to yourself or others.



Do not install your wall mount while your TV is turned on. It can result in personal injury due to electric shock

- 1** Disconnect all cables connected to the TV.
- 2** Carefully place the TV on a flat and clean surface with screen facing down. It is recommended to place the TV cover or protection sheet between the TV and flat surface.
- 3** Remove the screw attaching the stand and TV.
- 4** Remove and store the stand for future use.

Wall Mount

Product Model #	VESA hole pattern (mm)	Standard Screw
DM65USR (65")	400 x 400	M6
DM85UXR (85")	600 x 400	M8

Adjusting the Menu Settings

Menu Operation

	Remote Control
1 Display the menu.	Press MENU .
2 Select a menu option.	<ol style="list-style-type: none"> 1. Press ▲ or ▼ to select a menu or option. 2. Press OK or ▶ to enter a menu or confirm an option.
3 Adjust or select the setting.	<ol style="list-style-type: none"> 1. Press ▲ or ▼ to select an option. Or, press ◀ or ▶ to adjust a setting, such as Brightness. 2. Press OK to apply the settings.
4 Exit the menu.	To exit the menu, press MENU button. Or, to return to a previous screen one at a time, press Global return button  .

Quick Setup Menu

Quickly access to frequently used TV options.

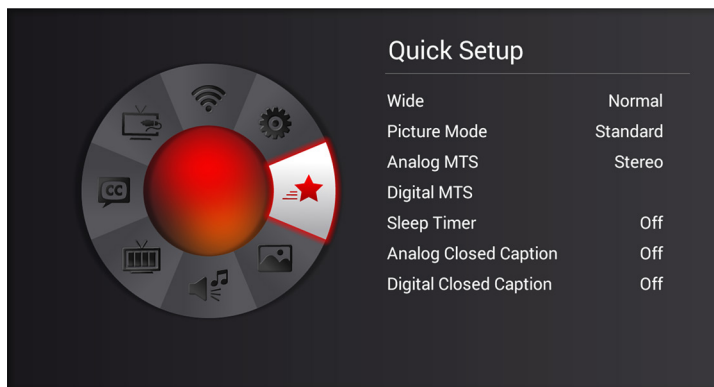

Wide

Select "Wide" to change TV viewing aspect ratio.

- 1** Press **▲** or **▼** to select "Wide", then press **▶** or **OK**.
- 2** Press **▲** or **▼** to select "Normal", "Wide", "Zoom" or "Panoramic/Stretch".*

*Depending on content resolution.

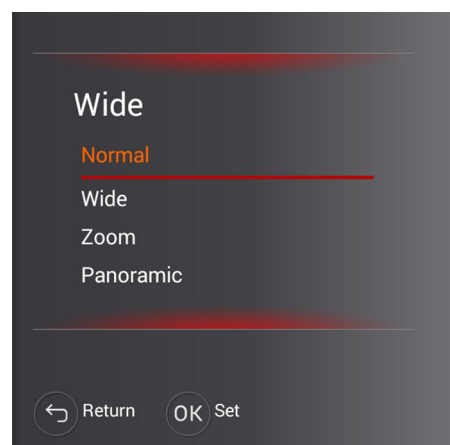

Adjusting the Menu Settings

Picture Mode

Select the picture mode.

Custom	For custom picture settings.
Standard	For standard picture settings.
Movie	For moving pictures such as movies.
Game	For fast and dynamic pictures suitable with playing games.
Vivid	For bright and vivid picture settings.
Sport	Suggested settings for sporting events.

Analog MTS

Select the Analog MTS modes.

Digital MTS

Select Digital MTS modes.

Sleep Timer

Sleep timer sets the TV to automatically turn off after a preset amount of time.

Analog/Digital Closed Caption

Closed Caption decodes and displays closed caption data of television programs as subtitles.

Picture Menu

Adjust picture options such as Brightness, contrast, and advanced picture settings.

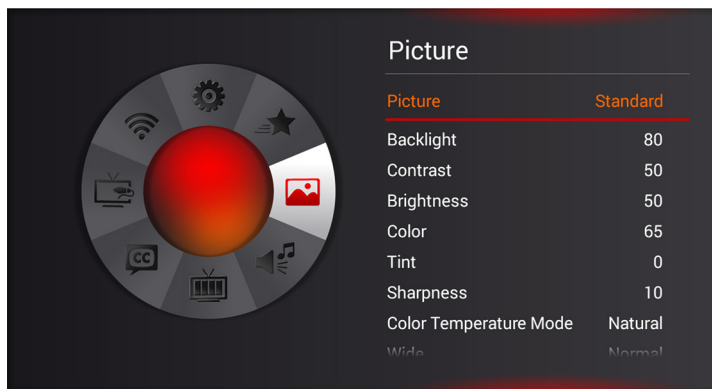

Picture

Select the picture mode.

Custom	For custom picture settings.
Standard	For standard picture settings.
Movie	For moving pictures such as movies.
Game	For fast and dynamic pictures suitable with playing games.
Vivid	For bright and vivid picture settings.
Sport	Suggested settings for sporting events.

Adjusting the Menu Settings

Backlight

Adjust the backlight that affects the overall brilliance of the picture. (0 ~100)

Contrast

Adjust the white level in the picture. Low contrast makes pictures look dark, high contrast makes pictures washed out. (0 ~100)

Brightness

Adjust the brightness setting. (0 ~100)

Color

Adjust the amount of color level in the picture. (0 ~100)

Tint

Adjust the sharpness of the edges of elements in the picture.

Sharpness

Select WIDE to change TV viewing aspect ratio (Normal, Wide, Zoom and Stretch).

Color Temperature Mode

Select Color Temperature Mode. (Custom, Cool, Natural and Warm)

Ambient Light Sensor

Select the sensitivity of the ambient light sensor to automatically adjust to light changes in the room. (Off / Dark / Standard / Bright).

Wide

Adjust the picture hue. (-50 ~ 50)

Advanced Picture

Adjust various advance picture settings.

Professional Picture

Adjust various professional picture settings.

Reset Picture Settings

Reset the picture mode settings to default.

Adjusting the Menu Settings

Audio Menu



TV Speakers

Turn the internal speakers on or off.

XinemaSound® 3D

Expansive and immersive, multi-dimensional surround sound experience. (Off, Movie, News)

Note: When XinemaSound® 3D is on, **Bass**, **Treble** and **Equalizer Settings** functions will not be available for adjustment.

XinemaSound® Leveler

Delivers smooth, steady volume levels from the quietest sound to the loudest volume with exceptional audio clarity.

Bass

Adjust the bass level to your preference. (-12 ~ 12)

Treble

Adjust the treble level to your preference. (-12 ~ 12)

Balance

Adjust the audio level of the L/R channels of the speakers to your preference. (-10 ~ 10)

Lip Sync

Adjust to match the movements and the lips of the person talking on the screen. (0 ~ 5)

Digital Audio Out

Select the type of digital audio output. (Off /Dolby Digital / PCM)

Analog Audio Out

Select the type of analog audio output. (Fixed / Variable)

Channel Menu

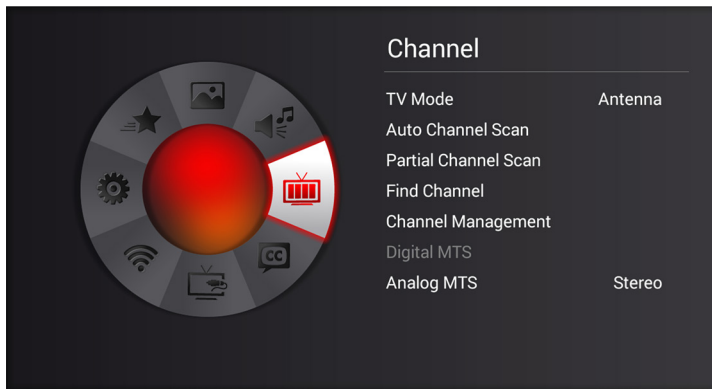

TV mode

Select Antenna or Cable for the service connected to your TV.

Auto Channel Scan

When you run auto scan, the TV scans for all available channels. Make sure the antenna/cable is connected properly.

Partial Channel Scan

You can partially scan for network signal within a specified range of channels.

Note: Auto scan may take 15 to 30 minutes to find available channels.

Find Channel

New channels may be added to your area periodically. Use the Add Channel function to add new channels.

Channel Management

To mark favorite channels or to remove channels from the Channel List.

Digital MTS

Select Digital MTS modes.

Analog MTS

Select the Analog MTS modes.

Adjusting the Menu Settings

Closed Caption

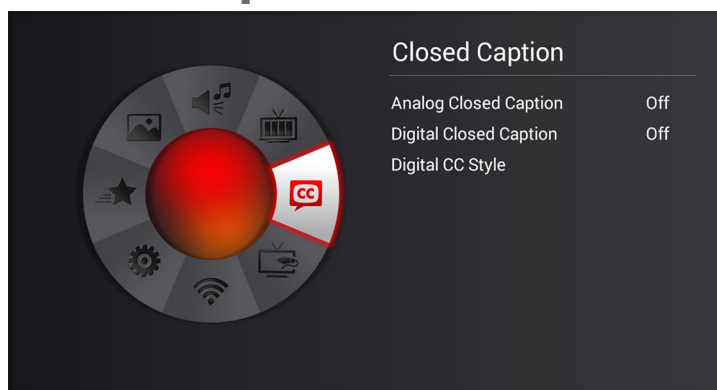

Closed Caption decodes and displays closed caption data of television programs as subtitles.

1 Press **MENU**.

2 Select “Closed Caption”, then press **OK**.

3 Select “Analog Closed Caption” or “Digital Closed Caption”, then press **OK**.

Note: Either “Analog Closed Caption” or “Digital Closed Caption” is available depending on Video content. For digital closed caption, you can select closed caption options, such as text size and text color.

4 Select closed caption type or select “Off” to disable this feature, then press **OK**.

Devices Menu

Configure connected input devices.

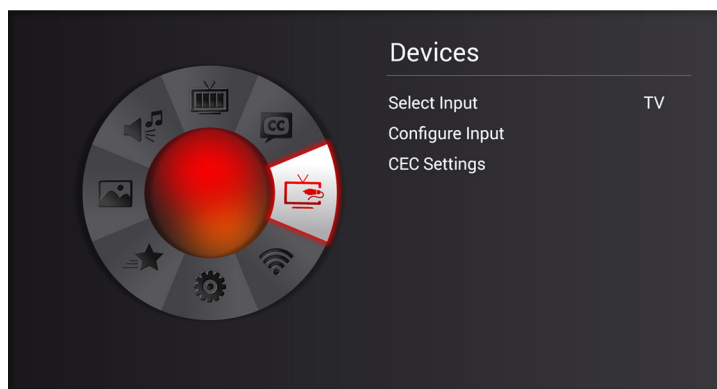

To label an input source, perform the following steps:

1 Select Input Source, then press **OK**.

2 Go to “Configure Input”, then select “Input Labels”.

Adjusting the Menu Settings

CEC Settings

CEC allows you to control devices using your TV remote control when the CEC devices are connected via HDMI.

CEC Function	Enable or disable CEC function.
System Audio Control	Connect to your device through Audio Return Channel-enabled HDMI Port.
Device Search	If CEC Function is enabled, select to search for CEC devices.

Network Menu

Select Network methods (Ethernet or WiFi).

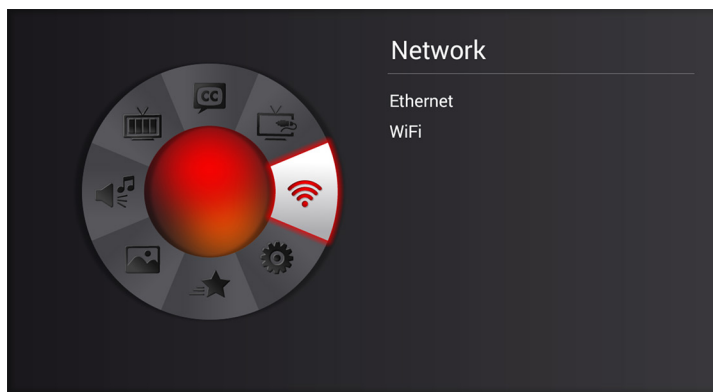

Ethernet

To establish Hard-Wired Ethernet connection, connect one end of a CAT5 Ethernet cable to your home network router, connect the other end of CAT5 Ethernet cable to the Ethernet connector jack on the back of the TV.

WiFi

To establish Wireless connection, select WiFi and follow the on screen instructions to select the desired network and enter security key code.

System Menu

Select the input source signal.

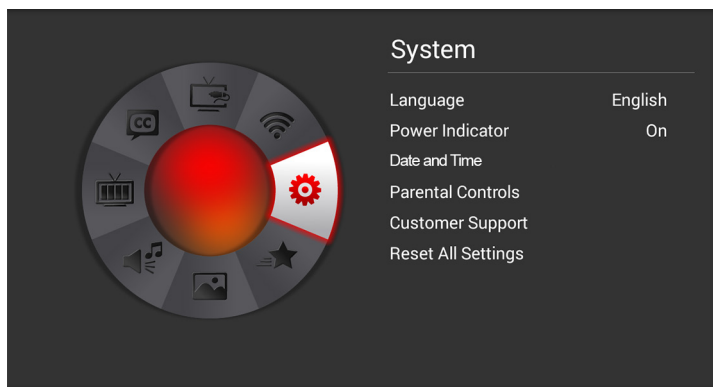

Language

Select the on-screen menu language (English, French or Spanish).

Adjusting the Menu Settings

Power Indicator

To turn on/off the LED power indicator while TV is on.

Date and Time

Configure TV Date and Time manually or automatically (require network connection).

Parental Control

The Parental Control feature allows you to control and restrict TV programs by Channel Lock, TV Rating, or Movie Rating.

Access Parental Control Menu

The Parental Control menu requires you to enter the 4 digit password to access its submenu.

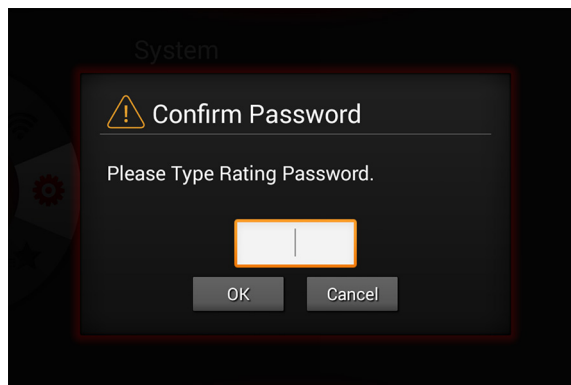

Note: The default password is "0000".

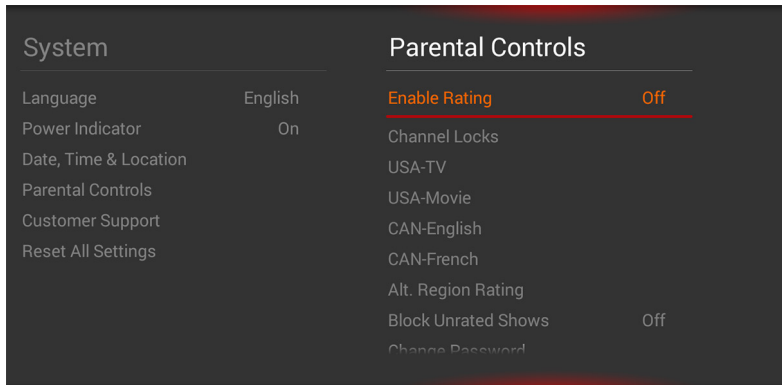

Restrict By Channel

Use the Channel Lock feature to restrict viewing a specified channel . Once locked channel is selected, the TV displays a blank screen.

- 1 Go to "Enable Rating" and select "On".
- 2 Select "Channel Lock", then press **OK**.
- 3 Highlight a channel that you want to lock.
- 4 Press **OK** to mark and lock the channel.
- 5 Press the **Global return** button  to exit.

Adjusting the Menu Settings

Restrict By TV/Movie Rating

You can select which TV/Movie rating to lock for viewing.

1 In the “Parental Control” menu, press **▼** or **▲** to select a rating submenu, then press **OK**.

- “Enable Rating”: Select “On” to enable rating.
- “USA-TV”: Set the rating by age level and genre.
- “USA-Movie”: Set by USA movie rating standards.
- “CAN-English”: Set by Canadian English movie rating standards.
- “CAN-French”: Set by Canadian French movie rating standards.
- “Block Unrated Shows”: Select “On” to block unrated shows.

2 Press **▼** or **▲**, then press **OK** to select the rating.

3 Press the **GLOBAL return** button **↩** to exit.

Change Password

1 In the “Parental Control” menu, press **▼** or **▲** to select “Change Password”, then press **OK**.

2 Enter new password, then press **OK**.

3 Re-enter the new password, then press **OK** to complete.

Reset Parental Settings

Reset parental settings to default settings.



Customer Support

Display all system information of the TV.

Reset All Settings

Reset all TV settings to default settings.



Access to JVC Home Screen

Press the JVC home button  to enter JVC home screen. Press JVC home  button again or the **GLOBAL return** button  to exit.

- 1 Preview PIP shows content from last input source.
- 2 Main Menu Wheel: Use Up or Down button to navigate menu option.



- 3 Date and time information.
- 4 Apps list

Use Up  and Down  buttons to navigate main menu options.



Note: When entered JVC homepage, Qwerty keyboard and touchpad on the reverse side of remote control can be utilized for navigating and selecting features.

Home Screen: My APP

- 1 Use Directional buttons \uparrow / \downarrow / \leftarrow / \rightarrow to navigate App menu and **OK** button to select App.
- 2 Press Left \leftarrow button or the **GLOBAL return** button  to go back to main menu.

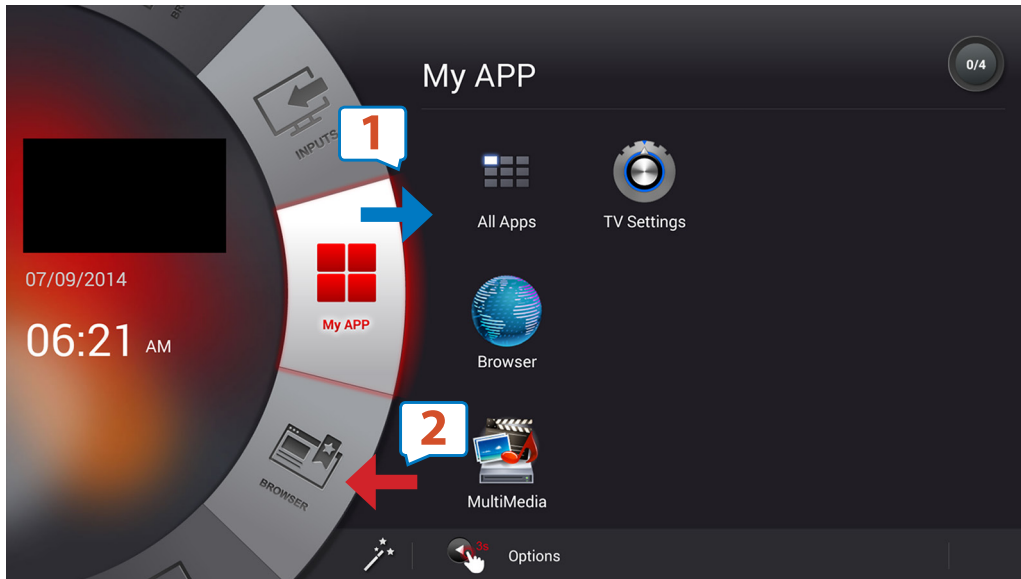

- 3 Press Left \leftarrow button for 3 seconds to access my APP management mode to add or remove Apps from "My APP" home screen. Press Right \rightarrow button or the **GLOBAL return** button  to exit.



Home Screen: Browser

- 1 Select "Browser" on main menu wheel.
- 2 Access Bookmark info in Browser

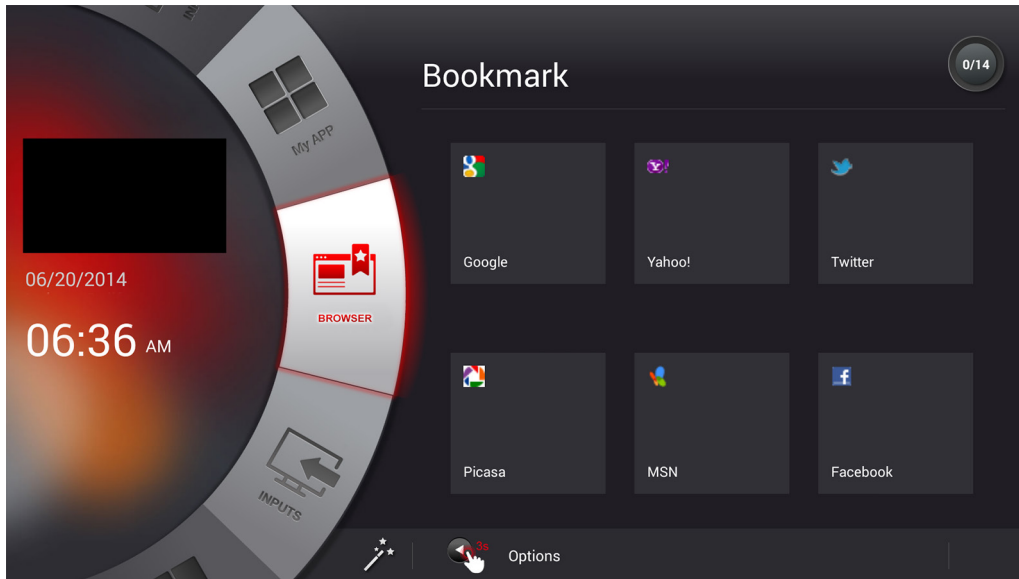

- 1 Press Left < button for 3 seconds to access Bookmark or history mode.
- 2 Press Right > button or the **GLOBAL return** button  to exit.

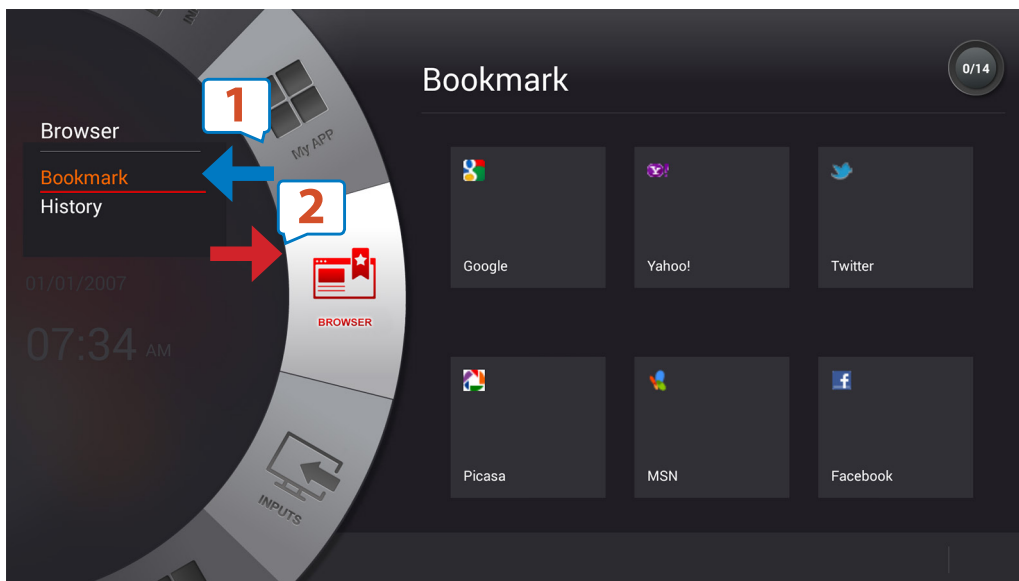

Home Screen: Browser

1 Press Up/Down buttons \wedge / \vee to navigate between History/Bookmarks mode.

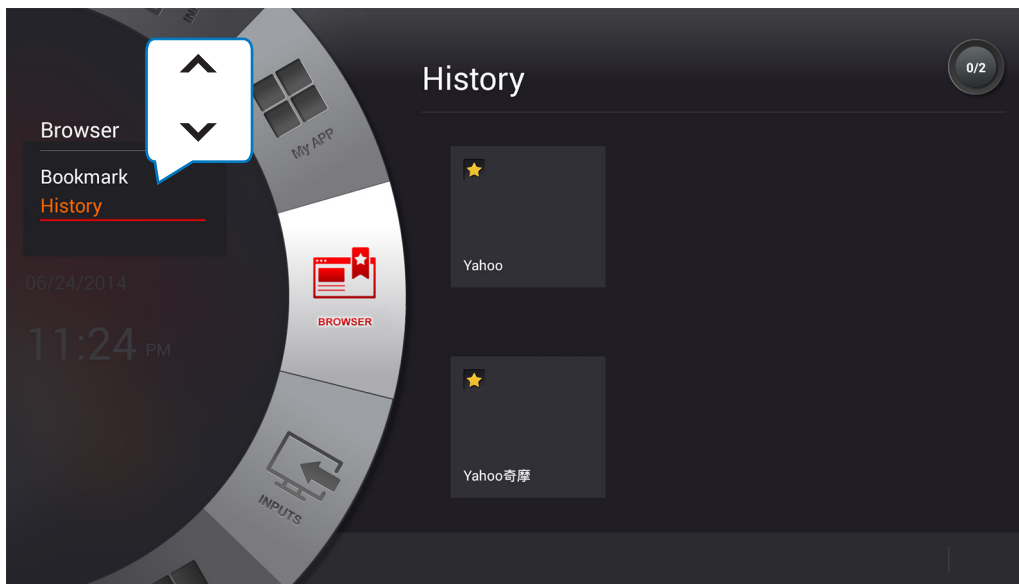

2 Choose a Bookmark or History, then press **OK** button to start browsing the selected website.

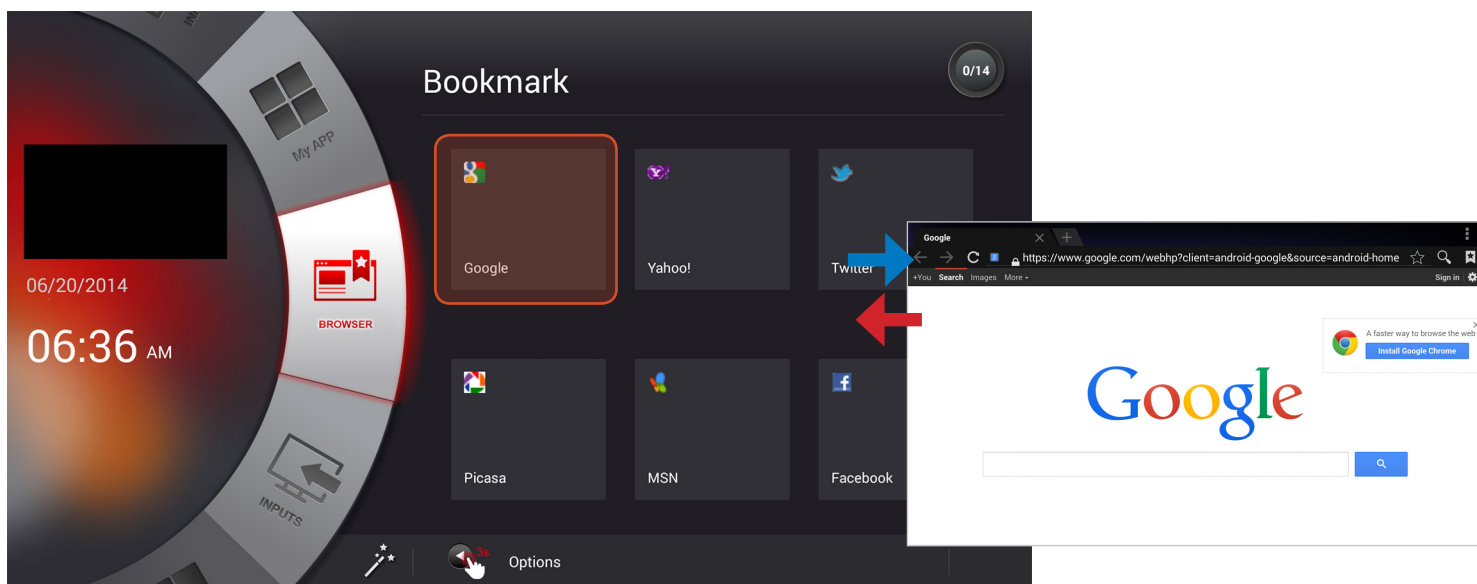

To manage "History" or "Bookmarks" in browser.

- 1 Open the browser.
- 2 Use touchpad to move cursor and click on "Favorite" icon on the top-right corner of the browser.
- 3 Choose "Bookmarks" or "History" page.
- 4 Manage "Bookmark" or "History" on the control page by choosing the Bookmark or History of your choice then press and hold the "Left mouse button" located on top right of the Qwerty Keyboard.

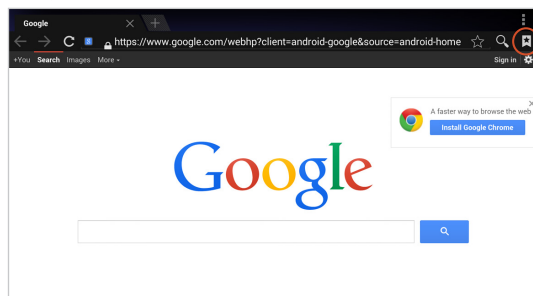

Home Screen: Input

- 1 Use Directional buttons \uparrow / \downarrow / \leftarrow / \rightarrow or touchpad to choose TV input source.

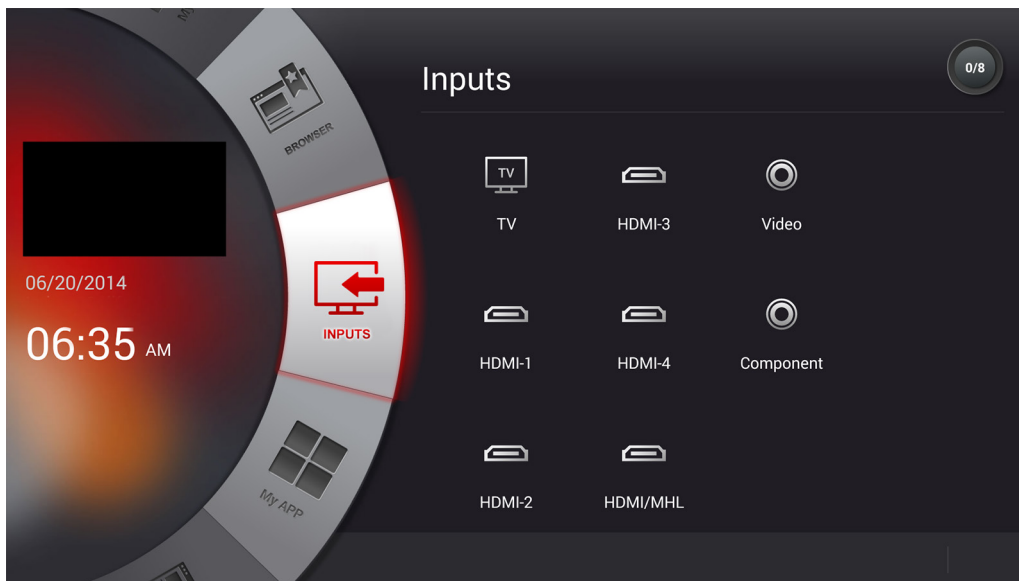

MMP (Multimedia Player)

There are two ways to enter MMP mode:

- 1 Select MMP App from "My APP" home page.
- 2 Plug in USB stick and click "OK" when Auto device detection window pops up.

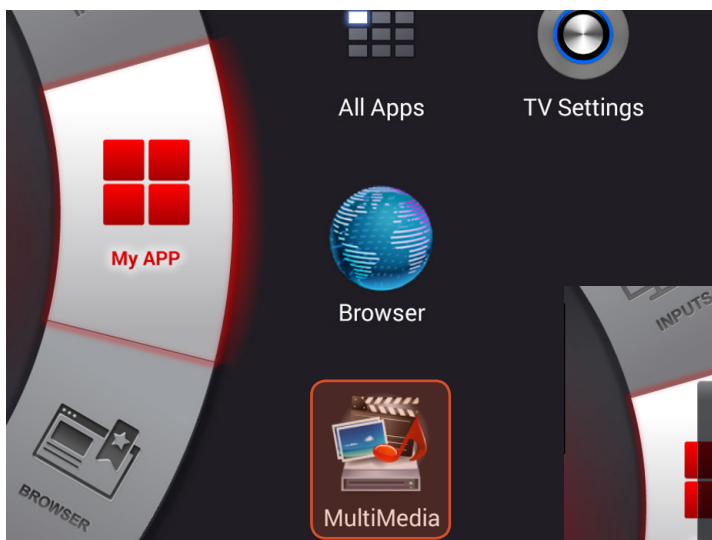

Note: Due to the wide variety of multimedia file formats some formats may not be supported.

MMP (Multimedia Player)

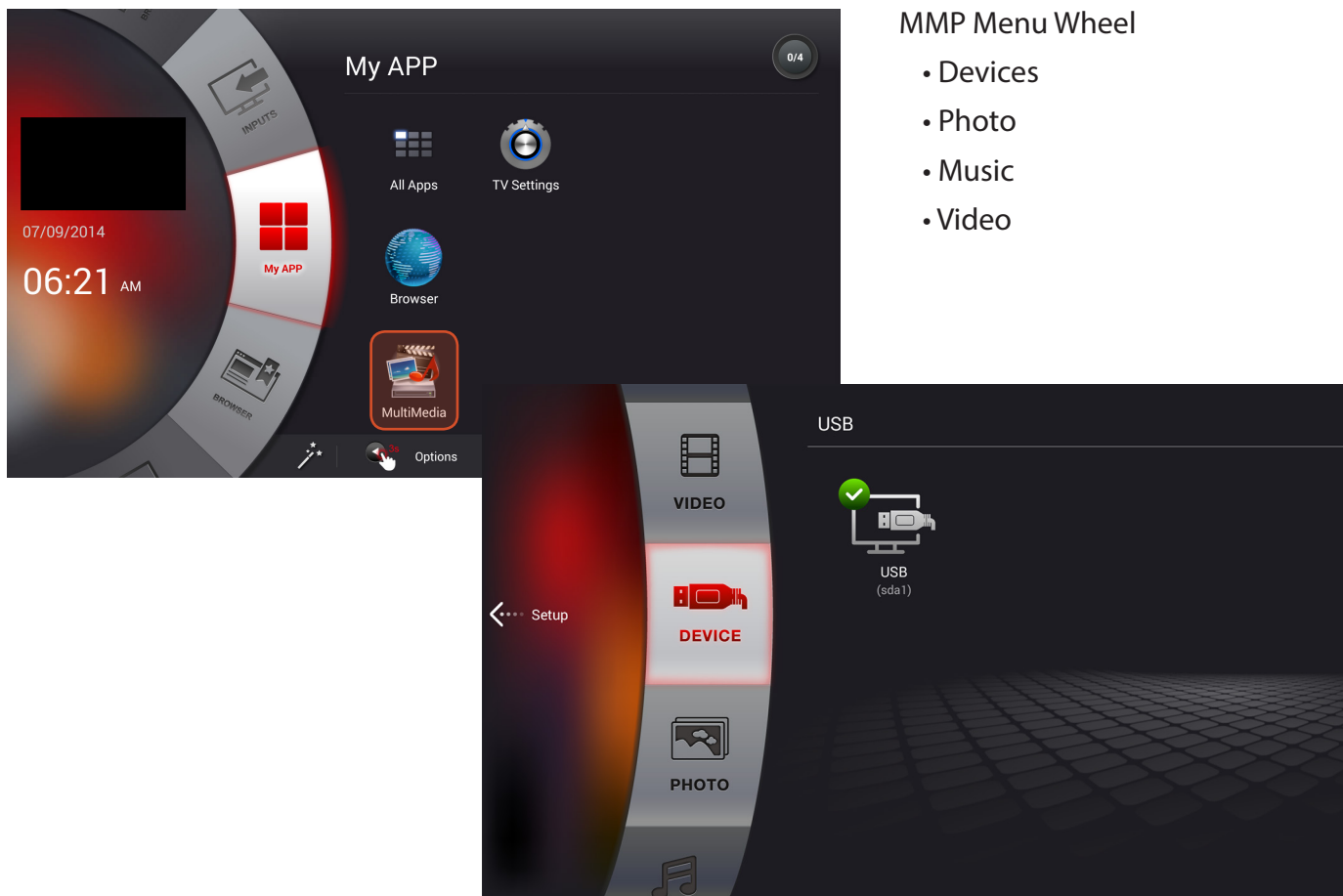

MMP Menu Wheel

- Devices
- Photo
- Music
- Video

Multimedia Menu: Device Operation

1 Use Directional buttons \uparrow / \downarrow / \leftarrow / \rightarrow to select media type on main wheel menu.

- USB
- DLNA

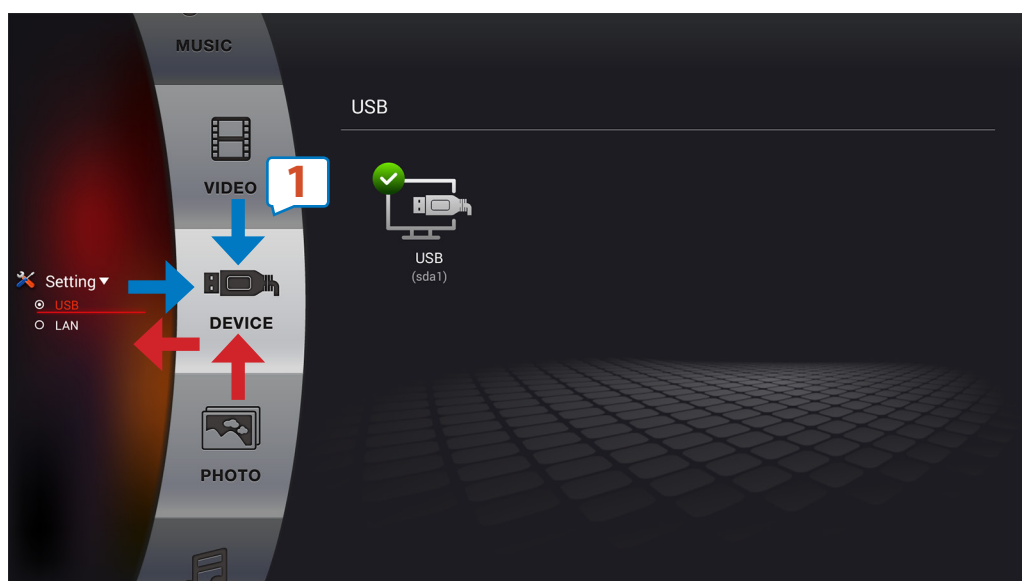

Multimedia Menu: Photo

- 1 Use Directional buttons \wedge / \vee / \langle / \rangle to navigate device photo folder.
- 2 Press Left \langle button or the **GLOBAL return** button \leftarrow to go back to main menu.



- 1 Press Left \langle button to enter Photo setting menu.
 - 2 Press Right \rangle button or the **GLOBAL return** button \leftarrow to exit.
- Sort
 - Interval time

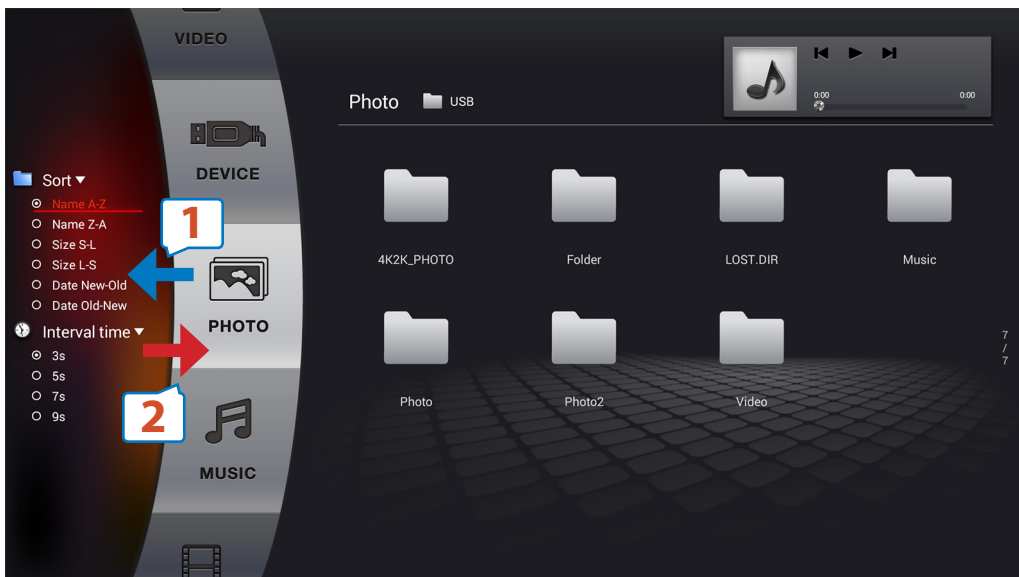

Multimedia Menu: Music

- 1 Use Directional buttons \wedge / \vee / \langle / \rangle to browse device Music folder.
- 2 Press Left \langle button or the **GLOBAL return** button \leftarrow to go back to main menu.

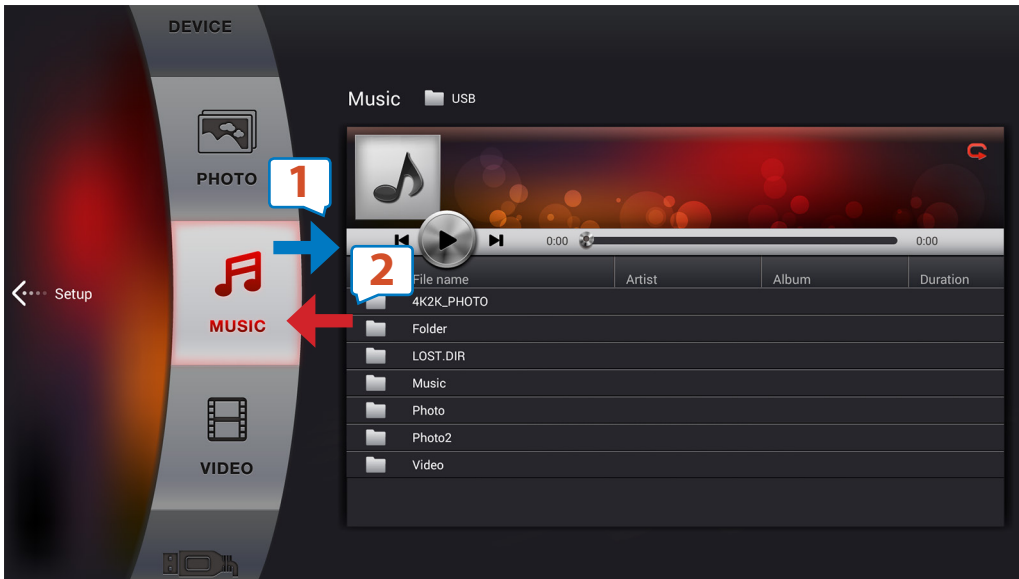

- 1 Press Left \langle button to enter Music setting menu.
 - 2 Press Right \rangle button or the **GLOBAL return** button \leftarrow to exit.
- Sort
 - Playback Order



Multimedia Menu: Video

- 1 Use Directional buttons \uparrow / \downarrow / \leftarrow / \rightarrow to browse device Video folder.
- 2 Press Left \leftarrow button or the **GLOBAL return** button \leftarrow to go back to main menu.

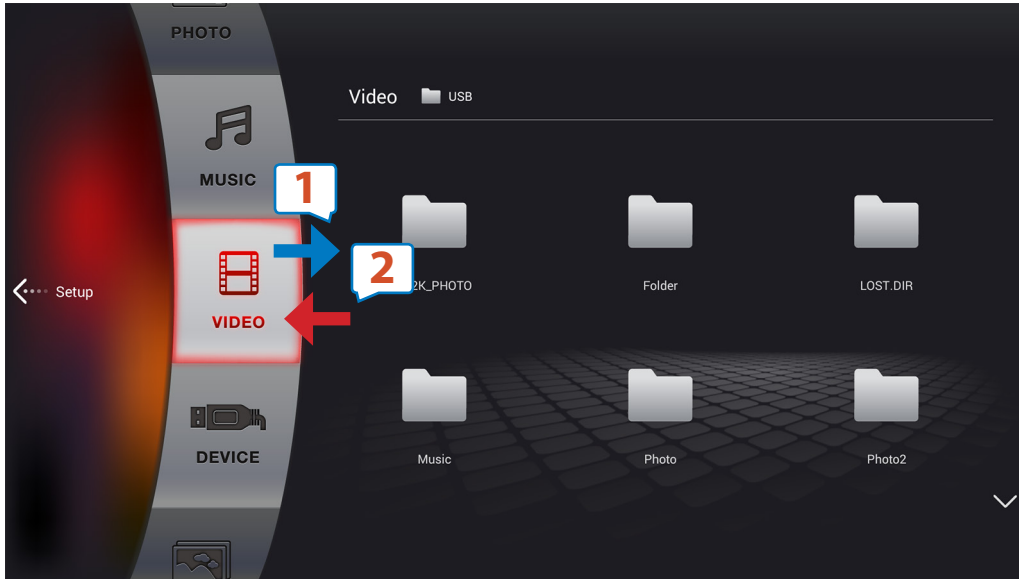

- 1 Press Left \leftarrow button to enter Video setting menu.
 - 2 Press Right \rightarrow button or the **GLOBAL return** button \leftarrow to exit.
- Sort

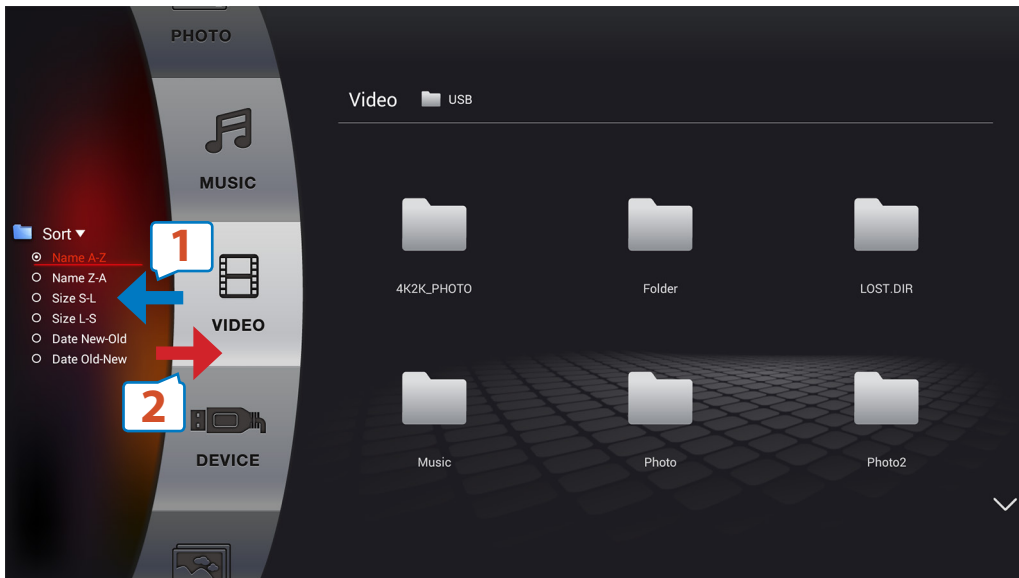

Roku App

Launch Roku App

Press **Home** key anytime when TV is on and Roku streaming stick is plugged into the TV, or press the **Input** button and select "Roku" on the input source.



Roku Remote Control Operation Instructions

RW button-Rewind: Rewind, scroll left one page at a time.

Play/Pause button: Start or pause playback.

FF button: Fast Forward, scroll right one page at a time.

Back button: Return to previous screen.

Roku Home button: Return to Roku home screen.

Info* button: View more options

Directional buttons: Move up, down, left or right.

OK button: Select an option from a menu.

Instant Replay button: Replays last 10 seconds of video.

(Note: Qwerty Keyboard and touchpad does not support Roku.)

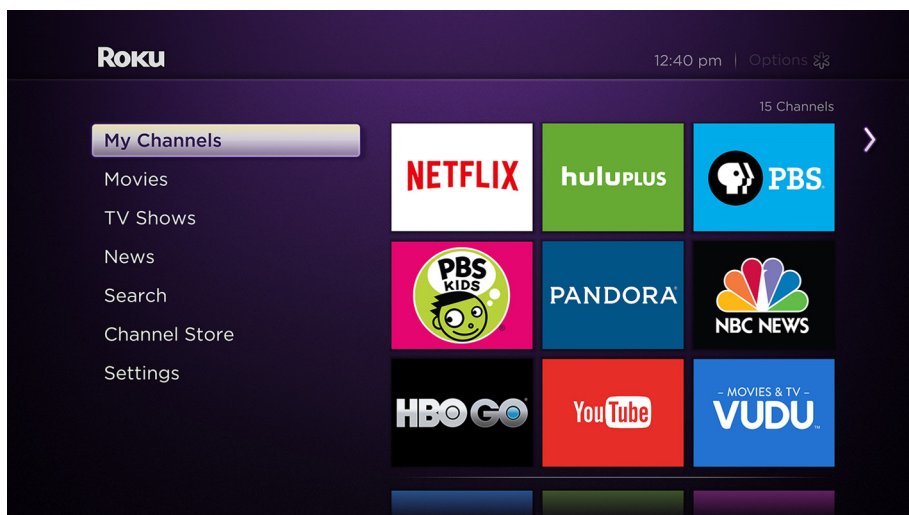

Appendix

Supported Resolution

Model Name	DM65USR / DM85UXR
Supported HDMI Timing	3480x2160 p@ 30/25/24 Hz
	1920x1080 p/i@ 60/50 Hz
	1920x1080 p@ 24 Hz
	1280x720 p@ 60/50Hz
	720x480 p@ 60 Hz
	720x576 p/i@ 50 Hz
	640x480 p@ 60 Hz
	*3480x2160 p@ 60 Hz
Supported Video Timing (NTSC, Composite)	480i
Supported Video Timing (ATSC, Composite)	1080 60i/30p/24p
	720 60p/30p/24p
	480 60p/60i/30p/24p

*8 bits, 4:2:0 on HDMI 2.0 ports only (HDMI Port 1-4)

Troubleshooting

If your TV fails to work properly, check the following guidelines for possible causes and solutions. Consult your local dealer or service outlet if problems persists.

Problem	Solution
No power.	<ul style="list-style-type: none"> • Make sure the power cord is plugged in. • The power is off, press the Power button to turn on the TV. • Try another outlet. • Unplug the unit for an hour, then plug it back in.
Poor sound or no sound.	<ul style="list-style-type: none"> • Press the VOL+ button on the remote control or on the TV to adjust volume . • Press MUTE on the remote control to ensure that mute is not on. • The channel or cable TV is experiencing problems, tune to another channel. • Check the TV audio settings. • Check for possible sources of interference.
Poor picture or no picture.	<ul style="list-style-type: none"> • The channel or cable TV is experiencing problems, tune to another channel. • Make sure that channels are set into memory. • Check the antenna or cable TV connections. • Check for possible sources of interference.
Poor reception on some channels.	<ul style="list-style-type: none"> • The channel or cable TV is experiencing problems, tune to another channel. • Make sure that channels are set into memory. • The network signal is weak, adjust the antenna to receive better reception. • Check for possible sources of interference.
The remote control does not work.	<ul style="list-style-type: none"> • Batteries may be weak, dead, or inserted incorrectly. • Point the remote control directly at the remote sensor on the TV with an angle of 35°. • Remove any obstacles between the remote control and the TV. • Remote control is out of range, move closer to the TV. • Make sure LED Indicator is lit up when any button is pressed.
TV shuts off.	<ul style="list-style-type: none"> • Sleep timer is on. • Power is interrupted.
No CATV reception.	<ul style="list-style-type: none"> • Check all cable TV connections. • Set the TV Mode in Channel menu.
Closed caption is not activated.	<ul style="list-style-type: none"> • The program tuned is not closed captioned. Try another channel. • Enable Closed Caption in the menu.

Specifications

Specifications are subject to change without prior notice.

	DM65USR	DM85UXR
Display Specification		
Size Class (Diagonal)	65" (actual viewable size: 65")	85" (actual viewable size: 84.5")
Resolution / Aspect:	3840 x 2160 / 16:9	3840 x 2160 / 16:9
Backlit	DLED	DLED
Refresh Rate / Frame Rate:	CM240HZ	CM240HZ
Contrast Ratio:	3000:1	3000:1
TV Features		
Color Enhancement:	Yes	Yes
Built-in NTSC / ATSC / Clear AQM Tuner	Yes	Yes
PIP/POP:	No	No
Close Caption:	Yes	Yes
Parental Control:	Yes	Yes
Electronic Programming Guide (EPG)	No	No
Picture Modes:	Yes	Yes
Audio		
Audio Technology:	MTS Stereo Decoder	MTS Stereo Decoder
	Dolby Digital Plus Decoder (5.1 Ch Pass Through)	Dolby Digital Plus Decoder (5.1 Ch Pass Through)
Graphic Equalizer:	Yes	Yes
Speaker Output Power:	15 Watts x 2	15 Watts x 2
Mechanical		
Wall Mount Pattern:	400mm x 400mm	400mm x 600mm
Without Stand (WXHxD) and Weight (Approx.):	57.4" x 33.4" x 2.7" / 52.4 lbs	75.1" x 42.9" x 3.1" / 148.8 lbs
With Stand (WXHxD) and Weight (Approx.):	57.4" x 35.1" x 14.7" / 59.5 lbs	75.1" x 45.7" x 19.9" / 154.3 lbs
Convenience Features		
Ambient Sensor:	Yes	Yes
Interactive Setup Guide:	Yes	Yes
Input Port Naming:	Yes	Yes
Audio Only Mode:	No	No
HDMI-ARC:	Yes	Yes
HDMI-CEC:	Yes	Yes
USB Multimedia (Picture Viewer)	Yes	Yes
Remote:	Yes	Yes
Energy Saving Features		
Auto Power OFF (DPMS)	Yes	Yes
Energy Star:	No	No
Input / Output		
Input		
Antenna In:	1	1
HDMI:	5 (4 HDMI 2.0 / 1 HDMI/MHL)	5 (4 HDMI 2.0 / 1 HDMI/MHL)
Component:	1	1
Composite (RCA):	1 (shared with component)	1 (shared with component)
VGA / RGB:	0	0
Music Port:	0	0
USB:	2 (1xUSB 2.0 / 1xUSB 3.0)	2 (1xUSB 2.0 / 1xUSB 3.0)
Output		
Optical Digital Audio Out:	1	1
Stereo Audio Out:	1	1

What's in the box



Roku® Streaming Stick™
(Roku Ready® Version)

What you need*

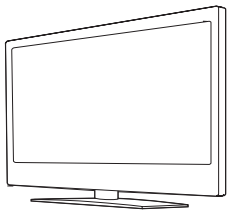

Roku Ready® TV
(or other device)

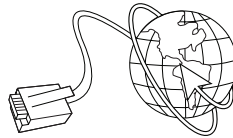

High speed
Internet

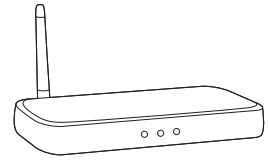

Wireless Router

Know your Streaming Stick™

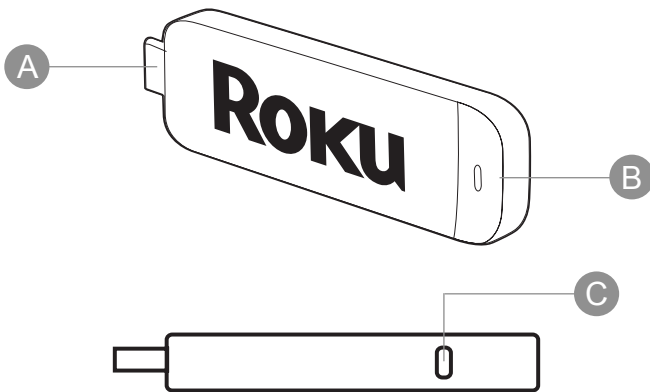

- A** [MHL CONNECTOR] Plugs into the MHL port on the back of your TV.
- B** [STATUS LIGHT] Signifies it is on when lit, or activity when flashing.
- C** [RESET BUTTON] Used to reset your Streaming Stick (you probably won't ever have to use this).

*Pssst! Subscription may be required to access some content. For example, Netflix requires a subscription to access titles in the Netflix streaming catalog. Some channels may not be available in all countries Roku products are sold.

What to do

Plug it in

Plug your Roku® Streaming Stick™ into the MHL® port of your TV or other Roku Ready® device. Simple as that!

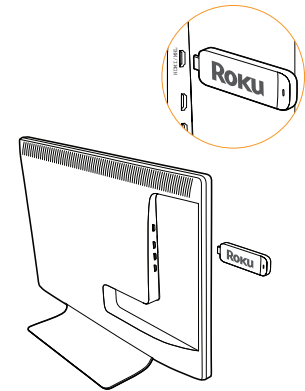

Connect to network

Now you can grab your remote and jump right into guided setup. Have your network name and password ready and do the following:

- Select your network from the list of available networks.
- Enter your network password, if you use one. Remember, network passwords are case sensitive.

Complete guided setup

It's the final stretch and hooray—it's a breeze! Continue following the on-screen instructions and you'll:

- Get the latest software.
- Link the Roku® Streaming Stick™ to your Roku account on your computer.

Your Roku account

During setup, you'll be prompted to create our Roku account online at roku.com/link. Your Roku® Streaming Stick™ will generate a unique code that links your player to your new account. Roku accounts are free. And while a valid credit card number is required to create your account, rest assured you will only be charged if you authorize purchases of apps and games from the Roku Channel Store.

Troubleshooting

Having trouble completing setup? Don't worry: it's usually an easy fix.

If you cannot see a picture on your TV:

- Make sure your TV is turned on. (This tip could save you some embarrassment.)
- Make sure the video input on your TV or home theater receiver is set to match the output (usually HDMI® or MHL®) used with the Roku® Streaming Stick™. Most TVs have an Input button on the remote control to change video inputs.

If you cannot connect to your wireless home network during guided setup:

- If you are not getting 3 or more signal-strength bars above your wireless network, adjust the location to your Roku® Streaming Stick™ and/or wireless router. Make sure there are no obstructions, like cement walls, between your Roku® Streaming Stick™ and your wireless router.
- Make sure you select the correct wireless router name on the “Wireless” screen.
- Make sure you enter the correct password, if your network is security enabled (password is case sensitive).
- If you have turned off SSID broadcasting on your wireless router, you can add your network by selecting “My network is not shown” from the “Wireless” screen.

If you cannot hear sound:

- Make sure the connectors on the cables between your TV and home theater receiver are pushed in all the way.
- Make sure the volume on your TV or home theater receiver is turned up and isn't on mute.
- Make sure the input on your TV or home theater receiver matches the output (HDMI® or MHL®) used with your Roku™ Streaming Stick™.

Need more help?

roku.com/support

Get the most out of your Roku™ Streaming Stick™.

Check out our FAQs, instructional videos and user forums.

ROKU®

© 2014 Roku, Inc. All rights reserved. ROKU®, the ROKU Logo, ROKU READY®, the ROKU READY Logo, and STREAMING STICK™ are trademarks and/or registered trademarks of Roku, Inc. in the United States and other countries. Other brand and product names are trademarks or registered trademarks of their respective owners.

Limited Warranty

ON PARTS AND LABOR

This Limited Warranty covers units that are purchased as new and in the United States Only. This Product is manufactured, distributed, and warranted by AmTRAN Video Corporation (hereinafter known as "Warrantor") under brand license by JVC KENWOOD Corporation. The Warrantor provides a warranty to the original purchaser of a new Product against defects in materials and workmanship for a period of one (1) year of non-commercial usage and ninety (90) days of commercial use. If a Product covered by this warranty is determined to be defective within the warranty period, the Warrantor will either repair or replace the Product at its sole option and discretion.

To obtain warranty service, contact our Technical Support:

Visit the Web Site: <http://jvc-tv.com/support>

Or call our Customer Support and Service Center

1-855-868-1928

PRE-AUTHORIZATION MUST BE OBTAINED BEFORE SENDING ANY PRODUCT TO A DESIGNATED SERVICE CENTER. Proof of purchase in the form of a purchase receipt or copy thereof is required to show that a Product is within the warranty period.

Parts and Labor

There will be no charge for parts or labor during the warranty period. Replacement parts and Products may be new or recertified at the Warrantor's option and sole discretion. Replacement parts and Products are warranted for the remaining portion of the original warranty or for ninety (90) days from warranty service or replacement, whichever is longer.

Type of Service

Defective Products must be sent to the designated service center to obtain warranty service. The Warrantor is not responsible for the transportation costs to the service center, but will cover the costs for return shipping to the customer. PRE-AUTHORIZATION IS REQUIRED BEFORE SENDING ANY PRODUCT TO A DESIGNATED SERVICE CENTER FOR WARRANTY SERVICE.

Product returned to designated service centers must utilize either the original carton box and shipping material or packaging that affords an equal degree of protection. Technical Support will provide instructions for packing and shipping the covered Product to the designated service center.

Limitations and Exclusions

The Warrantor's one-year limited warranty only covers defects in materials and workmanship. This warranty does not cover product issues caused by any other reason, including but not limited to cosmetic damage, normal wear and tear, improper operation, improper voltage supply or power surges, signal issues, damages from shipping, acts of God, any type of customer misuse, modifications or adjustments, as well as installation and set-up issues or any repairs attempted by anyone other than by an authorized service center. Products with unreadable or removed serial numbers, or requiring routine maintenance are not covered. This one year limited warranty does not cover Products that are sold "AS IS", "Open Box", "FACTORY RECERTIFIED", or by a non-authorized reseller.

THERE ARE NO EXPRESS WARRANTIES OTHER THAN THOSE LISTED OR DESCRIBED ABOVE. ANY IMPLIED WARRANTIES, INCLUDING ANY IMPLIED WARRANTY OF MERCHANTABILITY.

AND FITNESS FOR A PARTICULAR PURPOSE, SHALL BE LIMITED IN DURATION TO THE PERIOD OF TIME SET FORTH ABOVE. THE WARRANTOR'S TOTAL LIABILITY FOR ANY AND ALL LOSSES AND DAMAGES RESULTING FROM ANY CAUSE WHATSOEVER INCLUDING WARRANTOR'S NEGLIGENCE, ALLEGED DAMAGE, OR DEFECTIVE GOODS, WHETHER SUCH DEFECTS ARE DISCOVERABLE OR LATENT, SHALL IN NO EVENT EXCEED THE PURCHASE PRICE OF THE PRODUCT. THE WARRANTOR SHALL NOT BE RESPONSIBLE FOR LOSS OF USE, LOSS OF INFORMATION OR DATA, COMMERCIAL LOSS, LOST REVENUE OR LOST PROFITS, OR OTHER INCIDENTAL OR CONSEQUENTIAL DAMAGES. SOME STATES DO NOT ALLOW LIMITATIONS ON HOW LONG AN IMPLIED WARRANTY LASTS OR THE EXCLUSION OF INCIDENTAL OR CONSEQUENTIAL DAMAGES, SO THE ABOVE LIMITATIONS OR EXCLUSIONS MAY NOT APPLY TO YOU. THIS WARRANTY GIVES YOU SPECIFIC LEGAL RIGHTS, AND YOU MAY ALSO HAVE OTHER RIGHTS, WHICH VARY FROM STATE TO STATE. THIS WARRANTY IS SUBJECT TO CHANGE WITHOUT NOTICE. CHECK TV.JVC.COM FOR THE MOST CURRENT VERSION.

Personal Data

If your Product is capable of storing personal data and other information, all contents and information will be deleted in the course of some in-home and all ship-in warranty service. If this occurs, your product will be restored to you configured as originally purchased. You will be responsible for restoring all applicable data and passwords. Recovery and reinstallation of user data is not covered under this Limited Warranty. In order to protect your personal information, we recommend that you always clear all personal information from the unit before it is serviced, regardless of the servicer.

Important Open Source Software Notice

Some JVC device may contain free software which is based on the license granted under the GNU General Public License and Lesser General Public License (hereinafter "GPL/LGPL") that are subject to the GPL2.0/LGPL2.1 You may use, modify, or distribute only if you agree to all of the terms and conditions of the GPL/LGPL. For more details on the list of JVC devices with open source software, please visit : <http://jvc-tv.com/support>

Please note that any software component developed or created independently by AmTRAN Video Corporation shall not be subject to "GPL/LGPL" requirement for provision of the source code. Users are urged to read the details for the relevant license carefully before using the software component covered by "GPL/LGPL."

You can obtain a copy of the GPL/LGPL license from <http://www.gnu.org/licenses/gpl> and <http://www.gnu.org/licenses/lgpl>.

For details of any open source software on your JVC device, please visit the following web site: <http://jvc-tv.com/support>

Please note that we are unable to answer any inquiry relating to the contents, etc of the source code. Permission is hereby granted, free of charge, to any person obtaining a copy of any such software and associated documentation files (the "Open Source Software"), to deal in the Open Source Software without restriction including without limitation the rights to use, copy, modify, merge, publish, distribute, sublicense, and/or sell copies of the Open Source Software, and to permit persons to whom the Open Source Software is furnished to do so, subject to the following conditions:

THE SOFTWARE IS PROVIDED "AS IS", WITHOUT WARRANTY OF ANY KIND, EXPRESS OR IMPLIED, INCLUDING BUT NOT LIMITED TO THE WARRANTIES OF MERCHANTABILITY, FITNESS FOR A PARTICULAR PURPOSE AND NON-INFRINGEMENT, IN NO EVENT SHALL THE AUTHORS OR COPYRIGHT HOLDERS BE LIABLE FOR ANY CLAIM, DAMAGES OR OTHER LIABILITY, WHETHER IN AN ACTION OF CONTRACT, TORT OR OTHERWISE, ARISING FROM, OUT OF OR IN CONNECTION WITH THE SOFTWARE OR THE USE OR OTHER DEALINGS IN THE SOFTWARE.

Third Party Application Notice

You may encounter third-party applications (including links to websites, widgets, software or other software utilities ("Applications")) that interact with the Product. Such Applications are owned and operated by third parties that are not related to or sponsored by us. Use of an Application through the Product is at your own option and risk. We do not endorse any included third-party Applications or third-party products or services. Your use of included Applications is subject to the terms of use and privacy policy of the Application provider.

Roku® Streaming Stick™ (Roku Ready® Version)

Important Product Information

The License Agreement

The Roku and third-party software license terms can be found at: www.roku.com/license. Use of the Roku® Streaming Stick™ (Roku Ready® Version) constitutes acceptance of as well as agreement to those license terms.

One (1) Year Limited Hardware Warranty

Subject to the additional terms and conditions set forth below, Roku provides this Limited Warranty:

- Only to the person or entity that originally purchased the Streaming Stick from Roku or from one of its authorized re-sellers or distributors; and
- Only for Streaming Sticks purchased and delivered to the end user within the United States and Canada.

Limited Warranty

Roku warrants the Streaming Stick hardware against defects in materials and workmanship under normal use for a period of one (1) year from the date of purchase (“Warranty Period”). If Roku determines that the Streaming Stick’s hardware is defective, Roku will either repair the unit or replace the unit with either a new or rebuilt Streaming Stick, at its option. If the Warranty Period has expired or is otherwise not applicable (see Scope and Limitation on Warranty below), we will return the Streaming Stick to you. More information about this warranty can be found at www.roku.com/support. THE FOREGOING SETS FORTH ROKU’S SOLE OBLIGATION AND YOUR EXCLUSIVE REMEDY IN THE EVENT OF ANY BREACH OF THIS LIMITED WARRANTY. Return and Warranty Service Process Please access and review the online help resources at www.roku.com/support before seeking warranty service. To return or obtain warranty service for a Streaming Stick, you must first obtain a Return Merchandise Authorization (RMA) number from a Customer Support Representative (CSR) at Roku.

Customer Support

Contact information can be found by visiting www.roku.com/support. RMA numbers expire thirty days from issuance. Roku may attempt to troubleshoot a warranty-related problem prior to issuing a RMA number. Please be prepared to provide additional information upon request. Once a RMA number is obtained, you must ship your Streaming Stick, freight prepaid, together with proof of purchase and all accessories, in either the original packaging or packaging affording an equal degree of protection, to the Roku authorized distribution facility identified by the CSR. Failure to return any of the accessories could result in a delay and/or result in an invoice to you or credit to Roku for the missing accessories. Important: When emailing for a RMA number, please provide the following information with your request: (a) model number, (b) serial number, (c) problem description, (d) software version (located in the System Configuration menu), (e) date of purchase, (f) place of purchase (reseller or online place of purchase), and (g) return shipping address (P.O. boxes are not accepted). Scope of and Limitation on Warranty The warranty on the Streaming Stick is limited to the repair or replacement of defective units as described in the Limited Warranty section above. This warranty does not cover customer training or education, installation, set up adjustments, or signal reception problems. This warranty also does not cover any issue related to the service provided by your Service Provider, including but not limited to service disruption, changes in service terms, changes in offerings, changes in format, or technical problems. This warranty does not cover damage due to acts of God, accident, misuse, abuse, negligence, commercial use or modification of, or to any part of, your Streaming Stick.

This warranty does not cover damage due to improper operation or maintenance, connection to improper voltage supply or attempted repair by anyone other than a facility authorized by Roku to service your Streaming Stick. This warranty does not cover consumables (such as fuses and batteries).

Legal Notices

Federal Communication Commission Interference Statement

This equipment has been tested and found to comply with the limits for a Class B digital device, pursuant to Part 15 of the FCC Rules. These limits are designed to provide reasonable protection against harmful interference in a residential installation. This equipment generates, uses and can radiate radio frequency energy and, if not installed and used in accordance with the instructions, may cause harmful interference to radio communications. However, there is no guarantee that interference will not occur in a particular installation. If this equipment does cause harmful interference to radio or television reception, which can be determined by turning the equipment off and on, the user is encouraged to try to correct the interference by one of the following measures:

- Reorient or relocate the receiving antenna.
- Increase the separation between the equipment and receiver.
- Connect the equipment into an outlet on a circuit different from that to which the receiver is connected.
- Consult the dealer or an experienced radio/TV technician for help.

This device complies with Part 15 of the FCC Rules. Operation is subject to the following two conditions: (1) This device may not cause harmful interference, and (2) this device must accept any interference received, including interference that may cause undesired operation.

FCC Caution: Any changes or modifications not expressly approved by the party responsible for compliance could void the user's authority to operate this equipment. IEEE 802.11b or 802.11g operation of this product in the U.S.A. is firmware limited to channels 1 through 11. Wireless Radio Use:

This device is restricted to indoor use when operating in the 5.15 to 5.25 GHz frequency band.

IMPORTANT NOTE:

FCC Radiation Exposure Statement: This equipment complies with FCC radiation exposure limits set forth for an uncontrolled environment. This equipment should be installed and operated with minimum distance 20cm between the radiator and your body. This transmitter must not be collocated or operating in conjunction with any other antenna or transmitter.

Note to US model owner:

To comply with US FCC regulation, the country selection function has been completely removed from all US models. The availability of some specific channels and/or operational frequency bands are country dependent and are firmware programmed at the factory to match the intended destination. The firmware setting is not accessible by the end user.

Industry Canada statement

This device complies with RSS-210 of the Industry Canada Rules. Operation is subject to the following two conditions: (1) this device may not cause harmful interference, and (2) this device must accept any interference received, including interference that may cause undesired operation.

French translation:

Ce dispositif est conforme à la norme CNR-210 d'Industrie Canada applicable aux appareils radio exempts de licence. Son fonctionnement est sujet aux deux conditions suivantes: (1) le dispositif ne doit pas produire de brouillage préjudiciable, et (2) ce dispositif doit accepter tout brouillage reçu, y compris un brouillage susceptible de provoquer un fonctionnement indésirable.

Safety Precautions

The Streaming Stick has been designed with the highest concern for safety. However, any electrical device, if used improperly, has the potential for causing fire, electrical shock or personal injury. To help ensure accident-free operation, follow these guidelines:

- Observe all warnings, precautions and instructions.
- Stop use, unplug the device that the Streaming Stick is inserted into from the electrical outlet and disconnect any other cables immediately if the Streaming Stick or the device functions in an abnormal manner, produces unusual sounds or smells or becomes too hot to touch.
- For more information on product safety and troubleshooting, please go to www.roku.com/support. Use and Handling
- When playing video games, use in a well-lit area and stand or sit as far away from the screen as possible.
- Take a 10-15 minute break every hour if playing video games and avoid prolonged use of the remote.
- Stop playing video games if you begin to feel tired or if you experience discomfort or pain in your hands or arms while operating the remote if the condition persists, consult a doctor.
- If you experience any of the following health problems, discontinue use of the Streaming Stick immediately:
 - Dizziness, nausea, fatigue or symptoms similar to motion sickness.
 - Discomfort or pain in a part of the body, such as eyes, ears, hands, or arms. If symptoms persist, consult your physician.
- Keep the Streaming Stick and any accessories, including the remote, out of the reach of small children.
- Do not touch the Streaming Stick during an electrical storm.
- Do not allow liquid, small particles or other foreign objects to get into the Streaming Stick or accessories.
- Do not expose the Streaming Stick to smoke or steam.
- Do not expose the Streaming Stick or accessories to high, temperatures, high humidity or direct sunlight.

www.roku.com

Copyright © 2014 Roku, Inc. All rights reserved. Roku and the Roku logo are trademarks or registered trademarks of Roku, Inc.

JVC

Do not send product or other
correspondence to this address

Place
Stamp
Here

JVC

Attn: Product Registration

**P.O. BOX 50427
IRVINE, CA 92619**

Register Online: <http://jvc-tv.com/support>

First Name	
Last Name	
Address	
Apt. #	
City	
State	
Zip Code	
Phone Number	
E-mail Address	

Model Number	
Serial Number	
Dealer Name	
Purchase Price	
Date of Purchase	
Comments	

I would like to receive the JVC Community e-mail newsletter

WE ARE HERE TO HELP!



FOR HELP WITH TELEVISION SUPPORT:

1-855-868-1928

WE CAN HELP YOU WITH:

DAMAGED PACKAGE • MISSING PARTS • TECHNICAL SUPPORT

FOR HELP WITH ROKU® STREAMING STICK™:

CALL ROKU CUSTOMER SUPPORT: 1-88-600-7658 (ROKU)

WWW.ROKU.COM/SUPPORT

JVC