

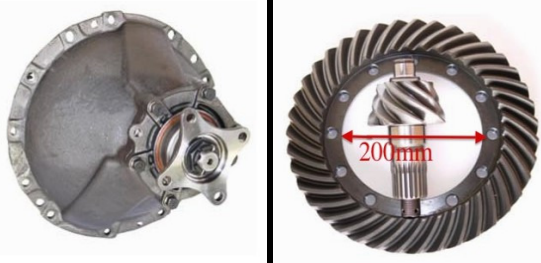



JOYWELL MOTOR CORPORATION

HEAD OFFICE : 12F-2, NO. 787, ZHONGMING SOUTH ROAD,
 402 TAICHUNG, TAIWAN, R.O.C.
 TEL/886-4-35008377(REP) FAX/886-4-35008378
 E-MAIL : jmc.group@msa.hinet.net

FUSO

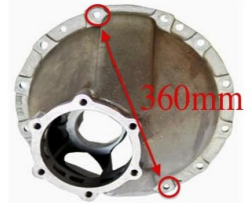
FK61 / 6M61 / 6M60



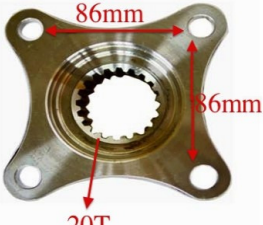

	GEAR No.	RATIO	PARTS No.
	6x37	6.1	MC075131
	6x40	6.6	MC075131S
	8x39	4.8	MC834997
	9x37	4.1	MC444937

RETARDER CASE	DIFFERENTIAL CASE	GEARS	BEARING HOUSING	YOKE
 <p>MOUNTING: 12xBOLTS (12mm) 360mm</p>	 <p>BEARINGS: 32214x2pcs 12xBOLTS(16mm)</p>	 <p>11T, 16T, 22T 168mm</p>	 <p>BEARINGS: 30311x1pc 30309x1pc OIL SEAL: 60-103-10/34.5</p>	 <p>86mm, 86mm, 20T</p>

FUSO

FK612 / FK622

	GEAR No.	RATIO	PARTS No.
	8x39	4.8	MC834741
	7x38	5.4	MC076705
	6x40	6.6	MC075140
	6x37	6.1	MC075141
	8x37	4.6	MC864104
	9x37	4.1	MC076530
	DIFFERENTIAL ASSEMBLY		MC864062
	DIFFERENTIAL ASSEMBLY		MC868294



RETARDER CASE	DIFFERENTIAL CASE	GEARS	BEARING HOUSING	YOKE
 <p>MOUNTING: 12BOLTSx12mm 360mm</p>	 <p>BEARING: 32214x2pcs 12BOLTSx16mm</p>	 <p>11T, 16T, 22T 168mm</p>	 <p>BEARING: 30311 x1PC 30310 x1PC OIL SEAL: 65-113-10/30</p>	 <p>110mm, 22T, 86mm, 86mm</p>





JOYWELL MOTOR CORPORATION

HEAD OFFICE : 12F-2, NO. 787, ZHONGMING SOUTH ROAD,
 402 TAICHUNG, TAIWAN, R.O.C.
 TEL/886-4-35008377(REP) FAX/886-4-35008378
 E-MAIL : jmc.group@msa.hinet.net

FUSO

6D16 / FM517

		GEAR No.	RATIO	PARTS No.
		6x40	6.6	MC839938
		6x37	6.1	MC817479
		7x39	5.5	MC814389
		7x36	5.1	MC150736
		8x37	4.6	MC150837
		DIFFERENTIAL ASSY	6.1	MK350243

RETARDER CASE	DIFFERENTIAL CASE	GEARS	BEARING HOUSING	YOKE
MOUNTING: 16BOLTSx12mm 	BEARING: 32217x2pcs 		BEARING: 30312x1pc 30311x1pc 	
	12BOLTSx20mm		OIL SEAL: 70-122-12/30.3	

FUSO

M91 / TRAILER AND DUMP TRUCK / 20TEETH

		GEAR No.	RATIO	PARTS No.
		6x40	6.6	MC834813
		6x37	6.1	
		7x39	5.5	
		7x36	5.1	MC892921
		8x37	4.6	MC061889
		9x38	4.2	
		DIFFERENTIAL ASSEMBLY		MK350398
DIFFERENTIAL ASSEMBLY		MC350948		

RETARDER CASE	DIFFERENTIAL CASE	GEARS	BEARING HOUSING	YOKE
				

JOYWELL MOTOR CORPORATION



HEAD OFFICE : 12F-2, NO. 787, ZHONGMING SOUTH ROAD,
 402 TAICHUNG, TAIWAN, R.O.C.
 TEL/886-4-35008377(REP) FAX/886-4-35008378
 E-MAIL : jmc.group@msa.hinet.net

FUSO

FV413 / FV415 / FV416 / FV419 / FV515 / FV517
(18 TEETH/15 TONS)

	GEAR No.	RATIO	PARTS No.
	DIFFERENTIAL ASSY	6.1	MK351676
	DIFFERENTIAL ASSY	4.6	MK350830

	TYPE	GEAR No.	RATIO	PARTS No.
	R/R	6x45	7.5	MC809464
		6x43	7.1	MC411419
		6x41	6.8	MC411641
		6x40	6.6	MC804120
				MC827163
		6x37	6.1	MC827160
		7x39	5.5	MC831408
		7x36	5.1	
		8x37	4.6	MC320837
		11x38	3.4	
		11x39	3.5	
11x42		3.8		

RETARDER CASE	DIFFERENTIAL CASE	GEARS	BEARING HOUSING	YOKE
MOUNTING: 18BOLTSx14mm 	BEARING:32218x2pc  12 BOLTSx20mm		BEARING:30313x1pc 30312x1pc  OIL SEAL. 70-142-12/30.3	





JOYWELL MOTOR CORPORATION

HEAD OFFICE : 12F-2, NO. 787, ZHONGMING SOUTH ROAD,
 402 TAICHUNG, TAIWAN, R.O.C.
 TEL/886-4-35008377(REP) FAX/886-4-35008378
 E-MAIL : jmc.group@msa.hinet.net

FUSO

FV413 / FV415 / FV416 / FV419 / FV515 / FV517 / FV519
(18 TEETH/15 TONS)



		GEAR No.	RATIO	PARTS No.
		F 6x37	6.1	MC804122
		F 6x40	6.6	MC804124
		F 7x39	5.5	MC831408
		F 7x36	5.1	MC831735
		F 8x37	4.6	MC320837
		F 6x41	6.8	MC411641
		F 6x43	7.1	MC411418
		F 6x45	7.5	MC809467





RETARDER CASE	DIFFERENTIAL CASE	GEARS	BEARING HOUSING	YOKE
				

JOYWELL MOTOR CORPORATION



HEAD OFFICE : 12F-2, NO. 787, ZHONGMING SOUTH ROAD,
 402 TAICHUNG, TAIWAN, R.O.C.
 TEL/886-4-35008377(REP) FAX/886-4-35008378
 E-MAIL : jmc.group@msa.hinet.net





ISUZU 10 WHEELS

		GEAR No.	RATIO	PARTS No.
		F 6×43	7.1	1-41210-293-1
		F 6×41	6.8	1-41210-473-0
		F 7×43	6.1	1-41210-308
		F 7×45	6.4	1-41210-287
		F 7×39	5.5	1-41210-309

RETARDER CASE	DIFFERENTIAL CASE	GEARS	BEARING HOUSING	YOKE
				

ISUZU 10 WHEELS

		GEAR No.	RATIO	PARTS No.
		R 6×43	7.1	1-41210-294-0
		R 6×41	6.8	1-41210-303
		R 7×43	6.1	1-41210-408-0
		R 7×45	6.4	1-41210-274
		R 7×39	5.5	1-41210-301-0





RETARDER CASE	DIFFERENTIAL CASE	GEARS	BEARING HOUSING	YOKE
				

JOYWELL MOTOR CORPORATION

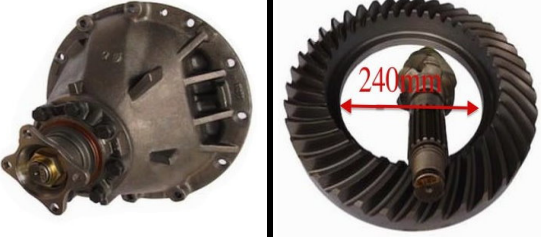
HEAD OFFICE : 12F-2, NO. 787, ZHONGMING SOUTH ROAD,
 402 TAICHUNG, TAIWAN, R.O.C.
 TEL/886-4-35008377(REP) FAX/886-4-35008378
 E-MAIL : jmc.group@msa.hinet.net

ISUZU FTR

	GEAR No.	RATIO	PARTS No.
	6×39	6.5	1-41210-276
	7×39	5.5	1-41210-280-0
	7×43	6.1	1-41210-277-0

RETARDER CASE	DIFFERENTIAL CASE	GEARS	BEARING HOUSING	YOKE
 <p>MOUNTING: 12BOLTSX14mm 402mm</p>	 <p>BEARING: 32216x2pcs 16BOLTSx16mm</p>	 <p>16T, 24T, 39T, 94mm, 10T</p>	 <p>BEARING: 30311x1pc 30310x1pc OIL SEAL: 68-124-11.5/27</p>	 <p>70mm, 97mm, 18T</p>

ISUZU KS

	GEAR No.	RATIO	PARTS No.
	7×39	5.5	
	7×43	6.1	

RETARDER CASE	DIFFERENTIAL CASE	GEARS	BEARING HOUSING	YOKE
				

JOYWELL MOTOR CORPORATION

HEAD OFFICE : 12F-2, NO. 787, ZHONGMING SOUTH ROAD,



402 TAICHUNG, TAIWAN, R.O.C.





TEL/886-4-35008377(REP) FAX/886-4-35008378

E-MAIL : jmc.group@msa.hinet.net

ISUZU

FRR / FSR

		GEAR No.	RATIO	PARTS No.
		7×38	5.4	
		8×41	5.1	
		10×39	3.9	

RETARDER CASE	DIFFERENTIAL CASE	GEARS	BEARING HOUSING	YOKE
				

JOYWELL MOTOR CORPORATION



HEAD OFFICE : 12F-2, NO. 787, ZHONGMING SOUTH ROAD,
402 TAICHUNG, TAIWAN, R.O.C.





TEL/886-4-35008377(REP) FAX/886-4-35008378

E-MAIL : jmc.group@msa.hinet.net

TOYOTA & HINO

14B / 15B

		GEAR No.	RATIO	PARTS No.
		8x45	5.62	
		7x39	5.57	



RETARDER CASE	DIFFERENTIAL CASE	GEARS	BEARING HOUSING	YOKE
				





JOYWELL MOTOR CORPORATION

HEAD OFFICE : 12F-2, NO. 787, ZHONGMING SOUTH ROAD,
 402 TAICHUNG, TAIWAN, R.O.C.
 TEL/886-4-35008377(REP) FAX/886-4-35008378
 E-MAIL : jmc.group@msa.hinet.net

HINO



FS





		GEAR No.	RATIO	PARTS No.
		7×45	6.4	41201-1382
		6×41	6.8	41201-1101

RETARDER CASE	DIFFERENTIAL CASE	GEARS	BEARING HOUSING	YOKE
 <p>MOUNTING: 16BOLTS x 14mm 425mm</p>	 <p>BEARING: 181504x2pcs 12-BOLTS x20mm</p>	 <p>34T 230mm 10T 16T</p>	 <p>BEARING: 913849x1pc 30312x1pc OIL SEAL: 80-136-10/26</p>	 <p>86mm 123mm 29T</p>

HINO

500GH



		GEAR No.	RATIO	PARTS No.
		8×37	4.6	41201-3600
		10×39	3.9	41221-4360
		10×43	4.3	41201-4190





RETARDER CASE	DIFFERENTIAL CASE	GEARS	BEARING HOUSING	YOKE
				

JOYWELL MOTOR CORPORATION

HEAD OFFICE : 12F-2, NO. 787, ZHONGMING SOUTH ROAD,
402 TAICHUNG, TAIWAN, R.O.C.
TEL/886-4-35008377(REP) FAX/886-4-35008378
E-MAIL : jmc.group@msa.hinet.net



HINO KG / KL 700/500F





		GEAR No.	RATIO	PARTS No.
		F 7x45	6.4	41201-3040
		F 6x41	6.8	41201-3160

RETARDER CASE	DIFFERENTIAL CASE	GEARS	BEARING HOUSING	YOKE
 <p>1811 E0020 488mm MOUNTING: 16BOLTSx16mm</p>			 <p>BEARING: 913849x1pc 30x12x1pc OIL SEAL: 80-136-10/26</p>	

HINO 700/500R

HINO NEW TYPE (16 HOLES)

		GEAR No.	RATIO	PARTS No.
		R 7x45	6.4	41201-3070
		R 6x41	6.8	41201-3165

RETARDER CASE	DIFFERENTIAL CASE	GEARS	BEARING HOUSING	YOKE
 <p>1811 E0020 488mm MOUNTING: 16BOLTSx16mm</p>	 <p>BEARING: 181504x2pcs 12BOLTSx20mm</p>	 <p>34T 216mm 10T 16T</p>	 <p>BEARING: 913849x1pc 30x12x1pc OIL SEAL: 80-136-10/26</p>	 <p>86mm 86mm 34T 37T</p>

JOYWELL MOTOR CORPORATION





HEAD OFFICE : 12F-2, NO. 787, ZHONGMING SOUTH ROAD,
 402 TAICHUNG, TAIWAN, R.O.C.
 TEL/886-4-35008377(REP) FAX/886-4-35008378
 E-MAIL : jmc.group@msa.hinet.net

HINO

FF / 3H / FG

15 TONS / JO8C / H07C

	GEAR No.	RATIO	PARTS No.	REMARK
	7×45	6.4	41201-2910	IN JAPAN, FOR 7 TONS AND 8 TONS
	7×43	6.1	41201-E0300	
	7×38	5.4	41201-2540	
	8×41	5.1	41201-E0027	BUS TYPE 233PS/225PS 255PS/263PS





RETARDER CASE	DIFFERENTIAL CASE	GEARS	BEARING HOUSING	YOKE
	 <p>BEARING: 515610x2pcs 515649x2pcs</p> <p>12 BOLTS x 18mm</p>	 <p>10T, 29T, 16T</p> <p>196mm</p>	 <p>BEARING: 30312x1pc 30311x1pc</p> <p>OIL SEAL: 80-124-10/26</p>	 <p>75mm, 106mm, 29T</p>

JOYWELL MOTOR CORPORATION

HEAD OFFICE : 12F-2, NO. 787, ZHONGMING SOUTH ROAD,
 402 TAICHUNG, TAIWAN, R.O.C.
 TEL/886-4-35008377(REP) FAX/886-4-35008378
 E-MAIL : jmc.group@msa.hinet.net

HINO HINO 300 2030-0190

		GEAR No.	RATIO	PARTS No.
		6x35	5.8	41201-80187
		7x45	6.4	41201-80209
		8x37	4.6	41201-80551

RETARDER CASE	DIFFERENTIAL CASE	GEARS	BEARING HOUSING	YOKE
				





JOYWELL MOTOR CORPORATION

HEAD OFFICE : 12F-2, NO. 787, ZHONGMING SOUTH ROAD,
 402 TAICHUNG, TAIWAN, R.O.C.
 TEL/886-4-35008377(REP) FAX/886-4-35008378
 E-MAIL : jmc.group@msa.hinet.net

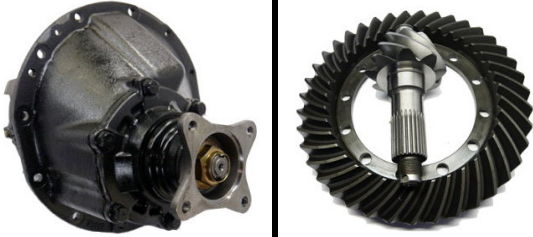
HINO

HINO 500 / 1991





	GEAR No.	RATIO	PARTS No.
	7×36	5.1	41201-E0120
	9×39	4.3	41221-4551
	10×39	3.9	41221-4552

RETARDER CASE	DIFFERENTIAL CASE	GEARS	BEARING HOUSING	YOKE
				

HINO

HINO NEW TYPE (16 HOLES) FOR PROFIA AS SO ON

	GEAR No.	RATIO	PARTS No.
	R 7×45	6.4	41201-3070
	R 6×41	6.8	41201-3165
	F 7×45	6.4	41201-3040
	F 6×41	6.8	41201-3160

RETARDER CASE	DIFFERENTIAL CASE	GEARS	BEARING HOUSING	YOKE
 MOUNTING: 16BOLTSx16mm				

JOYWELL MOTOR CORPORATION





HEAD OFFICE : 12F-2, NO. 787, ZHONGMING SOUTH ROAD,
402 TAICHUNG, TAIWAN, R.O.C.

TEL/886-4-35008377(REP) FAX/886-4-35008378

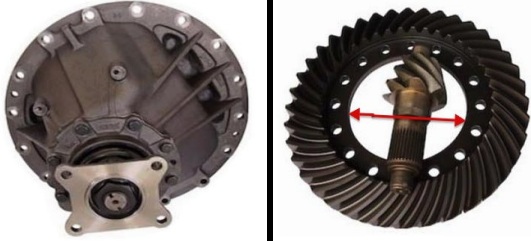
E-MAIL : jmc.group@msa.hinet.net

NISSAN UD CKA451 / KC TRAILER

	GEAR No.	RATIO	PARTS No.
	6x37	6.1	38110-91001
	7x39	5.5	38110-91110
	8x39	4.8	38110-90978
	9x39	4.3	38110-91068 38110-90967

RETARDER CASE	DIFFERENTIAL CASE	GEARS	BEARING HOUSING	YOKE
MOUNTING: 16BOLTSx16mm 	BEARING: 33218x2pcs 		BEARING: 30315x1pc 30313x1pc 	

JOYWELL MOTOR CORPORATION

HEAD OFFICE : 12F-2, NO. 787, ZHONGMING SOUTH ROAD,
 402 TAICHUNG, TAIWAN, R.O.C.
 TEL/886-4-35008377(REP) FAX/886-4-35008378
 E-MAIL : jmc.group@msa.hinet.net

NISSAN UD

RE8 / PF6 / FE6 (235HP)





	GEAR No.	RATIO	PARTS No.
	6x41	6.8	38110-9008-1
	6x37	6.1	38110-90008-2 38110-90569

RETARDER CASE	DIFFERENTIAL CASE	GEARS	BEARING HOUSING	YOKE
				

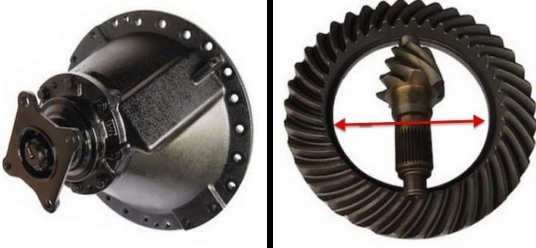
NISSAN UD

RF / RG / RH / RF6 (24 HOLES)

	GEAR No.	RATIO	PARTS No.
	6x41	6.8	38110-90219-2
	6x37	6.1	38110-90219-2
	7x39	5.5	38110-91117 38110-90917

RETARDER CASE	DIFFERENTIAL CASE	GEARS	BEARING HOUSING	YOKE
 MOUNTING: 24BOLTSx14mm	 BEARING: 32218x2pcs		 OIL SEAL: 80-135-12/26	

JOYWELL MOTOR CORPORATION

HEAD OFFICE : 12F-2, NO. 787, ZHONGMING SOUTH ROAD,
402 TAICHUNG, TAIWAN, R.O.C.



TEL/886-4-35008377(REP) FAX/886-4-35008378





E-MAIL : jmc.group@msa.hinet.net

NISSAN UD

FE6

CM86 / CM87 / CM88 / MK210 / MK211 / MK250 / MK251 / MK260

		GEAR No.	RATIO	PARTS No.
		7×40	5.7	38110-Z5100
		7×37	5.2	38110-Z5101

RETARDER CASE	DIFFERENTIAL CASE	GEARS	BEARING HOUSING	YOKE
				

JOYWELL MOTOR CORPORATION

HEAD OFFICE : 12F-2, NO. 787, ZHONGMING SOUTH ROAD,
402 TAICHUNG, TAIWAN, R.O.C.

TEL/886-4-35008377(REP) FAX/886-4-35008378





E-MAIL : jmc.group@msa.hinet.net

NISSAN UD

RF / RG / RH

	GEAR No.	RATIO	PARTS No.	REMARK
	DIFFERENTIAL ASSEMBLY		38300-92366	R
	DIFFERENTIAL ASSEMBLY		38300-93678	R
	DIFFERENTIAL ASSEMBLY		38300-93168	R
	DIFFERENTIAL ASSEMBLY		38300-93679	R

	GEAR No.	RATIO	PARTS No.	REMARK
	6x41	6.8	38110-90502	R
	6x39	6.5	38110-90503	R
	5x37	7.4	38110-90501	R

RETARDER CASE	DIFFERENTIAL CASE	GEARS	BEARING HOUSING	YOKE
MOUNTING: 16BOLTSx14mm 	BEARING: 32218x2pcs 		BEARING: 30314x1pc 30312x1pc 	

JOYWELL MOTOR CORPORATION

HEAD OFFICE : 12F-2, NO. 787, ZHONGMING SOUTH ROAD,

402 TAICHUNG, TAIWAN, R.O.C.

TEL/886-4-35008377(REP) FAX/886-4-35008378





E-MAIL : jmc.group@msa.hinet.net

NISSAN UD



RF / RG / RH

	GEAR No.	RATIO	PARTS No.	REMARK
	DIFFERENTIAL ASSEMBLY		38300-92666	F
	DIFFERENTIAL ASSEMBLY		38300-93665	F
	DIFFERENTIAL ASSEMBLY		38300-93265	F
	DIFFERENTIAL ASSEMBLY		38300-93666	F

	GEAR No.	RATIO	PARTS No.	REMARK
	6x41	6.8	38110-90476	F
	6x39	6.5	38110-90477	F
	5x37	7.4	38110-90475	F

RETARDER CASE	DIFFERENTIAL CASE	GEARS	BEARING HOUSING	YOKE
 MOUNTING: 16BOLTSx14mm	 12BOLTSx20mm		 8BOLTSx14mm	

COVER CARRIER	RETAINER BEARING	GEAR PINION	CASE ASSEMBLY	GEAR DIFF
 12BOLTSx14mm	 6BOLTSx14mm OIL SEAL: 85-110-21.3			

GEAR DRIVER	SHAFT
	 BEARING: 32214x1pc

JOYWELL MOTOR CORPORATION

HEAD OFFICE : 12F-2, NO. 787, ZHONGMING SOUTH ROAD,
402 TAICHUNG, TAIWAN, R.O.C.

TEL/886-4-35008377(REP) FAX/886-4-35008378





E-MAIL : jmc.group@msa.hinet.net

SCANIA

R780

	TYPE	GEAR No.	PARTS No.
	DIFFERENTIAL ASSEMBLY	12×37	1722314
	DIFFERENTIAL ASSEMBLY	11×36	1722315
	DIFFERENTIAL ASSEMBLY	10×34	1722316
	DIFFERENTIAL ASSEMBLY	10×38	1722317

	RATIO	GEAR No.	PARTS No.
	3.0	12×37	1327233
	3.2	11×36	1526117
	3.4	10×34	1340789
	3.8	10×38	1340792

RETARDER CASE	DIFFERENTIAL CASE	GEARS	BEARING HOUSING	YOKE
				

JOYWELL MOTOR CORPORATION

HEAD OFFICE : 12F-2, NO. 787, ZHONGMING SOUTH ROAD,
402 TAICHUNG, TAIWAN, R.O.C.

TEL/886-4-35008377(REP) FAX/886-4-35008378

E-MAIL : jmc.group@msa.hinet.net

SCANIA

R770

	TYPE	GEAR No.	PARTS No.
	DIFFERENTIAL ASSEMBLY	9×35	340850
	DIFFERENTIAL ASSEMBLY	10×35	340849

	RATIO	GEAR No.	PARTS No.
	3.88	9×35	370188
	3.5	10×35	370186

RETARDER CASE	DIFFERENTIAL CASE	GEARS	BEARING HOUSING	YOKE
		