

DiGiCo S-Series User Guide – Issue J

Issue J for Software Version 2.5



EC DECLARATION OF CONFORMITY

This is to certify that the:

DIGICO S21 MIXING CONSOLE

From serial number 210010

Manufactured by:

**DIGICO (UK) LIMITED
UNIT 10
SILVERGLADE BUSINESS PARK
LEATHERHEAD ROAD
CHESSINGTON SURREY
KT9 2QL
UNITED KINGDOM
TEL: (++44) 01372 845 600
FAX: (++44) 01372 845 656**

Conforms with the protection requirements of the Council Directive's 2004/108/EC and 2006/95/EC, relating to Electromagnetic Compatibility and Low Voltage Directive by the application of the following standards:

**EN55103-1 2009 Emission standard
EN55103-2 2009 Immunity standard
EN60065 2002 A1 2006 Low voltage directive**

Signed: 
John Robert Stadius

Position: Technical Director

Date: 24TH MARCH 2015

Copyright © 2019 Digico UK Ltd

All rights reserved.

No part of this publication may be reproduced, transmitted, transcribed, stored in a retrieval system, or translated into any language in any form by any means without the written permission of Digico UK Ltd. Information in this manual is subject to change without notice, and does not represent a commitment on the part of the vendor. Digico UK Ltd shall not be liable for any loss or damage whatsoever arising from the use of information or any error contained in this manual.

Software License Notice

Your license agreement with Digico UK Ltd, which is included with the S-Series console product, specifies the permitted and prohibited uses of the product. Any unauthorised duplication or use of Digico UK Ltd software, in whole or in part, in print or in any other storage and retrieval system is prohibited.

Licenses and Trademarks

The S21 logo, S31 logo, S21 name and S31 name are trademarks, and Digico UK Ltd and the Digico UK Ltd logo are registered trademarks of Digico UK Ltd.

Digico (UK) Ltd
Unit 10
Silverglade Business Park
Leatherhead Road
Chessington
Surrey
KT9 2QL
England
Telephone: +44 (0)1372 845600
Fax: +44 (0)1372 845656
Email: sales@digiconsoles.com
WWW: <http://www.digico.biz>

Manual Issue and Date: Issue I – November 2019 – For Version 2.5

Licence Agreement

"Product": S-Series software product produced by Digico UK Ltd intended for use on Target Platform identified below.
"Target Platform": Digico S-Series Digital Console systems.

In return for the payment of the one-time fee, the Customer (identified at the end of this Agreement) receives from Digico UK Ltd a licence to use the Product subject to the following terms and conditions.

1. The Product may be used without time limit by the Customer on the Target Platform.
2. The Customer must register the Product with Digico UK Ltd. Registering the Product is deemed an acceptance of the terms and conditions in this agreement.
3. The Product and its licence are not transferable, and the Customer is not permitted to onward-license to any third party. The Customer indemnifies Digico UK Ltd against any and all claims and actions arising from third party use of copies of the Product made by the Customer.
4. The Customer agrees not to attempt to decompile the object code of the Product otherwise than in circumstances specifically provided for by law, and then only after consultation with Digico UK Ltd.
5. The Customer agrees not to use, or licence the Product for use, with equipment other than the Target Platform.
6. The Customer agrees not to modify the Product without the prior written consent of Digico UK Ltd.
7. This Agreement applies to any enhancement or upgrades that may become available for the Product.
8. This Agreement does not transfer any right, title, or interest in the Product to Customer except as specifically set forth herein.
9. Digico UK Ltd reserves the right to terminate this Agreement upon breach, in which event Customer shall thereafter only be authorised to use the Product to the extent that its contractual commitments to third parties require and then only where such commitments relate to use of the Product as authorised in the foregoing provisions of the Agreement.

LIMITED WARRANTY - Digico UK Ltd warrants for a period of 1 year from the date of purchase of the Product, the Product will reasonably execute its programming instructions when properly installed on the Target Platform. In the event that this Product fails to execute its programming instructions during the warranty period, the Customer's remedy shall be to return the Product to Digico UK Ltd for replacement or repair at Digico UK Ltd option. Digico UK Ltd makes no other express warranty, whether written or oral with respect of this Product.

LIMITATION OF LIABILITY - Except as otherwise expressly provided by law, (a) the remedies provided above are the Customer's sole and exclusive remedies and (b) Digico UK Ltd shall not be liable for any direct, indirect, special, incidental, or consequential damages (including lost profit whether based on warranty, contract, tort, or any other legal theory.)
This agreement is made under the Laws of England.

LICENCE NO:

REGISTRATION DATE:

Contents

1.1	The Console.....	1
1.2	Before You Start.....	2
1.2.1	Worksurface Layout	2
1.2.2	Layers and Banks.....	3
1.2.3	Using the Control Surface.....	3
1.2.4	The Selected Channel	4
1.2.5	The Under Screen Controls	5
1.3	The Expanded Views	6
1.3.1	Display Expanded Views.....	6
1.3.2	Channel Setup View	7
1.3.3	Copy Channel	9
1.3.4	Presets	10
1.3.5	Channel Ganging	11
1.3.6	Recording & Virtual Soundcheck.....	13
1.3.7	Group and Aux Setup View.....	14
1.3.8	Aux Sends View.....	16
1.3.9	Input Routing View.....	17
1.3.10	EQ View	19
1.3.11	Dynamics 1 View	21
1.3.12	Dynamics 2 View	22
1.3.13	Control Group Setup	23
1.3.14	Solo Channel Setup	26
1.4	Customising the Layout.....	27
1.4.1	The Console Overview	27
1.4.2	The Spill Set.....	27
1.4.3	Swap Banks	28
1.4.4	Set Master.....	28
1.4.5	Add/Delete Banks	29
1.5	The Main Menu.....	30
1.5.1	Session Management	30
1.5.2	Snapshots.....	32
1.5.3	Fader Crossfades	37
1.5.4	Preferences	38
1.5.5	UI Preferences.....	39

1.5.6	Solo Preferences	40
1.5.7	Workspace Preferences	40
1.5.8	Audio Sync	41
1.5.9	Macros	41
1.5.10	Presets	42
1.5.11	FX Rack.....	43
1.5.12	Graphic EQs.....	45
1.5.13	Send & Return Insert Routing	47
1.5.14	Matrix	47
1.5.15	AMM.....	48
1.5.16	System	50
1.5.17	Diagnostics.....	52
1.5.18	Extensions.....	52
1.5.19	Restart or Shutdown	55
1.5.20	Upgrading Software	55
1.6	DMI Cards	56
1.6.1	Fitting DMI Cards.....	56
1.7	DMI-MADI Cards	57
1.7.1	Connecting DMI-MADI	57
1.7.2	Sharing Racks with DMI-MADI.....	60
1.7.3	Auto-Discovery of DMI Cards & Racks	62
1.7.4	DiGiRack Compatibility.....	64
1.7.5	DMI Card Details & Upgrade.....	65
1.8	DMI - Dante Cards	66
1.9	DMI - ADC - DAC - MIC - AES Cards	68
1.10	DMI - Waves - Hydra Cards	69
1.11	DMI - ME - A3232 Cards	70

1.1 The Console

The DiGiCo S21 and S31 consoles each consist of a worksurface, an audio engine and a range of onboard inputs and outputs. They can be connected using optional DiGiCo DMI Cards to a variety of DiGiCo racks and other audio input/output devices.

The console worksurface consists of 2 (S21) or 3 (S31) sections that can be configured to control up to 48 mono or stereo input channels, 10 VCAs, 16 mono or stereo busses plus a Master buss and a 10 Input x 8 Output Matrix.

The left and right sections (and the middle section if using an S31) have 10 assignable faders and 10 sets of assignable on-screen channel controls, the right hand section also has a dedicated Master fader and mute, a Master/Solo meter, a set of 6 assignable encoder/switches and worksurface navigation controls

The console's buss architecture is dynamic and can support mono and stereo configurations.

Multiple console setups can provide:

Front of House and Monitoring with shared stage racks and gain tracking.



S21 (above) and S31 (below)

NOTE: The S21 and S31 offer the same channel counts, buss counts and processing as each other. The only difference between the two consoles is the number of worksurface sections and the placement of banks on a default session. In this manual, all screenshots are taken from an S21 console. S31 and S21 sessions are interchangeable provided that the software version used on the console is not earlier than the software version that the session was created in. There is no backward compatibility of sessions.

1.2 Before You Start

There are certain general operating principles and terms that should be understood before continuing to use this manual. Please read this chapter carefully before proceeding.

IMPORTANT NOTES:

S-Series v2.5 software is not compatible with any sessions created in preliminary (pre v1.0) versions of software.

It is compatible with all sessions created in v1.0 onwards.

Please delete old sessions (pre 1.0) to avoid potential issues and create a "New" session in v2.5.

The console power switch is situated on the rear panel.

Please ensure that any required DiGiCo I/O racks are connected to the console DMI cards and powered on before starting the console itself to enable automatic discovery of the racks.

If using the inbuilt UB MADI interface with a computer running MacOS Catalina, use the Core Audio driver and not the UB MADI driver.

DMI cards are NOT "Hot swappable" so please ensure that the console is powered off before inserting or removing them.

We recommend that the first snapshot is used as a "Setup" Snapshot where all of your "session wide" settings like routing, Control Group membership and Buss Modes (whether Busses are Groups or Auxes) are first stored.

Because these types of setting can be changed with Snapshot recall, it is advisable to save them all into this first snapshot before creating any further Snapshots. In this way, the settings for all subsequent Snapshots will contain the same data and there should be less requirement to adjust the Safe settings in the channels.

1.2.1 Worksurface Layout

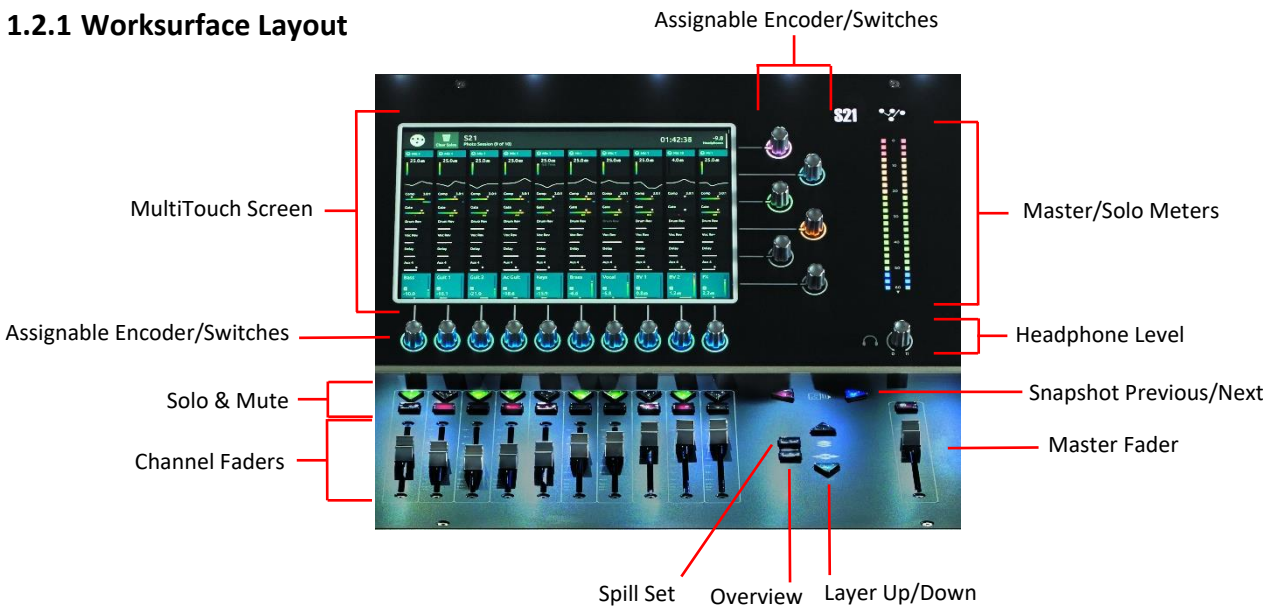

Rear Panel

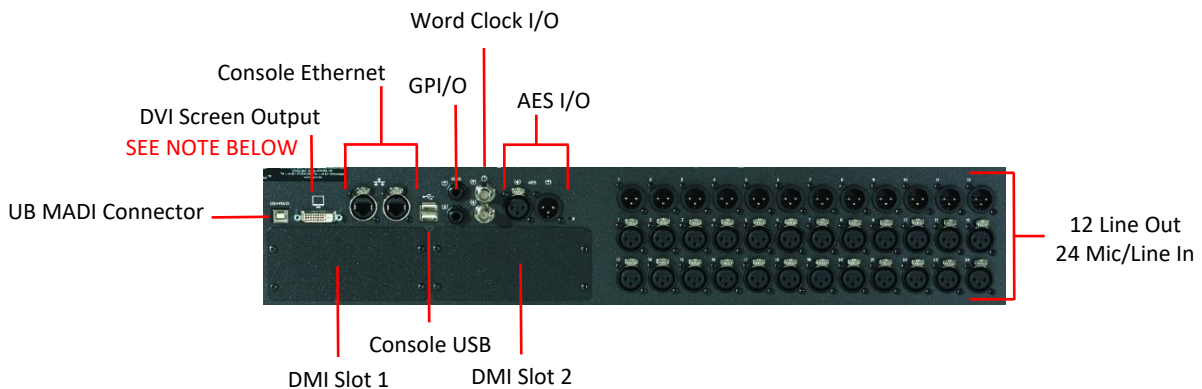

IMPORTANT NOTE: The DVI Screen output will display a copy of the Master (right hand) screen but this must be connected to the HDMI input of a suitable monitor using a standard DVI to HDMI adaptor (not supplied).

IMPORTANT NOTE: The GPI/O functionality is not yet implemented in v2.5.

1.2.2 Layers and Banks

The S-Series worksurface is divided into Layers and Banks. Each Layer contains 2 (S21) or 3 (S31) Banks of 10 channels, and the layer which is currently active on the control surface is selected using the **layer up and down** buttons next to the Master fader. The **right hand screen** is referred to as the **Master Screen** and this is where the various expanded views of elements such as EQ and Dynamics are displayed.

Pressing the white **Overview** button, located near the **layer up and down** buttons displays an on screen representation of all console channels and the active layer can also be selected by touching it on the screen in this mode. The specific channels which are contained within each Bank are defined in the **Overview** display.

By default on an S21, the Input channels will be assigned to Layers 1 and 2 and 3 on the left and right sections of the console. The different output channels will be assigned to Layer 3 and 4. Control Groups will be assigned to Layer 5.

A default session on an S31 will assign the Control Groups, Auxes and Groups to Layers 1, 2 and 3 of the right hand section respectively. The Input channels and the Matrix channels will be assigned to Layers 1, 2 and 3 of the left hand section and the middle section. These bank assignments can be customised by the user and saved in a session at any time.

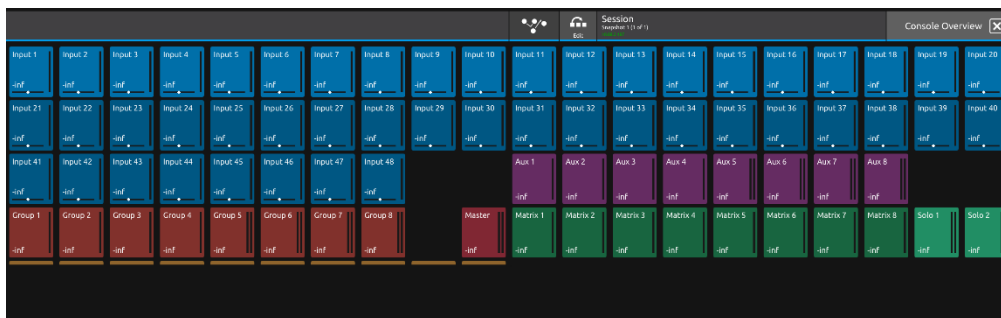

1.2.3 Using the Control Surface

There are two main ways in which all of the functions of the S-Series are accessed:

1. The touchscreen display, which can be controlled directly using a finger
2. The physical encoders, switches and faders

A number of functions can be accessed in different ways, allowing users to operate the console using whichever interface they prefer. All of the physical controls on the console worksurface are described in full within the relevant section of the manual and many require no further introduction.

The right hand Master Screen has a DiGiCo logo icon at the top which is used to access the **Main Menu**.

Main Menu

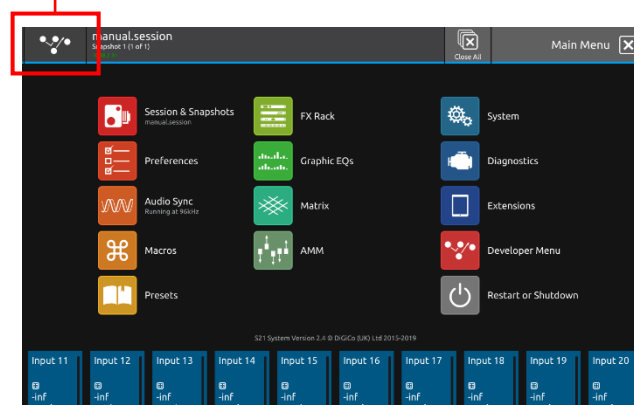

1.2.4 The Selected Channel

One of the channels in the Channel view is displayed with a highlighted background, indicating that it is currently the Selected Channel. This means that it has been assigned to the worksurface controls to the right of the screen as shown in the image below. To assign a channel, touch in the Output Block at the bottom of the onscreen Channel view.



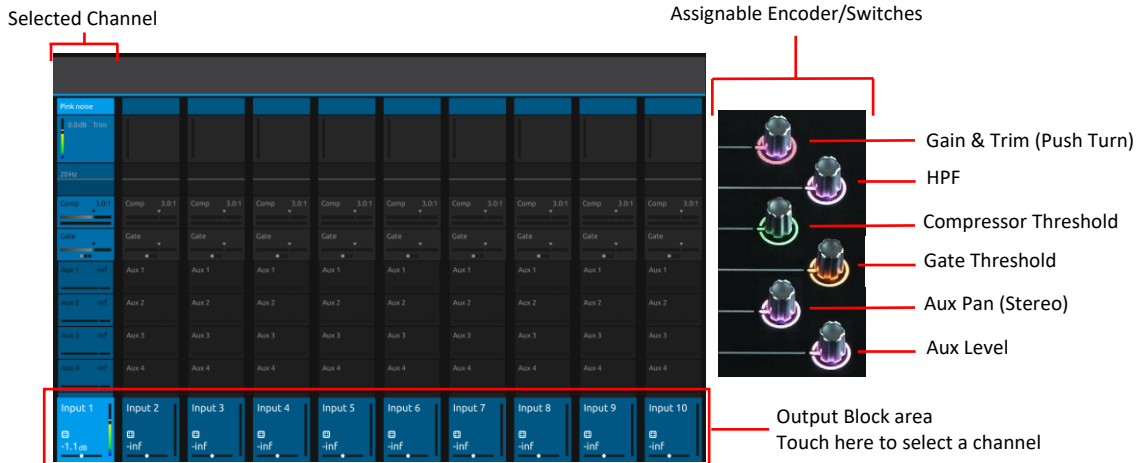









NOTE: All of the master and under screen rotaries are encoders and switches in one unit. Often, different functions can be accessed by a standard turn, a push turn and a push (switch). e.g. Standard turn = Gain control & Push turn = Trim control



NOTE: When the right hand screen is not displaying the Channel view (e.g. it is displaying an EQ view), the master screen worksurface rotaries will not be assigned to the Channel view controls but to the controls for the EQ or other expanded view instead.

The block at the top of each Channel Strip displays information about the processing that has been applied to the channel. This box displays the **Gain**, **Trim** and **Delay** that has been added to the channel. There are also a number of symbols that can be seen along the Channel Strip which represent settings on the channel.

Their meanings are as follows:

-  Insert A
-  Insert B
-  Listening To Copied Audio
-  Phantom power
-  Inverse Input Polarity
-  Gain tracking
-  Pad
-  DiGiTube
-  EQ<>Dyn Swap
-  Dynamic EQ
-  The channel is assigned to at least one Group
-  The channel is a member of at least one Control Group

1.2.5 The Under Screen Controls

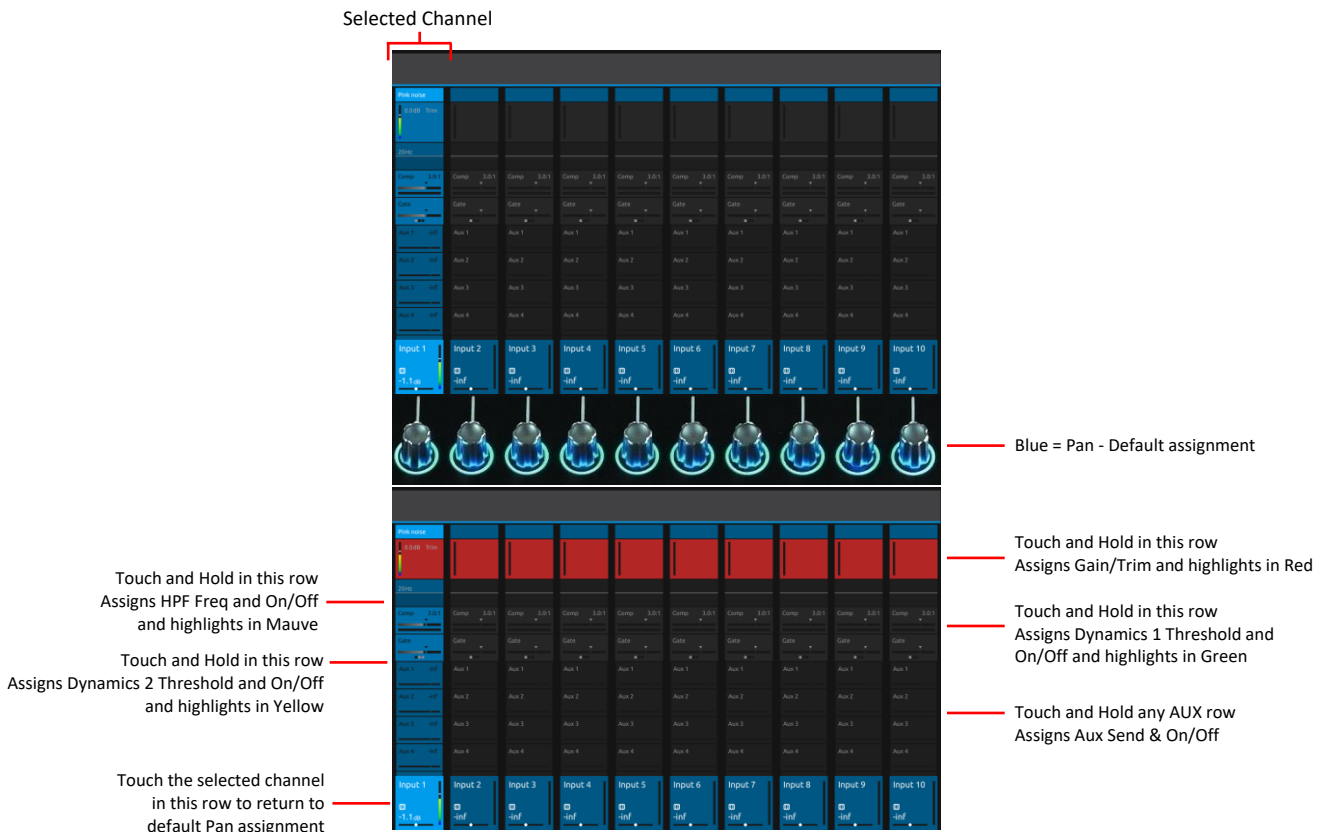

There is a row of 10 encoder/switches immediately below each touchscreen (shown above) that refer to the channels with which they are aligned.

These controls give access to the channel pans in standard operation and the surrounding coloured LED rings are blue. Touching and holding on the rows of controls onscreen assign these encoders to different parameters, the screen row changes colour and the LED rings change to a similar colour.

In the above example the Gain/Trim row at the top of the Channel View has been touched, the row is highlighted in red and the under screen controls are assigned to the Gain/Trim function.

Other possible assignments are:

- HPF Frequency & On/Off - Row and LED ring highlighted in Mauve
- Dynamics 1 Threshold & On/Off - Row and LED ring highlighted in Green
- Dynamics 2 Threshold & On/Off - Row and LED ring highlighted in Yellow
- Selected Aux row Send level & On/Off - Row and LED ring highlighted in Purple
- AMM Weightings - Row and LED ring highlighted in Pale Green

1.3 The Expanded Views

1.3.1 Display Expanded Views

A single touch (rather than a touch and hold) will open a number of different expanded views according to where the touch is made.

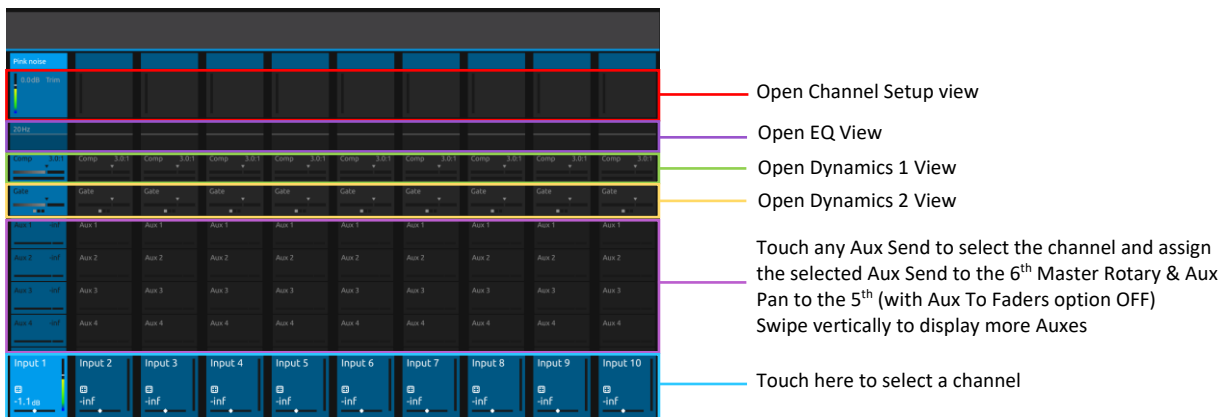

The image above shows the various touch areas in the Channel view and the expanded view will be displayed on the Master screen.

NOTE: When an expanded view is already open, selecting a different channel by touching the Output block area at the bottom of the screen will change the expanded view to display the newly selected channel.

If an expanded view is already open and a different expanded view is selected, the last view selected will be displayed on the Master screen with the previously expanded view behind it.

Any combination of expanded views can be "layered" in this way.

The **Close All** button on the Master screen can be touched at any time to close all active expanded views.

The **Close** button on the Master screen can be touched at any time to close the currently active expanded view and display the view beneath it.

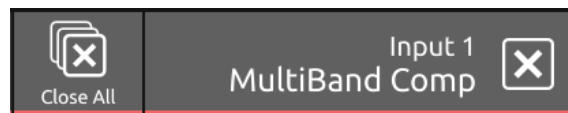

1.3.2 Channel Setup View

Touching the input block at the top of the channel opens the Channel Setup view.

Each column represents a section of the channel processing strip and contains blocks which can be selected by touching them.

On screen arrows indicate the **signal path** from one section of processing to the next.

Once a block is selected, the display changes accordingly and the parameters available in that section are assigned to the worksurface. Master Rotaries to the right of the screen.

Note that touching the Filter block or the EQ block will both display the EQ view but with different bands selected.

NOTE: When any expanded view is open on the Master screen, the Master Rotaries no longer have their standard default assignment and are instead assigned to the parameters in the expanded view which is currently displayed.

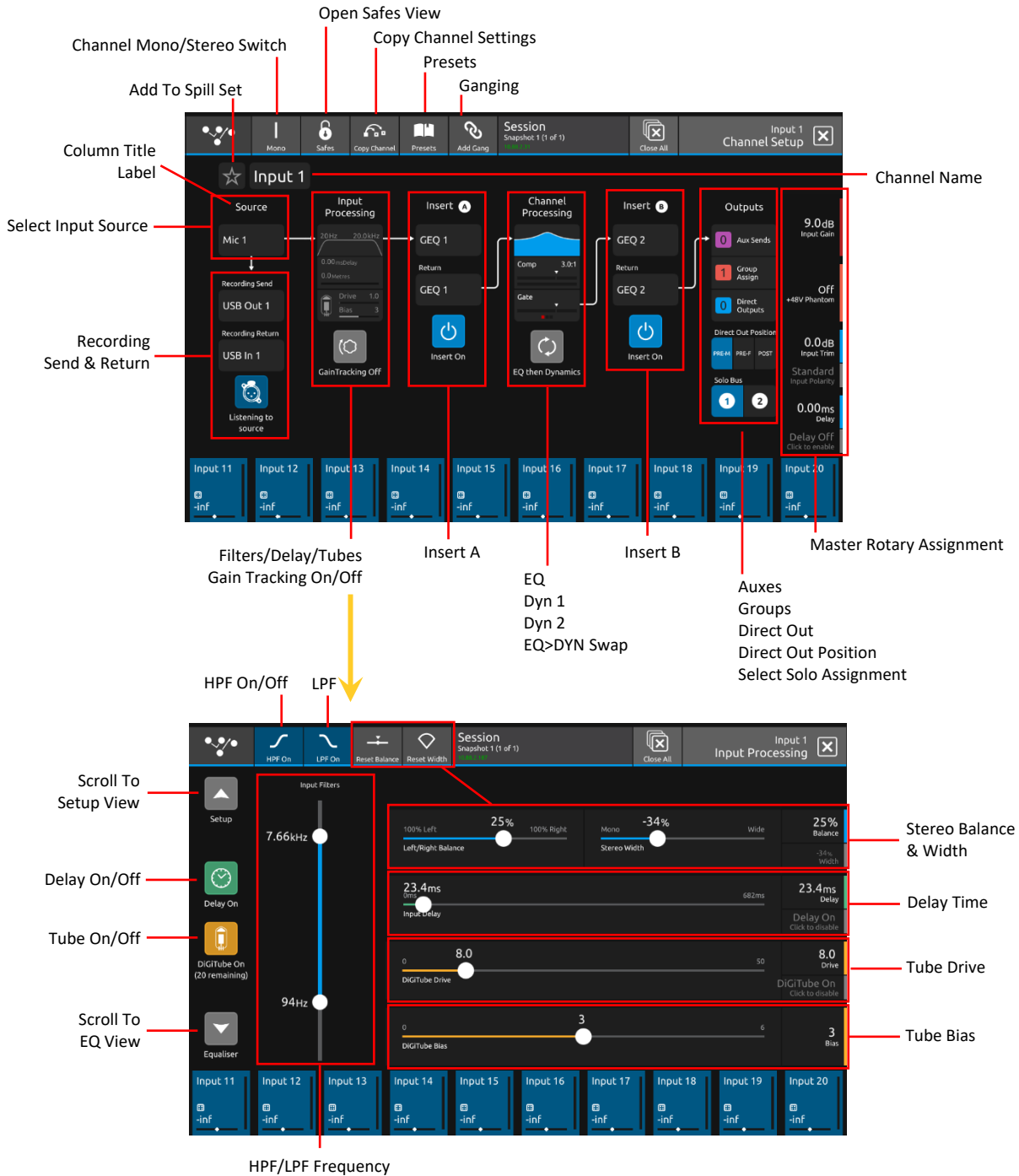

Channel Names can be changed by touching on the existing Channel Name to open the **Rename View** and then using the **Left/Right scroll** buttons to move through channels without closing the Rename View.

Touching the **Star** icon next to the channel name will add the selected channel to the **Spill Set** (see Spill Set section later in this document).

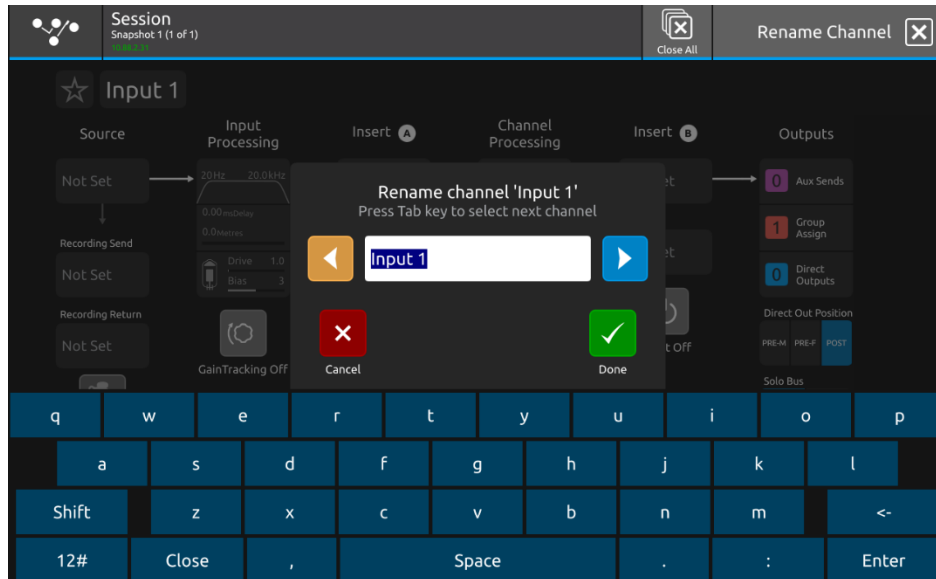

The buttons in the top bar provide the following functions:

Switching the channel from **Mono to Stereo mode**

Opening the **Safes View** which allows channel parameters to be protected from Snapshot Recall

Opening the **Channel Copy** view

Opening the **Presets** view where a preset can either be saved or recalled

Opening the **Gang Setup** view

Channel Delay, Tube, Filter and **Stereo Width/Balance** (Stereo Input channels only) settings are adjusted by touching in the **Input Processing** column. This will open an **Input Processing View**.

At the bottom of the input processing column is a switch to turn **Gain Tracking On/Off** for the channel.

Touch the **Equaliser** button at the bottom left of the screen to switch to the EQ view for the currently selected channel.

To select an **Input Route** touch the block below the **Source** label and the Input routing view will open.

To select an **Output Route** touch the **Direct Output** block in the **Outputs** column and the output routing view will open.

The **Direct Out Position** can be set to either pre-mute, pre-fader or post-fader.

To assign the channel to a **Group buss** touch the **Group Assigns** button in the **Outputs** column.

To view and adjust **Aux Send Options** for the channel touch the relevant **Aux Sends** button in the **Outputs** column.

To select which **Solo Busses** the channel is assigned to touch the Solo 1, Solo 2 or both Solo 1&2 buttons at the bottom of the **Outputs** column.

The default processing order of EQ > Dynamics can be swapped to Dynamics > EQ independently in any channel using the **EQ<>Dyn Swap** button at the bottom of the Channel processing column.

Direct out Position

The direct out send can be sent from one of three positions: pre-mute, pre-fader or post-fader (default) on a per input channel basis. This does not affect the send position to any buses.

The default send position is post-fader and the selected position is not saved in presets.

The position is included in the direct out section of the channel safe.

NOTE: DiGiTubes are limited to 21 per session.

1.3.3 Copy Channel

Multiple settings can be copied from one channel to single or multiple other channels using the Copy Channel button in the Channel setup view.

Open the **Channel Setup** view for the required source channel by touching the top of its channel strip.

Touch the **Copy Channel** button in the top bar.

Touch to select or deselect the parameters that you wish to copy - selected blocks will be highlighted in green.

To select/deselect all of the channel parameters that can be copied touch the **Full Copy** button in the top bar.

Touch the **Copy** button in the bottom right of the screen.

Select the Destination channel(s) by touching them on screen - they will have a white outline.

Touch the **OK** button in the bottom right of the screen.

Copy Channel Function

Source Channel Setup View

Full Copy Option

Green (Selected) parameters will be copied

Copy Button

Select Destination Channels

Confirm Copy

NOTE: Channel Name is not included in the Full Copy selection but can be selected separately if desired.

NOTE: Insert and Output routes cannot be copied as they could cause conflicts with existing routes. Not all parameter types exist for all channel types so some options might be unavailable e.g. Buss mode on an input channel.

1.3.4 Presets

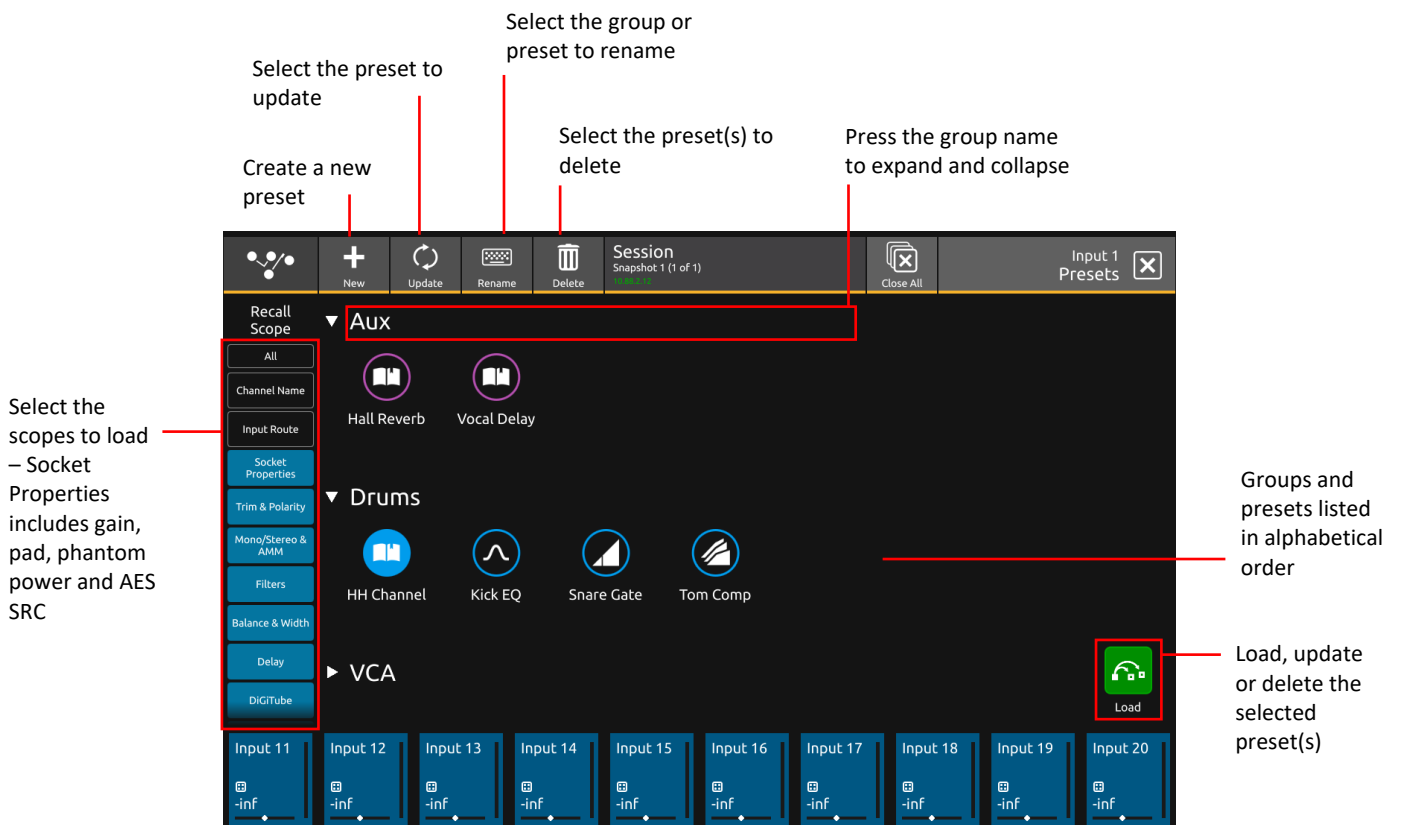

Presets can be used on Input, Group, Aux, Matrix, CG and Master channels. Preset scopes are used to select which parameters are loaded into the selected channel.

New presets can be made by opening the presets view in the desired channel’s setup, EQ, dynamics 1 or dynamics 2 view. In this view, press **New** then enter the preset name and optionally, a group, before confirming. All parameters for that channel are saved into a preset. The view in which the preset was created will determine the preset icon.

Presets are updated and deleted by selecting one of these functions in the top of the presets view, selecting the presets to be updated or deleted, then confirming by pressing the **Update** or **Delete** confirm at the bottom right of the view. To rename a preset or group, select **Rename** then touch on the preset or group which will bring up a rename dialogue.

1.3.5 Channel Ganging

Any channel can be ganged (linked) to one or more other channels (**up to a maximum of 10 channels**) so that changes made on one will also be made to other members of the gang. This excludes Control Group and Solo channel types.

All level parameters that are measured in dBs (e.g. faders) will change relatively so moving a fader on one member of the gang by +3dB will add +3dB to all other members of the gang irrespective of their starting point.

NOTE: Channel Ganging is limited to a selection of up to 10 channels from anywhere on the console. Multiple gangs can be created but a single channel can only be in one gang at one time.

To create a new gang:

- Select the first required member channel of the new gang in the Channel view.
- Touch the top of that channel to open the **Channel Setup View**.
- Touch the **Add Gang** button in the top bar of the **Channel Setup View**.
- Touch the relevant channel blocks in the **Pick Channels View** to select or deselect members.
- Touch the **OK** button to confirm.
- Members will now be displayed with a colour coded line at top of the output block on each gang member.

To edit an existing gang:

- Select any member channel of the existing gang in the Channel view.
- Touch the top of that channel to open the **Channel Setup View**.
- Touch the **Edit Gang** button in the top bar of the **Channel Setup View**.
- Touch the relevant channel blocks in the **Pick Channels View** to select or deselect members.
- Touch the **OK** button to confirm.

Add/Edit Gang



Touch to select members

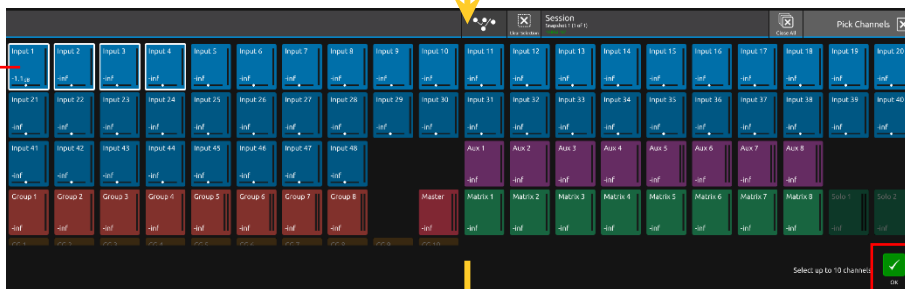

OK to Confirm

Colour coded members
Touch to remove or select new members

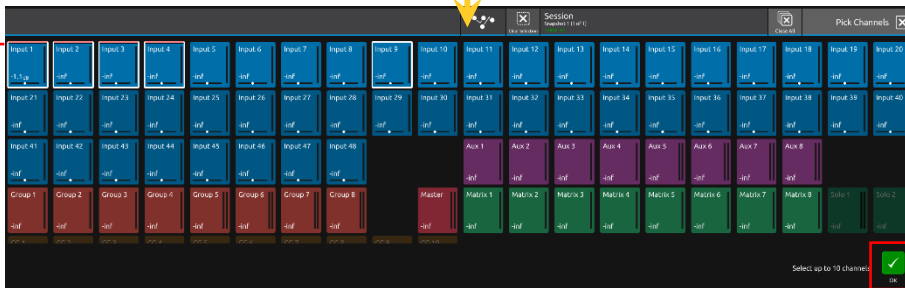

OK to Confirm

Parameters that are included in gangs are a fixed selection of most standard channel functions, but the following elements are among the parameters that are not included:

Routing Input/Output/Insert/Record Send & Return
Mono/Stereo switch
Polarity switch
Analogue socket gain
+48V
Channel & Aux Panning
Parameter Safe Status
CG Membership
Bus Mode
Fader Crossfades
AMM Membership
AMM Weighting

NOTE: Gang membership cannot be changed with snapshots.

NOTE: Gang members cannot be temporarily isolated from a gang - to change the settings in just one channel, first remove it from the gang, make the changes and then add it back to the gang again.

NOTE: If any element of a gang member is "Flattened" this change will only apply that that member and not to any of the other members of the gang.

Also if settings are copied to any member of a gang, the new settings will only be applied to that member of the gang and not to any of the other members of the gang.

1.3.6 Recording & Virtual Soundcheck

Any input channel can be sent from a dedicated pre-processing **Record Send** point in the channel signal path to any valid output socket. Typically a selection of input channel signals would be sent to the console's UB MADI interface for recording on a DAW via a USB connection.

Playback signals from the DAW can then be returned into the dedicated Record Return and switched either individually or globally to replace the standard input signal to that channel. This is known as **Listening to Copied Audio**.

Listen to Sources & Listen to Copied Audio Macros

Record Send and Return Routing

Ripple Route with Send+Return Active

Record Sends to 40 x UB MADI Outputs

Listening To Source

Listening To Copied Audio

To set up a Record Send and Return:

- 1) Touch the top of the first input channel that you wish to record to open the Channel Setup View
- 2) Touch the Recording Send button on the left of the screen to display the Record Send Routing view
- 3) Ensure that the Send+Return mode is active using the button in the top bar
- 4) Select an output to feed the recorder by first selecting a port (e.g. UB MADI) Multiple channel Record Sends can be assigned at the same time using the standard Ripple Route function
- 5) When the Record Send selections have been made, touch the Route button at the bottom right of the screen to confirm.
- 6) Select the Channel Setup View again and you will note that the relevant, same numbered input route for the Record Return has automatically been assigned. So if your Record Send was USB Out 1 then your Record Return will be USB In 1
- 7) The button below the Record Send & Return has 2 states:
 - a) **Listening to Source** - the Record signal is being sent and the channel signal is the original Record Send source
 - b) **Listening to Copied Audio** - The Record signal is being sent and the channel signal is the Record Return from the recording device e.g. Playback signal

NOTE: There are 2 Macros available that allow switching of all console Record Sends from Listen to Sources to Listen to Copied Audio. Using these 2 Macros, the console can be set to monitor record source or record returns globally for all channels that are being recorded.

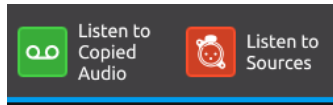

Record Sends and Returns do not have to use the console UB MADI Port, they can use any port or combination of ports in any socket order required. For example, a recording could be made via a DMI-MADI card.

A Record Send can be routed to multiple destinations at the same time, but a Record Return can only be fed from one input socket at one time. This is the input socket that will be used when Listen To Copied Audio is active.

1.3.7 Group and Aux Setup View

The Group and Aux Channel Setup view are very similar to the Input Channel version, but they have one extra function that is used to convert a Group Buss to an Aux Buss or vice versa.

The S-Series consoles have a fixed number of output busses, but they can be changed at any time to be either Auxes or Groups.

In the example below, touching the **Mode** button on the Group Setup view will change the Group to an Aux but there is warning that all channel assignments will be reset in the process. So the newly converted Aux will be flattened.

The situation is exactly the same when converting an Aux to a Group - all assignments are reset.

NOTE: In Aux/Group Buss Mode can be changed with a Snapshot recall which has its own Safe block. Please ensure that the buss modes are set in your first Snapshot before you create any further Snapshots. This will ensure that the buss mode settings will be consistent in all Snapshots.

Change Group to Aux



Warning

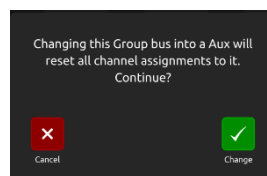

Group To Group Routing

Any mono or stereo Group buss can be assigned to any other buss (including the Master buss) using the **Group Assigns** view on a Group channel.

Touch the top of a Group channel to open the Channel Setup view, touch the Group Assigns button in the Outputs column. In the example below, Group 1 is assigned to the Master buss by touching the Master buss button.

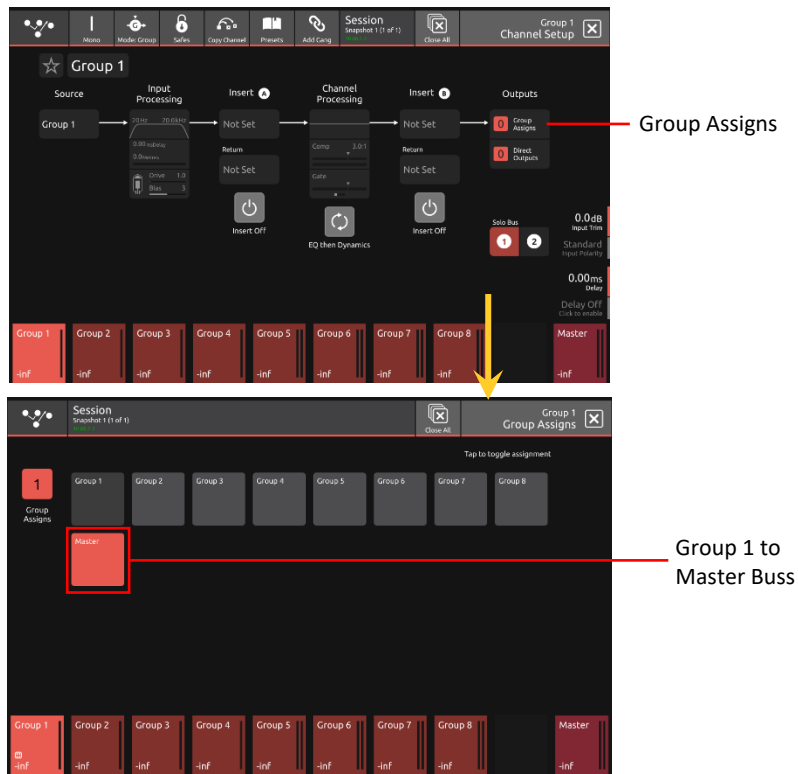

NOTE: A Group cannot be assigned to itself

Aux Send Pre/Post Switches

Any Aux buss can have all of its related sends from all channels set to Pre/Pre-Mute/Post using the buttons in the Aux buss setup view. Touch the top of an Aux channel to open the Channel Setup view and then touch the relevant **Set All Sends To** button on the right of the screen. A warning will be displayed which can be confirmed by touching the **Yes** button.

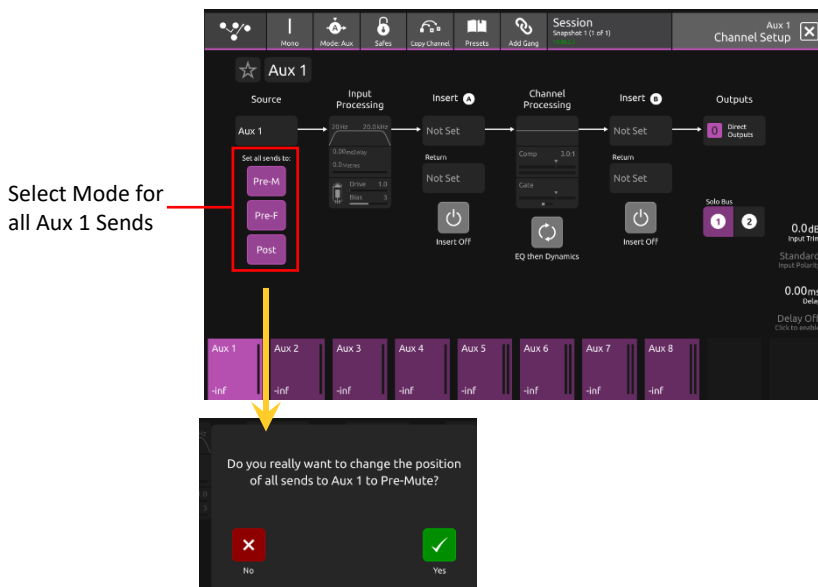

1.3.8 Aux Sends View

The **Aux Sends View** panel displays every aux buss in the current session and touching the buss will activate the buss solo and aux to faders.

It can be accessed from any input channel's setup view by selecting the outputs column and touching the Aux Sends button in the Outputs column or from the **Aux Sends View Macro**.

There are 2 options in the top bar:

- 1) **Solo on select** - with this option active, the relevant Aux Master Solo will be activated
- 2) **Assign on select** - with this option active, the relevant Aux buss sends will be assigned to either the input channel faders or the underscreen rotaries according to the status of the Aux To Faders option in the Worksurface Preferences panel (found in the Preferences Panel)

If **Aux To Faders** is **OFF** the sends are assigned to the underscreen rotaries.

If **Aux To Faders** is **ON** the sends are assigned to the channel faders.

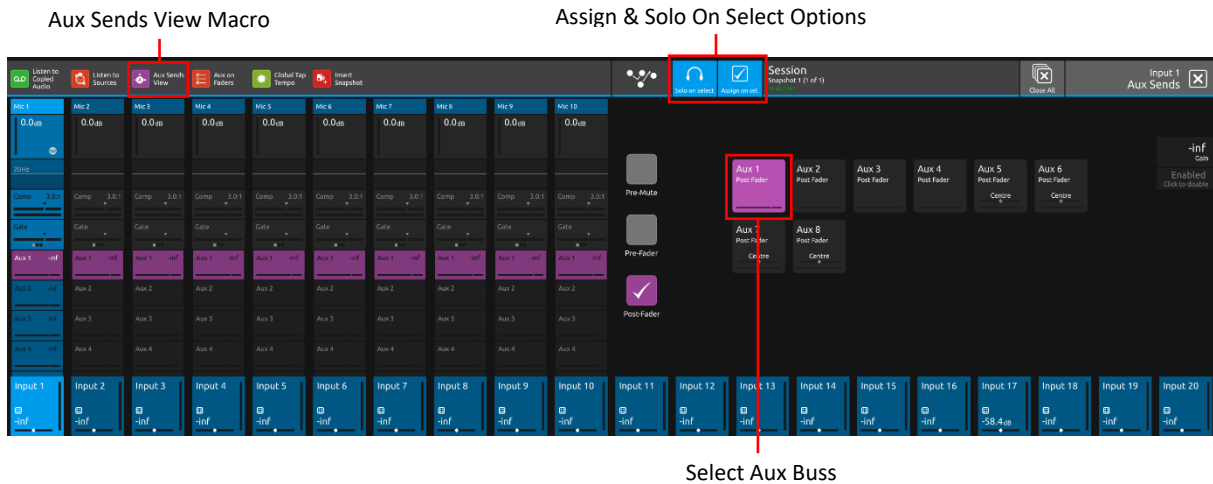

Select Aux Buss

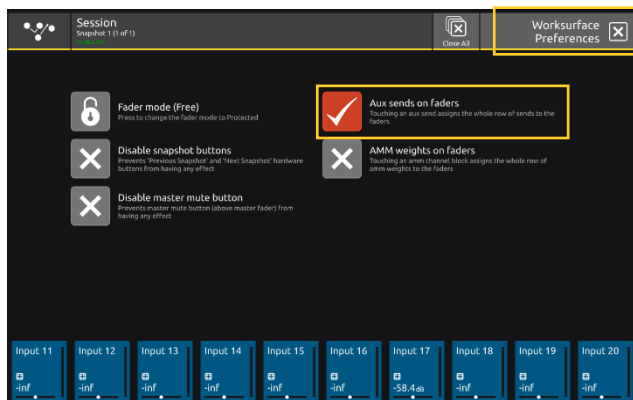

OR

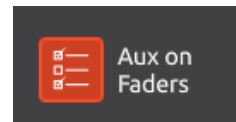

Aux to Faders On/Off Macro

1.3.9 Input Routing View

Touching the **Source** area on the Channel Setup will open the Input Route expanded view.

Only input channels have a **Source** selection - output channels sources are fixed within the system.

To select an input source, touch one of the buttons in the port list on the left of the screen and the relevant sockets will be displayed. Now touch to select a socket in the socket display.

Inputs can be routed into multiple channels at the same time using the **Ripple Route** function.

Touch the Ripple Route button in the top bar and then select the first and last sockets in the required range - then press the **OK** button. The Master Rotaries are assigned to the Gain/Trim, +48V and Input Pad controls if they exist for the socket type selected.

NOTE: Ripple routes are automatically done in the channel display order rather than channel number order.

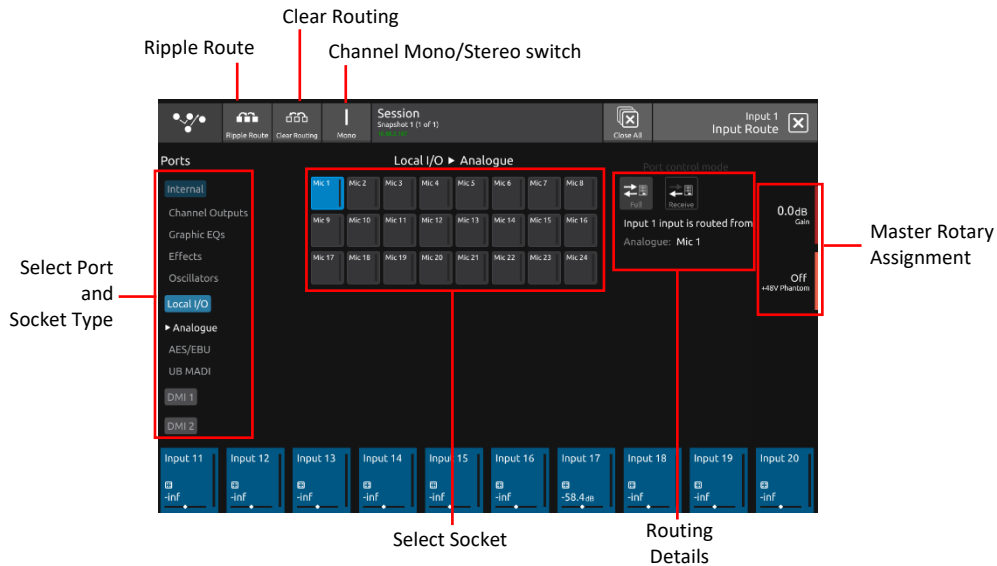

Clear Routing

Multiple consecutive socket routes (inputs or outputs) can be cleared using the **Clear Routing** function.

From any input or output routing view, select the relevant port by touching the port name in the left hand column.

Touch the **Clear Routing** button in the top bar.

Select the first and last sockets in the range that you wish to clear.

Touch the **Clear** button at the bottom right of the panel.

In the example below UB MADI Port - Input Sockets 1-8 will be cleared.

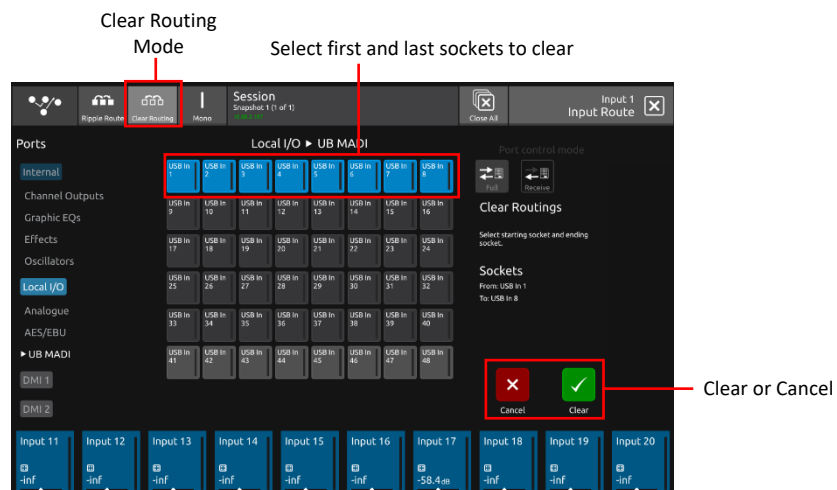

NOTE: Sockets routings are cleared in socket order, not in channel order, so in the above example, the sockets that are cleared may not necessarily belong to adjacent channels. The input routing will be cleared from ANY channel that has these sockets as an input source. This is not a channel Clear Routing function but rather a socket Clear Routing function.

Receive Only Mode

Ports have two different control modes. **Receive Only Mode** prevents the console from changing Gain, Phantom Power and Pad values. **Full Control Mode** allows the console to change these values.

To change the Port Control Mode, in the Input routing view, touch the desired mode to the right of the view.

This can also be done in the Output routing view.

When in Receive Only Mode, Gain values will appear in Orange text on the Channel Strip.

NOTE: This Port Control Mode is controlled on a per rack basis and cannot be changed with snapshots.



1.3.10 EQ View

Touching the EQ area on either the Channel view or the Channel Setup will open the EQ expanded view.

The EQ band can be selected by touching the band icons on the left of the screen or by touching the bands on the EQ graph itself.

The graph has 2 modes, 4 band EQ or filters. Touch the relevant band and the adjust the parameters by dragging the band icon on the graph.

While an EQ band is selected, it can be "pinched" on screen to adjust the Q setting.

The selected band's parameters can also be adjusted with the Master Rotaries to the right of the screen.

The buttons in the top bar provide the following functions:

EQ On/Off

Show Dynamic EQ controls

Copy EQ to another channel(s) - touch the button and select the destination channels from the channel picker - OK to confirm

Presets can be saved or recalled from this view. The recall scope only included EQ when recalling a preset from the EQ view.

Flatten EQ

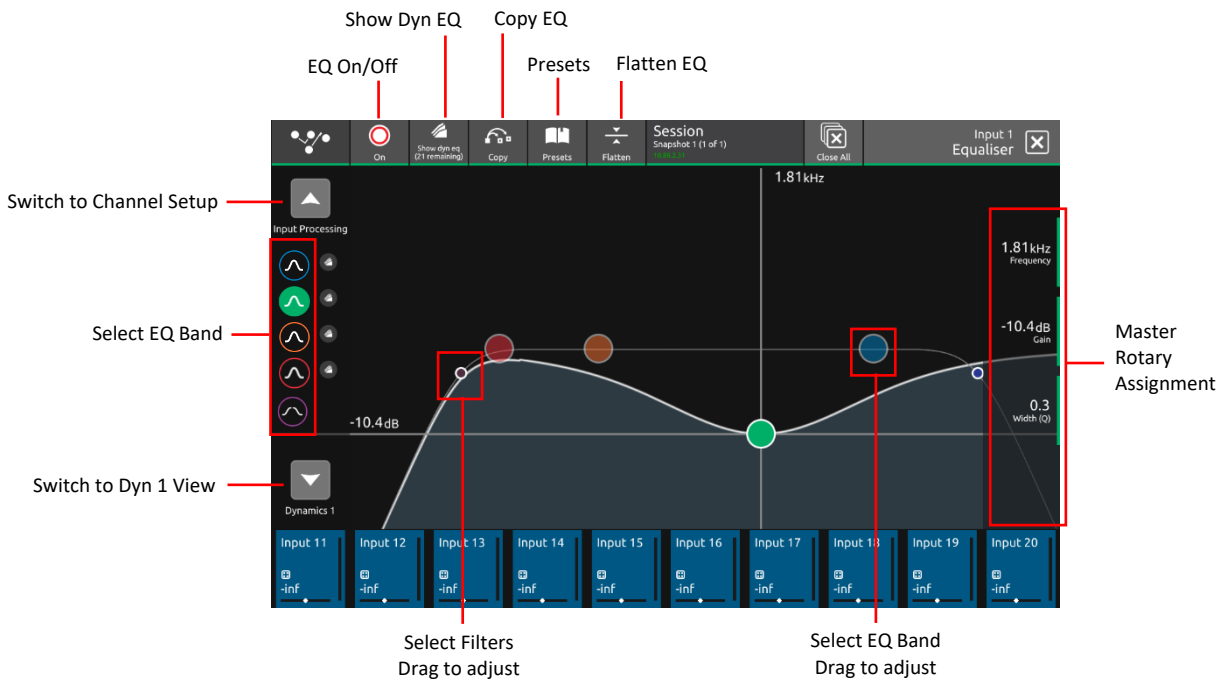

Dynamic EQ

Touching the **Show Dyn EQ** button at the top of a channel's EQ view opens the **Dynamic EQ View**.

Touching it again will hide the Dynamic EQ controls.

Each EQ band can be turned into a Dynamic EQ band by touching the **Dyn EQ On/Off** button at the left of the screen for each band. Bands where Dynamic EQ is active will be shown with the Dynamic EQ symbol in the Band Icon. The corresponding dynamics icon of each band will appear as a solid colour when active.

The parameters of each Dynamic EQ band can be adjusted by dragging the sliders at the bottom of the view or touching a band and using the Master Rotaries.

Each Dynamic EQ band has 2 modes. In **Over Mode**, the EQ adjustment is applied when the level of the incoming signal is over the threshold. **Under Mode** applies the EQ adjustment when the incoming signal is below the threshold. The mode can be changed by selecting the band and using the Master Rotaries. The mode is shown by the direction of the arrow next to the Threshold slider at the bottom of the view.

Next to the slider controls of each band is a **Bipolar Meter**. The level of the meter will rise when the band is being boosted and fall when the band is being attenuated.

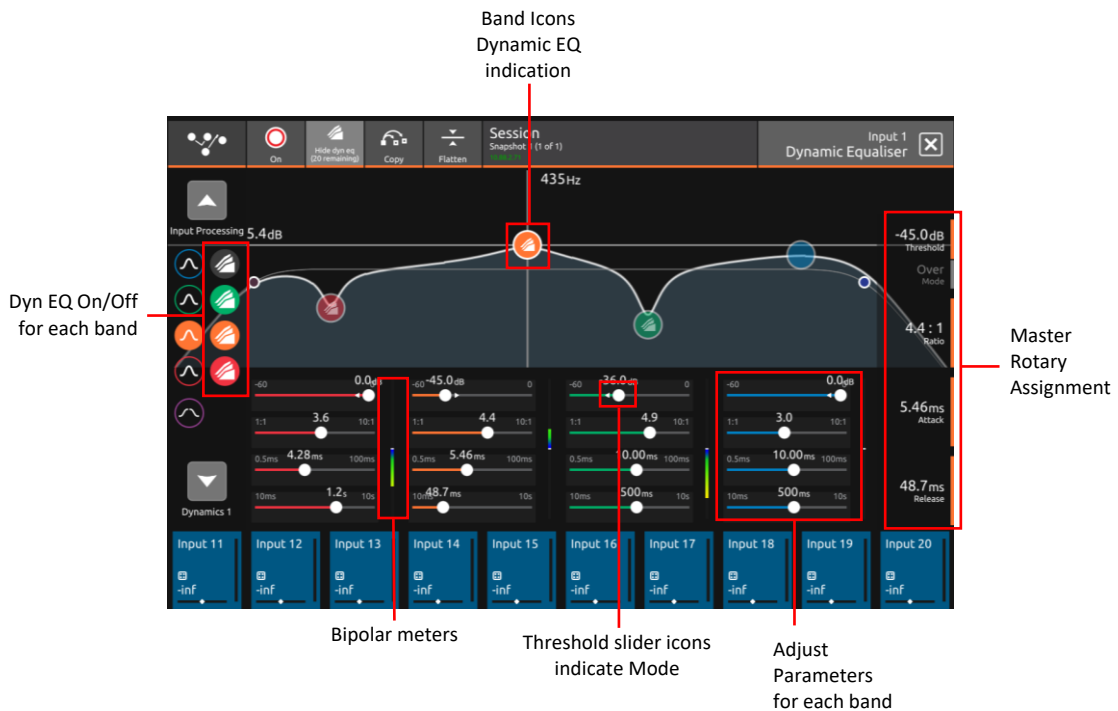

NOTE: Dynamic EQ is limited to 21 per session.

1.3.11 Dynamics 1 View

Touching the Dynamics 1 area on either the Channel view or the Channel Setup will open the Dynamics 1 expanded view. Dynamics 1 can be a Single Band or Multiband Compressor (on 21 channels). Touch the **Mode** button in the top bar to switch modes. Multiband Dynamics has **4 viewing modes**, one for each individual band and one that displays all 3 bands at the same time. These are selected with the buttons on the left of the screen.

Parameters can be adjusted on-screen or using the Master Rotaries to the right of the screen.

The buttons in the top bar also provide the following functions:

Dynamics Module On/Off

Copy Dynamics settings to another channel(s) - touch the button and select the destination channels from the channel picker - OK to confirm

Reset Dynamics module

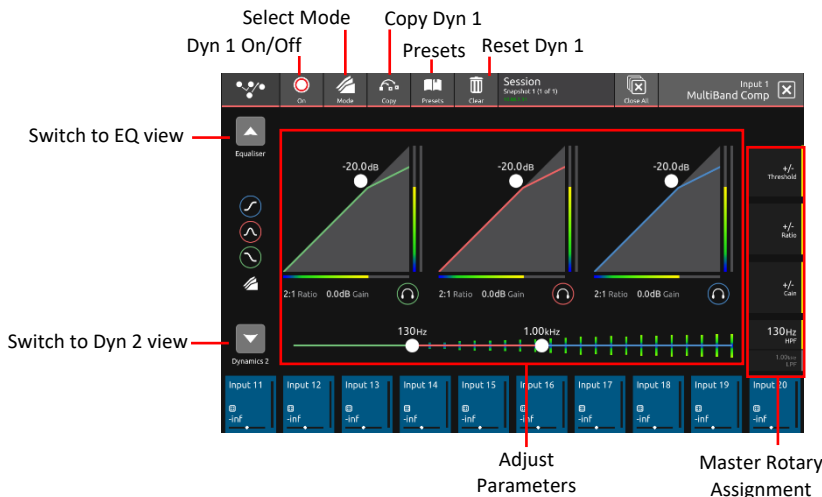
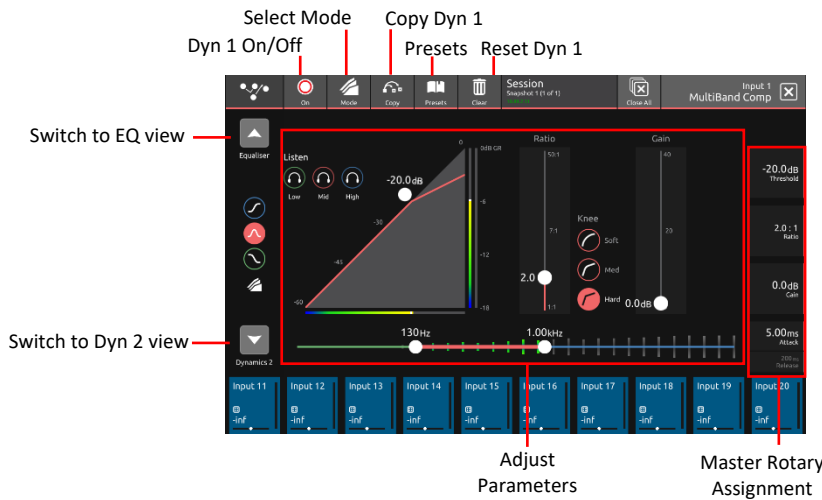
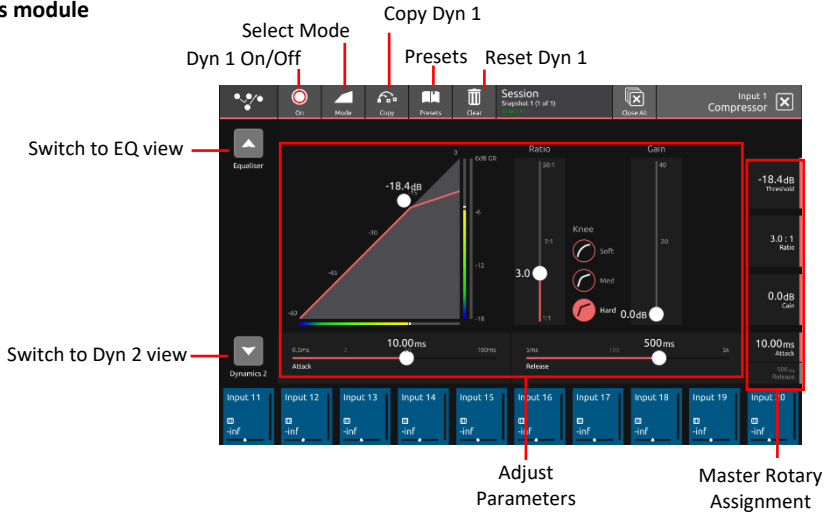

NOTE: Multiband Compressors are limited to 21 per session.

1.3.12 Dynamics 2 View

Touching the Dynamics 2 area on either the Channel view or the Channel Setup will open the Dynamics 2 expanded view.

Dynamics 2 can be a Keyed Gate, a Ducker or Single Band Compressor with Side Chain.

Touch the **Mode** button in the top bar to switch modes.

Dynamics module 2 provides side chain access via a selectable input - this can be used for external triggering.

Select the Source signal by touching the **Key/Side Chain** input button on the left of the screen and select a source from the standard input routing list. Then use the **Self/Ext** button to activate this function.

Parameters can be adjusted on-screen or using the Master Rotaries to the right of the screen.

The buttons in the top bar also provide the following functions:

Dynamics Module On/Off

Copy Dynamics settings to another channel(s) - touch the button and select the destination channels from the channel picker - OK to confirm

Reset Dynamics module

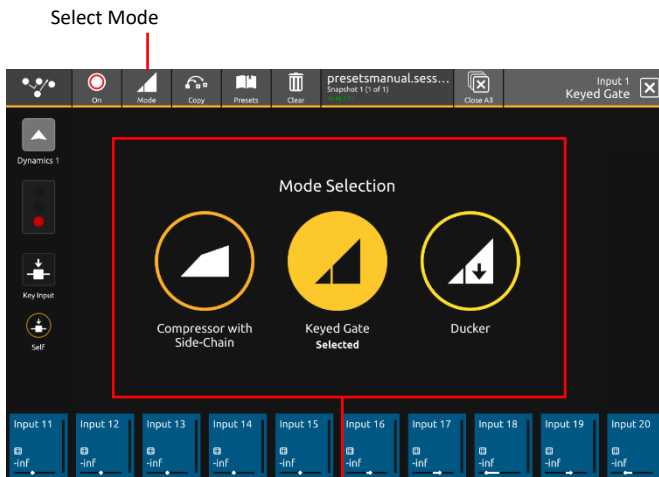
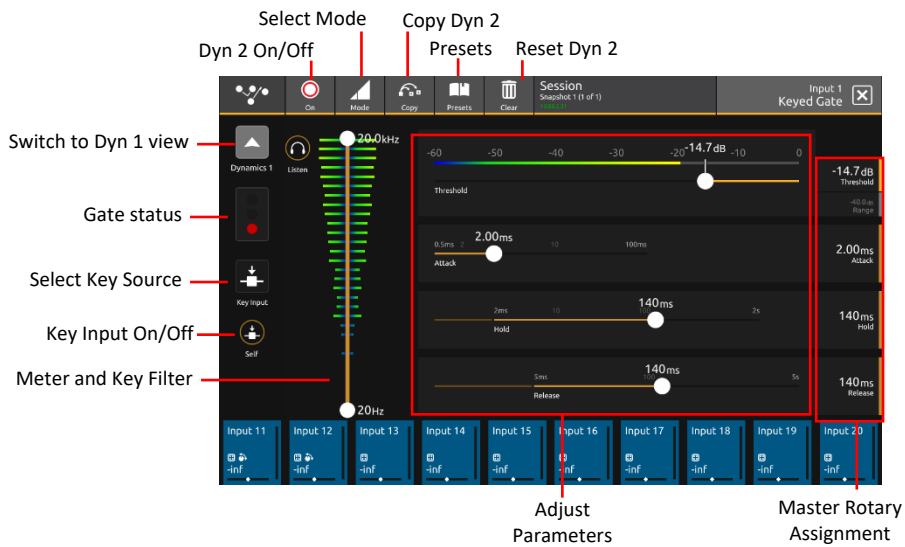

1.3.13 Control Group Setup

To create a Control Group, touch the top of a **Control Group Channel** to open the CG Setup view.
 Touch the **Edit** button in the top bar and then touch the **Members** button from the drop down menu.
 Select the required CG members by touching them in the **Channel Picker** and touch the **OK** button.
 The CG members can also be changed by double tapping on the centre section of the Control Group Channel.
 The CG Setup view will now show blocks representing each of the CG members and the CG channel will display a list of its members with their fader levels.

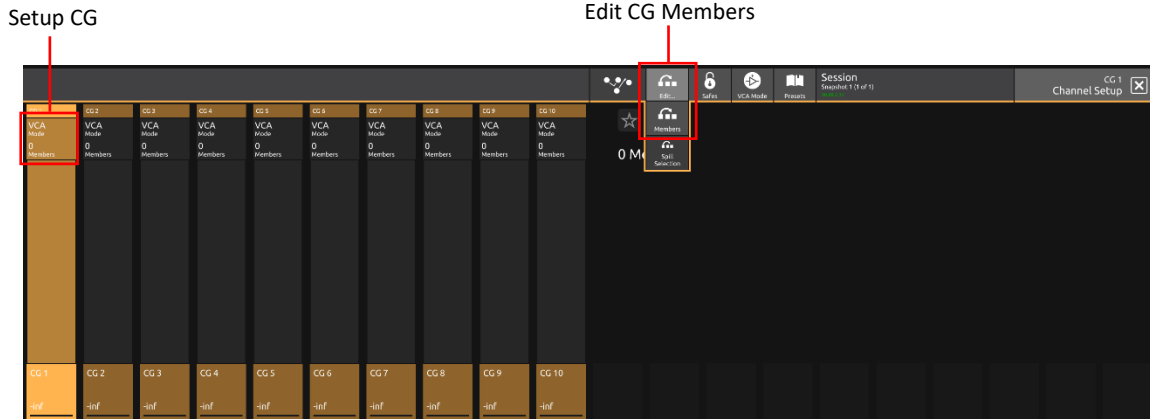

Touch to select members

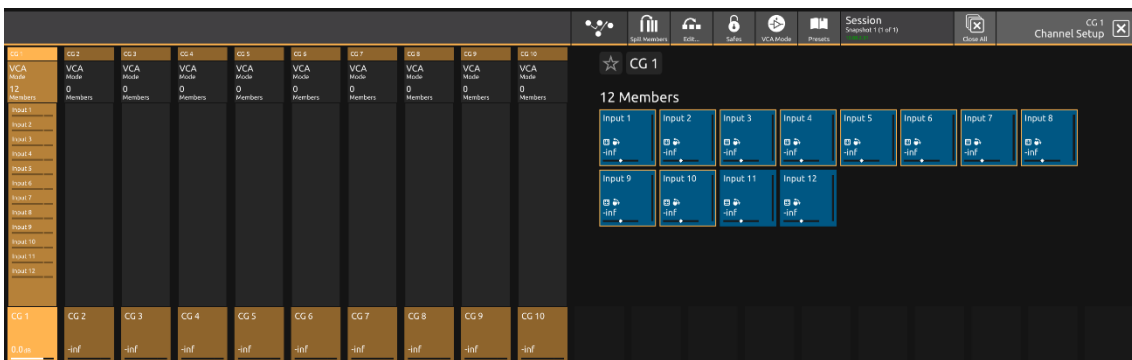

Control Group Spill

Up to 10 members of a Control Group can be spilled onto a preselected screen.
 Touch the **Edit** button in the top bar and then touch the **Spill Selection** button from the drop down menu.
 Select the channels to add to the CG Spill by touching them. Channels in the Control Group Spill are shown with an orange outline. The order of channels can also be changed by dragging the Channel boxes.
 Touching the **Edit** button again will exit Edit mode.
 The **Control Group Spill Screen** can be changed in the Preferences menu.

A Control Group can be spilled in 4 different ways:

- Touching the **Spill Members** button at the top of the CG Channel Setup view.
- Holding the centre section of the Control Group Channel.
- A **Spill Macro** exists for each Control Group.

The **Solo** button of the Control Group can be repurposed in the **Solo Preferences** menu to open the Spill.

A Control Group Spill can be closed in 4 different ways:

Touching the **Close Spill** button at the top of the Master screen.

Holding the centre section of the Control Group Channel.

Touching the **Close Spill Macro** (the Spill Macro will change to a Close Spill macro when the spill is open).

Unsoling the Control Group (if the Control Group Solo button was used to open the spill).

Edit Spill Selection

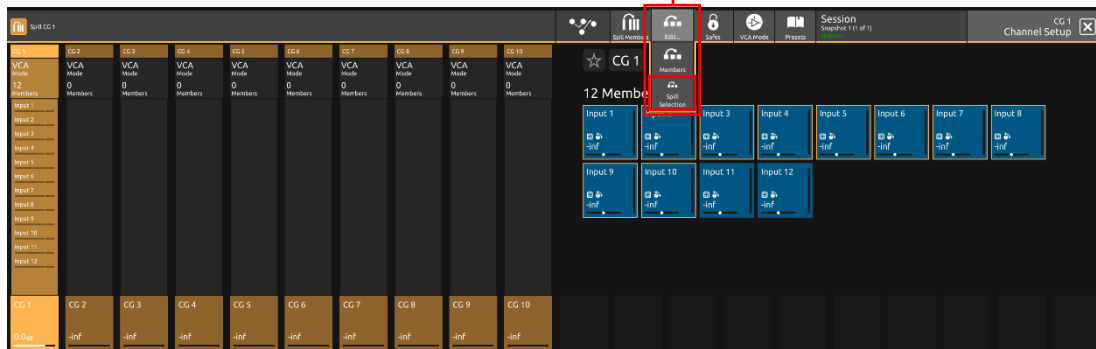

Light grey button to show Edit mode is active

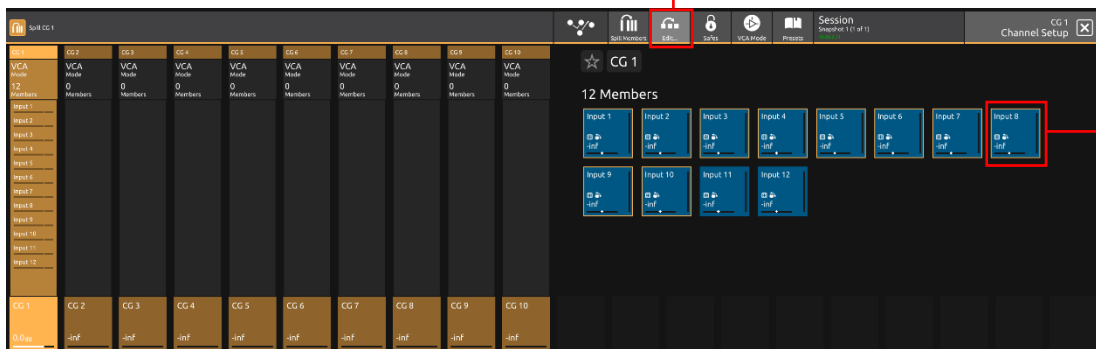

Orange borders to show Spill channels

Spill Control Group Macro

Spill Members button

Hold centre section of channel to spill

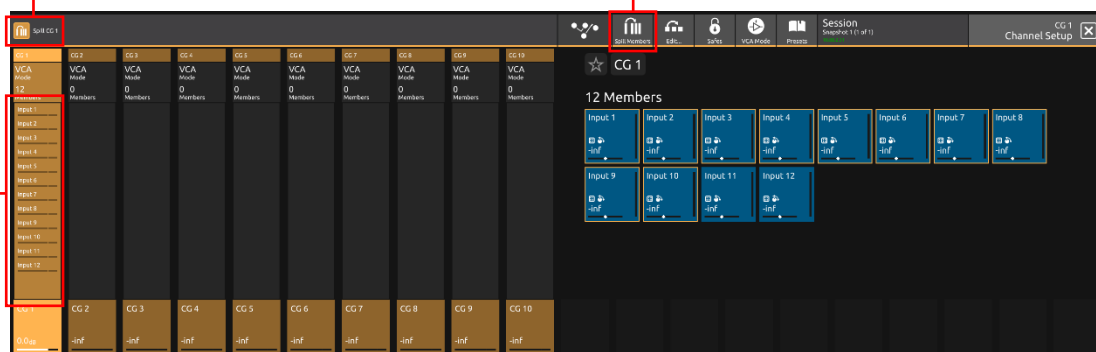

Close Control Group Spill Macro

Close Spill button

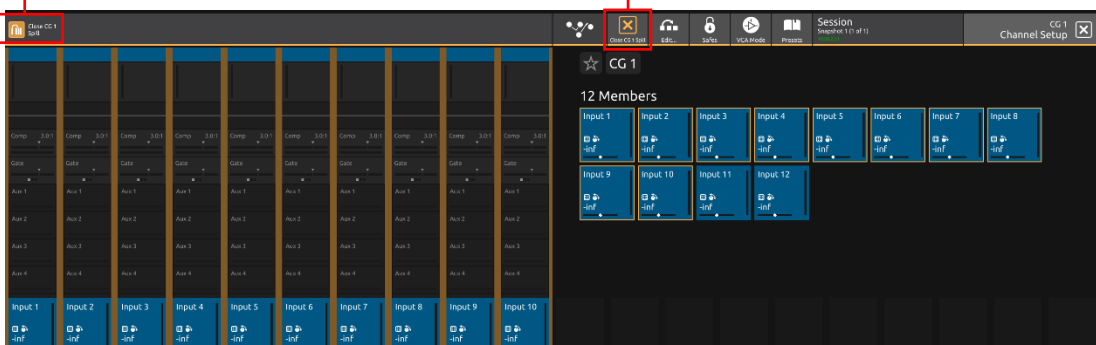

Control Group Modes

Control Groups have 2 modes, **VCA** and **Mute Group** - any CG can be switched to either of these modes.

In VCA Mode, the CG fader and mute will both affect the CG member channels.

In Mute Group Mode, the CG Mute will affect the CG member channels, but the CG fader will have no effect on the member channels.

Macros are provided to adjust CG mutes from the Macro Bar.

To switch CG Mode:

Touch the top of a CG channel to open the CG setup view.

Touch the Mode button in the top bar to switch modes.

NOTE: In Mute Group Mode, if the CG fader is moved, it will return automatically to 0dB.

NOTE: If a CG is switched from VCA Mode to Mute Mode, the faders will be reset to 0dB - an on screen warning will be displayed to indicate that this is going to happen.

CG Mode
Default = VCA
Touch here to switch to Mute Mode

Changing this Control Group to Mute Group mode will set its fader to 0dB. Are you sure you want to change?

Faders will be set to 0dB on switch

Mute Group Mode

CG Mute Macros

CG Spill Macros

1.3.14 Solo Channel Setup

The S-Series consoles have 2 Solo busses which have their own control channels in the console layout normally located on the 4th layer next to the Matrix Output channels.

NOTE: Both Solo busses 1&2 are both sent permanently to the console headphone socket. When no channels are soloed, the Master Bus (No Solo source) will always be sent to Solo Bus 1

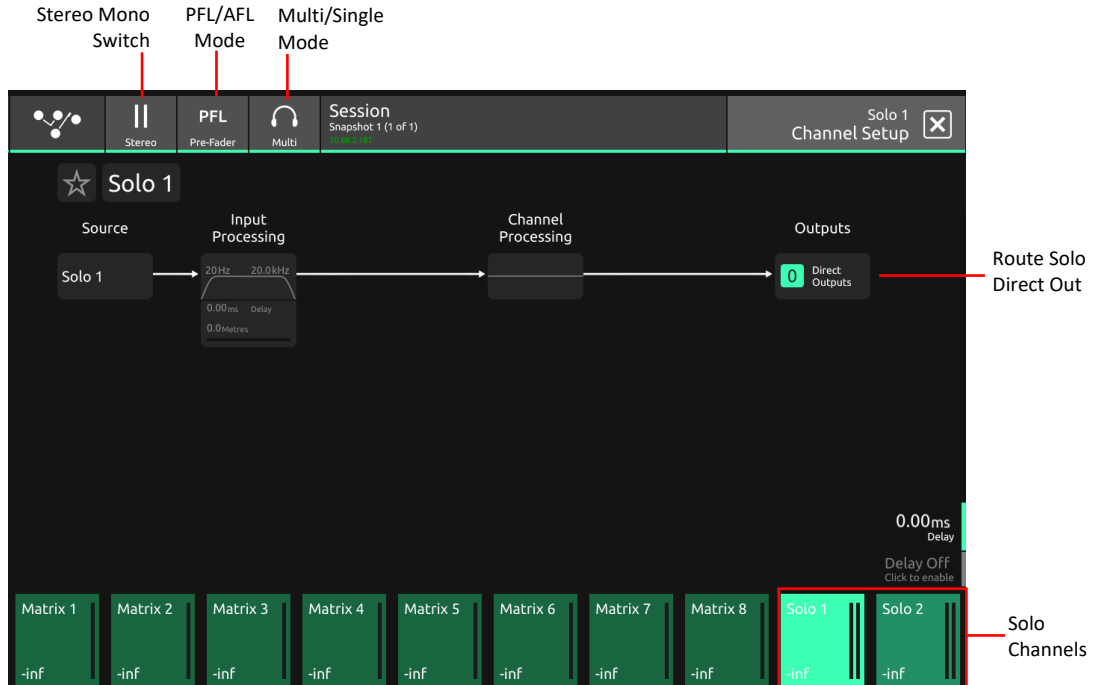

Touching the top of either Solo channel will open the relevant Solo setup view.

Various Solo buss settings can be found in the top bar of this view.

Solo busses can be switched **Mono or Stereo**.

They can be set to **PFL** or **AFL** mode.

They can be set to **Multi Mode** where multiple solos can be switched on at the same time or **Single Mode** where switching one solo on will cancel previously active Solos.

Any channel can be assigned to **Solo Bus 1, 2 or both 1&2**.

Open the channel setup view for any channel and there are Solo Buss Assignment buttons at the bottom of the output column.

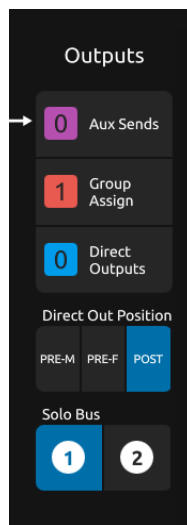

1.4 Customising the Layout

1.4.1 The Console Overview

Pressing the white Overview button, located near the layer up and down buttons displays an on screen representation of all console channels. This view can be used to change the layout of the console channels and banks.

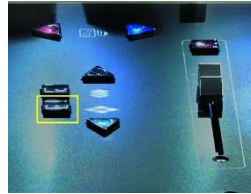

Touching the **Edit** button in the top bar changes the appearance of the display and activates drag and drop capability. Any block that represents a channel can be dragged to another position and dropped there. This will overwrite the channel in that position and the overwritten channel will reappear in the **Unassigned Channels** section at the bottom of the left screen. Channel blocks can also be dragged directly to the Unassigned Channels section to remove them from the workspace.

NOTE: Channel blocks can be dragged between the console screens.

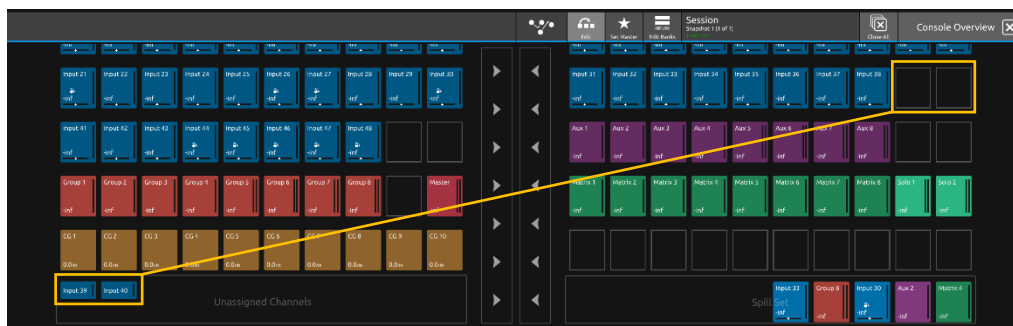

1.4.2 The Spill Set

In Edit mode, a selection of up to 10 channels can be dragged to the Spill Set section at the bottom of the right hand overview screen to create a Spill Set.

Typically, these would be channels to which the user needs to have quick access at all times.

When a Spill Set has been created, the workspace button located above the overview button will become blue and pressing this button will display the Spill Set channels on the right hand screen. pressing again hides the Spill Set.

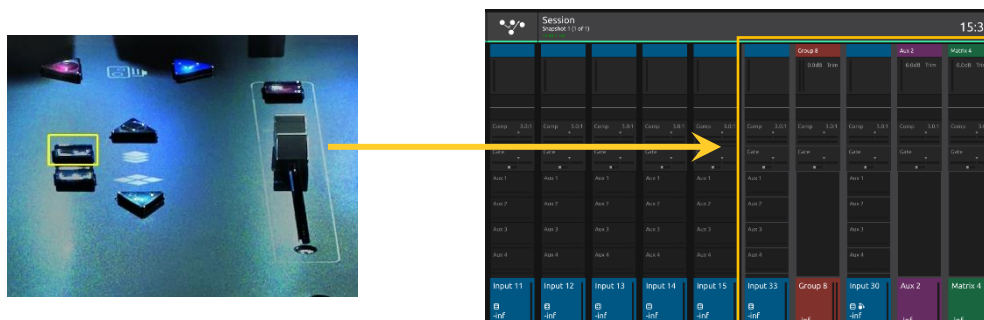
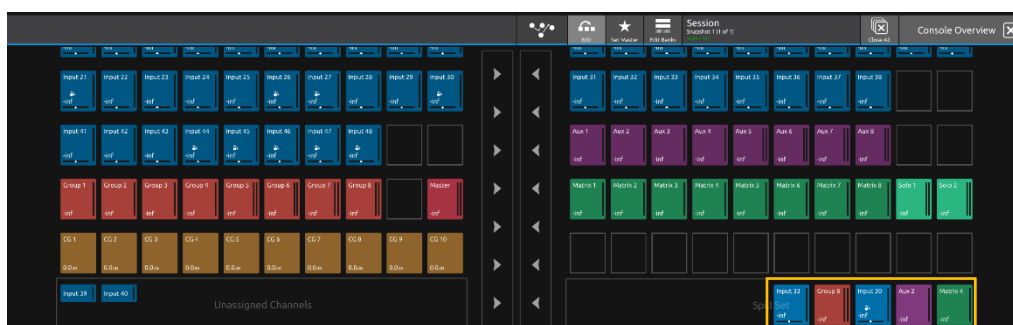

1.4.3 Swap Banks

In Edit mode, touching the Edit Banks and then the Swap Banks button in the top bar allows complete banks to be moved from one position to another either from left to right or from one layer to another.

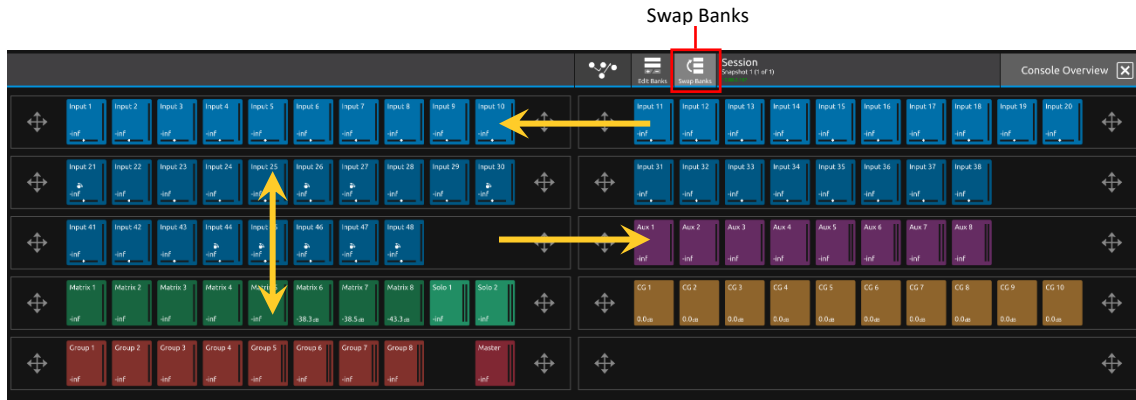

1.4.4 Set Master

In Edit mode, touching the **Set Master** button in the top bar allows a bank to be selected that will be locked to the right hand console screen. Touch the Set Master button and then touch the required bank.

In this mode, all other banks are assigned to the left hand console screen and can be accessed using the worksurface layer up and down buttons. Once a Master is set, it can be cleared by touching the **Clear Master** button in the top bar.

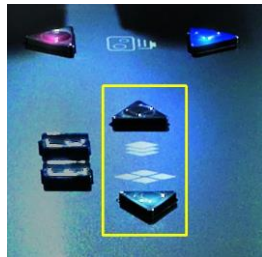

Set Master / Clear Master

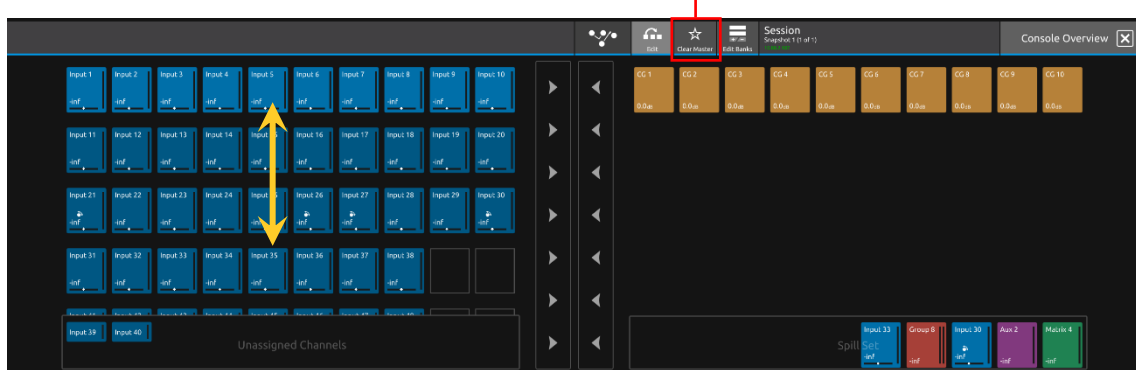

1.4.5 Add/Delete Banks

In **Edit** mode, touching the **Edit Banks** button, displays the **Add Bank** button and when touched, this button will add an empty bank to the existing layout. The console can have up to 12 banks on 6 layers (S21) or 4 layers (S31) when the console is not in Master Mode.

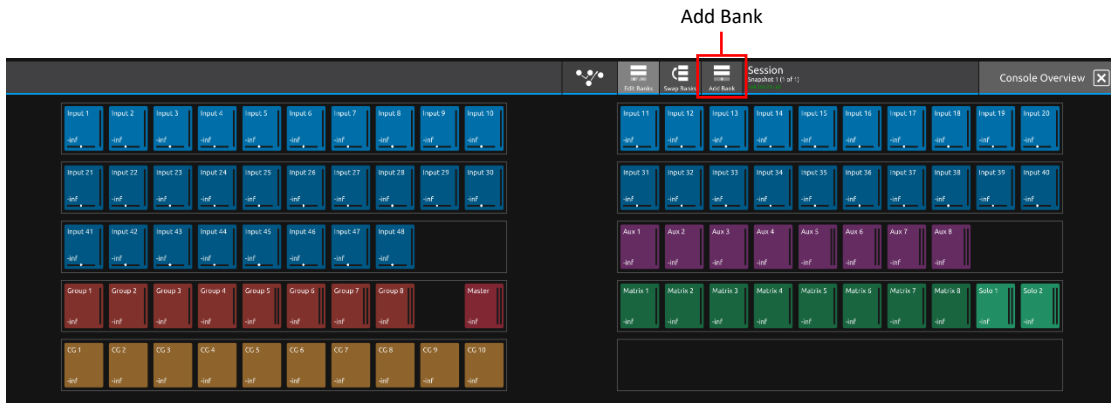

To remove existing banks, select the bank by touching it in the overview display and a **Remove Banks** button will be displayed in the top bar. Touch this button and a warning be will be displayed that requires a user confirmation. When this message is confirmed, the contents of the bank that has been removed will appear in the **Unassigned Channels** section of the display.

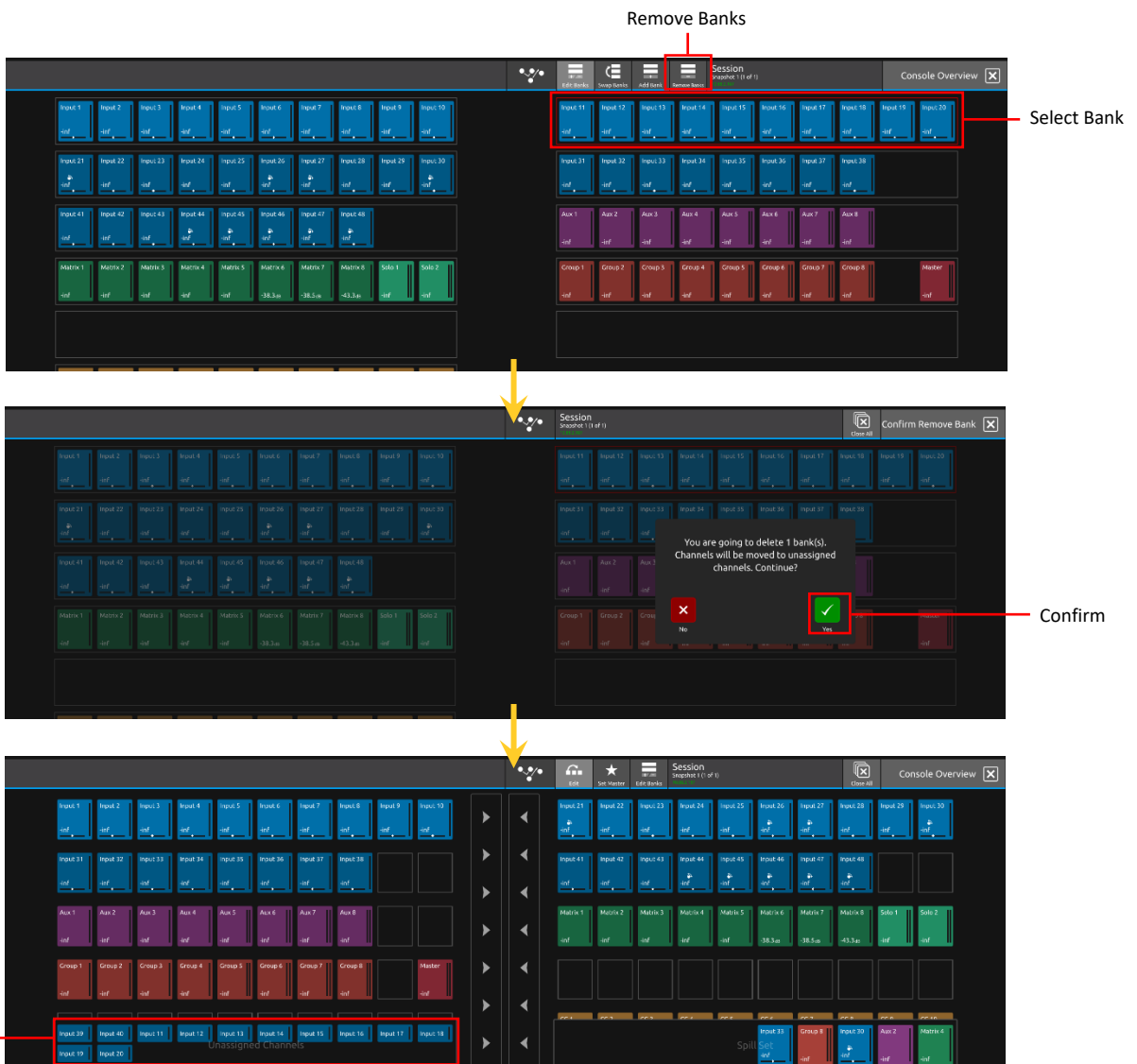

1.5 The Main Menu

The right hand Master Screen has a DiGiCo logo icon at the top which is used to open the **Main Menu**. The Main Menu contains a number of buttons which are used to access various console functions.

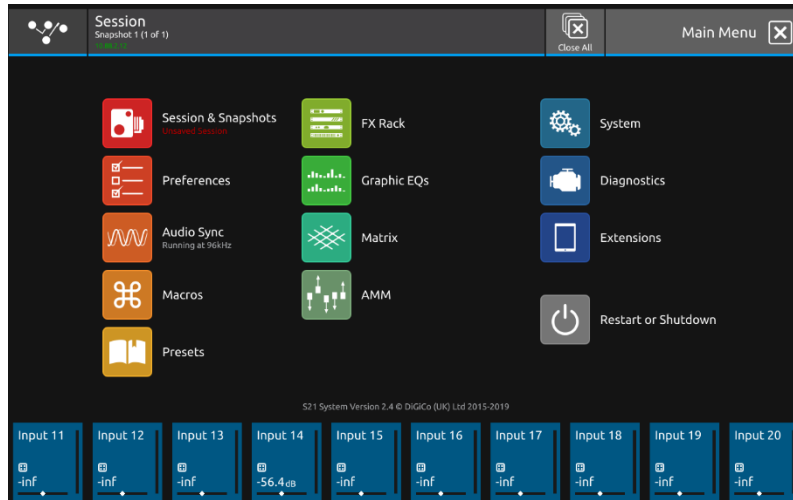

1.5.1 Session Management

Touching the **Sessions & Snapshots** button opens a display which contains file management functions in the top bar and Snapshot control in the main area of the screen.

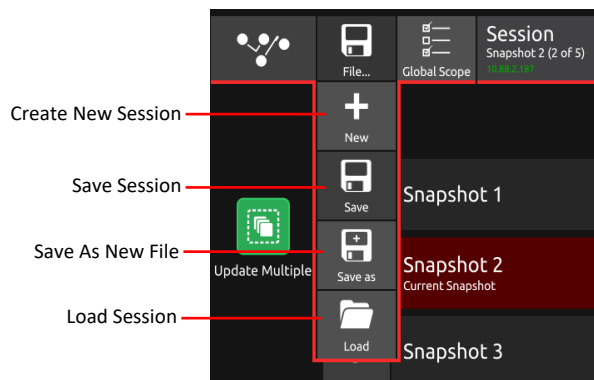
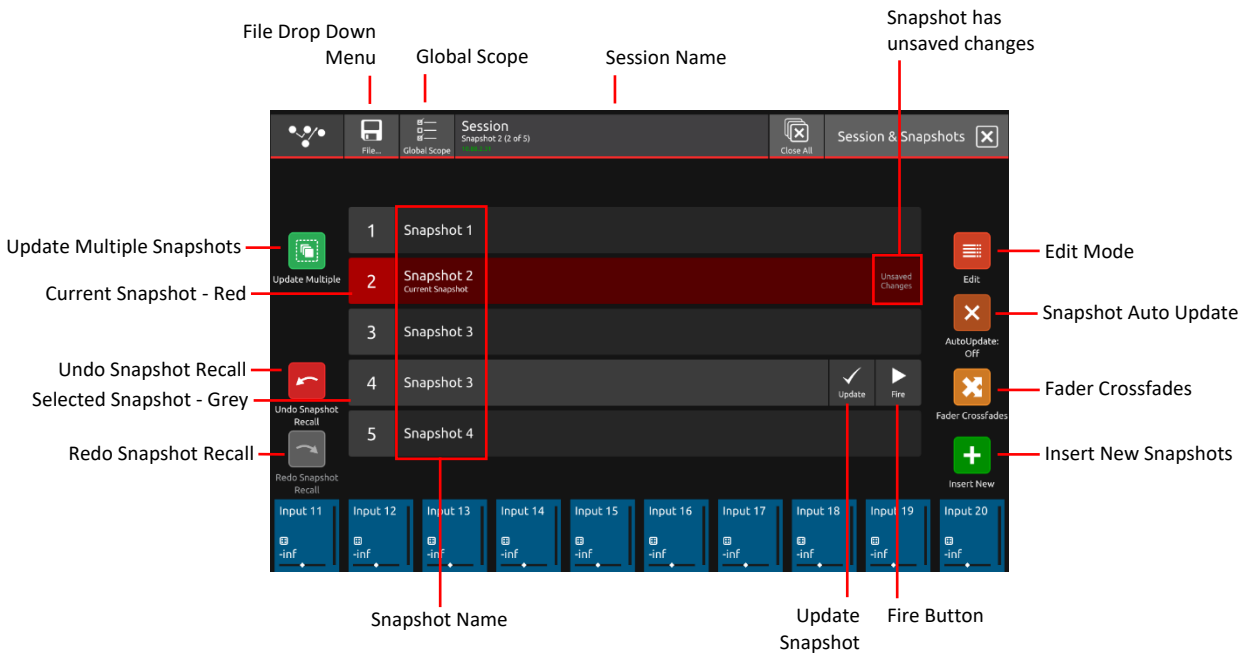

NOTE: The Auto-Update button on the left of the screen relates to Snapshots and not to Sessions. When active, this function will automatically update the current Snapshot as changes are made on the console. Please read the Snapshot section and only activate this function if you definitely require it.

To create a new session, touch the **New** button in the top bar and an activity indicator will be displayed. When the process is complete, touch the **Save As** button, select the internal drive (labelled Internal) or the USB port (with a USB key inserted into the console USB port) and touch the **Save Here** button. Then type a new session name using the on-screen keyboard and touch the **Done** button. To update the session after the initial Save As process, just touch the **Save** button and the current session will be updated automatically. To load an existing session, touch the **Load** button, select the internal or USB drive and then select the required session from the list and touch the **OK** button.

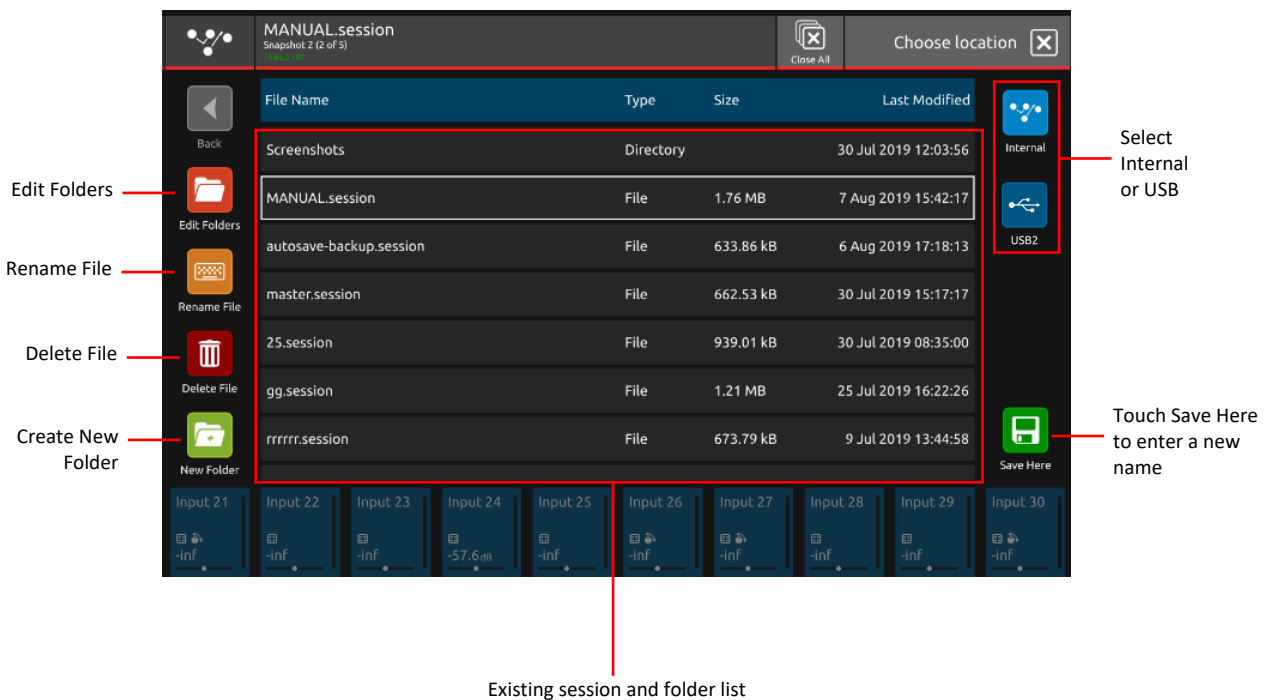

All other file and folder management functions are also available on this panel.

1.5.2 Snapshots

The S-Series console always has at least one Snapshot in its list and more can be added using the **Insert New** button in the bottom right corner of the screen (there is also a Macro available for this function). The **Current** Snapshot is highlighted in **red**.

We recommend that the first snapshot is used as a "Setup" Snapshot where all of your "session wide" settings like routing, Control Group membership and Buss Modes (whether Busses are Groups or Auxes) are first stored.

Because these types of setting can be changed with Snapshot recall, it is advisable to save them all into this first snapshot before creating any further Snapshots. In this way, the settings for all subsequent Snapshots will contain the same data and there should be less requirement to adjust the Safe settings in the channels.

When a Snapshot is created it will always save all of the current console settings and it will be placed in the Snapshot list after the **Selected** (highlighted in **light grey**) Snapshot.

Subsequently, certain console parameters can be isolated or made "Safe" from **Snapshot Recall** as required.

To recall (Fire) a different Snapshot, it must first be selected on the list, highlighting it in light grey, and then the **Fire** button should be touched.

The Previous and Next Snapshots in the list can also be fired by pressing the **Prev/Next** buttons on the worksurface.

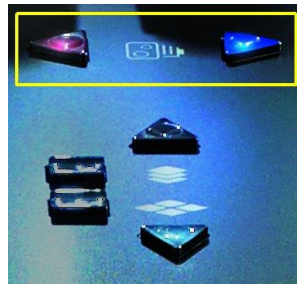

When the console state has changed but the current Snapshot has not been updated, the Snapshot will be marked as having "**Unsaved changes**". Pressing the update button on the current Snapshot will store these unsaved changes.

To change a Snapshot name touch the **Edit** button at the top of the list, touch the Snapshot name and type using the on-screen keyboard.

To delete a Snapshot, touch the **Edit** button (if not already active) and then touch the **Delete** button (dustbin icon) next to the required Snapshot. You will then be required to confirm the action by touching the **Yes** button.

To rename a Snapshot, touch the **Edit** button (if not already active) and then touch the **Rename** button next to the required Snapshot. You will then be required to enter a new name and confirm.

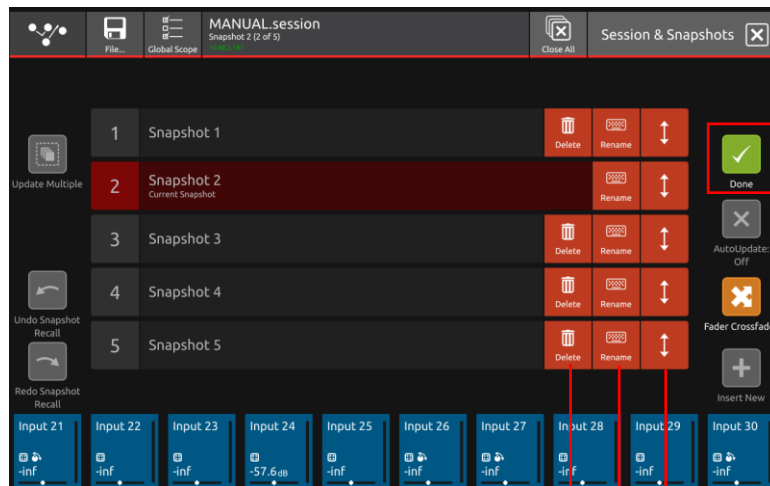

Done to Exit Edit Mode

Delete Snapshot
Rename Snapshot
Change Snapshot Order

Multiple Snapshot Update

To update Multiple Snapshots at the same time:

Open the **Main Menu > Sessions & Snapshots View**.

Touch the **Update Multiple** button.

Select multiple snapshots by touching them on screen or use the **Select All** button.

Adjust the required console settings and the **Confirm** button will become highlighted.

NOTE: While the Confirm button is highlighted, other Snapshot functions are disabled until the Edit function is either cancelled or cleared. Touch the **Confirm** button and the new settings will be written to all selected snapshots.

NOTE: The values that are written to the selected Snapshots are "Absolute" and not relative to their starting position.

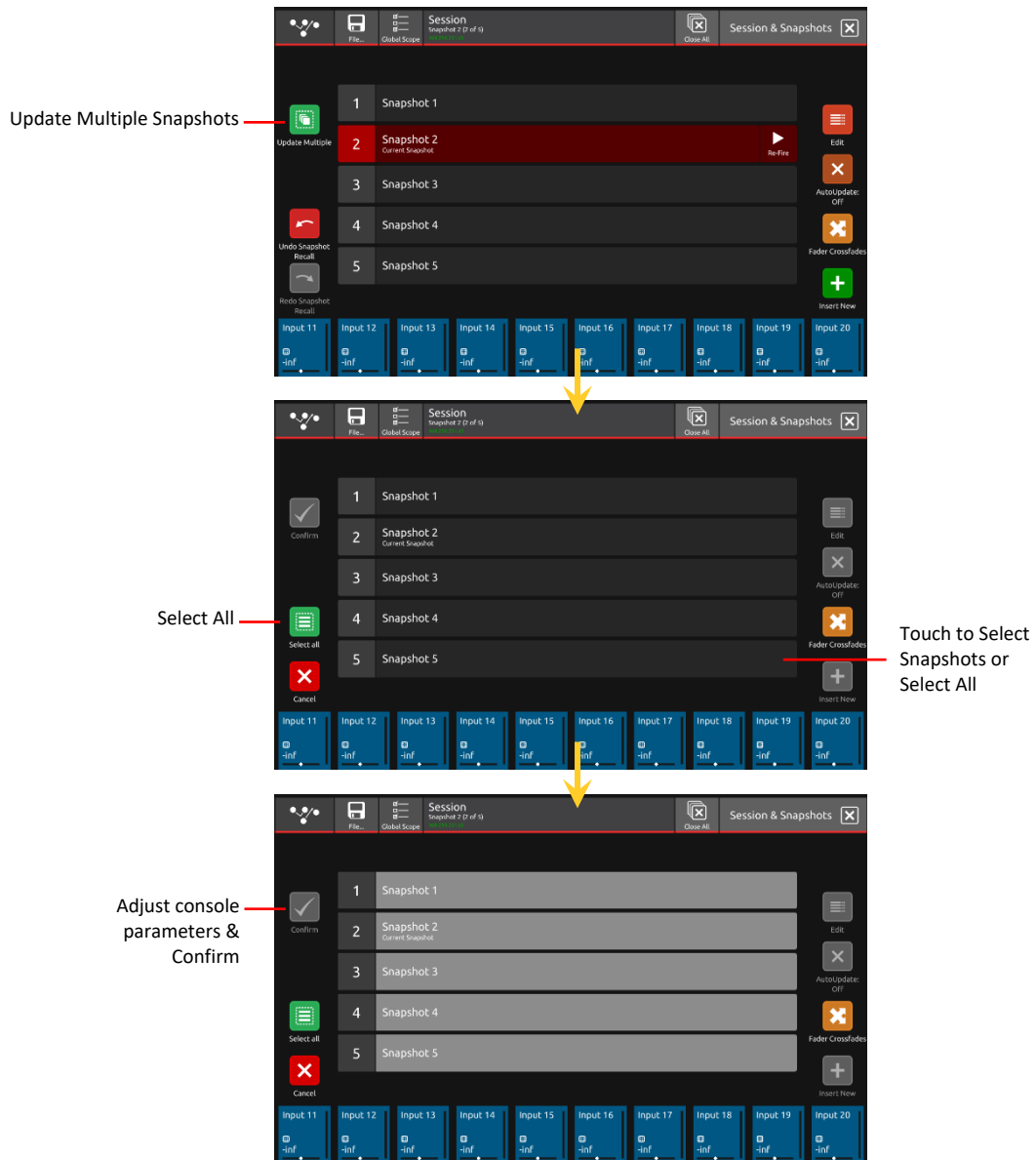

Undo/Redo Snapshot Recall

When a snapshot is recalled (fired), that recall can be undone by touching the **Undo Snapshot Recall** button.

If a snapshot recall has been undone, it can then be redone by touching the **Redo Snapshot Recall** button.

Snapshot Change Order

The order of snapshots in an existing snapshot list can be changed in the following way:

Open the **Main Menu > Sessions & Snapshots View**.

Touch the **Edit** button.

Touch and hold the **up/down arrow** icon at the end of the snapshot row and drag the snapshot to the required new position in the list. When changes are complete, touch the **Done** button to return to the standard view.

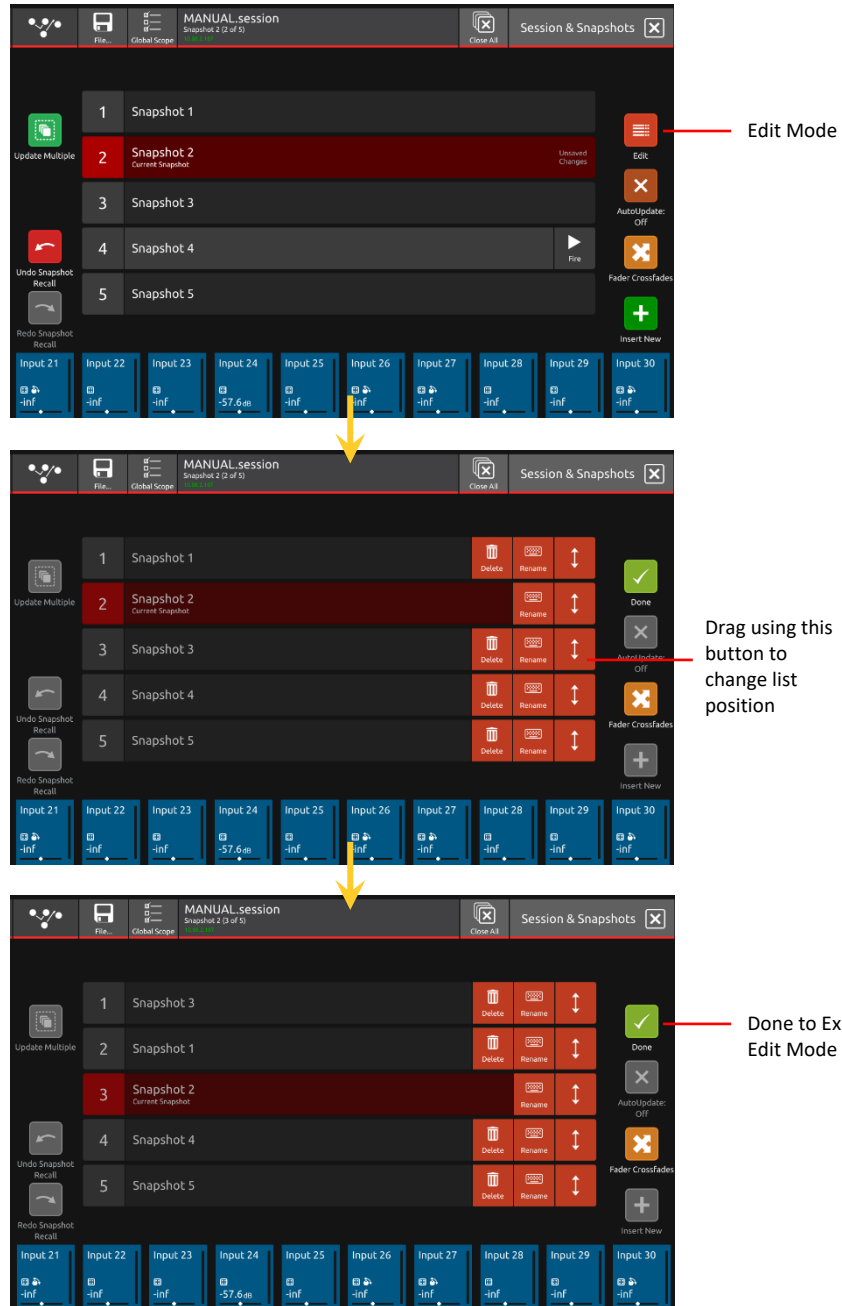

Snapshot Global Recall Scope

Snapshot recall can be controlled globally with the Global Recall Scope settings. These settings can allow or prevent selected console parameters from being affected by the Snapshot system. It is recommended that if you are using Snapshots, you set the Global Scope before you start creating the Snapshot list. However, the Global Scope can be changed at any time.

From the Main Menu > Sessions & Snapshots view touch the **Global Scope** button in the top bar. The **Global Scope Setup view** will now be displayed - Each block represents a different set of console parameters. The default setting for Global Scope will display all of the blocks highlighted in green and this indicates that they are **"In Scope"** and can therefore all be recalled with Snapshots (subject to parameter Safe settings). Touching an individual block will remove the green highlight and this block of parameters is now **"Out of Scope"** and can therefore not be affected by any Snapshot recall - its settings can only be changed manually. For example, in the final picture below, the Global Scope has been adjusted so that only faders, mutes, pans, balance and width, trim, delay, FX and GEQs can be changed with Snapshots.

In the top bar on the Global Scope panel there is also a button that allows all parameters to be **enabled/disabled** at the same time which can make the selection process easier.

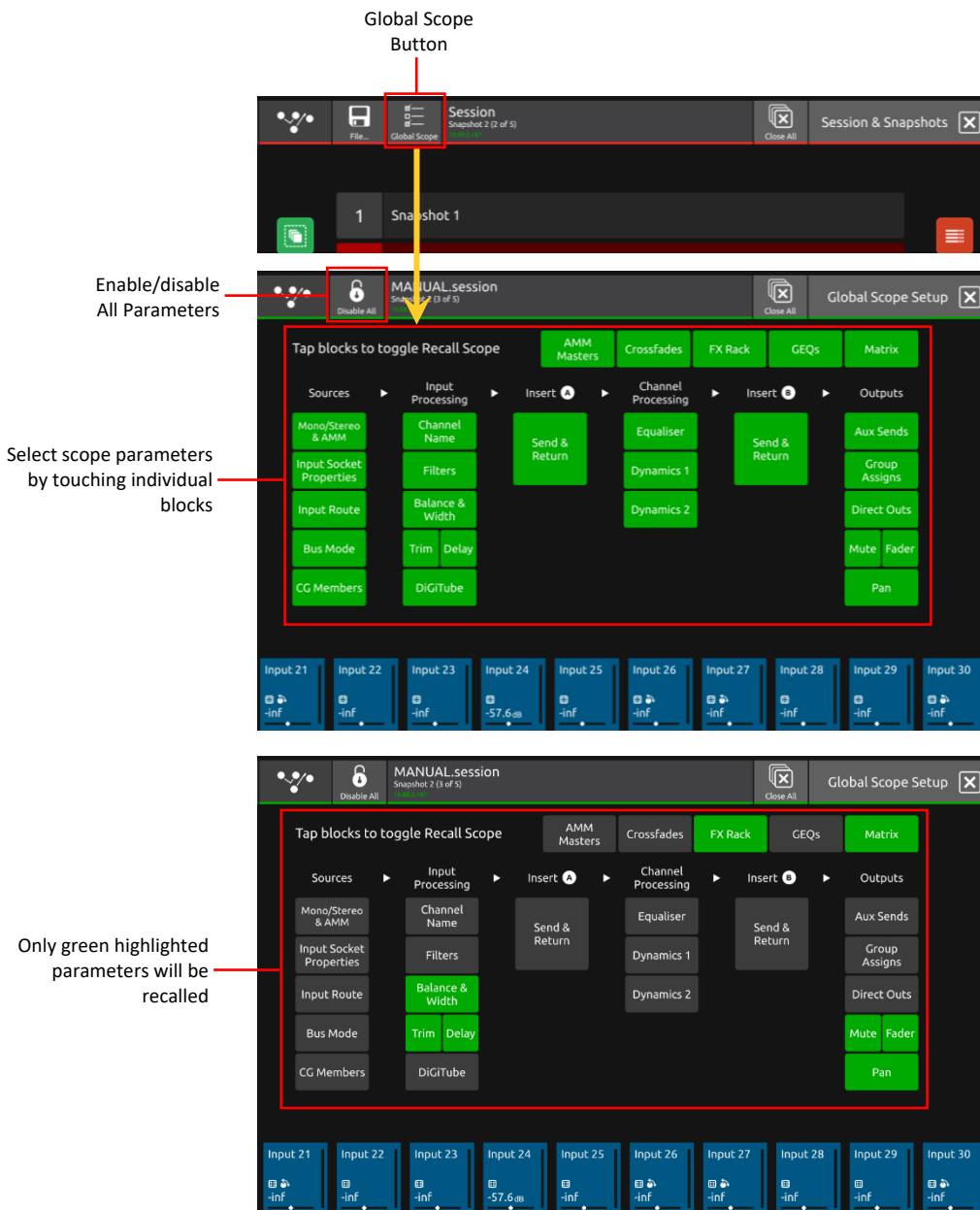

Snapshot Recall Safes

To prevent parameters from being recalled by Snapshots, use the **Safe** functions on each channel which are accessed through the Channel Setup view Safes button in the top bar. If a parameter is Safe, it cannot be affected by any Snapshot Recall. Each block represents a section of the channel as labelled - touch the block, it will be highlighted in red and the Safe will be applied.

NOTE: Socket Properties comprise Analogue Gain, +48V, Input Pad and AES SRC where appropriate. These properties can apply to more than one input channel which is using the same input socket and therefore the Safe state will automatically be the same on all channels that are sharing that socket if there is no socket routed into the channel, the Safe function will not be available.

NOTE: Control Group membership and Buss Modes (Aux or Group) only apply to their relevant channel types and will therefore not be available in input channels

There is also a **Full Safe On/Off** button in the top bar to Safe all of the channel parameters at the same time.

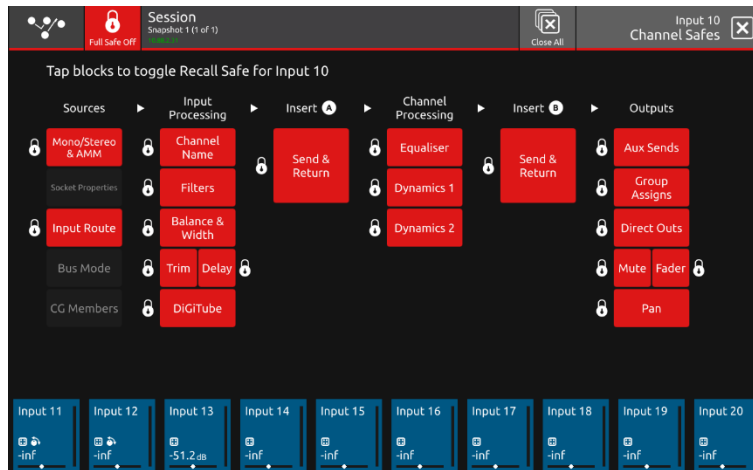

Safes are also available for **individual FX units, Graphic EQ (globally) and individual Matrix Inputs**. The buttons to activate the functions are all located in the top bar of the relevant view.

1.5.3 Fader Crossfades

To edit Fader Crossfades, touch the Main Menu > **Sessions & Snapshots** button and then the **Fader Crossfades** button.

Fire the snapshot that you want to edit the crossfades for. Crossfades will be applied for entering the currently fired snapshot.

Touch the **Fader Crossfades** button in the Sessions & Snapshots menu.

In the Channel Picker view, select the channels for crossfades to be applied to.

The **6th Master Rotary** can now be used to select a crossfade time for the selected channels. The maximum crossfade time is 60 seconds.

Pressing the **Confirm Crossfades** button at the bottom right of the view will save these times to the snapshot.

NOTE: Crossfade times are automatically saved to the snapshot. The snapshot does not have to be updated.

NOTE: Crossfades can only be applied to input channels, matrix channels and CGs.

To apply different crossfade times to different channels for one snapshot, the crossfade view must be entered more than once.

At the top of the Crossfade Channel Picker view, there are selection buttons that allow quick selection of all input channels, or all channels. When selecting a crossfade time, clicking the 6th encoder will round the crossfade time to the nearest second. Pressing and turning the encoder will change the time in coarse mode, meaning higher crossfade times can be reached faster.

When changing fader crossfade time for a single snapshot, the previous crossfade value of each fader is displayed in white, with the new value being shown in orange underneath.



Fader Crossfades can be applied to multiple snapshots at once using the **Update Multiple** function in the Sessions & Snapshots menu. It works in the same way as for other parameters. When in update multiple mode and no other changes have been made, after some crossfades are applied and the confirm button is pressed, update multiple mode will automatically be exited.

There is a macro available that will **Disable All Crossfades**. Enabling Crossfades again will bring back the previously set times.

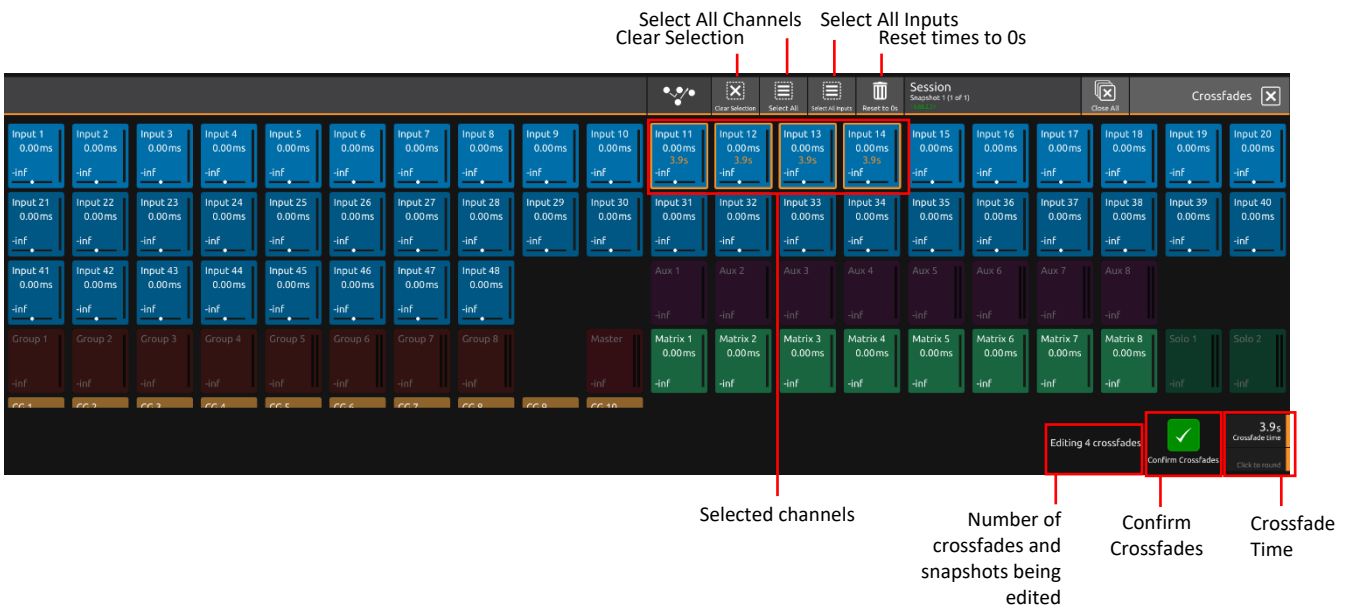
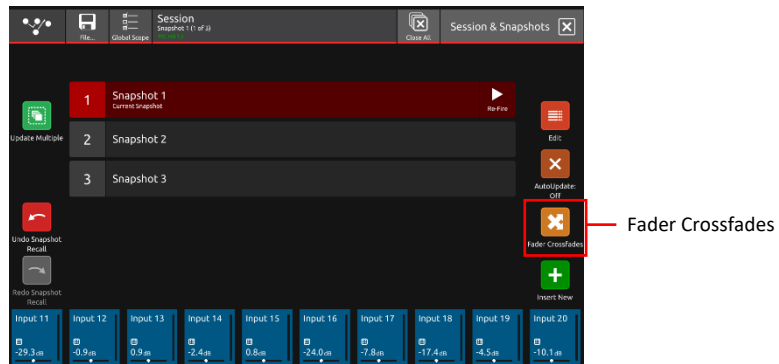

1.5.4 Preferences

Touching the Main Menu > **Preferences** button displays and allows the setting of certain console options.

Meter Preferences - Allows the Attack, Release and Peak Hold of all meters to be adjusted.

Solo Preferences - An extra list of Solo related preferences.

Global Tempo - The 6th Master Rotary to the right of the screen controls the Global Tap Tempo value when touched repeatedly.

Re-assign Master Fader - Allows the master fader at the right of the worksurface to be re-assigned to any channel.

UI Preferences - An extra list of Worksurface related preferences.

Worksurface Preferences - An extra list of Worksurface related preferences.

Brightness Controls - Screen backlight, worksurface LEDs and the Light Bar brightness can be independently adjusted.

Automatic Rack Update - A3232 racks connected via a DMI-A3232 update firmware automatically when discovered.

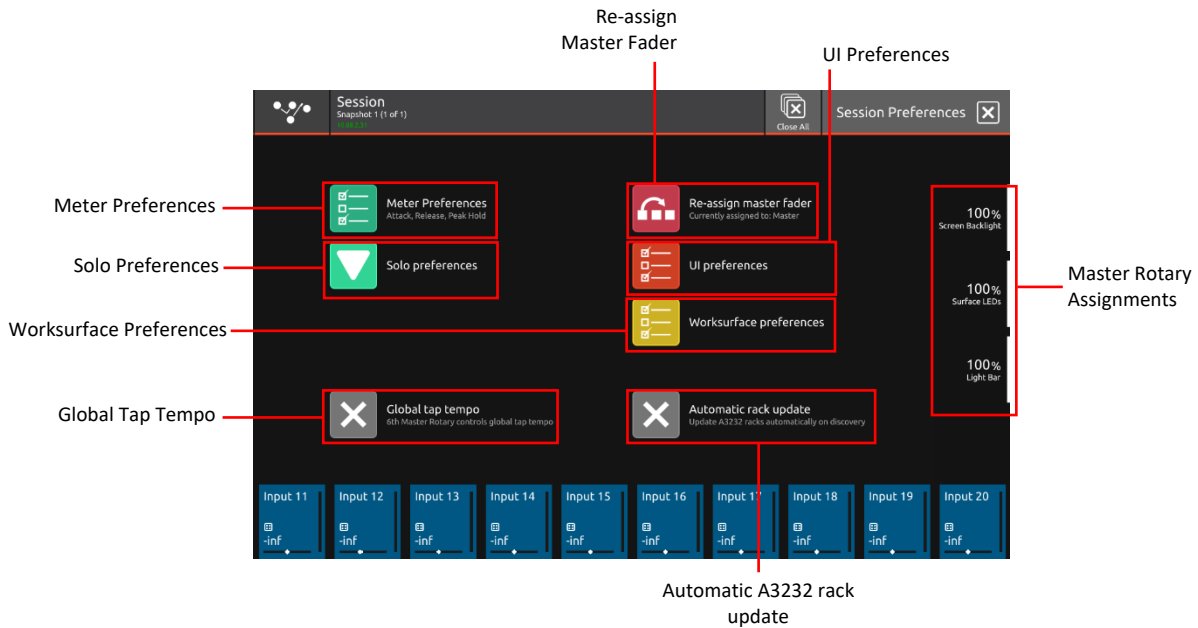

NOTE: A Macro button is also available for the Global Tap Tempo Preferences

Meter Preferences

Touch the Preferences > **Meter Preferences** button.

Touch and drag the sliders to change the meter preferences.

The meter on the left represents the signal on the last selected channel.

Meter Preferences can be **Reset** by touching the button at the top of the screen.

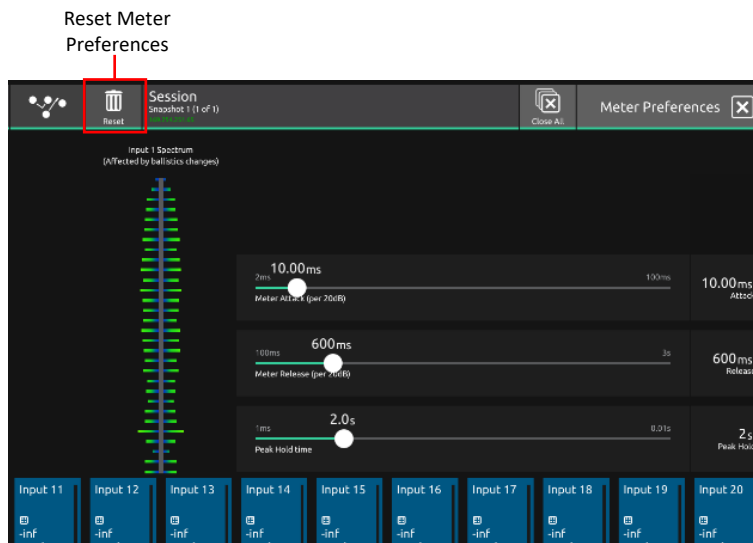

Re-assign Master Fader

Touch the Preferences > **Re-assign Master Fader** button.
Touch the desired channel in the channel picker view.
Touch **OK** to confirm.

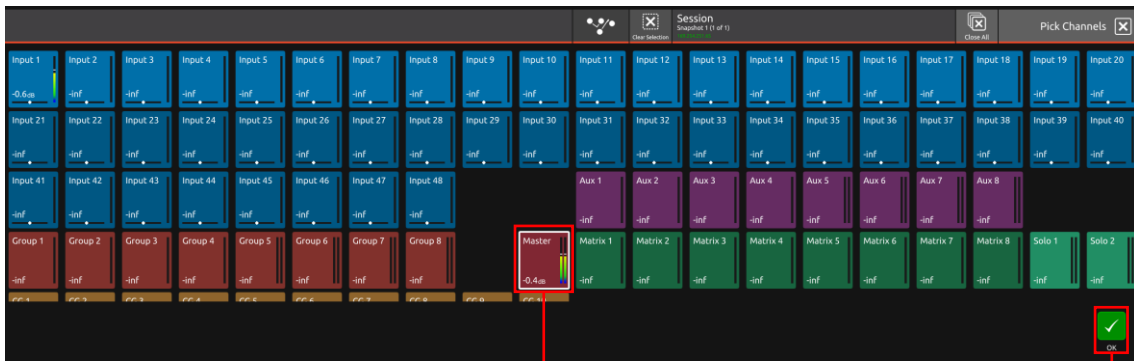

Select channel to assign

OK to Confirm

1.5.5 UI Preferences

User interface preferences allows the user to select which screen to use when spilling a control group, along with whether to turn layer change animations on or off.

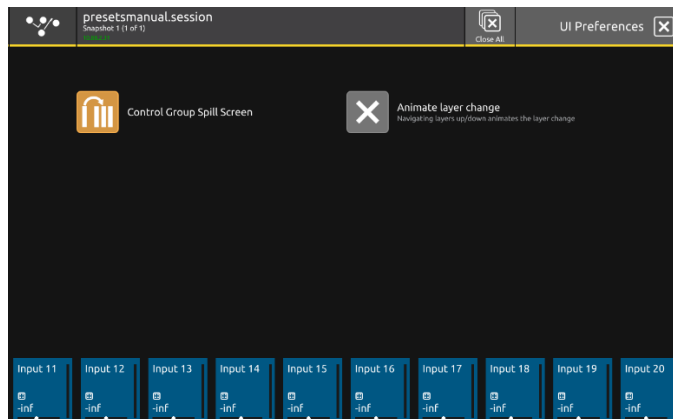

Animate Layer Changes

This allows the user to turn on or off the layer change animation. The default setting is off. Having this off may improve UI speed performance on large sessions when switching layers. This setting is saved with the session.

Control Group Spill Screen

Touch the Preferences > **Control Group Spill Screen** button.
Touch the desired screen to spill CG members onto.
Touch **OK** to confirm.

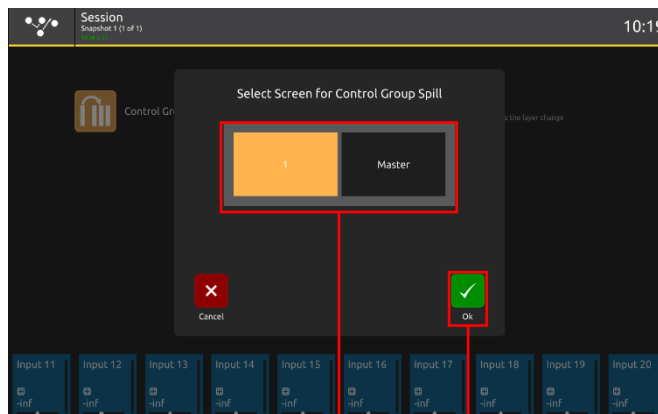

Select Spill Screen

OK to Confirm

1.5.6 Solo Preferences

Touching the Main Menu > Preferences > **Solo Preferences** displays the Solo based preferences.

Solo selects channel - Pressing a channel solo button selects that channel on screen.

Solo assigns Auxes - Setting the Solo Assigns Auxes Preference to ON means that whenever an Aux Master channel is soloed, the sends for that Aux will be assigned to either the underscreen rotaries or the channel faders according to whether the Aux Sends on Faders Preference is active or not.

Control Group Solo Button Control – The Control Group Solo buttons can be set to **Solo Members**, **Spill Members**, or **Solo & Spill Members**. When the solo button is set to Spill members, pressing it again will close the spill.

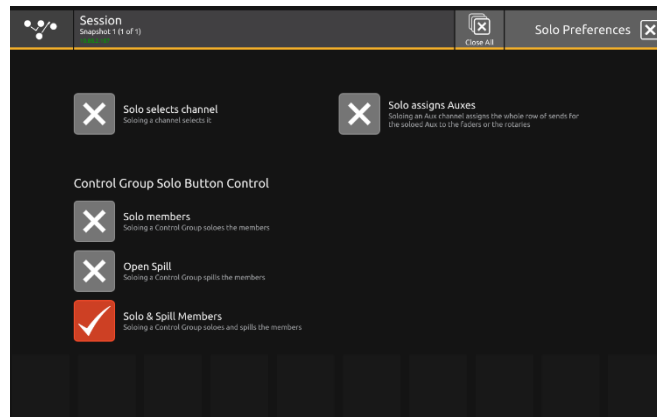

1.5.7 Worksurface Preferences

Fader Mode - Faders can be put into **Free** or **Protected** mode. In Protected mode, the faders require a capacitive (finger) touch to be moved. In Free mode, they do not require this so can be moved whilst wearing gloves.

Disable Snapshot buttons - The worksurface snapshot Previous and Next buttons are disabled.

Disable Master Mute button - This prevents the Master Buss Mute button (above the Master Fader) from having any effect.

The **Aux Sends on Faders** option (also available as a Macro function), when active, assigns the complete row of Aux Sends to the channel faders when an Aux Send row is touched in the Channel view.

In this mode the channel's output block is highlighted with a purple background and the underscreen rotaries are assigned to Aux pans if a stereo Aux row is selected.

In this mode, touching and holding the Aux row will assign the Aux Sends to the underscreen rotaries - the output blocks will turn blue, but the selected Aux row will remain purple.

To reassign the channel faders to their standard function, touch the channel's output block at the bottom of the Channel view, the output blocks will revert to the standard blue colour and the faders will control the channel level again.

AMM Weights on Faders - When this option is selected and a master AMM has been turned on, touching and holding the AMM row in the channel strip view assigns the complete row of AMM Weights to the channel faders. When AMM Weights are on faders, this is indicated by the channel blocks changing colour to Pale Green. Faders can be returned to controlling channel level by touching and holding the Output block area at the bottom of a channel.

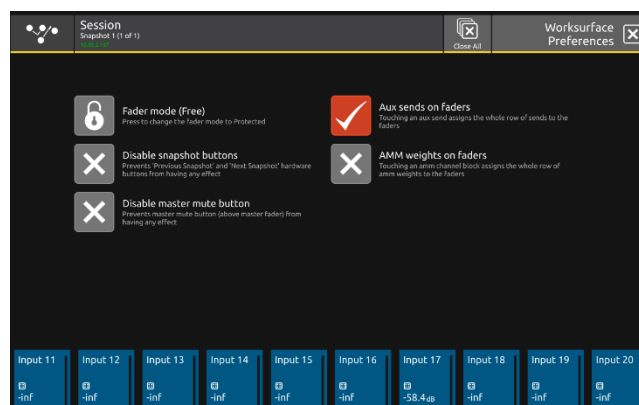

NOTE: Macro buttons are also available for the Aux Sends on Faders and AMM Weights on Faders.

1.5.8 Audio Sync

Touching the Main Menu > **Audio Sync** button displays and allows the setting of console Audio Sync options.

The console's sample rate can be changed from its default **96kHz** to **48kHz** but this has a confirmation stage as the audio will be affected during the switch.

NOTE: When a New Session is created, the console will always default to a 96kHz sample rate.

In normal operation the console should be set to **Internal Sync** and it will automatically provide sync to connected DiGiCo I/O racks via the DMI cards.

Other sync options available are the **Word Clock** input on the console back panel and the **Local I/O AES/EBU** input.

Also **DMI Card 1** or **DMI Card 2** can be used as sync sources.

These options should only be selected if the console is not intended to be the Sync Master for the system.

When a valid sync source is available, the relevant item on-screen will display an indicator to confirm this.

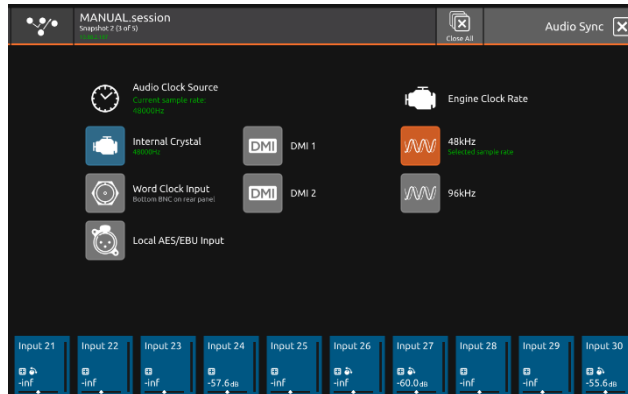

If the desk's sample rate is more than 50Hz away from the correct sample rate for over 5s then an error message will be displayed to the user, as seen below.

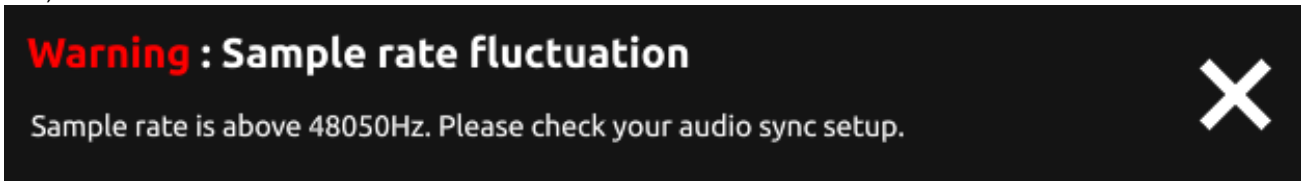

1.5.9 Macros

Touching the Main Menu > **Macros** button displays a list of factory provided Macros that can be assigned to the Macro bar at the top of the left hand screen.

The Macro bar is visible in all console views.

To assign a Macro to the bar, touch and hold on the required Macro on the left screen and drag it into the Macro bar at the top.

To remove a Macro from the bar, touch and hold on the required Macro and drag it back into the main screen area.

Macros can also be reordered within the Macro bar by touching, holding and drag/drop.

The Macro bar can display up to 10 Macros at one time and if more Macros are added, up to 5 groups of 10 Macros can be displayed by swiping horizontally in the Macro bar itself.

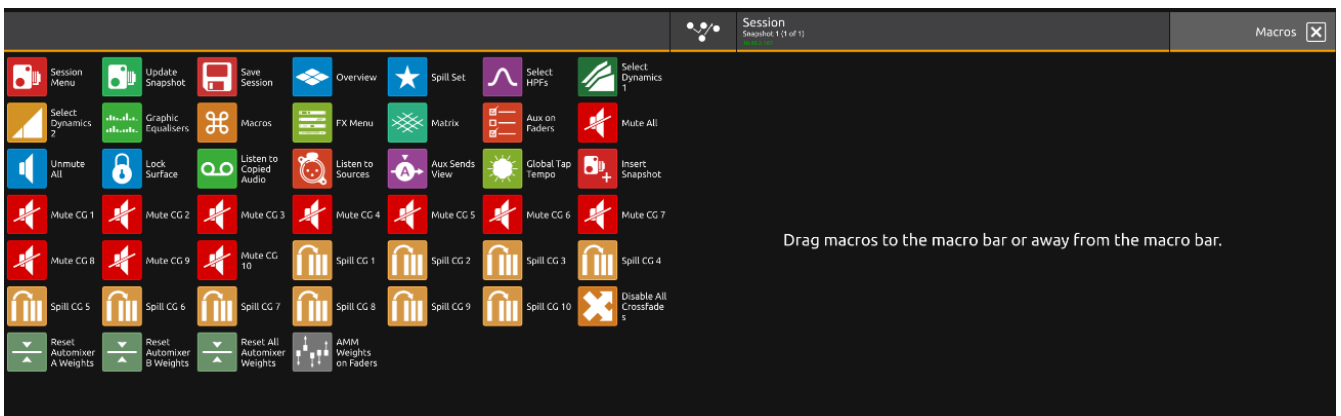

1.5.10 Presets

Touching the Main Menu > **Presets** button displays all the available presets in the current session.

To delete a preset, select **Delete** then select the presets to delete followed by the Delete confirm at the bottom right of the display. Presets and groups can be renamed here in the same manner as the channel presets view.

Presets can be imported to and exported from a session, up to a total of 250 stored in each session. Select Import and Export to transfer presets to and from internal memory or an external USB storage device.

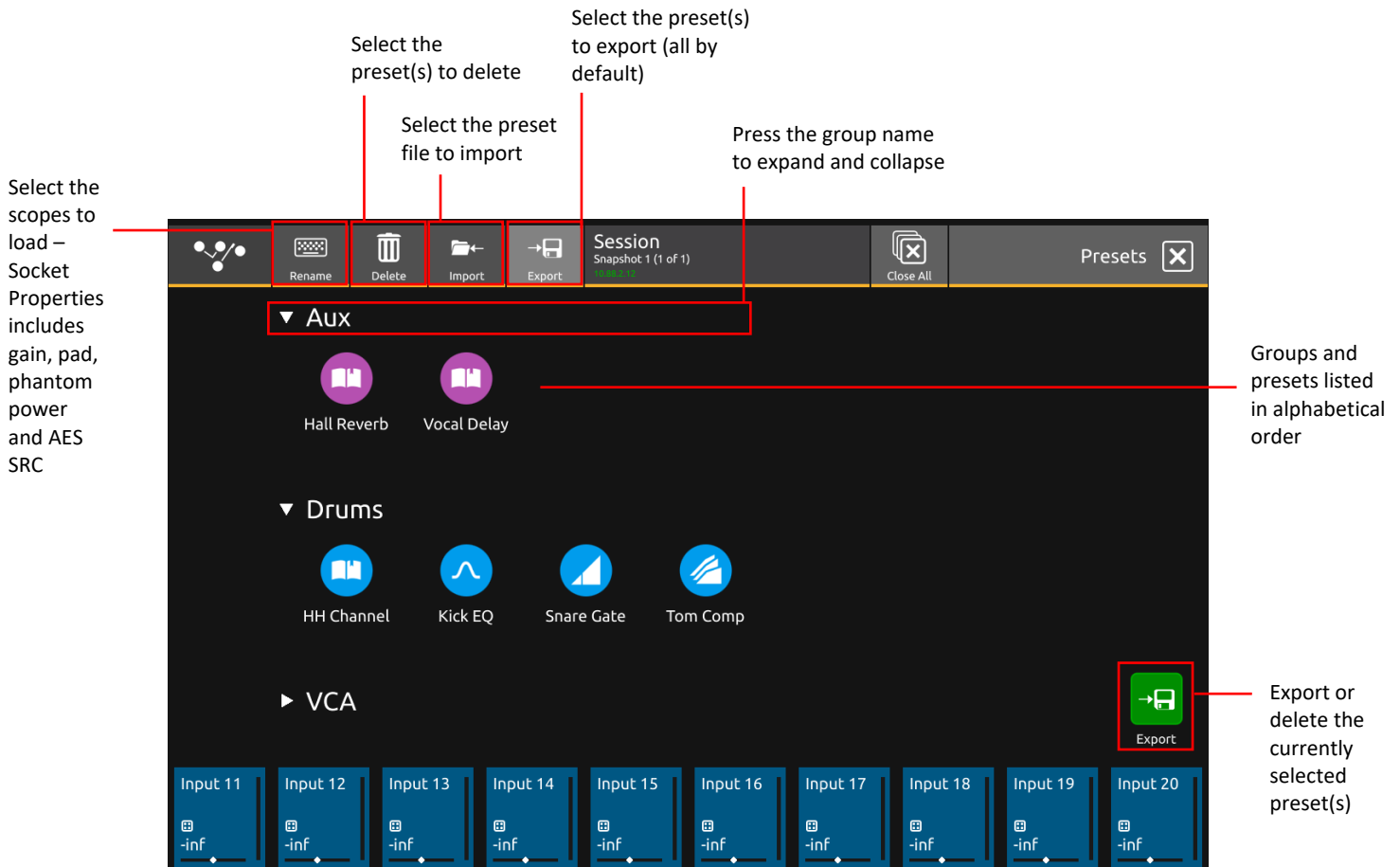

1.5.11 FX Rack

NOTE: A maximum of 6 Delay-based units can be used at any one time. These FX include Chorus, Flangers and Delays. There is no limit to the other available FX.

Touching the Main Menu > **FX Rack** button displays the FX slots and the FX units that are assigned to them.

If a slot is empty, touch that slot and select the required FX unit from the scrollable FX picker list, this will then be added to the slot and opened to display its expanded view.

FX parameters can be adjusted on-screen by touching/dragging the controls or by using the Master rotaries to the right of the screen. Close this view to return to the FX overview and touch on any existing effect to reopen the expanded view.

To change the FX unit type in a slot, touch and hold on the existing unit in the slot and FX picker will be displayed.



To route signal to an FX unit:

Open the Channel Setup view for the required Input Channel or Aux Master by touching the top of the channel strip.

Touch the Direct Outputs block on the right of the screen which opens the output routing view.

Select **Effects** from the **Internal Port Group** in the top left of the screen.

Select a socket(s) for the required FX inputs.

To route signal from an FX unit:

Open the Channel Setup view for the required Input Channel which will be the FX return by touching the top of the channel strip.

Touch the input block in the Source column which opens the input routing view.

Select **Effects** from the **Internal Port Group** in the top left of the screen.

Select a socket(s) for the required FX returns.

A similar routing procedure to the above should be used when inserting FX in a Channel Insert point.

The Channel Insert routing (A or B) is also found in the Channel Setup View.

The buttons in the top bar of the expanded FX view also provide the following functions:

Copy FX from one FX slot to another - touch the copy button and then touch the required destination slot and the confirm copy button.

Clear FX - Set the parameters of the FX unit to its default settings - touch the Clear button.

Safe FX - touch the Safe button, it will highlight in red and so will the outline of the FX unit in the FX overview.

Delay Tap Tempo

In the **Main Menu > FX Rack**, each on screen Delay unit has its own **individual tap tempo button**. This button is also in the Delay unit expanded view.

The worksurface **6th Master Rotary** control can be used as a **Global Tap Tempo** input device and a tempo entered in this way can be applied to single or multiple Delay units in the FX rack. The 6th Master Rotary should be tapped rather than switched (pushed) as it is a touch sensitive control. The green LED ring on this control will flash at the tap speed.

To activate the Global Tap Tempo controller, touch either the **Global Tap Tempo On/Off switch** in the top bar of the FX Rack view or use the **Global Tap Tempo On/Off Macro**. There is also a Global Tap Tempo On/Off switch in the **Preferences Menu** for this function.

To enable a Delay unit to be affected by the Global Tap Tempo, touch the **Join Global Tempo** button in the Delay unit's expanded view. When a new Delay unit is inserted in the FX rack, Join Global Tempo is switched on by default but it can be switched off. In this way, single or multiple Delay units can be affected by the same Global Tap Tempo value.

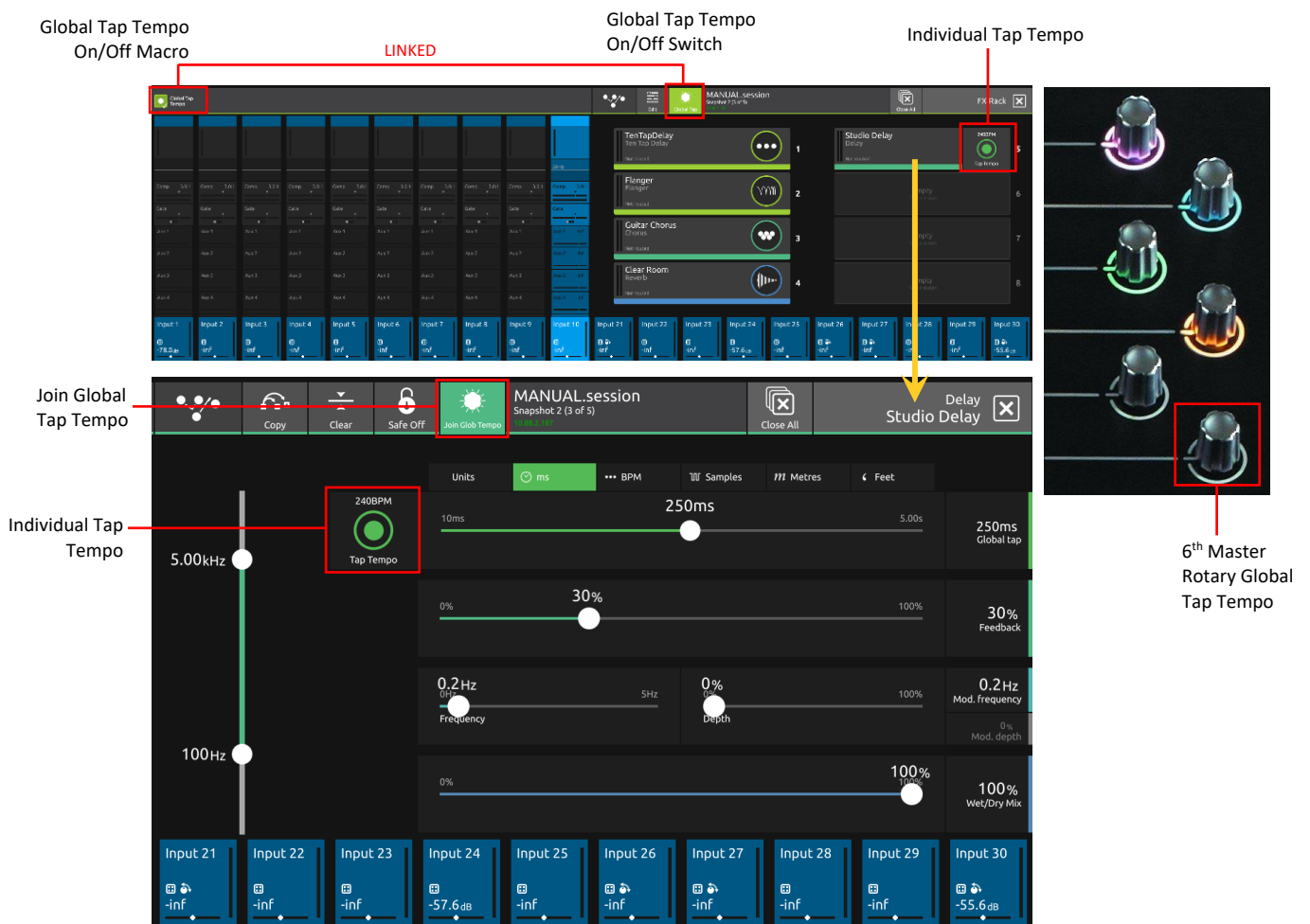

1.5.12 Graphic EQs

Touching the Main Menu > **Graphic EQs** button will display and allow the setting of the Graphic EQs.

When this view is opened, the console's channel faders are immediately assigned to the selected Graphic EQ. Use these faders to change the levels.

To select a different Graphic EQ, touch in the small blocks at the top of the screen and this will reassign the channel faders to that EQ. The display highlights the 20 bands that are currently assigned to the faders and to change the assignment, just drag horizontally in the area between the bottom of the on-screen faders and the frequency labels at the bottom of the screen.

The selected Graphic EQ unit has a **Trim** control and an **On/Off** switch assigned to the 2nd and 3rd Master rotaries on the right of the screens.



To route signal to/from a Graphic EQ using a channel insert point:

Open the Channel Setup view for the required Input Channel or Output channel by touching the top of the channel strip.

Touch the Insert Send block on the Insert A or B column which opens the output routing view.

Select **Graphic EQs** from the **Internal Port Group** in the top left of the screen.

Select a socket(s) for the required Graphic EQ inputs.

Close the output routing view.

Touch the Insert Return block on the Insert A or B column which opens the input routing view.

Select **Graphic EQs** from the **Internal Port Group** in the top left of the screen.

Select a socket(s) for the required Graphic EQ outputs.

Touch the Insert On/Off button to activate the insert point.

This routing will now also be displayed in the relevant Graphic EQ block in the Graphic EQ view.

Copy Graphic EQ

Graphic EQ settings can be copied from one Graphic EQ to single or multiple others using the Copy button in the Graphic EQ view.

Open the **Graphic EQ view** by touching the Graphic EQ button in the Main Menu.

Select a **Source Graphic EQ** unit by touching it on screen.

Touch the **Copy** button in the top bar.

Select the **Destination Graphic EQ unit(s)** by touching them on screen - they will have a white outline.

Touch the **OK** button in the bottom right of the screen.

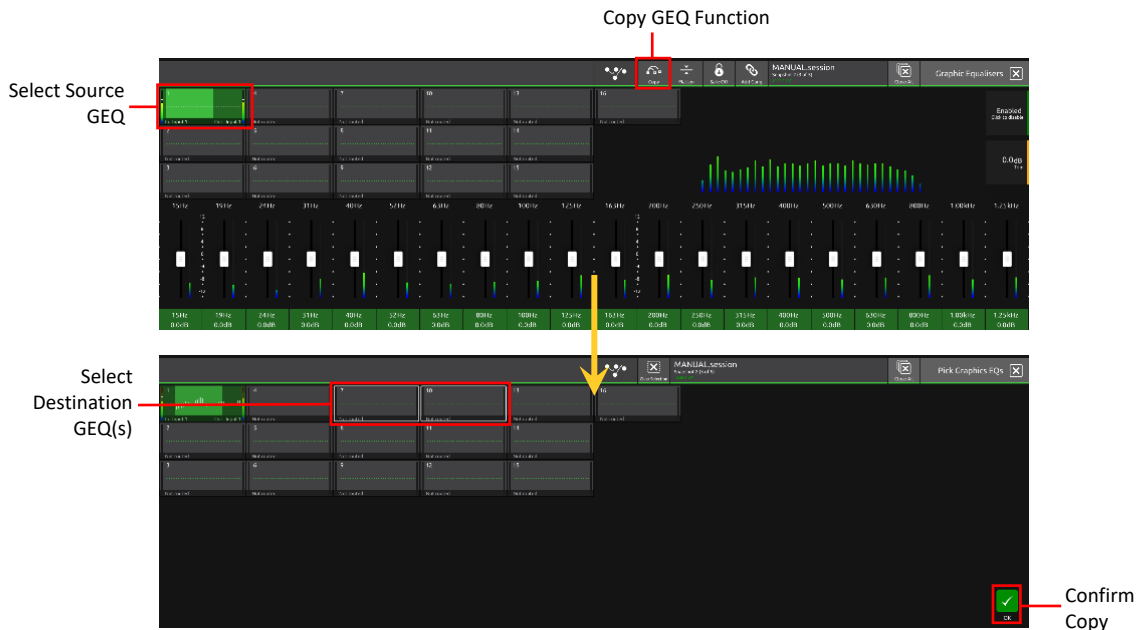

Graphic EQ Ganging

Any Graphic EQ unit can be ganged (linked) to one or more other units so that changes made on one unit will also be made to other members of the gang. Changes are applied relatively to each unit.

To create a new gang:

Touch the first required member of the new gang in the small Graphic EQ displays.

Touch the **Add Gang** button in the top bar of the Graphic EQ view.

Touch the small Graphic EQ displays to select or deselect members.

Touch the **OK** button to confirm.

Members will now be displayed with a colour coded number and a link symbol on each gang member.

To edit an existing gang:

Touch any member of the existing gang in the small Graphic EQ displays.

Touch the **Edit Gang** button in the top bar of the Graphic EQ view.

Touch the small Graphic EQ displays to select or deselect members.

Touch the **OK** button to confirm.

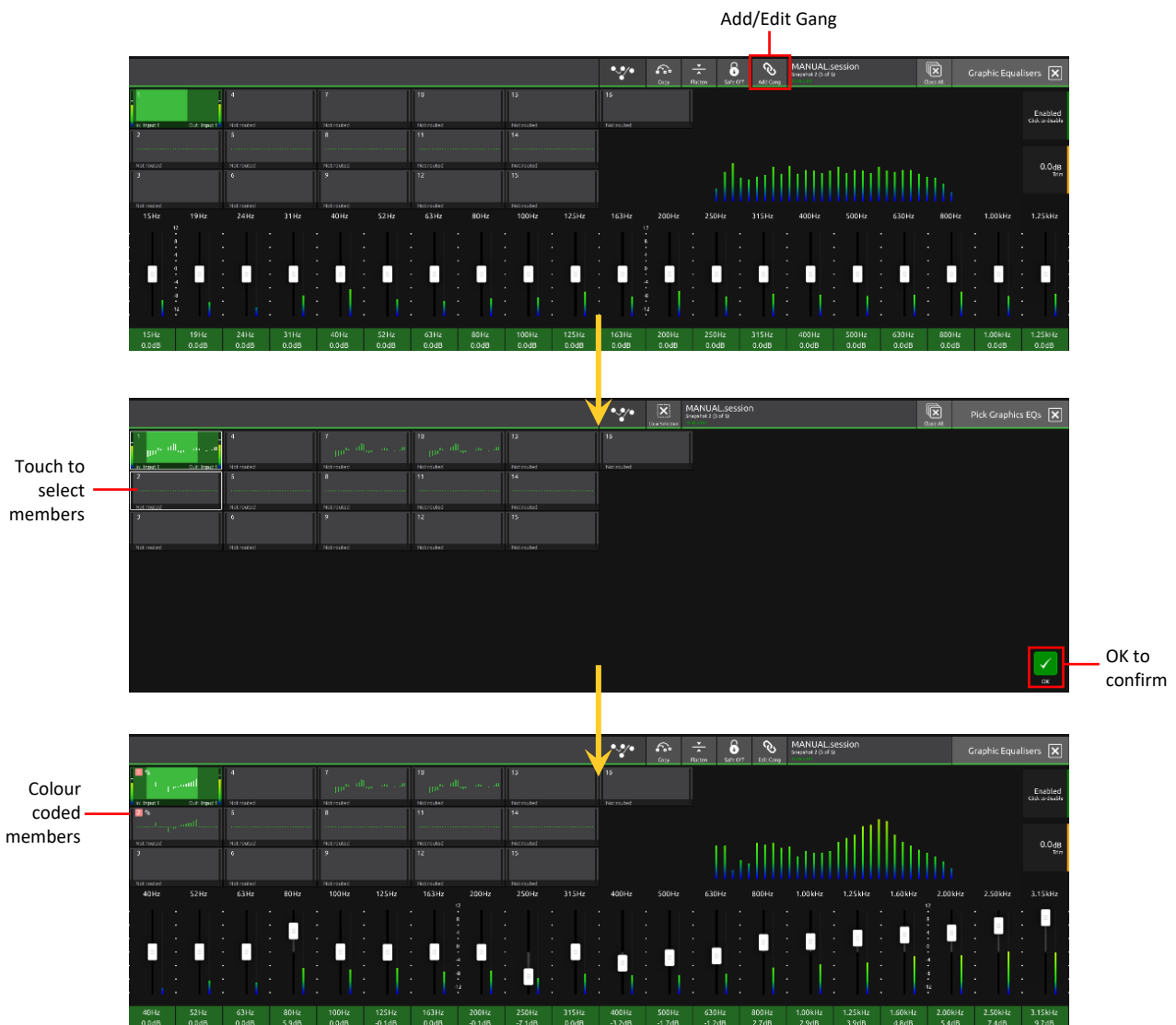

1.5.13 Send & Return Insert Routing

For insert points routed to/from internal sources like Graphic EQ and Effects plus Record Sends & Returns to/from UBMADI, there is an option to route the send and return sockets together automatically.
 Open the Insert Send routing view.
 Select the relevant port for the Insert Send destination e.g. Graphic EQ.
 Touch the Send & Return Routing button in the top bar to highlight it.
 Select the required Insert Send socket e.g. Graphic EQ 8.
 The Insert Return for this Insert point will now be routed automatically from Graphic EQ 8.

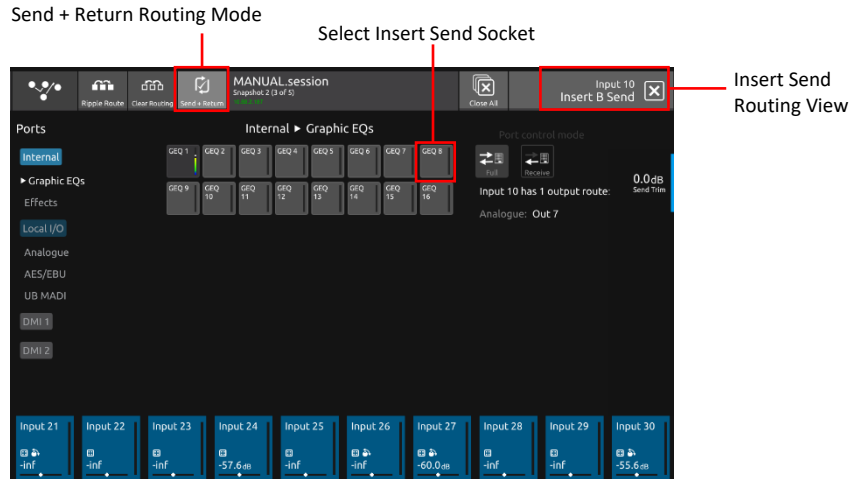

1.5.14 Matrix

Touching the Main Menu > **Matrix** button will display and allow the setting of the Matrix Inputs and Matrix Sends. The Matrix has 10 inputs and 8 outputs displayed in a grid on screen.

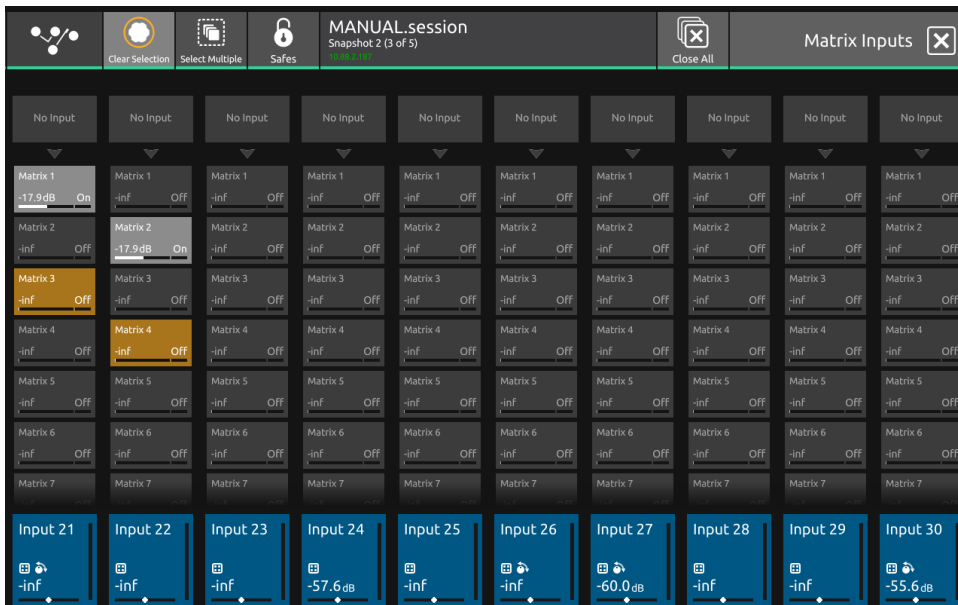

Matrix Inputs are selected by touching in the block at the top of the Matrix Input channel which is labelled **No Input** when it is not assigned. This opens the **Matrix Input Routing View**.
 Select the relevant internal port, rack or local I/O from the ports column and the select the required input socket from the socket display.
 Close the view to return to the Matrix Inputs grid view.
 To switch Matrix Nodes On/Off and control the send levels:
 Select the required nodes by touching them on-screen - each selected node will be highlighted in orange.
 If the **Select Multiple** button is active in the top bar then multiple nodes can be selected and adjusted at the same time.
 Touching the Select Multiple button will activate **Select Single** mode which only allows one node to be selected at a time.
 Once nodes are selected, they can be adjusted using the Touch/Turn control assigned to the 6th Master Rotary on the worksurface. This is also lit in orange.
 Push the rotary control to switch nodes On/Off and turn to adjust the Matrix Send levels.
 When the adjustments are done, either touch the selected nodes individually to deselect them or touch the **Clear Selection** button in the top bar.

1.5.15 AMM

The DMI-AMM card automatically manages several live microphones in unpredictable dialogue situations. When one person speaks, that microphone’s gain level fades up instantly, while the other microphone gains are reduced. When the speaker pauses, all microphone levels will adjust to medium gain to collectively match the level of one microphone at full gain. The resulting effect will be as if all speakers are sharing one microphone. When several people talk at once, the gain is shared.

The Weighting control allows adjustment of the relative sensitivity of the DMI-AMM on a per channel basis. When weighting controls are balanced (equal), each microphone has an equal opportunity to “take over” the system. Changing the weight will not have an effect on the overall level of the channel, just how easily it can take a share of the gain. There is a Floor control that imposes a lower limit on the level detector for all microphones in the relevant AMM group to prevent a noisy microphone capturing a disproportionate share of gain. The Floor should be left at the default value of -130dB for normal operation.

One DMI-AMM gives the S-Series console two independent 48 channel AMM groups. All AMM parameters (both master and channel specific) are saved on a per snapshot basis and can be saved or removed from the global scope.

Adjusting the Master AMM Controls:

Touching Main Menu > **AMM** will show the AMM Master view.

When first inserting a DMI-AMM, there will be a **Conform** button in this view. This must be touched for the card to become active.

The **Card Status** here shows if there is an AMM card present, and if so which DMI slot it is in.

Each AMM group (A and B) has its own **Master Enable** button. Touch this to enable an AMM group. When an AMM group has been enabled, a **Green AMM Row** will appear across the channels.

The AMM Master view has a drop down menu at the top where Weights can be Reset. If resetting Weights, a Warning will appear. Touch **Yes** to confirm. There is also a set of Macros to reset group A weights, reset group B weights or reset all weights.

The separate **Floor controls** for each AMM group can be adjusted by touching and dragging the sliders or using the Master Rotaries. Clicking a Master Rotary will reset the Floor of that group to -130dB.

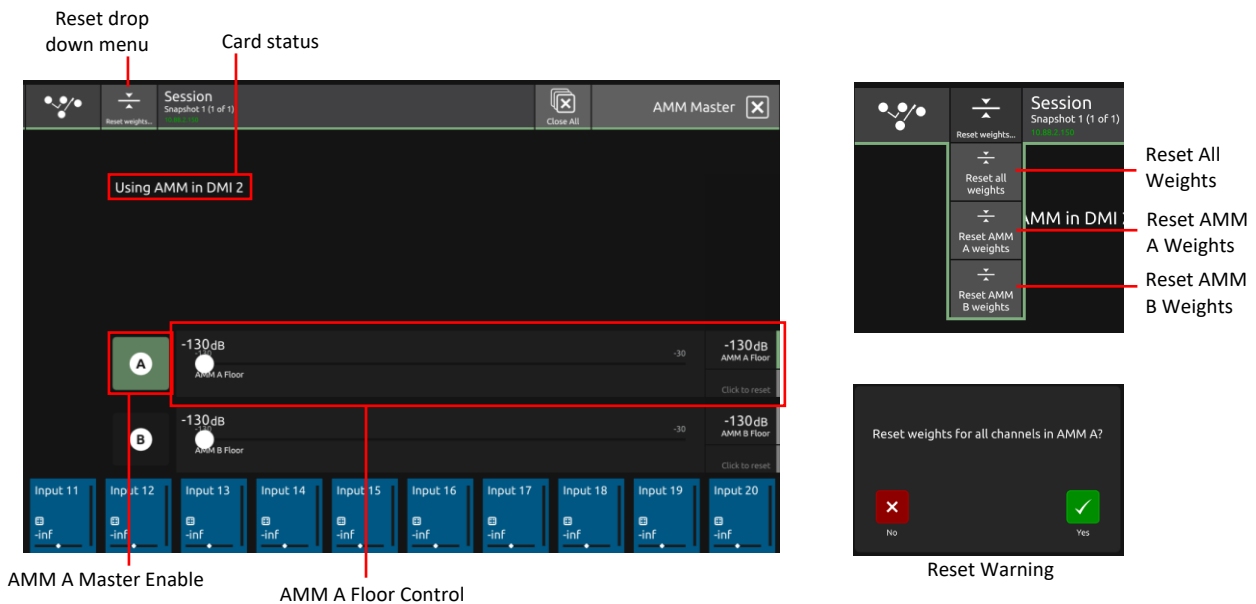

Adjusting the Channel Specific AMM Controls:

Touch the **AMM block** of a channel to open the Channel’s AMM Settings.

Touch the A or the B box to change the channel’s AMM Membership. Each channel can only be a member of one AMM group.

Touch and drag the slider or use the Master Rotary to change the channel’s Weight. Clicking the Master Rotary will reset the Weight to 0dB.

To Reset the Weights for the channel’s assigned AMM group, touch the **Reset AMM Group Weights** button to the left of the screen.

The **Send and Receive Meters** show the level of signal going to the AMM card and the level returning.

The yellow **Share Meter** shows the percentage of the gain share that the channel is taking.

Touch the **AMM Master View** button at the top of the screen to go to the AMM Master View.

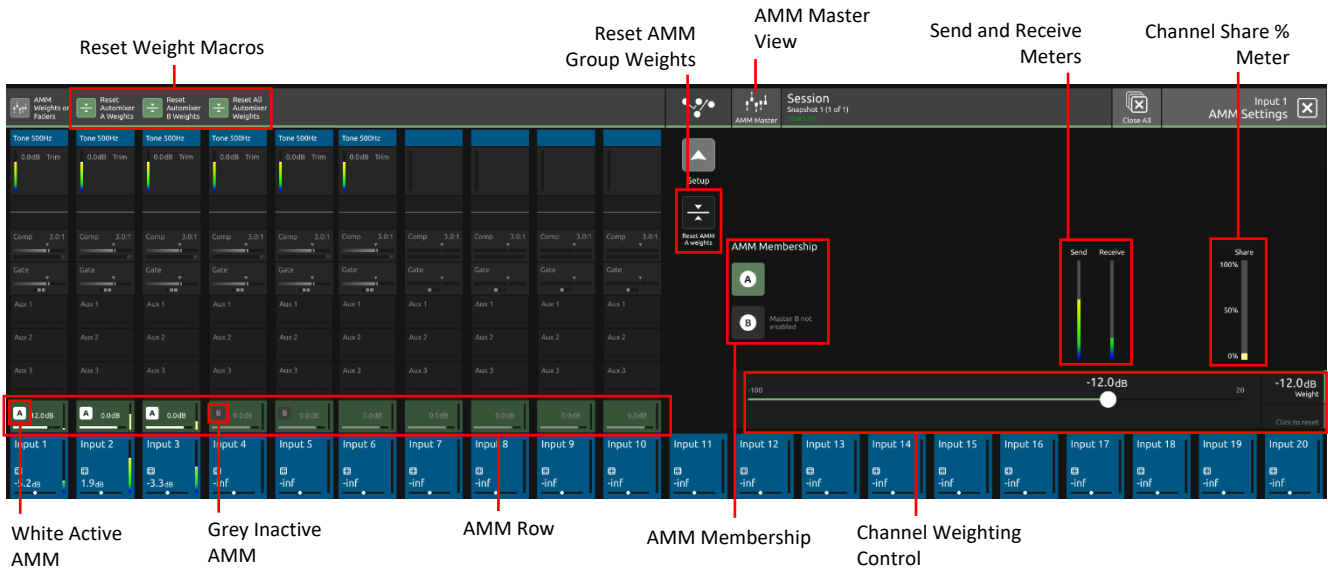

The green AMM row shows the AMM Membership of each channel. A white box shows that the AMM group is active. A grey box shows that the AMM group is not active. This could be due to the Master Enable for the group being off, or no AMM card being present. The AMM row also shows a horizontal Weight meter and a vertical Share meter. Touching and holding the AMM row will assign the underscreen rotaries to control the channel weights. AMM weights can be put onto faders in the same way that Aux sends can be put onto faders. This is an option in the Worksurface Preferences menu. An **AMM Weights on Faders Macro** also exists.

To put AMM Weights on Faders:

- Turn on the option in the Worksurface Preferences or by using the Macro.
- Touch and Hold the **AMM row** in the same way to assign controls to the underscreen rotaries.
- When Weights are on faders, a Green theme will be adopted.
- To return the faders to channel levels, hold the Channel Output Block.

AMM Weights on Faders Macro



A session can be set up with AMM parameters without a card being present. All AMM parameters can be changed, but no audio will be affected. This means that an AMM session can also be setup using the offline software.

NOTE: Stereo channels cannot be added to an AMM. Only input channels can be added to the AMM. In channel input or output routing views, the DMI-AMM will appear as grey because routing is done automatically.

1.5.16 System

Touching the Main Menu > **System** button will display and allow the setting of various system level console functions.

NOTE: In normal operation there will seldom be any need to adjust any of these settings

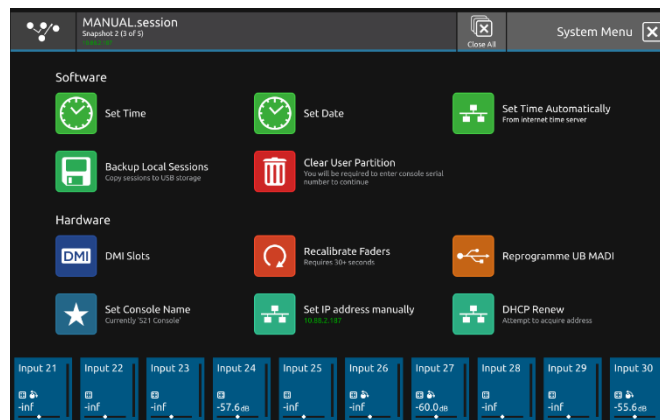

There are options to manually **set the time and date** for the console.

This can also be done automatically but requires an internet connection with a DHCP server.

Faders can be calibrated which is a process that takes approx. 30 seconds - **please do not do this unless advised to do so by DiGiCo Support.**

The **UBMADI interface** can be reprogrammed with new firmware if required - **please do not do this unless advised to do so by DiGiCo Support.**

The **console name** can be reset, and the console's **IP address** set or renewed via DHCP - **please do not do this unless advised to do so by DiGiCo Support.**

DMI Cards can have their software or firmware upgraded or downgraded to a version which is approved for S-Series consoles.

This will be required if the DMI firmware dates do not match the required code dates for S-Series consoles which are embedded in the application.

Code version on the DMI card matches the console requirement

Code version on the DMI card is more recent than the console requirement

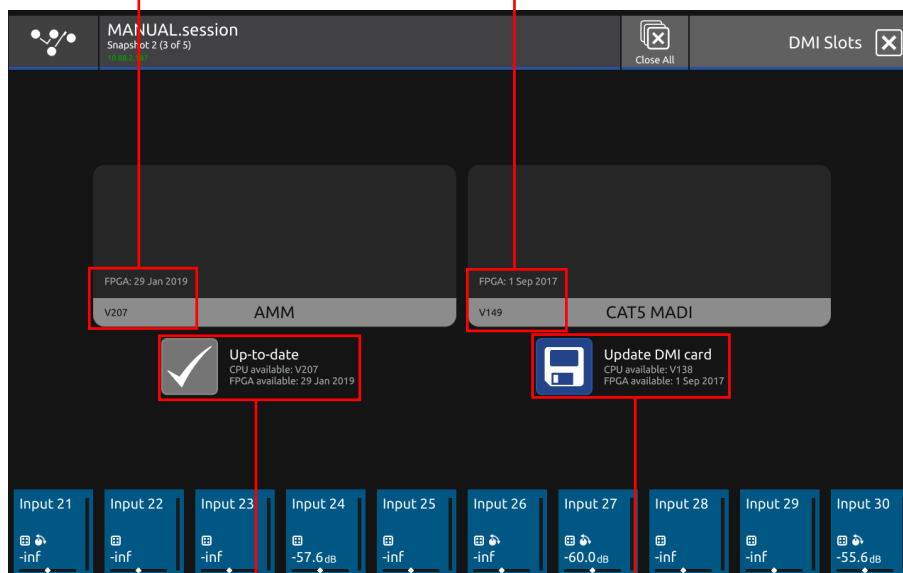

DMI Firmware up to date

DMI Firmware requires a downgrade

Backup Local Sessions will copy all of the sessions present on the local user partition of the console to a USB key. First insert a USB key into one of the console's USB ports. Touch the **System Menu > Backup Local Sessions** button. Read the displayed warning and touch the Confirm button. A file browser view will be displayed - Select the required USB key. Touch the **Save Here** button, type a name for the folder which will contain the saved sessions and confirm. All sessions will be saved in a folder on the USB key - the folder will have the name entered in the previous step.

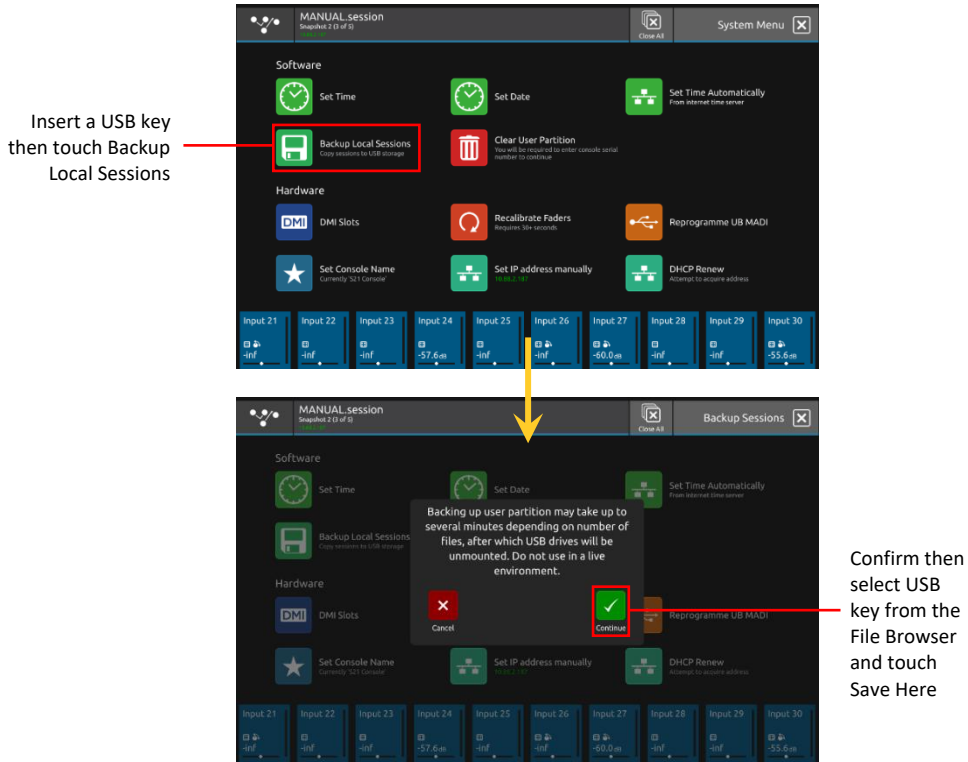

Clear User Partition will permanently remove all of the sessions present in the user partition of the console. *NOTE: Please use this function with care - all of the sessions currently on the console will be deleted. You will be required to enter the console serial number and confirm the function before proceeding.*

Touch the **Clear User Partition** button. When prompted, enter the console serial number and confirm all warnings to proceed.

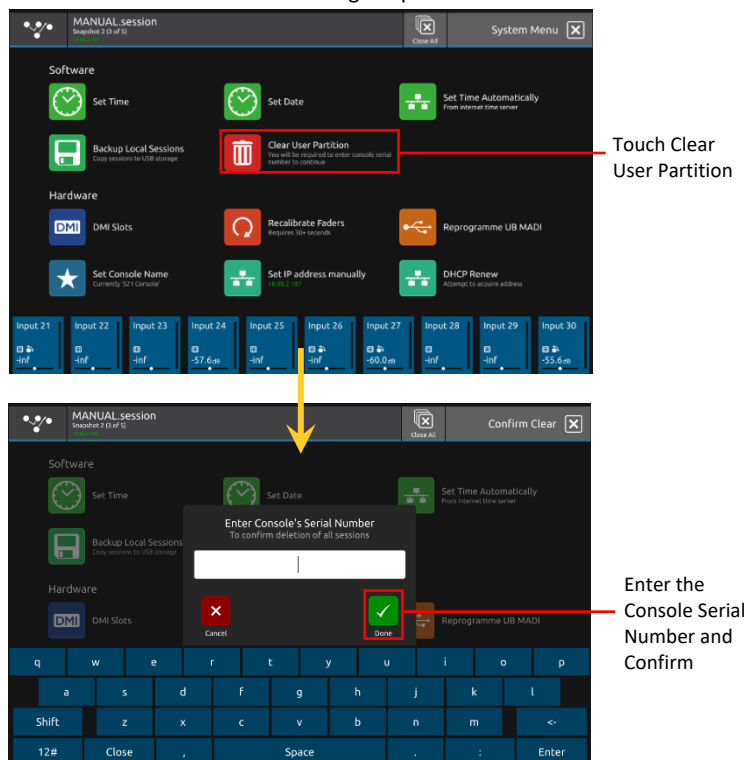

1.5.17 Diagnostics

Touching the Main Menu > **Diagnostics** button will display various console settings such as software and firmware versions. This information may be required in the event of troubleshooting procedures.

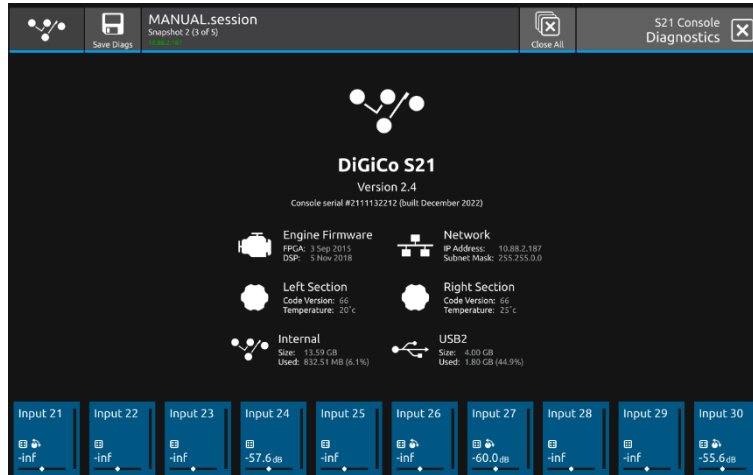

1.5.18 Extensions

Touching the Main Menu > **Extensions** button will display the available extensions.

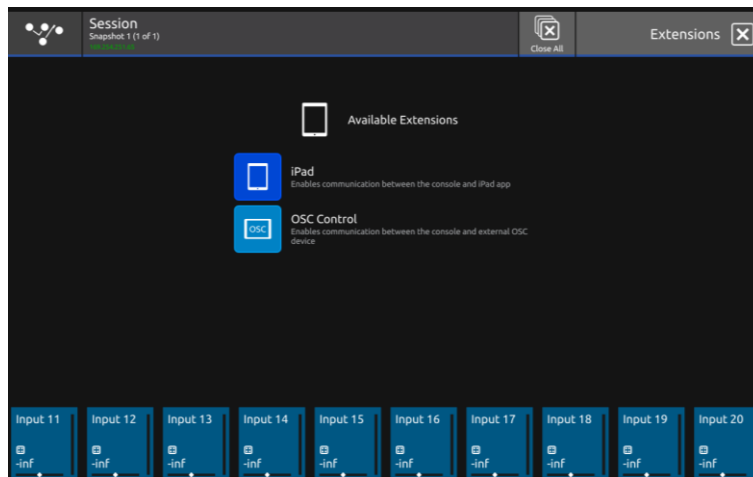

iPad

To connect an iPad running the DiGiCo S-Series App, touch Extensions > **iPad** to enter the **iPad Configuration** view.

Touch **Add New Controller** in the top left corner to add a new device. This will open a floating window where the **device's IP Address** and the **device's Receive Port** should be entered. Touch **Done** to confirm these values. This will create a new Controller row in the **Controllers Table**.

Touch the **Receive Port** button to change the **console's Receive Port**. Touch **Done** to confirm this value.

Touch the **Enable iPad Connections** button to enable any connections.

Touch the **Enable Controller** button for the desired controller in the **Controllers Table**. Only one controller can be enabled at any one time. A controller cannot be enabled if any other controller is enabled.

Individual controllers can be removed from the **Controllers Table** by pressing the **Remove Controller** button for the appropriate controller. All controllers can be removed at once by touching the **Remove All Controllers** button at the top of the screen.

NOTE: Multiple iPads can be added as controllers but only one can be enabled at a time.

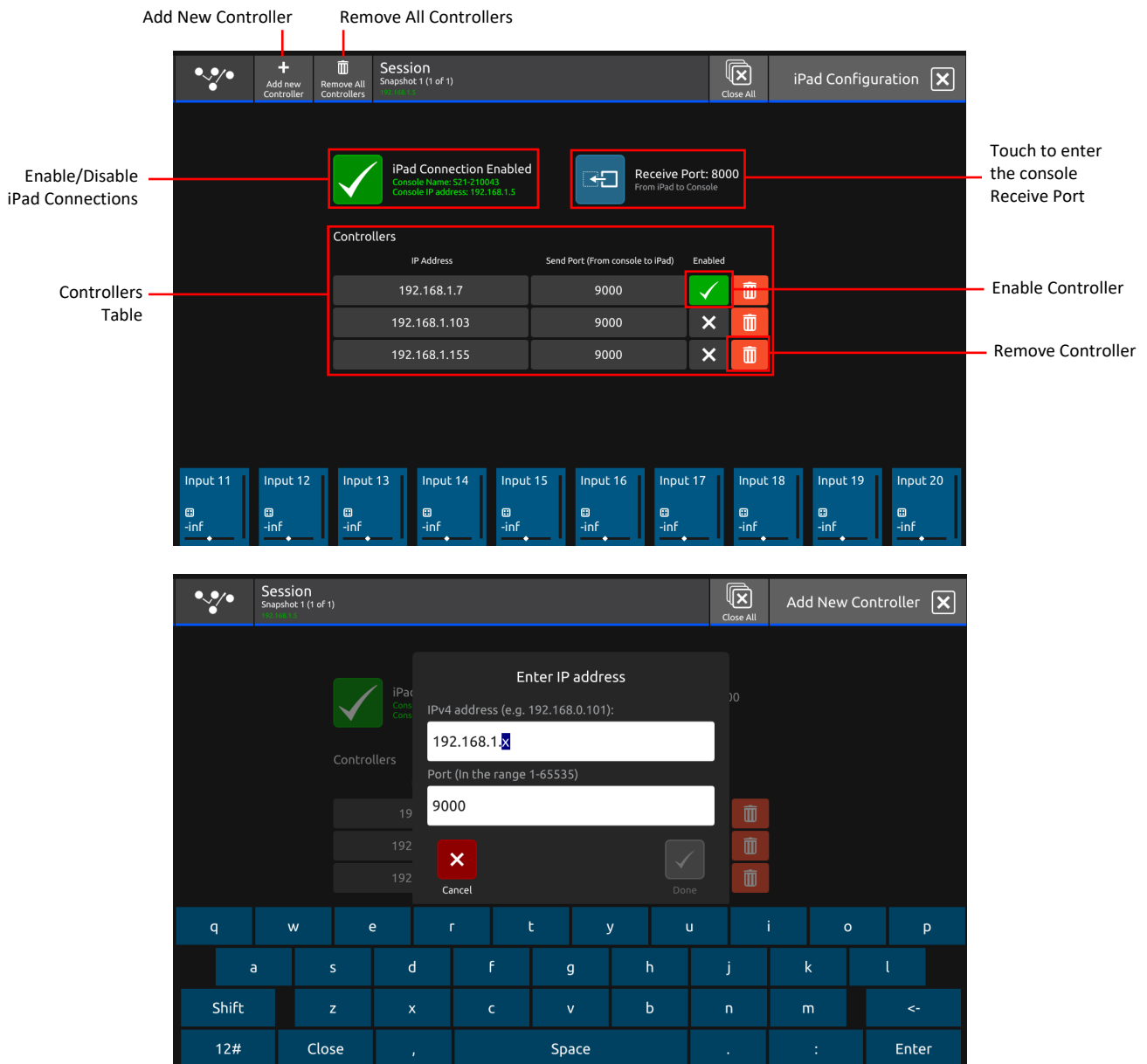

OSC Control

To connect an OSC enabled device, touch Extensions > **OSC** to enter the **OSC Configuration** view. Touch **Add New Controller** in the top left corner to add a new device. This will open a floating window where the **device's IP Address** and the **device's Receive Port** should be entered. Touch **Done** to confirm these values. This will create a new Controller row in the **Controllers Table**.

Touch the **Receive Port** button to change the **console's Receive Port**. Touch **Done** to confirm this value.

Touch the **Enable OSC Connections** button to enable any connections.

The console can be enabled to only **Send** messages to the controller, only **Receive** messages from the controller, or **both** by touching to tick the appropriate boxes in the Controller Table. Multiple OSC devices can be added to this table but only one can be enabled at any one time.

Touching the **Available OSC** button will show the list of OSC messages that the console understands.

Individual controllers can be removed from the Controllers Table by pressing the **Remove Controller** button for the appropriate controller. All controllers can be removed at once by touching the **Remove All Controllers** button at the top of the screen.

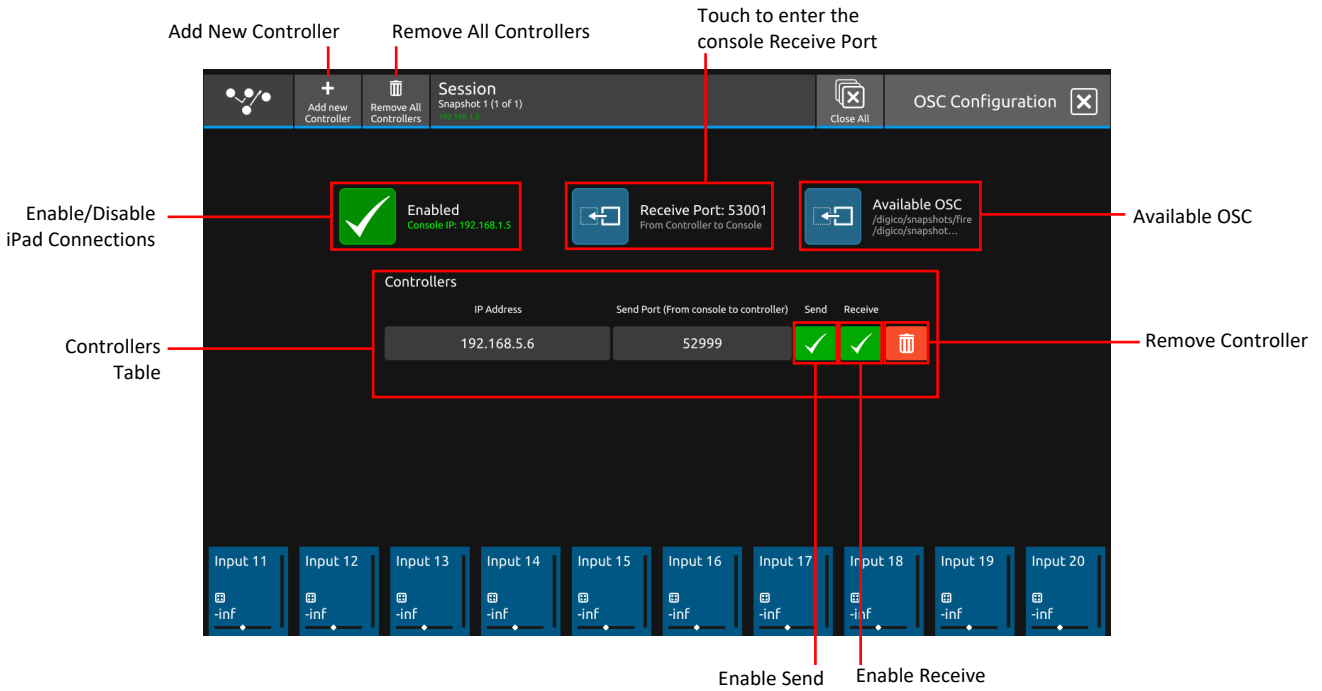

NOTE: An iPad and an OSC Control device can be used at the same time, but the console Receive Ports must be different.

NOTE: For a successful connection to an external device, the following requirements must be met:
 The device and the console must be on the same subnet mask.
 The device send port must match the console receive port.
 The device receive port must match the console send port.

Available OSC commands		
Command	Parameter	Effect
/digico/snapshots/fire	int	Fires snapshot corresponding the given parameter
/digico/snapshots/fire/next		Fires next snapshot
/digico/snapshots/fire/previous		Fires previous snapshot

1.5.19 Restart or Shutdown

Touching the Main Menu > **Restart or Shutdown** button displays a number of options for restarting, closing down and temporarily locking the console.

To Shut Down the console, first touch the **Shut Down** button and then when a power icon appears on screen, power off using the switch on the rear panel.

The console surface can be locked by touching the **Lock Surface** button and a padlock will be displayed on the screen with an instruction on how to unlock it again.

This function is simply intended to avoid accidental changes being made to worksurface and screen controls.

In the event of an issue with the console that requires a reset there are 3 options for restarting without a power cycle.

Restart - this will interrupt the audio briefly.

Warm boot - there is a small red reset button recessed on the console rear panel which will reset the console computer and will also cause a brief interruption in audio.

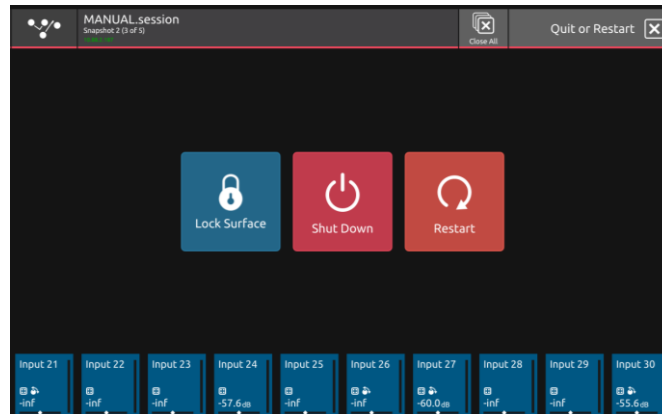

1.5.20 Upgrading Software

S-Series Software can be upgraded by downloading a file as advised by support@digiconsoles.com, copying this to a USB key and proceeding as follows:

1. Copy the downloaded file to the root folder of a USB key – ensure that it is called update.dcu
2. Switch the console off
3. Insert the USB key in the console USB port
4. Hold down the “Overview” button on the console worksurface

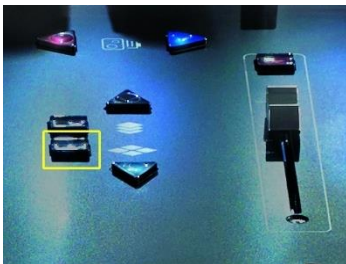

5. Switch the console on and keep the overview button held for about 5 seconds and then release it
6. You should then see a series of icons on the screen starting with a clock icon
7. Wait for the console application to boot
8. Open the main menu and check the version number at the bottom of the screen
9. Upgrade complete

1.6 DMI Cards

The DiGiCo S-Series has two option slots on its rear panel for the installation of DMI cards (see below). These cards come in a variety of I/O types.

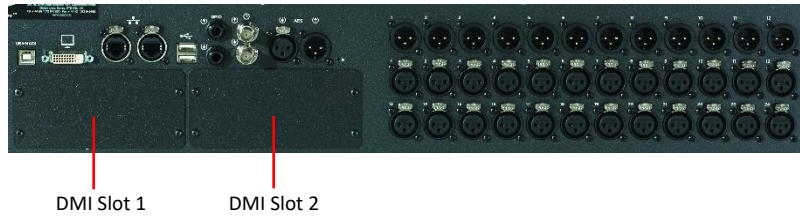

1.6.1 Fitting DMI Cards

NOTE: DMI cards are NOT hot swappable and therefore they should NEVER be fitted or removed from the S-Series console while the console is powered on.

To fit a DMI card:

- 1) Remove the four screws from the console blanking plate and this will expose a hole in the rear panel with an internal connector and a white slider on each side of the hole. Keep the four screws safe in order to secure the card in place.

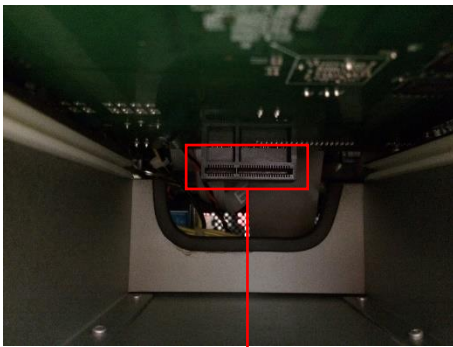

DMI Internal Socket

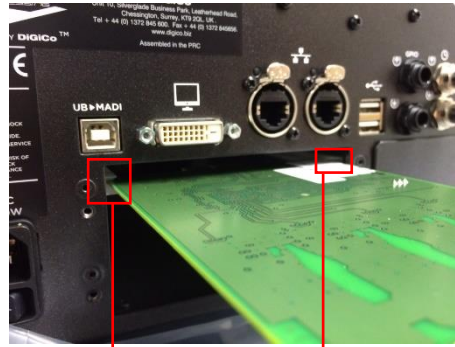

Card fits in slider grooves

NOTE: Before fitting the DMI card, carefully examine the internal connector as in some cases this may have a protective cover that must be removed before fitting the card. If the cover is present, please remove it before proceeding

NOTE: With the DMI-MADI C there are 2 internal switches that must be set to the A position for use in the S-Series console. Please check these switch positions (as picture below) before fitting the card.

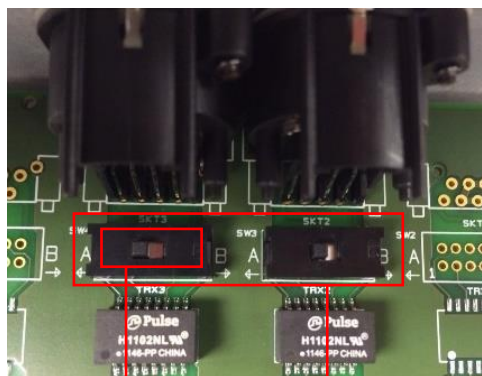

Position A for console use

DMI-MADI C internal switches

- 2) Carefully slide the DMI card in the hole using the white slider grooves as a guide and then ensure that it pushes into the internal connector correctly with a click.
- 3) Replace the 4 fitting screws.

1.7 DMI-MADI Cards

There are 2 types of DMI-MADI Card:

MADI B has 2 pairs of BNC connectors

MADI C has 2 bi-directional Cat5e connectors

Both of these cards can be used to connect a Standard MADI stream at 48KHz or 96KHz or an SD-Series DiGiCo Rack with the appropriate connector (D-Rack, D2-Rack, SD-Rack, SD-MiNiRack).

NOTE: Only one DiGiCo Rack can be connected to a single DMI-MADI card at one time.

NOTE: With S-Series software version 2.5, cable redundancy at 48KHz using both the Main and Aux MADI ports on a D2Rack, SD-Rack or SD-MiNiRack is not implemented.

1.7.1 Connecting DMI-MADI

External audio connections can be made using either BNC MADI (AES10) or the DiGiCo Cat5e Connection.

There are 2 types of MADI connection available. A DiGiCo Stage rack can be connected to a console via a bi-directional MADI connection will have up to 112 channels (56 in, 56 out) of audio plus the control data for the Rack (located on CH57). A bi-directional standard MADI stream will contain up to 128 channels of Audio (64 in, 64 out) and can be connected to any 3rd party device that has MADI connectivity.

A DiGiCo Cat5e connection is a bi-directional up to 64 Channel interface that uses STP Cat5e Cable with interference suppressors fitted on each end used to connect D-Racks and D2-Racks.

Please carefully note the following connection requirements:

DMI-MADI C to D-Rack at 48KHz

Connect DMI card Cat5e socket A to D-Rack Cat5e socket.

DMI-MADI C to D-Rack at 96KHz

Connect DMI card Cat5e socket A to D-Rack Cat5e socket.

NOTE: This setup provides one 28 channel 96kHz MADI stream therefore D-Rack input sockets 29-32 will not pass audio.

Single S-Series Console to D-Rack with DMI-MADI C Card

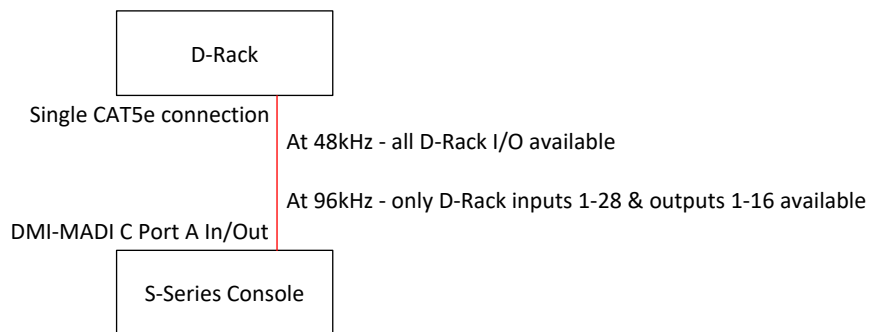

Audio Sync = MASTER

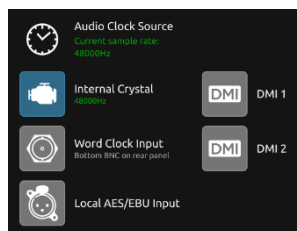

DMI-MADI C to D2-Rack at 48kHz

Connect DMI card Cat5e socket A to D2-Rack Cat5e Main socket.

Single S-Series Console to D2-Rack with DMI-MADI C Card at 48kHz

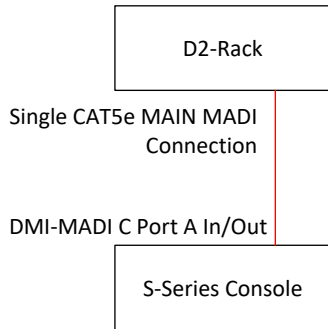

Audio Sync = MASTER

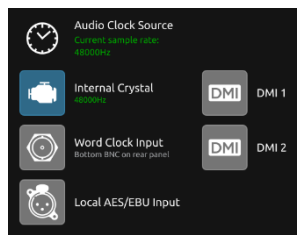

DMI-MADI C to D2-Rack at 96kHz

Connect DMI card Cat5e socket A to D2-Rack Cat5e MAIN socket.

Connect DMI card Cat5e socket B to D2-Rack Cat5e AUX socket.

Single S-Series Console to D2-Rack with DMI-MADI C Card at 96kHz

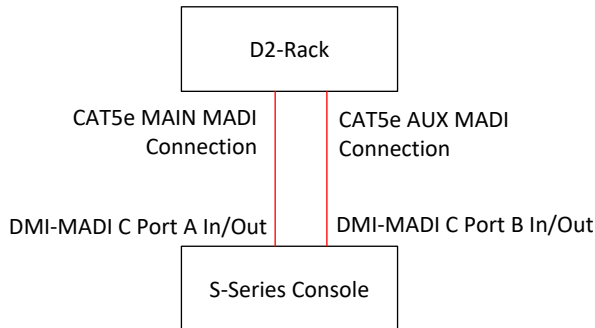

Audio Sync = MASTER

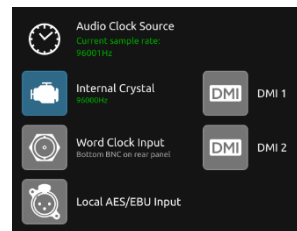

DMI-MADI B to D2-Rack, SD-Rack or SD-MiNiRack at 48kHz

Connect DMI card BNC IN socket A to D2-Rack BNC OUT MAIN socket.
 Connect DMI card BNC OUT socket A to D2-Rack BNC IN MAIN socket.

Single S-Series console to D2-Rack with DMI-MADI B Card at 48kHz

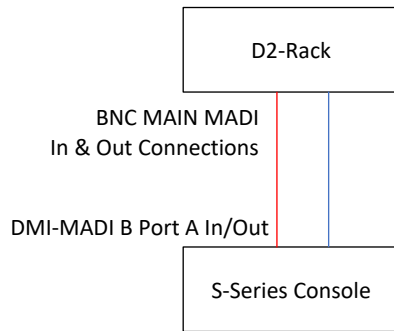

Audio Sync = MASTER

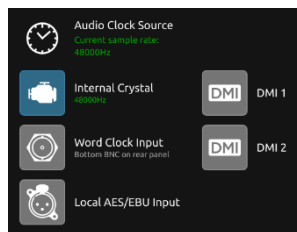

DMI-MADI B to D2-Rack, SD-Rack or SD-MiNiRack at 96kHz

Connect DMI card BNC IN socket A to D2-Rack BNC OUT MAIN socket.
 Connect DMI card BNC OUT socket A to D2-Rack BNC IN MAIN socket.
 Connect DMI card BNC IN socket B to D2-Rack BNC OUT AUX socket.
 Connect DMI card BNC OUT socket B to D2-Rack BNC IN AUX socket.

Single S-Series console to D2-Rack with DMI-MADI B Card at 96kHz

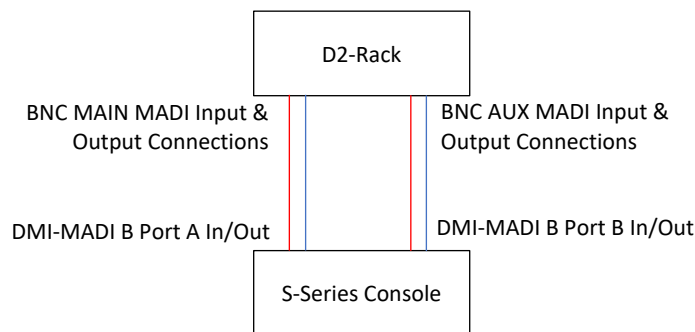

Audio Sync = MASTER

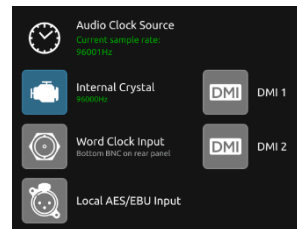

DMI-MADI B to a Standard MADI device at 48kHz

Connect DMI card BNC IN socket A to Standard MADI device BNC OUT.
 Connect DMI card BNC OUT socket A to Standard MADI device BNC IN.

DMI-MADI B to a Standard MADI device at 96kHz

Connect DMI card BNC IN socket A to Standard MADI device CH 1-32 BNC OUT.
 Connect DMI card BNC OUT socket A to Standard MADI device CH 1-32 BNC IN.
 Connect DMI card BNC IN socket B to Standard MADI device CH 33-64 BNC OUT.
 Connect DMI card BNC OUT socket B to Standard MADI device CH 33-64 BNC IN.

1.7.2 Sharing Racks with DMI-MADI

If the system is running at a sample rate of 48kHz a D2-Rack, SD-Rack or SD-MiNiRack can be shared between 2 consoles (Two S-Series consoles or an S-Series console and another SD-Series console) with the connection system shown below.

In this setup:

- 1) All inputs can be shared by the two consoles but only one console controls the rack analogue gains (the "Master" console)
- 2) The console which is not controlling the gains (the "Slave" console) can automatically adjust its digital trims to compensate for the gain changes using a system known as "Gain Tracking" (see below)
- 3) Only the "Master" console can use the outputs of the shared rack

The recommended connection between the Monitor (Slave) console and Stage Rack is a single MADI OUT from the Shared Rack's AUX MADI connected to the console's MADI A IN.

The FOH (Master console) is connected via MADI A IN and OUT to the stage rack.

A similar method can be used if the Monitor console requires gain control and the FOH console will track the gain changes. MADI OUT from the Shared Rack's AUX MADI connected to the FOH console's MADI A IN.

The Monitor (Master console) is connected via MADI A IN and OUT to the stage rack.

NOTE: The "Master" console should be set to provide "Master Sync" (Main Menu/Audio Sync view - see diagram below) to the Shared rack.

The "Slave" console should be set to receive its Audio Sync from the DMI-MADI slot that is connected to the Shared Rack.

- 1) The operators should agree on and set a level of analogue gain that provides enough headroom for the required application
- 2) The second console should connect to the Shared rack in **Receive Only** mode (only MADI Input cable connected)
- 3) **Gain Tracking** (the **GT ON/OFF** button at the top of the Input channel setup view) can be switched on for the console that is in **"Receive Only"** mode for all the channels that are being shared
- 4) When an analogue gain control is changed on the "Master" console, the "Slave" console's analogue gain should reflect the changes and the digital trim control should compensate for this change by moving by the same amount in the opposite direction

IMPORTANT NOTE: The "Slave" console's Analogue gains and +48V should not be adjusted in this setup as they will have no effect on the rack.

If these settings are adjusted on the "Slave" console they will potentially no longer reflect the actual state of the analogue gain and +48V status.

If Gain Tracking is active on a channel, the digital trim control will still respond to the local gain adjustment by compensating locally for the displayed gain change.

If the "Slave" console loads a session where the Analogue Gain and +48V settings do not match the current state of the racks, the Master console should then reload its session to update the state of these controls on the "Slave" console.

FOH & MONITORS WITH SHARED RACK at 48kHz USING MADI

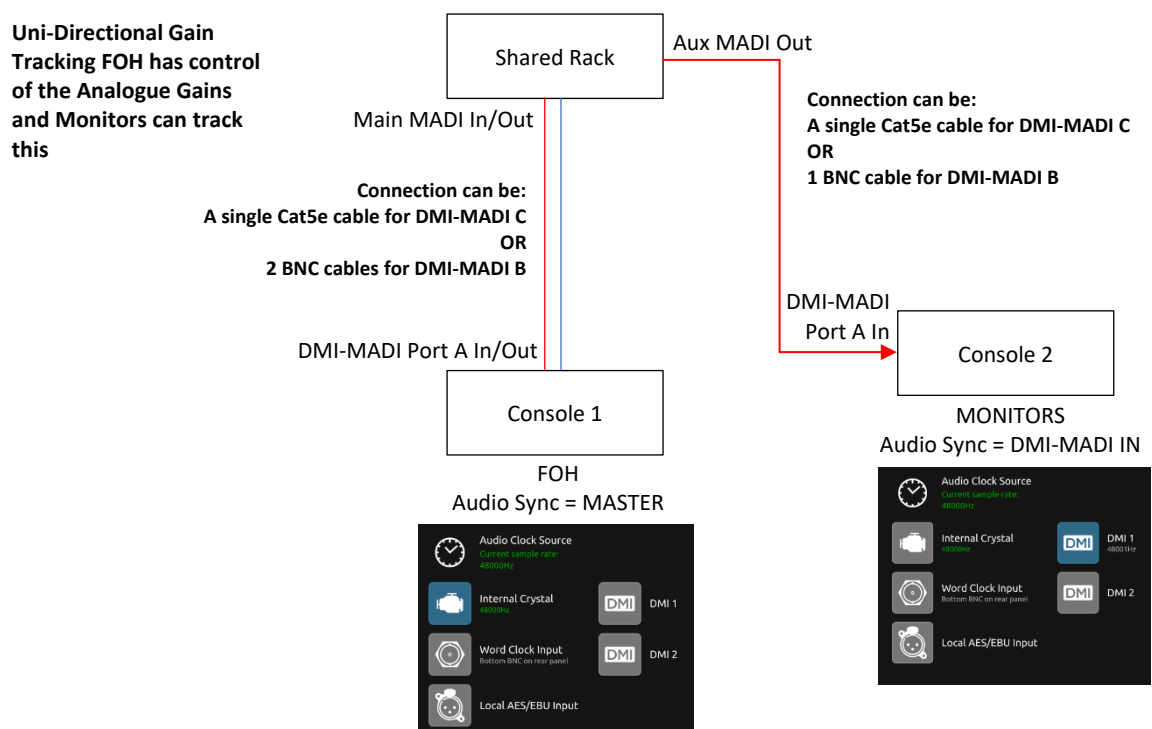

If the system is running at a sample rate of 48kHz, a D-Rack can also be shared between 2 consoles (Two S-Series consoles or an S-Series console and another SD-Series console with Cat5e connections e.g. SD9 or SD11) with the connection system shown below.

This setup is similar to the one previously described but requires a DiGiCo Little Red Box.

The Little Red Box has separate Cat5e connections for:

The D-Rack itself

The FULL CONNECT " Master" console

The RECEIVE ONLY "Slave" console

In all other respects the setup is the same as that for the D2-Rack and SD-Rack.

SHARING A D-RACK at 48kHz USING MADI

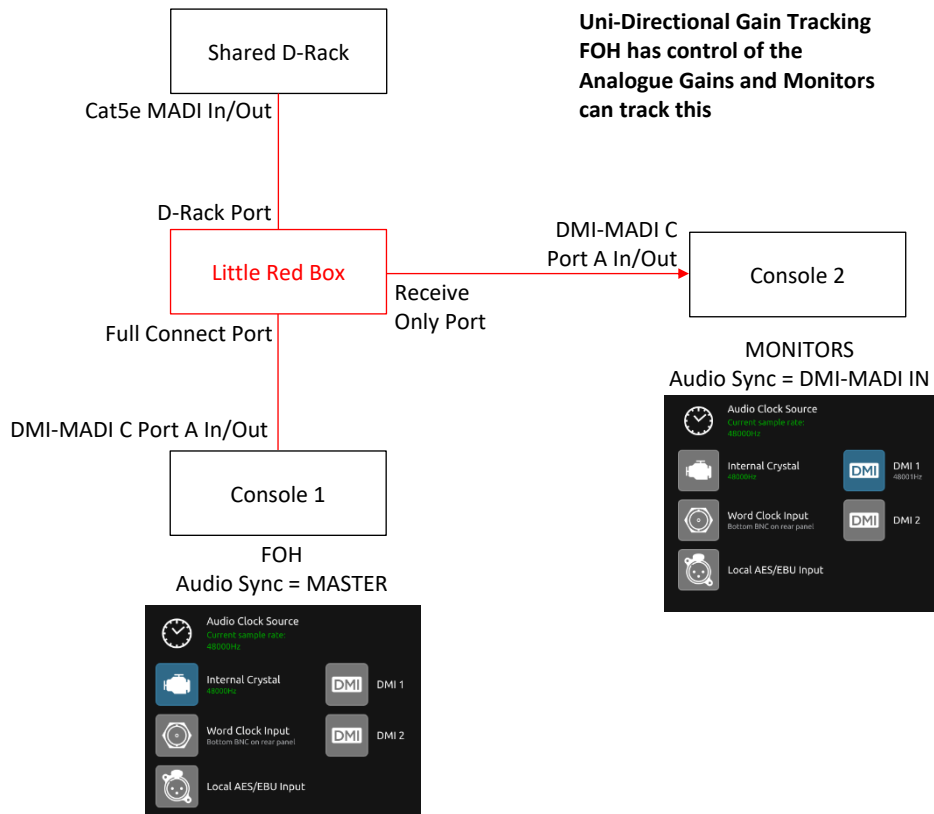

1.7.3 Auto-Discovery of DMI Cards & Racks

The S-Series consoles have a system of Auto-Discovery for DMI cards and racks connected to those cards. It is therefore essential that DMI cards and racks are all correctly connected before the system is powered on.

NOTE: DMI cards are NOT hot swappable and therefore they should NEVER be fitted or removed from the S-Series console while the console is powered on.

The correct procedure is as follows:

- 1) Power off the console
- 2) Install DMI cards as required in the console
- 3) Make all necessary connections between DMI cards and required DiGiCo Racks and other Standard MADI devices
- 4) Power on all racks and connected Standard MADI devices before powering on the console
- 5) Power on the console

When the above procedure has been completed, open the S-Series Input Routing view by touching the top of an input channel strip to display the Channel Setup view and then touch the Input Select button on the right hand side of the screen. At the bottom of the port list, the DMI cards will be displayed as DMI 1 and DMI 2 and any connected racks will also be displayed. Touch the relevant DMI card button to display and select from the available inputs. DMI card outputs will also be displayed in any of the output routing views (Direct Outputs / Insert Sends etc).

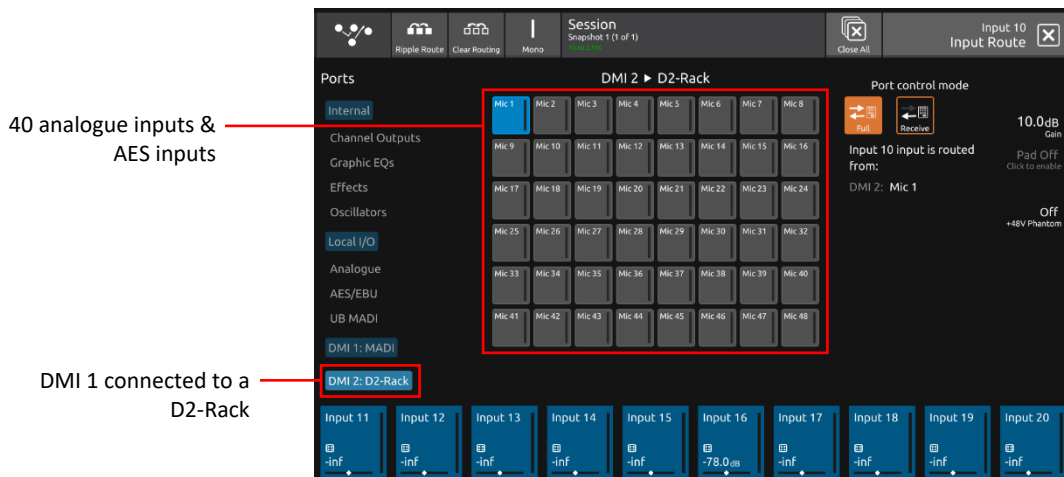

IMPORTANT NOTE: If a DMI-MADI card is connected to a rack or other Standard MADI device and the connection is changed to a different type of rack or device, the new connection will be discovered automatically after a few seconds and a Conform button will be displayed to allow the user to decide whether to accept the hardware change. Please allow enough time for the auto discovery process to complete before pressing the Conform button (approx. 30secs).

It is advisable to save your session before changing from one device type to another to ensure that the original setup can be reinstated later if required.

Conforming Racks

When an I/O Rack is connected or disconnected from the system, there is an option to **Conform** the console for the new hardware. In the following example a D-Rack is connected via a DMI-MADI card to the console on DMI Port 1 and is then disconnected (or switched off).

The console displays a prompt to allow it to Conform to the new hardware - in this case, because the D-Rack is no longer connected, the DMI-MADI card is considered to be a Standard 64 channel MADI I/O device.

If you choose to Conform for the new device, warning message is displayed and if confirmed, the port is changed accordingly.

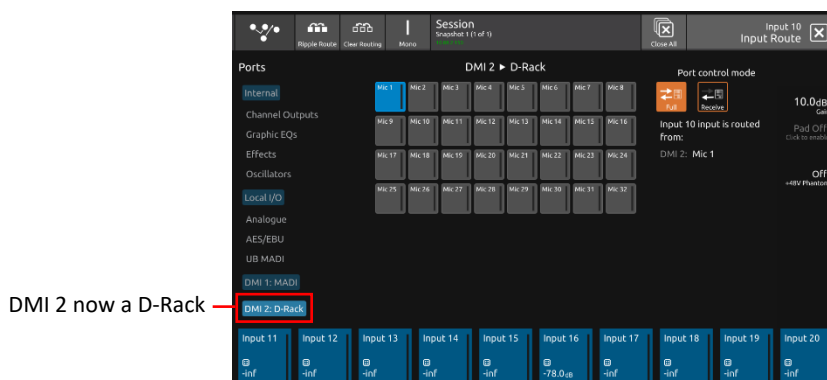
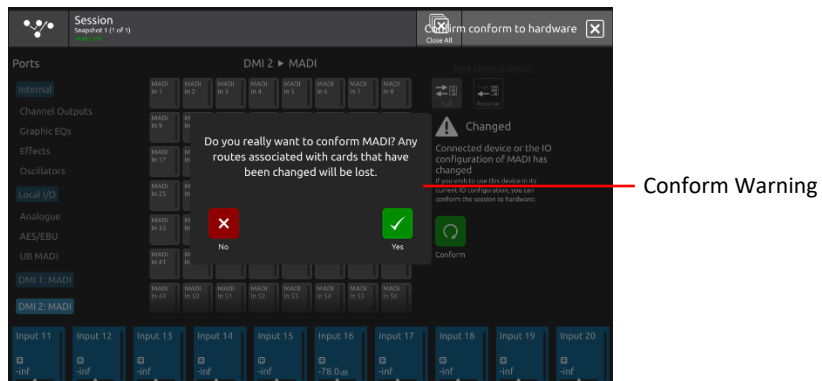
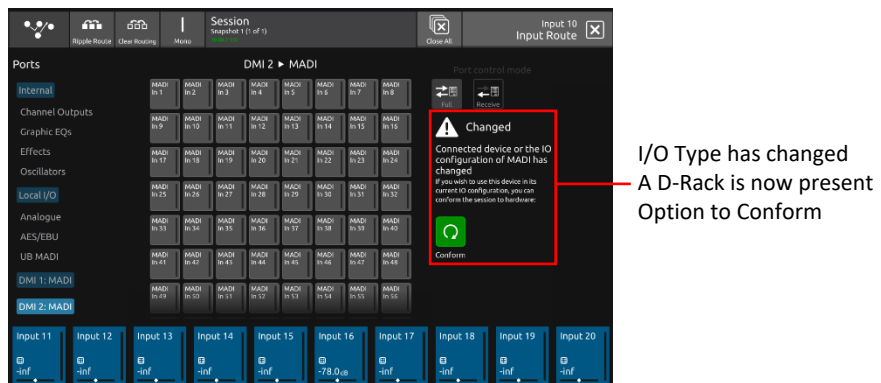
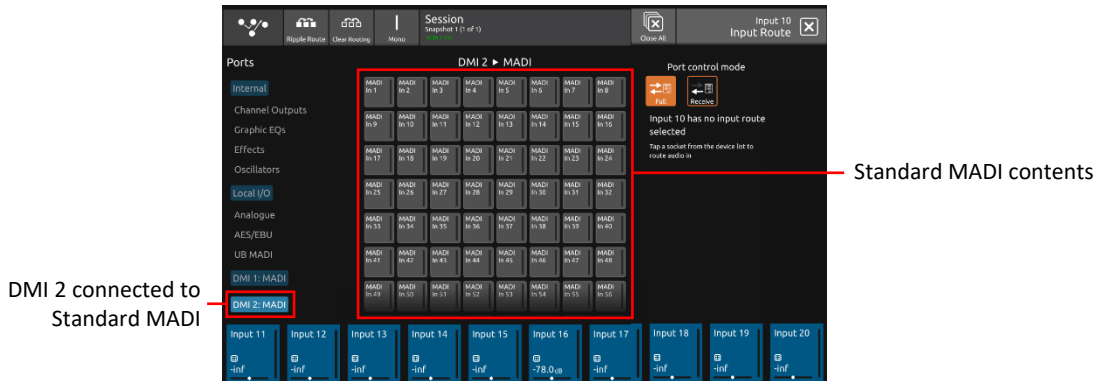

1.7.4 DiGiRack Compatibility

DiGiRacks, MADIRacks and MiNi-DiGiRacks are now recognised as valid input devices when connected to a DMI-MADI card.

VERY IMPORTANT NOTE: DiGiRacks, MADIRacks and MiNi DiGiRacks only operate at 48kHz sample rate
If one of these racks is connected when the console is running at 96kHz, it will not be recognised and a Conform will appear that cannot be confirmed until the sample rate is changed.

Only certain types of DiGiRack inputs cards will be recognised - these are Analogue In, Analogue Out, AES IN, AES Out, combined AES IN/Out and AVIOM cards - all other cards will be displayed as blank slots.

DiGiRack Analogue Input cards can be switched internally with a ribbon cable connector for either Line or Mic operation. When using inputs to these cards please ensure that the software Line/Mic switch for the socket used is in the correct position or the input will not work correctly.

DiGiRacks, MADIRacks and MiNi-DiGiRacks are connected to a DMI-MADI card in the normal way and the DMI port display in the Audio I/O view will show "DiGiRack" as the rack type in all cases.

NOTE: A MiNi-DiGiRack is always displayed as a full size DiGiRack with 7 input and 7 output slots - only the first 4 slots are populated.
This type of rack is numbered on screen reading top to bottom but the physical rack itself is numbered from bottom to top (see the following image).

Standard DiGiRack

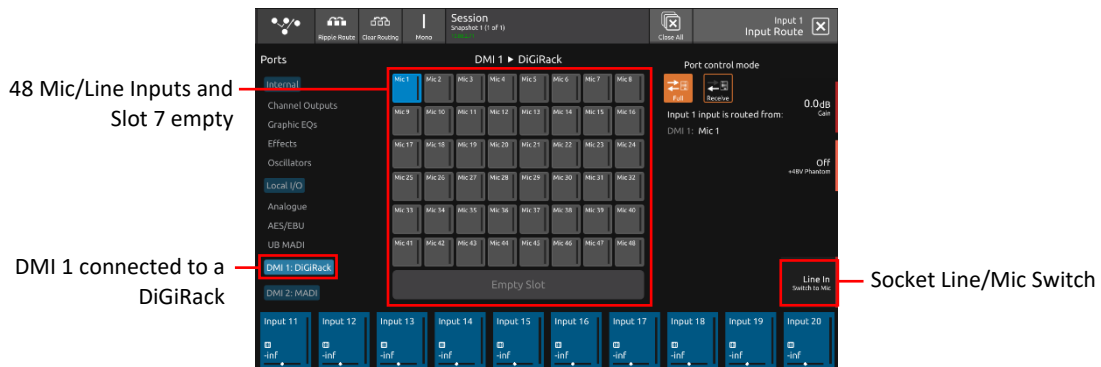

MiNi DiGiRack consists of first 4 slots in reverse order

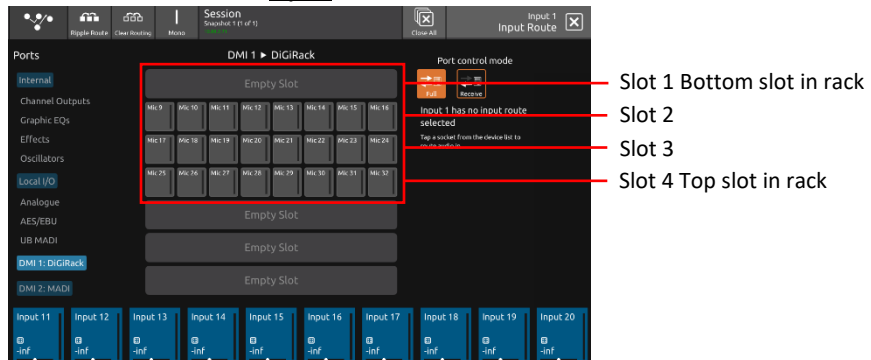

Outputs

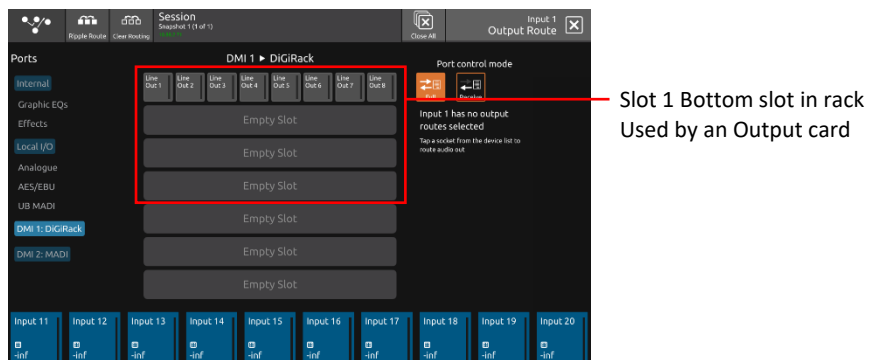

1.7.5 DMI Card Details & Upgrade

In the Main Menu > System > Hardware section there is a button which displays information about the installed DMI Cards including the current firmware dates.

This view is also used to upgrade the DMI firmware on the cards but please do not attempt to upgrade your cards unless instructed to do so by DiGiCo Support.

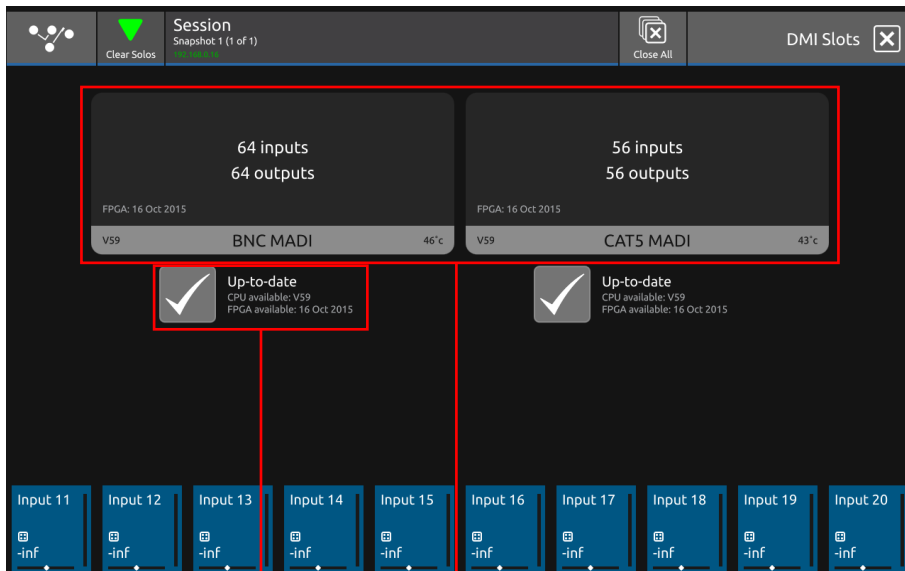
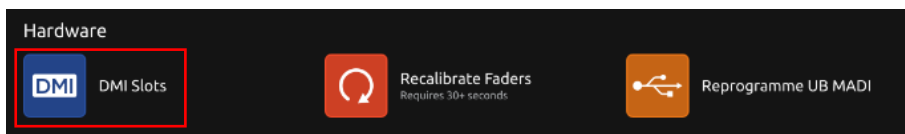
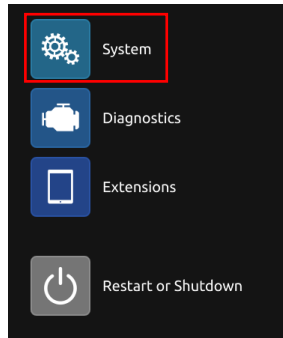

Upgrade DMI firmware

DMI Card Details

1.8 DMI - Dante Cards

A **DMI-Dante** card in an S-Series console provides 64 input and 64 output channels at 48kHz and 32 input and 32 output channels at 96kHz. It is provided with Primary and Secondary (backup) Gigabit Ethernet ports for connection to the Dante network.



A **DMI-Dante 64@96** DMI card provides 64 input and 64 output channels at 48kHz or 96kHz, along with support for SRC (Sample Rate Conversion). This enables the desk to run at a different sample rate to the Dante network.



Sample rate conversion can be enabled in the input routing page by enabling 'Auto SRC'. This will automatically switch on when necessary to convert the sample rate of the desk inputs and outputs to match the Dante network's sample rate e.g. the Dante network at 96kHz and console structured at 48kHz. SRC will not affect the number of input and output channels that can be routed.

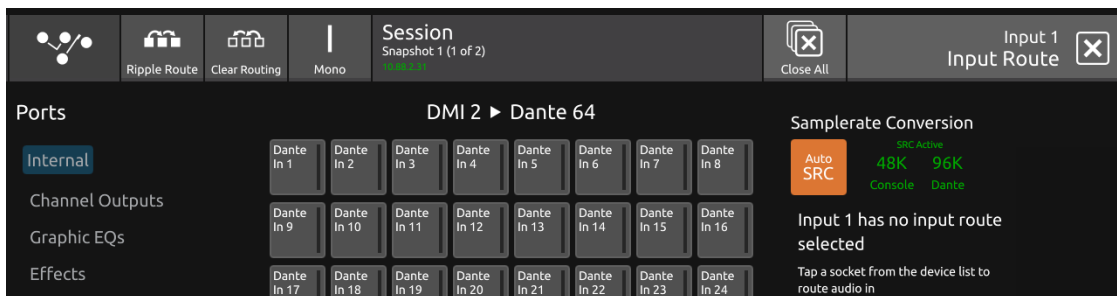

For both Dante cards, all control and configuration of the Dante interface is done externally by the Dante controller software. A separate control computer must be provided to do this.
 In S-Series, the Dante network can be set to use the console as the network system clock (in the Dante Controller software) or the Dante card can be selected as the console clock source.

In the picture below, the Dante Controller software displays two DiGiCo DMI-Dante devices.
 The second device in the list is installed in an S21 and has been manually labelled "DiGiCo S21".
 In the Dante Device Config tab the S21 DMI-Dante card must be set to match the S21 sample rate at 48kHz or 96kHz.

Example 1 - Console is Master clock for Dante Network

In the Dante Clock Status tab, the S21 DMI-Dante card is set to Sync To External and Preferred Master. This setup enables the DMI-Dante in the S21 to take its Audio Sync Source from the console itself and in turn provide sync to the rest of the Dante network. The console would typically be set as Audio Master in the Main Menu > Audio Sync panel.

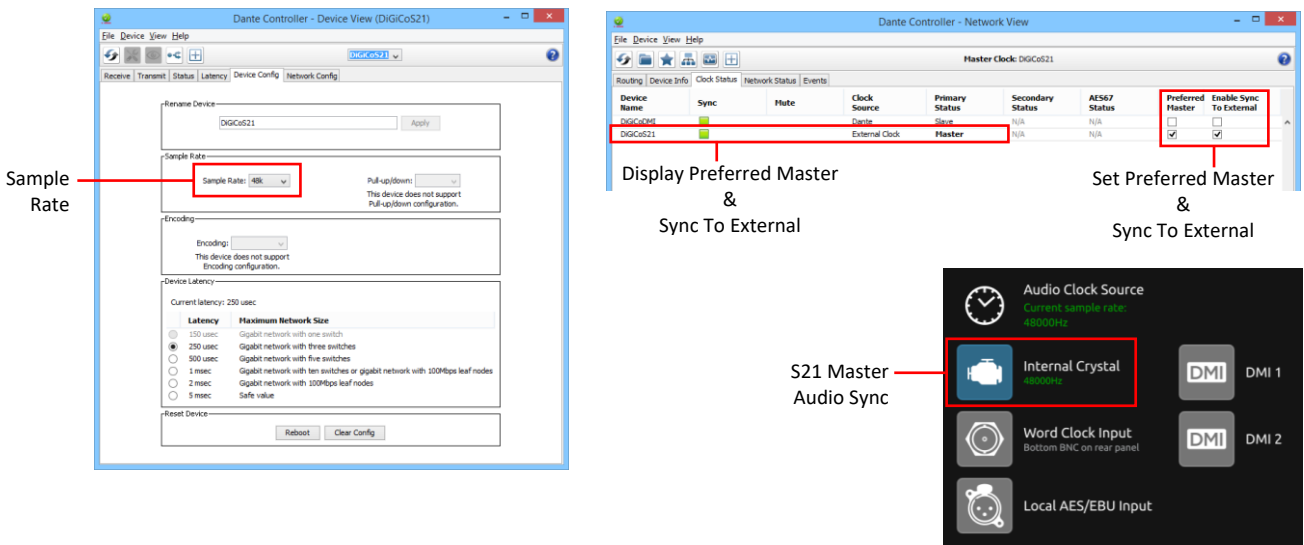

Example 2 - Dante Network is Master clock for console

If the console is required to use the Dante network as its sync source the following settings should be applied.
 Enable Sync to External = OFF

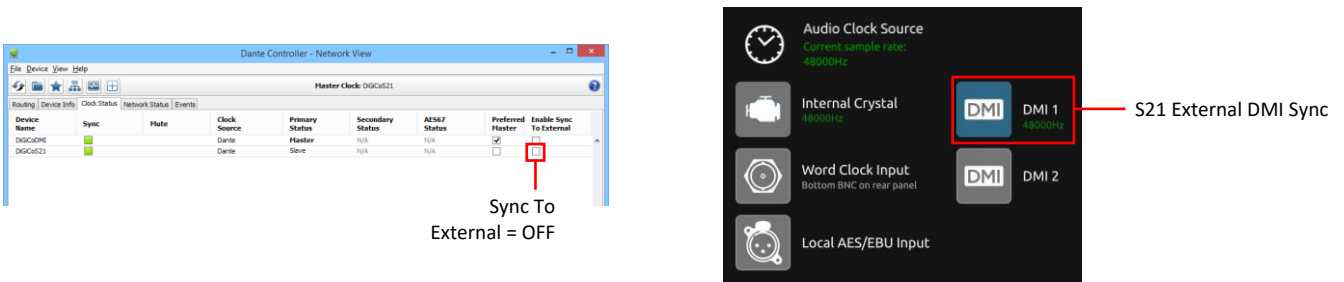

1.9 DMI - ADC - DAC - MIC - AES Cards

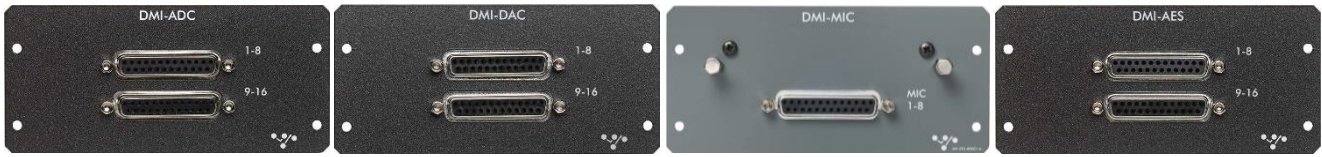

The **DMI-ADC** card provides 16 analogue inputs on 2 x 25 way "D" connectors.
 The ADC card is a line card only. There is no microphone amplifier or phantom power available.
 The S-series consoles have no gain control function for these inputs (only digital trim). Maximum input level +22dBu.

The **DMI-DAC** card provides 16 analogue outputs on 2 x 25 way "D" connectors.
 DAC card is line level only. Maximum output level +22dBu (Digital Full Scale).

The **DMI-MIC** card provides 8 microphone pre-amps on 1 x 25 way "D" connector.
 The S-Series consoles have control over phantom power, gain and pad on the card.

The **DMI-AES** card provides 16 Inputs (8 pairs) and 16 outputs (8 pairs) on 2 x 25 way "D" connectors.
 All AES inputs are provided with sample rate conversion (SRC) by default.
 All AES outputs are synchronised to the mixer system clock.

Multi-Pin Connector Pinouts

The DMI module range use 25 way "D" connectors, Female on the module (Male required on the connecting cable). The pins connections are as follows.

Analogue inputs and outputs			
Sorted by pin		Sorted by function	
Function	Pin	Function	Pin
8+	1	0	2
0	2	0	5
7-	3	0	8
6+	4	0	11
0	5	0	16
5-	6	0	19
4+	7	0	22
0	8	0	25
3-	9	1-	12
2+	10	1+	24
0	11	2-	23
1-	12	2+	10
nc	13	3-	9
8-	14	3+	21
7+	15	4-	20
0	16	4+	7
6-	17	5-	6
5+	18	5+	18
0	19	6-	17
4-	20	6+	4
3+	21	7-	3
0	22	7+	15
2-	23	8-	14
1+	24	8+	1
0	25	nc	13

AES-EBU combined in/out			
Sorted by pin		Sorted by function	
Function	Pin	Function	Pin
4out+	1	0	2
0	2	0	5
3out-	3	0	8
2out+	4	0	11
0	5	0	16
1out-	6	0	19
4in+	7	0	22
0	8	0	25
3in-	9	1in-	12
2in+	10	1in+	24
0	11	1out-	6
1in-	12	1out+	18
nc	13	2in-	23
4out-	14	2in+	10
3out+	15	2out-	17
0	16	2out+	4
2out-	17	3in-	9
1out+	18	3in+	21
0	19	3out-	3
4in-	20	3out+	15
3in+	21	4in-	20
0	22	4in+	7
2in-	23	4out-	14
1in+	24	4out+	1
0	25	nc	13

Pinout and connection notes:

0 = earth/ground or screen/shield nc = not connected + = phase/hot - = antiphase/cold

Analogue connections for input and output are connected in the same way, as shown.
 Analogue connections for channels 1-8 shown, channels 9-16 follow the same pattern (1 = 9, 2 = 10 etc.).

AES connections are shown as 4 stereo (2 channel) connections, equivalent to channels 1-8.
 AES connections for stereo connections 1-4 (ch 1-8) shown, connections stereo 5-8 (ch 9-16) follow the same pattern (1 = 5, 2 = 6 etc.).

1.10 DMI - Waves - Hydra Cards



DMI-Waves has 64 Inputs and 64 Outputs at both 48kHz and 96kHz - there is no control from the console, just simple routing of audio inputs and outputs.

Configuration of this card on the Waves network is done with Waves own software and Control Panels - please refer to Waves own documentation for SoundGrid Studio and or Waves MultiRack.

DMI-Hydra has 56 inputs and 56 Outputs and only functions when the console is at a sample rate of **48kHz** - there is no control from the console, just simple routing of audio inputs and outputs.

The ID of the card on the Hydra network can be changed from the console by touching the **Set Network ID** button, entering a new number using the on screen keyboard and the power cycling the console.

Configuration of this card on the Hydra network is done with Calrec's own software and Control Panels - please refer to Calrec's own documentation for details.

***IMPORTANT NOTE:** If a DMI-Hydra or DMI-Waves card is used in an S-Series console, the console **MUST** be set to Clock Master. The DMI-Hydra and the DMI-Waves cannot be used as a clock sources for the S-Series console itself.*

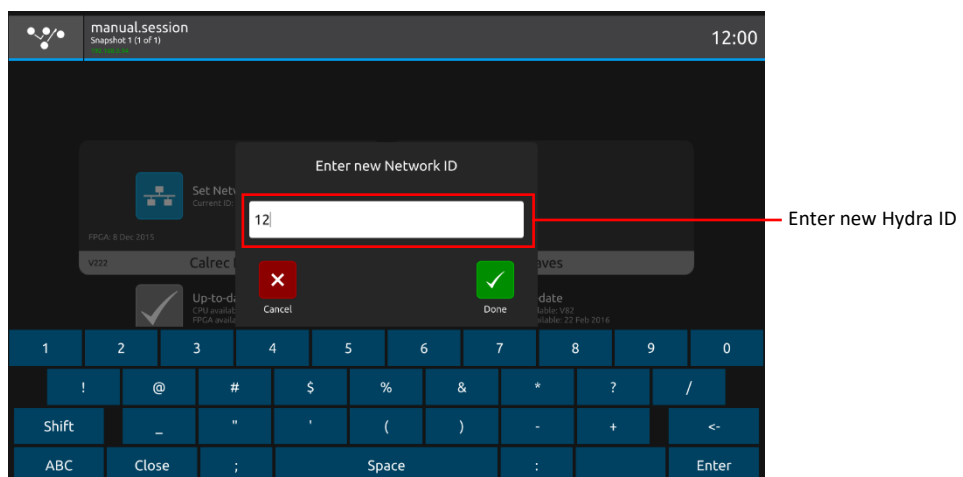
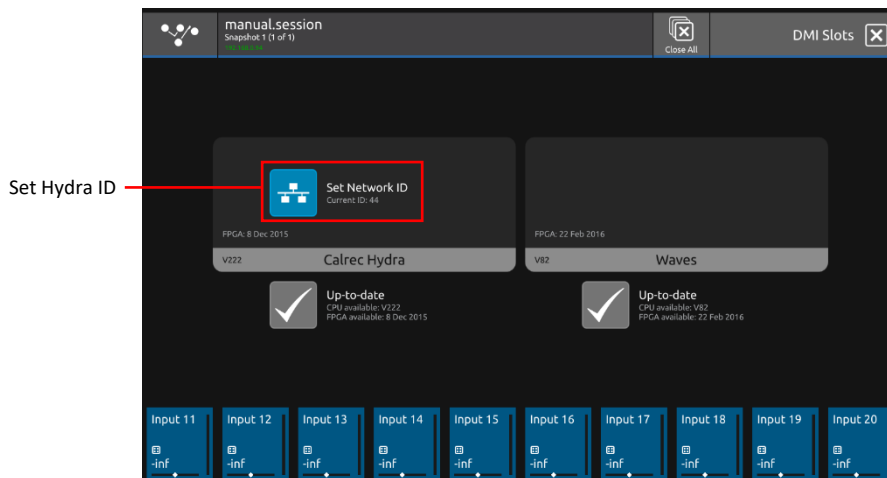

1.11 DMI - ME - A3232 Cards



The **DMI-ME** provides 40 outputs at 48kHz and 96kHz to Allen & Heath ME-1 or ME-500 Personal Mixers. There are no controls on the card.

The **DMI-A3232** allows connection to A168 STAGE Racks. Each Cat5 port supports up to 32 I/O, for a total channel count of 64 I/O. The rack can be run in two different modes. In Cascade Mode, up to two A168 racks can be connected to each port. In redundant mode, one A168 rack can be connected with redundant cabling to both ports on the card. When a DMI-A3232 is connected, each rack connected will be shown in a different view. The mode is changed by touching the desired mode in the **Port Control Mode** section. S-Series consoles have control over gain, phantom power and pads of the rack.

NOTE: When changing the Port Control Mode, there is a physical switch on the A168 STAGE racks that must also be changed.

NOTE: The primary and secondary ports on the racks are not interchangeable. The primary port must be used as the main connection.

