

Digital 7" Square (Hotplate) Magnetic Stirrer

User Manual



MS7-Pro Digital 7" Square Plate Magnetic Stirrer

MS7-H550-Pro Digital 7" Square Hotplate Magnetic Stirrer

Please read the User Manual carefully before use, and follow all operating and safety instructions!

www.scilogex.com

Contents

Preface	2	12. Associated Standards and Regulations	13
Service	2	13. Technical Data	13
Warranty	2	14. Ordering Information	15
1. Safety Instructions	3	15. Main Spare Parts	16
2. Proper use	4	15.1 Spare Parts Diagram	16
3. Inspection	5	15.2 List of Spare Parts	17
3.1 Receiving Inspection	5		
3.2 Listing of Items	5		
4. Control and Display	5		
4.1 Control Elements	5		
4.2 Display	6		
5. Trial run	7		
6. Initialization	8		
6.1 Initializing Sequence	8		
6.2 Default Settings	8		
7. Function: Heating	8		
7.1 Working with External Temperature Sensor	9		
7.2 Residual Heat Warning(Hot)	9		
7.3 Setting the Safety Temperature	10		
8. Function: Stirring	10		
9. Remote Control	10		
10. Faults	11		
11. Maintenance and Cleaning	12		

Preface

Welcome to the “Digital 7” Square (Hotplate) Magnetic Stirrer User Manual ” . Users should read this Manual carefully, follow the instructions and procedures, and be aware of all the cautions when using this instrument.

Service

When help needed, you can always contact the Service Department of manufacturer/supplier for technical support in the following ways :

SCIOLOGEX, LLC
500 Four Rod Road
Suite 122
Berlin, CT 06037
USA
Tel: 1- (860) 828-5614
Fax: 1- (860) 828-5389
E-mail: info@scilogex.com
Website: [Http://www.scilogex.com](http://www.scilogex.com)

Please provide the customer care representative with the following information:



- Serial number on the rear panel
- Description of problem (i.e.,hardware or software)
- Methods and procedures adopted to resolve the problems
- Your contact information

Warranty

You have purchased a Scilogex instrument. This instrument is warranted to be free from defects in materials and workmanship under normal use and service, for a period of 24 months from the date of invoice. The warranty is extended only to the original purchaser. It shall not apply to any product or parts which have been damaged on account of improper installation, improper connections, misuse, accident or abnormal conditions of operation.

For claims under the warranty please contact your local supplier. You may also send the instrument directly to manufacturer, enclosing the invoice copy and by giving reasons for the claim.

1. Safety Instructions

	<p>Warning!</p> <ul style="list-style-type: none"> • Read the operating instructions carefully before use. • Ensure that only trained staff works with the instrument.
	<p>Risk of burn!</p> <ul style="list-style-type: none"> • Caution when touch the housing parts and the hotplate which can reach temperature of 550°C. • Pay attention to the residual heat after switching off.
	<p>Protective ground contact!</p> <ul style="list-style-type: none"> • Make sure that socket must be grounded (protective ground contact) before use.

- Gradually increase the speed, reduce the speed if :
 - Stirring bar breaks away due to high speed
 - The instrument is not running smoothly, or container moves on the base plate
 - Temperature must always be set to at least 50°C lower than the fire point of the media used.
 - Be aware of hazards due to:
 - Flammable materials or media with a low boiling temperature
 - Overfilling of media
 - Unsafe container
 - Process pathogenic materials only in closed vessels.
 - Check the instrument and accessories prior to each use. Do not use damaged components. Safe operation is only guaranteed with the accessories described in the “Accessories” chapter. Accessories must be securely attached to the device and can not come off by themselves. Always disconnect the plug before fitting accessories.
 - Ensure that the external temperature sensor is inserted in the media to a depth of at least 20 mm.
 - When using metal vessels, do not place the temperature sensors on the bottom of the vessel. This can cause excessively high temperatures to be measured especially in media with poor conductivity.
- When working wear personal safety guards to avoid the risk from:
 - Splashing and evaporation of liquids
 - Release of toxic or combustible gases
 - Set up the instrument in a spacious area on a stable, clean, non-slip, dry and fireproof surface. Do not operate the instrument in explosive atmospheres, with hazardous substances or under water.

- The tip of the measuring sensor must be at least 5 mm from vessel bottom; a distance of 10 mm is ideal.
- The instrument can only be disconnected from the main power supply by pulling out the main or the connector plug.
- The voltage stated on the label must correspond to the main power supply.
- Ensure that the main power supply cable does not touch the hotplate. Do not cover the device.
- The instrument may only be opened by experts.
- Keep away from high magnetic field.

2. Proper use

The instrument is designed for mixing and/or heating liquids in schools, laboratories or factories.

- Observe the minimum distances between the devices, between the device and the wall and above the assembly (min. 100 mm).

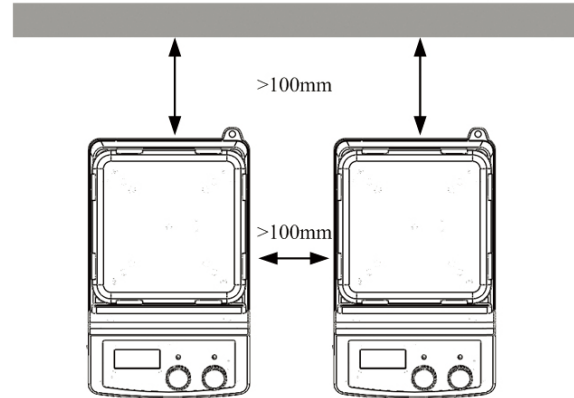

Figure 1

This device is not suitable for using in residential areas or other constraints mentioned in Chapter 1.

3. Inspection

3.1 Receiving Inspection

Unpack the equipment carefully and check for any damages which may have arisen during transport. Please contact manufacturer/supplier for technical support.



Note:

If there is any apparent damage to the system, please do not plug it into the power line.

3.2 Listing of Items

Items	Qty
Main unit	1
Power cable	1
User Manual	1

Table 1

4. Control and Display

4.1 Control elements

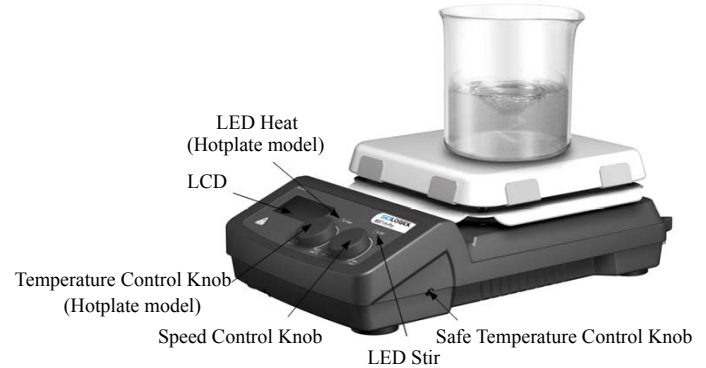

Figure 2

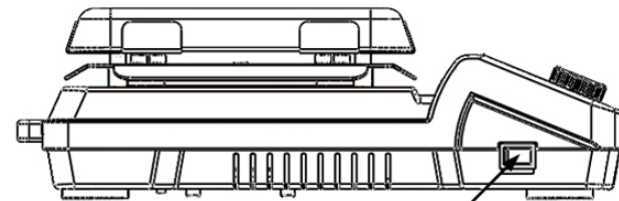

Figure 3

Power Switch

Items	Descriptions
Speed control Knob Stir	Set the rated rotary speed. The stirring function is switched ON or OFF by pushing the knob.
Temperature control knob Heat (Hotplate)	Set the rated temperature. The heating function is switched ON or OFF by pushing the knob.
LCD	LCD displays the real working state and all settings.
LED Heat(Hotplate)	When the heating function is switched
LED Stir	When the stirring function is switched ON, the LED Stir is lit.
Safe temperature control Knob	Set safety temperature, stop heating when exceed secure temperature.
Power Switch	Switch ON or OFF the instrument.

Table 2

4.2 Display

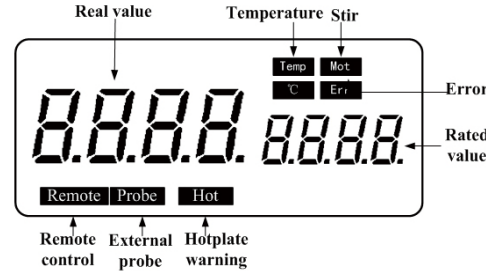



Figure 4

Character	Descriptions
Temp and °C	Display temperature when the heating function is switched ON.
Mot	Display stirring state when the stirring function is switched ON.
Hot	Display hot warning if the hotplate temperature is above 50 °C after switching OFF the heating function.
Probe	Display when using external probe.

Remote	Display in case of remote control.
Err	Display in case of error happening.
Rated value/Real value	Display value in case of heating or stirring function switching ON.

Table 3

	<p>Note: If both heating and stirring functions have been started at the same time, heating function always has higher priority. If in this case speed is changed via the stirring knob, it displays stirring speed and reverses to temperature in the duration of 5 seconds.</p>
---	--

5. Trial run

- Make sure the required operating voltage and power supply voltage match.
- Ensure the socket must be properly grounded.
- Ensure the power is off.
- Plug in the power cable, ensure the power is on and begin initializing.
- Add the medium into the vessel with a stirring bar.
- Place vessel on the work plate.
- Set the rated stirring speed and begin.
- Observe the stirring bar and LCD display.
- Set the rated temperature and start heating.
- Observe the real temperature on LCD display.
- Stop the heating and stirring functions.

If these operations above are normal, the device is ready to operate. If these operations are not normal, the device may be damaged during transportation, please contact manufacturer for technical support.

6. Initialization

6.1 Initializing sequence

- Turn on instrument by the power switch.
- The “Heat” and “Stir” LEDs and the LCD display flash about 3 times.
- LCD displays the work plate, safe temperature limit in “SAFE xxx℃” .
- LCD displays residual heat warning “rES On/OFF” .
- LCD displays stirring bar breakaway monitoring “br On/OFF” .
- LCD displays the “Probe” characters in case of connecting with external temperature sensors.

6.2 Default settings

The following table is supplied with default settings:

Items	Default settings
Setting temperature (℃)	25
Setting rotary speed (rpm)	100

Table 4

7. Function: Heating

The device is controlled by digital temperature control technology, which has two separate safe circuits. The hotplate is kept at a constant temperature by a digital control circuit. The hotplate temperature can also be monitored from a separate, adjustable safe circuit. The two temperature sensors (PT1000) internal for temperature control are built into the hotplate. The single external PT1000 can monitor the temperature of sample.

If external temperature sensors needed, it must be plugged in before the device is switched ON.

- Ensure the external temperature sensor connect firmly before heating.
- Set the temperature via turning the temperature control knob slowly to the ideal value.
- When the heating function is switched on, the LED “Heat” will light up and the LCD will display the real temperature.
- The rated temperature will be displayed on the right-hand side of the LCD as well as Temp and℃ characters.
- The heating function is switched on or off by pushing heating knob.

Instrument is turned on for the setting zone temperature setting when the last shutdown temperature, the common

case, set the heating temperature display the actual temperature may have the following differences:

- Hotplate center and outer edge.
- The sample container and the container.

In order to ensure the accuracy of the temperature inside the container, please use the external temperature sensor PT1000.

7.1 Working with external temperature sensor

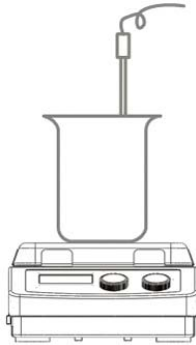

Figure 5

The external temperature sensor PT1000 is the

Manufacture' s standard accessory. If the sensor is not plugged in, "Probe" will flash. If plugged in, "Probe" will be shown on the digital display to indicate the sensor is operating. The setting value of external temperature sensors and actual temperature are displayed. Safe circuit controls hotplate temperature.

Comparing with the temperature control of the hotplate, the external temperature sensor can control the medium' s temperature more precisely.



Warning!

Do not insert or remove sensor while heating.

7.2 Residual heat warning (Hot)

In order to prevent the risk of burns from a hotplate, digital hotplate model has a residual heat warning function. When the heating function is switched off and the hotplate temperature is still above 50°C, "Hot" will flash to warn that there is a hazard of burns from the hotplate (Figure 6).When the hotplate temperature drops to below 50°C, the unit will automatically switch off. If users want to turn off the LCD immediately, just pull out the plug directly. When the plug is pulled out, the residual heat warning function can not be run.

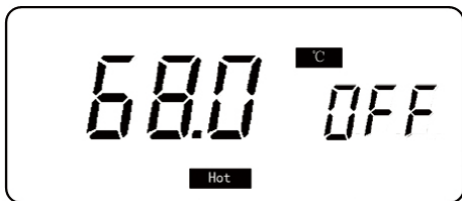

Figure 6

7.3 Setting the safety temperature

The safety temperature can be set as follows:

- Adjust the temperature setting key to set the safety temperature.

8.Function: Stirring

The function “stirring” is switched on or off via rotating stirring knob. The speed is set on the knob (100 to 1500 rpm in steps of 10 rpm).

When both of function heating and stirring are switched on and those above operations are done, the LCD will shift to the speed value and come back to the temperature value in about 5 seconds.

9. Remote control

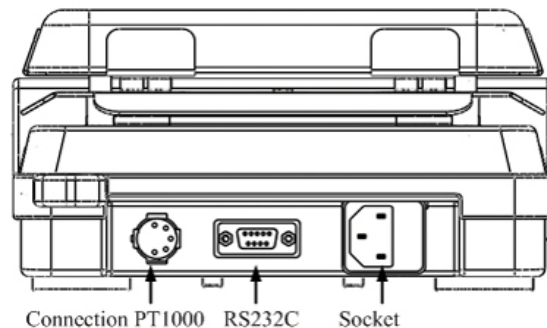

Figure 7

The unit can be controlled from an external PC (using the dedicated software) via the RS232 C serial interface fitted to the unit. Data communication from laboratory instrument to computer is only possible on demand of the computer.

- The functions of the interface lines between laboratory instrument and automation system are selected from the specified signals of the EIA-standard RS232C, corresponding with DIN66020 Part 1. The allotment of the bushing can be taken from Figure 7.
- Transmission method: Asynchronous signal transmission in start-stop-operation.
- Mode of transmission: Fully Duplex. 1start bit; 7 character bits; 1stop bit.
- Transmission speed: 9600 bit/s.
- Start remote control knob LED display “Remote” .



Note:
Forbid to insert or remove the RS232C communication line when switch on!

10. Faults

- Instruments can not be power ON
 - Check whether the power cable is plugged in

- Check whether the fuse is broken or loose
- Fault in power on self test
 - Switch OFF the unit, then switch ON and reset the instruments to factory default setting.
- Temperature can switched on not reach set point
 - Check whether the safety temperature value is set too low.
- Stir speed can not reach set point
 - Check whether the stirring bar breakaway monitoring is ON.
 - Excessive medium viscosity may cause abnormal speed reduction of the motor.
- Heating or stirring function do not start when knob is pressed.
 - Check whether the unit is in the mode setting program,
 - Exit from the mode setting and restart the heating/ stirring functions.
- Unit do not power down when switched off.
 - Check if the residual heat warning function is still ON and hotplate temperature is above 50°C (the LCD still works and “Hot” flashes).

If these faults are not resolved, please set the instruments to factory default setting or take the unit to technical service center.

11.Maintenance and Cleaning

- Proper maintenance can keep instruments working properly and lengthen its lifetime.
- Do not spray cleanser into the instrument when cleaning.
- Unplug the power line when cleaning.
- Only use recommended cleansers:

Dyes	Isopropyl alcohol
Construction materials	Water containing tenside / Isopropyl alcohol
Cosmetics	Water containing tenside / Isopropyl alcohol
Foodstuffs	Water containing tenside
Fuels	Water containing tenside

- Wear the proper protective gloves during cleaning of the instrument.
- Before using other method for cleaning or decontamination, the user must ascertain with the manufacturer that this method will not harm the instrument.
- Send in the case of service the instrument back in the

packaging carton. Storage packing is not sufficient for the back dispatch. Use additionally a suitable transportation packing.

- The enamel makes the hotplate easier to care for and more resistant to acids and bases. Because of it, however, the hotplate is also more susceptible to extreme fluctuations in temperature and the force of impact. This can result in cracks forming or the coating flaking off.



Warning!

Cut off power when maintenance and cleaning.

12. Associated standards and regulations

Construction in accordance with the following safety standards:

EN 61010-1

UL 3101-1

CAN/CSA C22.2(1010-1)

EN 61010-2-10

Construction in accordance with the following EMC standards:

EN 61326-1

Associated EU guidelines:

EMC-guidelines: 89/336/EWG

Instrument guidelines: 73/023/EWG

* The above standards will be available from July 2011.

13. Technical data

Voltage [VAC]	100-120/200-240
Frequency [Hz]	50/60
Power [W]	1050(hotplate model) 50
Stirring point position quantity	1
Max. stirring quantity (H ₂ O) [L]	20
Max. magnetic bar [mm]	80 × 10
Motor type	Brushless motor
Max. power input of motor [W]	18
Max. power output of motor [W]	10
Speed range[rpm]	100-1500
Rotary speed display	LCD
Speed display accuracy [rpm]	1
Hotplate material	Glass ceramic
Dimensions of workplate (mm)	184 × 184

Dimensions of heating (mm)	176 × 176
Heating power[W]	1000(hotplate model)
Temperature range [°C]	RT-550 (hotplate model)
Temperature display[°C]	LCD(hotplate model)
Temperature display accuracy [°C]	0.1(hotplate model)
Control accuracy of heating temperature [°C]	1(100°C below)/ ± 1%(100°C above) (hotplate model)
The safety temperature range of the hotplate [°C]	100-580 (hotplate model)
Temperature sensor in medium	PT1000 (hotplate model)
Control accuracy of heating temperature with temperature sensor [°C]	0.2(hotplate model)
Residual heat warning	50°C (hotplate model)
Dimensions (mm)	215 × 360 × 112

Weight [kg]	5.3
Permitted ambient temperature[°C]	5-40
Permitted relative humidity	80%
Protection class acc. to DIN 60529	IP21
RS232 interface	Yes

Table 5

14. Ordering information

Cat No.	Descriptions
813223009999	MS7-H550-Pro Digital 7" Square Hotplate Magnetic Stirrer, glass ceramics hotplate, USA plug, 110V/50Hz/60Hz
813223019999	MS7-H550-Pro Digital 7" Square Hotplate Magnetic Stirrer, glass ceramics hotplate, Cn plug, 220V/50Hz/60Hz
813223029999	MS7-H550-Pro Digital 7" Square Hotplate Magnetic Stirrer, glass ceramics hotplate, Euro plug, 220V/50Hz/60Hz
813223039999	MS7-H550-Pro Digital 7" Square Hotplate Magnetic Stirrer, glass ceramics hotplate, UK plug, UK plug, 220V/50Hz/60Hz
813213009999	MS7-Pro Digital 7" Square Plate Magnetic Stirrer, glass ceramics plate, USA plug, 110V/50Hz/60Hz
813213019999	MS7-Pro Digital 7" Square Plate Magnetic Stirrer, glass ceramics plate, Cn plug, 220V/50Hz/60Hz

813213029999	MS7-Pro Digital 7" Square Plate Magnetic Stirrer, glass ceramics plate, Euro plug, 220V/50Hz/60Hz
813213039999	MS7-Pro Digital 7" Square Plate Magnetic Stirrer, glass ceramics plate, UK plug, 220V/50Hz/60Hz
Accessories	
18900016	PT1000 Temperature sensor for digital hotplate model, length 230mm
18900084	PT1000 Temperature sensor for digital hotplate model, length 100mm
18900017	Support clamp of PT1000
18900002	MS135.2 Red quarter pie, 11 holes, 4 ml reaction vessel, Ø15.2mm, 20mm depth
18900003	MS135.3 Purple quarter pie, 4 holes, 20 ml reaction vessel, Ø28mm, 24mm depth
18900004	MS135.4 Blue quarter pie, 4 holes, 30 ml reaction vessel, Ø28mm, 30mm depth

18900005	MS135.5 Black quarter pie, 4 holes,40 ml reaction vessel, Ø28mm, 43mm depth
18900048	MS135.6 Green quarter pie, 6 holes, 8ml reaction vessel, Ø17.75mm, 26mm depth
18900049	MS135.7 Golden quarter pie, 4 holesØ16ml reaction vessel, Ø21.6mm, 31.7mm depth
18100319	9-Pin interface line, suitable for StirPC-V2 software.

Table 6

Note:The software StirPC-V2 can be freely downloaded from our website www.scilogex.com.

15.Main spare parts

15.1 Spare parts diagram

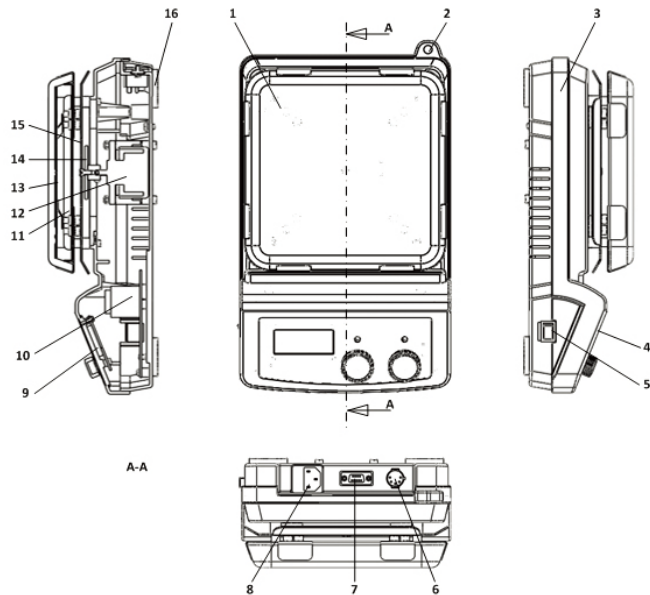

Figure 8

15.2 List of spare parts

Item	Spare parts	Item	Spare parts
1	Work plate	9	Main circuit board
2	Hole for external temperature sensor	10	Driver circuit board
3	Mains switch	11	Heating parts
4	Housing	12	Direct-current brushless motor
5	Control panel	13	Internal temperature sensor
6	External temperature sensors' socket	14	Permanent magnet
7	Remote control socket	15	Protective plate
8	Main socket	16	Rubber foot

SCIOGEX, LLC

500 Four Rod Road

Suite 122

Berlin, CT 06037

USA

Tel: 1- (860) 828-5614

Fax: 1- (860) 828-5389

E-mail: info@scilogex.com

Website: [Http://www.scilogex.com](http://www.scilogex.com)