

Panasonic®

Operating Instructions

Digital Corded/Cordless Answering System

Model No. **KX-TGF350**
KX-TGF352
KX-TG572SK
KX-TGF353



Model shown is KX-TGF350.

Before initial use, see “Getting Started” on page 8.

Thank you for purchasing a Panasonic product.

Please read these operating instructions before using the unit and save them for future reference.

Consulte “Guía Rápida Española”, página 57.

For assistance, visit our Web site: www.panasonic.com/support for customers in the U.S.A. or Puerto Rico.

Please register your product: www.panasonic.com/prodreg

Table of Contents

Introduction		
Model composition	3	
Accessory information	3	
Important Information		
For your safety	5	
Important safety instructions	6	
For best performance	6	
Other information	6	
Specifications	7	
Getting Started		
Setting up	8	
Controls	11	
Display icons	12	
Language settings	12	
Date and time	13	
Recording your greeting message	13	
Other settings	13	
Making/Answering Calls		
Making calls	14	
Answering calls	15	
Useful features during a call	15	
Intercom		
Intercom	18	
Call Block		
Using the [CALL BLOCK] button	19	
Storing unwanted callers	19	
Phonebook		
Phonebook	22	
Speed dial	24	
One-touch dial buttons	25	
Programming		
Menu list	27	
Alarm	32	
Silent mode	33	
Baby monitor	33	
Other programming	35	
Registering a unit	36	
Caller ID Service		
Using Caller ID service	37	
Caller list	37	
Answering System		
Answering system	39	
Turning the answering system on/off	39	
Greeting message	39	
Listening to messages	40	
Advanced new message alerting features	41	
Remote operation	43	
Answering system settings	44	
Useful Information		
Voicemail service	46	
Wall mounting	47	
Error messages	49	
Troubleshooting	49	
FCC and other information	54	
Guía Rápida Española		
Guía Rápida Española	57	
Appendix		
Customer services	61	
Warranty (For United States and Puerto Rico)	62	
Index		
Index	64	

Model composition

Series	Model No.	Base unit	Handset	Quantity
		Part No.	Part No.	
KX-TGF350 series	KX-TGF350	KX-TGF350	KX-TGFA30	1
	KX-TGF352	KX-TGF350	KX-TGFA30	2
	KX-TG572SK	KX-TGF350	KX-TGFA30	2
	KX-TGF353	KX-TGF350	KX-TGFA30	3

Accessory information

Supplied accessories

No.	Accessory item/Part number	Quantity		
		KX-TGF350	KX-TGF352 KX-TG572SK	KX-TGF353
①	AC adaptor/PNLV226Z	1	1	1
②	Telephone line cord*1	1	1	1
③	Desk stand/Wall mounting adaptor*2, *3	1	1	1
④	Corded handset*4	1	1	1
⑤	Corded handset cord*5	1	1	1
⑥	Rechargeable batteries*6	2	4	6
⑦	Handset cover*7, *8	1	2	3
⑧	Belt clip*9	1	2	3
⑨	Charger*10	1	2	3

*1 PQJA10075Z (Transparent cord), PQJA10075Y (Black cord)

*2 The desk stand/wall mounting adaptor comes attached to the base unit.

*3 PNKL1051Z2 (White), PNKL1051Z1 (Black)

*4 PNLXP1012Y (Champagne gold), PNLXP1005Y (Metallic black)

*5 PQJA212M (White), PQJA212V (Black)

*6 See page 4 for replacement battery information.

*7 The handset cover comes attached to the handset.

*8 PNYNTGFA30NR (White), PNYNTGA680BR (Black)

*9 PNKE1268Z3 (White), PNKE1268Z1 (Black)

*10 PNLC1040ZN (Champagne gold), PNLC1040ZB (Black)

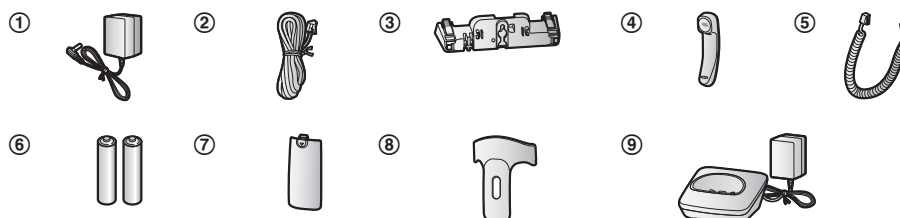

For assistance, please visit www.panasonic.com/support

3

Introduction

Additional/replacement accessories

Please contact your nearest Panasonic dealer for sales information (page 61).

Accessory item	Model number/Specifications
Rechargeable batteries	HHR-4DPA*1 ● To order, please visit www.panasonic.com/batterystore
	Battery type: – Nickel metal hydride (Ni-MH) – 2 x AAA (R03) size for each handset
Headset	KX-TCA60, KX-TCA93, KX-TCA400, KX-TCA430
T-adaptor	KX-J66
Range extender	KX-TGA405*2
Key detector	KX-TGA20*3

*1 Replacement batteries may have a different capacity from that of the supplied batteries.

*2 By installing this unit, you can extend the range of your phone system to include areas where reception was previously not available. This product can be purchased online. Please visit our Web site: www.panasonic.com/RangeExtender

*3 By registering the key detector (4 max.) to a Panasonic Digital Cordless Phone and attaching it to an easy-to-lose item in advance, you can locate and find the mislaid item to which the key detector is attached. Please visit our Web site: www.panasonic.net/pcc/products/telephone/p/tga20/

Other information

- Design and specifications are subject to change without notice.
- The illustrations in these instructions may vary slightly from the actual product.

Expanding your phone system

Handset (optional): KX-TGFA30	
You can expand your phone system by registering optional handsets (6 max.) to a single base unit. ● Optional handsets may be a different color from that of the supplied handsets.	

For your safety

To prevent severe injury and loss of life/property, read this section carefully before using the product to ensure proper and safe operation of your product.

WARNING

Power connection

- Use only the power source marked on the product.
- Do not overload power outlets and extension cords. This can result in the risk of fire or electric shock.
- Completely insert the AC adaptor/power plug into the power outlet. Failure to do so may cause electric shock and/or excessive heat resulting in a fire.
- Regularly remove any dust, etc. from the AC adaptor/power plug by pulling it from the power outlet, then wiping with a dry cloth. Accumulated dust may cause an insulation defect from moisture, etc. resulting in a fire.
- Unplug the product from power outlets if it emits smoke, an abnormal smell, or makes an unusual noise. These conditions can cause fire or electric shock. Confirm that smoke has stopped emitting and contact us at www.panasonic.com/contactinfo
- Unplug from power outlets and never touch the inside of the product if its casing has been broken open.
- Never touch the plug with wet hands. Danger of electric shock exists.

Installation

- To prevent the risk of fire or electrical shock, do not expose the product to rain or any type of moisture.
- Do not place or use this product near automatically controlled devices such as automatic doors and fire alarms. Radio waves emitted from this product may cause such devices to malfunction resulting in an accident.
- Do not allow the AC adaptor or telephone line cord to be excessively pulled, bent or placed under heavy objects.

Operating safeguards

- Unplug the product from power outlets before cleaning. Do not use liquid or aerosol cleaners.
- Do not disassemble the product.
- Do not spill liquids (detergents, cleansers, etc.) onto the telephone line cord plug, or allow it to become wet at all. This may cause a fire. If the telephone line cord plug becomes wet, immediately pull it from the telephone wall jack, and do not use.
- Do not excessively pull the corded handset cord from the base unit. This may cause the base unit to fall, resulting in injury.

Medical

- Consult the manufacturer of any personal medical devices, such as pacemakers or hearing aids, to determine if they are adequately shielded from external RF (radio frequency) energy. (The product operates in

the frequency range of 1.92 GHz to 1.93 GHz, and the RF transmission power is 115 mW (max.)

- Do not use the product in health care facilities if any regulations posted in the area instruct you not to do so. Hospitals or health care facilities may be using equipment that could be sensitive to external RF energy.

CAUTION

Installation and location

- Never install telephone wiring during an electrical storm.
- Never install telephone line jacks in wet locations unless the jack is specifically designed for wet locations.
- Never touch uninsulated telephone wires or terminals unless the telephone line has been disconnected at the network interface.
- Use caution when installing or modifying telephone lines.
- The AC adaptor is used as the main disconnect device. Ensure that the AC outlet is installed near the product and is easily accessible.
- This cordless handset is unable to make calls when:
 - the handset batteries need recharging or have failed.
 - there is a power failure.

Ni-MH rechargeable batteries

- We recommend using the batteries noted on page 4. **USE ONLY rechargeable Ni-MH batteries AAA (R03) size.**
- Do not mix old and new batteries.
- Do not open or mutilate the batteries. Released electrolyte from the batteries is corrosive and may cause burns or injury to the eyes or skin. The electrolyte is toxic and may be harmful if swallowed.
- Exercise care when handling the batteries. Do not allow conductive materials such as rings, bracelets, or keys to touch the batteries, otherwise a short circuit may cause the batteries and/or the conductive material to overheat and cause burns.
- Charge the batteries provided with or identified for use with this product only, in accordance with the instructions and limitations specified in this manual.
- Only use a compatible base unit (or charger) to charge the batteries. Do not tamper with the base unit (or charger). Failure to follow these instructions may cause the batteries to swell or explode.

Attention:



A nickel metal hydride battery that is recyclable powers the product you have purchased. Please call 1-800-8-BATTERY (1-800-822-8837) for information on how to recycle this battery.

Important Information

Note when using alkaline batteries for power backup

- The batteries should be used correctly, otherwise the unit may be damaged due to battery leakage.
- Do not charge, short-circuit, disassemble, or heat the batteries.
- Do not dispose of batteries in a fire.
- Remove all the batteries when replacing.
- Do not mix old, new or different types of batteries.
- It is recommended that batteries are replaced annually.
- It is recommended that batteries are replaced after a power outage.

Important safety instructions

When using your product, basic safety precautions should always be followed to reduce the risk of fire, electric shock, and injury to persons, including the following:

1. Do not use this product near water for example, near a bathtub, washbowl, kitchen sink, or laundry tub, in a wet basement or near a swimming pool.
2. Avoid using a telephone (other than a cordless type) during an electrical storm. There may be a remote risk of electric shock from lightning.
3. Do not use the telephone to report a gas leak in the vicinity of the leak.
4. Use only the power cord and batteries indicated in this manual. Do not dispose of batteries in a fire. They may explode. Check with local codes for possible special disposal instructions.

SAVE THESE INSTRUCTIONS

For best performance

Base unit location/avoiding noise

The base unit and other compatible Panasonic units use radio waves to communicate with each other.

- For maximum coverage and noise-free communications, place your base unit:
 - at a convenient, high, and central location with no obstructions between the cordless handset and base unit in an indoor environment.
 - away from electronic appliances such as TVs, radios, personal computers, wireless devices, or other phones.
 - facing away from radio frequency transmitters, such as external antennas of mobile phone cell stations. (Avoid putting the base unit on a bay window or near a window.)
- Coverage and voice quality depends on the local environmental conditions.
- If the reception for a base unit location is not satisfactory, move the base unit to another location for better reception.

Environment

- Keep the product away from electrical noise generating devices, such as fluorescent lamps and motors.
- The product should be kept free from excessive smoke, dust, high temperature, and vibration.
- The product should not be exposed to direct sunlight.

- Do not place heavy objects on top of the product.
- When you leave the product unused for a long period of time, unplug the product from the power outlet.
- The product should be kept away from heat sources such as heaters, kitchen stoves, etc. It should not be placed in rooms where the temperature is less than 0 °C (32 °F) or greater than 40 °C (104 °F). Damp basements should also be avoided.
- The maximum calling distance may be shortened when the product is used in the following places: Near obstacles such as hills, tunnels, underground, near metal objects such as wire fences, etc.
- Operating the product near electrical appliances may cause interference. Move away from the electrical appliances.

Routine care

- Wipe the outer surface of the product with a soft moist cloth.
- Do not use benzene, thinner, or any abrasive powder.

Other information

CAUTION: Risk of explosion if battery is replaced by an incorrect type. Dispose of used batteries according to the instructions.

Notice for product disposal, transfer, or return

- This product can store your private/confidential information. To protect your privacy/confidentiality, we recommend that you erase information such as phonebook or caller list entries from the memory before you dispose of, transfer, or return the product.

Notice

- This product is designed for use in the United States of America. Sale or use of this product in other countries may violate local laws.
- Cet appareil est conçu pour être utilisé aux États-Unis d'Amérique. La vente ou l'emploi de cet appareil dans certains autres pays peut constituer une infraction à la législation locale.
- Este producto está diseñado para usarse en los Estados Unidos de América. La venta o el empleo de este producto en ciertos países puede constituir violación de la legislación local.
- 本產品專為美國使用而設。若在其他國家銷售或使用，可能會違反當地法例。
- この製品は、日本国外での使用を目的として設計されており、日本国内での使用は法律違反となります。従って、当社では日本国内においては原則として修理などのサービスは致しかねます。

Specifications

- **Standard:**
DECT 6.0 (Digital Enhanced
Cordless Telecommunications 6.0)
- **Frequency range:**
1.92 GHz to 1.93 GHz
- **RF transmission power:**
115 mW (max.)
- **Power source:**
120 V AC, 60 Hz
- **Power consumption:**
Base unit:
Standby: Approx. 0.7 W
Maximum: Approx. 3.0 W
Charger:
Standby: Approx. 0.1 W
Maximum: Approx. 1.8 W
- **Operating conditions:**
0 °C – 40 °C (32 °F – 104 °F), 20 % – 80 % relative air
humidity (dry)

Getting Started

Setting up

Connections

■ Base unit

- ① Connect the AC adaptor to the unit by pressing the plug firmly.
- ② Connect the telephone line cord to the unit until you hear a click.
- ③ Fasten the AC adaptor cord and the telephone line cord by hooking it.
- ④ Connect the AC adaptor to the power outlet.
- ⑤ Connect the telephone line cord to the single-line telephone jack (RJ11C) until you hear a click.
- ⑥ A DSL/ADSL filter (not supplied) is required if you have a DSL/ADSL service.
- ⑦ Connect the corded handset cord to the corded handset and the base unit until you hear a click.

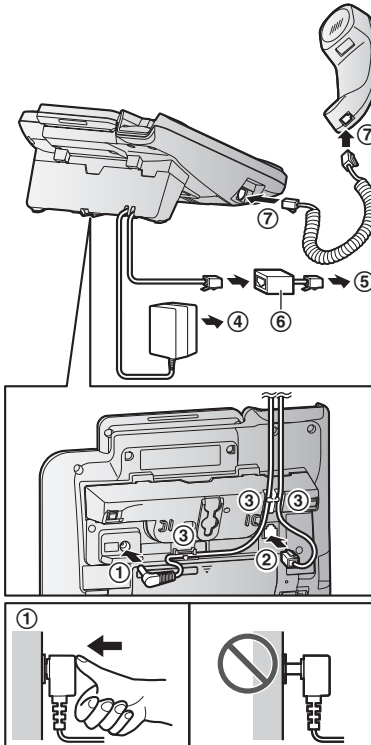

Note:

- Use only the supplied Panasonic AC adaptor PNLV226.

- Follow the directions on the display to set up the unit.

■ Charger

- ① Connect the AC adaptor to the power outlet.

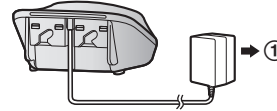

Handset battery installation

- USE ONLY rechargeable Ni-MH batteries AAA (R03) size (A).
- Do NOT use alkaline/manganese/Ni-Cd batteries.
- Confirm correct polarities (+, -).

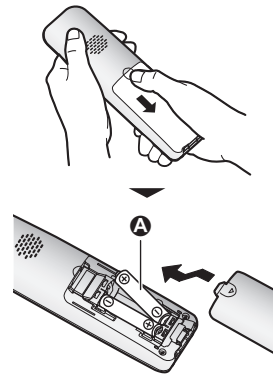

- Follow the directions on the display to set up the unit.

Handset battery charging

Charge for about 7 hours.

- Confirm “Charging” is displayed (A).
- When the batteries are fully charged, “Fully charged” is displayed.



Handset battery level

Icon	Battery level
	High
	Medium
	Low
	Needs charging.
	Empty

Panasonic Ni-MH battery performance (supplied batteries)

Operation	Operating time
In continuous use	13 hours max.*1
Not in use (standby)	12 days max.*1

*1 If eco mode is on.

Note:

- Actual battery performance depends on usage and ambient environment.

Base unit battery installation (for power backup)

You can insert 2 AAA (R03) batteries (not supplied) into the base unit that will power the unit temporarily in the event of a power failure.

Important:

- The following batteries can be used with the base unit:
 - Rechargeable Ni-MH batteries*1, *2 (including the batteries used in your handset(s))

– Standard (non-rechargeable) alkaline batteries*3

- Do NOT use manganese batteries.
- Confirm correct polarities (+, -).

*1 The base unit can fully charge Ni-MH batteries in about 15 hours.

*2 We recommend using HHR-4DPA batteries (page 4).

*3 Only insert alkaline batteries once a power failure occurs. Remove the alkaline batteries when power is restored.

- 1 Disconnect the telephone line cord (1).
- 2 Open the battery cover (2).
- 3 Install the batteries in the battery compartment (3).
- 4 Close the cover, then reconnect the telephone line cord (4).

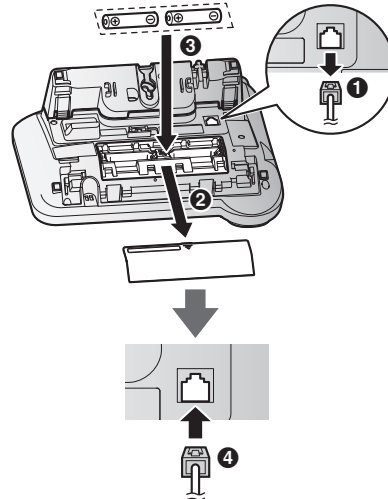

Note:

- If your phone service provider requires additional devices in order to make and receive calls, such as a modem, you may still not be able to make and receive calls even if the base unit's backup power feature is functioning.

Base unit battery status when a power failure occurs

Icon	Battery status
	Power backup mode is on.
	Battery power is low.*1

Getting Started

- *1 If  begins flashing on the base unit, replace the batteries with new ones as soon as possible. If you replace Ni-MH batteries with alkaline batteries, insert the Ni-MH batteries into the base unit again after the power is restored so that they will be recharged.

Battery saving mode setting

This feature allows the base unit to reduce its power consumption by limiting the available functions and therefore extend battery life during a power failure.

The following settings are available:

- “On”: The unit will work as a standard telephone. Only the corded handset can be used to make and receive calls. (You cannot use the base unit display, phonebook, one-touch dial, answering system, speakerphone, etc.)
The base unit display is blank.
- “OFF” (default): You can use the full functions of the base unit, but battery life is not extended. The brightness level for the base unit display is lowered.

Base unit

- 1 [MENU] [#] 1 5 0
- 2 [↕]: Select the desired setting.
- 3 [SAVE] → [EXIT]

Note:

- Once the battery saving mode is set to “On”, the unit rings with the volume level 1 even if the ringer volume for the base unit is set to “OFF” to let you know an incoming call is being received.

Panasonic Ni-MH battery performance (optional batteries) when operating on backup battery power

Operation	Saving mode	
	Off	On
In continuous use	2 hours max.	7 hours max.
Not in use (standby)	3 hours max.	8 hours max.

Note:

- Battery performance depends on the type of batteries.
- Actual battery performance depends on usage and ambient environment.

Note when setting up

Note for connections

- The AC adaptor must remain connected at all times. (It is normal for the adaptor to feel warm during use.)
- The AC adaptor should be connected to a vertically oriented or floor-mounted AC outlet. Do not connect the AC adaptor to a ceiling-mounted AC outlet, as the weight of the adaptor may cause it to become disconnected.

Note for Ni-MH battery installation

- **Handset:** Use the supplied rechargeable batteries.
- **Handset/Base unit:** For replacement, we recommend using the Panasonic rechargeable batteries noted on page 4, 5.

Note for battery charging

- It is normal for the handset to feel warm during charging.
- Clean the charge contacts of the handset, base unit, and charger with a soft and dry cloth once a month. Before cleaning the unit, disconnect from power outlets and any telephone line cords. Clean more often if the unit is exposed to grease, dust, or high humidity.

Intelligent eco mode

This feature automatically reduces handset power consumption by suppressing handset transmission power when the handset is close to the base unit.

- When this feature is activated, **ECO** is displayed.
- Eco mode is turned off when the clarity booster is activated (page 16).

Controls

Handset

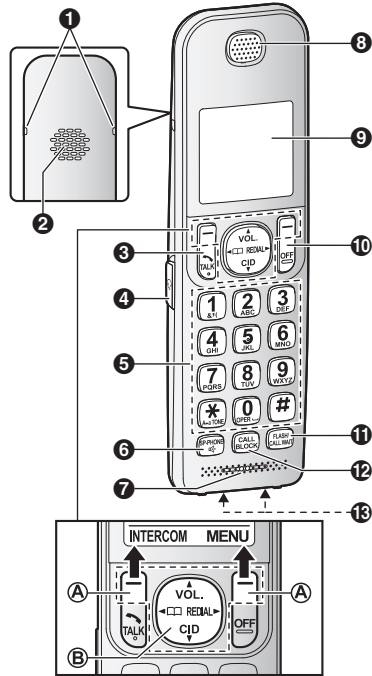

- 1 Belt clip holes
- 2 Speaker
- 3 [TALK]
- 4 Headset jack
- 5 Dial keypad (☒): TONE
- 6 [SP-PHONE: Speakerphone]
- 7 Microphone
- 8 Receiver
- 9 Display
- 10 [OFF]
- 11 [FLASH] [CALL WAIT]
- 12 [CALL BLOCK]
- 13 Charge contacts

Control type

A Soft keys

By pressing a soft key, you can select the feature shown directly above it on the display.

B Navigator key

- [▲], [▼], [◀], or [▶]: Scroll through various lists and items.

- VOL. (Volume: [▲] or [▼]): Adjust the receiver or speaker volume while talking.
- [◀] [☐]: View the phonebook entry.
- [▶] REDIAL: View the redial list.
- [▼] CID (Caller ID): View the caller list.

Base unit

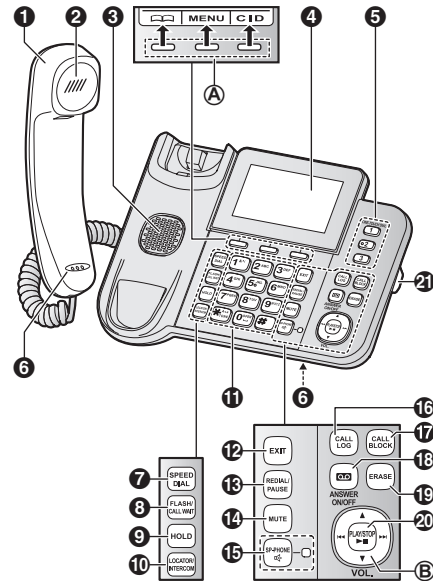

- 1 Corded handset
- 2 Receiver
- 3 Speaker
- 4 Display
 - The display can be moved back and forth to select the desired angle.
- 5 ONE-TOUCH DIAL buttons
- 6 Microphone
- 7 [SPEED DIAL]
- 8 [FLASH] [CALL WAIT]
- 9 [HOLD]
- 10 [LOCATOR] [INTERCOM]
 - You can locate a misplaced handset by pressing [LOCATOR].
- 11 Dial keypad (☒): TONE
- 12 [EXIT]
- 13 [REDIAL] [PAUSE]
- 14 [MUTE]
- 15 [SP-PHONE: Speakerphone]
SP-PHONE indicator
- 16 [CALL LOG]
 - You can access the caller list/redial list by pressing [CALL LOG].

Getting Started

- 17 [CALL BLOCK]
- 18 [ANS] (ANSWER ON/OFF)
ANSWER ON/OFF indicator
- 19 [ERASE]
- 20 [▶■] (PLAY/STOP)
Message indicator
- 21 Desk stand/Wall mounting adaptor
 - The adaptor is a removable attachment for desk stand or wall mounting use (page 47).

Control type

A Soft keys

By pressing a soft key, you can select the feature shown directly above it on the display.

B Navigator key

- [▲], [▼], [◀], or [▶]: Scroll through various lists and items.
- VOL. (Volume: [▲] or [▼]): Adjust the receiver or speaker volume while talking.
- [◀]/[▶]: Repeat/skip messages during playback.

Display icons

Handset display items

Item	Meaning
	Within base unit range
	Out of base unit range
	The line is in use. <ul style="list-style-type: none"> • When flashing: The call is put on hold. • When flashing rapidly: An incoming call is now being received.
ECO	Eco mode is on. (page 10)
NR	Noise reduction is set. (page 16)
EQ	Equalizer is set. (page 16)
	Speakerphone is on. (page 14)
	Ringer volume is off. (page 29)
ZzZ	Silent mode is on. (page 33)
PRIV.	Call sharing mode is off. (page 31)
	Alarm is on. (page 32)
1	Handset number
	Battery level

Item	Meaning
	Blocked call (page 19)
BOOST	Clarity booster is on. (page 16)
	Baby monitor is activated. The name/number displayed next to the icon indicates the monitoring unit. (page 33)
In use	Answering system is being used by another handset or the base unit.
Line in use	Someone is using the line.

Base unit display items

Item	Meaning
	The line is in use. <ul style="list-style-type: none"> • When flashing: The call is put on hold. • When flashing rapidly: An incoming call is now being received.
	Ringer volume is off. (page 29)
ZzZ	Silent mode is on. (page 33)
PRIV	Call sharing mode is off. (page 31)
GO	“Greeting only” is selected. Caller messages are not recorded. (page 45)
	Power backup mode is on. (page 9)
	Blocked call (page 19)
In use	Answering system is being used by the handset.
Line in use	Someone is using the line.

Language settings

Display language

You can select either “English” or “Español” as the display language. The default setting is “English”.

Handset / Base unit

- 1 [MENU]#[1][1][0]
- 2 [↓]: Select the desired setting. → [SAVE]

- 3 Proceed with the operation for your unit.
Handset: [OFF]
Base unit: [EXIT]

Voice guidance language

You can select either “English” or “Español” as the voice guidance language of the answering system. The default setting is “English”. You can configure this setting using either the base unit or one of the handsets.

Handset / Base unit

- 1 **[MENU]** **#** **1** **1** **2**
- 2 **[↕]**: Select the desired setting. → **[SAVE]**
- 3 Proceed with the operation for your unit.
Handset: [OFF]
Base unit: [EXIT]

Date and time

You can configure this setting using either the base unit or one of the handsets.

Handset / Base unit

- 1 **[MENU]** **#** **1** **0** **1**
- 2 Enter the current month, date, and year by selecting 2 digits for each.
Example: July 12, 2015
0 **7** **1** **2** **1** **5**
- 3 **[OK]**
- 4 Enter the current hour and minute (12-hour clock format) by selecting 2 digits for each.
Example: 9:30
0 **9** **3** **0**
- 5 Proceed with the operation for your unit.
Handset: **[X]**: Select “AM” or “PM”.
Base unit: **[AM/PM]**: Select “AM” or “PM”.
- 6 **[SAVE]**
- 7 Proceed with the operation for your unit.
Handset: [OFF]
Base unit: [EXIT]

Note:

- When English is selected as the display language, 12-hour clock format is used. When Spanish is selected, 24-hour clock format is used.

Recording your greeting message

You can record your own greeting message instead of using a pre-recorded greeting message. See page 39 for details.

You can configure this setting using either the base unit or one of the handsets.

Handset / Base unit

- 1 **[MENU]** **#** **3** **0** **2**
- 2 **[↕]**: “Yes” → **[SELECT]**
- 3 Record a greeting message. → **[STOP]**
- 4 Proceed with the operation for your unit.
Handset: [OFF]
Base unit: [EXIT]

Other settings

Dialing mode

If you cannot make calls, change this setting according to your telephone line service. The default setting is “Tone”.

“Tone”: For tone dial service.

“Pulse”: For rotary/pulse dial service.

You can configure this setting using either the base unit or one of the handsets.

Handset / Base unit

- 1 **[MENU]** **#** **1** **2** **0**
- 2 **[↕]**: Select the desired setting. → **[SAVE]**
- 3 Proceed with the operation for your unit.
Handset: [OFF]
Base unit: [EXIT]

Making/Answering Calls

Making calls

Using the handset

- 1 Lift the handset and dial the phone number.
 - To correct a digit, press **[CLEAR]**.
- 2 **[↶]**
- 3 When you finish talking, press **[OFF]** or place the handset on the charger.

Using the speakerphone

- 1 Dial the phone number and press **[📞]**.
- 2 When you finish talking, press **[OFF]**.

Note:

- To switch back to the receiver, press **[📞]/[↶]**.

Making a call using the redial list

The last 5 phone numbers dialed are stored in the redial list (each 48 digits max.).

- 1 **[▶]** REDIAL
- 2 **[↕]**: Select the desired phone number.
- 3 **[↶]**

Erasing a number in the redial list

- 1 **[▶]** REDIAL
- 2 **[↕]**: Select the desired phone number. → **[ERASE]**
- 3 **[↕]**: "Yes" → **[SELECT]**
- 4 **[OFF]**

Using the base unit

- 1 Dial the phone number.
 - To correct a digit, press **[CLEAR]**.
- 2 Lift the corded handset.
- 3 When you finish talking, place the corded handset on the cradle.

Note:

- You can also dial the phone number after lifting the corded handset.
- While on a call, you can switch from the base unit to the cordless handset as follows.
The call sharing mode must be on (page 31).
① **Handset:** Press **[↶]**.

- ② **Base unit:** Place the corded handset on the cradle. When the speakerphone is used, press **[📞]**.

Using the speakerphone

- 1 During a conversation with the corded handset, press **[📞]** to turn on the speakerphone.
 - You can place the corded handset on the cradle.
 - Speak into the base unit microphone.
- 2 When you finish talking, press **[📞]**.

Note:

- To switch to the receiver, lift the corded handset.

Making a call using the redial list

The last 10 phone numbers dialed are stored in the redial list (each 48 digits max.).

- 1 **[REDIAL]**
- 2 **[↕]**: Select the desired phone number.
- 3 Lift the corded handset.

Note:

- In step 1, you can also access the redial list as follows:
[CALL LOG] → **[↕]**: "Outgoing call" → **[SELECT]**

Erasing a number in the redial list

- 1 **[REDIAL]**
- 2 **[↕]**: Select the desired phone number. → **[ERASE]**
- 3 **[↕]**: "Yes" → **[SELECT]**
- 4 **[EXIT]**

Adjusting the receiver or speaker volume

Handset / Base unit

Press **[▲]** or **[▼]** repeatedly while talking.

Pause (for PBX/long distance service users)

A pause is sometimes required when making calls using a PBX or long distance service. When storing a calling card access number and/or PIN in the phonebook, a pause is also needed (page 24).

Example: If you need to dial the line access number "9" when making outside calls with a PBX:

Handset

- 1 [9] → [▲] (Pause)
- 2 Dial the phone number. → [↶]

Base unit

- 1 [9] → [PAUSE]
- 2 Dial the phone number.
- 3 Lift the corded handset.

Note for handset and base unit:

- A 3.5 second pause is inserted each time you press [▲] (Pause) on the handset or [PAUSE] on the base unit.

Answering calls

Using the handset

- 1 Lift the handset and press [↶] or [📞] when the unit rings.
- 2 When you finish talking, press [OFF] or place the handset on the charger.

Any key answer: You can answer the call by pressing any dial key.

Auto talk: You can answer calls simply by lifting the handset (page 30).

Temporary ringer off: You can turn the ringer off temporarily by pressing [🔕].

Using the base unit

- 1 Lift the corded handset or press [📞] when the unit rings.
- 2 When you finish talking, place the corded handset on the cradle. When the speakerphone is used, press [📞].

Temporary ringer off: You can turn the ringer off temporarily by pressing [🔕].

Adjusting the ringer volume

Handset / Base unit

Press [▲] or [▼] repeatedly to select the desired volume while ringing.

Useful features during a call

Hold

Handset

- 1 Press [MENU] during an outside call.
- 2 [↕]: "Hold" → [SELECT]
- 3 To release hold, press [↶].
 - Another handset user can take the call by pressing [↶].
 - The base unit user can take the call by lifting the corded handset.

Base unit

- 1 Press [HOLD] during an outside call.
 - If you are using the corded handset, you can place it on the cradle.
- 2 To release hold, lift the corded handset.
 - A handset user can take the call by pressing [↶].

Note for handset and base unit:

- While an outside call is on hold, the SP-PHONE indicator flashes.
- After holding for 10 minutes, the call is disconnected.

Mute

Handset / Base unit

- 1 Press [MUTE] during a call.
- 2 To return to the call, press [MUTE].

Note:

- [MUTE] is a soft key visible on the display during a call.

Flash

Handset / Base unit

[FLASH] allows you to use the special features of your host PBX such as transferring an extension call, or accessing optional telephone services.

Note:

- To change the flash time, see page 31.

Making/Answering Calls

For call waiting or Call Waiting Caller ID service users

To use call waiting or Call Waiting Caller ID, you must first subscribe with your phone service provider.

This feature allows you to receive calls while you are already talking on the phone. If you receive a call while on the phone, you will hear a call waiting tone.

If you subscribe to both Caller ID and Call Waiting with Caller ID services, the 2nd caller's information is displayed on the handset or base unit that is in use after you hear the call waiting tone.

Handset / Base unit

- 1 Press **[CALL WAIT]** to answer the 2nd call.
- 2 To switch between calls, press **[CALL WAIT]**.

Note:

- Please contact your phone service provider for details and availability of this service in your area.

Temporary tone dialing (for rotary/pulse service users)

Handset / Base unit

Press **[TONE]** before entering access numbers which require tone dialing.

Handset clarity booster

This feature can improve sound clarity when the handset is used in an area where there may be interference. During an outside call, this feature is turned on automatically when necessary.

- When this feature is turned on, **BOOST** is displayed.

Handset noise reduction

This feature allows you to hear the voice of the person you are talking to more clearly, by reducing the surrounding noise coming from the other party's telephone.

- 1 Press **[MENU]** while talking.
- 2 **[↕]**: "Noise reduction on" or "Noise reduction off" → **[SELECT]**

Note:

- Depending on the environment where this handset is being used, this feature may not be effective.
- This feature is not available while using the speakerphone.

Handset equalizer

This feature clarifies the voice of the person you are talking to, producing a more natural-sounding voice that is easier to hear and understand.

- 1 Press **[MENU]** while talking.
- 2 **[↕]**: "Equalizer" → **[SELECT]**
- 3 **[↕]**: Select the desired setting.
- 4 Press **[OK]** to exit.

Note:

- Depending on the condition and quality of your telephone line, this feature may emphasize existing line noise. If it becomes difficult to hear, turn this feature off.
- This feature is not available while using the speakerphone.
- When both the "Equalizer" setting and noise reduction are activated, **NR** is shown on the display.

Call share

You can join an existing outside call.

Handset

To join the conversation, press **[hook]** when the other unit is on an outside call.

Base unit

To join the conversation, lift the corded handset when the handset is on an outside call.

Note for handset and base unit:

- A maximum of 3 parties (including 1 outside party) can join a conversation. **(3-way conference)**
- To prevent other users from joining your conversations with outside callers, turn call sharing mode off (page 31).

Transferring calls, conference calls

Outside calls can be transferred or a conference call with an outside party can be made:

- between 2 handsets
- between a handset and the base unit

Handset

- 1 During an outside call, press **[MENU]**.
- 2 **[↕]**: "Intercom" → **[SELECT]**
- 3 **[↕]**: Select the desired unit. → **[SELECT]**
- 4 Wait for the paged party to answer.
 - If the paged party does not answer, press **[BACK]** to return to the outside call.
- 5 **To complete the transfer:**
Press **[OFF]**.
To establish a conference call:
[MENU] → **[↕]**: "Conference" → **[SELECT]**
 - To leave the conference, press **[OFF]**. The other 2 parties can continue the conversation.
 - To put the outside call on hold: **[MENU]** → **[↕]**: "Hold" → **[SELECT]**
To resume the conference: **[MENU]** → **[↕]**: "Conference" → **[SELECT]**
 - To cancel the conference: **[MENU]** → **[↕]**: "Stop conference" → **[SELECT]**
You can continue the conversation with the outside caller.

Base unit

- 1 During an outside call, press **[INTERCOM]**.
When 2 or more handsets are registered:
[↕]: Select the desired unit. → **[SELECT]**
 - To page all handsets, press **[0]** or wait for a few seconds.
- 2 Wait for the paged party to answer.
 - If paged party does not answer, press **[INTERCOM]** to return to the outside call.
- 3 **To complete the transfer:**
Place the corded handset on the cradle.
 - The outside call is being routed to the handset.**To establish a conference call:**
Press **[CONF]**.
 - To leave the conference, place the corded handset on the cradle. The other 2 parties can continue the conversation.
 - To put the outside call on hold, press **[HOLD]**. To resume the conference, press **[CONF]**.

Intercom

Intercom

Intercom calls can be made:

- between handsets
- between a handset and the base unit

Note:

- When paging unit(s), the paged unit(s) beeps for 1 minute.
- If you receive an outside call while talking on the intercom, the interrupt tone sounds.
 - **Handset:** To finish intercom, press **[OFF]**. To answer the call, press **[↶]**.
 - **Base unit:** To finish intercom, place the corded handset on the cradle. If the speakerphone is used, press **[📞]**. To answer the call, lift the corded handset. If the speakerphone is used, press **[📞]**.

Making an intercom call

Handset

- 1 **[MENU]** → **[↕]**: “Intercom” → **[SELECT]**
- 2 **[↕]**: Select the desired unit. → **[SELECT]**
- 3 When you finish talking, press **[OFF]**.

Note:

- You can also use the **[INTERCOM]** soft key, if displayed, to make intercom calls.

Base unit

- 1 Press **[INTERCOM]**.
When 2 or more handsets are registered:
[↕]: Select the desired unit. → **[SELECT]**
 - To page all handsets, press **[0]** or wait for a few seconds.
 - Lift the corded handset if needed.
- 2 When you finish talking, press **[📞]** or place the corded handset on the cradle.

Answering an intercom call

Handset

- 1 Press **[↶]** to answer the page.
- 2 When you finish talking, press **[OFF]**.

Base unit

- 1 Press **[📞]** or lift the corded handset to answer the page.

- 2 When you finish talking, press **[📞]** or place the corded handset on the cradle.

Turning auto intercom on/off

This feature allows the handset and base unit to answer intercom calls automatically when it is called. You do not need to press **[↶]**, lift the corded handset, or press **[📞]**. When this feature is set to “on”, the monitoring handset or base unit for the baby monitor feature (page 35) will also answer baby monitor calls automatically. The default setting is “off”.

Handset / Base unit

- 1 **[MENU]** **[#]** **[2]** **[7]** **[3]**
- 2 **[↕]**: Select the desired setting. → **[SAVE]**
- 3 Proceed with the operation for your unit.
Handset: **[OFF]**
Base unit: **[EXIT]**

Using the [CALL BLOCK] button

You can press the [CALL BLOCK] button in the following situations to disconnect the current call and add a phone number to the call block list:

- when an incoming call is being received
- when an incoming call is being recorded by the answering system
- when talking on an outside call

Once a phone number has been added to the call block list, the unit will block calls from that phone number in the future.

Handset / Base unit

- 1 Press [CALL BLOCK] under the situations shown above.
- 2 Confirm the call block number and press [YES].
 - The call block number is stored in the call block list, "Caller blocked" is displayed, and then the call is disconnected.

Note:

- If the call has no phone number, the call is blocked but it is not stored in the call block list.
- The call block feature is not available for intercom calls or calls received by call waiting.
- Blocked calls are logged in the caller list.

Storing unwanted callers

The unit can block calls by storing the desired items in the call block list beforehand (Caller ID subscribers only).

- "Block a single number": The unit blocks calls from specific phone numbers stored in the call block list.
- "Block range of numbers": The unit blocks calls that begin with a number stored in the call block list, such as a toll-free phone number prefix or certain area codes.
- "Block unknown CID": The unit blocks calls that have no phone number.

Single phone numbers and ranges of numbers can be stored in the call block list up to 250 items in total.

Blocking unwanted callers:

When a call is received, the unit rings briefly*1 while caller information is being received.

If the caller's phone number matches an entry in the call block list, the unit emits no sound to the caller, and disconnects the call.

*1 If you do not want this one ring to sound, select "No" in "Setting not to ring once for blocked call" (page 20).

Storing a single phone number

Important:

- We recommend storing 10 digits (including the area code). If only 7 digits are stored, all numbers that have the same last 7 digits will be blocked.

Adding call blocked numbers from the caller list

Handset

- 1 [v] CID
- 2 [↕]: Select the entry to be blocked.
 - To edit the number: [MENU] → [↕]: "Edit" → [SELECT]
 - Press [EDIT] repeatedly until the phone number is shown in the 10-digit format. → [SAVE] → [↕]: "Call block" → [SELECT] → Go to step 4.
- 3 [CALL BLOCK]
- 4 [↕]: "Yes" → [SELECT]
- 5 Edit the phone number if necessary (24 digits max.).
- 6 [SAVE] → [OFF]

Base unit

- 1 [CID]
- 2 [↕]: Select the entry to be blocked.
 - To edit the number: Press [EDIT] repeatedly until the phone number is shown in the 10-digit format.
- 3 [CALL BLOCK]
- 4 [↕]: "Yes" → [SELECT]
- 5 Edit the phone number if necessary (24 digits max.).
- 6 [SAVE] → [EXIT]

Adding call blocked numbers manually

Handset

- 1 [CALL BLOCK]

Call Block

- 2 [↕]: "Block a single number" → [SELECT]
- 3 [MENU] → [↕]: "Add" → [SELECT]
- 4 Enter the phone number (24 digits max.).
- 5 [SAVE] → [OFF]

Base unit

- 1 [CALL BLOCK]
- 2 [↕]: "Block a single number" → [SELECT] → [ADD]
- 3 Enter the phone number (24 digits max.).
- 4 [SAVE] → [EXIT]

Storing a range of number

Handset

- 1 [CALL BLOCK]
- 2 [↕]: "Block range of numbers" → [SELECT]
- 3 [MENU] → [↕]: "Add" → [SELECT]
- 4 Enter the desired number (2-8 digits).
- 5 [SAVE] → [OFF]

Base unit

- 1 [CALL BLOCK]
- 2 [↕]: "Block range of numbers" → [SELECT]
- 3 [ADD]
- 4 Enter the desired number (2-8 digits).
- 5 [SAVE] → [EXIT]

Blocking incoming calls that have no phone number

You can block calls when no phone number is provided, such as private callers or out of area calls.

Handset / Base unit

- 1 [CALL BLOCK]
- 2 [↕]: "Block unknown CID" → [SELECT]
- 3 [↕]: Select the desired setting. → [SAVE]
- 4 Proceed with the operation for your unit.
Handset: [OFF]
Base unit: [EXIT]

Setting not to ring once for blocked call

If you do not want the unit to sound one ring for calls from phone numbers stored in the call block list, select "No". The default setting is "Yes".

Handset / Base unit

- 1 [CALL BLOCK]
- 2 [↕]: "One ring for blocked call" → [SELECT]
- 3 [↕]: Select the desired setting. → [SAVE]
- 4 Proceed with the operation for your unit.
Handset: [OFF]
Base unit: [EXIT]

Viewing/editing/erasing call block numbers

Handset

- 1 [CALL BLOCK]
- 2 [↕]: "Block a single number" or "Block range of numbers" → [SELECT]
- 3 [↕]: Select the desired entry.
 - After viewing, press [OFF] to exit.
- 4 **To edit a number:**
[EDIT] → Edit the number. → [SAVE] → [OFF]

To erase a number:
[ERASE] → [↕]: "Yes" → [SELECT] → [OFF]

Base unit

- 1 [CALL BLOCK]
- 2 [↕]: "Block a single number" or "Block range of numbers" → [SELECT]
- 3 [↕]: Select the desired entry.
 - After viewing, press [EXIT] to exit.
- 4 **To edit a number:**
[EDIT] → Edit the number. → [SAVE] → [EXIT]

To erase a number:
[ERASE] → [↕]: "Yes" → [SELECT] → [EXIT]

Note:

- When editing, press the desired dial key to add digits and press [CLEAR] to erase digits.

Erasing all call block numbers

Handset / Base unit

- 1 **[CALL BLOCK]**
- 2 **[↕]**: “Block a single number” or “Block range of numbers” → **[SELECT]**
- 3 Proceed with the operation for your unit.
Handset: **[MENU]** → **[↕]**: “Erase all” → **[SELECT]**
Base unit: **[ERASE]**
- 4 **[↕]**: “Yes” → **[SELECT]**
- 5 **[↕]**: “Yes” → **[SELECT]**
- 6 Proceed with the operation for your unit.
Handset: **[OFF]**
Base unit: **[EXIT]**

Phonebook

Phonebook

You can add 100 names (16 characters max.) and phone numbers (24 digits max.) to the phonebook, and assign each phonebook entry to the desired group (page 23).

Important:

- All entries can be shared by the base unit and any registered handset.

Adding phonebook entries

Handset / Base unit

- 1 Proceed with the operation for your unit.
Handset: [◀] □□ → [MENU]
Base unit: [□□] → [MENU]
- 2 [↕]: "Add new entry" → [SELECT]
- 3 Enter the party's name. → [OK]
- 4 Enter the party's phone number. → [OK]
- 5 [↕]: Select the desired group. → [SELECT]
2 times
- 6 Proceed with the operation for your unit.
Handset: [OFF]
Base unit: [EXIT]

Note for base unit:

- You can also add entries as follows:
Press [□□]. → [ADD] → Go to step 3.

Character table for entering names

While entering characters, you can switch between uppercase and lowercase by pressing [X] (A→a).

Key	Character
[1]	& ' () * , - . / 1
[2]	A B C 2 a b c 2
[3]	D E F 3 d e f 3
[4]	G H I 4 g h i 4
[5]	J K L 5 j k l 5

Key	Character
[6]	M N O 6 m n o 6
[7]	P Q R S 7 p q r s 7
[8]	T U V 8 t u v 8
[9]	W X Y Z 9 w x y z 9
[0]	_ 0
[#]	#

- To enter another character that is located on the same dial key:
Handset: Press [▶] to move the cursor to the next space.
Base unit: Press [▶▶] to move the cursor to the next space.
- If you do not press any dial key within 2 seconds after entering a character, the character is fixed and the cursor moves to the next space.
- _ in the above table represents a single space.

Erasing the character or number

- Handset:** Press [◀] or [▶]. → [CLEAR]
Base unit: Press [◀◀] or [▶▶]. → [CLEAR]
- Press and hold [CLEAR] to erase all characters or numbers.

Storing a redial list number to the phonebook

Phone numbers of up to 24 digits can be stored in the phonebook.

Handset / Base unit

- 1 Proceed with the operation for your unit.
Handset: [▶] REDIAL
Base unit: [REDIAL]
- 2 [↕]: Select the desired phone number. → [SAVE]
- 3 To store the name, continue from step 3, "Editing entries", page 23.

Storing caller information to the phonebook

Handset

- 1 [▼] CID

- 2 [↕]: Select the desired entry. → [MENU]
 - To edit the number: [↕]: “Edit” → [SELECT]

Press [EDIT] repeatedly until the phone number is shown in the desired format. And then, press [SAVE]. Go to step 4.
- 3 [↕]: “Save caller ID” → [SELECT]
- 4 [↕]: “Phonebook” → [SELECT]
- 5 Continue from step 3, “Editing entries”, page 23.

Base unit

- 1 [CID]
- 2 [↕]: Select the desired entry.
 - To edit the number, press [EDIT] repeatedly until the phone number is shown in the desired format.
- 3 [SAVE]
- 4 [↕]: “Phonebook” → [SELECT]
- 5 Continue from step 3, “Editing entries”, page 23.

Groups

Groups can help you find entries in the phonebook quickly and easily. You can change the names of groups assigned for phonebook entries (“Friends”, “Family”, etc.). By assigning different ringer tones for different groups of callers, you can identify who is calling (ringer ID), if you have subscribed to Caller ID service.

Changing group names/setting ringer ID

The default group name is “Group 1” to “Group 9”.

Handset / Base unit

- 1 Proceed with the operation for your unit.

Handset: [←] □□ → [MENU]
Base unit: [□□] → [MENU]
- 2 [↕]: “Group” → [SELECT]
- 3 [↕]: Select the desired group. → [SELECT]
- 4 **To change group names**

[↕]: “Group name” → [SELECT] → Edit the name (10 characters max.). → [SAVE]
- 5 **To set group ringer tone (handset)**

[↕]: Select the current setting of the group ringer tone. → [SELECT] → [↕]: Select the desired ringer tone. → [SAVE]

- 6 Proceed with the operation for your unit.

Handset: [OFF]
Base unit: [EXIT]

Finding and calling from a phonebook entry

Handset / Base unit

- 1 Proceed with the operation for your unit.

Handset: [←] □□
Base unit: [□□]
- 2 **To scroll through all entries**

[↕]: Select the desired entry.
To search by first character
 - ① Press the dial key ([0] to [9], or [#]) which contains the character you are searching for (page 22).
 - ② [↕]: Scroll through the phonebook if necessary.**To search by group**
 - ① [GROUP]
 - ② [↕]: Select the desired group. → [SELECT]
 - ③ [↕]: Scroll through the phonebook if necessary.
- 3 Proceed with the operation for your unit.

Handset: [↶]
Base unit: Lift the corded handset.

Editing entries

Handset

- 1 Find the desired entry (page 23).
- 2 [MENU] → [↕]: “Edit” → [SELECT]
- 3 Edit the name if necessary. → [OK]
- 4 Edit the phone number if necessary. → [OK]
- 5 [↕]: Select the desired group (page 23). → [SELECT] 2 times → [OFF]

Base unit

- 1 Find the desired entry (page 23).
- 2 [EDIT]
- 3 Edit the name if necessary. → [OK]
- 4 Edit the phone number if necessary. → [OK]
- 5 [↕]: Select the desired group (page 23). → [SELECT] 2 times → [EXIT]

Phonebook

Erasing entries

Erasing an entry

Handset

- 1 Find the desired entry (page 23).
- 2 **[MENU]** → **[↕]**: "Erase" → **[SELECT]**
- 3 **[↕]**: "Yes" → **[SELECT]** → **[OFF]**

Base unit

- 1 Find the desired entry (page 23).
- 2 **[ERASE]** → **[↕]**: "Yes" → **[SELECT]** → **[EXIT]**

Erasing all entries

Handset / Base unit

- 1 Proceed with the operation for your unit.
Handset: **[◀]** **[□□]** → **[MENU]**
Base unit: **[□□]** → **[MENU]**
- 2 **[↕]**: "Erase all" → **[SELECT]**
- 3 **[↕]**: "Yes" → **[SELECT]**
- 4 **[↕]**: "Yes" → **[SELECT]**
- 5 Proceed with the operation for your unit.
Handset: **[OFF]**
Base unit: **[EXIT]**

Chain dial

This feature allows you to dial phone numbers in the phonebook while you are on a call. This feature can be used, for example, to dial a calling card access number or bank account PIN that you have stored in the phonebook, without having to dial manually.

Handset / Base unit

- 1 Proceed with the operation for your unit.
Handset: During an outside call, press **[◀]** **[□□]**.
Base unit: During an outside call, press **[□□]**.
- 2 **[↕]**: Select the desired entry.
- 3 Press **[CALL]** to dial the number.

Note:

- When storing a calling card access number and your PIN in the phonebook as one phonebook entry, press **[▲]** (Pause) on the handset or **[PAUSE]** on the base unit to add pauses after the number and PIN as necessary (page 14).

- If you have rotary/pulse service, you need to press **[TONE]** before pressing **[◀]** **[□□]** on the handset or **[□□]** on the base unit in step 1 to change the dialing mode temporarily to tone. When adding entries to the phonebook, we recommend adding **[TONE]** to the beginning of phone numbers you wish to chain dial (page 22).

Speed dial

You can store phone numbers to the base unit and handset separately:

- Handset: up to 9 entries.
- Base unit: up to 9 entries.

Adding phone numbers to speed dial keys

Handset

You can assign 1 phone number to each of the dial keys (**[1]** to **[9]**).

■ By entering phone numbers:

- 1 Press and hold the desired speed dial key (**[1]** to **[9]**). → **[ADD]**
- 2 **[↕]**: "Manual" → **[SELECT]**
- 3 Enter the party's name (16 characters max.). → **[OK]**
- 4 Enter the party's phone number (24 digits max.). → **[OK]**
- 5 **[SELECT]** → **[OFF]**

■ From the phonebook:

- 1 Press and hold the desired speed dial key (**[1]** to **[9]**). → **[ADD]**
- 2 **[↕]**: "Phonebook" → **[SELECT]**
- 3 **[↕]**: Select the desired entry.
- 4 **[SAVE]** → **[OFF]**

Base unit

■ By entering phone numbers:

- 1 **[SPEED DIAL]**
- 2 **[↕]**: Select the desired speed dial key. → **[EDIT]**
- 3 Enter the party's name (16 characters max.). → **[OK]**

4 Enter the party's phone number (24 digits max.). → [OK]

5 [SELECT] → [EXIT]

■ From the phonebook:

1 [SPEED DIAL]

2 [↕]: Select the desired speed dial key. → [□□]

3 [↕]: Select the desired entry.

4 [SAVE] → [EXIT]

Note for handset and base unit:

- If you edit a phonebook entry which is assigned to a speed dial key, the edited entry does not transfer to the speed dial key.

Note for base unit:

- You can also select the desired entry as follows:
 - Press and hold the desired speed dial key ([1] to [9]).
 - Press [SPEED DIAL] and then enter the desired speed dial key ([1] to [9]).

Editing an entry

Handset

1 Press and hold the desired speed dial key ([1] to [9]). → [MENU]

2 [↕]: "Edit" → [SELECT]

3 Edit the name if necessary. → [OK]

4 Edit the phone number if necessary. → [OK]

5 [SELECT] → [OFF]

Base unit

1 [SPEED DIAL]

2 [↕]: Select the desired entry. → [DETAIL]

3 [EDIT]

4 Edit the name if necessary. → [OK]

5 Edit the phone number if necessary. → [OK]

6 [SELECT] → [EXIT]

Erasing an entry

Handset

1 Press and hold the desired speed dial key ([1] to [9]). → [MENU]

2 [↕]: "Erase" → [SELECT]

3 [↕]: "Yes" → [SELECT]

4 [OFF]

Base unit

1 [SPEED DIAL]

2 [↕]: Select the desired entry. → [DETAIL]

3 [ERASE]

4 [↕]: "Yes" → [SELECT]

5 [EXIT]

Viewing an entry/Making a call

Handset

1 Press and hold the desired speed dial key ([1] to [9]).

2 To make a call, press [↶].

Base unit

1 [SPEED DIAL]

2 [↕]: Select the desired entry.

3 Lift the corded handset.

Note for base unit:

- You can dial phone numbers in the speed dial while you are on a call.

One-touch dial buttons

You can store phone numbers or extension numbers to the base unit's one-touch dial buttons (1 to 3).

- phone numbers for outside calls
- extension numbers for handsets

Note:

- You can transfer a call to a handset. While you are on an outside call, press the one-touch dial button with an extension number stored. The line is put on hold and the base unit pages the handset. After the handset answers the page, place the corded handset on the cradle to complete the transfer.

Phonebook

Adding phone numbers for outside calls

Base unit

■ By entering phone numbers:

- 1 Press and hold the desired one-touch dial button (1 to 3). → **[EDIT]**
- 2 Enter the party's name (16 characters max.). → **[OK]**
- 3 Enter the party's phone number (24 digits max.). → **[OK]**
- 4 **[SELECT]** → **[EXIT]**

■ From the phonebook:

- 1 Press and hold the desired one-touch dial button (1 to 3).
- 2 **[□□]**
- 3 **[↕]**: Select the desired entry.
- 4 **[SAVE]** → **[EXIT]**

Note:

- If you edit a phonebook entry which is assigned to a one-touch dial button, the edited entry does not transfer to the one-touch dial button.

Adding extension numbers for handsets

Base unit

- 1 Press and hold the desired one-touch dial button (1 to 3). → **[EDIT]**
- 2 Press **[INT]**.
- 3 **[↕]**: Select the desired unit. → **[SELECT]** 2 times → **[EXIT]**

Viewing/editing/erasing an entry

Base unit

- 1 Press and hold the desired one-touch dial button (1 to 3).
 - After viewing, press **[EXIT]** to exit.
- 2 **To edit an entry**
[EDIT] → Edit the name if necessary. → **[OK]** → Edit the phone number if necessary. → **[OK]** → **[SELECT]** → **[EXIT]**
To erase an entry

[ERASE] → **[↕]**: "Yes" → **[SELECT]** → **[EXIT]**

Making a call

Base unit

Press the desired one-touch dial button (1 to 3), then lift the corded handset.

Note:

- You can dial phone numbers in the one-touch dial while you are on a call.

Menu list

To access the features, there are 2 methods.

Handset / Base unit





■ Scrolling through the display menus

- 1 [MENU]
- 2 Press [▼] or [▲] to select the desired main menu. → [SELECT]
- 3 Press [▼] or [▲] to select the desired item from the next sub-menus. → [SELECT]
- 4 Press [▼] or [▲] to select the desired setting. → [SAVE]

■ Using the direct command code



- 1 [MENU] → Enter the desired code.
Example: Press [MENU]#1101.
- 2 Select the desired setting. → [SAVE]

Note:



- The unit column shows the unit(s) that can be used to program the item.
 - : Only the handset can program the item.
 - : Only the base unit can program the item.
 - : Both the handset and base unit can program the item.
- To exit the operation, press [OFF] on the handset or [EXIT] on the base unit.
- In the following table, < > indicates the default settings.
- In the following table,  indicates the reference page number.
- Display menu order and sub-menu may vary depending on your model.

Display menu tree and direct command code table

Main menu:  "Phonebook"

Operation	Code	Unit	
Viewing the phonebook entry.	#280	 	23





Main menu:  "Caller list"

Operation	Code	Unit	
Viewing the caller list.	#213	 	37

Main menu:

Handset:  "Answering device"

Base unit:  "Answering device"

Sub-menu 1	Sub-menu 2	Settings	Code	Unit	
Play new message	–	–	#323		40
Play all message	–	–	#324		40
Erase all message*1	–	–	#325		41

Programming

Sub-menu 1	Sub-menu 2	Settings	Code	Unit	
Greeting	Record greeting* ¹	–	#302		39
	Check greeting	–	#303		40
	Pre-recorded* ¹ (Reset to pre-recorded greeting)	–	#304		39
New message alert* ¹	Outgoing call – On/Off	On <Off>	#338		41
	Outgoing call – Notification to	–			
	Outgoing call – Remote code	Activate <Inactivate>			
	Base unit beep	On <Off>	#339		41
Settings	Ring count* ¹	2-7 rings <4 rings> Toll saver	#211		44
	Recording time* ¹	1 min <3 min> Greeting only* ²	#305		45
	Remote code* ¹	<111>	#306		43
	Screen call	<On> Off	#310		44
Answer on* ¹	–	–	#327		39
Answer off* ¹	–	–	#328		39

Main menu: “Voicemail access”

Operation	Code	Unit	
Listening to voicemail messages.	#330		46

Main menu: “Intercom”



Operation	Code	Unit	
Paging the desired unit.	#274		18

Main menu: “Set date & time”























Sub-menu 1	Sub-menu 2	Settings	Code	Unit	
Date and time* ¹	–	–	#101		13
Memo alarm	Alarm1-3	Once Daily Weekly <Off>	#720		32
Time adjustment* ¹ , * ³	–	<Caller ID auto> Manual	#226		–

Programming

















Main menu:  "Speed dial"

Operation	Code	Unit	
Viewing the speed dial entry.	#261		24











Main menu:  "Settings"

Sub-menu 1	Sub-menu 2	Settings	Code	Unit		
Ring adjustments	Ringer volume	Off-6 <6>	#160		-	
	Ringer tone* ^{4,5}	<Tone 1>	#161		-	
	Silent mode - On/Off	On <Off>	#238		33	
	Silent mode - Start/End	<11:00 PM/06:00 AM>	#237		33	
	Silent mode - Select group	Group 1-9	#241		33	
Set date & time	Date and time* ¹	-	#101		13	
	Memo alarm - Alarm1-3	Once Daily Weekly <Off>	#720		32	
	Time adjustment* ^{1,3}	<Caller ID auto> Manual	#226		-	
Talking caller ID	-	Handset: <On> Off Base unit:* ¹ On <Off>	#162		37	
Key detector setting* ⁶ - 1:Add new device (for Detector1)* ⁷ - 2:Add new device (for Detector2) - 3:Add new device (for Detector3) - 4:Add new device (for Detector4)	Change name* ¹	Detector1	#6561		-	
		Detector2* ⁸	#6562* ⁸			
		Detector3* ⁸	#6563* ⁸			
		Detector4* ⁸	#6564* ⁸			
	Registration	-		#6571		-
				#6572* ⁸		
				#6573* ⁸		
				#6574* ⁸		
	Deregistration	-		#6581		-
				#6582* ⁸		
			#6583* ⁸			
			#6584* ⁸			

Programming

Sub-menu 1	Sub-menu 2	Settings	Code	Unit	👉
Call block*1	Block a single number	–	#217		19
	Block range of numbers	–			20
	Block unknown CID (CID: Caller ID)	Block <Unblock>	#240		20
	One ring for blocked call	<Yes> No	#173		20
One-touch dial	–	–	#247		25
Speed dial	–	–	#261		24
Record greeting*1	–	–	#302		39
Voicemail	Save VM access#*1, *9 (VM: Voicemail) Save Voicemail access#*1, *10	–	#331		46
	VM tone detect*1	<On> Off	#332		46
LCD contrast (Display contrast)	–	Handset: Level 1-4 <2> Base unit: Level 1-6 <3>	#145		–
Handset name	–	–	#104		35
Display name	–	On <Off>	#105		35
Auto intercom	–	On <Off>	#273		18
Key tone	–	<On> Off	#165		–
Caller ID edit (Caller ID number auto edit)	–	<On> Off	#214		38
Auto talk*11	–	On <Off>	#200		15



Programming

Sub-menu 1	Sub-menu 2	Settings	Code	Unit	👉
Set tel line* ¹	Set dial mode	Pulse <Tone>	#120		13
	Set flash time* ¹²	900 ms <700 ms> 600 ms 400 ms 300 ms 250 ms 200 ms 160 ms 110 ms 100 ms 90 ms 80 ms	#121		15
	Set line mode* ¹³	A 	#122		–
Call sharing* ¹	–	<On> Off	#194		16
Registration	Register handset	–	#130		36
	Deregistration* ²	–	#131		36
Deregistration* ²	–	–	#131		36
Battery saving mode	–	On <Off>	#150		10
Change language	Display	<English> Español	#110		12
	Voice prompt* ¹	<English> Español	#112		13

Main menu: 🌐 “Customer support”

Operation	Code	Unit	👉
Displaying customer support Web address.	#680		–

Main menu: 😊 “Baby monitor”

Sub-menu 1	Sub-menu 2	Settings	Code	Unit	👉
On/Off	–	On <Off>	#268		34
Sensitivity level	–	Low <Middle> High	#269		35

Main menu: 🗄️ “Key detector”⁶

Sub-menu 1	Sub-menu 2	Settings	Code	Unit	👉
Search	–	–	#655		–
Battery check	–	–			

Programming

- *1 If you program these settings using one of the units, you do not need to program the same item using another unit.
- *2 This menu is not displayed when scrolling through the display menus. It is only available in direct command code.
- *3 This feature allows the unit to automatically adjust the date and time each time caller information including date and time is received.
To turn this feature on, select “**Caller ID auto**”. To turn this feature off, select “**Manual**”. (Caller ID subscribers only)
To use this feature, set the date and time first (page 13).
- *4 The preset melodies in this product (“**Tone 3**” - “**Melody 10**”) are used with permission of © 2009 Copyrights Vision Inc.
- *5 If you subscribe to a distinctive ring service (such as IDENTA-RING), select a tone (tone 1 or 2). If you select a melody, you cannot distinguish lines by their ringers.
- *6 This setting is available when you have the key detector (KX-TGA20). Read the installation manual for more information on the key detector.
- *7 For models with supplied key detectors, the display shows “**1:Detector1**”.
- *8 If you register 2 or more key detectors.
- *9 Handset
- *10 Base unit
- *11 If you subscribe to a Caller ID service and want to view the caller’s information after lifting up the handset to answer a call, turn off this feature.
- *12 The flash time depends on your telephone exchange or host PBX. Contact your PBX supplier if necessary. The setting should stay at “**700 ms**” unless pressing [**FLASH**] fails to pick up the waiting call.
- *13 Generally, the line mode setting should not be changed. This setting automatically maintains receiver volume at the proper level depending on the current telephone line condition. Set the line mode to “**A**” if telephone line condition is not good.

Alarm

An alarm sounds at the set time for 1 minute and is repeated 5 times at 5 minute intervals (snooze function). A text memo can also be displayed for the alarm. A total of 3 separate alarm times can be programmed for each handset. You can set one of 3 different alarm options (once, daily, or weekly) for each alarm time.

Important:

- Make sure the unit’s date and time setting is correct (page 13).

Handset

- 1 [**MENU**][**#**][**7**][**2**][**0**]
- 2 [**↕**]: Select the desired alarm. → [**SELECT**]
- 3 [**↕**]: Select the desired alarm option. → [**SELECT**]

“ OFF ”	Turns alarm off. Go to step 10.
----------------	---------------------------------

“ Once ”	An alarm sounds once at the set time.
“ Daily ”	An alarm sounds daily at the set time. Go to step 5.
“ Weekly ”	Alarm sounds weekly at the set time(s).

- 4 Proceed with the operation according to your selection in step 3.
 - **Once:**
Enter the desired month and date. → [**OK**]
 - **Weekly:**
[**↕**]: Select the desired day of the week and press [**SELECT**]. → [**OK**]
- 5 Set the desired time.
- 6 [**☒**]: Select “**AM**” or “**PM**”. → [**OK**]
- 7 Enter a text memo (10 characters max.). → [**OK**]

- 8 **[↕]**: Select the desired alarm tone. → **[SELECT]**
 - We recommend selecting a different ringer tone from the one used for outside calls.
- 9 **[↕]**: Select the desired snooze setting. → **[SAVE]**
- 10 **[SELECT]** → **[OFF]**

Note:

- Press **[STOP]** to stop the alarm completely.
- When the handset is in use, the alarm will not sound until the handset is in standby mode.
- Press any dial key or **[SNOOZE]** to stop the sound but keep the snooze function activated.
- If you want to make an outside call when the snooze function is activated, please stop the snooze function before making the call.

Silent mode

Silent mode allows you to select a period of time during which the handset and/or base unit will not ring for outside calls. This feature is useful for time periods when you do not want to be disturbed, for example, while sleeping. Silent mode can be set for each unit.

Using the phonebook's group feature (page 23), you can also select groups of callers whose calls override silent mode and ring the unit (Caller ID subscribers only).

Important:

- Make sure the unit's date and time setting is correct (page 13).
- If you have set the alarm, the alarm sounds even if the silent mode is turned on.

Turning silent mode on/off

Handset

- 1 **[MENU]****#****2****3****8**
- 2 **[↕]**: Select the desired setting. → **[SAVE]**
 - If you select "OFF", press **[OFF]** to exit.
- 3 Enter the desired hour and minute you wish to start this feature.
- 4 **[X]**: Select "AM" or "PM". → **[OK]**
- 5 Enter the desired hour and minute you wish to end this feature.
- 6 **[X]**: Select "AM" or "PM".
- 7 **[SAVE]** → **[OFF]**

Base unit

- 1 **[MENU]****#****2****3****8**
- 2 **[↕]**: Select the desired setting. → **[SAVE]**
 - If you select "OFF", press **[EXIT]** to exit.
- 3 Enter the desired hour and minute you wish to start this feature.
- 4 **[AM/PM]**: Select "AM" or "PM". → **[OK]**
- 5 Enter the desired hour and minute you wish to end this feature.
- 6 **[AM/PM]**: Select "AM" or "PM".
- 7 **[SAVE]** → **[EXIT]**

Changing the start and end time

Handset / Base unit

- 1 **[MENU]****#****2****3****7**
- 2 Continue from step 3 for handset or step 3 for base unit, "Turning silent mode on/off", page 33.

Selecting groups to bypass silent mode

Handset / Base unit

- 1 **[MENU]****#****2****4****1**
- 2 **[↕]**: Select the desired group. → **[SELECT]**
 - "✓" is displayed next to the selected group numbers.
 - To cancel the selected group: **[↕]**: Select the group. → Press **[SELECT]** again. "✓" disappears.
- 3 **[SAVE]**
- 4 Proceed with the operation for your unit.
Handset: [OFF]
Base unit: [EXIT]

Baby monitor

This feature allows you to listen in on a room where another handset is located, allowing you to easily monitor from different areas of the house or place. The monitored handset (placed in a baby's room, for example) will automatically call the monitoring handset, base unit, or the phone number stored when it detects sound.

Important:

- You should perform a test run of the baby monitor procedure to ensure that the baby monitor feature is set correctly. For example,

Programming

test its sensitivity. Check the connection if you are diverting the baby monitor to an outside line.

- This feature should not be used as a substitute for a medical or caregiver's supervision. It is the caregiver's responsibility to stay close enough to handle any eventuality.

Note:

- If the unit is connected to a PBX system, you cannot set the baby monitor.
- During the monitoring mode, battery consumption is faster than usual. We recommend leaving the monitored handset on charger.
- The monitored handset never rings while it is being monitoring. If the base unit is placed near the monitored handset, we recommend turning off the base unit ringer volume (page 29).

Setting the baby monitor

Perform the setting operation with the handset to be monitored (for example, the handset placed in a baby's room).

To monitor with a unit

The internal baby monitor feature is only available:

- between handsets
- between a handset and the base unit

Handset

- 1 **[MENU]** **#** **2** **6** **8**
- 2 **[↕]**: "On" → **[SELECT]**
- 3 **[↕]**: Select the desired unit's number to monitor with. → **[SAVE]**
 - "Baby monitor" will be displayed.
 - The registered unit's name/number is displayed.

Note:

- When this feature is on, another handset or the base unit can hear the monitored handset by making an intercom call.

To monitor from an outside line

If you enable this feature, the unit will call a pre-programmed phone number when the handset detects sound. After you answer the call, you can listen in on the room where the handset is located.

Handset

From the phonebook:

- 1 **[MENU]** **#** **2** **6** **8**
- 2 **[↕]**: "On" → **[SELECT]**
- 3 **[↕]**: Select "Outgoing call" to monitor from an outside line. → **[EDIT]** → **[ADD]**
- 4 **[↕]**: "Phonebook" → **[SELECT]**
- 5 **[↕]**: Select the phonebook entry. → **[SAVE]**
 - "Baby monitor" will be displayed.

Note:

- If you edit a phonebook entry which is assigned for monitoring, the edited entry does not transfer to the monitor.

By entering phone numbers:

- 1 **[MENU]** **#** **2** **6** **8**
- 2 **[↕]**: "On" → **[SELECT]**
- 3 **[↕]**: Select "Outgoing call" to monitor from an outside line. → **[EDIT]** → **[ADD]**
- 4 **[↕]**: "Manual" → **[SELECT]**
- 5 Enter the desired name. → **[OK]**
- 6 Enter the desired number. → **[OK]** → **[SELECT]**
 - "Baby monitor" will be displayed.

Note:

- The registered name/number is displayed.

Turning off the baby monitor

The monitored handset cannot be used while baby monitor is set to "On".

Handset

- 1 Press **[MENU]** on the handset being monitored.
- 2 **[↕]**: "On/Off" → **[SELECT]**
- 3 **[↕]**: "Off" → **[SELECT]** → **[OFF]**

Editing an outside monitoring number

Handset

- 1 Press **[MENU]** on the handset being monitored.
- 2 **[↕]**: "On/Off" → **[SELECT]**
- 3 **[↕]**: "On" → **[SELECT]**
- 4 **[↕]**: Select the outside line. → **[EDIT]**

- 5 [MENU] → [↕]: "Edit" → [SELECT]
- 6 Edit the name if necessary. → [OK]
- 7 Edit the phone number if necessary. → [OK] → [SELECT]

Erasing an outside monitoring number

Handset

- 1 Press [MENU] on the handset being monitored.
- 2 [↕]: "On/Off" → [SELECT]
- 3 [↕]: "On" → [SELECT]
- 4 [↕]: Select the outside line. → [EDIT]
- 5 [MENU] → [↕]: "Erase" → [SELECT]
- 6 [↕]: "Yes" → [SELECT] → [OFF]

Baby monitor sensitivity

You can adjust the sensitivity of the baby monitor. Increase or decrease the sensitivity to adjust the sound level needed to trigger the baby monitor feature.

- This feature cannot be set during a monitoring call.

Handset

- 1 Press [MENU] on the handset being monitored.
- 2 [↕]: "Sensitivity level" → [SELECT]
- 3 [↕]: Select the desired setting. → [SAVE] → [OFF]

Answering the baby monitor

■ When monitoring with a unit:

Handset: Press [↶] to answer a call.

Base unit: Press [📞] to answer a call.

If you want to respond from the monitoring unit, press [MUTE].

- The monitoring unit will answer calls automatically when the auto intercom feature is set to "On" (page 18).

Note:

- If you receive an outside call when communicating with the monitored handset, the interrupt tone sounds.
 - To answer the call with the handset, press [OFF], then press [↶].
 - To answer the call with the base unit, press [📞] 3 times.*1

*1 If [MUTE] is pressed, press [📞] 2 times.

■ When monitoring from an outside line:

Answer the call.

If you want to respond from your monitoring phone, press [#]1 using tone dialing.

You can turn off the baby monitor feature by pressing [#]0.

Note:

- The unit disconnects the call automatically after 2 minutes.

Other programming

Changing the handset name

The default handset name is "Handset 1" to "Handset 6". You can customize the name of each handset ("Bob", "Kitchen", etc.). This is useful when you make intercom calls between handsets. To display the handset name in standby mode, turn on the handset name display feature (page 35).

Handset

- 1 [MENU]#104
- 2 Enter the desired name (max. 10 characters).
- 3 [SAVE] → [OFF]

Displaying the handset name

You can select whether or not the handset name is displayed in standby mode. The default setting is "off".

Handset

- 1 [MENU]#105
- 2 [↕]: Select the desired setting. → [SAVE] → [OFF]

Programming

Registering a unit

Operating additional units

Additional handsets

Up to 6 handsets can be registered to the base unit.

Important:

- See page 4 for information on the available model.

Registering a handset to the base unit

The supplied handset and base unit are pre-registered. If for some reason the handset is not registered to the base unit, re-register the handset.

- 1 Handset:**
[MENU][#][1][3][0]
- 2 Base unit:**
Press and hold [LOCATOR] for about 5 seconds.
 - If all registered handsets start ringing, press [LOCATOR] again to stop, then repeat this step.
- 3 Handset:**
Press [OK], then wait until a long beep sounds.

Deregistering a handset

A handset can cancel its own registration to the base unit, or other handsets registered to the same base unit. This allows the handset to end its wireless connection with the system.

Handset / Base unit

- 1 [MENU][#][1][3][1]**
 - All handsets registered to the base unit are displayed.
- 2 [↕]:** Select the handset you want to cancel.
→ [SELECT]
- 3 [↕]:** "Yes" → [SELECT]
- 4** Proceed with the operation for your unit.
Handset: [OFF]
Base unit: [EXIT]

Using Caller ID service

Important:

- This unit is Caller ID compatible. To use Caller ID features, you must subscribe to a Caller ID service. Contact your phone service provider for details.

Caller ID features

Handset / Base unit

When an outside call is being received, the caller information is displayed.

Caller information for the last 50 callers is logged in the caller list from the most recent call to the oldest.

- If the unit cannot receive caller information, the following is displayed:
 - “**Out of area**”: The caller dials from an area which does not provide a Caller ID service.
 - “**Private caller**”: The caller requests not to send caller information.
 - “**Long distance**”: The caller makes a long distance call.
- If the unit is connected to a PBX system, caller information may not be properly received. Contact your PBX supplier.

Missed calls

Handset / Base unit

If a call is not answered, the unit treats it as a missed call. The display shows “**Missed call**”.

Note:

- Even when there are unviewed missed calls, “**Missed call**” disappears from the standby display if the following operation is performed by one of the units:
 - A handset is replaced on the charger.
 - Pressing **[OFF]** on a handset.
 - Pressing **[EXIT]** on the base unit.

Phonebook name display

When caller information is received and it matches a phone number stored in the phonebook, the stored name in the phonebook is displayed and logged in the caller list.

Talking Caller ID

Handset / Base unit

This feature lets you know who is calling without looking at the display.

To use this feature, you must:

- subscribe to a Caller ID service of your phone service provider.
- turn this feature on (page 29).

When caller information is received, the handsets and/or base unit announce the caller’s name or phone number received from your phone service provider following every ring.

The unit announces in English only.

- Name pronunciation may vary. This feature may not pronounce all names correctly.
- Caller ID service has a limit of how many characters can be displayed. If the caller’s name is too long, the unit may not be able to display or announce the entire name.

Phonebook name announcement

When caller information is received and it matches a phone number stored in the phonebook, the stored name in the phonebook is announced.

Caller list

Important:

- Make sure the unit’s date and time setting is correct (page 13).

Viewing the caller list and calling back

Handset / Base unit

- 1 Proceed with the operation for your unit.
Handset: **[▼]** CID
Base unit: **[CID]**
- 2 Press **[▼]** to search from the most recent call, or **[▲]** to search from the oldest call.
- 3 Proceed with the operation for your unit.
Handset:
 - To call back, press **[↶]**.
 - To exit, press **[OFF]**.**Base unit:**
 - To call back, lift the corded handset.
 - To exit, press **[EXIT]**.

Caller ID Service

Note for handset and base unit:

- If the entry has already been viewed or answered, “✓” is displayed.
- In step 1, you can also access the caller list as follows:

Base unit:

[CALL LOG] → [↕]: “Incoming call” → [SELECT]

Editing a caller’s phone number

You can edit a phone number in the caller list by removing its area code and/or the long distance code “1”.

Handset

- 1 [▼] CID
- 2 [↕]: Select the desired entry. → [MENU]
- 3 [↕]: “Edit” → [SELECT]
- 4 Press [EDIT] repeatedly until the phone number is shown in the desired format.
- 5 [↶]

Base unit

- 1 [CID]
- 2 [↕]: Select the desired entry.
- 3 Press [EDIT] repeatedly until the phone number is shown in the desired format.
- 4 Lift the corded handset.

Caller ID number auto edit feature

Handset / Base unit

Once you call back an edited number, the unit which was used to call back remembers the area code and format of the edited number. The next time someone calls from the same area code, caller information is customized by the unit as follows:

- When the call is being received, the Caller ID number is displayed in the same format as the edited number.
- After the call has ended, the caller’s phone number is displayed in the same format as the edited number, when reviewed from the caller list.

For example, you can use this feature to set the unit to ignore the area code of callers in your area, so that you can call these local numbers using caller information without dialing the area code.

To activate this feature, you must edit an entry in the caller list, then call that number. After that, phone numbers from that caller’s area code are edited automatically.

This feature can be set for each unit (page 30). The default setting is “On”.

Note:

- Phone numbers from the 4 most recently edited area codes are automatically edited.

Erasing selected caller information

Handset / Base unit

- 1 Proceed with the operation for your unit.
Handset: [▼] CID
Base unit: [CID]
- 2 [↕]: Select the desired entry.
- 3 [ERASE] → [↕]: “Yes” → [SELECT]
- 4 Proceed with the operation for your unit.
Handset: [OFF]
Base unit: [EXIT]

Erasing all caller information

Handset / Base unit

- 1 Proceed with the operation for your unit.
Handset: [▼] CID
Base unit: [CID]
- 2 [ERASE] → [↕]: “Yes” → [SELECT]
- 3 Proceed with the operation for your unit.
Handset: [OFF]
Base unit: [EXIT]

Answering system

The answering system can answer and record calls for you when you are unavailable to answer the phone.

You can also set the unit to play a greeting message but not to record caller messages by selecting “**Greeting only**” as the recording time setting (page 45).

Important:

- Make sure the unit’s date and time setting is correct (page 13).

Memory capacity (including your greeting message)

The total recording capacity is about 17 minutes. A maximum of 64 messages can be recorded.

Note:

- When message memory becomes full:
 - “**Messages full**” is shown on the handset and base unit display.
 -  on the base unit flashes rapidly if the answering system is turned on.
 - If you use the pre-recorded greeting message, the unit automatically switches to another pre-recorded greeting message asking callers to call again later.
 - If you recorded your own greeting message, the same message is still announced to callers even though their messages are not recorded.

Turning the answering system on/off

Base unit

Press  to turn on/off the answering system.

Handset

- 1 To turn on:
[MENU]#327
To turn off:
[MENU]#328
- 2 [OFF]

Note for base unit and handset:

- When the answering system is turned on,  on the base unit lights up.

Greeting message

When the unit answers a call, a greeting message is played to callers.

You can use either:

- your own greeting message
- a pre-recorded greeting message

Recording your greeting message

You can configure this setting using either the base unit or one of the handsets.

Handset / Base unit

- 1 [MENU]#302
- 2 [↕]: “**Yes**” → [SELECT]
- 3 After a beep sounds, speak clearly about 20 cm (8 inches) away from the microphone (2 minutes max.).
- 4 Press [STOP] to stop recording.
- 5 Proceed with the operation for your unit.
Handset: [OFF]
Base unit: [EXIT]

Using a pre-recorded greeting message

The unit provides 2 pre-recorded greeting messages:

- If you reset to pre-recorded greeting or do not record your own greeting message, the unit plays a pre-recorded greeting asking callers to leave a message.
- If the message recording time (page 45) is set to “**Greeting only**”, callers’ messages are not recorded and the unit plays a different pre-recorded greeting message asking callers to call again.

Resetting to a pre-recorded greeting message

If you change into a pre-recorded greeting message once you record your own greeting message, your own recorded greeting message is erased.

You can configure this setting using either the base unit or one of the handsets.

Answering System

Handset / Base unit

- 1 [MENU]#304
- 2 [YES]
- 3 Proceed with the operation for your unit.
Handset: [OFF]
Base unit: [EXIT]

Playing back the greeting message

Handset / Base unit

- 1 [MENU]#303
- 2 Proceed with the operation for your unit.
Handset: To exit, press [OFF].
Base unit: To exit, press [EXIT].

Listening to messages

Important:

- If your phone service provider offers voicemail service, the voicemail service may answer calls before the base unit's built-in answering system has a chance to answer calls and record messages.
In this case, messages you expect to be recorded by the answering system will be recorded on the voicemail service. For more information, see "For landline voicemail service subscribers" (page 44).
- When using the base unit or handset to listen to messages, the noise reduction feature (page 16) is activated automatically in spite of the setting (NR is not displayed).

Using the base unit

When new messages have been recorded:

- [▶■] on the base unit flashes.
- "New message" is displayed.

Press [▶■] (PLAY).

- During playback, [▶■] on the base unit lights.
- If new messages have been recorded, the base unit plays back new messages.
- If there are no new messages, the base unit plays back all messages.

Operating the answering system during playback

Key	Operation
[▲] or [▼]	Adjust the speaker volume
[◀◀]	Repeat message* ¹
[▶▶]	Skip message
[PAUSE]	Pause message To resume playback, press [▶■].
[▶■] (STOP)	Stop playback
[ERASE]	Erase currently playing message

*¹ If pressed within the first 5 seconds of a message, the previous message is played.

Calling back (Caller ID subscribers only)

Lift the corded handset during playback.

- To edit the number before calling back, press [EDIT] repeatedly until the phone number is shown in the desired format (page 38).

Erasing all messages

Press [ERASE] 2 times while the unit is not in use.

Using the handset

When new messages have been recorded, "New message" is displayed.

1 To listen to new messages:

[MENU]#323

To listen to all messages:

[MENU]#324

2 When finished, press [OFF].

Note:

- To switch to the receiver, press [↶].
- You can also use the [PLAY] soft key, if displayed, to play new messages.

Operating the answering system

[MENU] → [↕]: "Answering device" → [SELECT]

Key	Operation
[▲] or [▼]	Adjust the receiver/speaker volume (during playback)
[1] or [◀]	Repeat message (during playback)* ¹

Key	Operation
[2] or [▶]	Skip message (during playback)
[3]	Enter the "Settings" menu
[4]	Play new messages
[5]	Play all messages
[6]	Play greeting message
[7][6]	Record greeting message
[8]	Turn answering system on
[PAUSE]	Pause message ^{*2}
[9] or [STOP]	Stop recording Stop playback
[0]	Turn answering system off
[X][4] ^{*3}	Erase currently playing message
[X][5]	Erase all messages
[X][6]	Reset to a pre-recorded greeting message

*1 If pressed within the first 5 seconds of a message, the previous message is played.

*2 To resume playback:

[↕]: "Playback" → [SELECT]

*3 You can also erase as follows:

[PAUSE] → [↕]: "Erase" → [SELECT]
→ [↕]: "Yes" → [SELECT]

Calling back (Caller ID subscribers only)

1 Press [PAUSE] during playback.

2 [↕]: "Call back" → [SELECT]

Editing the number before calling back

1 Press [PAUSE] during playback.

2 [↕]: "Edit & Call" → [SELECT]

3 Press [EDIT] repeatedly until the phone number is shown in the desired format (page 38). → [↶]

Erasing all messages

1 [MENU]# [3][2][5]

2 [↕]: "Yes" → [SELECT] → [OFF]

Advanced new message alerting features

Audible message alert

This feature allows the base unit to beep to inform you of a new message arrival when new messages are recorded. The base unit beeps 2 times every minute until you listen to the messages, if the "Base unit beep" setting is turned on. The default setting is "OFF".

You can configure this setting using either the base unit or one of the handsets.

Handset / Base unit

1 [MENU]# [3][3][9]

2 [↕]: Select the desired setting. → [SAVE]

3 Proceed with the operation for your unit.

Handset: [OFF]

Base unit: [EXIT]

New message alert by a call

This feature allows you to receive a notification by phone when new messages are recorded. The base unit calls a phone number you specify. You can then operate the answering system remotely to listen to the new message.

To use this feature, you must:

- store a phone number to which the unit makes the call to.
- turn on the new message alert setting.

After you answer the new message alert call, you can listen to messages from that call (page 43). You can configure this setting using either the base unit or one of the handsets.

Important:

- A new message alert is stopped 1 minute after the unit starts to call. The unit will not retry the call even if the call is not answered.

Storing a phone number to which the unit makes an alert call

Handset

■ From the phonebook:

1 [MENU]# [3][3][8]

Answering System

- 2 [↕]: "Notification to" → [SELECT] → [ADD]
- 3 [↕]: "Phonebook" → [SELECT]
- 4 [↕]: Select the desired phonebook entry. → [SAVE] → [OFF]

■ By entering a phone number:

- 1 [MENU]#338
- 2 [↕]: "Notification to" → [SELECT] → [ADD]
- 3 [↕]: "Manual" → [SELECT]
- 4 Enter the desired name (16 characters max.). → [OK]
- 5 Enter the desired number (24 digits max.). → [OK] → [SELECT] → [OFF]

Base unit

■ From the phonebook:

- 1 [MENU]#338
- 2 [↕]: "Notification to" → [SELECT] → [□□]
- 3 [↕]: Select the desired phonebook entry. → [SAVE] → [EXIT]

■ By entering a phone number:

- 1 [MENU]#338
- 2 [↕]: "Notification to" → [SELECT] → [EDIT]
- 3 Enter the desired name (16 characters max.). → [OK]
- 4 Enter the desired number (24 digits max.). → [OK] → [SELECT] → [EXIT]

Turning on/off the new message alert setting

Handset / Base unit

- 1 [MENU]#338
- 2 [↕]: "On/Off" → [SELECT]
- 3 [↕]: Select the desired setting. → [SAVE]
- 4 Proceed with the operation for your unit.
Handset: [OFF]
Base unit: [EXIT]

Editing the set phone number

Handset

- 1 [MENU]#338
- 2 [↕]: "Notification to" → [SELECT]

- 3 [MENU] → [↕]: "Edit" → [SELECT]
- 4 Edit the name if necessary (16 characters max.). → [OK]
- 5 Edit the phone number if necessary (24 digits max.). → [OK] → [SELECT] → [OFF]

Base unit

- 1 [MENU]#338
- 2 [↕]: "Notification to" → [SELECT] → [EDIT]
- 3 Edit the name if necessary (16 characters max.). → [OK]
- 4 Edit the phone number if necessary (24 digits max.). → [OK] → [SELECT] → [EXIT]

Erasing the set phone number

Handset

- 1 [MENU]#338
- 2 [↕]: "Notification to" → [SELECT]
- 3 [MENU] → [↕]: "Erase" → [SELECT]
- 4 [↕]: "Yes" → [SELECT] → [OFF]
 - The new message alert setting is turned off.

Base unit

- 1 [MENU]#338
- 2 [↕]: "Notification to" → [SELECT] → [ERASE]
- 3 [↕]: "Yes" → [SELECT] → [EXIT]
 - The new message alert setting is turned off.

Activating/inactivating the remote access code to play messages

If you activate this feature, you must enter the remote access code (page 43) to play the new message from the new message alert call. This is so that unauthorized parties cannot listen to your messages. The default setting is "Inactivate".

- "Inactivate": You can listen to the message by pressing [4] to play new messages (without entering the remote access code).
- "Activate": You must enter your remote access code and then press [4] to play new message.

Handset / Base unit

- 1 [MENU]#338
- 2 [↕]: "Remote code" → [SELECT]
- 3 [↕]: Select the desired setting. → [SAVE]

- 4 Proceed with the operation for your unit.
Handset: [OFF]
Base unit: [EXIT]

Listening to messages

After you answer the new message alert, you can listen to the messages as follows.

■ **When the remote access code is set to “Inactivate”:**

Press [4] to play the new message during the announcement.

■ **When the remote access code is set to “Activate”:**

- 1 Enter the remote access code (page 43) during the announcement.
- 2 Press [4] to play the new message.

Note:

- Within 10 seconds after listening to new messages, you can press [#][9] during the call to turn off the new message alert by a call feature.
- Even if the unit makes a new message alert call, the handset redial list does not show the record. However, on the base unit redial list it is shown as “Message alert”.

Remote operation

Using a touch-tone phone, you can call your phone number from outside and access the unit to listen to messages or change answering system settings. The unit’s voice guidance prompts you to press certain dial keys to perform different operations.

Remote access code

A 3-digit remote access code must be entered when operating the answering system remotely. This code prevents unauthorized parties from listening to your messages remotely. The default setting is “111”.

You can configure this setting using either the base unit or one of the handsets.

Important:

- To prevent unauthorized access to this product, we recommend that you regularly change the remote code.

Handset / Base unit

- 1 **[MENU][#][3][0][6]**
- 2 Enter the desired 3-digit remote access code.
- 3 **[SAVE]**
- 4 Proceed with the operation for your unit.
Handset: [OFF]
Base unit: [EXIT]

Deactivating remote operation

Press [X] in step 2 on “Remote access code”, page 43.

- The entered remote access code is deleted.

Using the answering system remotely

- 1 Dial your phone number from a touch-tone phone.
- 2 After the greeting message starts, enter your remote access code.
- 3 Follow the voice guidance prompts as necessary or control the unit using remote commands (page 43).
- 4 When finished, hang up.

Voice guidance

■ **When the English voice guidance is selected**

During remote operation, the unit’s voice guidance starts and prompts you to press [1] to perform a specific operation, or press [2] to listen to more available operations.

■ **When the Spanish voice guidance is selected**

To start the voice guidance, press [9]. The voice guidance announces the available remote commands (page 43).

Note:

- If you do not press any dial keys within 10 seconds after a voice guidance prompt, the unit disconnects your call.

Remote commands

You can press dial keys to access certain answering system functions without waiting for the voice guidance to prompt you.

Key	Operation
[1]	Repeat message (during playback)*1

Answering System

Key	Operation
[2]	Skip message (during playback)
[4]	Play new messages
[5]	Play all messages
[9]	Stop playback* ² Start voice guidance* ³
[0]	Turn answering system off
[*][4]	Erase currently playing message
[*][5]	Erase all messages
[*][#]	End remote operation (or hang up)

*1 If pressed within the first 5 seconds of a message, the previous message is played.

*2 For English voice guidance only

*3 For Spanish voice guidance only

Turning on the answering system remotely

- 1 Dial your phone number from a touch-tone phone.
- 2 Let the phone ring 15 times.
 - A long beep is heard.
- 3 Enter your remote access code within 10 seconds after the long beep.
 - The greeting message is played back.
 - You can either hang up, or enter your remote access code again and begin remote operation (page 43).

Answering system settings

Call screening

Handset / Base unit

While a caller is leaving a message, you can listen to the call through the unit's speaker.

To adjust the speaker volume, press [▲] or [▼] repeatedly.

You can answer the call by:

- lifting the corded handset from the base unit, or
- pressing [📞] on the handset.

Call screening can be set for each unit. The default setting is "On".

1 [MENU][#][3][1][0]

2 [↕]: Select the desired setting. → [SAVE]

3 Proceed with the operation for your unit.

Handset: [OFF]

Base unit: [EXIT]

Number of rings before the unit answers a call

You can change the number of times the phone rings "Ring count" before the unit answers calls. You can select 2 to 7 rings, or "To11 saver".

The default setting is "4 rings".

"To11 saver": The unit's answering system answers at the end of the 2nd ring when new messages have been recorded, or at the end of the 5th ring when there are no new messages. If you call your phone from outside to listen to new messages (page 43), you know that there are no new messages when the phone rings for the 3rd time. You can then hang up without being charged for the call.

You can configure this setting using either the base unit or one of the handsets.

Handset / Base unit

1 [MENU][#][2][1][1]

2 [↕]: Select the desired setting. → [SAVE]

3 Proceed with the operation for your unit.

Handset: [OFF]

Base unit: [EXIT]

For landline voicemail service subscribers

If you subscribe to a flat-rate service package that includes Caller ID, call waiting, voicemail, and unlimited local/regional/long distance calls, please note the following:

- To use the voicemail service provided by your phone service provider rather than the unit's answering system, turn off the answering system (page 39).
- To use this unit's answering system rather than the voicemail service provided by your phone service provider, please contact your phone service provider to deactivate your voicemail service.

If your phone service provider cannot do this:

- Set this unit's "Ring count" setting so that this unit's answering system answers calls before the voicemail service of your phone service provider does. It is necessary to check the number of rings required to activate

the voicemail service provided by your phone service provider before changing this setting.

- Change the number of rings of the voicemail service so that the answering system can answer the call first. To do so, contact your phone service provider.

Caller's recording time

You can change the maximum message recording time allowed for each caller. The default setting is "3 min".

You can configure this setting using either the base unit or one of the handsets.

Handset / Base unit

- 1 **[MENU]** **[#]** **[3]** **[0]** **[5]**
- 2 **[↕]**: Select the desired setting. → **[SAVE]**
- 3 Proceed with the operation for your unit.
Handset: [OFF]
Base unit: [EXIT]

Selecting "Greeting only"

You can select "Greeting only" which sets the unit to announce a greeting message to callers but not record messages.

Select "Greeting only" in step 2 on "Caller's recording time", page 45.

Note:

- When you select "Greeting only":
 - If you do not record your own message, the unit will play the pre-recorded greeting-only message asking callers to call again later.
 - If you use your own message, record the greeting-only message asking callers to call again later (page 39).

Useful Information

Voice mail service

Voice mail is an automatic answering service offered by your phone service provider. After you subscribe to this service, your phone service provider's voice mail system answers calls for you when you are unavailable to answer the phone or when your line is busy. Messages are recorded by your phone service provider, not your telephone. Please contact your phone service provider for details of this service.

Important:

- To use the voice mail service provided by your phone service provider rather than the unit's answering system, turn off the answering system (page 39). For details, see page 44.

Storing the voice mail (VM) access number

In order to listen to your voice mail messages, you must dial your phone service provider's voice mail access number. Once you have stored your voice mail access number, you can dial it automatically (page 46). You can configure this setting using either the base unit or one of the handsets.

Handset / Base unit

- 1 **[MENU]** **#** **3** **3** **1**
- 2 Enter your access number (24 digits max.). → **[SAVE]**
- 3 Proceed with the operation for your unit.
Handset: **[OFF]**
Base unit: **[EXIT]**

Note:

- When storing your voice mail access number and your mailbox password, press **[Δ]** (Pause) on the handset or **[PAUSE]** on the base unit to add pauses (page 14) between the access number and the password as necessary. Contact your phone service provider for the required pause time.

Example:

1-222-333-4444	PPPP	8888
VM access number	Pauses	Password

To erase the voice mail access number

Handset / Base unit

- 1 **[MENU]** **#** **3** **3** **1**
- 2 Press and hold **[CLEAR]** until all digits are erased. → **[SAVE]**
- 3 Proceed with the operation for your unit.
Handset: **[OFF]**
Base unit: **[EXIT]**

Voice mail (VM) tone detection

Handset / Base unit

Your phone service provider sends special signals (sometimes called "voice mail tones" or "stutter tones") to the unit to let you know you have new voice mail messages. If you hear a series of dial tones followed by a continuous dial tone after you press **[↶]** on the handset or lift the corded handset, you have new voice mail messages. Soon after you hang up a call or after the phone stops ringing, your unit checks the phone line to see if new voice mail messages have been recorded.

Turn this feature off when:

- You do not subscribe to voice mail service.
- Your phone service provider does not send voice mail tones.
- Your phone is connected to a PBX.

If you are not sure which setting is required, contact your phone service provider.

Turning VM tone detection on/off

The default setting is "On".

You can configure this setting using either the base unit or one of the handsets.

Handset / Base unit

- 1 **[MENU]** **#** **3** **3** **2**
- 2 **[↕]**: Select the desired setting. → **[SAVE]**
- 3 Proceed with the operation for your unit.
Handset: **[OFF]**
Base unit: **[EXIT]**

Listening to voice mail messages

When new messages have been recorded, "Voice mail msg. via phone co." is displayed if message indication service is available.

Handset / Base unit

- 1 **[MENU][#][3][3][0]**
 - The speakerphone turns on.
 - Lift the corded handset if needed.
- 2 Follow the pre-recorded instructions.
- 3 When finished, hang up.

Note:

- You can also use the **[ACCESS]** soft key, if displayed, to play new voicemail messages.
- If the handset and base unit still indicate there are new messages even after you have listened to all new messages, turn it off by pressing and holding **[#]** until the handset or base unit beeps.

Wall mounting

The base unit can be mounted on a wall by changing the wall mounting adaptor's position.

Note:

- Make sure that the wall and the fixing method are strong enough to support the weight of the unit.

Base unit

- 1 To remove the wall mounting adaptor, push down the release levers (1). Remove the adaptor (2).

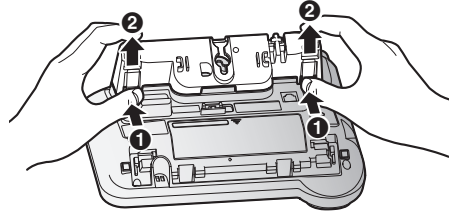

- 2
 - 1 Turn the adaptor so that the words "UP WALL" are facing up.
 - 2 Tuck the telephone line cord inside the wall mounting adaptor.
 - 3 Connect the AC adaptor cord and telephone line cord.

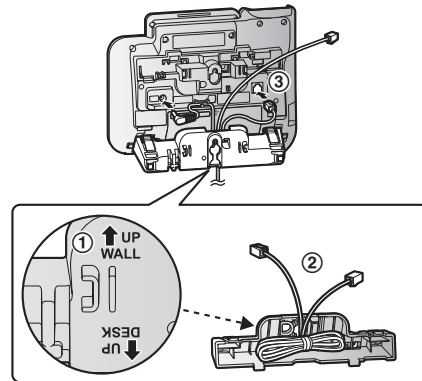

Useful Information

- 3** Insert the lower tabs of the adaptor into the unit's bottom slots (1), then insert by pushing down the levers of the adaptor into the upper slots (2).

- The words "UP WALL" should be facing up.

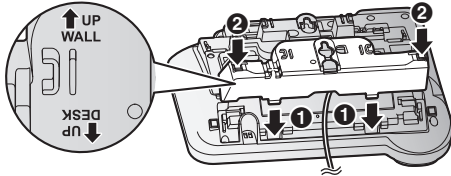

- 4** Mount the unit on a wall then slide down to secure in place.

- This product is compliant with the following wall phone plate sizes (2 types).

A 83 mm (3 1/4 inches)

B 102 mm (4 inches)

Fit the slots of the unit onto the corresponding wall phone plate tabs for (C) and (D) respectively.

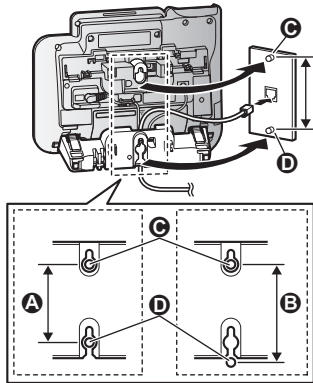

Charger

Drive the screws (A) (not supplied) into the wall.

B 27.2 mm (1 1/16 inches)

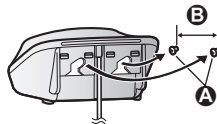

Error messages

Display message	Cause/solution
Ask phone company for VM access #	<ul style="list-style-type: none"> You have not stored the voicemail access number. Store the number (page 46).
Base no power or No link. Re-connect base AC adaptor.	<ul style="list-style-type: none"> Confirm the base unit's AC adaptor is connected to the unit and the power outlet correctly. The handset has lost communication with the base unit. Move closer to the base unit and try again. Unplug the base unit's AC adaptor to reset the unit. Reconnect the adaptor and try again. The handset's registration may have been canceled. Re-register the handset (page 36).
Busy	<ul style="list-style-type: none"> The called unit is in use. Other units are in use and the system is busy. Try again later. The handset you are using is too far from the base unit. Move closer and try again.
Check tel line	<ul style="list-style-type: none"> The supplied telephone line cord has not been connected yet or not connected properly. Check the connections (page 8).
Error!!	<ul style="list-style-type: none"> Recording was too short. Try again.
Invalid	<ul style="list-style-type: none"> There is no handset registered to the base unit matching the handset number you entered. The handset is not registered to the base unit. Register the handset (page 36).
Requires subscription to Caller ID.	<ul style="list-style-type: none"> You must subscribe to a Caller ID service. Once you receive caller information after subscribing to a Caller ID service, this message will not be displayed.
Use rechargeable battery.	<ul style="list-style-type: none"> A wrong type of battery such as alkaline or manganese was inserted. Use only the rechargeable Ni-MH batteries noted on page 4, 5.

Troubleshooting

If you still have difficulties after following the instructions in this section, disconnect the base unit's AC adaptor, then reconnect the base unit's AC adaptor. Remove the batteries from the handset, and then insert them into the handset again.

If the base unit batteries for power backup are installed, remove the batteries from the base unit, and then insert them into the base unit again.

General use

Problem	Cause/solution
The handset does not turn on even after installing charged batteries.	<ul style="list-style-type: none"> Place the handset on the charger to turn on the handset.



Useful Information

Problem	Cause/solution
The unit does not work.	<ul style="list-style-type: none"> ● Make sure the batteries are installed correctly (page 8). ● Fully charge the batteries (page 9). ● Check the connections (page 8). ● Unplug the base unit's AC adaptor to reset the unit. Reconnect the adaptor and try again. ● The handset has not been registered to the base unit. Register the handset (page 36).
I cannot hear a dial tone.	<ul style="list-style-type: none"> ● The base unit's AC adaptor or telephone line cord is not connected. Check the connections. ● Disconnect the base unit from the telephone line and connect the line to a known working telephone. If the working telephone operates properly, contact our service personnel to have the unit repaired. If the working telephone does not operate properly, contact your phone service provider.
The base unit beeps.	<ul style="list-style-type: none"> ● New messages have been recorded. Listen to the new messages (page 40).
The unit does not work during a power failure.	<ul style="list-style-type: none"> ● You can insert 2 AAA (R03) batteries (not supplied) into the base unit that will power the unit temporarily in the event of a power failure (page 9). ● The base unit display is blank if the saving mode is "On" (page 10).

Menu list

Problem	Cause/solution
The display is in a language I cannot read.	<ul style="list-style-type: none"> ● Change the display language (page 12).
I cannot register a handset to a base unit.	<ul style="list-style-type: none"> ● The maximum number of handsets (6) is already registered to the base unit. Cancel unused handset registrations from the base unit (page 36).

Battery recharge

Problem	Cause/solution
The handset beeps and/or  flashes.	<ul style="list-style-type: none"> ● Battery charge is low. Fully charge the batteries (page 9).
I fully charged the batteries, but <ul style="list-style-type: none"> –  still flashes, –  is displayed, or – the operating time seems to be shorter. 	<ul style="list-style-type: none"> ● Clean the battery ends (\oplus, \ominus) and the charge contacts with a dry cloth and charge again. ● It is time to replace the batteries (page 8).

Making/answering calls, intercom

Problem	Cause/solution
 is displayed.	<ul style="list-style-type: none"> ● The handset is too far from the base unit. Move closer. ● The base unit's AC adaptor is not properly connected. Reconnect AC adaptor to the base unit. ● The handset is not registered to the base unit. Register it (page 36).

Useful Information

Problem	Cause/solution
Noise is heard, sound cuts in and out.	<ul style="list-style-type: none"> You are using the handset or base unit in an area with high electrical interference. Re-position the base unit and use the handset away from sources of interference. Move closer to the base unit. If you use a DSL/ADSL service, we recommend connecting a DSL/ADSL filter between the base unit and the telephone line jack. Contact your DSL/ADSL provider for details.
The handset or base unit does not ring.	<ul style="list-style-type: none"> The ringer volume is turned off. Adjust the ringer volume (page 15, 29). Silent mode is turned on. Turn it off (page 15, 33).
I cannot make a call.	<ul style="list-style-type: none"> The dialing mode may be set incorrectly. Change the setting (page 13).
I cannot make long distance calls.	<ul style="list-style-type: none"> Make sure that you have long distance service.

Caller ID/Talking Caller ID

Problem	Cause/solution
Caller information is not displayed.	<ul style="list-style-type: none"> You must subscribe to Caller ID service. Contact your phone service provider for details. If your unit is connected to any additional telephone equipment such as a Caller ID box or cordless telephone line jack, plug the unit directly into the wall jack. If you use a DSL/ADSL service, we recommend connecting a DSL/ADSL filter between the base unit and the telephone line jack. Contact your DSL/ADSL provider for details. The name display service may not be available in some areas. Contact your phone service provider for details. Other telephone equipment may be interfering with this unit. Disconnect the other equipment and try again.
Caller information is displayed or announced late.	<ul style="list-style-type: none"> Depending on your phone service provider, the unit may display or announce the caller's information at the 2nd ring or later. Move closer to the base unit.
Caller information is not announced.	<ul style="list-style-type: none"> The ringer volume is turned off. Adjust the ringer volume (page 29). The Talking Caller ID feature is turned off. Turn it on (page 29). The number of rings for the answering system is set to "2 rings" or "Toll saver". Select a different setting (page 44). If the base unit and another handset are having an intercom call, your handset does not announce caller information.
The caller list/incoming phone numbers are not edited automatically.	<ul style="list-style-type: none"> The Caller ID number auto edit feature is turned off. Turn it on and try again (page 30). You need to call back the edited number to activate Caller ID number auto edit.
I cannot dial the phone number edited in the caller list.	<ul style="list-style-type: none"> The phone number you dialed might have been edited incorrectly (for example, the long distance "1" or the area code is missing). Edit the phone number with another pattern (page 38).
Time on the unit has shifted.	<ul style="list-style-type: none"> Incorrect time information from incoming Caller ID changes the time. Set the time adjustment to "Manual" (off) (page 29).

For assistance, please visit www.panasonic.com/support

51

Useful Information

Problem	Cause/solution
The 2nd caller's information is not displayed during an outside call.	<ul style="list-style-type: none"> In order to use Caller ID, call waiting, or Call Waiting Caller ID (CWID), you must first contact your phone service provider and subscribe to the desired service. After subscribing, you may need to contact your phone service provider again to activate this specific service, even if you already subscribed to both Caller ID and Call Waiting with Caller ID services (CWID).

Answering system

Problem	Cause/solution
The unit does not record new messages.	<ul style="list-style-type: none"> The answering system is turned off. Turn it on (page 39). The message memory is full. Erase unnecessary messages (page 40, 41). The recording time is set to "Greeting only". Change the setting (page 45). Your phone service provider's voicemail service may be answering your calls before the unit's answering system can answer your calls. Change the unit's number of rings setting (page 44) to a lower value, or contact your phone service provider. The answering system will not answer incoming calls while the other devices such as handsets are engaged in a call.
I cannot operate the answering system remotely.	<ul style="list-style-type: none"> The remote access code is not set. Set the remote access code (page 43). You are entering the wrong remote access code. If you have forgotten your remote access code, enter the remote access code setting to check your current code (page 43). The answering system is turned off. Turn it on (page 44).
The unit does not emit the specified number of rings.	<ul style="list-style-type: none"> If the ring once setting is turned off (page 20), the number of rings decreases by 1 from the specified number of rings.

Voicemail

Problem	Cause/solution
"Voicemail msg. via phone co." is shown on the display. How do I remove this message from the display?	<ul style="list-style-type: none"> This notification is displayed when your phone service provider's voicemail service (not the unit's answering system) has recorded a message for you. Typically you can remove this notification from the display by listening to the message. To listen to the message, dial the voicemail number provided by your phone service provider (for most cases, this will be your own phone number), and follow the voice instructions. Depending on your phone service provider, you may need to remove all messages from your voice mailbox to remove the notification. You can also remove this notification by pressing and holding # until the unit beeps.

Useful Information

Liquid damage

Problem	Cause/solution
Liquid or other form of moisture has entered the handset/base unit.	<ul style="list-style-type: none">● Disconnect the AC adaptor and telephone line cord from the base unit. Remove the batteries from the handset and leave to dry for at least 3 days. After the handset/base unit are completely dry, reconnect the AC adaptor and telephone line cord. Insert the batteries and charge fully before use. If the unit does not work properly, contact an authorized service center.

Caution:

- To avoid permanent damage, do not use a microwave oven to speed up the drying process.

Useful Information

FCC and other information

This equipment complies with Part 68 of the FCC rules and the requirements adopted by the ACTA. On the bottom of this equipment is a label that contains, among other information, a product identifier in the format US:ACJ-----.

If requested, this number must be provided to the telephone company.

- Registration No.....(found on the bottom of the unit)
- Ringer Equivalence No. (REN).....0.1B

A plug and jack used to connect this equipment to the premises wiring and telephone network must comply with the applicable FCC Part 68 rules and requirements adopted by the ACTA. A compliant telephone cord and modular plug is provided with the product. It is designed to be connected to a compatible modular jack that is also compliant.

The REN is used to determine the number of devices that may be connected to a telephone line. Excessive RENs on a telephone line may result in the devices not ringing in response to an incoming call. In most but not all areas, the sum of RENs should not exceed five (5.0). To be certain of the number of devices that may be connected to a line, as determined by the total RENs, contact the local telephone company. For products approved after July 23, 2001, the REN for the product is part of the product identifier that has the format US:AAAEQ##TXXXX. The digits represented by ## are the REN without a decimal point (e.g., 03 is a REN of 0.3).

If this equipment causes harm to the telephone network, the telephone company will notify you in advance that temporary discontinuance of service may be required. But if advance notice isn't practical, the telephone company will notify the customer as soon as possible. Also, you will be advised of your right to file a complaint with the FCC if you believe it is necessary.

The telephone company may make changes in its facilities, equipment, operations or procedures that could affect the operation of the equipment. If this happens the telephone company will provide advance notice in order for you to make necessary modifications to maintain uninterrupted service.

If trouble is experienced with this equipment, for repair or warranty information, please contact a Factory Service Center or other Authorized Servicer. If the equipment is causing harm to the telephone network, the telephone company may request that you disconnect the equipment until the problem is resolved.

Connection to party line service is subject to state tariffs. Contact the state public utility commission, public service commission or corporation commission for information.

If your home has specially wired alarm equipment connected to the telephone line, ensure the installation of this equipment does not disable your alarm equipment. If you have questions about what will disable alarm equipment, consult your telephone company or a qualified installer.

This equipment is hearing aid compatible as defined by the FCC in 47 CFR Section 68.316.

When you hold the phone to your ear, noise might be heard in your Hearing Aid. Some Hearing Aids are not adequately shielded from external RF (radio frequency) energy. If noise occurs, use an optional headset accessory or the speakerphone option (if applicable) when using this phone. Consult with your audiologist or Hearing Aid manufacturer about the availability of Hearing Aids which provide adequate shielding to RF energy commonly emitted by digital devices.

WHEN PROGRAMMING EMERGENCY NUMBERS AND/OR MAKING TEST CALLS TO EMERGENCY NUMBERS:

1. Remain on the line and briefly explain to the dispatcher the reason for the call.
2. Perform such activities in the off-peak hours, such as early morning or late evenings.

This device complies with Part 15 of the FCC Rules. Operation is subject to the following two conditions:

(1) This device may not cause harmful interference, and (2) this device must accept any interference received, including interference that may cause undesired operation.

Privacy of communications may not be ensured when using this phone.

CAUTION:

Any changes or modifications not expressly approved by the party responsible for compliance could void the user's authority to operate this device.

NOTE:

This equipment has been tested and found to comply with the limits for a Class B digital device, pursuant to Part 15 of the FCC Rules. These limits are designed to provide reasonable protection against harmful interference in a residential installation. This equipment generates, uses, and can radiate radio frequency energy and, if not installed and used in accordance with the instructions, may cause harmful interference to radio communications. However, there is no guarantee that interference will not occur in a particular installation. If this equipment does cause harmful interference to radio or television reception, which can be determined by turning the equipment off and on, the user is encouraged to try to correct the interference by one or more of the following measures:

- Reorient or relocate the receiving antenna.
- Increase the separation between the equipment and receiver.
- Connect the equipment into an outlet on a circuit different from that to which the receiver is connected.
- Consult the dealer or an experienced radio/TV technician for help.

Some cordless telephones operate at frequencies that may cause interference to nearby TVs and VCRs. To minimize or prevent such interference, the base of the cordless telephone should not be placed near or on top of a TV or VCR. If interference is experienced, move the cordless telephone further away from the TV or VCR. This will often reduce or eliminate interference.

FCC RF Exposure Warning:

- This product complies with FCC radiation exposure limits set forth for an uncontrolled environment.
- To comply with FCC RF exposure requirements, the base unit must be installed and operated 20 cm (8 inches) or more between the product and all person's body.
- This product may not be collocated or operated in conjunction with any other antenna or transmitter.

- The handset may be carried and operated with only the specific provided belt-clip. Other non-tested belt-clips or similar body-worn accessories may not comply and must be avoided.

Notice:

- FCC ID can be found inside the battery compartment or on the bottom of the units.

Compliance with TIA-1083 standard:

Telephone handsets identified with this logo have reduced noise and interference when used with T-Coil equipped hearing aids and cochlear implants.

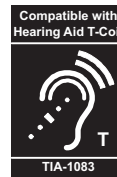

Charge only mode

The charge only mode is the dedicated mode to charge the backup batteries of the base unit. Do not use this mode if it is unnecessary because all functions except the base unit's battery charge is disabled with this feature on. Leave all the registered handsets on the chargers during use of the charge only mode.

■ **To activate the charge only mode:**

- 1 Disconnect the telephone line cord, the AC adaptor plug, and remove the batteries from the base unit with the corded handset placed on the cradle.
- 2 Press and hold **[3]**, **[4]**, and **[HOLD]** at the same time, then insert the AC adaptor plug to the base unit.
Keep on pressing these keys until:
 - a beep tone sounds, and
 - **[3]** and the SP-PHONE indicator once turn on and off.
- 3 Release these keys.
 - LCD turns off.
- 4 Insert batteries.
 - The batteries are started to be charged.

Note:

- If the LCD is still on when you release the keys, the base unit is not in the charging only mode. Repeat from step 1. The charge only mode is



Useful Information

canceled when the corded handset comes off during or after setting up.

■ **To deactivate the charge only mode:**

- Lift the corded handset from the base unit and replace it.
- Press any key.
- 24 hours passed after activating the charge only mode.

Guía Rápida Española

Conexiones

Unidad base

- ① Conecte el adaptador de corriente alterna a la unidad presionándolo firmemente.
- ② Conecte el cable de la línea telefónica a la unidad hasta que escuche un clic.
- ③ Enganche el cable del adaptador de corriente alterna y el cable de la línea telefónica para fijarlos.
- ④ Conecte el adaptador de corriente alterna a la toma de corriente.
- ⑤ Conecte el cable de la línea telefónica a la toma de una sola línea telefónica (RJ11C) hasta que escuche un clic.
- ⑥ Requiere un filtro DSL/ADSL (no incluido) si dispone de este tipo de servicio.
- ⑦ Conecte el cable del auricular alámbrico a este y a la unidad base hasta que escuche un clic.

Nota:

- Use solo el adaptador de corriente alterna Panasonic PNLV226 que se suministra.

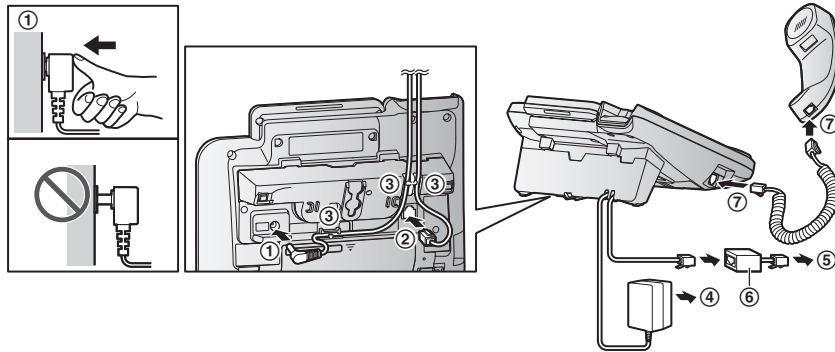

Cargador

- ① Conecte el adaptador de corriente alterna a la toma de corriente.

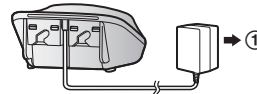

Instalación de la batería de la unidad portátil/cargado de la batería de la unidad portátil

Cargue aproximadamente durante 7 horas.

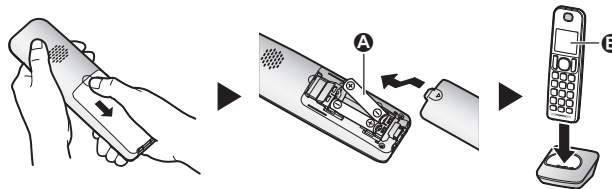

Nota:

- UTILICE SOLO baterías recargables de Ni-MH tamaño AAA (R03) (A).
- NO utilice baterías alcalinas, de manganeso ni de Ni-Cd.
- Confirme que las polaridades estén correctas (+, -).
- Cambie el idioma de la pantalla.
- Confirme que aparezca "Cargando" (B).

Sugerencias de operación

Teclas de función

Al oprimir una tecla de función, puede seleccionar la función que aparece directamente encima de ella en la pantalla. Preste atención a la pantalla para ver qué funciones están asignadas a las teclas de función durante la operación.

Tecla navegadora

Auricular:

- [▲], [▼], [◀], o [▶]: Navegue por diversas listas y elementos.
- VOL. (Volumen: [▲] o [▼]): Ajuste el volumen del receptor o el altavoz mientras habla.
- [◀] □□: Ver la entrada del directorio telefónico.
- [▶] REDIAL (Remarcación): Vea la lista de remarcación.
- [▼] CID (Identificador de llamadas): Vea la lista de personas que llamaron.

Unidad base:

- [▲], [▼], [◀◀] o [▶▶]: Navegue por diversas listas y elementos.
- VOL. (Volumen: [▲] o [▼]): Ajuste el volumen del receptor o el altavoz mientras habla.
- [◀◀]/[▶▶]: Repetir u omitir mensajes durante la reproducción.

Auricular

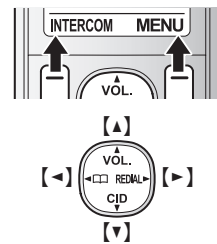

Unidad base

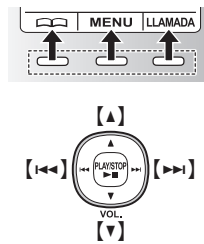

Cambio de idiomas (Auricular/Unidad base) (predeterminado: "English")

Cuando instale las baterías por primera vez, es posible que aparezca "Set date/time Press SELECT". Oprima [OFF]/[EXIT] para salir.

Idioma de la pantalla

- 1 [MENU]#110 → [↕]: "Español"
- 2 Continúe operando su unidad.
Auricular: [GUARDAR] → [OFF]
Unidad base: [GUARDA] → [EXIT]

Idioma de la guía de voz

- 1 [MENU]#112 → [↕]: "Español"
- 2 Continúe operando su unidad.
Auricular: [GUARDAR] → [OFF]
Unidad base: [GUARDA] → [EXIT]

Fecha y hora (Auricular/Unidad base)

- 1 [MENU]#101
- 2 Introduzca el día, mes y año actuales. → [OK]
- 3 Introduzca la hora y minuto actuales (formato de reloj de 24 horas).
- 4 Continúe operando su unidad.
Auricular: [GUARDAR] → [OFF]
Unidad base: [GUARDA] → [EXIT]

Grabación de su mensaje de saludo en el contestador automático (Auricular/ Unidad base)

Puede grabar su propio mensaje de saludo en lugar de usar uno pregrabado.

- 1** **[MENU]** **#** **3** **0** **2** → **[↕]**: “sí” → **[SELEC.]**
- 2** Después de que suene un pitido, hable con claridad en el micrófono a una distancia aproximada de 20 cm (8 pulgadas) (máx. de 2 minutos).
- 3** Oprima **[PARAR]** para dejar de grabar.
- 4** Continúe operando su unidad.
Auricular: **[OFF]**
Unidad base: **[EXIT]**

Operaciones básicas

Para hacer y contestar llamadas (Auricular/Unidad base)

Para hacer llamadas	Auricular: Marque el número telefónico. → [↶]/[☎] Unidad base: Marque el número telefónico. → Levante el auricular alámbrico u oprima [☎] .
Para contestar llamadas	Auricular: [↶]/[☎] Unidad base: Levante el auricular alámbrico u oprima [☎] .
Para colgar	Auricular: [OFF] Unidad base: Coloque el auricular alámbrico en la base. Cuando utilice el altavoz, oprima [☎] .
Para ajustar el volumen del receptor o del altavoz	Oprima [▲] o [▼] repetidamente mientras habla.
Cómo hacer una llamada usando la lista de remarcación	Auricular: [▶] REDIAL → [↕] : Seleccione la entrada deseada. → [↶] Unidad base: [REDIAL] → [↕] : Seleccione el número telefónico deseado. → Levante el auricular alámbrico.
Para ajustar el volumen del timbre	Oprima [▲] o [▼] repetidamente para seleccionar el volumen deseado mientras timbra.

Directorio telefónico (Auricular/Unidad base)

Para añadir entradas	1 Continúe operando su unidad. Auricular: [◀] □□ → [MENU] Unidad base: [□□] → [MENU] 2 [↕] : “Agregar Ent. Nueva” → [SELEC.] 3 Introduzca el nombre de la persona (máx. 16 caracteres). → [OK] 4 Introduzca el número telefónico de la persona (máx. 24 dígitos). → [OK] 5 [↕] : Seleccione el grupo deseado. → [SELEC.] 2 veces 6 Continúe operando su unidad. Auricular: [OFF] Unidad base: [EXIT]
Para hacer llamadas	1 Continúe operando su unidad. Auricular: [◀] □□ Unidad base: [□□] 2 [↕] : Seleccione la entrada deseada. 3 Continúe operando su unidad. Auricular: [↶] Unidad base: Levante el auricular con cable.

Guía Rápida Española

Operaciones básicas	
Contestador de llamadas (Unidad base)	
Contestador encendido/apagado	Oprima [ON] para encender y apagar el contestador de llamadas.
Para escuchar mensajes	[▶■] (PLAY)
Sistema contestador de llamadas (auricular)	
Para escuchar mensajes	Para escuchar mensajes nuevos: [REPRO.] o [MENU]#323 Para escuchar todos los mensajes: [MENU]#324
Preguntas frecuentes	
Pregunta	Causa y solución
¿Por qué aparece  ?	<ul style="list-style-type: none"> El auricular está demasiado lejos de la unidad base. Acérquelo. El adaptador para corriente de la unidad base no está conectado correctamente. Conecte de nuevo el adaptador para corriente a la unidad base. El auricular no está registrado en la unidad base. Regístrelo. <ol style="list-style-type: none"> Auricular: [MENU]#130 Unidad base: Oprima y mantenga oprimido [LOCATOR] durante aproximadamente 5 segundos. Auricular: Oprima [OK], y después espere hasta que suene un pitido largo.
¿Cómo se incrementa el nivel de volumen del auricular?	<ul style="list-style-type: none"> Oprima la tecla de volumen [▲] repetidamente mientras habla.
¿Por qué hay ruido o se corta la conversación?	<ul style="list-style-type: none"> Trate de reubicar la unidad base de forma que se minimice la distancia al auricular. Si ocurre el mismo problema aunque el auricular se encuentre enseguida de la unidad base, visite: www.panasonic.com/support
¿Es posible añadir otro auricular accesorio a mi unidad base?	<ul style="list-style-type: none"> Sí, puede añadir hasta 6 auriculares (incluyendo los que se venden con su unidad base) a una sola unidad base. Para adquirir auriculares accesorios adicionales (KX-TGFA30), visite: www.panasonic.com/accessories <p>Los usuarios TTY (usuarios con impedimentos auditivos o del habla) pueden llamar al 1-877-833-8855.</p>
¿Es posible mantener cargando las baterías todo el tiempo?	<ul style="list-style-type: none"> Puede dejar el auricular en el cargador el tiempo que lo desee. Esto no daña las baterías.
¿Cómo se contestan las llamadas en espera (2a llamada)?	<ul style="list-style-type: none"> Oprima [CALL WAIT] cuando escuche el tono de llamada en espera.

Customer services

Shop
Accessories!

for all your Panasonic gear

Go to

www.panasonic.com/accessories

Get everything you need to get the most out of
your Panasonic products

Accessories & Parts for your Camera, Phone, A/V
products, TV, Computers & Networking, Personal
Care, Home Appliances, Headphones, Batteries,
Backup Chargers & more...

Customer Services Directory

For Product Information, Operating Assistance,
Parts, Owner's Manuals, Dealer and Service info

go to www.panasonic.com/support

For the hearing or speech impaired TTY: 1- 877-833-8855

Warranty (For United States and Puerto Rico)

Panasonic Telephone Products Limited Warranty

Limited Warranty Coverage

If your product does not work properly because of a defect in materials or workmanship, Panasonic Corporation of North America (referred to as "the warrantor") will, for the length of the period indicated on the chart below, which starts with the date of original purchase ("Limited Warranty period"), at its option either (a) repair your product with new or refurbished parts, or (b) replace it with a new or a refurbished equivalent value product, or (c) refund your purchase price. The decision to repair, replace or refund will be made by the warrantor.

Parts
One (1) Year

Labor
One (1) Year

During the "Labor" Limited Warranty period there will be no charge for labor. During the "Parts" Limited Warranty period, there will be no charge for parts. You must mail-in your product prepaid during the Limited Warranty period. This Limited Warranty excludes both parts and labor for batteries, antennas, and cosmetic parts (cabinet). This Limited Warranty only applies to products purchased and serviced in the United States or Puerto Rico. This Limited Warranty is extended only to the original purchaser and only covers products purchased as new.

Mail-in Service--Online

Online Repair Request

To submit a new repair request and for quick repair status visit our web site at www.panasonic.com/repair

When shipping the unit carefully pack in a padded shipping carton, include all accessories, and send it prepaid. Include a letter detailing the complaint, a return address and provide a day time phone number where you can be reached. P.O. Boxes are not acceptable. Keep the tracking number for your records. A copy of valid registered receipt is required under the 1 year parts and labor Limited Warranty.

For Limited Warranty service for headsets if a headset is included with this product please follow instructions above.

IF REPAIR IS NEEDED DURING THE LIMITED WARRANTY PERIOD THE PURCHASER WILL BE REQUIRED TO FURNISH A SALES RECEIPT/PROOF OF PURCHASE INDICATING DATE OF PURCHASE, AMOUNT PAID AND PLACE OF PURCHASE. CUSTOMER WILL BE CHARGED FOR THE REPAIR OF ANY UNIT RECEIVED WITHOUT SUCH PROOF OF PURCHASE.

Limited Warranty Limits And Exclusions

This Limited Warranty ONLY COVERS failures due to defects in materials or workmanship, and DOES NOT COVER normal wear and tear or cosmetic damage. The Limited Warranty ALSO DOES NOT COVER damages which occurred in shipment, or failures which are caused by products not supplied by the warrantor, or failures which result from accidents, misuse, abuse, neglect, bug infestation, mishandling, misapplication, alteration, faulty installation, set-up adjustments, misadjustment of consumer controls, improper maintenance, power line surge, lightning damage, modification, introduction of sand, humidity or liquids, commercial use such as hotel, office, restaurant, or other business or rental use of the product, or service by anyone other than a Factory Service Center or other Authorized Servicer, or damage that is attributable to acts of God.

THERE ARE NO EXPRESS WARRANTIES EXCEPT AS LISTED UNDER "LIMITED WARRANTY COVERAGE". THE WARRANTOR IS NOT LIABLE FOR INCIDENTAL OR CONSEQUENTIAL DAMAGES RESULTING FROM THE USE OF THIS PRODUCT, OR ARISING OUT OF ANY BREACH OF THIS LIMITED WARRANTY. (As examples, this excludes damages for lost time, lost calls or messages, cost of having someone remove or re-install an installed unit if applicable, travel to and from the servicer. The items listed are not exclusive, but are for illustration only.) **ALL EXPRESS AND IMPLIED WARRANTIES, INCLUDING THE WARRANTY OF MERCHANTABILITY, ARE LIMITED TO THE PERIOD OF THE LIMITED WARRANTY.**

Some states do not allow the exclusion or limitation of incidental or consequential damages, or limitations on how long an implied warranty lasts, so the exclusions may not apply to you. This Limited Warranty gives you specific legal rights and you may also have other rights which vary from state to state. If a problem with this product develops during or after the Limited Warranty period, you may contact your dealer or Service Center. If the problem is not handled to your satisfaction, then write to the warrantor's Consumer Affairs Department at the addresses listed for the warrantor.

PARTS AND SERVICE, WHICH ARE NOT COVERED BY THIS LIMITED WARRANTY, ARE YOUR RESPONSIBILITY.

When you ship the product

- Carefully pack your unit, preferably in the original carton.
- Attach a letter, detailing the symptom.
- Send the unit to Panasonic Exchange Center, prepaid and adequately insured.
- Do not send your unit to Panasonic Corporation of North America listed on the back cover or to executive or regional sales offices. These locations do not repair consumer products.

Index

Index

- # 3-way conference: 16
- A** Additional handset: 36
 - Alarm: 32
 - Answering calls: 15
 - Answering system
 - Call screening: 44
 - Erasing messages: 40, 41, 44
 - Greeting message: 39
 - Greeting only: 45
 - Listening to messages: 40, 43
 - New message alerting: 41
 - Number of rings: 44
 - Recording time: 45
 - Remote access code: 43
 - Remote operation: 43
 - Ring count: 44
 - Toll saver: 44
 - Turning on/off: 39
 - Auto intercom: 18
 - Auto talk: 15, 30
- B** Baby monitor: 33
 - Battery: 8, 10
 - Battery saving mode: 10
 - Booster (Clarity booster): 16
- C** Call block: 19
 - One ring for blocked call: 20
 - Call share: 16, 31
 - Call waiting: 16
 - Call Waiting Caller ID: 16
 - Caller ID number auto edit: 30, 38
 - Caller ID service: 37
 - Caller list: 37
 - Caller list edit: 38
 - Chain dial: 24
 - CID (Caller ID): 37
 - Conference calls: 16
 - Control type: 11, 12
 - Customer support: 31
- D** Date and time: 13
 - Dialing mode: 13
 - Direct command code: 27
 - Display
 - Contrast: 30
 - Language: 12
- E** Eco mode: 10
 - Equalizer: 16
 - Error messages: 49
- F** Flash: 15, 31
- G** Groups: 23
- H** Handset
 - Deregistration: 36
 - Locator: 11
 - Name: 35
 - Registration: 36
 - Hold: 15
- I** Intercom: 18
- K** Key detector: 29, 31
 - Key tone: 30
- L** Line mode: 31
- M** Making calls: 14
 - Missed calls: 37
 - Mute: 15
- N** Noise reduction: 16
- O** One-touch dial buttons: 25
- P** Pause: 14
 - Phonebook: 22
 - Power failure (power backup operation): 9
- R** Redialing: 14
 - Ringer ID: 23
 - Ringer tone: 29
 - Rotary/pulse service: 16
- S** Silent mode: 33
 - Speed dial: 24
 - SP-PHONE (Speakerphone): 14
- T** Talking Caller ID: 37
 - Temporary tone dialing: 16
 - Time adjustment: 29
 - Transferring calls: 16
 - Troubleshooting: 49
 - TTY: 61
- V** VM (Voicemail): 46
 - Voice guidance language: 13
 - Voicemail: 44, 46
 - Volume
 - Receiver: 14
 - Ringer (Base unit): 15, 29
 - Ringer (Handset): 15, 29
 - Speaker: 14
- W** Wall mounting: 47

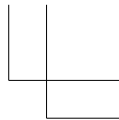
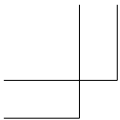

Notes

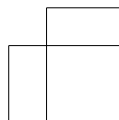
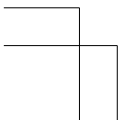
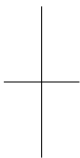

Notes

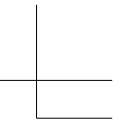
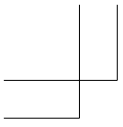

Notes

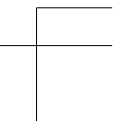
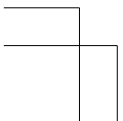
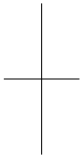

IMPORTANT!

If your product is not working properly. . .

- ① Reconnect AC adaptor to the base unit.
- ② Check if telephone line cord is connected.
- ③ Use rechargeable Ni-MH batteries.
(Alkaline/Manganese/Ni-Cd batteries CANNOT be used.)
- ④ Read **troubleshooting** page in the **Operating Instructions**.



Visit our Web site: www.panasonic.com/support

- FAQ and troubleshooting hints are available.

For your future reference

We recommend keeping a record of the following information to assist with any repair under warranty.

Serial No.	Date of purchase
(found on the bottom of the base unit)	
Name and address of dealer	

Attach your purchase receipt here.

Panasonic Corporation of North America
Two Riverfront Plaza, Newark, NJ 07102-5490

© Panasonic System Networks Co., Ltd. 2014

Printed in China



PNQX6715ZA

PNQX6715ZA TT1114KT0 (E)