



DIY Beach Chair

Copyright © 2014 Shanty-2-Chic.com

Supply List

Item	Quantity	Description
1 x 6 x 26"	1	Hopefully you have a scrap piece available for this
1 x 6 x 6'	1	Pine or whitewood board
1 x 2 x 8'	4	Pine or whitewood board
1 x 4 x 8'	4	Pine or whitewood board
1 x 3 x 8'	3	Pine or whitewood board
Brad nails	handful	
1-1/4" wood screws	about 1lb	
1-1/4" pocket hole screws	16	
Wood glue		
2-1/2" wood scrwes	4	optional for the footrest
Wood filler		The stainable and paintable kind

Use this layout as a general guide for cutting your pieces. It is always a good idea to cut and fit your parts as you build.

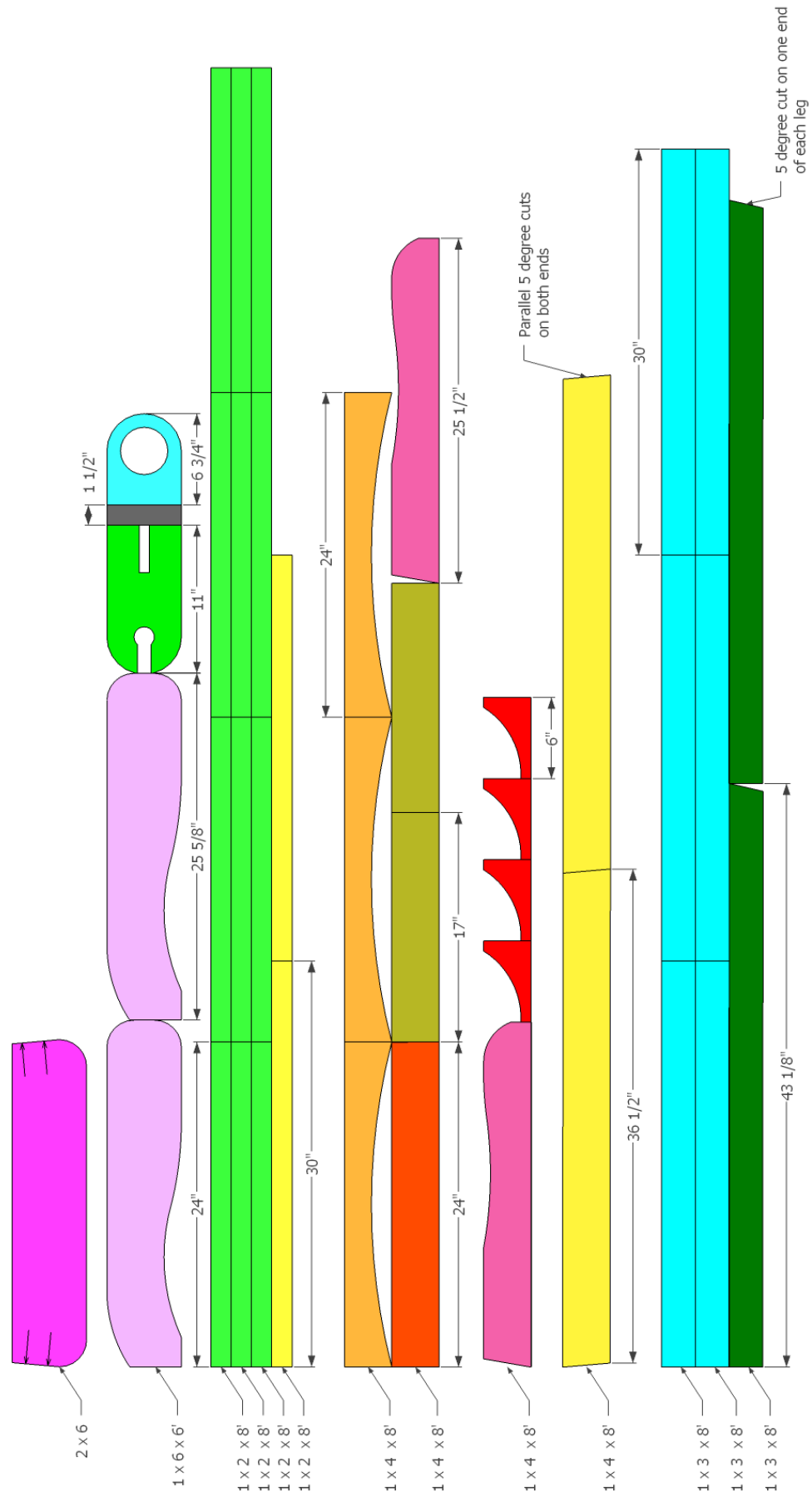

The following diagrams show the general dimensions for the curved parts. All of the curved cuts can be completed with a jigsaw and then sanded smooth. Feel free to modify any of the shapes as you prefer. For rounded corners you can trace a stain or spray paint can.

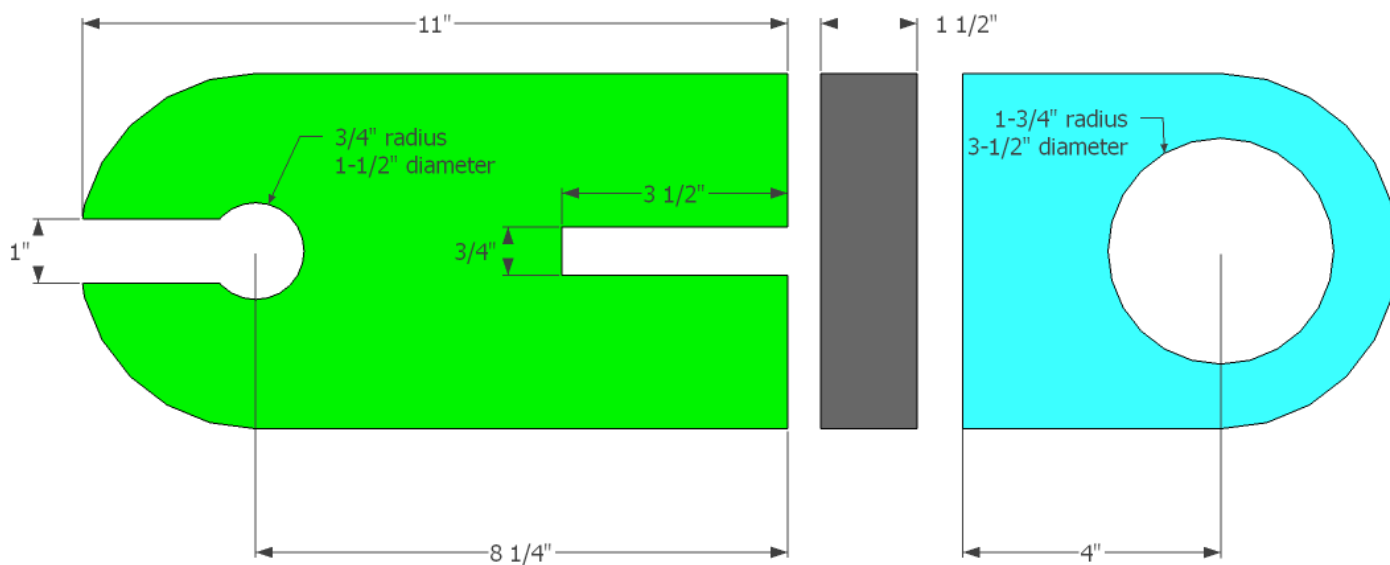
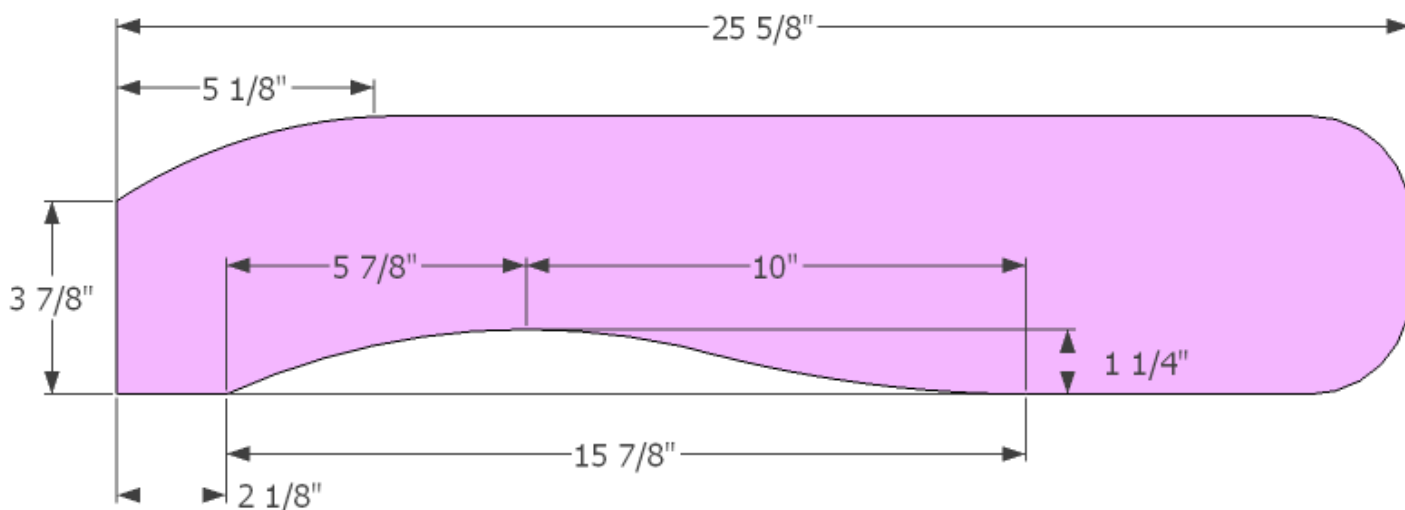
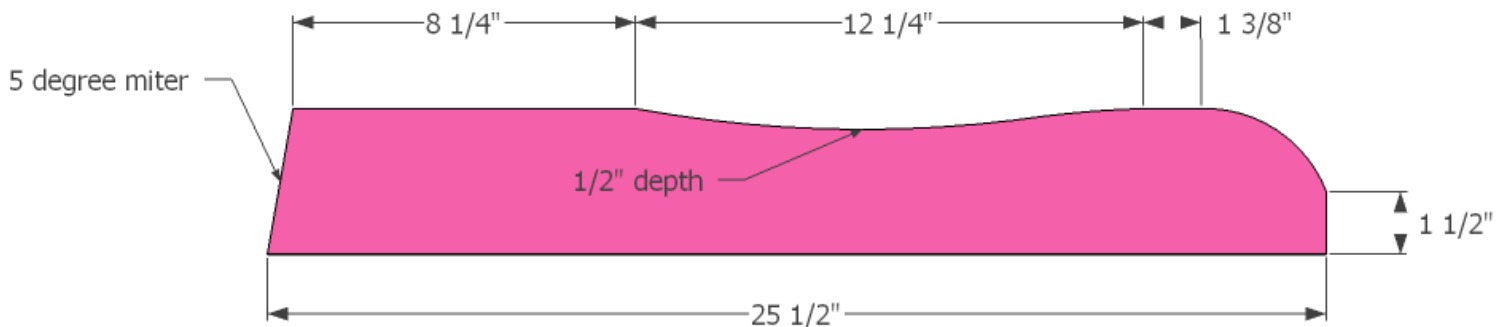
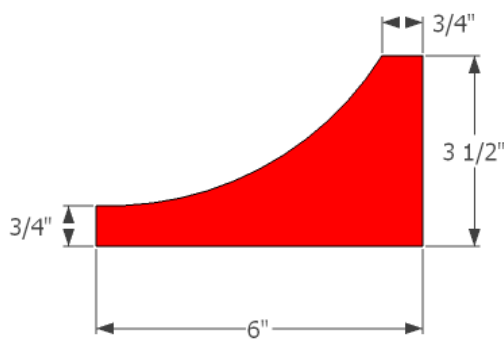

The three curved mounts for the back slats should be cut identical and oversized at first. This will ensure that the radius of the curve is identical on all three pieces.

First, cut three pieces identical to the top image in this diagram. Then, when needed, cut each piece down to the correct length as shown in following three images. Make sure the parts remain symmetrical and that they are cut to length by measuring from the center out.

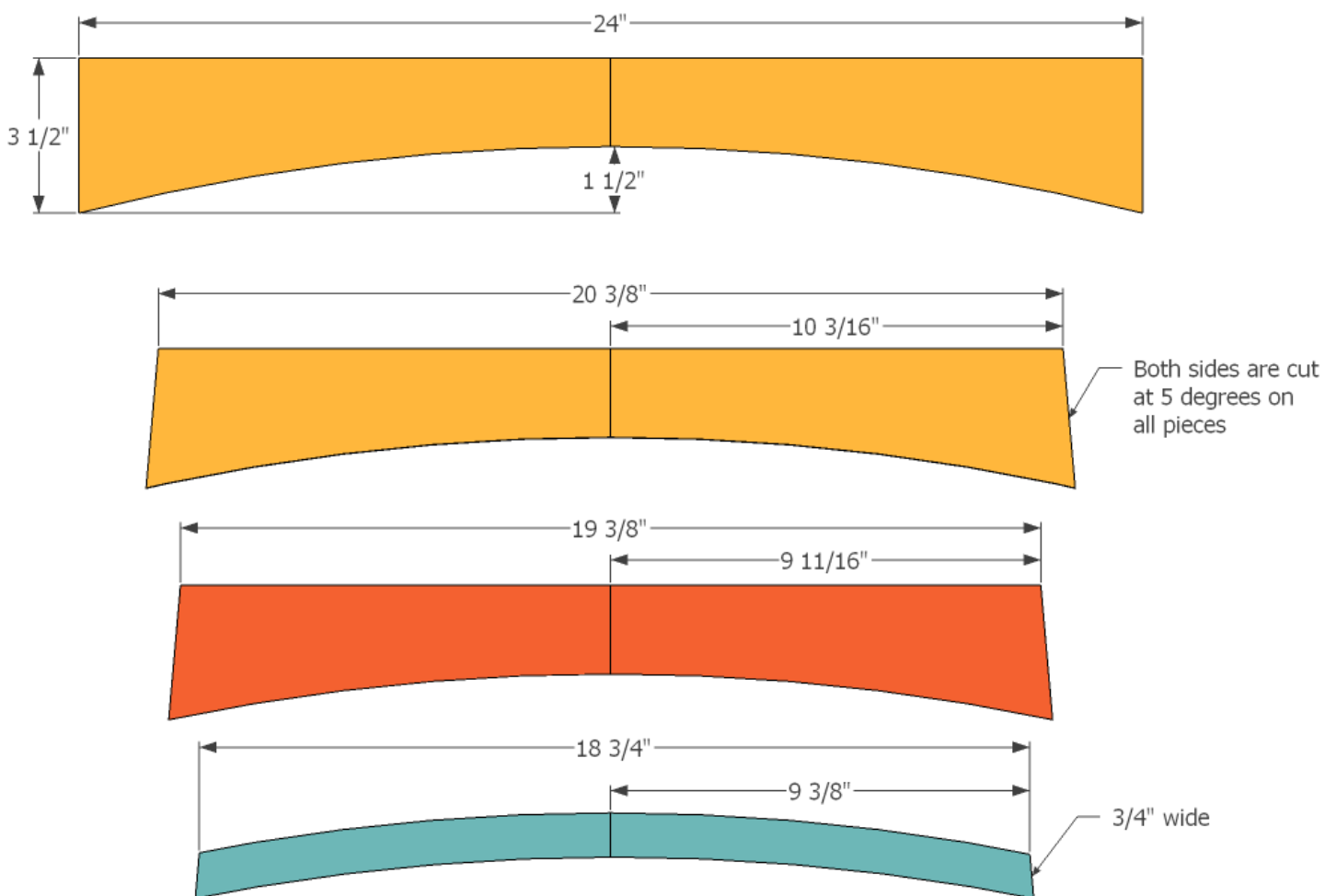

The footrest can be attached with 1-1/4" pocket hole screws from below or predrilled and screwed on from the outside of the legs with 2-1/2" screws.

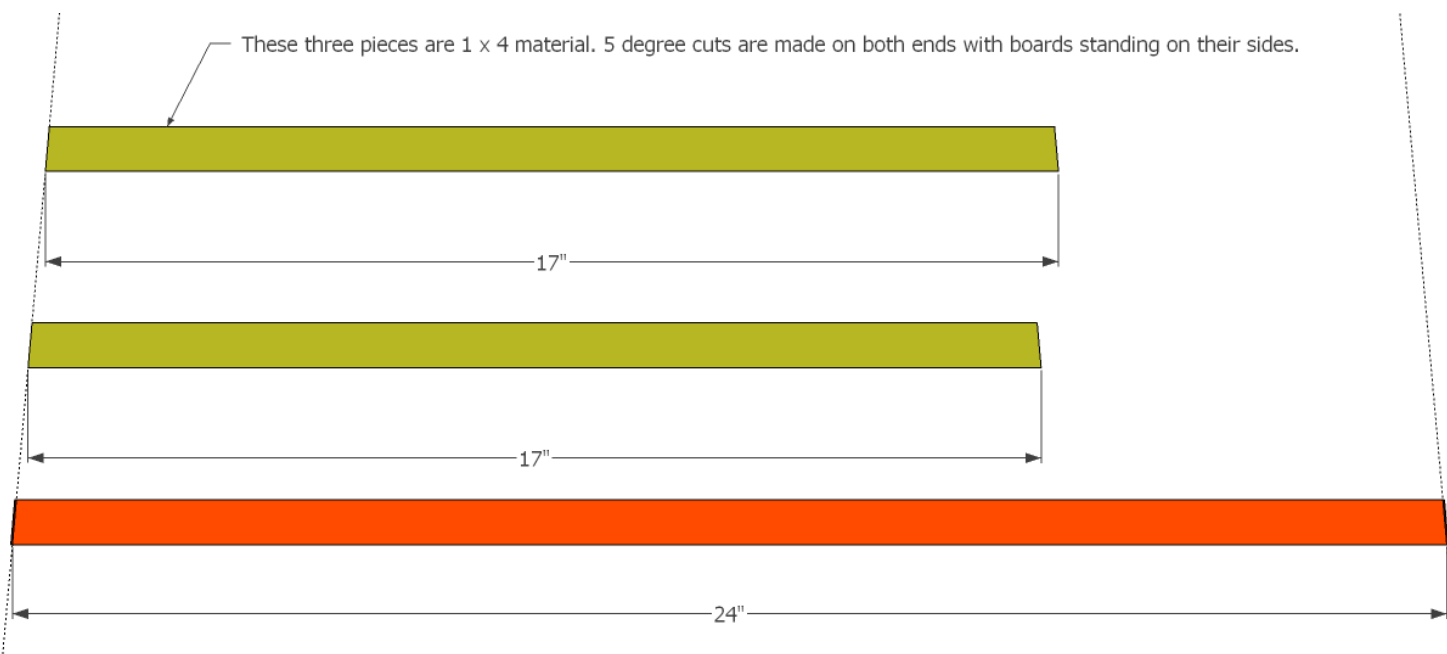
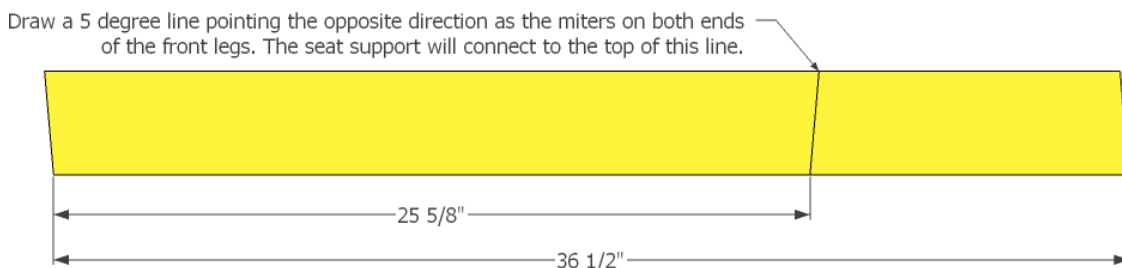
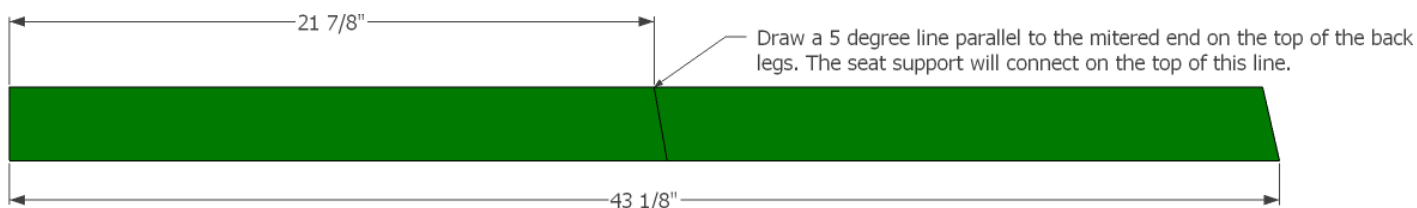

1

It is important to get the legs lined up identical of one another. Use the reference lines noted in the above diagrams to locate and attach the seat support pieces. The seat supports should stick out 3/4" from the front legs (yellow). Use glue and a few 1-1/4" wood screws to secure them. It is a good idea to use a couple brad nails to prevent the pieces from moving while you predrill for the screws. Make sure the screw heads will be on the inside of the chair.

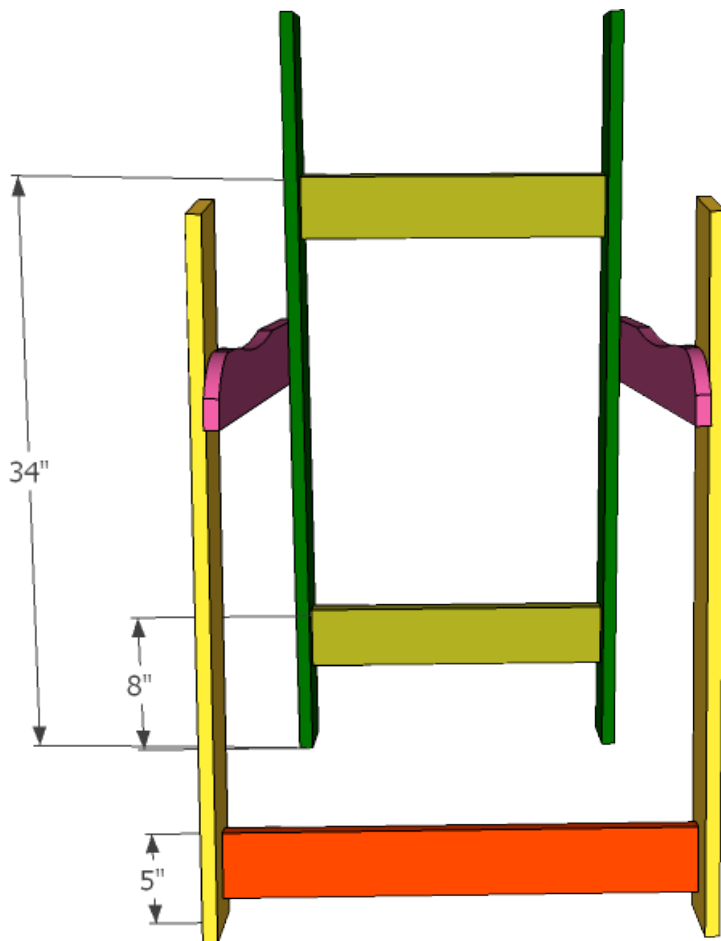
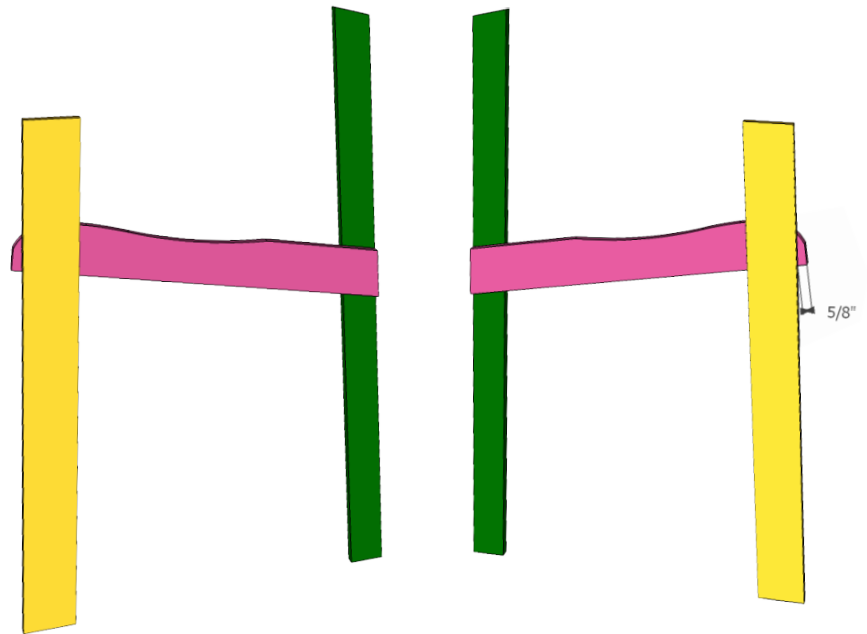

2

Connect the leg assemblies with the leg stretchers using 1-1/4" pocket hole screws. Because the ends of these boards are cut at a 5 degree angle the stop collar on the drill bit should be moved 1/8" closer to the tip of the drill bit when drilling these pocket holes. These boards should be centered on the legs. The height can be adjusted to your liking but I included a few dimensions for reference.

3

Next, add the first two back slat supports. The front of the lower support should be 7-1/2" from the top back corner of the seat support. The upper back slat support should be centered. Pre-drill and use glue and screws to secure both pieces.

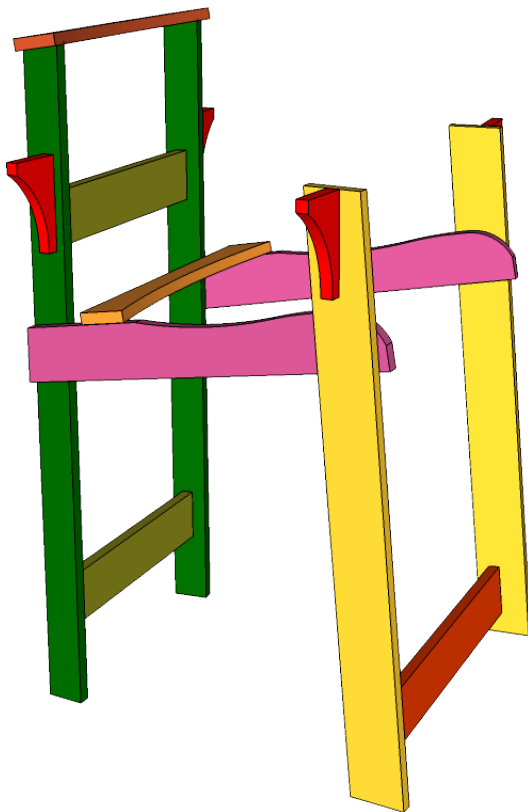
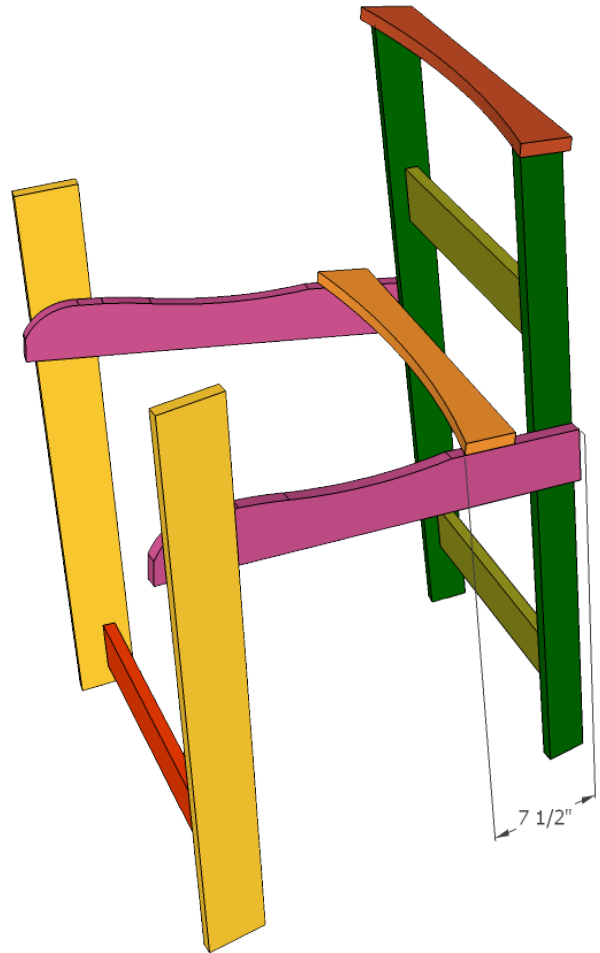

4

Add the front two arm braces first. Their top lines up with the top of the front legs and are centered on the front legs. These brackets should be vertical. Pre-drill and use glue and two 1-1/4" screws from the inside of the legs to secure them. Then either use a level or measure and transfer the height of the front braces to the back legs for the back braces. They are attached the same way. These can be placed near the inside edge of the back legs if needed.

5

Pre-drill and attach the arms with wood glue and screws through the inside of the back legs as well as through the top of the arms into the braces and front leg. These holes can be filled with stainable/paintable wood putty. It is very important to pre-drill these holes first so the braces won't crack.

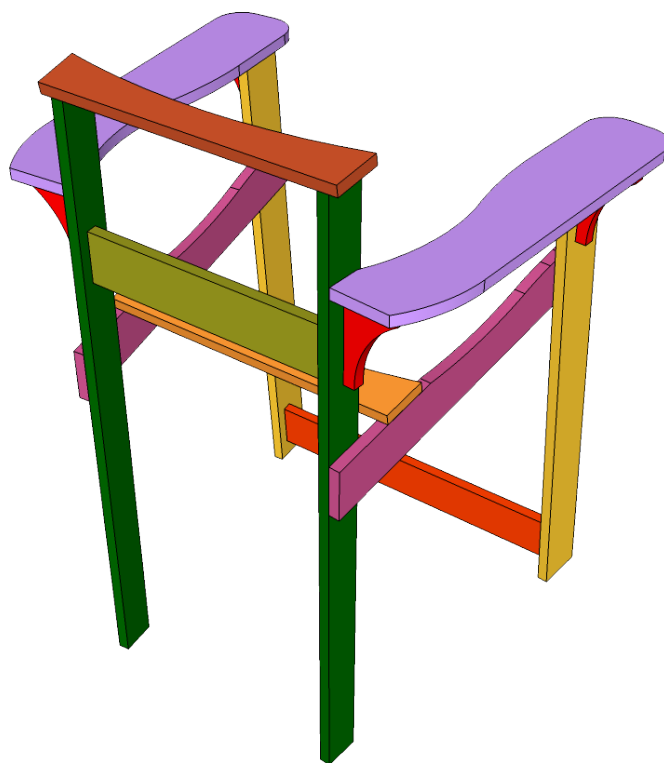

6

This step may be easier with the chair laying on it's back. Evenly space the slats at the bottom. Pre-drill and secure them with wood glue and 1-1/4" screws. Before the glue has time to cure spread the tops of the back slats out as you wish. With the slats in their final position pre-drill and secure them to the top curved support with 1-1/4" screws.



Add the final top brace to the back of the back slats. Pre-drill and use glue and 1-1/4 wood screws. Then, draw an arc on the top of the back slats and cut it out with a jigsaw. Feel free to make this curve any shape you wish.

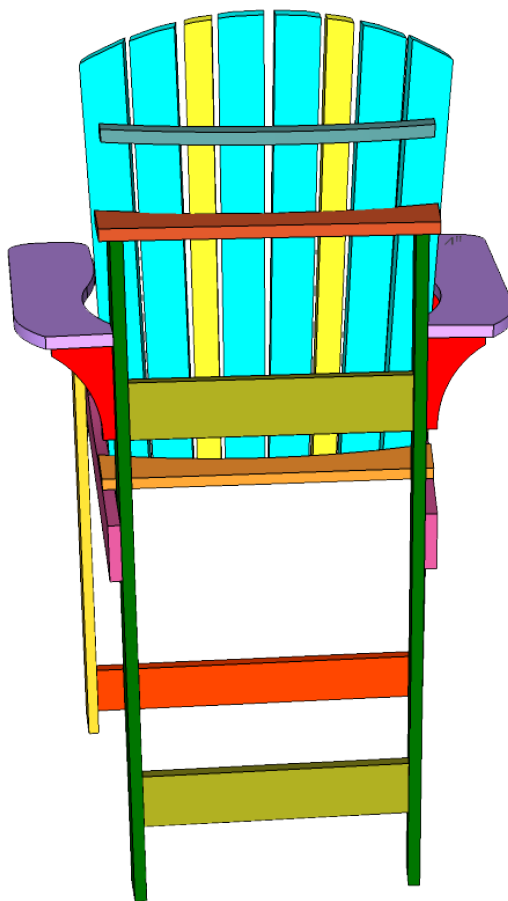

Cut and fit the first two seat slats in front. Pre-drill and attach these with glue and 1-1/4" wood screws. Then evenly space the rest of the seat slats. Use a pencil to mark the correct length from below. Cut them to length with 5 degree miters on each end.

9

Predrill and attach the seat slats with wood glue and 1-1/4" wood screws.

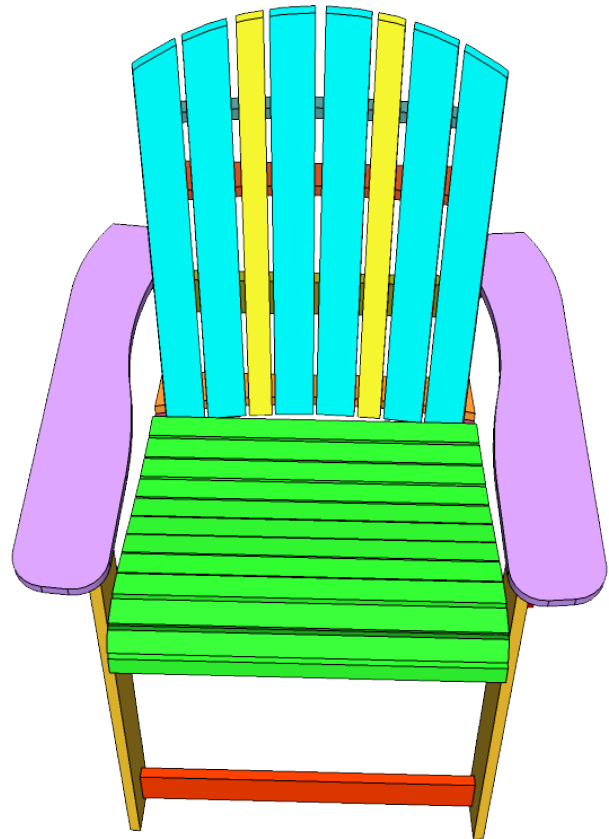

10

Add the foot rest to the height of your choice. Either predrill from the outside and attach it with wood glue and 2-1/2" wood screws from the outside of the legs or use glue and 1-1/4" pocket hole screws from below.

11

This step is optional. There is enough 1 x 6 material left to make this handy slide on cup and wine glass holder. For parts dimensions see the diagrams in the beginning. To assemble, screw the spacer to the bottom of the cup holder. Predrill and use glue and 1-1/4" wood screws. Then do the same from the bottom of the wine holder piece into the spacer. This will make all of the screws hidden.

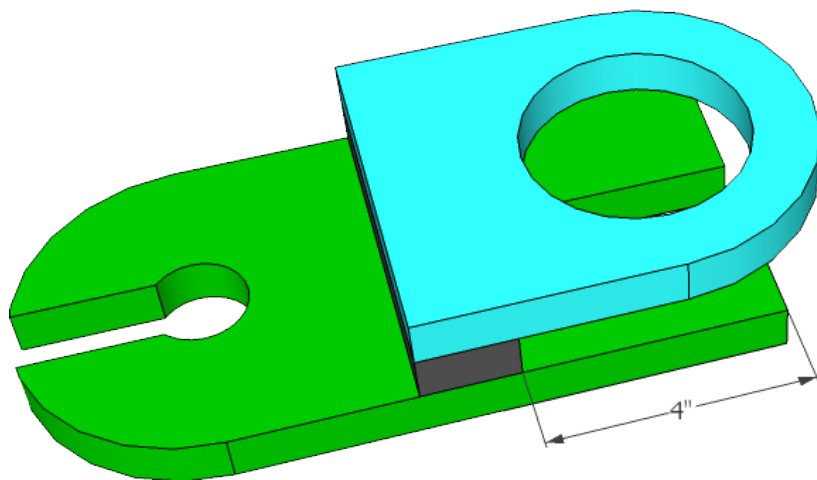

12

The cool thing about the beverage holder is that it just slides onto the arms where the arm brace is. When it's not needed you can hang it from the upper leg stretcher behind the seat. That way it's out of the way when not needed and within an arms reach when needed. We really hope you enjoy this project and would love for you to build one too. If you do build one be sure to stop by our website and let us know!