

# HATCHING HOPE



DIY CHICKEN COOP

## Step-By-Step Building Guide



# Chicken Coop Plans



## Supplies:

- 2- 4x4 Posts (120")
- 9- 2x4's (96")
- 10- 2x2's (96")
- 4- Sheets Plywood Siding (4' x 8')
- 1- 72" Piano Hinge
- 1- 30" Piano Hinge
- 3- Sheets 1/2" OSB Plywood (4' x 8')
- 12- 2x4 Brackets (Simpson FB24Z ZMAX)
- 1- 2x8 (72")
- 15- 1x2 (96") For Trim
- Red Outdoor Paint
- White Outdoor Paint
- Roofing of Your Choice
- Screws (2-1/2" should work great)
- 2- Window Bolts
- Hook for Your Basket

## Tools Needed:

- Miter Saw
- Impact Driver
- Staple Gun
- Reciprocating Saw or Jig Saw
- Circular Saw or Table Saw (to cut your plywood)
- Kreg Jig (optional, but highly recommended)
- Measuring Tape and Pencil
- Eye and Ear Protection
- Wood Glue

# Chicken Coop Plans

## Cut List:

### 4x4

- 4- 50-1/2" one end cut 30° (measurement is on short side of angle)

### 2x4

- 2- 41"
- 1- 45"
- 2- 89"
- 2- 18" cut 30° on one end, and 60° on the other end, with 1/2" left square (see pg 7-8)
- 2- 14-1/2" cut 30° on one end, and 60° on the other end, with 3/4" left square (see pg 7-8)
- 1- 92" with 3-1/2" notch on side (see pg 9)
- 1- 32"

### Plywood Siding

- 2- 92"x4-1/2"
- 1- 92"x23"
- 2- 46"x22-1/2"
- 2- 46-1/4"x48" (see pg 10)
- 1- 32-1/2"x16-1/2"
- 2- 18"x16-1/2" (cut at 20°) with 3-1/2"x1-1/2" notch (see plans, pg 13)

### 2x2

- 2- 41"
- 2- 85"
- 4- 19"
- 4- 89"
- 2- 13"
- 4- 14-1/2" one end cut 30° (on LONG side)
- 4- 14-1/2" one end cut 30° (on SHORT side)
- 4- 18" one end cut 30° (on LONG side)
- 2-16-1/2"
- 1- 32"
- 2- 13"
- 2- 16" (cut at 30° parallel on both ends)

### 1/2" OSB Plywood

- 1- 92"x48" with 3 1/2" notches cut from each corner and on sides (see pg 5)
- 2- 14-1/2"x96"
- 2-17-3/4"x96"
- 1- 32-1/2"x18" (nesting box floor)
- 1- 33-1/2"x18-1/2" (nesting box roof)

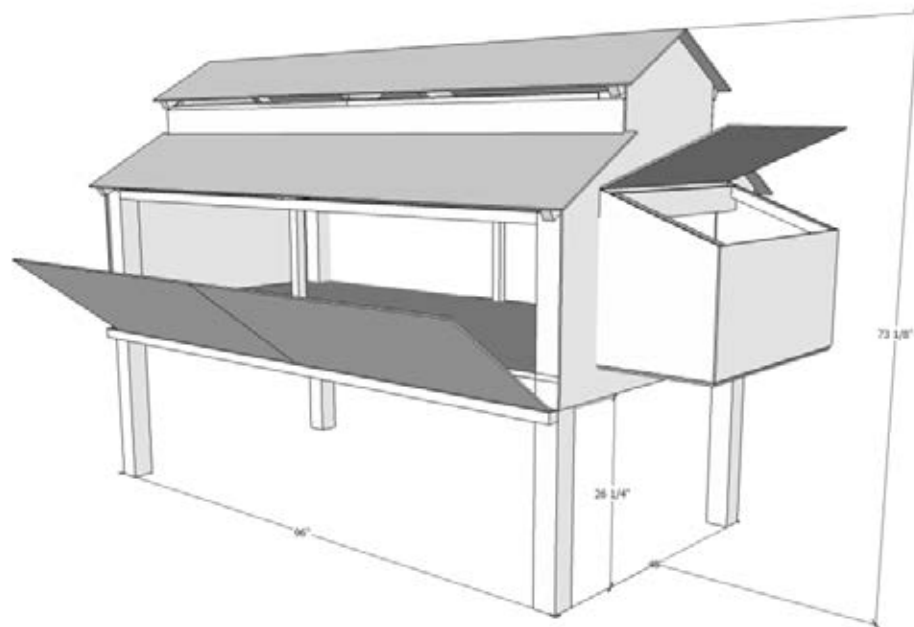

# Step 1

## BUILD FRAME END PIECES AND FLOOR

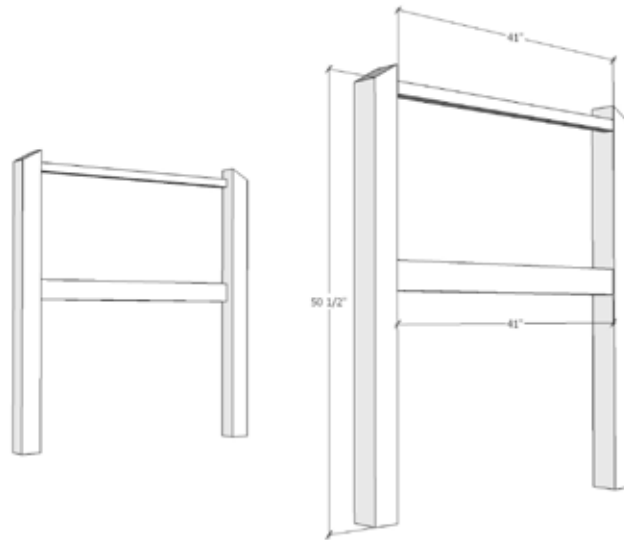

Start by cutting your 4x4's (50-1/2" on short side of angle) with a 30-degree angle on top. Attach your 2x4 (41") cross braces with fence brackets. You will build two of these for the ends.

After you have both ends built, hook them together with 2x4 (85") stretchers, and a 2x4 (45") across the middle to support the chicken coop floor.

Screw the middle 2x4 onto the side board with grabber screws, no need to use a bracket.

## Step 2

### ADD PLYWOOD FLOOR

Trim one end of the plywood floor so it measures, 92"x48". After it's cut to size, use a reciprocating saw and cut 3-1/2"x3-1/2" notches in the corners to fit around your 4x4 corner posts.

Place the plywood on the frame and staple the plywood down to the 2x4's.

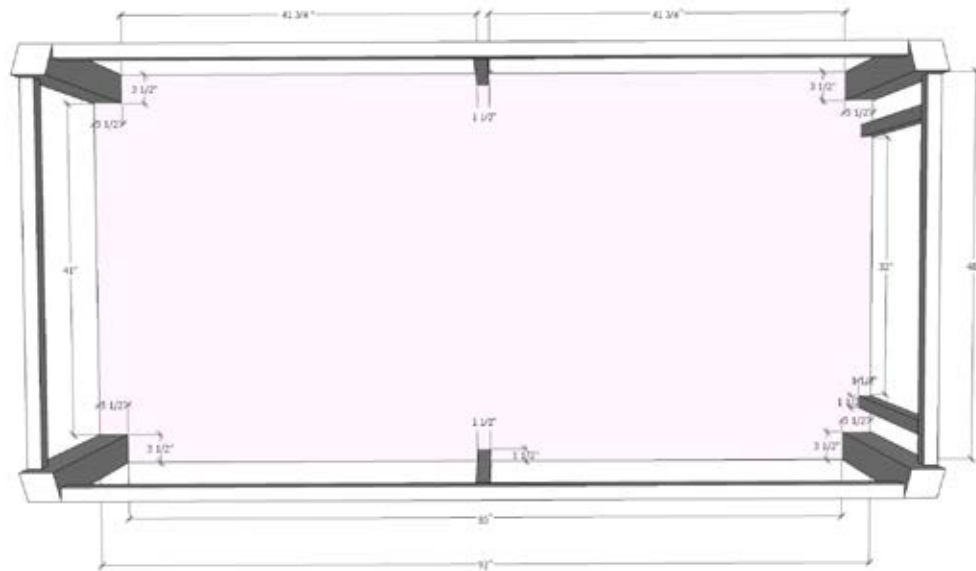

## Step 3

### ADD SUPPORTS

To add the supports add 2x2 horizontal (85" on the sides and 41" on the ends) and vertical (19") supports to the sides. Attach the 2x4's using brackets, and attach the 2x2's using pocket holes. Create pocket holes using a Kreg Jig, or you can freehand pocket holes with a drill.

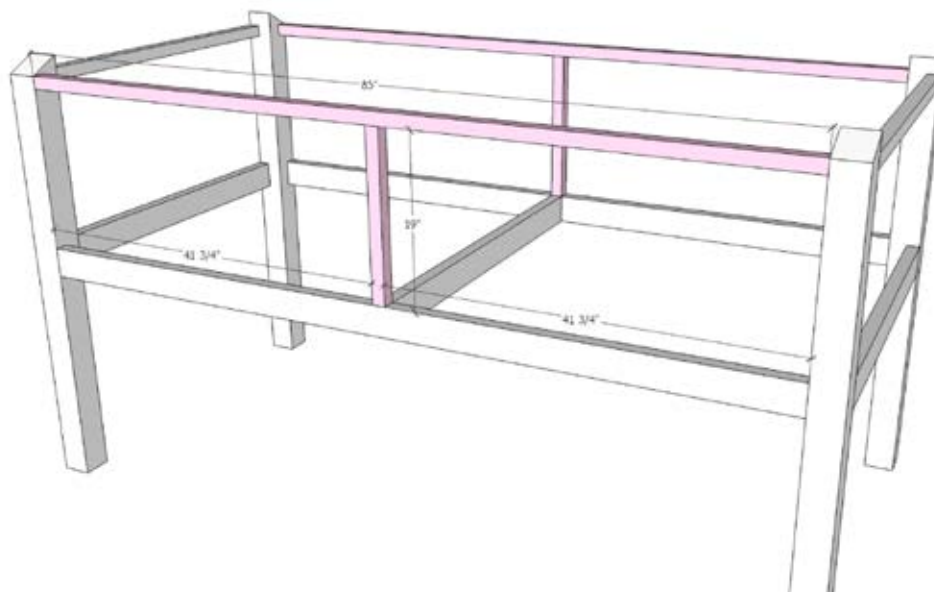

## Step 3

### ADD SUPPORTS (CONTINUED)

Next, add 2 (19") vertical 2x2's on the front end (3" in from each side), these will support the nesting box later (see plans below). Remember, if you are screwing through a 2x2, pre-drill the hole so the wood doesn't split.

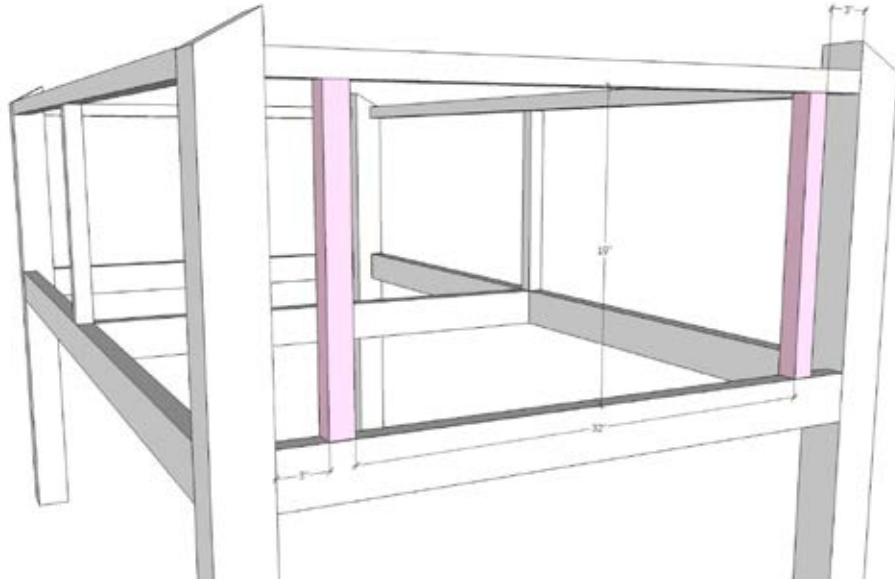

## Step 4

### FRAME UPPER WALLS

Next, frame your upper walls using horizontal 2x2's (89") and vertical 2x4's (13" for the center and 14-1/2" cut at 30 degrees for the ends).

Use what is available, either size will work. Use grabber screws to attach the upper frame to the lower frame.

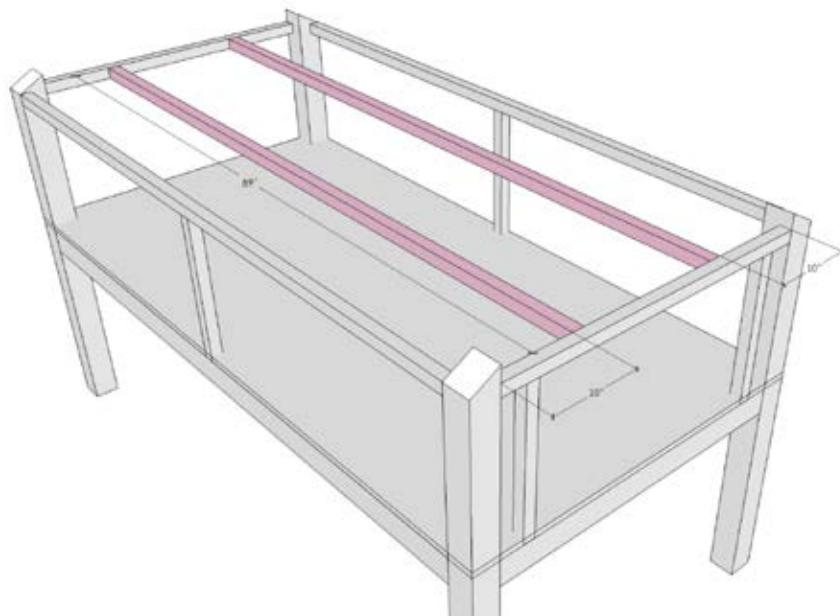

## Step 4

### FRAME UPPER WALLS (CONTINUED)

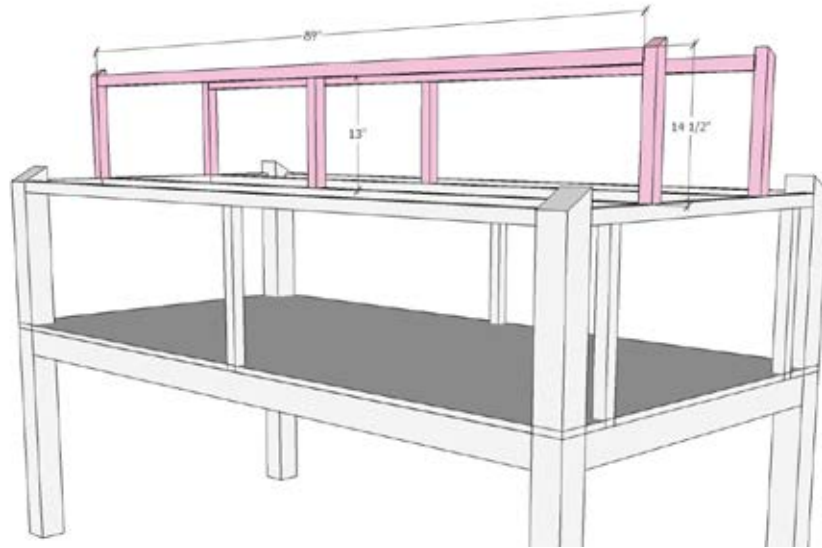

Then, add the 2x2 roof “trusses”:

- 4- 18" 2x2's
- 4- 14-1/2" 2x2's
- 2- 14-1/2" 2x4's
- 2- 18" 2x4's

All angles are 30 degrees (except the bottom of the middle 2x4's, see below). Ensure the roof supports overhang about an inch on the bottom.

Attach the roof supports to the 4x4 posts and the vertical 2x4's with grabber screws.

You can see in the photo above the 2x4's are used for the vertical upper walls, but 2x2's would also work.

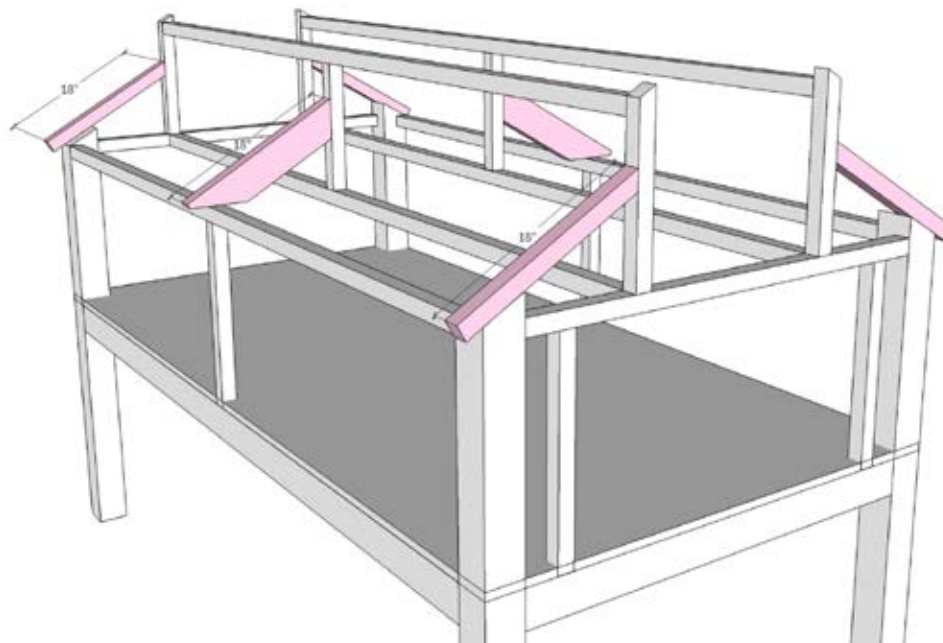

## Step 4

### FRAME UPPER WALLS (CONTINUED)

The roof “trusses” are 2x2’s on each end, and a 2x4 in the middle. Since the roof pitch is 30 degrees, cut one end of the 2x2 boards at 30 degrees and leave the other end square.

The middle 2x4 is cut a little different, with 30 degrees on one end, and 60 degrees on the other end, with 1/2" left square. This, and the same piece for the upper roof, are the only angled cuts in the entire roof that aren't 30 degrees.

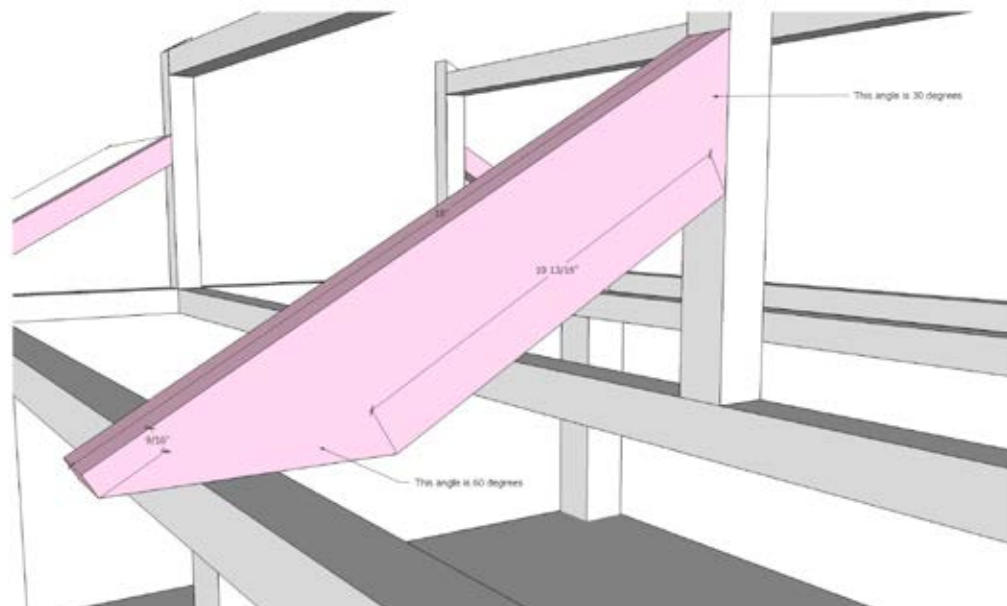

Repeat for the top, 2x2's on the outer edges, and a 2x4 in the middle. The angled pieces are connected using pocket holes and screws. Or use a mending plate to keep the trusses together.

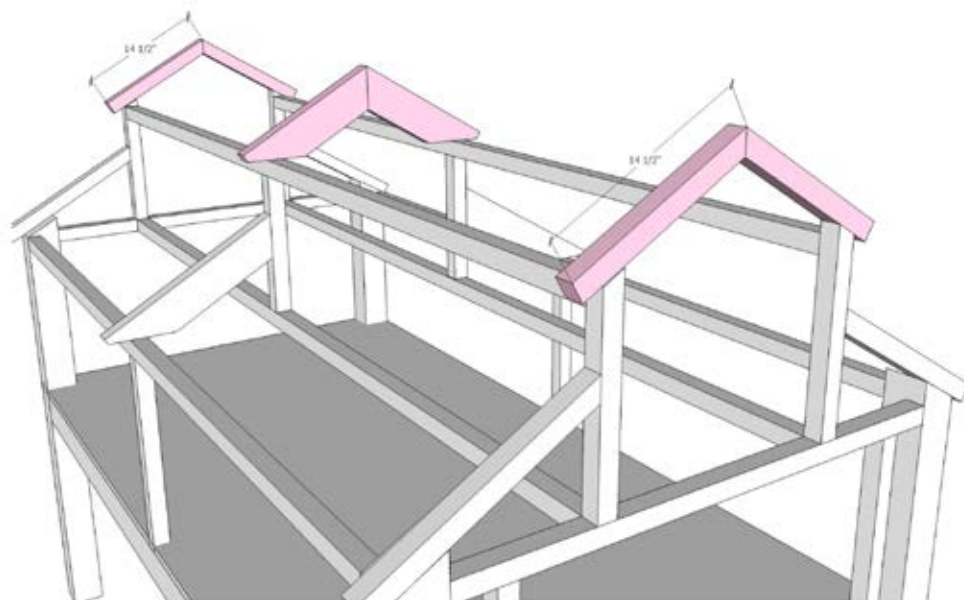



## Step 5

### FRAMING HINGED SIDES

Now that the roof is taken care of, there is still one more piece until the frame is complete. This 2x4 is where the hinge for the side attaches.

Using a reciprocating saw, cut a 3-1/2" square notch on each end of the 2x4, and screw it in place right below the floor support.

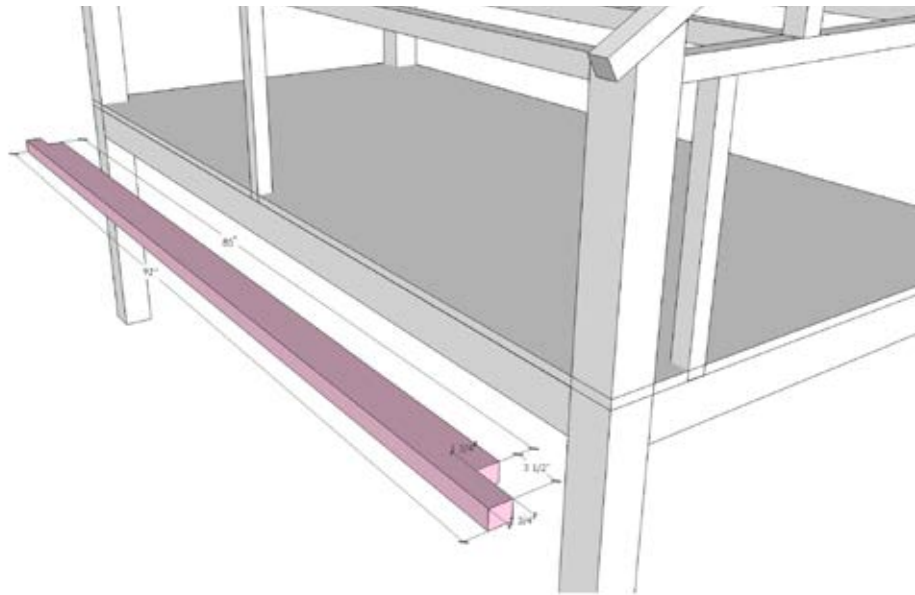

Once the 2x4 is in place, the framing is done and it's starting to look like a chicken coop!

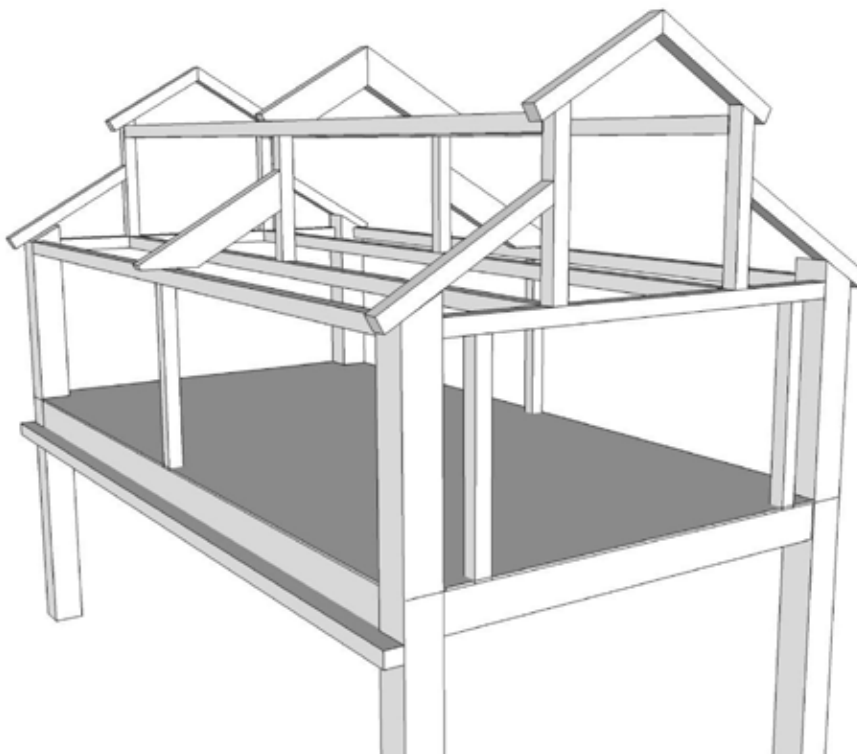

# Step 6

## ATTACH SIDING

When everything is framed, start to add the plywood siding. Cut the plywood siding to size before using a brad nailer to attach it to the coop. At this stage of construction, only attach the front, back, and one side for now. Attach the side that opens up later.

The dimensions are in the image below, but you may want to double check your plywood siding dimensions before you cut it. Remember all the angles on the roof are 30 degrees.

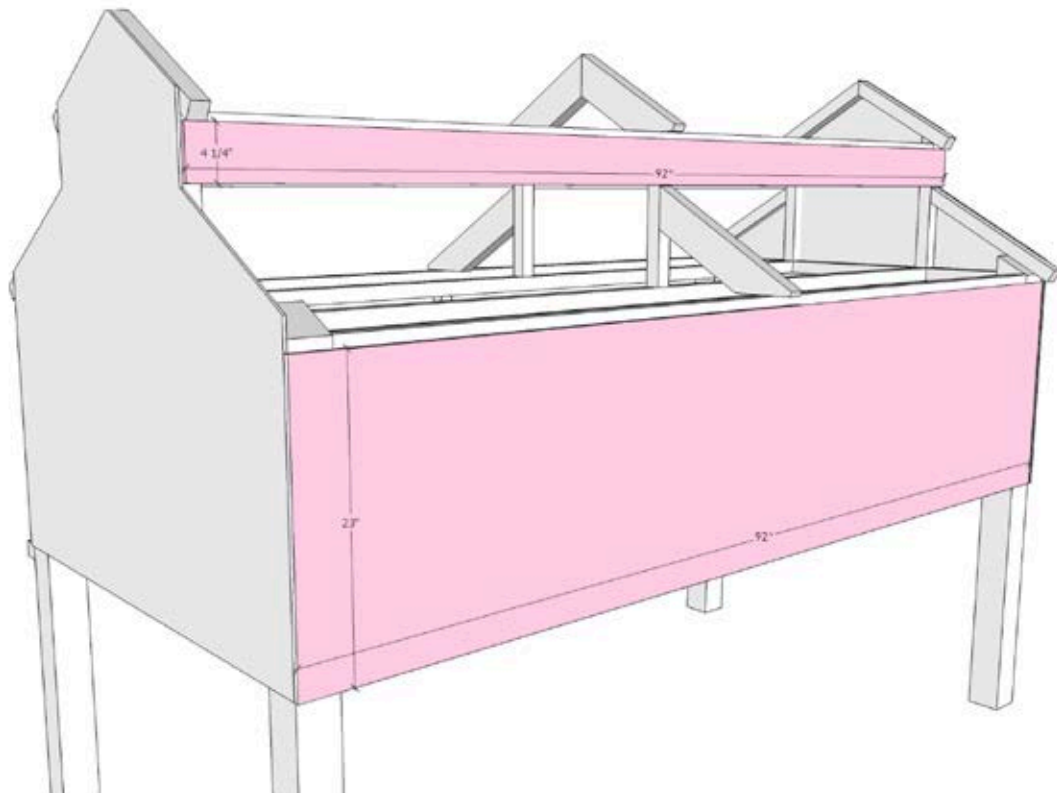
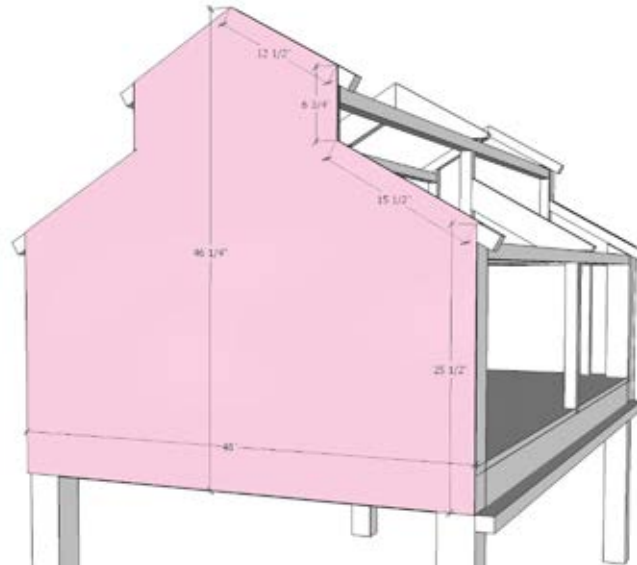

## Step 7

### CREATE SIDING FOR HINGED SIDE

For the side that hinges down, put together two pieces of plywood siding (45"x23" each). Then we will frame the OUTSIDE with our 2x2 trim. The finished dimensions will be 23"x90," which is slightly smaller than the other side. It will be smaller to allow for the side to hinge up and down.

Set the hinging door aside until it is time to paint. Or, if you have time to plan ahead, you might want to paint the siding before you attach the trim to the outside.

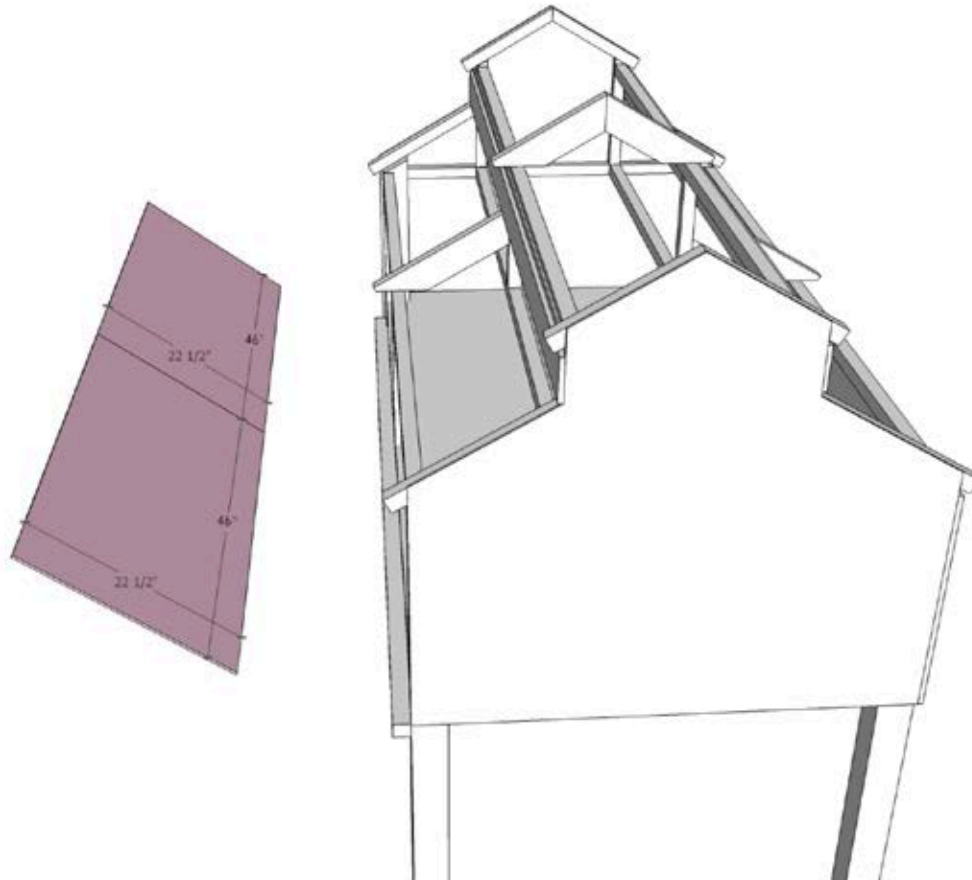

## Step 8

### ATTACH PLYWOOD ROOF

The chicken coop is taking shape and almost complete!

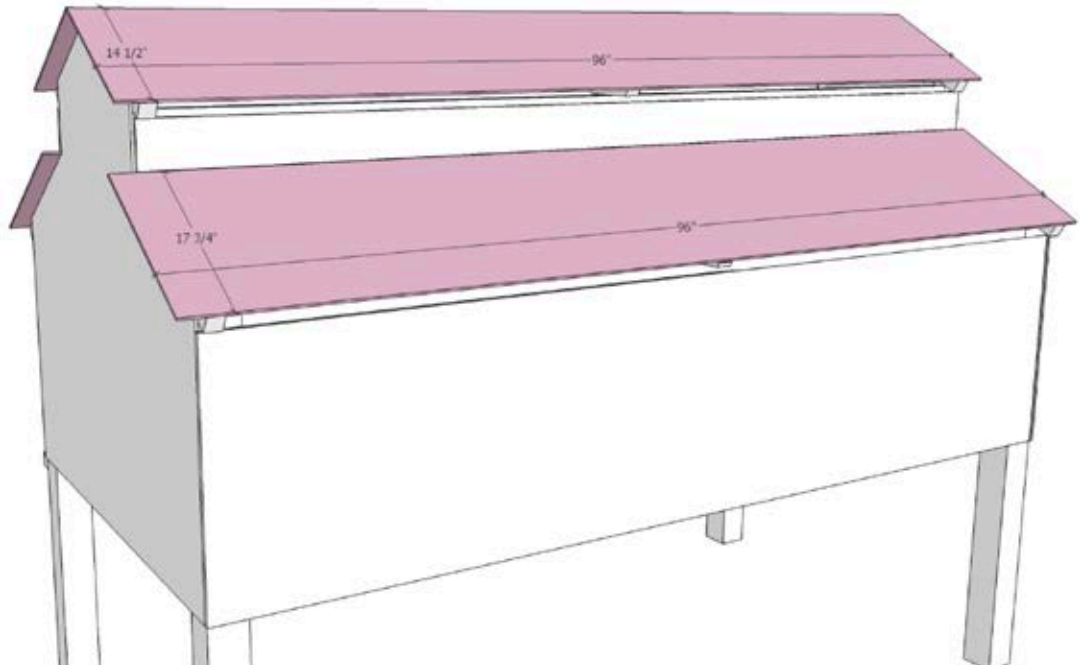

## Step 9

### BUILDING THE NESTING BOX

The nesting box frame will be mainly 2x2's, with a 2x4 on the open edge, which is where it will attach to the chicken coop, and where the hinge for the nesting box roof will be screwed. All of the angles for the nesting box are 20 degrees. (Not to be confused with all the 30 degree angles in the actual coop).

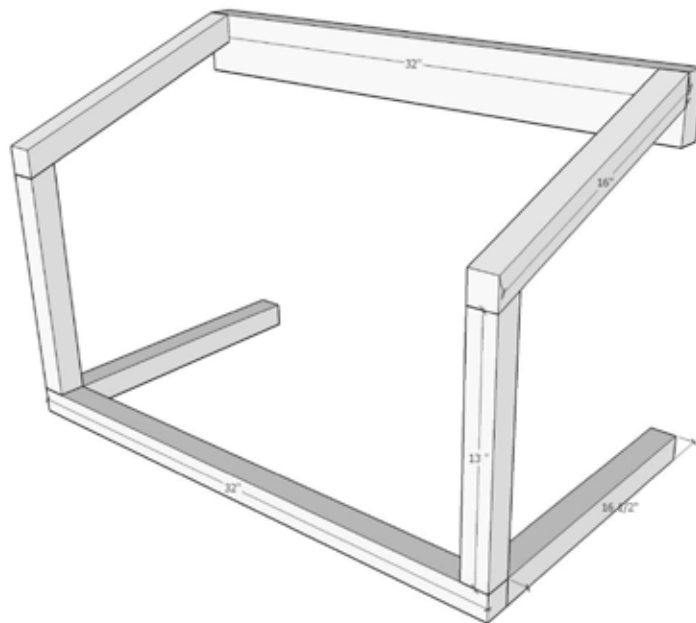

## Step 9

### BUILDING THE NESTING BOX (CONTINUED)

Cut the plywood siding and staple it onto the frame. You will notice the sides of the nesting box are notched out. Use this notch to slide the nesting box into the hole in the coop, and attach the plywood siding sides to the inside of the 2x2's you already have in place on the front wall of the coop.

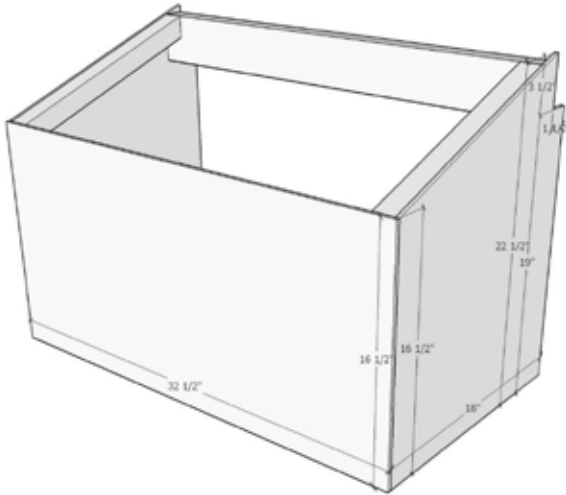

Picture above is what the nesting box looks like when it is ready to be attached to the coop. Wait to attach the nesting box until everything is painted.

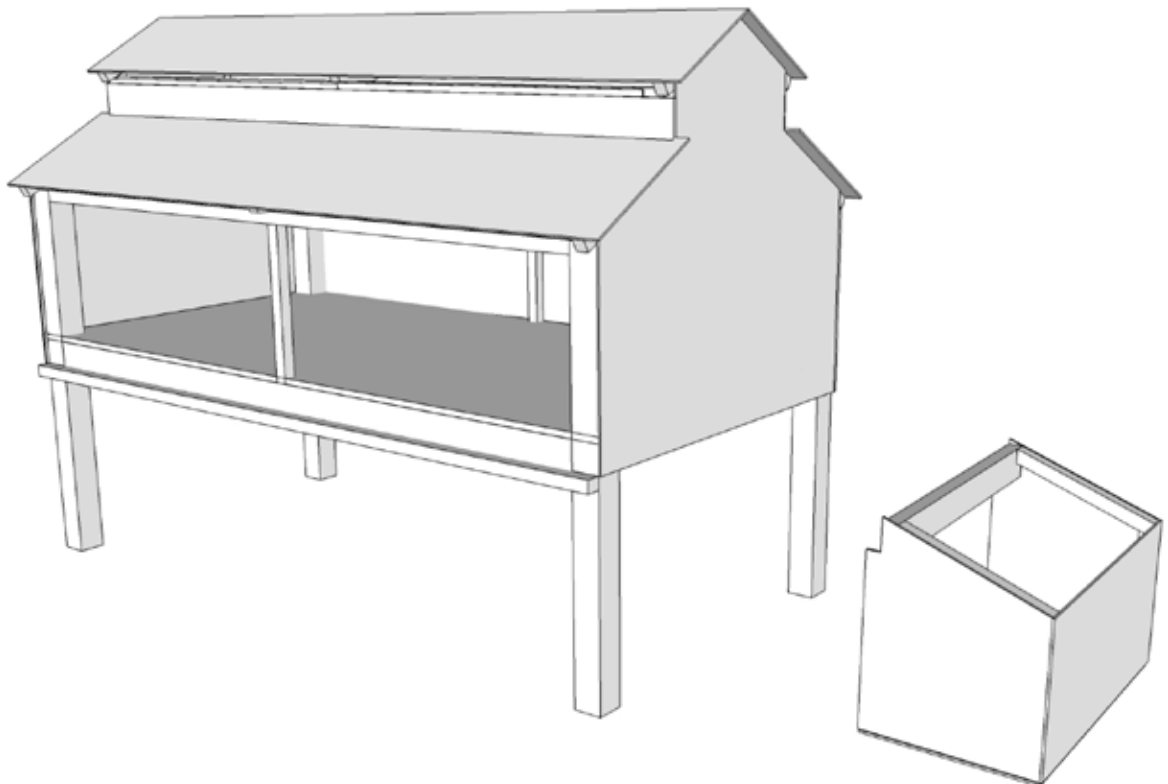

## Step 10

### PAINT THE CHICKEN COOP

Now it's time to make the chicken coop look great, by adding paint!

Paint the 1x2 trim boards before you start trimming.



# Step 11

## ATTACHING THE NESTING BOX

Once everything is painted, add the nesting box. Cut a hole in the front of the coop for the nesting box to attach to the coop.

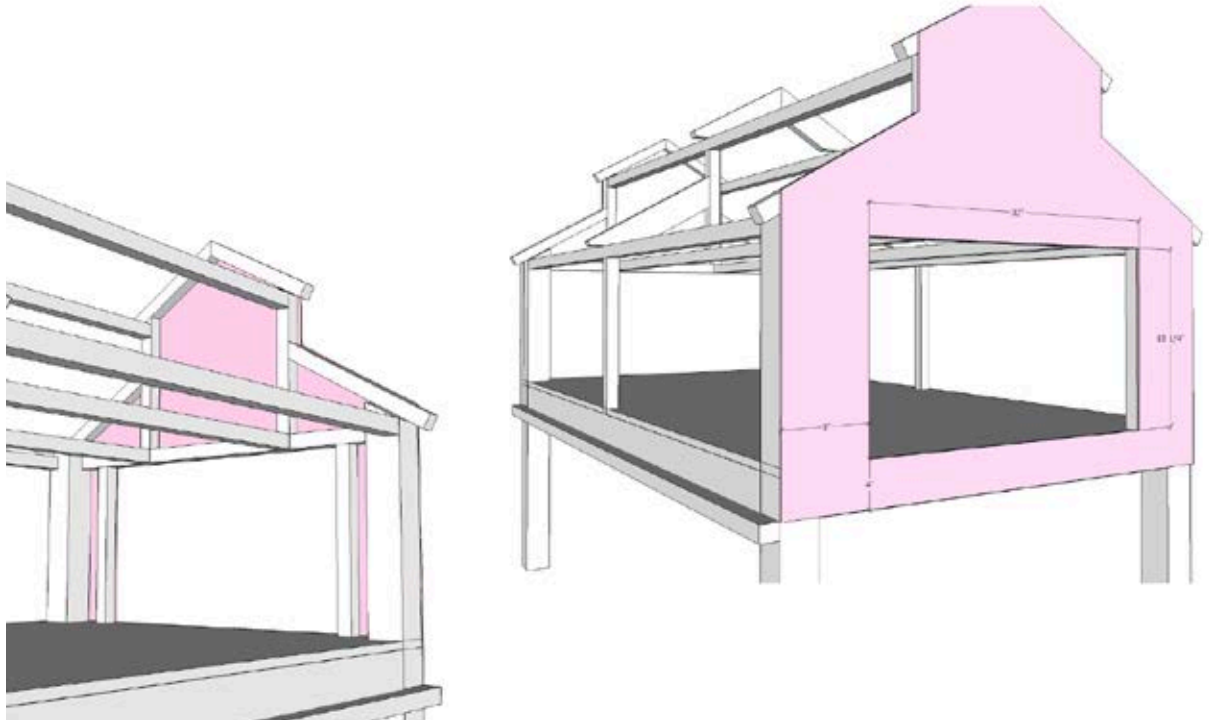

Cut the hole in the plywood siding using a reciprocating saw.

Once again, double check your measurements, the hole for the nesting box is 19"x32-1/2"



# Step 11

## ATTACHING THE NESTING BOX (CONTINUED)

Rest the nesting box on the floor and frame of the chicken coop. Cut the nesting box 3-3/4" from the bottom (3-1/2" for the 2x4, and 1/4" for the plywood floor).

Once the nesting box is in place, screw the 2x4 on the nesting box to the chicken coop using grabber screws.

The view from the inside shows how the nesting box attaches to the chicken coop frame. Screw the plywood to the frame to ensure the nesting box is sturdy.





## Step 12

### ADD ROOF TO THE NESTING BOX

After the nesting box is securely attached to the coop, add the nesting box roof, which will hinge open.

The roof is regular plywood, 33-1/2"x18-1/2"

Screw a piano hinge onto the edge of the nesting box roof first, then it attach to the nesting box.

Add a 2x2, with a 20 degree angled end to prop the roof open while gathering eggs. Screw the prop on with a grabber screw, but don't tighten all the way, so the board has freedom to hinge up and down.

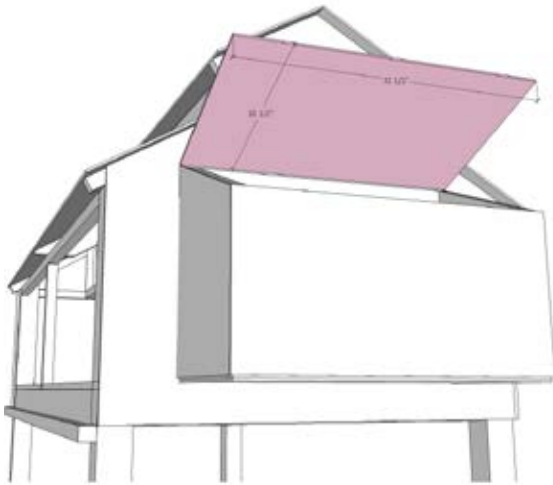

## Step 13

### ADD FOLD DOWN SIDE

Once the nesting box is complete, attach the side that folds down.

You might need an extra set of hands to hold the side up in place while you screw the piano hinge on. Screw a couple of screws in, then hinge it up and make sure it's straight before you finish screwing in all the rest of the screws.

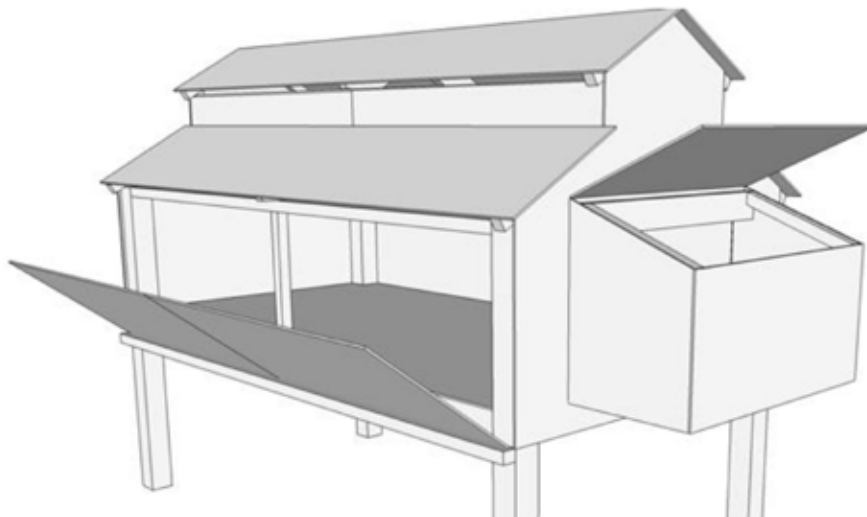

# Step 14

## TRIM CHICKEN COOP

Use regular 1x2's for the trim. Paint them before you cut them. Make sure your trim is measured correctly. Even 1/4" errors will make a big difference.

When installing the trim, make sure you are flush and level on the corners and edges. For the corners, staple one edge on, then make sure the other corner piece fits right up against it, so there isn't any overhang.

After everything is trimmed out, it's time to add a few finishing touches, included window bolts to hold the door up. Add one on each side. You can also paint the edges of the plywood roof and the roof "trusses" that will be exposed as well as the 4x4 legs.



## Step 15

### ADD RAMP

To add a ramp for the chickens to get into the coop, cut a hole (about 10"x10") in the back of the coop, 3-3/4" from the bottom. Use a 6' long 2x8, and staple scrap pieces every 5" to create the ramp. Add a 1x2 under the ramp to support it, then screw a 4" grabber screw at an angle through the ramp, into the support pieces.



## Step 16

### ADD ROOFING MATERIAL

Metal roofing is highly recommended. It's less expensive than shingles, it's easy to install and very durable.



**Congratulations, you've completed the construction of your new chicken coop!**

# HATCHING HOPE

These plans were created by Natalie Dalpiaz, from The Creative Mom and distributed by Cargill, Inc. These building plans are for personal use only. Please do not copy, sell, redistribute, or claim as your own.

© 2019 TheCreativeMom.com and Cargill, Incorporated.

3/2019

