

MAVIC MINI

User Manual v1.0

2019.11

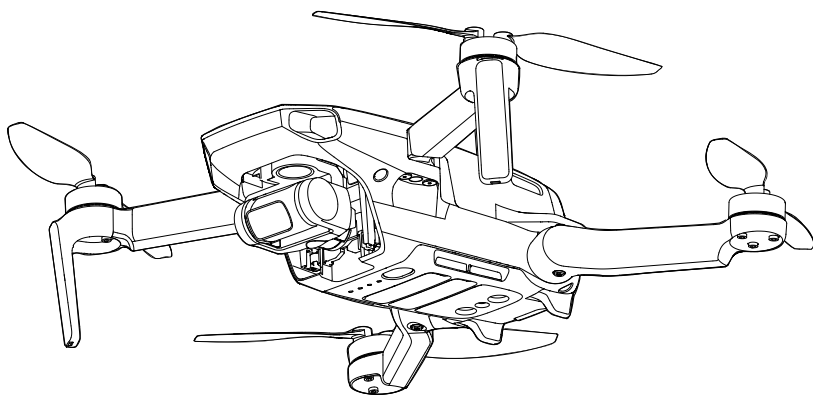

Searching for Keywords

Search for keywords such as “battery” and “install” to find a topic. If you are using Adobe Acrobat Reader to read this document, press Ctrl+F on Windows or Command+F on Mac to begin a search.

Navigating to a Topic

View a complete list of topics in the table of contents. Click on a topic to navigate to that section.

Printing this Document

This document supports high resolution printing.

Using this Manual

Legend

 Warning

 Important

 Hints and Tips

 Reference

Read Before the First Flight

Read the following documents before using the DJI™ MAVIC™ Mini:

1. In the Box
2. User Manual
3. Quick Start Guide
4. Disclaimer and Safety Guidelines

It is recommend to watch all tutorial videos on the official DJI website and read the disclaimer and safety guidelines before using for the first time. Prepare for your first flight by reviewing the quick start guide and refer to this user manual for more information.

Video Tutorials

Go to the address below or scan the QR code on the right to watch the Mavic Mini tutorial videos, which demonstrate how to use the Mavic Mini safely:

<http://www.dji.com/mavic-mini/info#video>



Download the DJI Fly App

Make sure to use DJI Fly during flight. Scan the QR code on the right to download the latest version.

The Android version of DJI Fly is compatible with Android v6.0 and later. The iOS version of DJI Fly is compatible with iOS v10.0.2 and later.



* For increased safety, flight is restricted to a height of 98.4 ft (30 m) and range of 164 ft (50 m) when not connected or logged into the app during flight. This applies to DJI Fly and all apps compatible with DJI aircraft.

Download DJI Assistant 2 for Mavic

Download DJI Assistant 2 for Mavic at <http://www.dji.com/mavic-mini/info#downloads>.

Contents

Using this Manual	2
Legend	2
Read Before the First Flight	2
Video Tutorials	2
Download the DJI Fly App	2
Download DJI Assistant 2 for Mavic	2
Product Profile	6
Introduction	6
Feature Highlights	6
Preparing the Aircraft	6
Preparing the Remote Controller	7
Aircraft Diagram	8
Remote Controller Diagram	8
Activation	9
Aircraft	11
Flight Modes	11
Aircraft Status Indicator	12
Return to Home	12
Vision System and Infrared Sensing System	15
Intelligent Flight Mode	16
Flight Recorder	18
Propellers	18
Intelligent Flight Battery	19
Gimbal and Camera	23
Remote Controller	26
Remote Controller Profile	26
Using the Remote Controller	26
Optimal Transmission Zone	29
Linking the Remote Controller	29
DJI Fly App	31
Home	31
Camera View	32

Flight	36
Flight Environment Requirements	36
Flight Limits and GEO Zones	36
Pre-Flight Checklist	37
Auto Takeoff/Landing	38
Starting/Stopping the Motors	38
Flight Test	39
Appendix	41
Specifications	41
Calibrating the Compass	44
Firmware Update	46
After-sales information	47

Product Profile

This section introduces Mavic Mini and lists the components of the aircraft and remote controller.

Product Profile

Introduction

Featuring a Downward Vision System and Infrared Sensing System, DJI Mavic Mini can hover and fly indoors as well as outdoors and Return to Home automatically. With a fully stabilized 3-axis gimbal and 1/2.3" sensor camera, Mavic Mini shoots 2.7k video and 12 MP photos. Mavic Mini has a maximum flight speed of 29 mph (46.8 kph) and a maximum flight time of 30 minutes.

Feature Highlights

Mavic Mini boasts a folded design and an ultralight weight of 249 g, making it easy to transport. The Intelligent Flight Mode QuickShots provide four sub modes, which can automatically shoot and generate different styles of video.

Using the advanced DJI flight controller, Mavic Mini is able to provide a safe and reliable flight experience. The aircraft is able to automatically return to its Home Point when the remote controller signal is lost or the battery level is low, as well as being able to hover indoors at low altitudes.

DJI's enhanced Wi-Fi technology is built into the remote controller, supporting both 2.4 GHz and 5.8 GHz frequencies and a transmission range of up to 2.49 mi (4 km), making it possible to stream 720p video to your mobile device.



- Maximum flight time was tested in an environment with no wind while flying at a consistent speed of 8.7 mph (14 kph) and the maximum flight speed was tested at sea level altitude with no wind. These values are for reference only.
- The remote controller reaches its maximum transmission distance (FCC) in a wide-open area with no electromagnetic interference at an altitude of about 400 ft (120 m). The maximum runtime was tested in a laboratory environment. This value is for reference only.
- 5.8 GHz is not supported in some regions. Observe the local laws and regulations.

Preparing the Aircraft

All aircraft arms are folded before the aircraft is packaged. Follow the steps below to unfold the aircraft arms.

1. Remove the gimbal cover from the camera.
2. Unfold the front arms.
3. Unfold the rear arms.

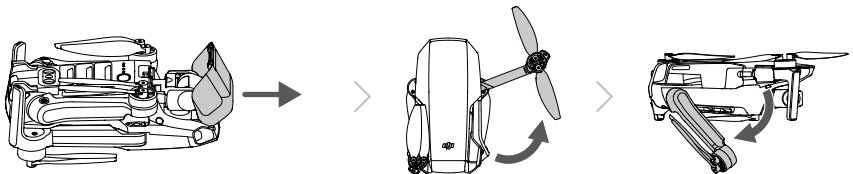

4. All Intelligent Flight Batteries are in hibernation mode before shipment to ensure safety. Use the provided USB charger to charge and activate Intelligent Flight Batteries for the first time.

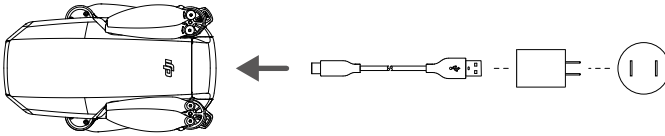

- ⚠ • Unfold the front arms before unfolding the rear arms.
 • Make sure the gimbal cover is removed and all arms are unfolded before powering on the aircraft. Otherwise, it may affect the aircraft self-diagnostics.

Preparing the Remote Controller

1. Unfold the mobile device clamps and the antennas.
2. Remove the control sticks from their storage slots on the remote controller and screw them into place.
3. Choose an appropriate remote controller cable based on the type of mobile device. A Lightning connector cable, Micro USB cable, and USB-C cable are included in the packaging. Connect the end of the cable with the DJI logo to the remote controller and the other end of the cable to your mobile device. Secure your mobile device by pushing both clamps inward.



- ⚠ • If a USB connection prompt appears when using an Android mobile device, select the option to charge only. Otherwise, it may result in connection failure.

Aircraft Diagram

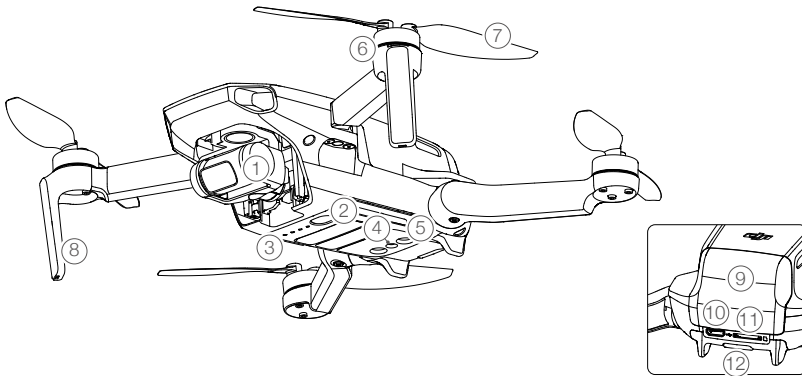

- 1. Gimbal and Camera
- 2. Power Button
- 3. Battery Level LEDs
- 4. Downward Vision System
- 5. Infrared Sensing System
- 6. Motors
- 7. Propellers
- 8. Antennas
- 9. Battery Compartment Cover
- 10. Charging Port (Micro USB)
- 11. microSD Card Slot
- 12. Aircraft Status Indicator

Remote Controller Diagram

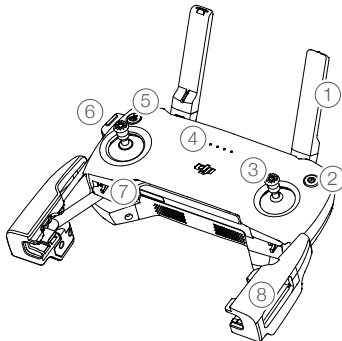

- 1. Antennas
Relay aircraft control and video wireless signals.
- 2. Power Button
Press once to check the current battery level. Press once, then again, and hold to turn the remote controller on or off.
- 3. Control Sticks
Use the control sticks to control the aircraft movements. Set the flight control mode in DJI

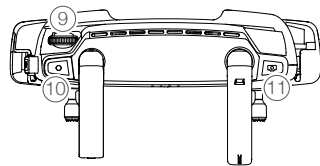

- Fly. The control sticks are removable and easy to store.
- 4. Battery Level LEDs
Displays the current battery level of the remote controller.
- 5. Flight Pause and Return to Home (RTH) Button
Press once to make the aircraft brake. If the aircraft is performing a QuickShot, Intelligent RTH, or auto landing, press once to make the

- aircraft exit the procedure and hover in place. Press and hold the button to initiate RTH. The aircraft returns to the last recorded Home Point. Press again to cancel RTH.
6. Video-Downlink/Power Port (Micro USB)
Connect to a mobile device for video linking via the remote controller cable. Connect to the USB charger to charge the remote controller battery.
 7. Control Sticks Storage Slots
For storing the control sticks.
 8. Mobile Device Clamps
Used to securely mount your mobile device to the remote controller.
 9. Gimbal Dial
Controls the camera's tilt.
 10. Record Button
In video mode, press once to start recording. Press again to stop recording. In photo mode, press once to switch to video mode.
 11. Shutter Button
In photo mode, press once to take a photo according to the mode selected in DJI Fly. In video mode, press once to switch to photo mode.

Activation

Mavic Mini requires activation before using for the first time. After powering on the aircraft and remote controller, follow the on-screen instructions to activate Mavic Mini using DJI Fly. An internet connection is required for activation.

Aircraft

Mavic Mini contains a flight controller, video downlink system, vision system, propulsion system, and an Intelligent Flight Battery.

Aircraft

Mavic Mini contains a flight controller, video downlink system, vision system, propulsion system, and an Intelligent Flight Battery. Refer to the aircraft diagram in the Product Profile section for more information.

Flight Modes

Mavic Mini has three flight modes, plus a fourth flight mode that the aircraft switches to in certain situations:

Position Mode: Position mode works best when the GPS signal is strong. The aircraft utilizes GPS and the Vision System to locate itself and stabilize. Intelligent Flight Mode is enabled in this mode. When the Downward Vision System is enabled and lighting conditions are sufficient, the maximum flight altitude angle is 20° and the maximum flight speed is 8 m/s.

The aircraft automatically changes to Attitude (ATTI) mode when the Vision System is unavailable or disabled and when the GPS signal is weak or the compass experiences interference. When the Vision System is unavailable, the aircraft cannot position itself or brake automatically, which increases the risk of potential flight hazards. In ATTI mode, the aircraft may be more easily affected by its surroundings. Environmental factors such as wind can result in horizontal shifting, which may present hazards, especially when flying in confined spaces.

Sport Mode: In Sport mode, the aircraft uses GPS and Vision System for positioning. In Sport mode, aircraft responses are optimized for agility and speed making it more responsive to control stick movements. The maximum flight speed is 13 m/s, maximum ascent speed is 4 m/s, and maximum descent speed is 3 m/s.

CineSmooth Mode: CineSmooth mode is based on Position mode and the flight speed is limited, making the aircraft more stable during shooting. The maximum flight speed is 4 m/s, maximum ascent speed is 1.5 m/s, and maximum descent speed is 1 m/s.









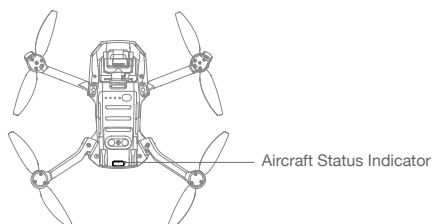





- The aircraft's maximum speed and braking distance significantly increase in Sport mode. A minimum braking distance of 30 m is required in windless conditions.
 - Descent speed significantly increases in Sport mode. A minimum braking distance of 10 m is required in windless conditions.
 - The aircraft's responsiveness significantly increases in Sport mode, which means a small control stick movement on the remote controller translates into the aircraft moving a large distance. Be vigilant and maintain adequate maneuvering space during flight.
-

Aircraft Status Indicator

The aircraft status indicator is located at the rear of the aircraft. It communicates the status of the aircraft's flight control system. Refer to the table below for more information about the aircraft status indicator.





Aircraft Status Indicator States



Normal States	Color	Blinking/Solid	Description of Aircraft State
	Alternating red, green, and yellow	Blinking	Powering on and performing self-diagnostic tests
	Yellow	Blinks four times	Warming up
	Green	Blinking slowly	P-mode with GPS
	Green	Periodically blinks twice	P-mode with Downward Vision System
	Yellow	Blinking slowly	No GPS, or Downward Vision System (ATTI mode)
	Green	Blinking quickly	Braking
Warning States			
	Yellow	Blinking quickly	Remote controller signal lost
	Red	Blinking slowly	Low battery
	Red	Blinking quickly	Critically low battery
	Red	Blinking	IMU error
	Red	Solid	Critical error
	Alternating red and yellow	Blinking quickly	Compass calibration required

Return to Home

The Return to Home (RTH) function brings the aircraft back to the last recorded Home Point. There are three types of RTH: Smart RTH, Low Battery RTH, and Failsafe RTH. This section describes these three types of RTH in detail. RTH will also be triggered if the video link is disconnected.

	GPS	Description
Home Point		The default Home Point is the first location where your aircraft received strong GNSS signals  (the white GNSS icon has at least four white bars). The aircraft status indicator blinks green quickly after the Home Point has been recorded.

Smart RTH

If the GPS signal is sufficiently strong, Smart RTH can be used to bring the aircraft back to the Home Point. Smart RTH is initiated either by tapping  in DJI Fly or by pressing and holding the RTH button on the remote controller. Exit Smart RTH by tapping  in DJI Fly or by pressing the RTH button on the remote controller.

Low Battery RTH

Low Battery RTH is triggered when the Intelligent Flight Battery is depleted to the point that the safe return of the aircraft may be affected. Return home or land the aircraft immediately when prompted.

DJI Fly displays a warning when the battery level is low. The aircraft will automatically return to the Home Point if no action is taken after a 10 second countdown.

The user can cancel RTH by pressing the RTH button on the remote controller. If RTH is cancelled following a low battery level warning, the Intelligent Flight Battery may not have enough power for the aircraft to land safely, which may lead to the aircraft crashing or being lost.

The aircraft will land automatically if the current battery level can only support the aircraft long enough to descend from its current altitude. The user cannot cancel the auto landing but can use the remote controller to alter the aircraft's direction during the landing process.

Failsafe RTH

If the Home Point was successfully recorded and the compass is functioning normally, Failsafe RTH automatically activates after the remote controller signal is lost for more than 11 seconds.

Other RTH Scenarios

If the video link signal is lost during flight while the remote controller is still able to control the movements of the aircraft, there will be a prompt to initiate RTH. RTH can be cancelled.

RTH Procedure

1. The Home Point is recorded.
2. RTH is triggered.
3. If the altitude is lower than 20 m, the aircraft ascends to the RTH altitude or 20 m, and then adjusts its orientation. If the altitude is higher than 20 m, the aircraft adjusts its orientation immediately.
4. a. If the aircraft is further than 20 m from the Home Point when the RTH procedure begins, it ascends to the preset RTH altitude and flies to the Home Point at a speed of 8 m/s. If the current altitude is higher than the RTH altitude, the aircraft flies to the Home Point at the current altitude.
b. If the aircraft is less than 20 m from the Home Point when the RTH procedure begins, it lands immediately.

5. After reaching the Home Point, the aircraft lands and the motors stop.

FailSafe RTH Illustration

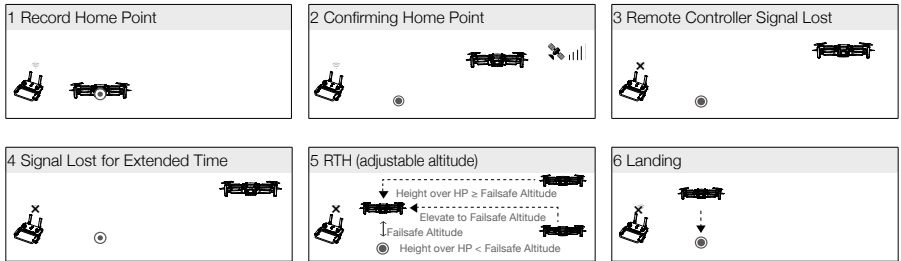

- The aircraft cannot return to the Home Point if the GPS signal is weak or unavailable. If the GPS signal become weak or unavailable after RTH is triggered, the aircraft will hover in place for a while, and then start landing.
- It is important to set a suitable RTH altitude before each flight. Launch DJI Fly, and then set the RTH altitude. In Smart RTH and Low Battery RTH, the aircraft automatically ascends to the RTH altitude. If the aircraft is at an altitude of 65 ft (20 m) or higher and has not yet reached the RTH altitude, the throttle stick can be moved to stop the aircraft from ascending. The aircraft will fly directly to the Home Point at its current altitude.
- During RTH, the aircraft's speed, altitude, and the orientation can be controlled using the remote controller or DJI Fly if the remote controller signal is normal, but the direction of flight cannot be controlled.
- GEO zones will affect RTH.
- The aircraft may not be able to return to a Home Point when the wind speed is too high. Fly with caution.

Landing Protection

Landing Protection will activate during Smart RTH.

1. During Landing Protection, the aircraft will automatically detect and gently land on suitable ground.
2. If Landing Protection determines that the ground is not suitable for landing, Mavic Mini will hover and wait for pilot confirmation.
3. If Landing Protection is not operational, DJI Fly will display a landing prompt when Mavic Mini descends below 0.5 meters. Pull down on the throttle stick or use the auto landing slider to land.

Vision System and Infrared Sensing System

Mavic Mini is equipped with a Downward Vision System and Infrared Sensing System. The Downward Vision System consists of one camera and the Infrared Sensing System consists of two 3D infrared modules. The Downward Vision System and Infrared Sensing System help the aircraft maintain its current position, hover in place more precisely, and to fly indoors or in other environments where GPS is unavailable.

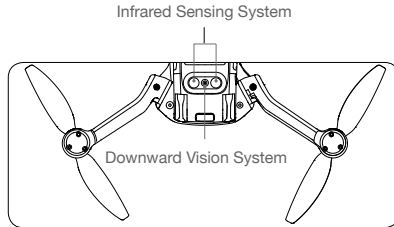

Detection Fields

The Downward Vision System works best when the aircraft is at an altitude of 0.5 to 10 m, and its operating range is 0.5 to 30 m.

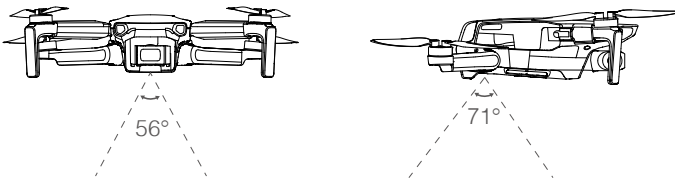

Using the Vision System

When GPS is unavailable, the Downward Vision System is enabled if the surface has a discernable surface and sufficient light. The Downward Vision System works best when the aircraft is at an altitude of 0.5 to 10 m. If the aircraft's altitude is above 10 m, the Vision System may be affected, so extra caution is required.

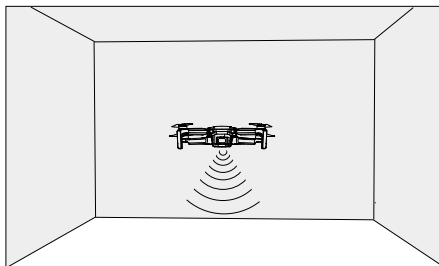

Follow the steps below to use the Downward Vision System

1. Make sure the aircraft is on a flat surface. Power on the aircraft.
2. The aircraft hovers in place after takeoff. The aircraft status indicator blinks green twice, which indicates the Downward Vision System is working.



- The max hover altitude of the aircraft is 5 m if there is no GPS. The Vision System works best when the aircraft is at an altitude from 0.5 to 10 m. If the altitude of the aircraft is above 10 m, the Vision System may be affected, so extra caution is required.
- The Vision System may not function properly when the aircraft is flying over water or snow-covered areas.
- Note that the Vision System may not function properly when the aircraft is flying too fast. Fly with caution when flying at over 10 m/s (32.8 ft/s) at 2 m (6.6 ft) or over 5 m/s (16.4 ft) at 1 m (3.3 ft).
- The Vision System cannot work properly over surfaces that do not have clear pattern variations. The Vision System cannot work properly in any of the following situations. Operate the aircraft cautiously.
 - a. Flying over monochrome surfaces (e.g., pure black, pure white, pure green).
 - b. Flying over highly reflective surfaces.
 - c. Flying over water or transparent surfaces.
 - d. Flying over moving surfaces or objects.
 - e. Flying in an area where the lighting changes frequently or drastically.
 - f. Flying over extremely dark (< 10 lux) or bright (> 40,000 lux) surfaces.
 - g. Flying over surfaces that strongly reflect or absorb infrared waves (e.g., mirrors).
 - h. Flying over surfaces without clear patterns or texture.
 - i. Flying over surfaces with repeating identical patterns or textures (e.g., tiles with the same design).
 - j. Flying over obstacles with small surface areas (e.g., tree branches).
- Keep the sensors clean at all times. DO NOT tamper with the sensors. DO NOT use the aircraft in environment with dust and humidity. DO NOT obstruct the Infrared Sensing System.
- DO NOT fly on days that are rainy, smoggy, or if there is limited visibility.
- Check the following every time before takeoff:
 - a. Make sure there are no stickers or any other obstructions over the Infrared Sensing and Vision System.
 - b. If there is any dirt, dust, or water on the Infrared Sensing and Vision System, clean it with a soft cloth. Do not use any cleanser that contains alcohol.
 - c. Contact DJI Support if there is any damage to the glass of the Infrared Sensing and Vision System.

Intelligent Flight Mode

Mavic Mini supports QuickShots Intelligent Flight Mode. QuickShots shooting modes include Dronie, Rocket, Circle, and Helix. Mavic Mini records a video according to the selected shooting mode and automatically generates videos approximately 15-second long. The video can be viewed, edited, or shared to social media from playback.



Dronie: The aircraft flies backward and ascends, with the camera locked on the subject.



Rocket: The aircraft ascends with the camera pointing downward.



Circle: The aircraft circles around the subject.

- Helix: The aircraft ascends and spirals around the subject.

Using QuickShots

1. Make sure that the Intelligent Flight Battery is sufficiently charged. Take off and hover at least 6.6 ft (2 m) above the ground.

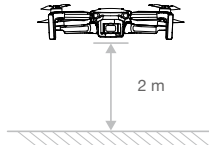

2. In DJI Fly, tap to select QuickShots and follow the prompts. Make sure that the user understands how to use the shooting mode and that there are no obstacles in the surrounding area.
3. Select your target subject in the camera view by tapping the circle on the subject or dragging a box around the subject. Choose a shooting mode and tap "Start" to begin recording. The aircraft flies back to its original position once shooting is finished.

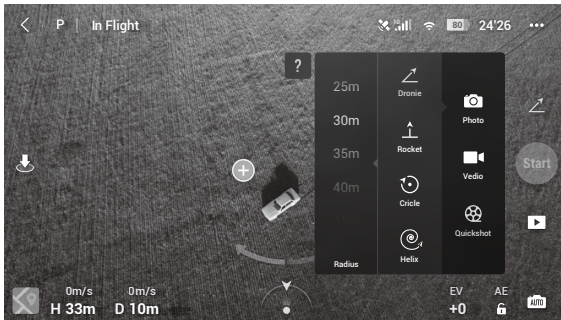

4. Tap  to access the video. The video can be edited and shared on social media after downloading to your phone.

Exiting QuickShots

Press the Flight Pause/RTH button once or tap the  in DJI Fly to exit QuickShots. The aircraft will hover in place.



- ⚠ • Use QuickShots at locations that are clear of buildings and other obstacles. Make sure that there are no humans, animals, or other obstacles in the flight path.
- Pay attention to objects around the aircraft and use the remote controller to avoid accidents with the aircraft.
- DO NOT use QuickShots in any of the following situations:
 - a. When the subject is blocked for an extended period or outside the line of sight.
 - b. When the subject is more than 50 m away from the aircraft.
 - c. When the subject is similar in color or pattern with the surroundings.
 - d. When the subject is in the air.
 - e. When the subject moves fast.
 - f. The lighting is extremely low (< 300 lux) or high (> 10,000 lux).
- DO NOT use QuickShots in places that are close to buildings or where the GPS signal is weak. Otherwise, the flight path may be unstable.
- Make sure to follow local privacy laws and regulations when using QuickShots.

Flight Recorder

Flight data including flight telemetry, aircraft status information, and other parameters are automatically saved to the internal data recorder of the aircraft. The data can be accessed using DJI Assistant 2 for Mavic.

Propellers

There are two types of Mavic Mini propellers, which are designed to spin in different directions. Marks are used to indicate which propellers should be attached to which motors. The two blades attached to one motor are the same.

Propellers	With marks	Without marks
Illustration		
Mounting Position	Attach to the motors of the arms with marks	Attach to the motors of the arms without marks

Attaching the Propellers

Attach the propellers with marks to the motors of the arm with marks and the unmarked propellers to the motors of the arm without marks. Use the screwdriver to mount the propellers. Make sure the propellers are secure.

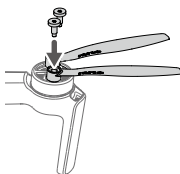

Unmarked

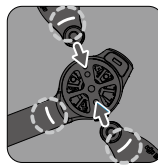

Marks

Detaching the Propellers

Use the screwdriver to detach the propellers from the motors.



- Propeller blades are sharp. Handle with care.
- The screwdriver is only used to mount the propellers. DO NOT use the screwdriver to disassemble the aircraft.
- If a propeller is broken, remove the two propellers and screws on the corresponding motor and discard them. Use two propellers from the same package. DO NOT mix with propellers from other packages.
- Only use official DJI propellers. DO NOT mix propeller types.
- Purchase the propellers separately if necessary.
- Make sure that the propellers are installed securely before each flight. Check if the screws on the propellers are tightened every 30 hours of flight time (approx. 60 flights).
- Make sure all propellers are in good condition before each flight. DO NOT use aged, chipped, or broken propellers.
- To avoid injury, stand clear of and do not touch propellers or motors when they are spinning.
- DO NOT squeeze or bend the propellers during transportation or storage.
- Make sure the motors are mounted securely and rotating smoothly. Land the aircraft immediately if a motor is stuck and unable to rotate freely.
- DO NOT attempt to modify the structure of the motors.
- DO NOT touch or let your hands or body come in contact with the motors after flight as they may be hot.
- DO NOT block any of the ventilation holes on the motors or the body of the aircraft.
- Make sure the ESCs sound normal when powered on.

Intelligent Flight Battery

The Mavic Mini Intelligent Flight Battery is a 7.2 V, 2400 mAh battery with smart charging and discharging functionality.

Battery Features

1. **Balanced Charging:** During charging, the voltages of the battery cells are automatically balanced.
2. **Overcharge Protection:** The battery stops charging automatically once fully charged.
3. **Temperature Detection:** In order to protect itself, the battery only charges when the temperature is between 41° and 104° F (5° and 40° C). Charging stops automatically if the temperature of the battery exceeds 122° F (0° C) during the charging process.
4. **Overcurrent Protection:** The battery stops charging if an excess current is detected.
5. **Over-discharge Protection:** Discharging stops automatically to prevent excess discharge when the battery is not in flight use. Over-discharge protection is not enabled when the battery is in flight use.
6. **Short Circuit Protection:** The power supply is automatically cut if a short circuit is detected.
7. **Battery Cell Damage Protection:** DJI Fly displays a warning prompt when a damaged battery cell is detected.
8. **Hibernation Mode:** If the battery cell voltage is lower than 3.0 V, the battery enters Hibernation mode to prevent over-discharge. Charge the battery to wake it from hibernation.

9. Communication: Information about the battery's voltage, capacity, and current is transmitted to the aircraft.

- ⚠ • Refer to the Mavic Mini Disclaimer and Safety Guidelines before use. Users take full responsibility for all operations and usage.
- The Mavic Mini Intelligent Flight Battery cannot discharge automatically. If the battery will not be used for more than 10 days, it is recommended to discharge the battery manually until the battery level is between 39% and 75%.
- Specifications of the Intelligent Flight Battery for the Japanese version are different. Refer to the Specifications section for more information. The battery features are the same for all versions of the Mavic Mini Intelligent Flight Battery.

Using the Battery

Insert the battery in the battery compartment and secure the battery clamp. A clicking sound indicates the battery is fully engaged. Make sure that the battery is fully inserted and the battery cover is secure in place.

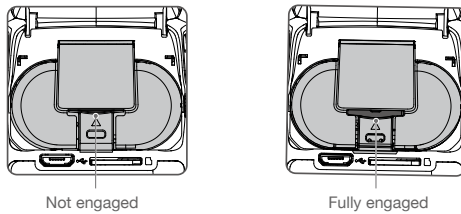

Press the battery clamp and detach the battery from the battery compartment to remove it.

- ⚠ • DO NOT detach the battery when the aircraft is powering on.
- Make sure that the battery is mounted firmly.

Checking Battery Level

Press the power button once to check the battery level.

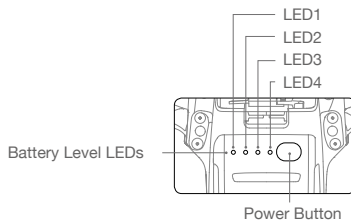

Battery Level LEDs

○ : LED is on. ◉ : LED is flashing. ○ : LED is off.

LED1	LED2	LED3	LED4	Battery Level
○	○	○	○	battery level > 88%
○	○	○	◉	75% < battery level ≤ 88%

○	○	○	○	63% < battery level ≤ 75%
○	○	☀	○	50% < battery level ≤ 63%
○	○	○	○	38% < battery level ≤ 50%
○	☀	○	○	25% < battery level ≤ 38%
○	○	○	○	13% < battery level ≤ 25%
☀	○	○	○	0% < battery level ≤ 13%

Powering On/Off

Press the power button once, then press again, and hold for two seconds to turn the battery on or off. The battery level LEDs display the battery level when the aircraft is powered on.

Press the power button once and the four battery level LEDs will blink for three seconds. If LED 3 and 4 blink simultaneously without pressing the power button, this indicates the battery is abnormal.

Low Temperature Notice

1. Battery capacity is significantly reduced when flying in low-temperature environments of 23° to 41° F (-5° to 5° C). It is recommended to hover the aircraft in place temporarily to heat the battery. Make sure to fully charge the battery before takeoff.
2. To ensure the optimal performance of the battery, keep the battery temperature above 68° F (20° C).
3. The reduced battery capacity in low-temperature environments reduces the wind speed resistance performance of the aircraft. Fly with caution.
4. Fly with extra caution at high sea levels.





In cold environments, insert the battery into the battery compartment and turn on the aircraft to warm up before taking off.

Charging the Battery

Fully charge the Intelligent Flight Battery before using for the first time.

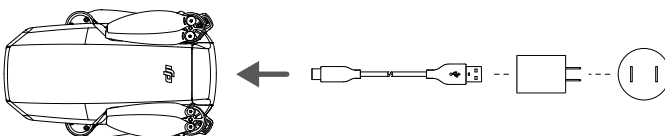
1. Connect the USB charger to an AC power supply (100-240V, 50/60 Hz). Use a power adapter if necessary.
2. Attach the aircraft to the USB charger.
3. The battery level LEDs display the current battery level during charging.
4. The Intelligent Flight Battery is fully charged when all the battery level LEDs are on. Detach the USB charger when the battery is fully charged.



















-  • The battery cannot be charged if the aircraft is powered on and the aircraft cannot be powered on during charging.
- DO NOT charge an Intelligent Flight Battery immediately after flight as the temperature may be too high. Wait until it cools down to room temperature before charging again.
- The charger stops charging the battery if the battery cell temperature is not within the operating range of 41° to 104° F (5° to 40° C). The ideal charging temperature is 71.6° to 82.4° F (22° to 28° C).
- The Battery Charging Hub (not included) can charge up to three batteries. Visit the official DJI Online Store to learn more.
- DJI does not take any responsibility for damage caused by third-party charger.

-  Discharging
 - It is recommended to discharge the Intelligent Flight Batteries to 30% or lower. This can be done by flying the aircraft outdoors until there is less than 30% charge left.

Battery Level LEDs During Charging





















The table below shows battery level during charging.

LED1	LED2	LED3	LED4	Battery Level
				0% < battery level ≤ 50%
				50% < battery level ≤ 75%
				75% < battery level < 100%
				Fully charged

-  • The blinking frequency of the battery level LEDs will be different when using different USB charger. If the charging speed is fast, the battery level LEDs will blink quickly. If the charging speed is extremely slow, the battery level LEDs will blink slowly (once every two seconds). It is recommended to change the Micro USB cable or USB charger.
- If there is no battery in the aircraft, LED 3 and 4 will blink three times alternatively.
- The four LEDs blink simultaneously to indicate the battery is damaged.

Battery Protection Mechanisms

The battery LED indicator can display battery protection indications triggered by abnormal charging conditions.

Battery Protection Mechanisms					
LED1	LED2	LED3	LED4	Blinking Pattern	Battery Protection Item
				LED2 blinks twice per second	Overcurrent detected
				LED2 blinks three times per second	Short circuit detected
				LED3 blinks twice per second	Overcharge detected
				LED3 blinks three times per second	Over-voltage charger detected
				LED4 blinks twice per second	Charging temperature is too low

○	○	○	☀	LED4 blinks three times per second	Charging temperature is too high
---	---	---	---	------------------------------------	----------------------------------

If the charging temperature protection is enabled, the battery will resume charging once the temperature has returned to within the allowable range. If one of the other battery protection mechanisms activate, in order to resume charging it is necessary to press the button to power off the battery, unplug the battery from the charger, and then plug it in again. If the charging temperature is abnormal, wait for the charging temperature to return to normal, and the battery will automatically resume charging without the need to unplug and plug in the charger again.

Gimbal and Camera

Gimbal Profile

Mavic Mini's 3-axis gimbal provides stabilization for the camera, allowing you to capture clear and stable images and video. Use the gimbal dial on the remote controller to control the camera's tilt. Alternatively, enter the camera view in DJI Fly. Press the screen until a circle appears and drag the circle up and down to control the camera's tilt.

The gimbal has a tilt range of -90° to $+20^{\circ}$ by enabling "Allow Upward Gimbal Rotation" in DJI Fly. The default control range is -90° to 0° .

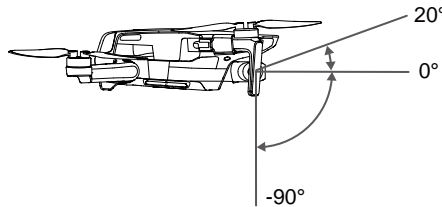

Gimbal Operation Modes

Two gimbal operation modes are available. Switch between the different operation modes in DJI Fly.

Follow Mode: The angle between the gimbal's orientation and aircraft front remains constant at all times.

FPV Mode: The gimbal synchronizes with the movement of the aircraft to provide a first-person flying experience.



- When the aircraft is powered on, do not tap or knock the gimbal. To protect the gimbal during takeoff, take off from open, flat surfaces.
- Precision elements in the gimbal may be damaged in a collision or impact, which may cause the gimbal to function abnormally.
- Avoid getting dust or sand on the gimbal, especially in the gimbal motors.
- A gimbal motor error may occur in the following situations:
 - a. The aircraft is on uneven ground or the gimbal is obstructed.
 - b. The gimbal experiences excessive external force, such as a collision.
- DO NOT apply external force to the gimbal after the gimbal is powered on. DO NOT add any extra payload to the gimbal as this may cause the gimbal to function abnormally or even lead to permanent motor damage.



- Make sure to remove the gimbal cover before powering on the aircraft. Also, make sure to mount the gimbal cover when the aircraft is not in use.
 - Flying in heavy fog or clouds may make the gimbal wet, leading to temporary failure. The gimbal recovers full functionality once it is dry.
-

Camera Profile

Mavic Mini uses a 1/2.3" CMOS sensor camera, which can shoot up to 2.7K video and 12 MP photos, and supports shooting modes such as Single Shot and Interval.

The aperture of the camera is f/2.8 and can focus from 1 m to infinity.



- Make sure the temperature and humidity are suitable for the camera during usage and storage.
 - Use a lens cleanser to clean the lens to avoid damage.
 - DO NOT block any ventilation holes on the camera as the heat generated may damage the device and hurt the user.
-

Storing Photos and Videos

Mavic Mini supports the use of a microSD card to store your photos and videos. A UHS-I Speed Grade 3 rating microSD card is required due to the fast read and write speeds necessary for high-resolution video data. Refer to the Specifications section for more information about recommended microSD cards.



- Do not remove the microSD card from the aircraft while it is turned on. Otherwise, the microSD card may be damaged.
 - To ensure the stability of the camera system, single video recordings are limited to 30 minutes.
 - Check camera settings before use to ensure they are configured as desired.
 - Before shooting important photos or videos, shoot a few images to test the camera is operating correctly.
 - Photos or videos cannot be transmitted or copied from the camera if the aircraft powered off.
 - Make sure to power off the aircraft correctly. Otherwise, your camera parameters will not be saved and any recorded videos may be damaged. DJI is not responsible for any failure of an image or video to be recorded or having been recorded in a way that is not machine-readable.
-

Remote Controller

This section describes the features of the remote controller and includes instructions for controlling the aircraft and the camera.

Remote Controller

Remote Controller Profile

Built into the remote control is DJI's enhanced Wi-Fi technology, offering 2.4 GHz and 5.8 GHz* transmission frequencies, a maximum transmission distance of 2.49 mi (4 km), and 720p video downlink from the aircraft to DJI Fly on your mobile device. The detachable control sticks make the remote controller easier to store. Refer to the remote controller diagram in the Product Profile section for more information.

The built-in battery has a capacity of 2600 mAh and a maximum run time of 4.5 hours when using an iOS device and 1 hour and 40 minutes when using an Android device. The remote controller charges the Android device with a charging ability of 500 mA@5V. The remote controller automatically charges Android devices.

* The MD1SD25 model remote controller can support both 2.4 GHz and 5.8 GHz. The MR1SS5 model remote controller only supports 5.8 GHz.

-  • Compliance Version: The remote controller is compliant with local regulations.
- Control Stick Mode: The control stick mode determines the function of each control stick movement. Three pre-programmed modes (Mode 1, Mode 2, and Mode 3) are available and custom modes can be configured in DJI Fly. The default mode is Mode 2.

Using the Remote Controller

Powering On/Off

Press the power button once to check the current battery level.

Press once, then again and hold to turn the remote controller on or off. If the battery level is too low, recharge before use.

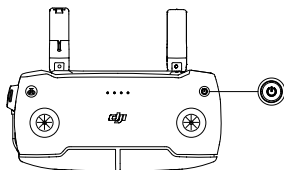

Charging the Battery

Use a Micro USB cable to connect the USB charger to the Micro USB port of the remote controller.

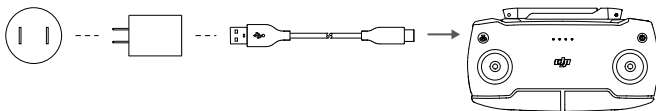

Controlling the Camera

1. Record Button: Press to start/stop recording (Video) or switch to video mode (Photo).
2. Shutter Button: Press to take photo (Photo) or switch to photo mode (Video).

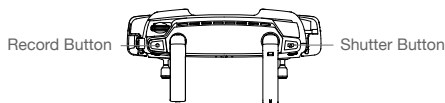

Controlling the Aircraft

Three pre-programmed modes (Mode 1, Mode 2, and Mode 3) are available and custom modes can be defined in the DJI Fly app. The default mode is Mode 2.

Mode 1

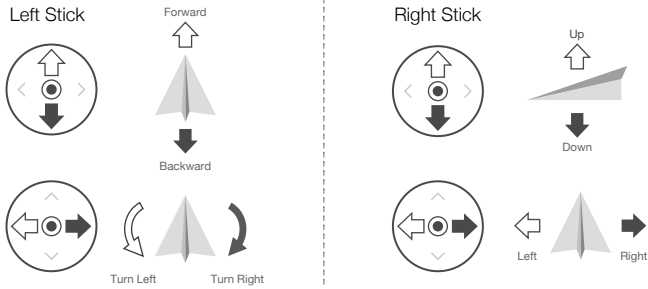



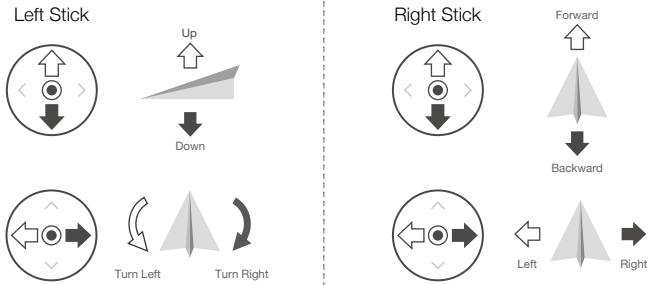

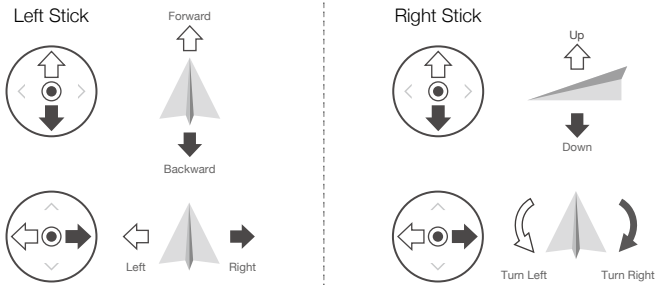

Mode 2

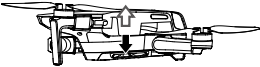

Mode 3

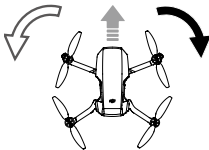

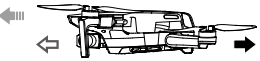
The figure below explains how to use each control stick, using Mode 2 as an example.

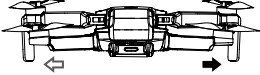
Remote Controller (Mode 2)	Aircraft (← Indicates Nose Direction)	Remarks
		<p>Moving the left stick up or down changes the aircraft's altitude. Push the stick up to ascend and down to descend. The more the stick is pushed away from the center position, the faster the aircraft will change altitude. Push the stick gently to prevent sudden and unexpected changes in altitude.</p>
		<p>Moving the left stick to the left or right controls the orientation of the aircraft. Push the stick left to rotate the aircraft counter-clockwise and right to rotate the aircraft clockwise. The more the stick is pushed away from the center position, the faster the aircraft will rotate.</p>
		<p>Moving the right stick up and down changes the aircraft's pitch. Push the stick up to fly forward and down to fly backward. The more the stick is pushed away from the center position, the faster the aircraft will move.</p>
		<p>Moving the right stick to the left or right changes the aircraft's roll. Push the stick left to fly left and right to fly right. The more the stick is pushed away from the center position, the faster the aircraft will move.</p>

Flight Pause/RTH Button

Press once to make the aircraft brake and hover in place. If the aircraft is performing a QuickShot, RTH, or auto landing, press once to exit the procedure and hover in place.

Press and hold the RTH button to start RTH. Press this button again to cancel RTH and regain control of the aircraft. Refer to the Return to Home section for more information about RTH.

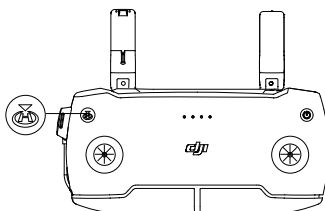

Optimal Transmission Zone

The signal between the aircraft and the remote controller is most reliable when the antennas are positioned in relation to the aircraft as depicted below.

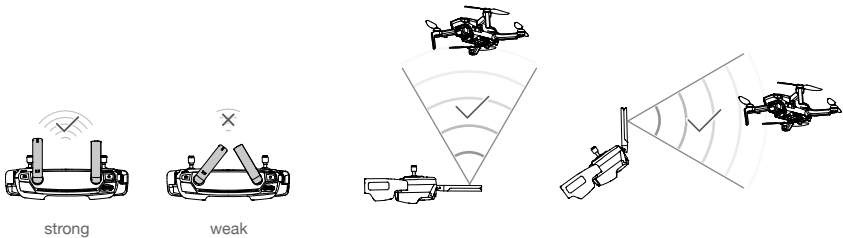

Linking the Remote Controller

The remote controller is linked to the aircraft before delivery. Linking is only required when using a new remote controller for the first time. Follow these steps to link a new remote controller:

1. Power on the remote controller and the aircraft.
2. Launch DJI Fly. In camera view, tap the  icon and select Shortcuts and Connect to Aircraft, or press and hold the power button of the remote controller for more than four seconds. The remote controller beeps continuously indicating it is ready to link.
3. Press and hold the power button of the aircraft for more than four seconds. The aircraft beeps once indicating it is ready to link. The aircraft beeps twice indicating linking is successfully.



- Make sure the remote controller is within 0.5 m of the aircraft during linking.
- The remote controller will automatically unlink from an aircraft if a new remote controller is linked to the same aircraft.



- Fully charge the remote controller before each flight.
- If the remote controller is powered on and not in use for five minutes, an alert will sound. After six minutes, the aircraft automatically powers off. Move the control sticks or press any button to cancel the alert.
- Adjust the mobile device clamp to ensure the mobile device is secure.
- Make sure the antennas of the remote controller are unfolded and adjusted to the proper position to achieve optimal transmission quality.
- Repair or replace the remote controller if damaged. A damaged remote controller antenna greatly decreases performance.
- Fully charge the battery at least once every three months to maintain battery health.

DJI Fly App

This section introduces the main functions of the DJI Fly app.

DJI Fly App

Home

Launch DJI Fly and enter the home screen.

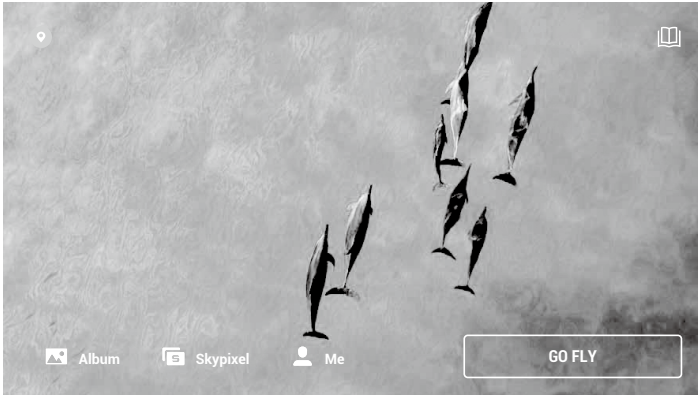

Academy

Tap the icon in the top right corner to enter Academy. Product tutorials, flight tips, flight safety, and manual documents can be viewed here.

Album

Allows you to view the DJI Fly and your phone's album. QuickShots videos can be viewed after downloading to your phone. Create contains Templates and Pro. Templates provides auto edit feature for imported footage. Pro allows you to edit the footage manually.

SkyPixel

Enter SkyPixel to view videos and photos shared by users.

Profile

View account information, flight records, DJI forum, online store, Find My Drone feature, and other settings.

Camera View

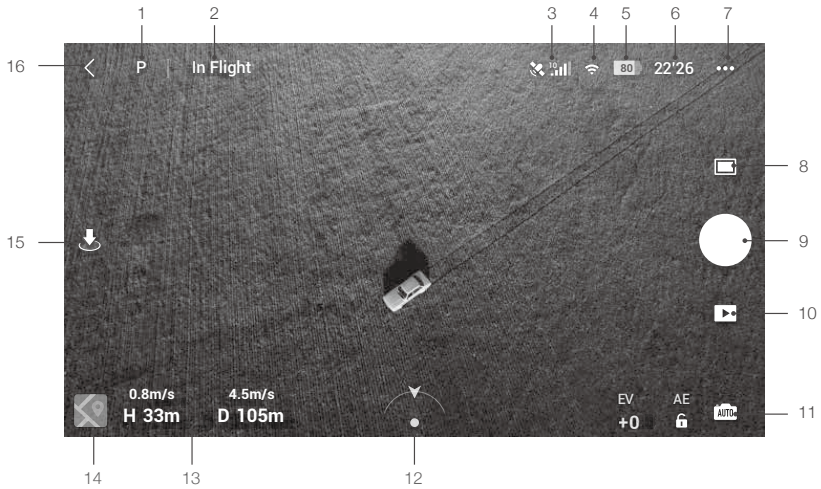

1. Flight Modes

P : Tap to switch Flight modes between Position, Sport, and CineSmooth mode.

2. System Status Bar

In Flight : Indicates aircraft flight status and displays various warning messages.

3. GPS Status

: Shows the current GPS signal strength.

4. Wi-Fi Strength

: Displays the Wi-Fi strength between the aircraft and remote controller.

5. Battery Level

80 : Shows the current battery level.

6. Battery Information

22'26 : Displays battery information such as battery temperature, voltage, and flight time.

7. System Settings

••• : There are Safety, Control, Camera, Transmission and About.

Safety

Flight Protection: Max Altitude, Max Distance, Auto RTH Altitude settings, and Update Home Point.

Sensors: View the IMU and compass status and start to calibrate if necessary.

Advanced Settings including Emergency Propeller Stop and Payload mode. "Emergency Only" indicates that the motors can only be stopped mid-flight in an emergency situation such as if there is a collision, a motor has stalled, the aircraft is rolling in the air, or the aircraft is out of control and ascending or descending very quickly. "Anytime" indicates that the motors can be stopped mid-flight anytime once the user performs a combination stick command (CSC). Stopping the motors mid-flight will cause the aircraft to crash.

If accessories are mounted to Mavic Mini, it is recommended to enable Payload mode for enhanced safety. After takeoff, Payload mode is enabled automatically if a payload is detected. Note that the Max Service Ceiling above Sea Level is 1500 m and the max flight speed is limited when Payload mode is enabled.

The Find My Drone feature helps to find the location of the aircraft on the ground.

Control

Aircraft Settings: Select Flight mode and Units settings.

Gimbal Settings: Switch gimbal mode and calibrate gimbal. Advanced gimbal settings include Pitch Speed, Pitch Smoothness, and Allow Upward Gimbal Rotation.

Remote Controller Settings: Stick mode settings and remote controller calibration.

Beginner Flight Tutorial: View the flight tutorial.

Connect to Aircraft: When the aircraft is not linked to the remote controller, tap to start linking.

Camera

Set the photo size and select the microSD card settings.

Advanced Settings such as Histogram, Gridlines, Overexposure Warning, and Anti-Flicker.

Tap Reset Camera Settings to restore all camera settings to default.

Transmission

Frequency and Channel mode settings.

About

View device information, firmware information, app version, battery version, and more.

8. Shooting Modes

 Photo: Choose between Single Shot and Interval.

Video: Video resolution can be set to 2.7K 25/30 fps and 1080P 25/30/50/60 fps.

QuickShots: Choose from Dronie, Circle, Helix, and Rocket.

9. Shutter/Record Button

 : Tap to start shooting photos or recording video.

10. Playback

 : Tap to enter playback and preview photos and videos as soon as they are captured.

11. Camera Modes Switch

 : Choose between Auto and Manual mode when in photo mode. In Manual mode, shutter and ISO can be set. In Auto mode, AE lock and EV can be set.

12. Aircraft Orientation

 : Display the real-time orientation of the aircraft.

13. Flight Telemetry

Displays the distance between the aircraft and the Home Point, height from the Home Point, aircraft horizontal speed, and aircraft vertical speed.

14. Map

 : Tap to view the map.

15. Auto Takeoff/Landing/Smart RTH

 : Tap this icon. When the prompt appears, press and hold the button to initiate auto takeoff or landing.

 : Tap to initiate Smart RTH and have the aircraft return to the last recorded Home Point.

16. Back

 : Tap to return to the home screen.



- Make sure to fully charge your mobile device before launching DJI Fly.
 - Mobile cellular data is required when using DJI Fly. Contact your wireless carrier for data charges.
 - If you are using a mobile phone as your display device, DO NOT accept phone calls or use texting features during flight.
 - Read all safety tips, warning messages, and disclaimers carefully. Be familiar with the related regulations in your area. You are solely responsible for being aware of all relevant regulations and flying in a way that is compliant.
 - a. Read and understand the warning messages before using the Auto-take off and Auto-landing features.
 - b. Read and understand the warning messages and disclaimer before setting the altitude beyond the default limit.
 - c. Read and understand the warning messages and disclaimer before switching between flight modes.
 - d. Read and understand the warning messages and disclaimer prompts near or in GEO zones.
 - e. Read and understand the warning messages before using the Intelligent Flight Mode.
 - Land your aircraft immediately at a safe location if a prompt to land appears in the app.
 - Review all warning messages on the checklist displayed in the app before each flight.
 - Use the in-app tutorial to practice your flight skills if you have never operated the aircraft or if you do not have sufficient experience to operate the aircraft with confidence.
 - Cache the map data of the area where you intend to fly the aircraft by connecting to the internet before each flight.
 - The app is designed to assist your operation. Use your discretion and DO NOT rely on the app to control your aircraft. Your use of the app is subject to DJI Fly Terms of Use and DJI's Privacy Policy. Read them carefully in the app before flying.
-

Flight

This section describes safe flight practices and flight restrictions.

Flight

Once pre-flight preparation is complete, it is recommended to hone your flight skills and practice flying safely. Make sure that all flights are carried out in an open area. Refer to the Remote Controller and DJI Fly sections for information about using the remote controller and the app to control the aircraft.

Flight Environment Requirements

1. Do not use the aircraft in severe weather conditions including wind speeds exceeding 8 m/s, snow, rain, and fog.
2. Fly in open areas. Tall structures and large metal structures may affect the accuracy of the onboard compass and GPS system.
3. Avoid obstacles, crowds, high voltage power lines, trees, and bodies of water.
4. Minimize interference by avoiding areas with high levels of electromagnetism such as locations near power lines, base stations, electrical substations, and broadcasting towers.
5. Aircraft and battery performance are subject to environmental factors such as air density and temperature. Be careful when flying 9842 ft (3000 m) or more above sea level, since battery and aircraft performance may be reduced.
6. Mavic Mini cannot use GPS within the Polar Regions. Use the Downward Vision System when flying in such locations.

Flight Limits and GEO Zones

Unmanned aerial vehicle (UAV) operators should abide by the regulations from self-regulatory organizations such as the International Civil Aviation Organization, the Federal Aviation Administration, and local aviation authorities. For safety reasons, flight limits are enabled by default to help users operate this aircraft safely and legally. Users can set flight limits on height and distance.

Altitude limits, distance limits, and GEO zones function concurrently to manage flight safety when GPS is available. Only altitude can be limited when GPS is unavailable.

Flight Altitude and Distance Limits

The flight altitude and distance limits can be changed in DJI Fly. Based on these settings, the aircraft will fly in a restricted cylinder, as shown below:

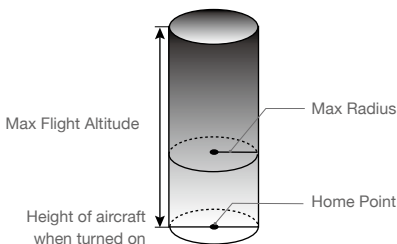

When GPS is available

	Flight Limits	DJI Fly App	Aircraft Status Indicator
Max Altitude	Aircraft's altitude cannot exceed the specified value	Warning: Height limit reached	Blinks green and red alternatively
Max Radius	Flight distance must be within the max radius	Warning: Distance limit reached	

Only Downward Vision System is available

	Flight Limits	DJI Fly App	Aircraft Status Indicators
Max Altitude	Height is restricted to 16 ft (5 m) when the GPS signal is weak and Downward Vision System is activated. Height is restricted to 98 ft (30 m) when the GPS signal is weak and Downward Vision System is inactive.	Warning: Height limit reached.	Blinks green and red alternatively
Max Radius	Blinks yellow		



- If the aircraft in a GEO zone and there is a weak or no GPS signal, the aircraft status indicator will glow red for five seconds every twelve seconds.
- If the aircraft reaches a limit, you can still control the aircraft, but you cannot fly it any further. If the aircraft flies out of the max radius, it will automatically fly back within range when the GPS signal is strong.
- For safety reasons, do not fly close to airports, highways, railway stations, railway lines, city centers, or other sensitive areas. Fly the aircraft only within your line of sight.

GEO Zones

All GEO zones are listed on the DJI official website at <http://www.dji.com/flysafe>. GEO zones are divided into different categories and include locations such as airports, flying fields where manned aircraft operate at low altitudes, borders between countries, and sensitive locations such as power plants.

There will be prompts in DJI Fly app alerting users of any nearby GEO zones.

Pre-Flight Checklist

1. Make sure the remote controller, mobile device, and Intelligent Flight Battery are fully charged.
2. Make sure the Intelligent Flight Battery and the propellers are mounted securely.
3. Make sure the aircraft arms are unfolded.
4. Make sure the gimbal and camera are functioning normally.
5. Make sure nothing is obstructing the motors and that they are functioning normally.
6. Make sure DJI Fly is successfully connected to the aircraft.
7. Make sure the camera lens and Vision System sensors are clean.

8. Use only genuine DJI parts or parts certified by DJI. Unauthorized parts or parts from non-DJI certified manufacturers may cause system malfunctions and compromise safety.

Auto Takeoff/Landing



Auto Takeoff

1. Launch DJI Fly and enter the camera view.
2. Complete all steps in the pre-flight checklist.
3. Tap . If conditions are safe for takeoff, press and hold the button to confirm.
4. The aircraft will take off and hover 3.9 ft (1.2 m) above the ground.

-
- ⚠️ • The aircraft status indicator shows whether the aircraft is using GPS and/or the Downward Vision System for flight control. It is recommended to wait until the GPS signal is strong before using auto takeoff.
 - DO NOT takeoff from an moving surface, such as a moving boat or vehicle.
-

Auto Landing

Use auto landing when the aircraft status indicator blinks green.

1. Tap . If conditions are safe to land, press and hold the button to confirm.
2. Auto landing can be cancelled by tapping .
3. If the Vision System is working normally, Landing Protection will be enabled.
4. Motors stops after landing.

-
- ⚠️ Choose the proper place for landing.
-

Starting/Stopping the Motors

Starting the Motors

A Combination Stick Command (CSC) is used to start the motors. Push both sticks to the bottom inner or outer corners to start the motors. Once the motors have started spinning, release both sticks simultaneously.

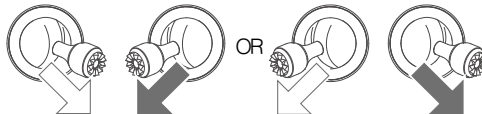

Stopping the Motors

There are two methods to stop the motors.

1. Method 1: When the aircraft has landed, push and hold the left stick down. The motors will stop after three seconds.
2. Method 2: When aircraft has landed, push the left stick down, then conduct the same CSC that was used to start the motors, as described above. The motors will stop immediately. Release both sticks once the motors have stopped.

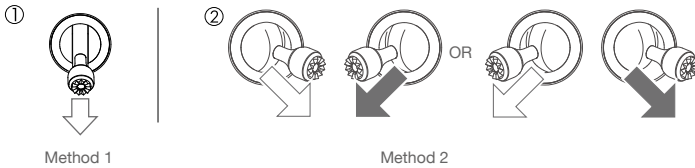

Stopping Motors Mid-flight

Stopping motors mid-flight will cause the aircraft to crash. The motors should only be stopped mid-flight in an emergency situation such as if a collision has occurred or if the aircraft is out of control and is ascending/descending very quickly, rolling in the air, or if a motor has stalled. To stop the motors mid-flight use the same CSC that was used to start the motors.

Flight Test

Takeoff/Landing Procedures

1. Place the aircraft in an open, flat area with the aircraft status indicator facing towards you.
2. Turn on the aircraft and the remote controller.
3. Launch DJI Fly and enter the camera view.
4. Wait until the aircraft status indicator blinks green indicating that the Home Point has been recorded and it is now safe to fly.
5. Gently push the throttle stick to take off or use auto-takeoff.
6. Pull the throttle stick or use auto-landing to land the aircraft.
7. After landing, push the throttle stick down and hold. The motors stop after three seconds.
8. Turn off the aircraft and remote controller.

Video Suggestions and Tips

1. The pre-flight checklist is designed to help you fly safely and to ensure that you can shoot video during flight. Go through the full pre-flight checklist before each flight.
2. Select the desired gimbal operation mode in DJI Fly.
3. Shoot video when flying in P-mode or C-mode.
4. DO NOT fly in bad weather conditions such as when it is raining or windy.
5. Choose the camera settings that best suit your needs.
6. Perform flight tests to establish flight routes and to preview scenes.
7. Push the control sticks gently to keep the aircraft movement smooth and stable.

Appendix

Appendix

Specifications

Aircraft	
Takeoff Weight	249 g / 199 g (JP version)
Dimensions (L×W×H)	Folded: 140×82×57 mm Unfolded: 160×202×55 mm Unfolded (with propellers): 245×290×55 mm
Diagonal Distance	213 mm
Max Ascent Speed	4 m/s (S Mode) 2 m/s (P Mode) 1.5 m/s (C Mode)
Max Descent Speed	3 m/s (S Mode) 1.8 m/s (P Mode) 1 m/s (C Mode)
Max Speed (near sea level, no wind)	13 m/s (S Mode) 8 m/s (P Mode) 4 m/s (C Mode)
Max Service Ceiling Above Sea Level	3000 m
Max Flight Time	30 mins (measured while flying at 14 kph in windless conditions) 18 mins for JP version (measured while flying at 12 kph in windless conditions)
Max Wind Speed Resistance	8 m/s (Scale 4)
Max Tilt Angle	30° (S Mode) 20° (P Mode) 20° (C Mode)
Max Angular Velocity	150°/s (S Mode) 130°/s (P Mode) 30°/s (C Mode)
Operating Temperature Range	0° to 40° C (32° to 104° F)
GNSS	GPS+GLONASS
Operating Frequency	Model MT1SS5: 5.725-5.850 GHz Model MT1SD25: 2.400-2.4835 GHz, 5.725-5.850 GHz
Transmission Power (EIRP)	Model MT1SS5 5.8 GHz: <30 dBm (FCC); <28 dBm (SRRC) Model MT1SD25 2.4 GHz: <19 dBm (MIC/CE) 5.8 GHz: <14 dBm (CE)

Hovering Accuracy Range	Vertical: ± 0.1 m (with Vision Positioning), ± 0.5 m (with GPS Positioning) Horizontal: ± 0.3 m (with Vision Positioning), ± 1.5 m (with GPS Positioning)
Gimbal	
Mechanical Range	Tilt: -110° to $+35^\circ$ Roll: -35° to $+35^\circ$ Pan: -20° to $+20^\circ$
Controllable Range	Tilt: -90° to 0° (default setting), -90° to $+20^\circ$ (extended)
Stabilization	3-axis (tilt, roll, pan)
Max Control Speed (tilt)	$120^\circ/\text{s}$
Angular Vibration Range	$\pm 0.01^\circ$
Sensing System	
Downward	Operating Range: 0.5-10 m
Operating Environment	Non-reflective, discernable surfaces with diffuse reflectivity of $>20\%$ Adequate lighting of lux >15
Camera	
Sensor	1/2.3" CMOS Effective Pixels: 12 MP
Lens	FOV: 83° 35 mm Format Equivalent: 24 mm Aperture: f/2.8 Focus Range: 1 m to ∞
ISO	Video: 100-3200 (Auto) Photo: 100-3200
Shutter Speed	Electronic Shutter: Video: 1/8000-1/fps (Auto) Photo: 4-1/8000 s (Manual), 1-1/8000 s (Auto)
Still Image Size	4:3: 4000 \times 3000 16:9: 4000 \times 2250
Still Photography Modes	Single shot Interval: 2/3/5/7/10/15/20/30/60 s
Video Resolution	2.7K: 2720 \times 1530 25/30 p FHD: 1920 \times 1080 25/30/50/60 p
Max Video Bitrate	40 Mbps
Supported File System	FAT32 (≤ 32 GB) exFA (> 32 GB)
Photo Format	JPEG
Video Format	MP4 (H.264/MPEG-4 AVC)
Remote Controller	
Operating Frequency	Model MR1SS5: 5.725 - 5.850 GHz Model MR1SD25: 2.400 - 2.4835 GHz, 5.725 - 5.850 GHz

Max Transmission Distance (unobstructed, free of interference)	Model MR1SS5: 5.8 GHz: 4000 m (FCC); 2500 m (SRRC) ModelMR1SD25: 2.4 GHz: 2000 m (MIC/CE) 5.8 GHz: 500 m (CE)
Operating Temperature Range	0° to 40° C (32° to 104° F)
Transmitter Power (EIRP)	ModelMR1SS5: 5.8 GHz: <30 dBm (FCC); <28 dBm (SRRC) ModelMR1SD25: 2.4 GHz: <19 dBm (MIC/CE) 5.8 GHz: <14 dBm (CE)
Battery Capacity	2600 mAh
Operating Current/Voltage	1200 mA 3.6 V (Android) 450 mA 3.6 V (iOS)
Supported Mobile Device Size	Max length: 160 mm Max thickness: 6.5 - 8.5 mm
Supported USB Port Types	Lightning, Micro USB (Type-B), USB-C
Video Transmission System	Enhanced Wi-Fi
Live View Quality	Remote Controller: 720p@30fps
Max. Bitrate	4 Mbps
Latency (depending on environmental conditions and mobile device)	170 - 240 ms
Charger	
Input	100 - 240V, 50/60 Hz, 0.5A
Output	12V 1.5A / 9V 2A / 5V 3A
Rated Power	18 W
Intelligent Flight Battery (General Version)	
Battery Capacity	2400 mAh
Voltage	7.2 V
Max Charging Voltage	8.4 V
Battery Type	Li-ion 2S
Energy	17.28 Wh
Weight	100 g
Charging Temperature Range	5° to 40° C (41° to 104° F)
Max Charging Power	24 W
Intelligent Flight Battery (JP Version)	
Capacity	1100 mAh
Voltage	7.6 V
Max Charging Voltage	8.7 V
Battery Type	LiPo 2S
Energy	8.36 Wh
Weight	50 g
Charging Temperature Range	5° to 40° C (41° to 104° F)

Max Charging Power	18 W
App	
App	DJI Fly
Required Operating System	iOS v10.0.2 or later; Android v6.0 or later
SD Cards	
Supported SD Cards	microSD Class 10 or UHS-I Speed Grade 3 rating with the above write speed better than 20MB/s required
Recommended microSD Cards	16GB: SanDisk Extreme, Lexar 633x 32GB: Samsung PRO Endurance, Samsung EVO Plus, SanDisk Industrial, SanDisk Extreme V30 A1, SanDisk Extreme PRO V30 A1, Lexar 633x, Lexar 667x 64GB: Samsung PRO Endurance, Samsung EVO Plus, SanDisk Extreme V30 A1, Lexar 633x, Lexar 667x, Lexar 1000x, Toshiba Exceria M303 V30 A1, Netac PRO V30 A1 128GB: Samsung PRO Plus, Samsung EVO Plus, SanDisk Extreme V30 A1, SanDisk Extreme Plus V30 A1, Lexar 633x, Lexar 667x, Lexar 1000x, Toshiba Exceria M303 V30 A1, Netac Pro V30 A1 256GB, SanDisk Extreme V30 A1

-  • Aircraft takeoff weight includes battery, propellers, and a microSD card.
 - Registration not required in some countries and regions. Check local rules and regulations before use.
 - These specifications have been determined through tests conducted with the latest firmware. Firmware updates can enhance performance. It is highly recommended to update to the latest firmware.
-

Calibrating the Compass

It is recommended that the compass is calibrated in any of the following situations when flying outdoors:

1. Flying at a location further than 31 miles (50 km) away from the location the drone was last flown.
 2. The aircraft has not been flown for more than 30 days.
 3. A compass interference warning appears in DJI Fly and/or the aircraft status indicator blinks red and yellow alternatively.
-

-  • DO NOT calibrate the compass in locations where magnetic interference may occur, such as close to magnetite deposits or large metallic structures such as parking structures, steel reinforced basements, bridges, cars, or scaffolding.
 - DO NOT carry objects (such as mobile phones) that contain ferromagnetic materials near the aircraft during calibration.
 - It is not necessary to calibrate the compass when flying indoors.
-

Calibration Procedure

Choose an open area to carry out the following procedure.

1. Tap the System Settings in DJI Fly, select "Control" and then select "Calibrate", and follow the on-screen instructions. The aircraft status indicator blinks yellow, indicating calibration has start.

2. Hold the aircraft horizontally and rotate it 360 degrees. The aircraft status indicator will turn solid green.
3. Hold the aircraft vertically, with its nose pointing downward, and rotate it 360 degrees around a vertical axis.
4. If the aircraft status indicator blinks red, the calibration has failed. Change your location and try the calibration procedure again.

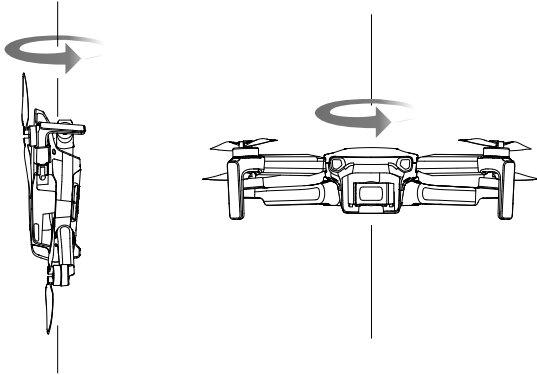

- If the aircraft status indicator blinks red and yellow alternatively after calibration is completed, this indicates that the current location is not suitable for flying the aircraft, due to the level of magnetic interference. Change your location.



- A prompt will appear in DJI Fly if compass calibration is required before takeoff.
 - The aircraft can take off immediately once calibration is complete. If you wait more than three minutes to take off after calibration, you may need to repeat the calibration process.
-

Firmware Update

Use DJI Fly or DJI Assistant 2 for Mavic to update the aircraft and the remote controller firmware.

Using DJI Fly

When you connect the aircraft and remote controller to DJI Fly, you will be notified if a new firmware update is available. To start updating, connect your mobile device to the internet and follow the on-screen instructions. Note that you cannot update the firmware if the remote controller is not linked to the aircraft.

Using DJI Assistant 2 for Mavic

Update the aircraft and remote controller firmware separately using DJI Assistant 2 for Mavic.

The Micro USB port is used when connecting the aircraft to a computer to update firmware. Follow the instructions below to update the aircraft firmware through DJI Assistant 2 for Mavic:

1. Launch DJI Assistant 2 for Mavic and log in with your DJI account.
2. Power on the aircraft, and then connect the aircraft to a computer via the Micro USB port using a Micro USB cable within 20 seconds.
3. Select "Mavic Mini" and click on Firmware Updates on the left panel.
4. Select the firmware version that you wish to update to.
5. Wait for the firmware to download. The firmware update will start automatically.
6. The aircraft will be powered off automatically after the firmware update is complete.

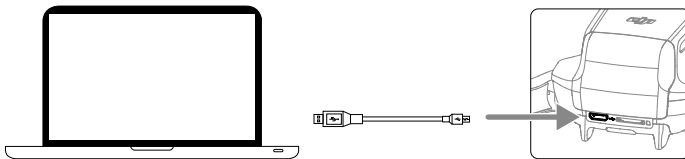

Follow the instructions below to update the aircraft firmware through DJI Assistant 2 for Mavic:

1. Launch DJI Assistant 2 for Mavic and log in with your DJI account.
2. Power on the remote controller, and then connect to a computer via the Micro USB port using a Micro USB cable.
3. Select "Mavic Mini remote controller" and click on Firmware Updates on the left panel.
4. Select the firmware version that you wish to update to.
5. Wait for the firmware to download. The firmware update will start automatically.
6. Wait for the firmware update to be completed.

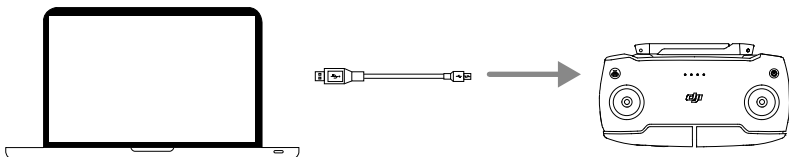



- Make sure to follow all the steps to update firmware. Otherwise, the update may fail.
 - The firmware update will take around 10 minutes. It is normal that the gimbal goes limp, aircraft status indicators blink, and the aircraft reboots. Wait patiently until the update is complete.
 - Make sure the computer has access to the internet.
 - Before performing an update, make sure the Intelligent Flight Battery and the remote controller have at least 30% power.
 - Do not disconnect the device from the computer during an update.
 - The remote controller may become unlinked from the aircraft after updating. Relink the remote controller and aircraft. Note that the update may reset various main controller settings, such as the RTH altitude and the maximum flight distance, to default settings. Before updating, take note of your preferred DJI Fly settings, and readjust them after the update.
-

After-sales information

Visit <https://www.dji.com/support> to learn more about after-sales service policies, repair services, and support.

DJI Support
<http://www.dji.com/support>

This content is subject to change.

Download the latest version from
<http://www.dji.com/mavic-mini>

If you have any questions about this document, please contact
DJI by sending a message to **DocSupport@dji.com**.

MAVIC is a trademark of DJI.

Copyright © 2019 DJI All Rights Reserved.