



RAD – The Radiation Assessment Detector for MSL

The Radiation Assessment Detector (RAD)

Scot C. R. Rafkin, RAD Project Scientist
Southwest Research Institute, Boulder, Colorado
rafkin@boulder.swri.edu (720)240-0116





Presentation Outline



RAD – The Radiation Assessment Detector for MSL

- RAD Team and Organization
- RAD Instrument Overview
 - Design Drivers
 - Principle of Operation
 - Predicted Performance
 - RAD Build and Delivery Schedule
- RAD on Mars Science Laboratory
 - Science Requirements Flowdown Summary
 - Investigation Background
 - Science Objectives
 - Measurement Requirements
- Summary



RAD Organization



RAD – The Radiation Assessment Detector for MSL

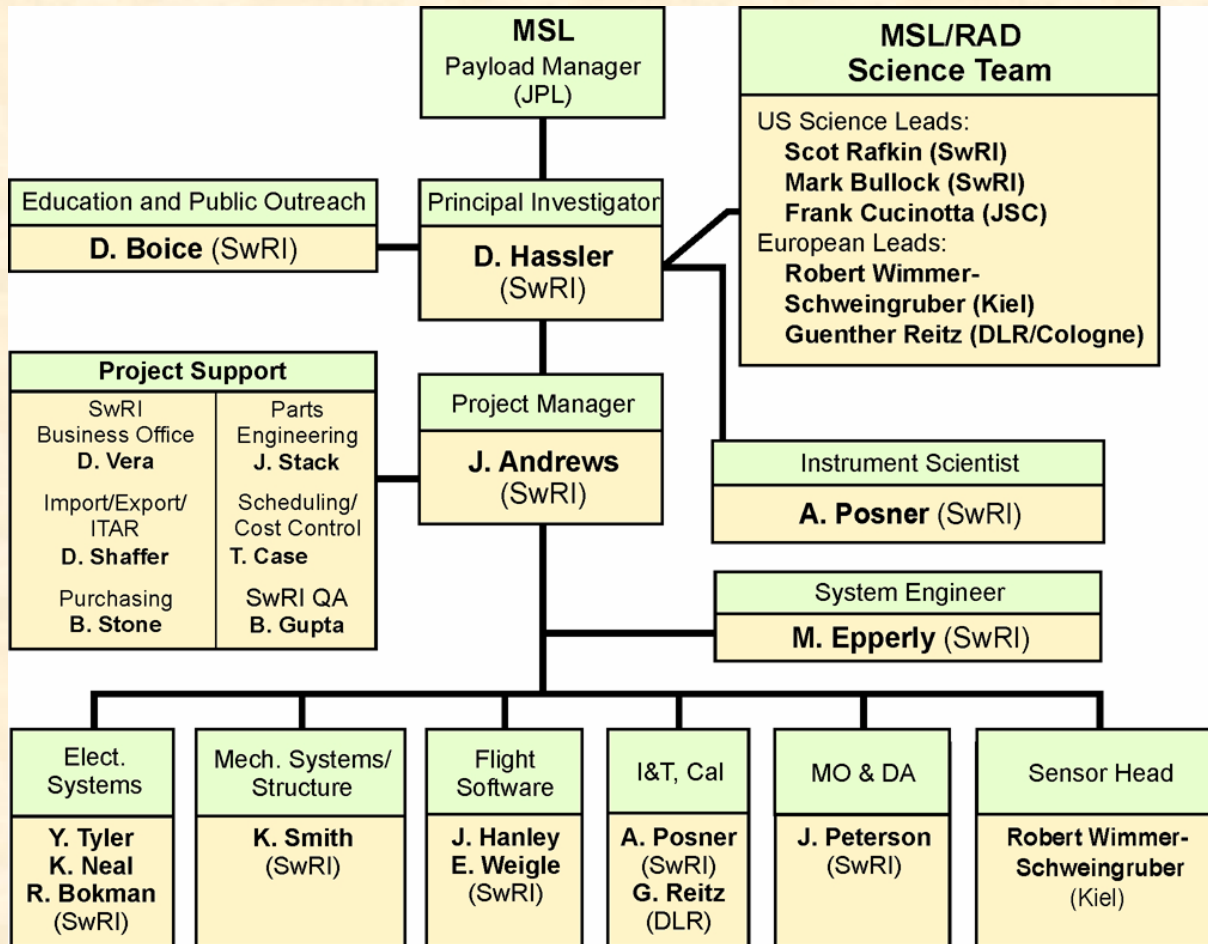

RAD Team is in place for completing Design and Development at both SwRI and CAU/Kiel

RAD Core Team interfaces to MSL Project via the RAD Instrument Engineer (A. Sirota) and RAD Investigation Scientist (D. Brinza)



RAD Teaming Arrangements & Responsibilities



RAD – The Radiation Assessment Detector for MSL

| | |
|---|---|
| <p align="center">SwRI</p> <p align="center">PI Institution, RAD electronics, Project Management, System Engineering, Instrument I&T, Data Analysis</p> | <p align="center">CAU – Kiel, Germany</p> <p align="center">Co-I Institution, RAD Sensor Head, Data Analysis</p> |
| <p>Large Non-Profit Research Organization (>3000 employees, >\$400M 2005 revenues). 30+ years experience w/ space research and instrumentation w/ >50 space borne scientific instruments developed and operated. Well equipped facilities for systems I&T.</p> | <p>Large research university in Germany. Very experienced team of radiation/plasma detection instrumentalists w/ recent experience on STEREO, SOHO, ISS, Ulysses. Well equipped facilities for developing space flight instrumentation.</p> |
| <p align="center">DLR – Cologne, Germany</p> <p align="center">RAD Instr. Calibration Lead, Data Analysis</p> | <p align="center">NASA/JSC</p> <p align="center">Astronaut Safety, Data Analysis</p> |
| <p>Branch of German Aerospace Agency in Cologne. Experienced w/ dosimetry, Astronaut Safety, and calibration of radiation detection instrumentation.</p> | <p>NASA field center with oversight of manned spaceflight, oversees and implements NASA's Astronaut Safety program. Experienced w/ dosimetry and radiation data analysis.</p> |



Design Challenges



RAD – The Radiation Assessment Detector for MSL

- Low mass, power (energy) and telemetry requirements driven by unique aspects of MSL mission
- Extreme thermal environment and rarified CO₂ atmosphere unique to Mars Surface Operations
- Extremely wide energy dynamic range required to observe both electrons, protons and iron with same instrument
- Extremely wide variation in fluence of relevant species must be observed to characterize both GCR and SPE with same instrument



RAD Instrument Overview



RAD – The Radiation Assessment Detector for MSL

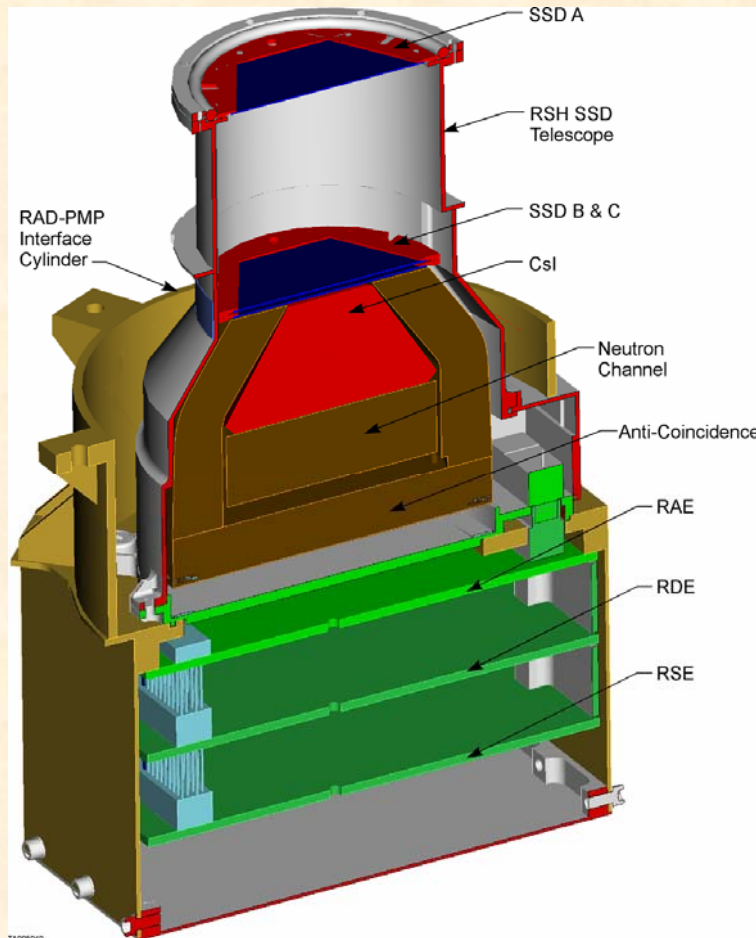

- Solid state detector telescope and CsI calorimeter with active coincidence logic to identify charged particles. Separate scintillators with anti-coincidence logic to detect neutrons and γ -rays.
- Zenith pointed with 65 deg. FOV, 100 mm²*sr geometric factor
- Large internal storage - 16 Mbyte
- CBE Mass = 1.52 kg
- Power (obs) = 4.1 W
- Telemetry = 1 Mbit/sol



RAD Functional Diagram (Principle of Operation)



RAD – The Radiation Assessment Detector for MSL

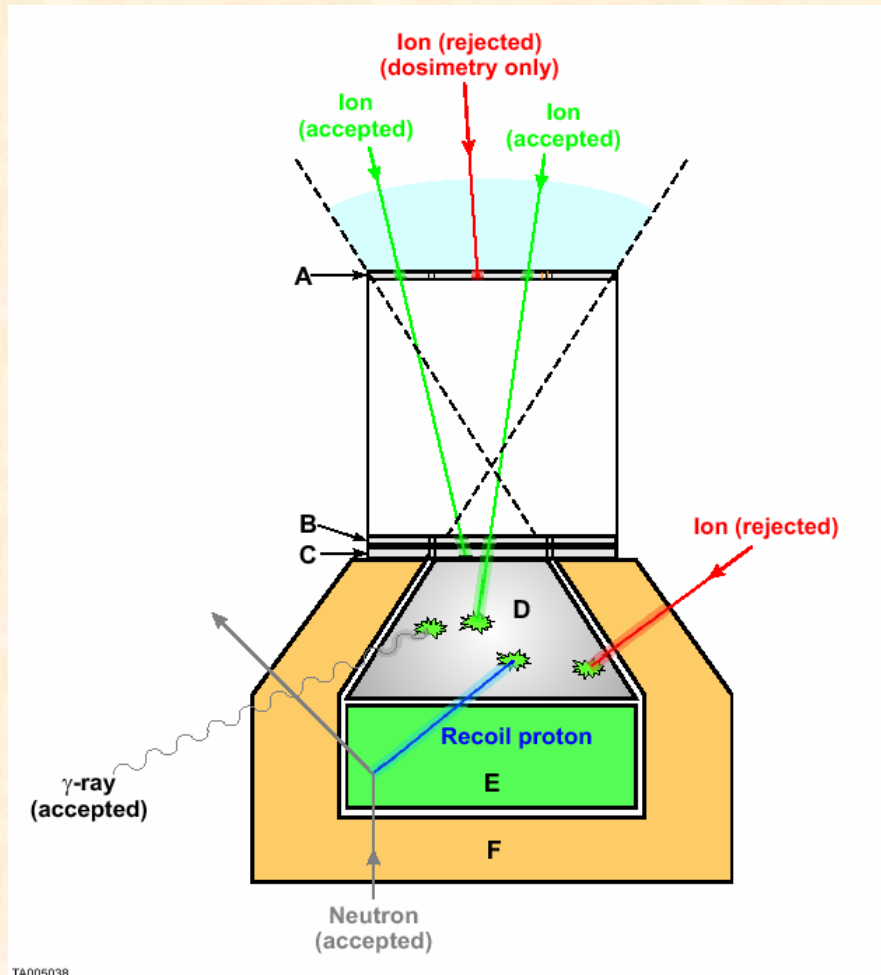

Legend

- A Solid State Detector (SSD) A
- B SSD B
- C SSD C
- D Cesium Iodide (CsI)
- E Neutron Channel (Bicron 430M scintillating plastic)
- F Anti-coincidence Shield

TA005038



RAD Functional Block Diagram



RAD - The Radiation Assessment Detector for MSL

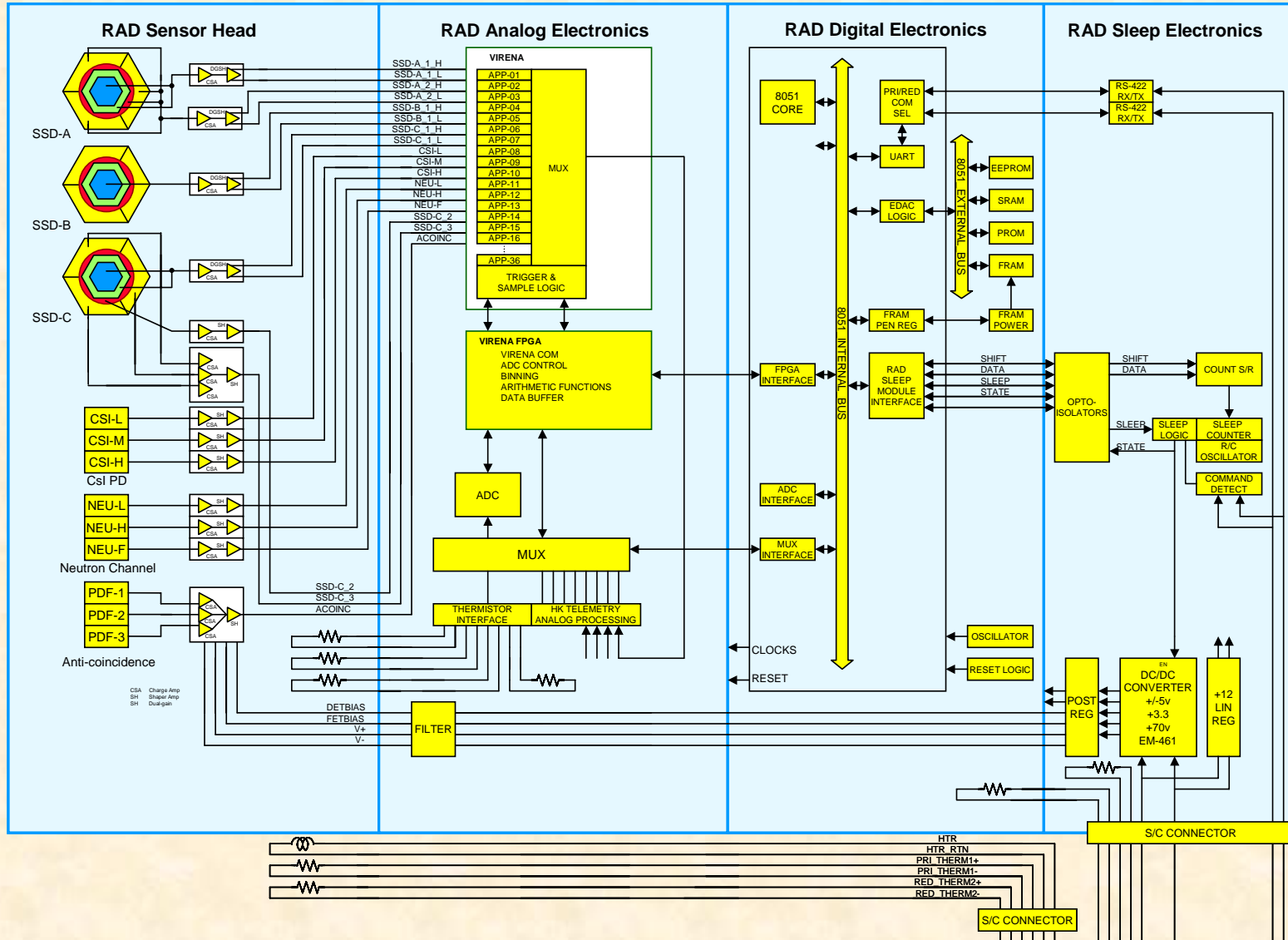



RAD Energy Coverage



RAD – The Radiation Assessment Detector for MSL

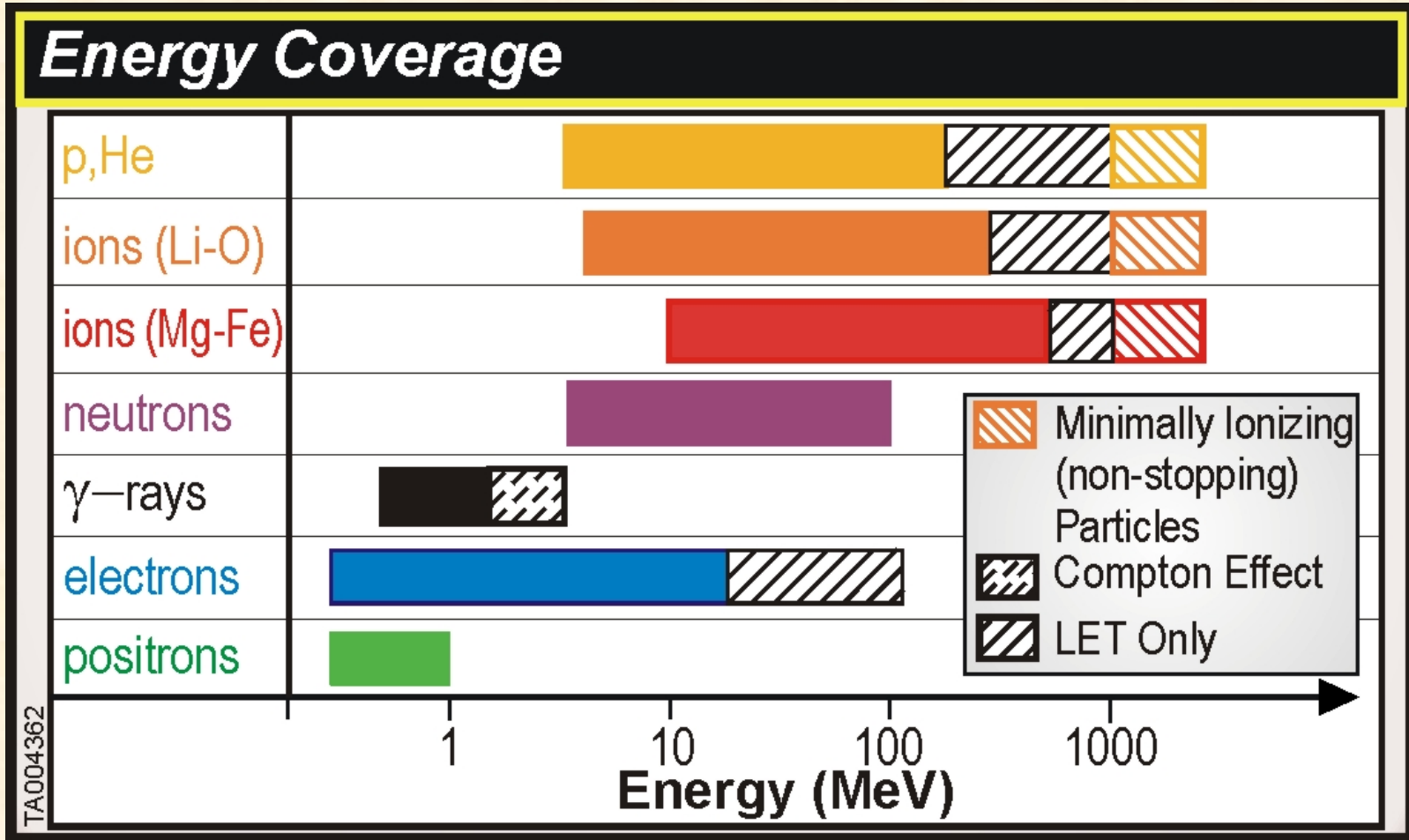



RAD Species Identification uses dE/dx vs E Method



RAD – The Radiation Assessment Detector for MSL

Stopping Charged Particles

dE/dx (SSD-A) and geometry factor versus total energy deposit

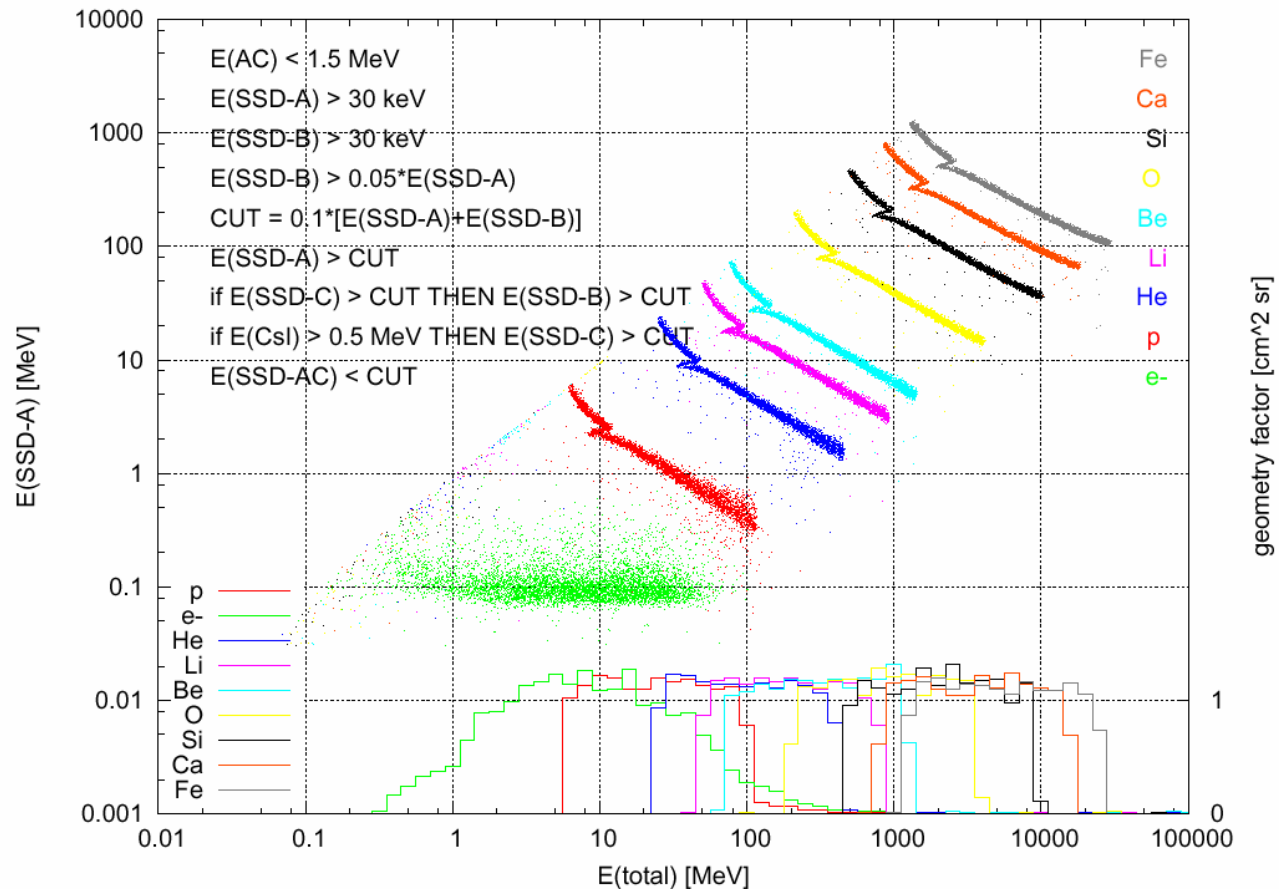



Data Matrix Bins

RAD – The Radiation Assessment Detector for MSL

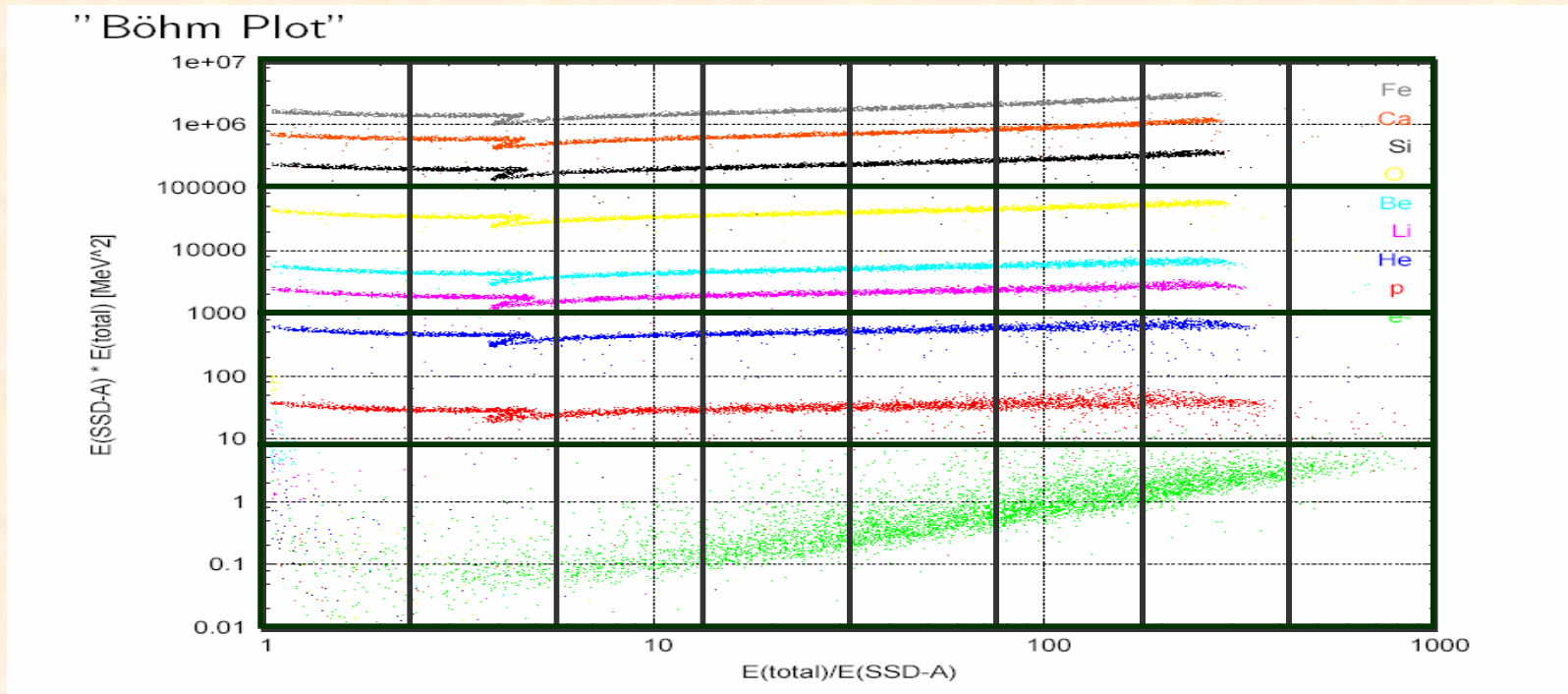



Predicted Performance (Signal-to-Noise)

RAD – The Radiation Assessment Detector for MSL



| | GCR S/N (required) | GCR S/N (current best estimate) | GCR S/N Margin | SPE S/N (required) | SPE S/N (current best estimate) | SPE S/N Margin |
|--------------------|-----------------------|---------------------------------------|-------------------|-----------------------|---------------------------------------|-------------------|
| neutrons | 10 | $>10^2$ | 10 | 10 | $>10^3$ | 100 |
| protons | 20 | 1.3×10^3 | 65 | 20 | 1.1×10^3 | 55 |
| He (Z = 2) | 10 | 2.0×10^2 | 20 | 10 | 56 | 5.6 |
| $3 \leq Z \leq 11$ | 10 | 56 | 5.6 | | | |
| $Z \geq 12$ | 10 | 20 | 2 | | | |

Assume: GCR integration time = 6 months (25% duty cycle) (requirement)

SPE integration time = 1 hour (25% duty cycle) (requirement)



NASA Space Radiation Laboratory (NSRL) at Brookhaven

RAD – The Radiation Assessment Detector for MSL



| Species | Charge State in Booster | Kinetic Energy (GeV/A) | Maximum Intensity (10^9 Ions/pulse) |
|-------------------|-------------------------|------------------------|--|
| p | 1 | 0.73 – 3.07 | 100 |
| ^{12}C | 6 | 0.09 – 1.23 | 2 |
| ^{28}Si | 14 | 0.09 – 1.23 | 4 |
| ^{56}Fe | 21 | 0.10 – 1.10 | 0.4 |
| ^{63}Cu | 22 | 0.10 – 1.04 | 1 |
| ^{197}Au | 32 | 0.04 – 0.30 | 2 |

Representative beams available at NSRL, along with energy ranges and maximum intensities.

A RAD Technology Demonstration Model (TDM) has already been tested at the Brookhaven National Laboratory (BNL) Heavy Ion Accelerator Facility.

Results of characterization indicate that MSL/RAD will function as designed/modeled



Photo-Diode Tests



RAD – The Radiation Assessment Detector for MSL

Pulse Height
Histogram over
Nuclear Charge
Number

Gaussian Fits for
Element Peaks

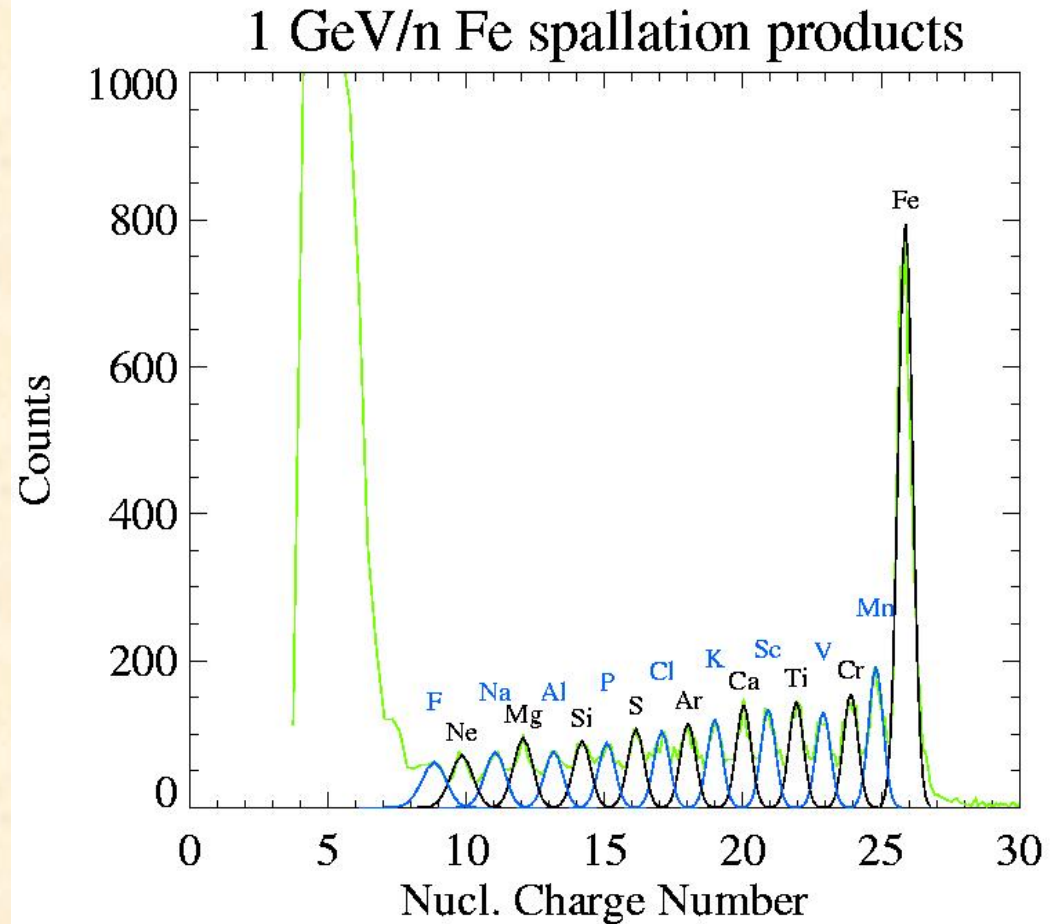



Photo-Diode Results 3: Elemental Resolution



RAD – The Radiation Assessment Detector for MSL

*RAD Photo-Diode Elemental Resolution is
Sufficient for Element Separation up to Fe*

Elemental Resolution for Spallation
Peak Mg (Z=12): $Z/\Delta Z=14$

Elemental Resolution for Primary
Beam Fe (Z=26): $Z/\Delta Z=41.9$

Fe elemental resolution

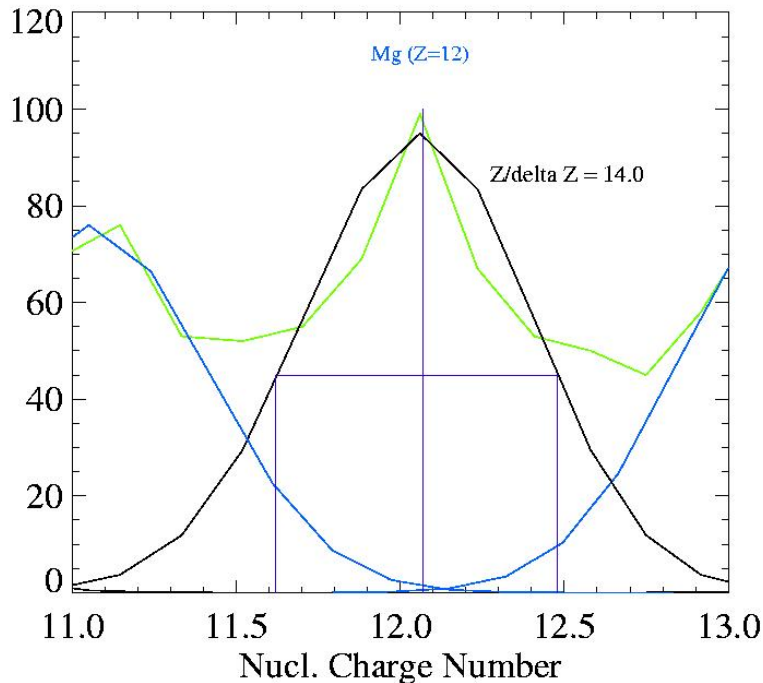

Fe elemental resolution

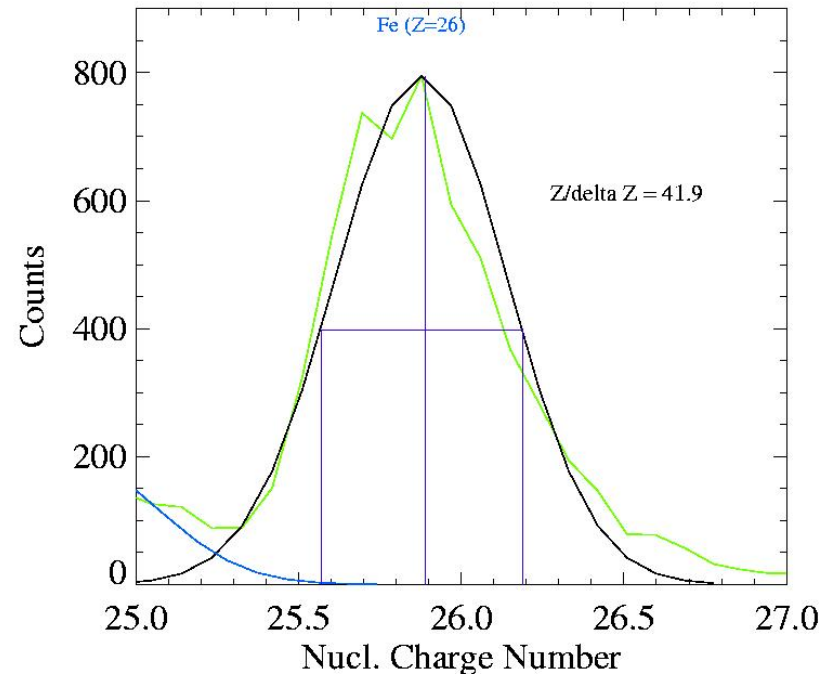

RAD



RAD Hardware Development Plan



RAD – The Radiation Assessment Detector for MSL

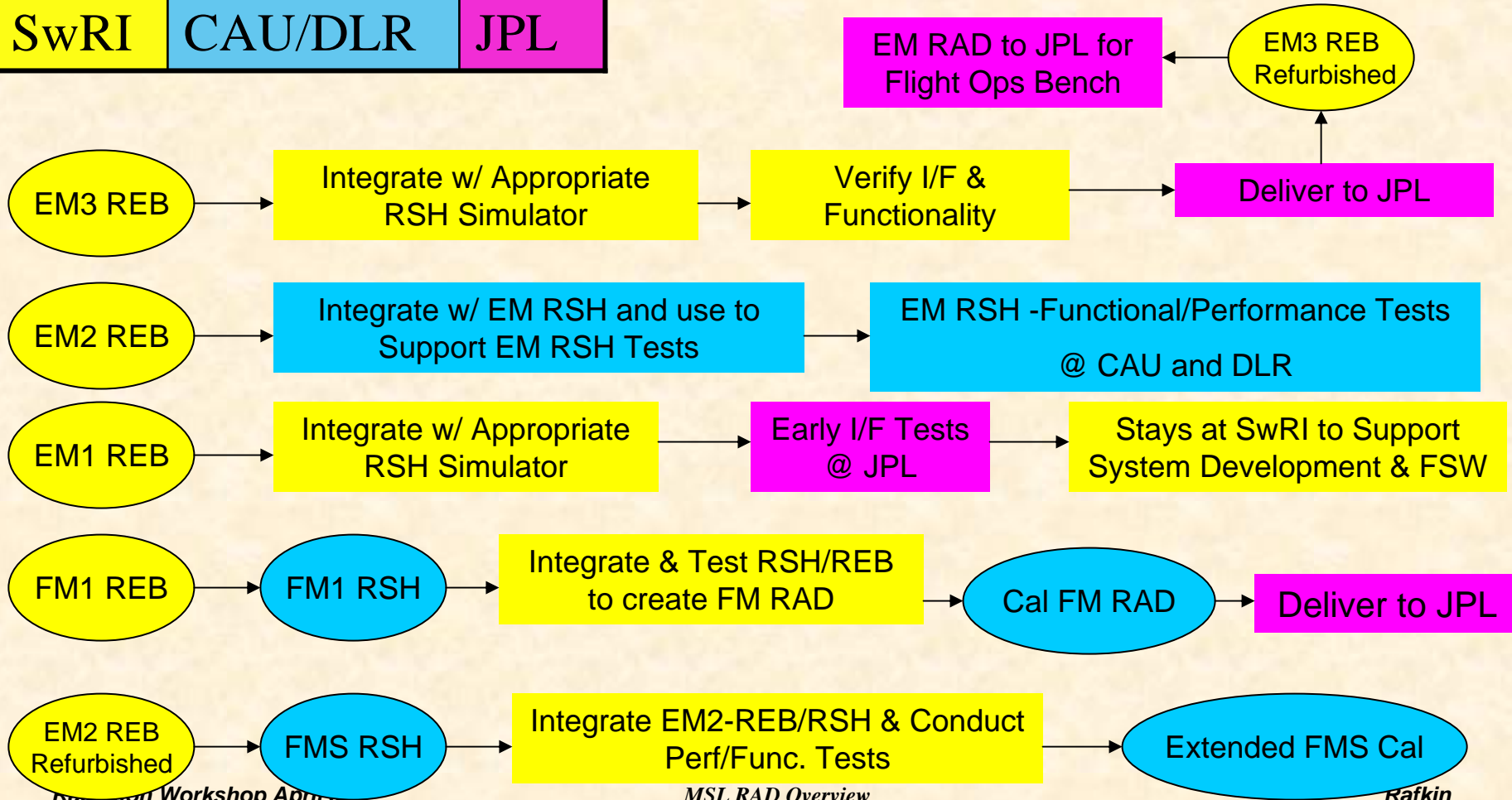



RAD Summary Schedule

(From P3e to MS Project)



RAD – The Radiation Assessment Detector for MSL

| ID | WBS | Task Name | % Complete | Duration | 2006 | | | | 2007 | | | | 2008 | | | | 2009 | | | |
|----|-----|---|------------|------------------|-------------------------------------|----|----|----|------|----|----|----|------|----|----|----|------|----|----|----|
| | | | | | Q4 | Q1 | Q2 | Q3 | Q4 | Q1 | Q2 | Q3 | Q4 | Q1 | Q2 | Q3 | Q4 | Q1 | Q2 | Q3 |
| 1 | 1.0 | Management and Science | 22% | 729 days | [Gantt bar from Q1 2006 to Q4 2008] | | | | | | | | | | | | | | | |
| 2 | | Milestones | 0% | 586 days | [Gantt bar from Q1 2006 to Q4 2008] | | | | | | | | | | | | | | | |
| 3 | | IPDR | 100% | 0 days | [Milestone at Q1 2006] | | | | | | | | | | | | | | | |
| 4 | | ICDR | 0% | 0 days | [Milestone at Q2 2007] | | | | | | | | | | | | | | | |
| 5 | | IPER | 0% | 0 days | [Milestone at Q4 2007] | | | | | | | | | | | | | | | |
| 6 | | EM Funded Schedule Reserve | 0% | 33 days | [Gantt bar from Q3 2007 to Q2 2008] | | | | | | | | | | | | | | | |
| 7 | | FM Funded Schedule Reserve | 0% | 41 days | [Gantt bar from Q4 2007 to Q3 2008] | | | | | | | | | | | | | | | |
| 8 | | Key Deliverables | 0% | 252 days | [Gantt bar from Q3 2007 to Q4 2008] | | | | | | | | | | | | | | | |
| 9 | | EM RAD to JPL | 0% | 0 days | [Milestone at Q3 2007] | | | | | | | | | | | | | | | |
| 10 | | FM RAD to JPL | 0% | 0 days | [Milestone at Q4 2008] | | | | | | | | | | | | | | | |
| 11 | 2.0 | Systems Engineering | 22% | 729 days | [Gantt bar from Q1 2006 to Q4 2008] | | | | | | | | | | | | | | | |
| 12 | 3.0 | RAD Instrument Development | 29% | 587 days | [Gantt bar from Q1 2006 to Q4 2008] | | | | | | | | | | | | | | | |
| 13 | | EM RAD Analog Electronics (RAE) | 55% | 260 days | [Gantt bar from Q1 2006 to Q3 2007] | | | | | | | | | | | | | | | |
| 14 | | FM RAD Analog Electronics (RAE) | 0% | 95 days | [Gantt bar from Q3 2007 to Q2 2008] | | | | | | | | | | | | | | | |
| 15 | | EM RAD Digital Electronics (RDE) | 62% | 257 days | [Gantt bar from Q1 2006 to Q3 2007] | | | | | | | | | | | | | | | |
| 16 | | FM RAD Digital Electronics (RDE) | 0% | 93 days | [Gantt bar from Q3 2007 to Q2 2008] | | | | | | | | | | | | | | | |
| 17 | | RAD Mechanical Package (RMP) | 35% | 462 days | [Gantt bar from Q1 2006 to Q4 2007] | | | | | | | | | | | | | | | |
| 18 | | EM RAD Sleep Electronics (RSE) | 53% | 279 days | [Gantt bar from Q1 2006 to Q3 2007] | | | | | | | | | | | | | | | |
| 19 | | FM RAD Sleep Electronics (RSE) | 0% | 98 days | [Gantt bar from Q3 2007 to Q2 2008] | | | | | | | | | | | | | | | |
| 20 | | RAD Flight Software (FSW) | 30% | 531 days | [Gantt bar from Q1 2006 to Q4 2007] | | | | | | | | | | | | | | | |
| 21 | | GSE & Test Software | 8% | 285 days | [Gantt bar from Q1 2006 to Q3 2007] | | | | | | | | | | | | | | | |
| 22 | | RAD Sensor Head (RSH) | 27% | 587 days | [Gantt bar from Q1 2006 to Q4 2008] | | | | | | | | | | | | | | | |
| 23 | | RAD Rover Window (RRW) Assembly | 9% | 412 days | [Gantt bar from Q1 2006 to Q4 2007] | | | | | | | | | | | | | | | |
| 24 | 3.2 | RAD I&T | 0% | 397 days | [Gantt bar from Q1 2006 to Q4 2008] | | | | | | | | | | | | | | | |
| 25 | | EM#1 I&T | 0% | 77 days | [Gantt bar from Q3 2007 to Q2 2008] | | | | | | | | | | | | | | | |
| 26 | | EM#2 I&T | 0% | 46 days | [Gantt bar from Q3 2007 to Q2 2008] | | | | | | | | | | | | | | | |
| 27 | | EM#3 I&T | 0% | 157 days | [Gantt bar from Q1 2006 to Q4 2007] | | | | | | | | | | | | | | | |
| 28 | | Early I/F Test at JPL | 0% | 5 days | [Milestone at Q3 2007] | | | | | | | | | | | | | | | |
| 29 | | FM REB I&T | 0% | 70 days | [Gantt bar from Q3 2007 to Q2 2008] | | | | | | | | | | | | | | | |
| 30 | | FM I&T | 0% | 87 days | [Gantt bar from Q3 2007 to Q2 2008] | | | | | | | | | | | | | | | |
| 31 | 4.0 | Post-Delivery Support | 0% | 591 days | [Gantt bar from Q1 2006 to Q4 2008] | | | | | | | | | | | | | | | |
| 32 | | EM Post Delivery Support | 0% | 406 days | [Gantt bar from Q1 2006 to Q4 2008] | | | | | | | | | | | | | | | |
| 33 | | FM Post Delivery Support | 0% | 330 days | [Gantt bar from Q1 2006 to Q4 2008] | | | | | | | | | | | | | | | |
| 34 | 5.0 | Education / Public Outreach (E / PO) | 0% | 0 days | [Milestone at Q4 2008] | | | | | | | | | | | | | | | |
| 35 | 6.0 | Mission Operations & Data Analysis (MO&DA) | 15% | 1088 days | [Gantt bar from Q1 2006 to Q4 2009] | | | | | | | | | | | | | | | |
| 36 | | Phase B/C/D Operations | 15% | 1088 days | [Gantt bar from Q1 2006 to Q4 2009] | | | | | | | | | | | | | | | |
| 37 | 7.0 | Science Data Processing (Phase E) | 0% | 0 days | [Milestone at Q4 2009] | | | | | | | | | | | | | | | |



RAD – The Radiation Assessment Detector for MSL



RAD on MSL



Characterizing the Radiation Environment on the Surface of Mars



RAD – The Radiation Assessment Detector for MSL

MSL AO Science Investigation D (Sect. 2.0):

“Characterize the broad-spectrum of the surface radiation environment, including galactic cosmic radiation, solar proton events, and secondary neutrons”.

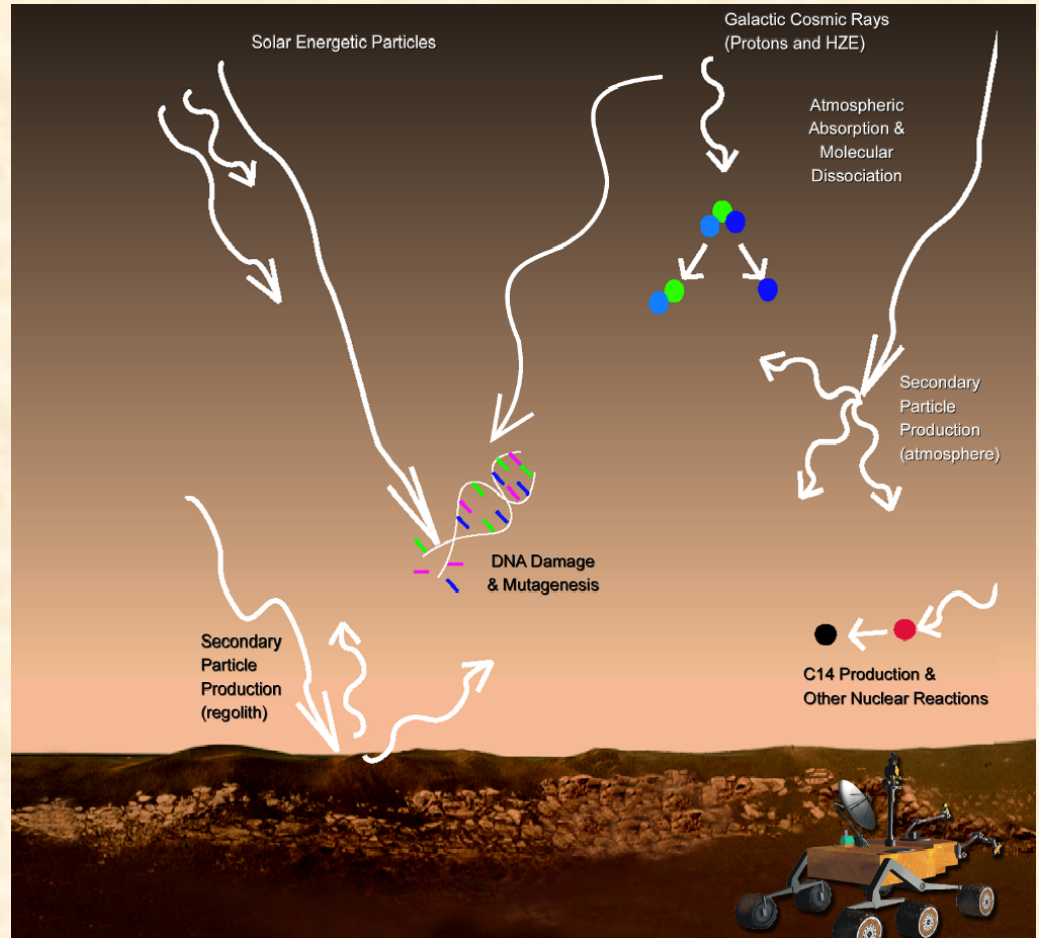



MSL RAD Accommodation / Field of View



RAD – The Radiation Assessment Detector for MSL

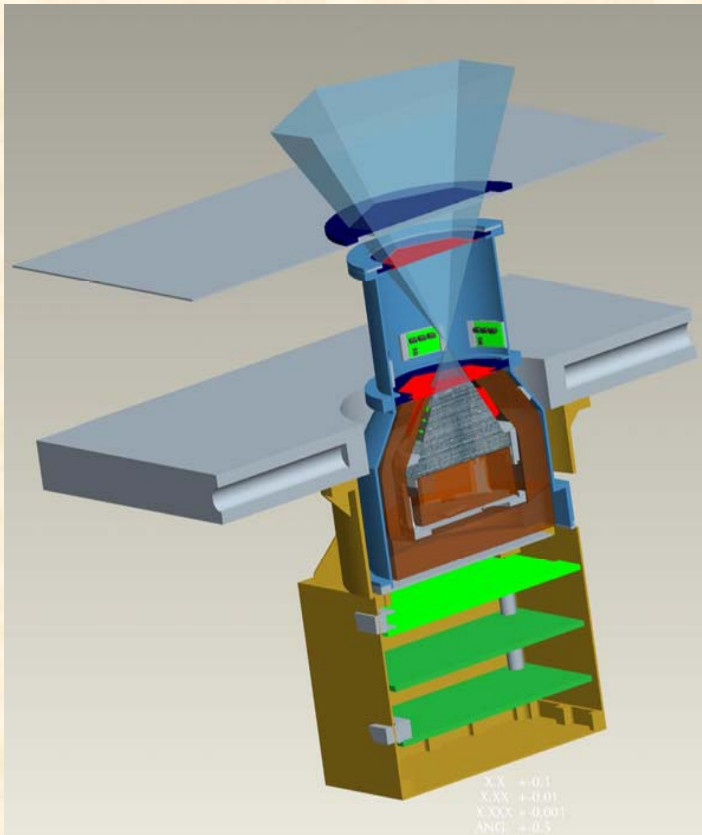

FOV ~ 65 deg. (full angle)
Geometric factor ~ 100 mm² * sr

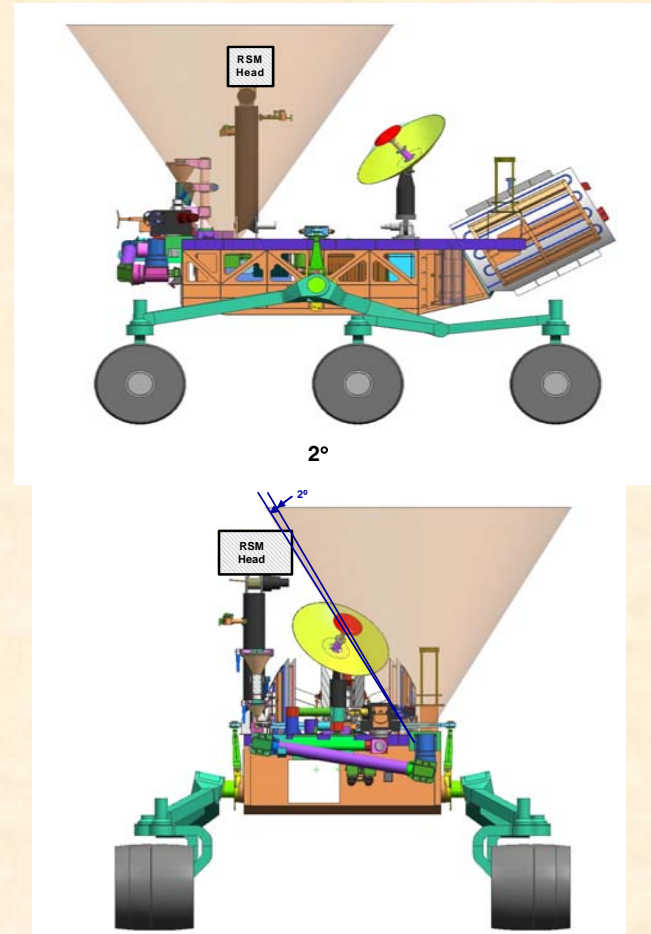



RAD Science Requirements Flowdown Summary

RAD – The Radiation Assessment Detector for MSL



- RAD Level 1 Science Requirements determine RAD Level 2 Measurement Requirements
- RAD Level 2 Measurement Requirements determine RAD Performance Requirements
- Simulations are used to
 - Translate measurement requirements to instrument requirements
 - Track/verify instrument performance



RAD Level 1 Science Objectives



RAD – The Radiation Assessment Detector for MSL

- 1) Characterize the energetic particle spectrum incident at the surface of Mars, including direct and indirect radiation created in the atmosphere and regolith.
- 2) Determine the radiation dose rate and equivalent dose for humans on the Martian surface.
- 3) Determine the radiation hazard and mutagenic influences to life, past and present, at and beneath the Martian surface.
- 4) Determine the chemical and isotopic effects of energetic particle radiation on the Martian surface and atmosphere.



RAD Level 1 Science Objective



RAD – The Radiation Assessment Detector for MSL

Objective 1: Characterize the energetic particle spectrum incident at the surface of Mars, including direct and indirect radiation created in the atmosphere and regolith.

2 Components of Primary Radiation:

- Galactic Cosmic Rays (GCR)
- Solar Energetic Particles (SEP)



Galactic Cosmic Rays



RAD – The Radiation Assessment Detector for MSL

- GCR flux varies with solar cycle and is more enriched in heavy nuclei at solar maximum than predicted by models.
- Physics-based models agree better than semi-empirical models but both can be improved (Mewaldt, 2004).

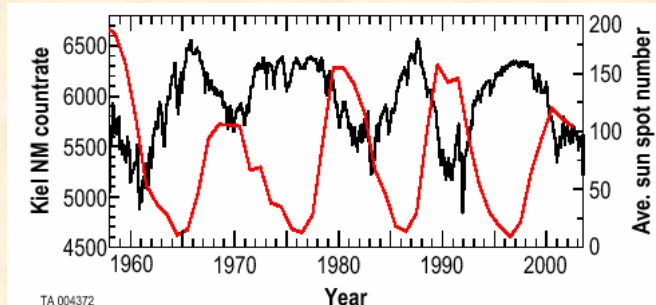
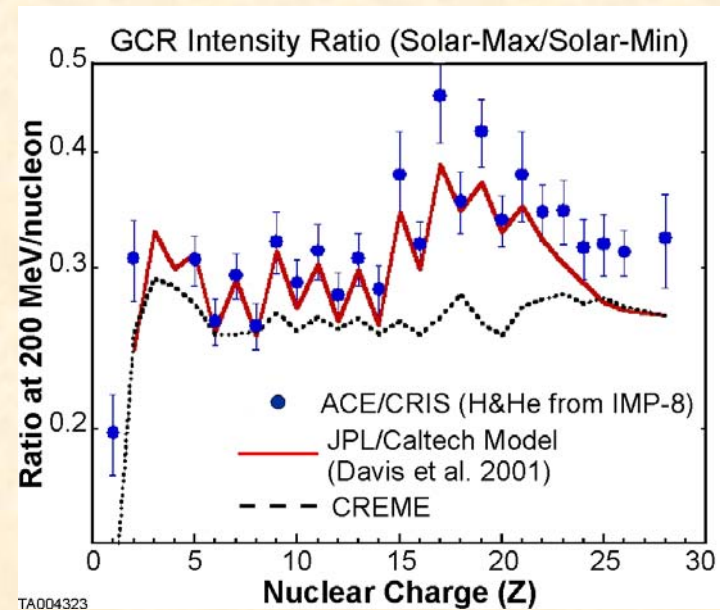

Figure FO1-1. Ground-based neutron monitor observations (black) provide a proxy for GCR flux. (Sunspot number is in red). GCRs are modulated by solar activity with a 15-30% reduction at solar maximum.





Composition Changes in Solar Energetic Particle Events



RAD – The Radiation Assessment Detector for MSL

Solar Energetic Particle Event (SPE) from Oct/Nov 2003. Shown are GOES proton fluxes and ACE/SWEPAM solar wind data superposed on SOHO/EIT images.

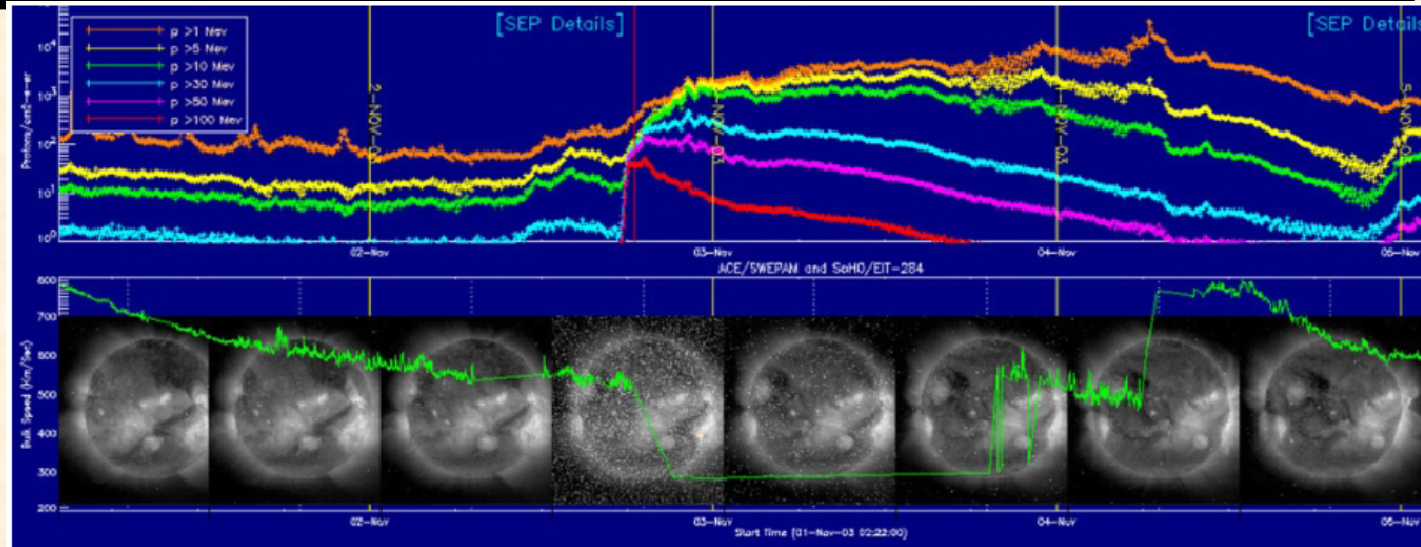

- Energetic particle spectra from SOHO/COSTEP of 3 particle species (electrons, protons, helium) show changes over several days (Posner et al., 2004).
- Quality factors (Q) for each type of radiation are shown on the left.

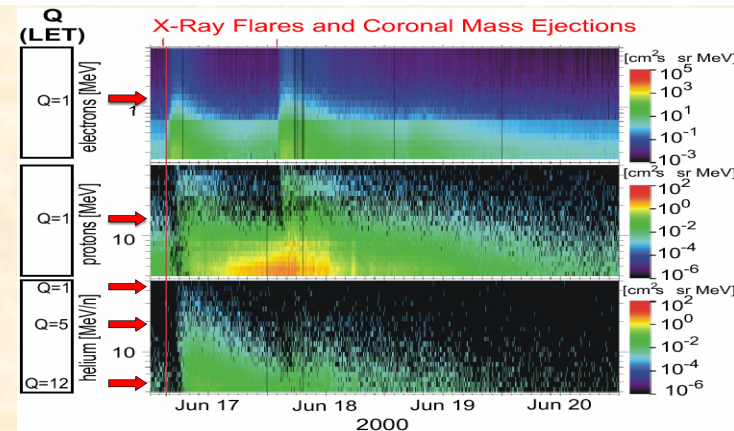



RAD Time Resolution Required is Derived from Need to Characterize/Resolve the Onset of a Solar Particle Event (SPE)

RAD – The Radiation Assessment Detector for MSL

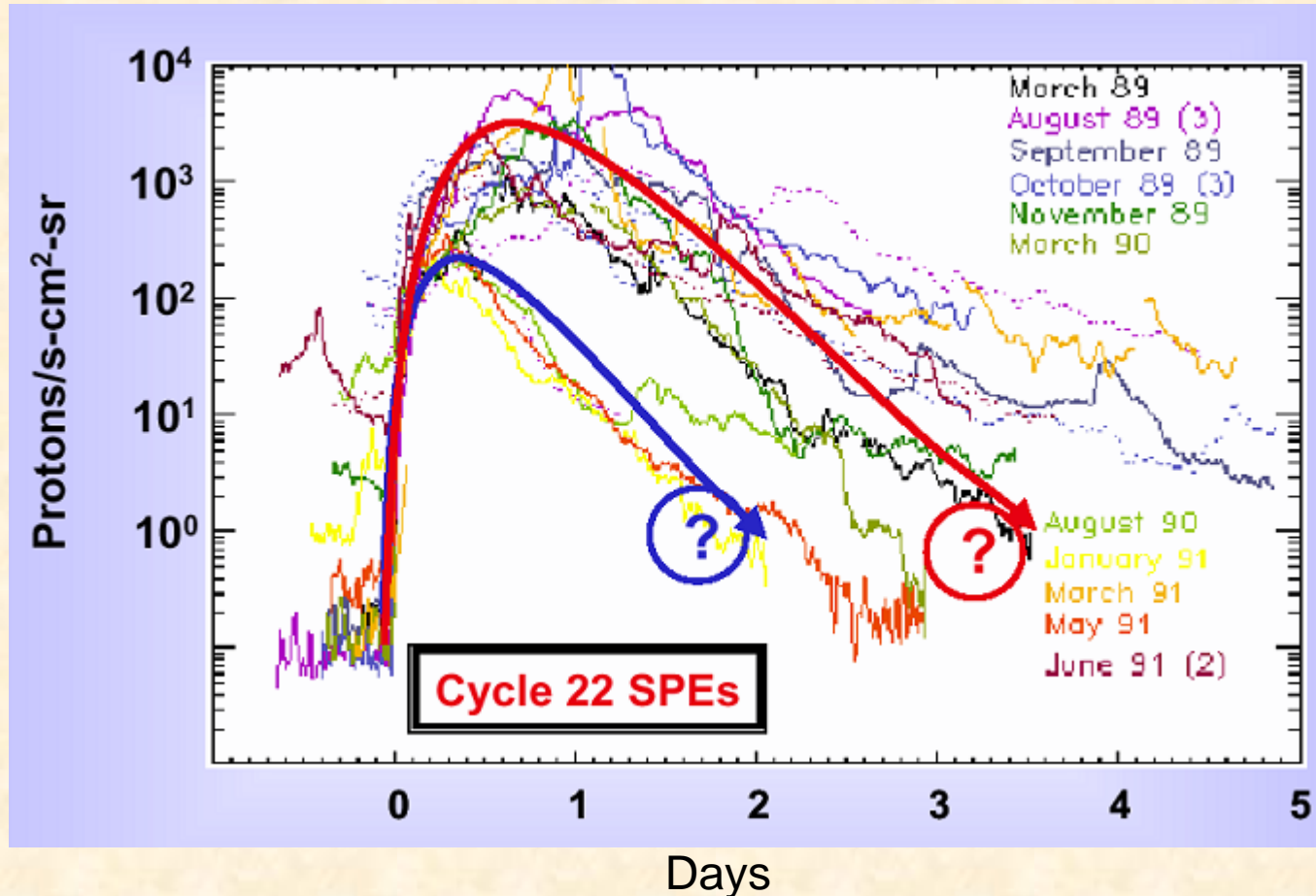



RAD Energy Range Required is Derived from Modeled SEP and GCR Energy Spectra at Mars

RAD – The Radiation Assessment Detector for MSL



**Input
(Space) Spectra**

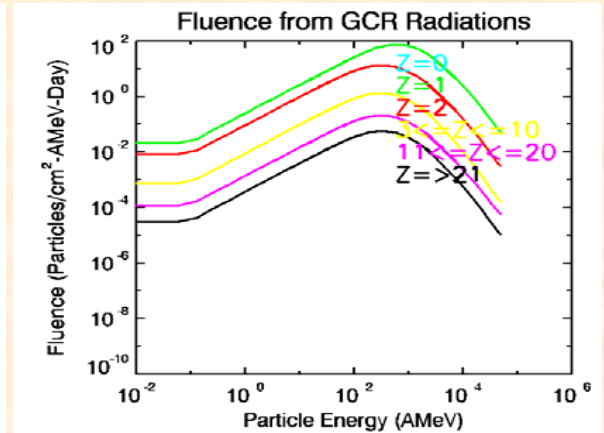
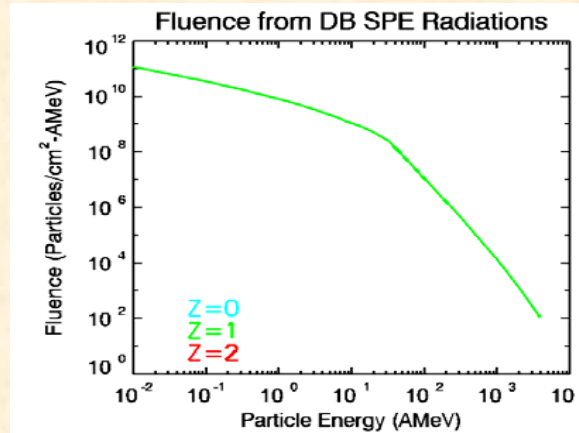

**Output
Surface Fluxes**

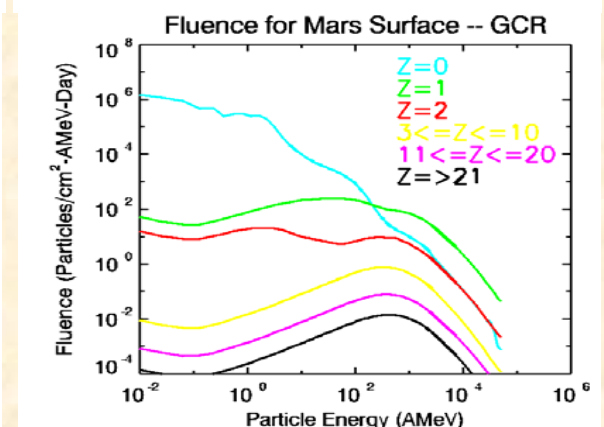
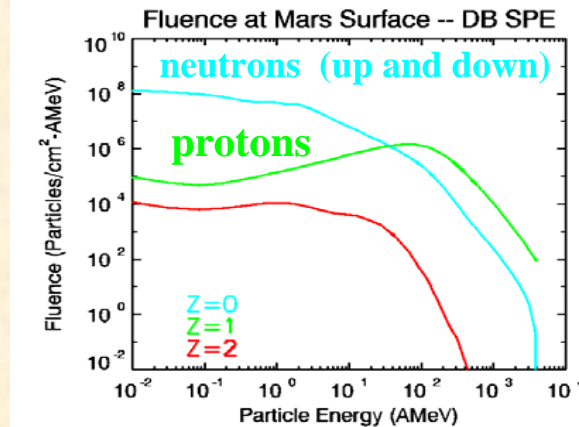

SEP

GCR

*From David Brain et al., VSE Workshop, Wintergreen, VA, 2005 (using SIREST model)



Science Objective 1

Measurement Requirements

RAD – The Radiation Assessment Detector for MSL



| | GCR | SEP |
|--|--|---|
| Particle Species | $0 \leq Z \leq 26$ Electrons | $0 \leq Z \leq 2$ Electrons |
| Energy Range a) ($0 \leq Z \leq 1$) b) ($2 \leq Z \leq 11$) c) ($12 \leq Z \leq 26$) d) electrons | a) 10 – 100 MeV/n b) 20 – 100 MeV/n c) 30 – 200 MeV/n d) 2 – 20 MeV | a) 10 – 100 MeV/n b) 20 – 100 MeV/n d) 2 – 20 MeV |
| Energy Resolution | < 30% | < 30% |
| Time Resolution / Sample Interval | 6 months (sufficient to resolve seasonal changes in Mars atmosphere) | 1 hr (sufficient to resolve onset of SPE and changes in time profile) |



RAD Level 1 Science Objective

RAD – The Radiation Assessment Detector for MSL



Objective 2: Determine the radiation dose rate and equivalent dose for humans on the Martian surface.



Determining the Radiation Dose Rate for Humans on Mars



RAD – The Radiation Assessment Detector for MSL

GCRs produce near-constant background flux of radiation, modulated by the solar cycle.

Composed mostly of H^+ and He^{2+} , but heavy ions contribute disproportionately to the Dose Equivalent due to their high quality factor, Q . (Wilson et al. 1997)

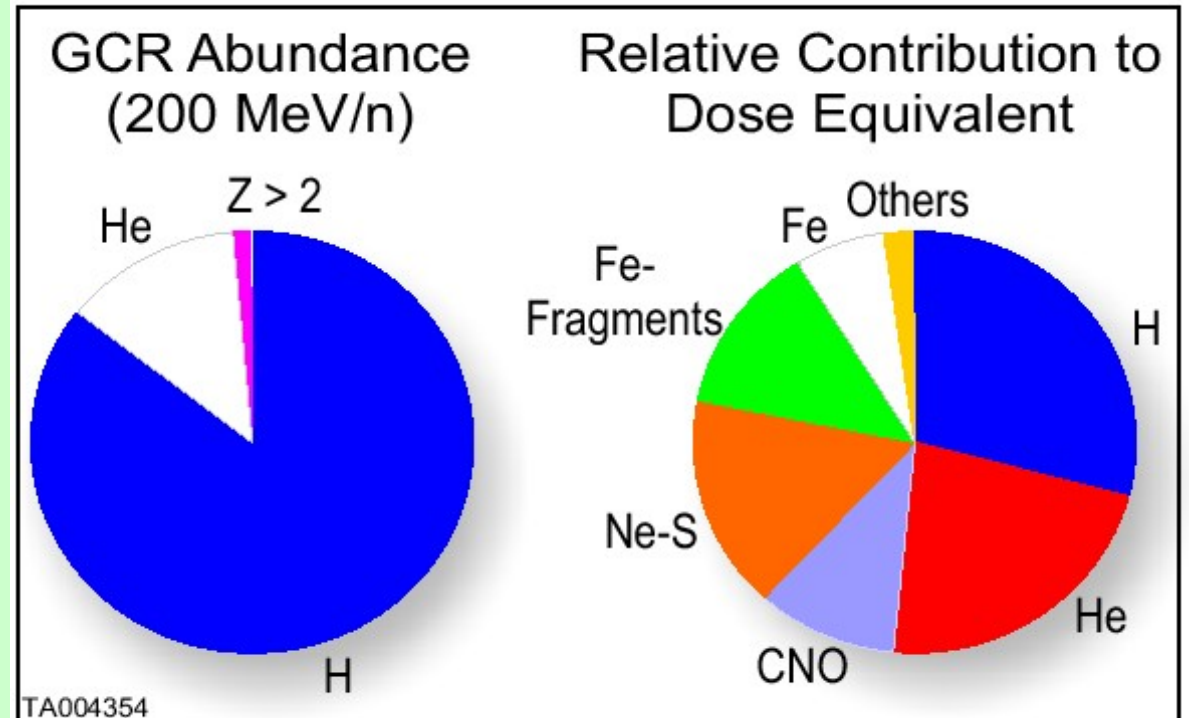



Astronaut Safety Requires Monitoring Certain Particle Species

RAD – The Radiation Assessment Detector for MSL



Table A1-2: Requirements for Complete Characterization of Radiation Environment.

Full characterization requires measuring ALL of these relevant species.

| Particle Species | Quality Factor (Q) | Relevance (Biological Importance and Need for Measurement) |
|------------------|--------------------|--|
| Protons | 1-7 | Largest flux, large contributor to total dose (>90% of GCR, >98% of SEP) |
| He (alphas) | 2-30 | Large flux, high Q at low energies thus large contributor to equivalent dose |
| C, N, O | 5-30 | High Q with large probability of reaction in body tissue, significant contributor to equivalent dose, relevance to carbon provenance, carbon cycle from ¹⁴ C/ ¹² C ratio |
| Fe | 6-30 | High Q factor with largest probability of reaction in body tissue, large contributor to equivalent and effective dose, <i>primary astronaut safety concern</i> |
| Neutrons | 3-10 | High Q factor, relevant near regolith and within tenuous atmospheres, high probability of reaction in tissue at 10-100 MeV, highly penetrating, <i>high astronaut safety concern</i> |
| γ-rays | 1 | Solar flare indicator, relevant to Mars geology: saline γ-line (⁴⁰ K) detection |
| Electrons | 1 | SEP precursor, highly penetrating, large fluence during SEP events (even with Q=1, large fluence contributes to large equivalent dose) |
| Positrons | 1 | GCR cascade by-product, required for radiation transport model validation |



Dosimetry



RAD – The Radiation Assessment Detector for MSL

T. Doke et al. / Radiation Measurements 33 (2001) 373–387

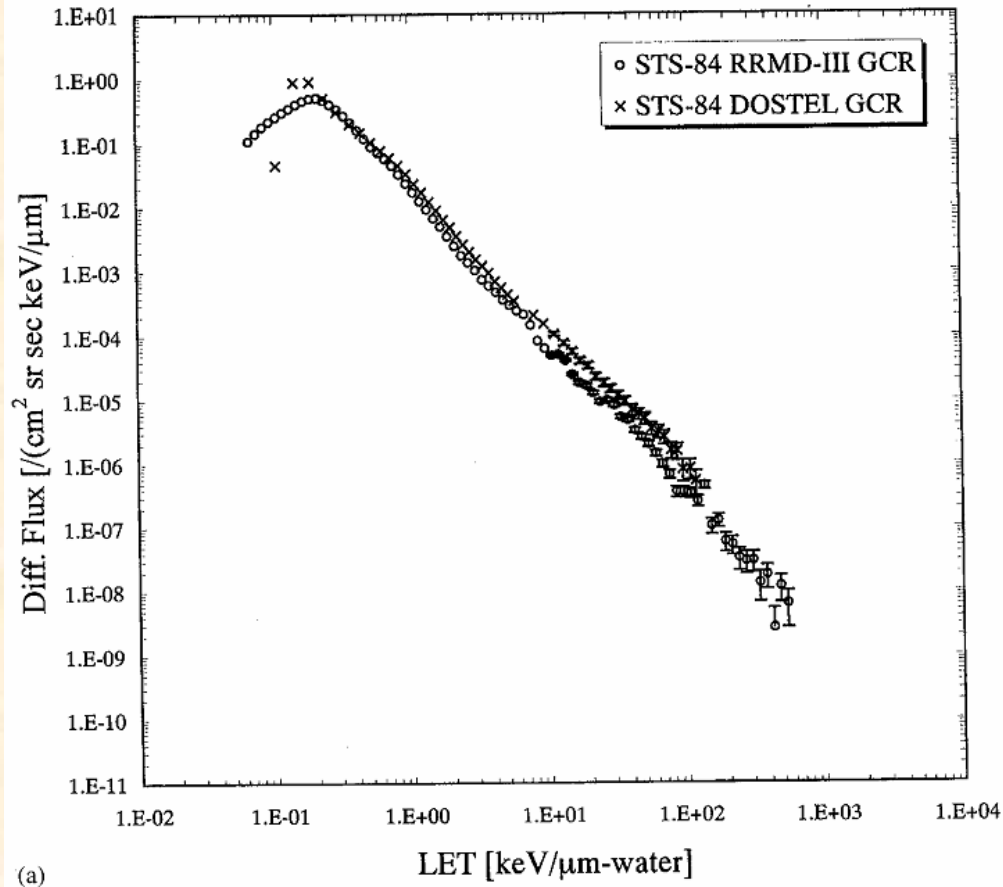

LET distribution for GCR particles observed on board STS-84.

RAD required LET measurement range is derived from need to measure relevant range of GCR particles that contribute to total Dose and Equivalent Dose.



RAD Level 1 Science Objective



RAD – The Radiation Assessment Detector for MSL

Objective 3: Determine the radiation hazard and mutagenic influences to life, past and present, at and beneath the Martian surface.



Radiation and Mutagenic Hazards to Life



RAD – The Radiation Assessment Detector for MSL

- By determining the flux and measuring the variations (diurnal, seasonal, solar cycle), RAD will allow calculations of the depth in rock or soil for which there is a lethal dose of radiation for biological organisms.
- It would then be possible to learn how deep life would have to be to provide sufficient natural shielding.
- These depths can be compared to calculations of diffusion depths of strong oxidizers which destroy organisms near the surface...and then judge whether radiation or oxidizing chemistry will determine the minimum depth needed to drill to look for extant life on Mars.
- Following validation and improvement of current transport codes, these calculations can be made for past higher pressure or warmer climate scenarios.



Science Objective 2 & 3 Measurement Requirements

RAD – The Radiation Assessment Detector for MSL



| | GCR | SEP |
|--|--|-----------------------------------|
| Particle Species | $0 \leq Z \leq 26$ | $0 \leq Z \leq 2$ |
| Energy Range | LET: 0.3 – 1000 keV/ μ m | LET: 0.3 – 1000 keV/ μ m |
| Energy Resolution | < 30% | < 30% |
| Time Resolution / Sample Interval | 6 months (sufficient to resolve seasonal changes in Mars atmosphere) | 1 day (sufficient to resolve SPE) |



RAD Level 1 Science Objective



RAD – The Radiation Assessment Detector for MSL

Objective 4: Determine the chemical and isotopic effects of energetic particle radiation on the Martian surface and atmosphere.

---Not discussed here...but happy to discuss off-line!



RAD Level 2 Measurement Requirements

RAD – The Radiation Assessment Detector for MSL



RAD shall measure:

- ***Req. 1: neutral particles (neutrons and gamma-rays) with energies up to 100 MeV.***
- ***Req. 2: dose and LET spectra in the range of 1 to 1000 KeV/μm.***
- ***Req. 3: energetic particles with an energy resolution sufficient to distinguish between major particle species (i.e. electrons, ions), low Z ions (i.e. p, He, Li), medium Z ions (i.e. C, N, O ions), and high Z ions (i.e. heavier nuclei up to Fe).***
- ***Req. 4: energetic particles with (one hour) observing cadence sufficient to identify the onset of solar particle events (SPEs), and resolve the time profiles associated with such events.***
- ***Req. 5: energetic ions with energies in the range of 10 to 100 MeV/n for p, He; 20 to 100 MeV/n for Li-Na (Z = 3-11); and 30 to 200 MeV/n for Mg-Fe (Z = 12-26).***



RAD Science Data: Classification

RAD – The Radiation Assessment Detector for MSL



Count Rates (L0):

Combinations of trigger signals in detectors determine the pre-defined **nominal science channels**. For each channel, the count rates per accumulation interval are recorded and transmitted to the ground.

Pulse-Height Analyzed (PHA) Data (L0):

For each nominal channel, pulse height words (i.e. energy losses) are recorded. The number of pulse heights per event depends on coincidence depth (1-5). Due to limited telemetry, **not all PHA data can be transmitted** to the ground. PHA therefore requires a **prioritization scheme**.

Histograms (L0/2):

Histograms are a **compressed** form of science data that require **on-board processing**. One of the benefits is spectra for particle species with **good statistics**.



Summary



RAD – The Radiation Assessment Detector for MSL

- RAD will characterize the radiation environment on the surface of Mars for both GCR and large SPEs, measuring all relevant energetic particle species, including secondary neutrons created both in the atmosphere and the regolith.
- RAD is an important element of the Mars Science Laboratory investigation to explore and quantitatively assess a potential habitat for life and the processes that influence habitability.
- RAD meets or exceeds all Science Requirements with substantial margin.
- RAD provides monitoring of:
 - Charge particle fluence $Z=1$ to 26
 - Absorbed dose
 - Dose Equivalent (time-resolved LET)
 - Neutron fluence 1-100 MeV (10-100 MeV with RTG)
- RAD is undergoing build
 - Engineering model in beam by winter of 2007
 - Flight build in 2008
 - Flight in 2009
- RAD is suitable for LEO, Lunar, and interplanetary measurements as is or with little modification, and with advantageous non-recurring cost base.