

# Panasonic

## DVD VIDEO RECORDER

### Operating Instructions

Model No. **DMR-E30**

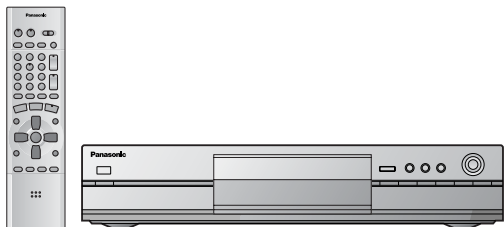

### Dear customer

Thank you for purchasing this product. For optimum performance and safety, please read these instructions carefully.

Before connecting, operating or adjusting this product, please read these instructions completely. Please keep this manual for future reference.

#### Region number supported by this unit

Region numbers are allocated to DVD players and software according to where they are sold.

- The region number of this unit is "1".
- The unit will play DVDs marked with labels containing "1" or "ALL".

Example:



**For U.S.A.**

**The warranty can be found on page 64.**

**For Canada**

**The warranty can be found on page 65.**



This manual was printed with soy based ink.

En las páginas 66 y 67 hay una guía de referencia rápida en español.

**CAUTION!**

THIS PRODUCT UTILIZES A LASER.  
USE OF CONTROLS OR ADJUSTMENTS OR PERFORMANCE OF PROCEDURES OTHER THAN THOSE SPECIFIED HEREIN MAY RESULT IN HAZARDOUS RADIATION EXPOSURE.

DO NOT OPEN COVERS AND DO NOT REPAIR YOURSELF. REFER SERVICING TO QUALIFIED PERSONNEL.

**WARNING:**

TO REDUCE THE RISK OF FIRE, ELECTRIC SHOCK OR PRODUCT DAMAGE, DO NOT EXPOSE THIS APPARATUS TO RAIN, MOISTURE, DRIPPING OR SPLASHING AND THAT NO OBJECTS FILLED WITH LIQUIDS, SUCH AS VASES, SHALL BE PLACED ON THE APPARATUS.



CAUTION: TO REDUCE THE RISK OF ELECTRIC SHOCK, DO NOT REMOVE SCREWS. NO USER-SERVICEABLE PARTS INSIDE. REFER SERVICING TO QUALIFIED SERVICE PERSONNEL.



The lightning flash with arrowhead symbol, within an equilateral triangle, is intended to alert the user to the presence of uninsulated "dangerous voltage" within the product's enclosure that may be of sufficient magnitude to constitute a risk of electric shock to persons.



The exclamation point within an equilateral triangle is intended to alert the user to the presence of important operating and maintenance (servicing) instructions in the literature accompanying the appliance.

**Accessories**

Please check and identify the supplied accessories. Use numbers indicated in parentheses when asking for replacement parts. (Only for U.S.A.)

To order accessories contact 1-800-332-5368 or web site (<http://www.panasonic.com>).

(Only for Canada)

To order accessories, call the dealer from whom you have made your purchase.

1 Remote control (EUR7615KJ0)



2 Batteries for remote control



1 AC power supply cord (RJA0065-A)



1 Audio/Video cable (VJA0788)



1 75 Ω coaxial cable (VJA1013)



1 DVD-RAM disc

**Note**

The included AC power supply cord is for use with this unit only. Do not use it with other equipment.

(U.S.A. only)

Product Registration Card

Please complete and return the included product registration card, or register via the Internet at: <http://www.prodreg.com/panasonic/>

THE FOLLOWING APPLIES ONLY IN THE U.S.A.:

**FCC Note:**

This equipment has been tested and found to comply with the limits for a Class B digital device, pursuant to Part 15 of the FCC Rules. These limits are designed to provide reasonable protection against harmful interference in a residential installation. This equipment generates, uses, and can radiate radio frequency energy and, if not installed and used in accordance with the instructions, may cause harmful interference to radio communications. However, there is no guarantee that interference will not occur in a particular installation. If this equipment does cause harmful interference to radio or television reception, which can be determined by turning the equipment off and on, the user is encouraged to try to correct the interference by one or more of the following measures:

- Reorient or relocate the receiving antenna.
- Increase the separation between the equipment and receiver.
- Connect the equipment into an outlet on a circuit different from that to which the receiver is connected.
- Consult the dealer or an experienced radio/TV technician for help.

FCC Caution: To assure continued compliance, follow the attached installation instructions and use only shielded interface cables when connecting to peripheral devices. Any changes or modifications not expressly approved by the party responsible for compliance could void the user's authority to operate this equipment.

This device complies with Part 15 of the FCC Rules. Operation is subject to the following two conditions: (1) This device may not cause harmful interference, and (2) this device must accept any interference received, including interference that may cause undesired operation.

DANGER	VISIBLE AND INVISIBLE LASER RADIATION WHEN OPEN. AVOID DIRECT EXPOSURE TO BEAM. (FDA 21 CFR)
CAUTION	VISIBLE AND INVISIBLE LASER RADIATION WHEN OPEN. AVOID EXPOSURE TO BEAM. (IEC60825-1)
ATTENTION	RAYONNEMENT LASER VISIBLE ET INVISIBLE EN CAS D'OUVERTURE. EXPOSITION DANGEREUSE AU FAISCEAU.
ADVARSEL	SYNLIG OG USYNLIG LASERSTRÅLING VED ÅBNING. UNDGÅ UDSÆTTELSE FOR STRÅLING.
VARO!	AVATTAESSA OLET ALTUINA NÄKYVÄÄ JA NÄKYMÄTÖN LASERSTRÄLÄLLÄÄ KÄSISÄÄ. VÄÄRÄÄ SUOJAUTUKSIA.
WARNING	SYNLIG OG ØYENLIG LASERSTRÅLING NÅR DENNA DEL ER ÅPNET. UNNGÅ EKSPONERING FOR STRÅLING.
ADVARSEL	SYNLIG OG USYNLIG LASERSTRÅLING NÅR DEKSEL ÅPNEES. UNNGÅ EKSPONERING FOR STRÅLING.
VORSICHT	SICHTBARE UND UNSICHTBARE LASERSTRAHLUNG, WENN ABDECKUNG GEÖFFNET. NICHT DEM STRAHLE AUSSETZEN.
注意	打开时有可能见到不可见激光辐射。避免激光束照射。
注意	この製品は、目に見えないレーザー光を放射する可能性があります。直射光を避けてください。 (R01.50233)

(Inside of product)

**IMPORTANT SAFETY INSTRUCTIONS**

Read these operating instructions carefully before using the unit. Follow the safety instructions on the unit and the applicable safety instructions listed below. Keep these operating instructions handy for future reference.

- 1) Read these instructions.
- 2) Keep these instructions.
- 3) Heed all warnings.
- 4) Follow all instructions.
- 5) Do not use this apparatus near water.
- 6) Clean only with dry cloth.
- 7) Do not block any ventilation openings. Install in accordance with the manufacturer's instructions.
- 8) Do not install near any heat sources such as radiators, heat registers, stoves, or other apparatus (including amplifiers) that produce heat.
- 9) Do not defeat the safety purpose of the polarized or grounding-type plug. A polarized plug has two blades with one wider than the other. A grounding-type plug has two blades and a third grounding prong. The wide blade or the third prong are provided for your safety. If the provided plug does not fit into your outlet, consult an electrician for replacement of the obsolete outlet.
- 10) Protect the power cord from being walked on or pinched particularly at plugs, convenience receptacles, and the point where they exit from the apparatus.
- 11) Only use attachments/accessories specified by the manufacturer.
- 12) Use only with the cart, stand, tripod, bracket, or table specified by the manufacturer, or sold with the apparatus. When a cart is used, use caution when moving the cart/apparatus combination to avoid injury from tip-over.
- 13) Unplug this apparatus during lightning storms or when unused for long periods of time.
- 14) Refer all servicing to qualified service personnel. Servicing is required when the apparatus has been damaged in any way, such as power-supply cord or plug is damaged, liquid has been spilled or objects have fallen into the apparatus, the apparatus has been exposed to rain or moisture, does not operate normally, or has been dropped.



The model number and serial number of this product can be found on either the back or the bottom of the unit.

Please note them in the space provided below and keep for future reference.

MODEL NUMBER \_\_\_\_\_ DMR-E30 \_\_\_\_\_

SERIAL NUMBER \_\_\_\_\_

**CAUTION:**

TO PREVENT ELECTRIC SHOCK MATCH WIDE BLADE OF PLUG TO WIDE SLOT, FULLY INSERT.

**CAUTION!**

DO NOT INSTALL, OR PLACE THIS UNIT, IN A BOOKCASE, BUILT-IN CABINET OR IN ANOTHER CONFINED SPACE. ENSURE THE UNIT IS WELL VENTILATED. TO PREVENT RISK OF ELECTRIC SHOCK OR FIRE HAZARD DUE TO OVERHEATING, ENSURE THAT CURTAINS AND ANY OTHER MATERIALS DO NOT OBSTRUCT THE VENTILATION VENTS.

DO NOT PLACE THIS APPARATUS INTO AN AUDIO RACK, BOOK SHELF OR SIMILAR LOCATION BECAUSE OF HEAT FROM THIS APPARATUS.

DO NOT BLOCK ANY OF THE VENTILATION OPENINGS. INSTALL IN ACCORDANCE WITH THE MANUFACTURER'S INSTRUCTIONS.

Before moving the unit, ensure the disc tray is empty. Failure to do so will risk severely damaging the disc and the unit.

**User memo:**

DATE OF PURCHASE \_\_\_\_\_

DEALER NAME \_\_\_\_\_

DEALER ADDRESS \_\_\_\_\_

TELEPHONE NUMBER \_\_\_\_\_

Do not place the unit on amplifiers or equipment that may become hot.

The heat can damage the unit.



THE FOLLOWING APPLIES ONLY IN THE U.S.A.

**Note to CATV system installer:**

This reminder is provided to call the CATV system installer's attention to Article 820-40 of the NEC that provides guidelines for proper grounding and, in particular, specifies that the cable ground shall be connected to the grounding system of the building, as close to the point of cable entry as practical.

CLASS 1 LASER PRODUCT

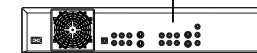

## Features

This unit allows recording of high quality video on DVD-RAM, the compact and durable digital media with fast random access. This media also outdoes past tape formats in ease of operation.

### ■ Watch a program while you are recording it (→page 28) **RAM**

#### Chasing play

You can watch a program from the start while you are still recording it.

#### Simultaneous rec and play

You can record a program while watching one you recorded previously.

#### Time Slip

You can jump back to review a piece of action you missed while recording by pressing the time slip button (can be set between 1 minute and 360 minutes in units of one minute).

### ■ Maximum 12 hours on DVD-RAM

- Using a double sided, 9.4 GB DVD-RAM allows you to record a maximum of 12 hours (6 hours continuously).
- When using a 4.7 GB DVD-RAM or a DVD-R, you can get 1 hour recording using the XP high picture quality mode, 2 hours with the regular SP mode, 4 hours with the long LP mode, and 6 hours with the extra long EP mode.
- You can also use the FR (Flexible Recording) mode to fit recordings efficiently onto the available space on the disc (→page 19).

### ■ The FUNCTIONS window shows you most of the features you can use (→page 41)

The FUNCTIONS window has most of the features and functions you are likely to use regularly. Just select the icon for the operation you want to perform.

### ■ Make your own DVD-Video

- This unit will record onto DVD-R in accordance with DVD video standards and will yield your very own original DVD video upon finalization (→page 8).
- The encoder system used for recording is called "Hybrid VBR" which allows high quality recordings.

### ■ Exceptional sound quality when recording

Audio is recorded using Dolby Digital stereo, enabling high quality sound recordings. When recording in XP mode it is possible to use LPCM (2 channel) to achieve sound recordings of even higher quality.

### ■ Wide ranging compatibility yielding unbeatable versatility

As well as being able to play DVD-Video movie software, this unit can also play other types of discs including audio CDs and video CDs. This means your recorder will be the center of your home entertainment, from high-end home theater through to CD play.

### ■ Progressive Scan

By connecting the component video terminal of this unit to a progressive scan television it is possible to enjoy the high quality picture rendered by the progressive scan function.

### ■ Fast access to the program you want to watch (→page 20)

Use the Direct Navigator to find a program you have recorded and start play.

### ■ Play list (→page 21) **RAM**

Use play lists to select your favorite scenes and rearrange them to play in any order you like. Pick out scenes from a music or sports show and create a collection of your favorite scenes, or take the images you have shot with a video camera and arrange them into a movie of your own creation.

## Explanatory notes

### Symbols used in these operating instructions

#### ■ Troubleshooting



is used to indicate ways to fix potential problems.

#### ■ Discs you can use

The features you can use with the different types of discs are indicated as follows.



#### For your reference

- DVD-R** indicates DVD-R that have not yet been finalized (→page 34) and can still be recorded on.
- DVD-R that have been finalized can use the same features as DVD-Video. (Refer to features indicated **DVD-V**.)

### Operation

These operating instructions describe operations mainly using the remote control. If the name of the button is the same, the operation described can also be performed with the main unit.

### Displays

The displays shown in these instructions are examples only. Actual displays depend on the disc and the operations you are performing.

**Should the AC power supply cord come loose by accident or for any other reason the power supply is cut off while recording or editing is taking place, the contents of the disc may be lost.**

VCR Plus+ and PlusCode are registered trademarks of Gemstar Development Corporation. The VCR Plus+ system is manufactured under license from Gemstar Development Corporation.

Pats. 5,307,173; 5,335,079; 4,908,713; 4,751,578; and 4,706,121

Manufactured under license from Dolby Laboratories. "Dolby", "Pro Logic" and the double-D symbol are trademarks of Dolby Laboratories.

"DTS", "DTS Digital Surround" and "DTS Digital Out" are registered trademarks of Digital Theater Systems, Inc.

## Table of contents

### Getting started

Accessories	2
IMPORTANT SAFETY INSTRUCTIONS	3
Features	4
Explanatory notes	4
Control reference guide	6
Disc information	8
Disc handling	9
STEP 1 The remote control	9
STEP 2 Antenna and television connections	10
STEP 3 Plug-in Auto Tuning	11
STEP 4 VCR Plus+ guide channel settings	13
STEP 5 Selecting TV screen type	14
STEP 6 Television operation	15

### Basic play and recording

Playing discs	16
Inserting discs	17
When a menu screen appears on the television	17
Starting play from where you stopped it	17
—Resume Function	17
Recording television programs	18
One Touch Recording—Specify a time to stop recording	19
Flexible Recording	19
—recording the best quality pictures in a set time	19
Watching the television while recording	19
Notes on recording	19

### Advanced play

Using the Direct Navigator	20
Playing play lists	21
Playing play lists	21
Playing play list scenes	21
To erase a play list or a play list scene during playback	21
Skipping programs and commercials	22
Skipping	22
Skipping a minute forward—CM Skip	22
Selecting an amount of time to skip—Time Slip	22
Other methods of play	23
Fast forward and rewind—SEARCH	23
Slow-motion play	23
Frame-by-frame viewing	23
Starting play from a selected program, title, chapter, or track	23
To erase a program that is being played back	23
To play DVD-R recorded on this unit on other players	23
Random play	24
Program play	24
Marking places to play again—MARKER	25
Marking positions directly	25
Using on-screen menus to mark positions	25
Changing audio	26

### Advanced recording

Playing while you are recording	28
Playing from the beginning of the program you are recording	28
—Chasing play	28
Simultaneous rec and play	28
Reviewing the recorded images while recording	28
—Time Slip	28
Recording from a video cassette recorder	29

### Timer recording

Timer recording	30
Using VCR Plus+ codes to make timer recording	30
Manually programming timer recordings	31

### Editing

Entering text	33
Disc setting	34
Editing programs	36
Editing play lists	38
Creating play lists	40

### Advanced operation

Using the FUNCTIONS window	41
Using on-screen menus	42
Common procedures	42
Disc menu	42
Play menu	43
Audio menu	43
Video menu	44
Home Theater	45
Connecting a cable TV box/satellite receiver	46
Connecting an amplifier or system component	47
Connecting other video equipment	48
Other antenna connections	49
Other antenna connection to the unit	49
Other antenna connection from the unit to the television	49
Changing the remote control code	50
Changing the unit's settings	51
Common procedures	51
Entering a password (Ratings)	51
Digital Audio Output	51
Summary of settings	52
Clock Settings	54
Channel Settings	55

### Reference

On-screen displays	56
Glossary	57
Error messages	58
Maintenance	59
Troubleshooting guide	60
Product Service	62
Specifications	63
Limited Warranty (ONLY FOR U.S.A.)	64
Limited Warranty (ONLY FOR CANADA)	65
Guía de referencia rápida en español	66
(Spanish Quick Reference)	
Index	Back cover

# Control reference guide

## Remote control

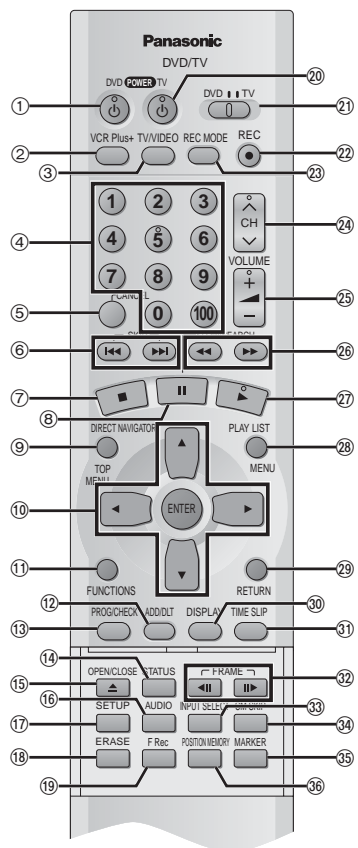

### How to open the remote control

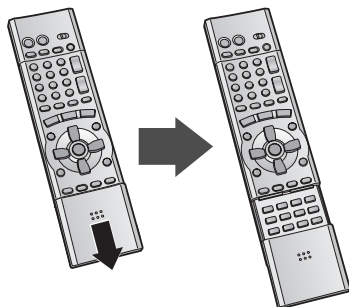

- ① **POWER button (⏻, DVD POWER)** ..... 11  
Press to switch the unit from on to standby mode or vice versa. In standby mode, the unit is still consuming a small amount of power.
- ② **VCR Plus+ button (VCR Plus+)** ..... 30
- ③ **Television input mode selector (TV/VIDEO)** ..... 15
- ④ **Numbered buttons (1-9, 0, 100)** ..... 15
  - When selecting a title, chapter, track, program, or play list  
Example: "5": [0] → [5]  
"15": [1] → [5]
  - When selecting a page of play list scene  
Example: "5": [0] → [0] → [5]  
"15": [0] → [1] → [5]
  - When selecting a television channel  
Example: "5": [0] → [5]  
"15": [1] → [5]  
"115": [100] → [1] → [5]
- ⑤ **Cancel button (CANCEL)** ..... 24
- ⑥ **Skip buttons (⏮, ⏭ SKIP)** ..... 22
- ⑦ **Stop button (■)** ..... 17
- ⑧ **Pause button (⏸)** ..... 17
- ⑨ **Top menu and Direct Navigator button (TOP MENU, DIRECT NAVIGATOR)** ..... 17, 20
- ⑩ **Cursor buttons (▲, ▼, ◀, ▶) / Enter button (ENTER)** ..... 12
- ⑪ **Functions button (FUNCTIONS)** ..... 41
- ⑫ **Manual channel adding and deleting button (ADD/DLT)** ..... 12
- ⑬ **Manual programming and check button (PROG/CHECK)** ..... 31
- ⑭ **On-screen display button (STATUS)** ..... 56
- ⑮ **Disc tray open/close button (▲ OPEN/CLOSE)** ..... 17
- ⑯ **Audio button (AUDIO)** ..... 26
- ⑰ **Setup button (SETUP)** ..... 12
- ⑱ **Program/play list erase button (ERASE)** ..... 21, 23
- ⑲ **Flexible Recording button (F Rec)** ..... 19
- ⑳ **TV power on/off button (⏻, POWER TV)** ..... 15
- ㉑ **DVD/TV switch (DVD, TV)** ..... 15
  - When selecting the receiving channel on this unit using channel button (㉒) and numbered buttons (④), make sure you switch [DVD, TV] to "DVD".
  - When selecting the receiving channel for the television using channel button (㉒) and numbered buttons (④), make sure you switch [DVD, TV] to "TV".
- ㉒ **Recording button (●, REC)** ..... 19
- ㉓ **Recording mode button (REC MODE)** ..... 19
- ㉔ **Channel buttons for recorder and TV (▲, ▼, CH)** ..... 15, 19
- ㉕ **TV volume buttons (+, -, VOLUME)** ..... 15
- ㉖ **Slow/search buttons (◀◀, ▶▶ SLOW/SEARCH)** ..... 23
- ㉗ **Play button (▶)** ..... 17
- ㉘ **Menu and Play List button (MENU, PLAY LIST)** ..... 17, 21
- ㉙ **Return button (RETURN)** ..... 12
- ㉚ **Display button (DISPLAY)** ..... 42
- ㉛ **Time slip button (TIME SLIP)** ..... 22
- ㉜ **Frame advance and frame reverse buttons (◀◀, ▶▶ FRAME)** ..... 23
- ㉝ **Input select button (INPUT SELECT)** ..... 29
- ㉞ **One-minute skip button (CM SKIP)** ..... 22
- ㉟ **Marker button (MARKER)** ..... 25
- ㊱ **Position memory button (POSITION MEMORY)** ..... 17

## Main unit

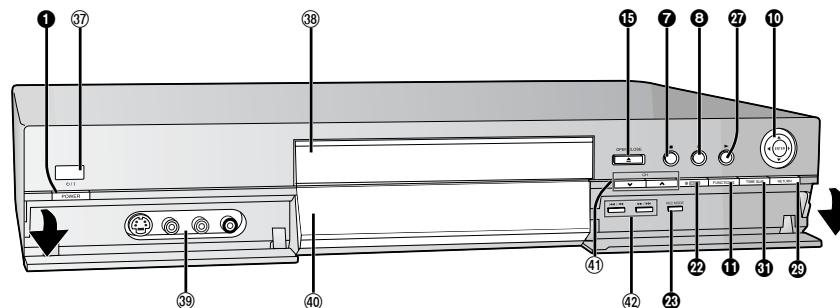

Controls such as ❶ function the same as the buttons on the remote control.

- ❶ **Remote control signal sensor** ..... 9
- ❷ **Disc tray** ..... 17
- ❸ **L2 input terminals (L2)** ..... 48
- ❹ **Display** ..... 9
- ❺ **Channel buttons for recorder (▲, ▼, CH)** ..... 19
- ❻ **Skip/Slow/Search buttons (◀◀, ▶▶)** ..... 22, 23

## The unit's display

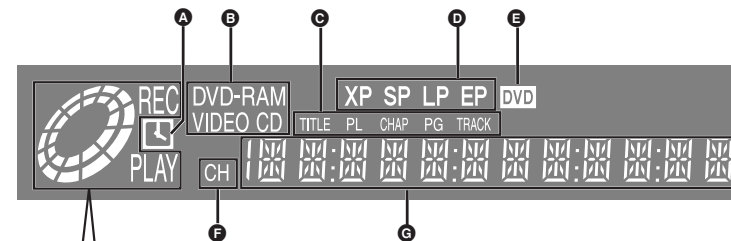

**Center circle (e.g.: DVD-RAM)**  
Rotating (REC, PLAY): recording  
Stopped (REC): recording paused

**Rotating (REC, PLAY):**  
Chasing play or simultaneous  
rec and play is in progress

**Rotating (PLAY): playing**  
**Stopped (PLAY): play paused**  
"PLAY" flashes:  
the resume function  
(→page 17) is working





- ❶ **Timer recording display**  
On: When timer recording is on standby (→page 30)  
Flashes: When the unit couldn't go to timer recording standby (e.g., a disc isn't loaded or a disc that can't be recorded to is loaded)
- ❷ **Disc type**
- ❸ **The display mode of the main display section**  
TITLE: Title number  
TRACK: Track number  
CHAP: Chapter number  
PG: Program number  
PL: Play list number

- ❹ **Recording mode (→page 19)**
- ❺ **DVD indicator**  
Flashes: When you press [⏻, DVD POWER] to turn the unit off until it actually turns off
- ❻ **Channel**
- ❼ **Main display section**  
Recording and play counter, and other miscellaneous messages

## Disc information

### Discs you can use for recording and play

	
<b>DVD-RAM</b> 4.7 GB/9.4 GB, 12 cm (5") 2.8 GB, 8 cm (3")	<b>DVD-R</b> 4.7 GB for General Ver. 2.0

- This unit is not compatible with:
  - 12-cm (5"), 2.6- and 5.2-GB DVD-RAM
  - 3.95- and 4.7-GB DVD-R for Authoring
  - DVD-RAM not recorded following the Video Recording Standard
  - Unfinalized DVD-R recorded on other equipment
- This unit is compatible with the **Content Protection for Recordable Media (CPRM)** system so you can record broadcasts that allow one copy, such as some CATV broadcasts, onto 4.7 GB/9.4 GB DVD-RAM (these are CPRM compatible). It is not possible to record onto DVD-R.
- We recommend using Panasonic discs as they have been confirmed to be compatible with this unit. Other discs may not perform correctly.
- Do not allow the disc to become dirty or scratched. Fingerprints, dirt, dust, scratches or deposits of cigarette smoke on the recording surface may make it impossible to use the disc for recording.

#### DVD-RAM

- **DVD-RAM recorded on this unit may not be compatible with other DVD players, including some Panasonic players. Consult the manual for the player to determine compatibility with these DVD-RAM discs.**
- This unit is compatible with both non-cartridge and cartridge DVD-RAM, but the write-protect tabs on cartridge-type discs give better protection to your recordings (→page 19).
- Picture aspect ratios, regular 4:3 or widescreen 16:9, are recorded as they are received.
- Discs with programs recorded in PAL already cannot be recorded on using this unit.

#### DVD-R

- **In order to play a DVD-R recorded using this machine on another playback source, the disc must first be finalized (→page 34).**
- Once a DVD-R is finalized, it becomes DVD-Video.
- You can record onto the available space on the disc and perform editing functions, such as giving titles to discs and programs and erasing programs before finalizing.
- You cannot record over parts that have been recorded.
- It takes about 30 seconds for the unit to complete recording management information after recording finishes.
- This unit optimizes the DVD-R for each recording. Optimizing is carried out when you start recording after inserting the disc or turning on the unit. Recording onto the disc may become impossible if optimizing is carried out too many times.
- Play may be impossible in some cases due to the condition of the recording.
- The video is recorded in a 4:3 aspect irrespective of the video signal input.
- Discs with programs recorded in PAL already cannot be recorded on using this unit.



### Play-only discs

		
DVD-Video	Audio CD	Video CD

- The producer of the material can control how DVD-Video and Video CDs are played. This means that you may not be able to control play of a disc with some operations described in these operating instructions. Read the disc's instructions carefully.
- This unit can play CD-DA (digital audio) and Video CD format (Video CD Format 2.0 or above), audio CD-R and CD-RW that have been finalized upon completion of recording. It may not be able to play some CD-R or CD-RW due to the condition of the recording.
- This unit cannot record onto CD-R or CD-RW.

#### DVD-Video

#### Audio format

	<b>Dolby Digital (→page 57)</b> This unit can play Dolby Digital in stereo (2 channels). Connect an amplifier with a built-in Dolby Digital decoder to enjoy surround sound.
	<b>DTS Digital Surround (→page 57)</b> Connect this unit to equipment that has a DTS decoder to enjoy DVDs with this mark.

### Discs that cannot be played

- DVD-Video with a region number other than "1" or "ALL"
- Some DVD-RAM (→left)
- Some DVD-R (→left)
- PAL discs
- DVD-ROM
- DVD-RW
- DVD-Audio
- +RW
- CD-ROM
- CDV
- CD-G
- Photo CD
- CVD
- SVCD
- SACD
- MV-Disc
- PD
- Divx Video Disc, etc.

**The manufacturer accepts no responsibility and offers no compensation for loss of recorded or edited material due to a problem with the unit or disc, and accepts no responsibility and offers no compensation for any subsequent damage caused by such loss.**

#### Examples of causes of such losses are

- A disc recorded and edited with this unit is played in a DVD recorder or computer disc drive manufactured by another company.
- A disc used as described above and then played again in this unit.
- A disc recorded and edited with a DVD recorder or computer disc drive manufactured by another company is played in this unit.

## Disc handling

Do not use irregularly shaped discs, such as heart-shaped. (These can damage the unit.)



### How to hold a disc

Do not touch the recorded surface.

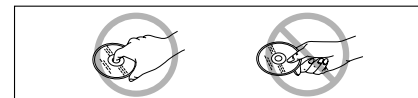

### If there is dirt or condensation on the disc

Moisture may condense on discs after they are brought inside from the cold.

#### DVD-RAM and DVD-R

Clean only with the DVD-RAM/PD disc cleaner available as an optional accessory, part number LF-K200DCA1. Do not use cleaners or cloths for CDs to clean DVD-RAM and DVD-R.

#### DVD-Video, CD, Video CD

Wipe with a damp cloth and then wipe dry.

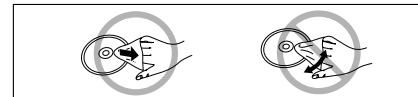

### Handling precautions

- Do not write on the label side with a ball-point pen or other writing instrument.
- Do not use record cleaning sprays, benzene, thinner, static electricity prevention liquids or any other solvent.
- Do not attach labels or stickers to discs. (Do not use discs with exposed adhesive from tape or left over peeled-off stickers.)
- Do not use scratch-proof protectors or covers.
- Do not use discs printed with label printers available on the market.
- Do not use discs that are badly warped or cracked.

### Do not place or store discs in the following places

- Locations exposed to direct sunlight
- Humid or dusty locations
- Locations directly exposed to a heat vent or heating appliance

## STEP 1 The remote control

### Batteries

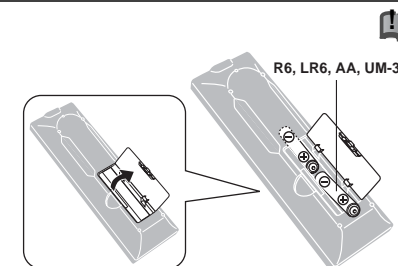

- Insert so the poles (+ and -) match those in the remote control.
- Do not use rechargeable type batteries.

#### Do not:

- mix old and new batteries.
  - use different types at the same time.
  - heat or expose to flame.
  - take apart or short circuit.
  - attempt to recharge alkaline or manganese batteries.
  - use batteries if the covering has been peeled off.
- Mishandling of batteries can cause electrolyte leakage which can damage items the fluid contacts and may cause a fire.

Remove if the remote control is not going to be used for a long period of time. Store in a cool, dark place.

#### Note

If you cannot operate the unit or television using the remote control after changing the batteries, please re-enter the codes (television→page 15, main unit→page 50).

### Use

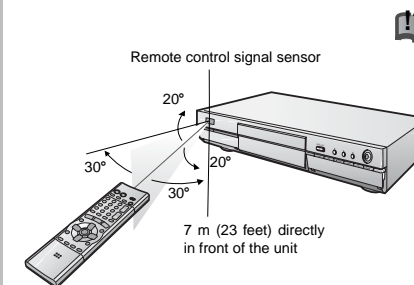

Aim at the sensor, avoiding obstacles, at a maximum range of 7 m (23 feet) directly in front of the unit.

## STEP 2 Antenna and television connections

### Preparation

- Refer to the television's operating instructions.
- Turn the television off and disconnect its AC power supply cord.

### To enjoy sound through other audio equipment

You can output digital signals from this unit's DIGITAL AUDIO OUT terminal, enabling you to enjoy the powerful surround effects found on discs recorded with Dolby Digital or DTS. Connect an amplifier with built-in decoders. See page 47 for connection examples.

### To enjoy CATV (→page 46)

(You need to subscribe to a cable TV or satellite TV service, to enjoy viewing their programming.)

### To enjoy progressive video

- Connect to the component video (480p) input terminals on a television compatible with this unit's copy guard system. (Video will not be displayed correctly if connected to an incompatible television.)
- Set "TV Type" to "480P" in STEP 5 Selecting TV screen type (→page 14).
- When playing back, select Video in the on-screen menu and set "Transfer" according to the type of material being played (→page 44).

### For your reference

All televisions manufactured by Panasonic and that have 480p input connectors are compatible. Consult the manufacturer if you have another brand of television.

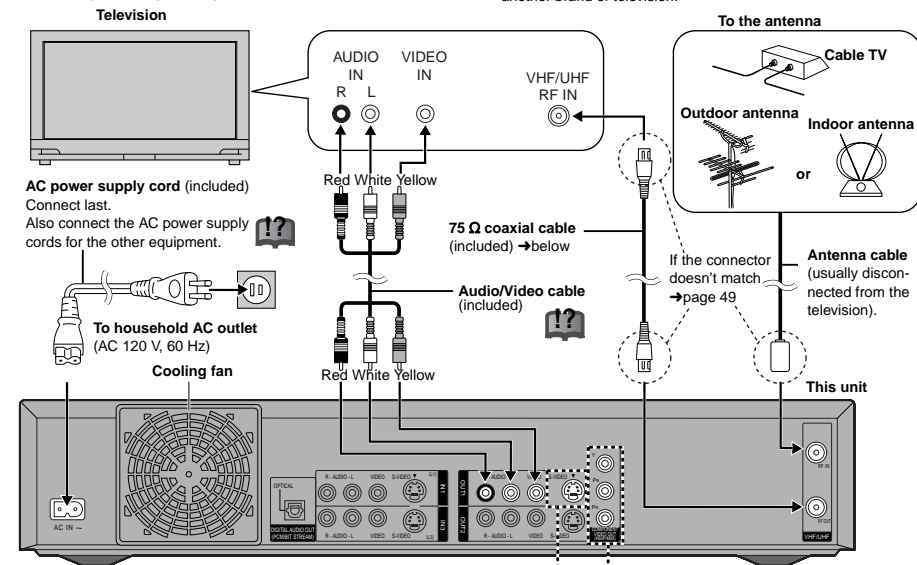

### S VIDEO OUT terminal

The S-video terminal achieves a more vivid picture than the VIDEO OUT terminal by separating the chrominance (C) and luminance (Y) signals. (Actual results depend on the television.)

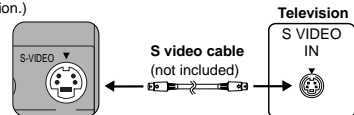

When making this connection, ensure you connect the audio cables to the corresponding audio input terminals on the television.

### 75 Ω coaxial cable

- The signal from the antenna passes through this unit and along the 75 Ω coaxial cable to the television even when this unit is turned off. You don't have to connect the antenna to the television.
- The picture and sound signal from this unit does not go through the 75 Ω coaxial cable to the television. Make sure you connect one of the following terminals on this unit to the television: the AUDIO/VIDEO terminal, the S-VIDEO OUT terminal or the COMPONENT VIDEO OUT terminal. If the television has none of these terminals, consult your local dealer.

### Conserving power

This unit consumes a small amount of power, even when it is turned off (approx. 3 W). To save power when the unit is not to be used for a long time, unplug it from the household AC outlet.

### COMPONENT VIDEO OUT terminal

These terminals can be used for either interlace or progressive output and provide a purer picture than the S VIDEO OUT terminal.

Connection using these terminals outputs the color difference signals (P/P<sub>r</sub>) and luminance signal (Y) separately in order to achieve high fidelity in reproducing colors.

- The description of the component video input terminals depends on the television or monitor (e.g. Y/P<sub>b</sub>/P<sub>r</sub>, Y/B-Y/R-Y, Y/C<sub>b</sub>/C<sub>r</sub>). Connect to terminals of the same color.

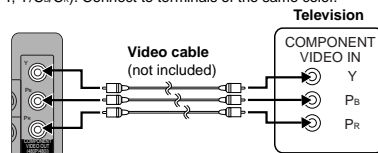

When making this connection, ensure you connect the audio cables to the corresponding audio input terminals on the television.

### Do not connect the unit through a video cassette recorder

Video signals fed through video cassette recorders will be affected by copyright protection systems and the picture will not be shown correctly on the television.

## STEP 3 Plug-in Auto Tuning

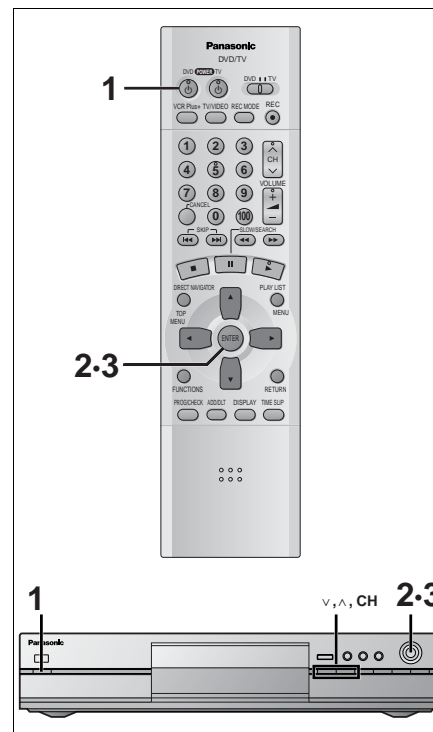

After plugging the unit into your household AC outlet and pressing [DVD, DVD POWER] to turn the unit on for the first time, the unit automatically tunes in all the channels it can receive and sets the clock.

The unit automatically determines the type of transmission (air or cable) and puts them into channels as follows.

### •TV Mode

Band	Air
VHF	2-13
UHF	14-69

### •CATV Mode

Band	Cable
VHF	2-13
CATV LOW BAND	95-99
CATV MID/SUPER BAND	14-36
CATV HYPER BAND	37-65
ULTRA BAND	66-94 100-125
SPECIAL CATV CHANNEL	1

### Preparation

- Confirm that the antenna is connected correctly.
- Turn on the television and select the appropriate video input to suit the connections to this unit.

### 1 Press [DVD, DVD POWER] to turn the unit on.

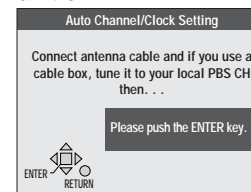

### 2 Press [ENTER].

Plug-in Auto Tuning starts and the unit puts the stations it can receive into channels.

The unit then proceeds with Auto Clock Setting. The time is displayed when finished. If the clock is an hour slower or faster than the actual time, go to "Time Zone Adjust" to correct it (→page 54).

### 3 When the display shows the correct time Press [ENTER] to complete Plug-in Auto Tuning.

### If the unit couldn't find any channels

Press [ENTER] to start Plug-in Auto Tuning again. If the channels still aren't tuned, set "Antenna System" manually and proceed to "Auto Channel Setting" (→page 12, "If Plug-in Auto Tuning fails").

### If unnecessary channels are set or necessary channels are not set

Refer to page 12, "Adding and deleting channels".

### If the unit couldn't set the clock automatically

Press [ENTER] to show the "Manual Clock Setting" screen. Set the time manually (→page 54).

### To start Plug-in Auto Tuning again (after relocation, for example)

Antenna system, channel caption, and VCR Plus+ guide channel settings all revert to the default values when you perform the procedure below. Timer recording settings are also cleared.

When the unit is on and stopped

- Press and hold [V, CH] and [^, CH] on the main unit for about five seconds. The unit turns off.
- Press [DVD, DVD POWER] to turn the unit on. Press [ENTER] to start Plug-in Auto Tuning.

### STEP 3 Plug-in Auto Tuning

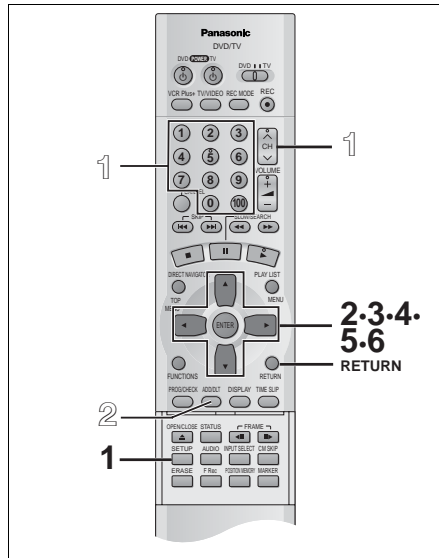

#### If Plug-in Auto Tuning fails

- 1 Press [SETUP] to show the menus.

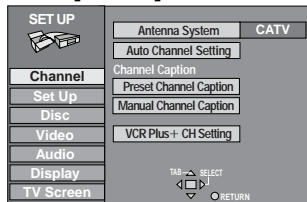

- 2 Press [▲, ▼] to select "Channel" and press [▶].

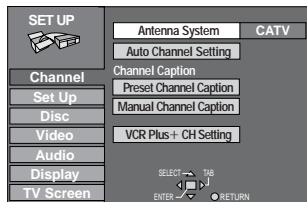

- 3 Press [▲, ▼] to select "Antenna System" and press [ENTER].

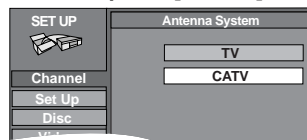

- 4 Press [▲, ▼] to select "TV" or "CATV" and press [ENTER].

TV: TV broadcast (2CH-69CH)  
CATV: CATV broadcast (1CH-125CH)  
The screen shown in step 2 reappears.

- 5 Press [▲, ▼] to select "Auto Channel Setting" and press [ENTER].

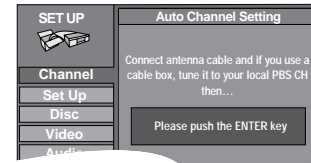

If you have not yet set clock, the "Auto Channel/Clock Setting" screen appears.

- 6 Press [ENTER].

Auto setting starts. This takes a few minutes. (To stop auto channel setting, press [RETURN].) When finished, the Complete screen or time display is shown. Press [ENTER].

#### To return to the previous screen

Press [RETURN].

#### When you are finished

Press [SETUP].

#### Adding and deleting channels

While this unit is receiving the antenna signal (but not during recording):

- 1 Press the numbered buttons to select a channel.

Example: "5": [0] → [5] Unit's display  
"15": [1] → [5]  
"115": [100] → [1] → [5]



• You can also use [▲, ▼, CH] when you are going to delete a channel.

- 2 Press [ADD/DLT].

The channel is **deleted** if it was set or **added** if it was not set.  
For example



Repeat steps 1 and 2 as necessary.

### STEP 4 VCR Plus+ guide channel settings

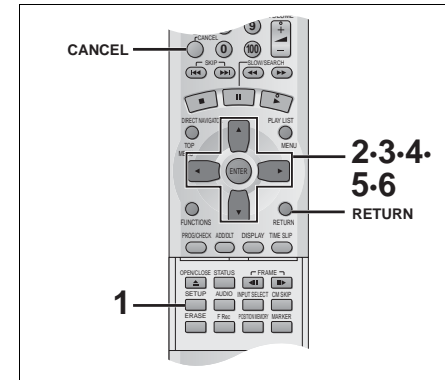

Set these guide channels so you can use VCR Plus+ codes for timer recording. Before starting the settings, prepare a chart showing the channels, station names, and guide channels.

For example:

Station name	Guide channel	Channel number	
CBS	04	04	→ A
HBO	33	15	→ B
Nickelodeon	38	20	→ C

Look up the guide channels for the stations in magazines. Write down all the stations you can receive.

- Ⓐ The guide channel and channel numbers correspond so you do not have to change the setting.
- Ⓑ In step 5, enter channel 15 next to Guide Channel 33.
- Ⓒ In step 5, enter channel 20 next to Guide Channel 38.

- 1 Press [SETUP] to show the menus.

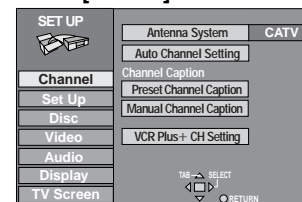

- 2 Press [▲, ▼] to select "Channel" and press [▶].

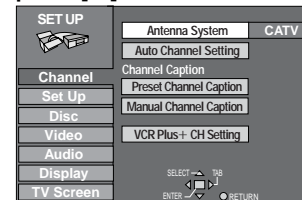

- 3 Press [▲, ▼] to select "VCR Plus+ CH Setting" and press [ENTER].

For example, when the current antenna system is CATV.

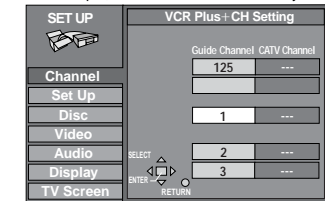

- 4 Press [▲, ▼] to select the guide channel you want to set and press [▶].

When selecting the guide channel, press and hold [▲, ▼] to scroll the screen up and down.

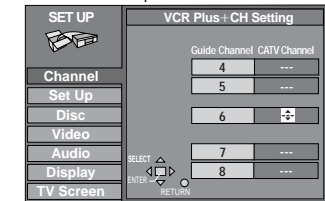

- 5 Press [▲, ▼] to select the channel corresponding to the guide channel and press [▶].

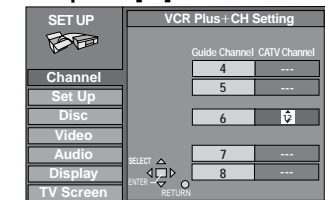

To delete a number, press [CANCEL]. Repeat steps 4 and 5 as necessary.

- 6 Press [ENTER].

The screen shown in step 2 reappears.

#### To return to the previous screen

Press [RETURN].

#### When you are finished

Press [SETUP].

## STEP 5 Selecting TV screen type

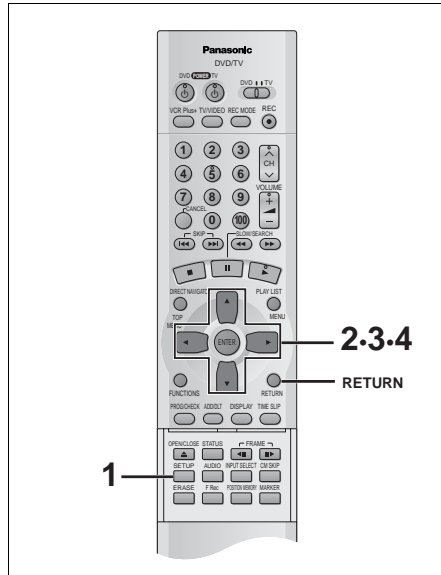

### Change the settings if you:

- Connect the unit to a widescreen 16:9 aspect television.  
→ Set "TV Aspect" to "16:9".
- Connect the unit through the COMPONENT video terminals (→ page 10) to a television compatible with progressive video signals (480P).  
→ Set "TV Type" to "480P".

### 1 Press [SETUP] to show the menus.

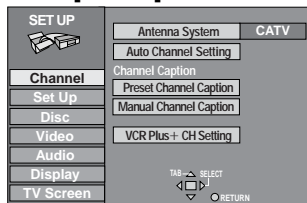

### 2 Press [▲, ▼] to select "TV Screen" and press [▶].

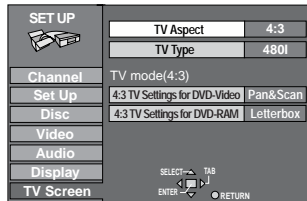

### TV Aspect

### 3 Press [▲, ▼] to select "TV Aspect" and press [ENTER].

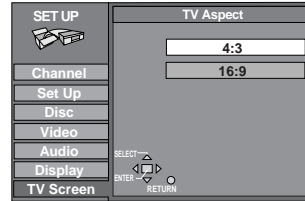

### 4 Press [▲, ▼] to select "16:9" and press [ENTER].

### TV Type

### 3 Press [▲, ▼] to select "TV Type" and press [ENTER].

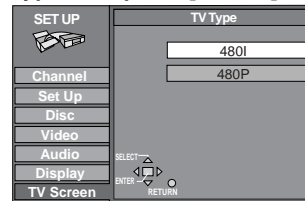

### 4 Press [▲, ▼] to select "480P" and press [ENTER].

- When playing back, select Video in the on-screen menu and set "Transfer" according to the type of material being played (→ page 44).

#### To return to the previous screen

Press [RETURN].

#### When you are finished

Press [SETUP].

## STEP 6 Television operation

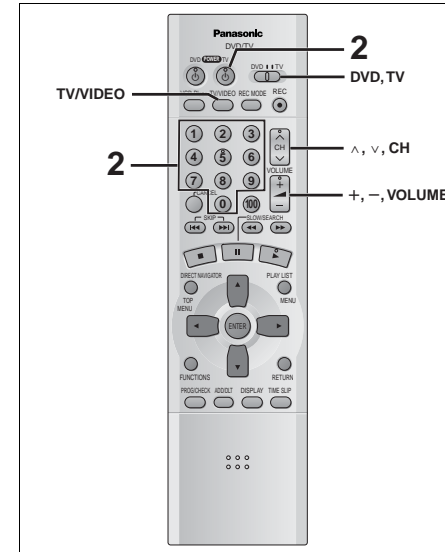

You can control televisions by entering the remote control code.

### 1 Refer to the chart below for the code for your television.

### 2 Press and hold [⏻, POWER TV] and enter the two-digit code with the numbered buttons.

- For example: 01, press [0] → [1].
- Test by turning on the television and changing channels. Repeat the procedure until you find the code that allows correct operation.

#### Note

- If your television brand is not listed or if the code listed for your television does not allow control of your television, this remote control is not compatible with your television.
- This remote control works with most recently manufactured televisions, but may not be able to control older models.

Code No.	Manufacturer
01	Panasonic/National QUASAR
02	Panasonic/National QUASAR
03	MAGNAVOX SYLVANIA PHILIPS (RC-5)
04	ZENITH
05	THOMSON RCA GE
06	SHARP
07	SHARP
08	SONY
09	TOSHIBA
10	SANYO FISHER
11	JVC
12	HITACHI
13	mitsubishi
14	SAMSUNG
15	GOLDSTAR/LG
16	GOLDSTAR/LG
17	GOLDSTAR/LG
18	SAMSUNG
19	SAMSUNG

#### ■ Operation

Point the remote control at the television.

Operation	Button
On and off	[⏻, POWER TV]
Video input mode	[TV/VIDEO]
Channels	(Switch [DVD, TV] to "TV".) [▲, ▼, CH] or Numbered buttons Example: Channel "5": [0] → [5]
Volume	[+, -, VOLUME]



## Playing discs

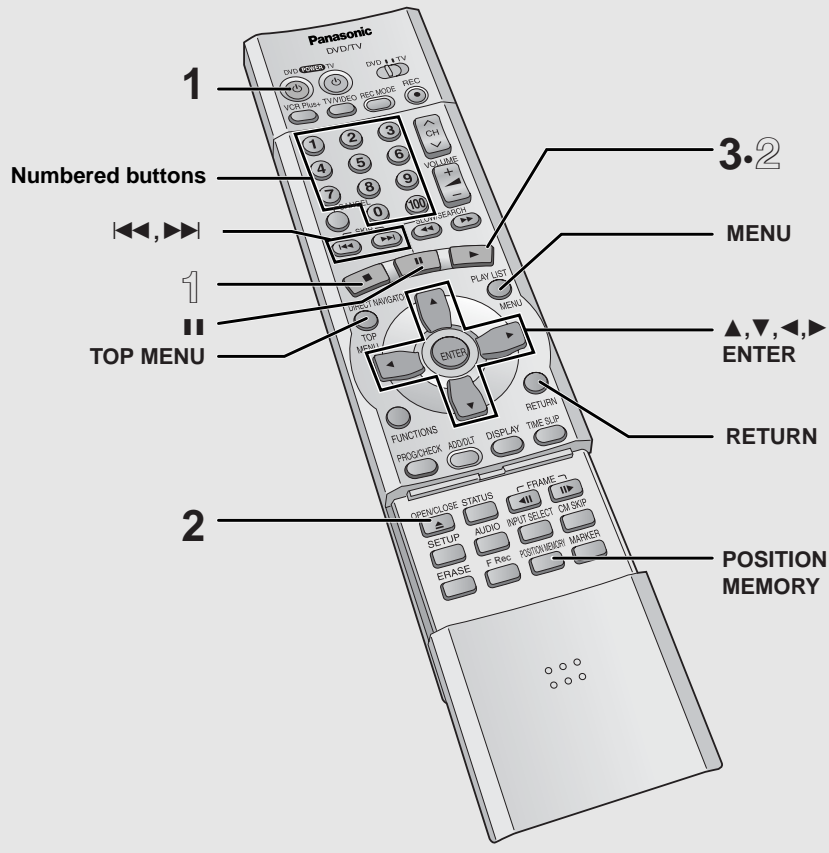
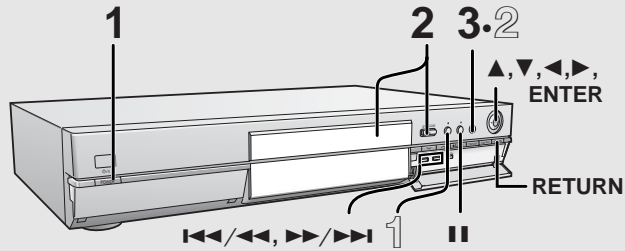

• Volume may be lower when playing DVD-Video than when playing other discs or during television broadcasts. Reduce the volume before playing other sources or returning to the television so volume doesn't increase suddenly.

### Auto power-off

The unit switches to standby after about 6 hours in the stop mode. You can turn this feature off or change the time to 2 hours (→page 52, Set Up—Off Timer).

RAM DVD-R DVD-V CD VCD

- 1 Press [POWER], DVD POWER] to turn the unit on.
- 2 Press [▲, OPEN/CLOSE] to open the tray and insert a disc (→ below).
  - Insert one disc only.
  - Press [▲, OPEN/CLOSE] again to close the tray.
- 3 Press [▶] (PLAY).

The unit takes some time to read the disc before play starts.



RAM DVD-R

Play starts from the beginning of the most recent recording. If that program is extremely short, play starts from the next most recent recording. Use "PLAY FROM TOP" in the FUNCTIONS window (→page 41) to start play from the oldest program on the disc (Program 1).

### To stop play

Press [■] (When "PLAY" flashes → right, Starting play from where you stopped it).

- The screen saver at right may appear when you stop play. Press [■] again and you can use this unit's tuner to watch television. This screen is also shown when you are playing CDs.



### To pause play

Press [II]. Press again to restart play.

## Inserting discs

### Cartridge discs

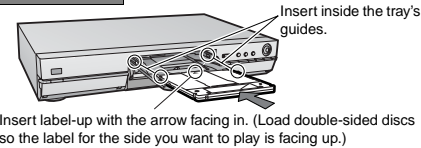

### Non-cartridge discs

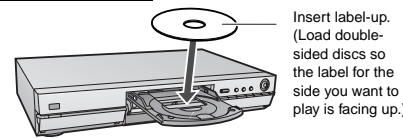

### Double-sided discs

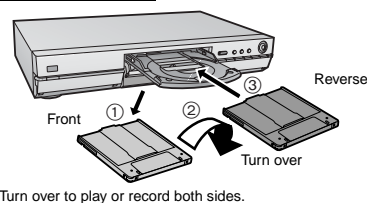

## When a menu screen appears on the television

DVD-V VCD

Press the numbered buttons to select an item.

Example: "5": [0] → [5]

- When playing DVDs, you can also use [▲, ▼, ◀, ▶] to select items. Press [ENTER] to confirm your selection. Play of the selected item now begins.

### Other buttons used to operate menus

Read the disc's instructions for further details about operation.

[▶] [▶] [▶] [▶] [▶]: Shows the next menu.

[◀] [◀] [◀] [◀] [◀]: Shows the previous menu.

[RETURN]: Shows the menu screen. [VCD]

[TOP MENU]: Shows the first menu screen. [DVD-V]

[MENU]: Shows the menu screen. [DVD-V]

### Note

Discs continue to rotate while menus are displayed. Press [■] when you have finished viewing to preserve the unit's motor and your television screen.

### For your reference

#### • If "⊙" appears on the television

The operation is prohibited by the unit or disc.

- If a disc is loaded, the unit will come on and play will start when you press [▶] (PLAY).
- If you play a disc with video and then replace it with an audio-only disc, the video from the previous disc may continue to be shown on the television.

## Starting play from where you stopped it —Resume Function

RAM DVD-R DVD-V CD VCD

(When elapsed play time is displayed)

- 1 During play Press [■]. The unit remembers the position.
- 2 Press [▶] (PLAY) while "PLAY" is flashing on the display. Play starts from where you stopped it.

### To cancel the resume function

Press [■] until "PLAY" goes out.

(The position is also cleared when you turn the unit off or open the disc tray.)

### To start play from a memorized position after turning the unit off—Position Memory

Press [POSITION MEMORY] during play.

(The message "Position Memorized" appears on the television.)

Now when you press [▶] (PLAY) after switching the unit to standby and back on, play starts from the memorized position and the position is cleared.

### For your reference

If you press [■] before switching the unit to standby after pressing [POSITION MEMORY] to memorize a position, play will resume from the position you pressed [■] when you press [▶] (PLAY).

DVD-R DVD-V CD VCD

- The position is memorized when you press [POSITION MEMORY] and cleared when you open the disc tray.

### RAM

- Positions recorded by pressing [POSITION MEMORY] remain memorized even after the disc tray is opened.
- You cannot mark positions if the disc is write-protected.

## Recording television programs

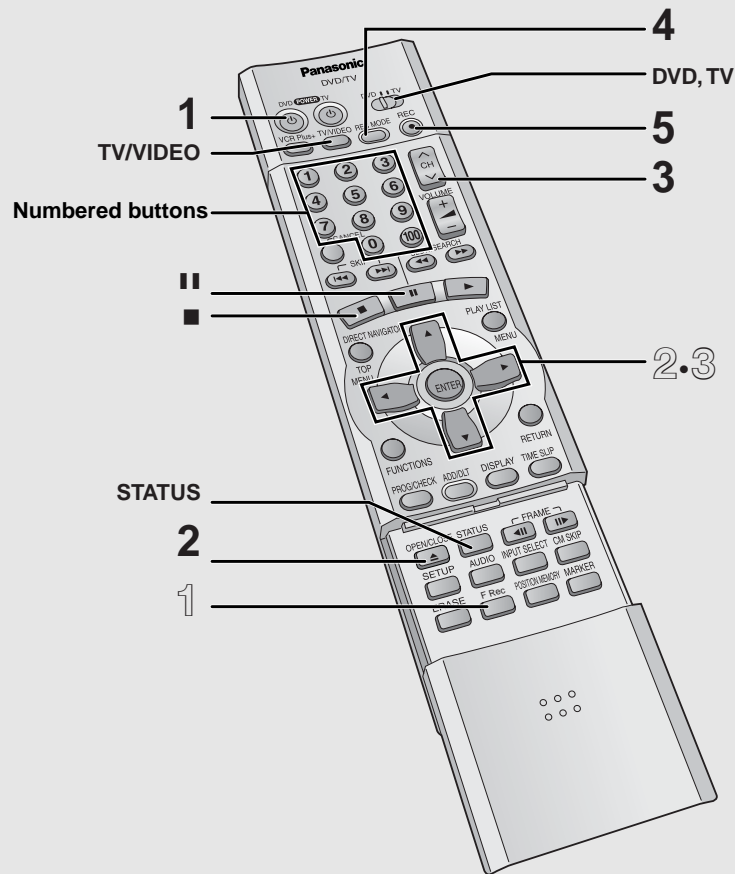
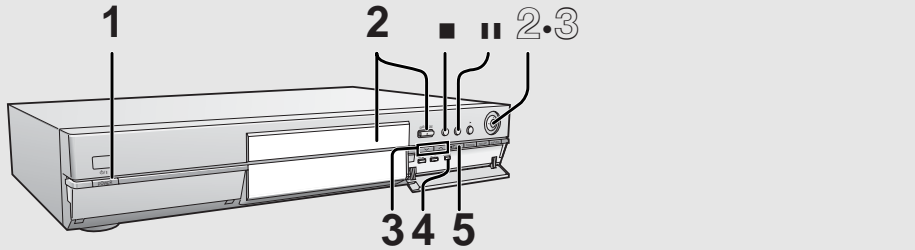

### RAM DVD-R

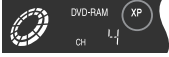
- Press [⏻, DVD POWER] to turn the unit on.
- Press [▲, OPEN/CLOSE] to open the tray and insert a disc.
  - Ensure the disc is not write-protected.
  - Press [▲, OPEN/CLOSE] again to close the tray.
- Ensure [DVD, TV] is switched to "DVD" and press [▲, ▼, CH] to select the channel.
 
- Press [REC MODE] to select the recording mode.
 

Select "XP", "SP", "LP", or "EP" (→ see below).
- Press [●, REC] to start recording.
 

A single recording is called a program. Program information (e.g., time and date) is registered in the program list (→page 20).

### To pause recording

Press [⏸]. Press again to restart recording.

### To stop recording

Press [■].

### For your reference

- You can record up to 99 programs on one disc.
- You cannot change the channel or recording mode during recording. You can change them while recording is paused, but the material is recorded as a separate program.
- There are limitations when recording to DVD-R (→page 8).
- When using a DVD-RAM for the first time with this unit, format it to ensure accurate recording (→page 34, "Format").

## One Touch Recording—Specify a time to stop recording

This is a simple way of specifying a time to stop recording when you are in a hurry or before you go to bed. You can set the time up to 4 hours in advance.

### While recording

Press [●, REC] to select the recording time.

Each time you press the button:

0:30 → 1:00 → 1:30 → 2:00 → 3:00  
 ↑ (Counter) ← 4:00 ←

Example:  

### To cancel

During recording, press [●, REC] until the counter appears.

- Recording continues.

### For your reference

- Press [STATUS] to show the time remaining until recording finishes.
- This does not work during timer recordings or while using Flexible Recording (→ right).
- Recording stops and the set time is cleared if you press [■].
- The set time is cleared if you change the recording mode or channel while recording is paused.

## Flexible Recording—recording the best quality pictures in a set time

The unit calculates a recording rate that enables the recording to fit in the time you set (within the remaining time on the disc) and with the best possible picture quality.

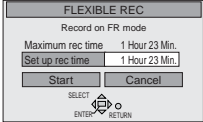
- While stopped Press [FR Rec].
 
- Use [◀, ▶] to select "Hour" and "Min." and set the time with [▲, ▼].
- To start recording Press [▲, ▼, ▶, ◀] to select "Start" and press [ENTER]. Recording starts.

### For your reference

- Press [STATUS] during recording to show the remaining time.
- It is not possible to change channel or recording mode while Flexible Recording is paused.
- Recording time reduces if you repeatedly pause recording.

### Note

It may not be possible to record to the finish of the program if the remaining time doesn't allow.

## Watching the television while recording

- Press [TV/VIDEO] to change the input mode to "TV".
- Switch [DVD, TV] to "TV".
- Press [▲, ▼, CH] to change channels.
  - You can also select the channel with the numbered buttons.
    - Example: "5": [0] → [5]
    - "15": [1] → [5]
    - "115": [100] → [1] → [5]

## Notes on recording

Recording modes and approximate recording times in hours

Mode	DVD-RAM		DVD-R (4.7 GB)
	Single-sided (4.7 GB)	Double-sided (9.4 GB)	
XP (High quality)*	1	2	1
SP (Normal)	2	4	2
LP (Long play)	4	8	4
EP (Extra long play)	6	12	6

\* It is possible to use LPCM when recording in XP mode (→page 53, Audio—Audio Mode for XP Recording).

### Flexible Recording (FR) mode

The unit automatically selects a recording rate between XP and EP that will enable the recordings to fit in the available recording time on the disc with the best possible recording quality. You may use FR mode in either Flexible Recording (→ above) or in timer recording (→page 30).

### Protection

You can protect the contents of your discs in the following ways.

- Cartridge-protect: With the write-protect tab in the protect position, you cannot record to, edit, or erase from the disc. (Type 1, 2, and 4 cartridge discs)
- Disc-protect (→page 34)
- Program-protect (→page 36)



## Using the Direct Navigator

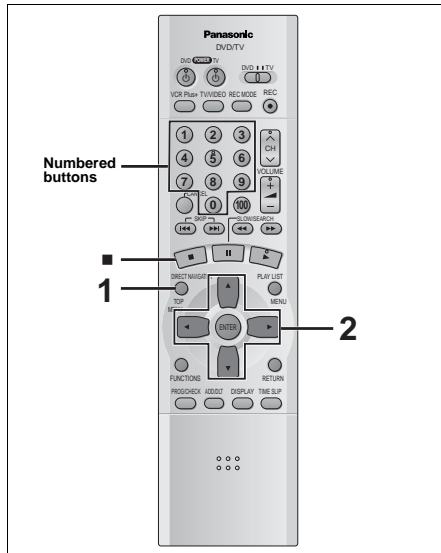

### RAM DVD-R

A list of programs is created as you record them. You can use this list to find programs to watch.

- 1 Press [DIRECT NAVIGATOR].  
The highlighted program plays in the background.

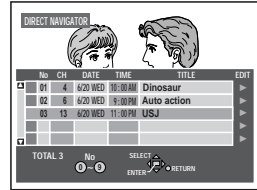

- 2 Press [▲, ▼] to select the program and press [ENTER].

• You can also select programs by entering a 2-digit number with the numbered buttons.

Example: "5": [0] → [5]  
"15": [1] → [5]

Play of the images that were playing in the background continues.

**To clear the program list**  
Press [DIRECT NAVIGATOR].

**To stop play**  
Press [■].

### About the program list

#### Write-protected

Displayed when you have protected the program.

#### Copy-protected

Displayed when you have recorded a program that has copy protection, from CATV broadcasts, for example.

#### Unable to play

Displayed if you cannot play the program.

#### Currently recording

Displayed when the program is being recorded.

No	CH	D
01	4	6/21
02	6	6/21
03	13	6/21
04	2	6/21
05	8	6/21

TOTAL 5

## Playing play lists

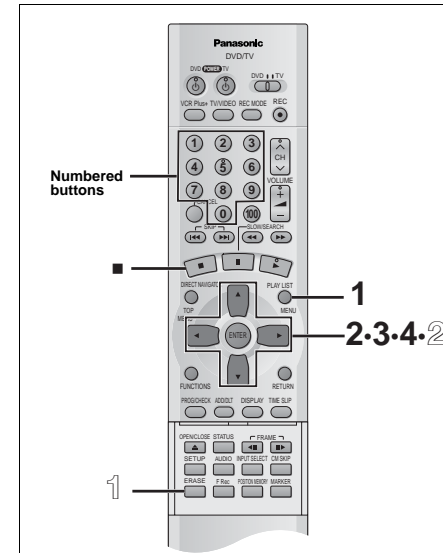

### RAM

Create play lists first (→page 40).

## Playing play lists

- 1 While stopped  
Press [PLAY LIST].

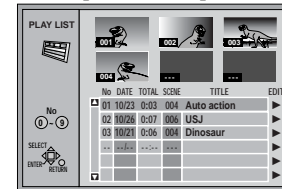

- 2 Press [▲, ▼] to select the play list and press [ENTER].

• You can also select play lists by entering a 2-digit number with the numbered buttons.

Example: "5": [0] → [5]  
"15": [1] → [5]

All the scenes in the play list are played.

**To stop play list play**  
Press [■].

The play list appears.

**To clear the play list**  
Press [PLAY LIST].

## Playing play list scenes

- 1 While stopped  
Press [PLAY LIST].
- 2 Press [▲, ▼] to select the play list that contains the scene you want to play and press [▶].

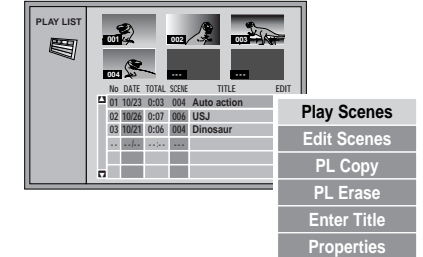

- 3 Press [▲, ▼] to select "Play Scenes" and press [ENTER].

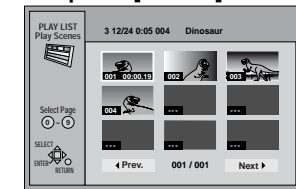

- 4 Press [▲, ▼, ◀, ▶] to select the scene and press [ENTER].

The scene you select is played.

#### To show scene 10 and later

In step 4, press [▲, ▼, ◀, ▶] to select "Next ▶" and press [ENTER].

• You can also select a page of scenes by entering a 3-digit number with the numbered buttons.

Example: "5": [0] → [0] → [5]  
"15": [0] → [1] → [5]

**To stop scene play**  
Press [■].

The scene list appears.

## To erase a play list or a play list scene during playback

- 1 While playing back a play list or play list scene  
Press [ERASE].  
A confirmation message will be displayed.
- 2 "Erase/Cancel" or "Yes/No" will be displayed. Select "Erase" or "Yes" and press [ENTER].  
Select "Cancel" or "No" and press [ENTER] to cancel.

## Skipping programs and commercials

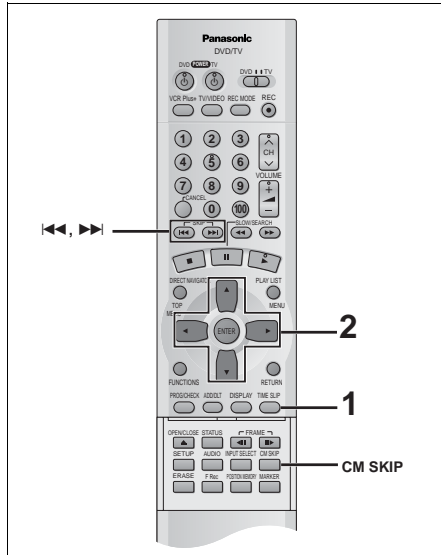

### Skipping

RAM DVD-R DVD-V CD VCD

You can skip to the beginning of tracks (CD and Video CD) and chapters (DVD-Video) and restart play from there. On DVD-RAM and DVD-R, you can skip to the start of a program or to a marker (→page 25) and start play from there.

During play or while paused

Press [**◀◀**] or [**▶▶**].

• Press [**◀◀**] or [**▶▶**] on the main unit.

[**◀◀**] [**◀◀◀◀**]: backward

[**▶▶**] [**▶▶▶▶**]: forward

Each press increases the number of skips.

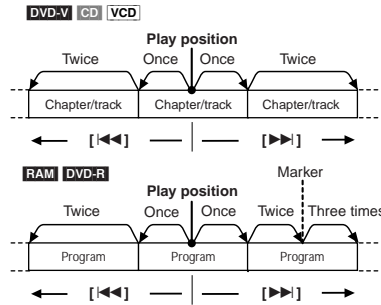

For your reference

Pressing [**◀◀**] [**◀◀◀◀**] or [**▶▶**] [**▶▶▶▶**] while the playback control feature on Video CDs (→page 57) is working may take you to a menu screen.

## Skipping a minute forward—CM Skip

RAM DVD-R

During play

Press [**CM SKIP**].

Play restarts from approximately a minute later.

Note

- If the start of the next program is within one minute of the point you skipped from, play restarts from the beginning of that program.
- Since the length of commercials varies, this feature may not skip commercials accurately.

## Selecting an amount of time to skip—Time Slip

RAM DVD-R

1 During play  
Press [**TIME SLIP**].

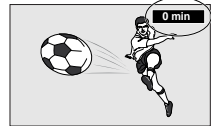

2 Press [**▲**], [**▼**] to enter the time and then press [**ENTER**].



Press to alter in one-minute units. Press and hold to alter in 10-minute units.

## Other methods of play

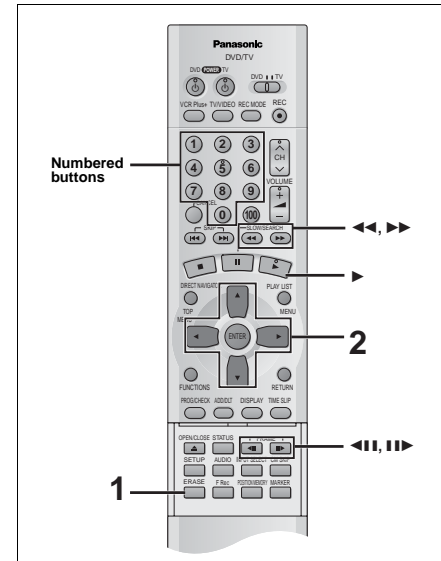

### Fast forward and rewind—SEARCH

RAM DVD-R DVD-V CD VCD

During play

Press [**◀◀**] or [**▶▶**].

• Press and hold [**◀◀**] or [**▶▶**] on the main unit.

[**◀◀**] [**◀◀◀◀**]: Backward

[**▶▶**] [**▶▶▶▶**]: Forward

• Press [**▶**] (PLAY) to restart play.

• The speed increases up to 5 steps.

• Pressing [**◀**] [**◀◀**] or [**▶**] [**▶▶**] while the playback control feature on Video CDs (→page 57) is working may take you to a menu screen.

• Audio will be heard during search. You can turn this audio off if you want to (→page 53, Audio—Audio during Search).

### Slow-motion play

RAM DVD-R DVD-V VCD

While paused

Press [**◀◀**] or [**▶▶**].

• Press and hold [**◀◀**] or [**▶▶**] on the main unit.

[**◀◀**] [**◀◀◀◀**]: Backward (does not work with Video CDs)

[**▶▶**] [**▶▶▶▶**]: Forward

• Press [**▶**] (PLAY) to restart play.

• The speed increases up to 5 steps.

• Pressing [**◀**] [**◀◀**] or [**▶**] [**▶▶**] while the playback control feature on Video CDs (→page 57) is working may take you to a menu screen.

## Frame-by-frame viewing

RAM DVD-R DVD-V VCD

While paused

Press [**◀**] or [**▶**].

[**◀**]: Backward (does not work with Video CDs)

[**▶**]: Forward

• Each press shows the next frame.

• Press [**▶**] (PLAY) to restart play.

## Starting play from a selected program, title, chapter, or track

RAM DVD-R DVD-V CD VCD

During play or while stopped

Press the numbered buttons to select the item.

Example: "5": [0] → [5]

"15": [1] → [5]

Note

• This may not work with some discs.

• This works only when stopped with some discs (the screen saver is on the television).



## To erase a program that is being played back

RAM DVD-R

Since the program and any play lists created from it are erased irretrievably by this procedure, you should be certain you wish to erase before carrying it out.

1 During play  
Press [**ERASE**].

A confirmation message will be displayed.

2 Press [**◀**] to select "Erase" and press [**ENTER**].

Select "Cancel" and press [**ENTER**] to cancel.

Note

• It is not possible to erase the program when you are carrying out simultaneous rec and play (→page 28).

• It is not possible to erase a program that is in the process of being recorded.

## To play DVD-R recorded on this unit on other players

DVD-R

You can play DVD-R on other compatible DVD players by finalizing (→page 34) them on this unit. The disc title (→page 34) and the program titles (→page 36) will appear as menus.

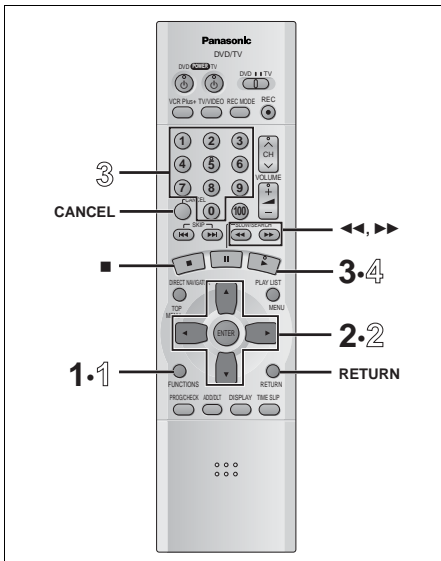

**Random play**

**CD VCD**  
The unit plays the tracks on a disc in random order.

- 1 While stopped Press [FUNCTIONS].
- 2 Press [▲, ▼, ◀, ▶] to select "RANDOM PLAY" and press [ENTER].



- 3 Press [▶] (PLAY).

**To cancel random play**

- 1 Press [■] until the random play screen appears.
- 2 Press [FUNCTIONS] or [RETURN].

**Program play**

**CD VCD**

You can select up to 100 tracks to play in the order you choose.

- 1 While stopped Press [FUNCTIONS].
- 2 Press [▲, ▼, ◀, ▶] to select "PROGRAM PLAY" and press [ENTER].



- 3 Press the numbered buttons to select the track.

Example: "5": [0] → [5]  
"15": [1] → [5]

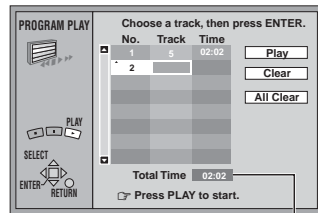

Total time of the program

- Repeat step 3 to select other tracks.
- You can also use the cursor buttons to select tracks.
  - 1 Press [ENTER], then press [▲, ▼] to select the track. Select "ALL" to enter all tracks on the disc.
  - 2 Press [ENTER].

- 4 Press [▶] (PLAY).

Play starts in the programmed sequence.

**To move to the page before or after the one shown**  
Press [◀◀] or [▶▶].

**To clear the programmed tracks one by one**

- 1 Press [▲, ▼] to select the track you want to clear.
  - 2 Press [CANCEL].
- Alternatively, press [▲, ▼, ◀, ▶] to select "Clear" and press [ENTER].

**To clear the whole program**

- Press [▲, ▼, ◀, ▶] to select "All Clear" and press [ENTER].
- The whole program is also cleared when you turn the unit off or open the disc tray.

**To exit the program mode**

- 1 Press [■] during play until the program play screen is displayed.
- 2 Press [FUNCTIONS] or [RETURN].

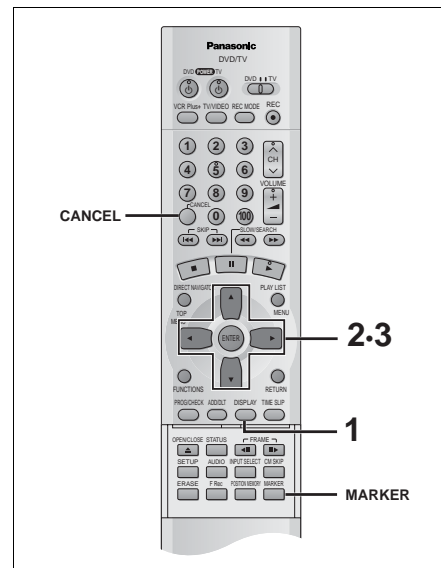

Use on-screen menus to mark, recall, and clear positions. You can also mark positions by pressing [MARKER].

**RAM DVD-R**

Mark up to 999 positions. The unit records the markers directly onto the disc and they remain intact even if you remove the disc.

**DVD-V CD VCD**

Mark up to 5 positions. The markers clear when you open the disc tray.

**Marking positions directly**

During play

Press [MARKER].

One marker is added.



**Note**

- You cannot use this feature if:
  - The disc's elapsed play time is not shown.
  - You are using a play list.
  - You have write-protected the disc (you can still recall the markers to play a position).
- Subtitles around markers may fail to appear.

**Using on-screen menus to mark positions**

**Displaying the marker icon**

- 1 During play Press [DISPLAY].  
The on-screen menu appears. (e.g., DVD-RAM)
 

Disc	Sound track	1	DD Digital 2/Ch
Play	Subtitle		OFF
Video	Repeat play		OFF
Audio	Audio channel		L/R
- 2 Press [▲, ▼] to select the "Play" tab and press [▶].
 

Disc	A-B repeat	OFF
Play	Repeat play	OFF
Video	Marker	1-10   *****
Audio		
- 3 Press [▲, ▼] to select "Marker" and press [▶] to highlight the first asterisk (\*).
 

RAM DVD-R	
1-10   *****	DVD-V CD VCD
	*****

**Marking positions**

Press [◀, ▶] to select an asterisk (\*) and press [ENTER].

One marker is added.

**When marking positions 11 and above**

**RAM DVD-R**

- 1 Press [◀, ▶] to highlight "1-10".
- 2 Press [▲, ▼] to select "11-20".  
You can select the next group of 10 when the current group is full.
- 3 Press [▶].  
The first asterisk is highlighted.
- 4 Press [ENTER] to mark a position.

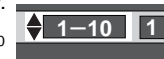

**Playing from a marked position**

Press [◀, ▶] to select a marker number and press [ENTER].

Play starts from the marked position.

**Clearing markers**

Press [◀, ▶] to select a marker number and press [CANCEL].

An asterisk replaces the number and the position is cleared.

**To clear the menus**

Press [DISPLAY].

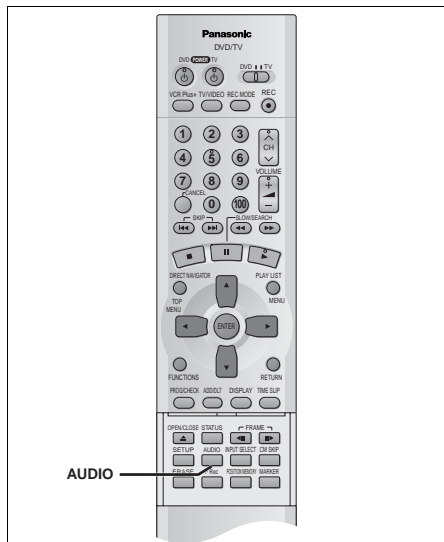

RAM DVD-R DVD-V VCD

You can change the audio being received or played.

During reception or play

Press [AUDIO].

How the type changes depends on when you press the button.

## While receiving Multi-channel Television Sound Stereo (MTS)

Stereo → SAP → Mono

Depending on the type of television broadcast and sound selected, received and recorded sound is as follows:

Television broadcast \ Audio selected	Audio selected		
	Stereo	SAP	Mono
Stereo +SAP	Main audio (Stereo) <sup>#1</sup>	Secondary audio program (SAP) <sup>#2</sup>	Main audio (Monaural)
Mono +SAP	Main audio (Monaural)	Secondary audio program (SAP) <sup>#2</sup>	Main audio (Monaural)
Stereo	Stereo <sup>#1</sup>	Stereo <sup>#1</sup>	Monaural
Mono	Monaural	Monaural	Monaural

- <sup>#1</sup> Select "Mono" if reception is poor during a stereo broadcast.
- <sup>#2</sup> If recorded in this mode, main audio is also recorded. Consequently it is possible to choose between MAIN and SAP when playing back.

e.g.: "Stereo" is selected

"(((" appears when the unit is receiving the type of audio you selected.

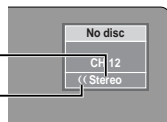

### Note

- If you alter the sound setting during recording, the sound will be altered in the recording itself also.
- It will not be possible to alter the sound by pressing [AUDIO] in the following cases:
  - When a DVD-R is in the disc tray
  - When recording mode is XP and LPCM has been selected in the SETUP menu, Audio Mode for XP Recording (→page 53).
- You cannot change audio type while recording with DVD-R or recording on DVD-RAM with LPCM sound. You can use the SETUP menus to select which audio type of an SAP broadcast is recorded, either "Main" or "SAP" (→page 53, Audio—Select MTS for DVD-R or LPCM).

## While playing DVD-RAM

LR→L→R

- If you have recorded an SAP broadcast by pressing [AUDIO] to select SAP  
MAIN↔SAP

e.g.: "L R" is selected

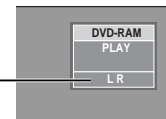

**For your reference**  
You can change the audio for the images being played with simultaneous rec and play and Time Slip.

## While playing DVD-R

You cannot change audio type.

## While playing DVD-Video

You can change the audio channel number each time you press the button. This allows you to change things like the soundtrack language.



e.g.: English is the selected language.



The language is switched to French.

## While playing Video CD

LR→L→R

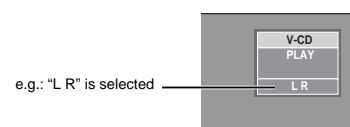

e.g.: "L R" is selected

### Note

If you cannot change the audio type when you have used only an optical digital cable for connection, set "Dolby Digital" to "PCM" (→page 51). Alternatively, you may connect to an amplifier with an audio/video cable and change the input on the amplifier to suit the connection.



## Playing while you are recording

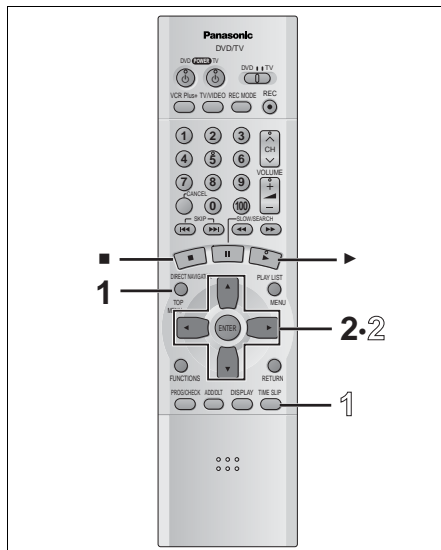

## Playing from the beginning of the program you are recording—Chasing play

RAM

For example:  
while recording program 2 (sport)

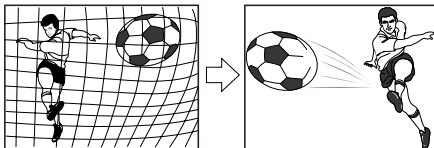

You are recording a **sports program (2)** and you want to watch it from the beginning.

The same **sports program** is recorded while you are watching it.

During recording

Press [▶] (PLAY).

Play starts from the beginning of the program being recorded.

For your reference

- Sound is not output while fast-forwarding.
- Play cannot be started until at least 2 seconds after recording starts.
- You cannot catch up to the point currently being recorded using fast-forward (play will automatically begin a few seconds before reaching the current recording point). If you wish to view the program as it is being recorded, press [■] to stop play.

### To stop play and recording

- 1 Press [■]. Play stops.  
Wait 2 seconds.
- 2 Press [■]. Recording stops.  
• To stop timer recording, press [■], then [ENTER] within 5 seconds.

## Simultaneous rec and play

RAM

You can start play a program previously recorded.

For example:  
while recording program 2 (sport)

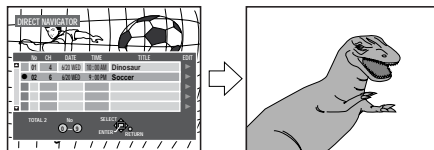

You want to watch the **movie** you recorded yesterday (program 1).

A **sports program** is recorded while you watch a **movie**.

- 1 During recording  
Press [DIRECT NAVIGATOR].  
The program list appears.
- 2 Press [▲, ▼] to select a program and press [ENTER].

For your reference

You cannot edit programs during simultaneous rec and play (→page 36).

## Reviewing the recorded images while recording—Time Slip

RAM

You can play the program being recorded to check that it is being recorded correctly. You can also check parts that were recorded previously.

- 1 During recording  
Press [TIME SLIP].

Play starts from 30 seconds previous. The play images appear as a picture-in-picture and you will hear the audio for these images.

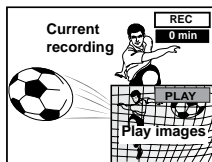

- 2 Within 5 seconds  
Press [▲, ▼] to enter the time and press [ENTER].

- Press [▲, ▼] to alter in one-minute units. Press and hold [▲, ▼] to alter in 10-minute units.



Note

The recording and play images cannot be shown at the same time if you set "TV Type" to "480P" (→page 14).

## Recording from a video cassette recorder

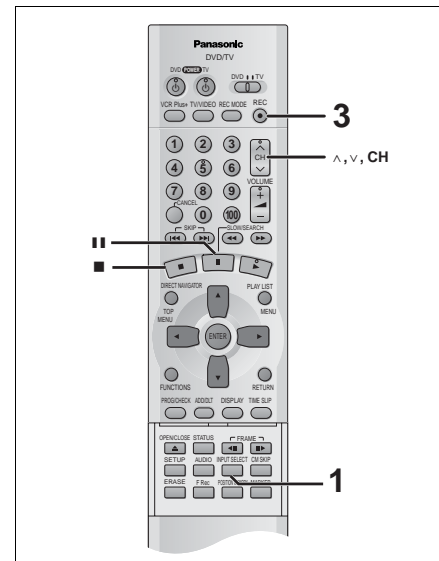

Preparation

- Connect a video cassette recorder to this unit's input terminals (→page 48).
- Insert a disc that can be recorded on.
- Select the recording mode, XP, SP, LP, or EP (→page 19).

- 1 While stopped  
Press [INPUT SELECT] to select the input channel for the equipment you have connected.  
Select L1, L2, or L3.  
• You can also select the input channel by pressing [▲, ▼, CH].
- 2 Start play on the other equipment.
- 3 Press [●, REC] at the point you want to start recording.

To skip unwanted parts

Press [||] to pause recording.  
Press again to restart recording.

To stop recording

Press [■].

Note

When recording using L1, L2 or L3 terminals, only the sound received at the time of recording will be recorded.

This unit complies with industry standards regarding the recording and duplication of copy-protected material. This includes commercial videotapes and DVDs. Consequently, copying not only infringes copyright laws but also presents serious technical difficulties. Even in cases where a copy can be made, the quality will be very poor.

## Timer recording

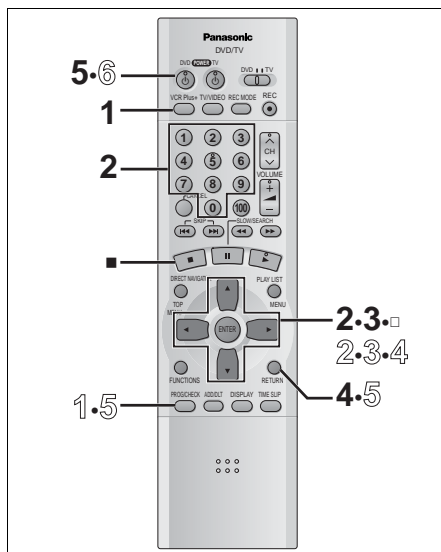

RAM DVD-R

### Preparation

- Ensure the clock (and guide channels for VCR Plus+ recording, →page 13) are set correctly.
- Insert a disc for recording (make sure there is enough room for the program you are going to record plus a little extra).

## Using VCR Plus+ codes to make timer recording

Entering VCR Plus+ codes is an easy way of programming the unit for recording. You can find these codes in newspapers and magazines. You can enter up to 16 programs up to a month in advance.

### 1 Press [VCR Plus+].

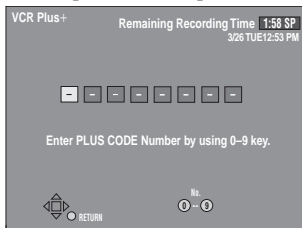

### 2 Press the numbered buttons to enter the VCR Plus+ code.

Press [←] to move back to correct a digit.

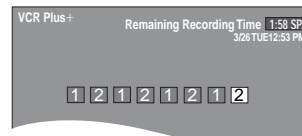

### 3 Press [ENTER].

The timer recording setting screen appears. Confirm the program and make corrections if necessary using [▲, ▼, ◀, ▶].

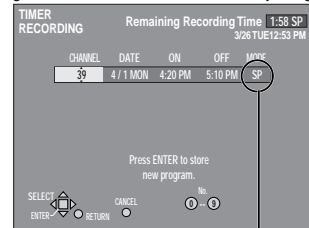

The current recording mode (shown on the unit's display) is automatically selected. In case where the recording mode has already been set to XP, the recording mode will be automatically changed to FR mode.

When you press [ENTER]

The timer recording list appears.

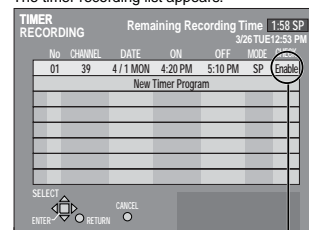

Displayed if the recording can fit in the remaining space on the disc.

Repeat steps 1-3 to program other recordings.

### 4 Press [RETURN].

The timer recording list disappears and the message "TURN RECORDER OFF FOR TIMER RECORDING" is shown on the television.

### 5 Press [⏻, DVD POWER].

Ensure "□" lights on the unit's display.

### To release the unit from recording standby

If you want to record something else before the program start time, for example:

Press [⏻, DVD POWER].

The unit turns on and "□" goes out.

- Be sure to press [⏻, DVD POWER] to return the unit to standby mode before the scheduled recording time. Timer recording will work only if "□" is displayed.

### To stop recording when recording has already begun

Press [■], then [ENTER] within 5 seconds.

Recording stops. Recording standby is also canceled if there are other timer recording programs. Be sure to press [⏻, DVD POWER] to put the unit on timer recording standby.

### Note

- The actual time recorded may be longer than the program itself when television programs are recorded using VCR Plus+.
- "Invalid Entry" is displayed when you enter the wrong code. Reenter the code.
- "All timer programs are occupied." appears if there are already 16 programs.

## Manually programming timer recordings

You can enter up to 16 programs up to a month in advance. Each daily or weekly program is counted as one program.

### 1 Press [PROG/CHECK].

The timer recording list appears.

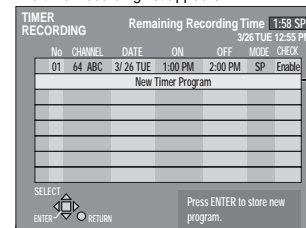

A line that is ready for programming is highlighted.

### 2 Press [ENTER].

The timer recording setting screen appears.

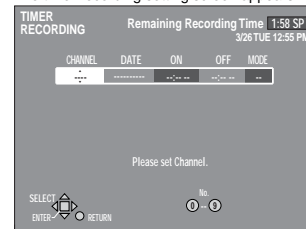

### 3 Press [▶] to move through the items and change the items with [▲, ▼].

- The current settings are shown each time you press [▶].
- You may use the numbered buttons to enter the CHANNEL, DATE, ON (start Time), and OFF (Finish Time).

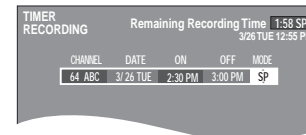

- CHANNEL (Channel number and caption)

- DATE
  - Current date---→the day before one month later→
  - SUN-SAT→MON-SAT→MON-FRI→
  - WEEKLY SUN---→WEEKLY SAT

- ON (Start time)/OFF (Finish time)

The time increases or decreases in 30-minute increments if you hold the button.

- MODE (Recording mode →page 19)

SP→XP→FR→EP→LP

### 4 Press [ENTER] when you have finished programming the timer.

The timer recording list reappears.

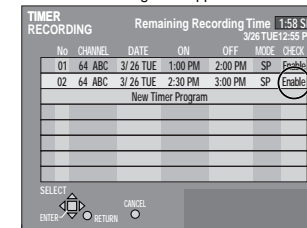

Displayed if the recording can fit in the remaining space on the disc.

Press [▲, ▼] to select "New Timer Program" and repeat steps 2-4 to program other recordings.

### 5 Press [PROG/CHECK] or [RETURN].

The timer recording list disappears and the message "TURN RECORDER OFF FOR TIMER RECORDING" is shown on the television.

### 6 Press [⏻, DVD POWER].

Ensure "□" lights on the unit's display.

### To release the unit from recording standby

If you want to record something else before the program start time, for example:

Press [⏻, DVD POWER].

The unit turns on and "□" goes out.

- Be sure to press [⏻, DVD POWER] to return the unit to standby mode before the scheduled recording time. Timer recording will work only if "□" is displayed.

### To stop recording when recording has already begun

Press [■], then [ENTER] within 5 seconds.

Recording stops. Recording standby is also canceled if there are other timer recording programs. Be sure to press [⏻, DVD POWER] to put the unit on timer recording standby.

### Notes on timer programming

- When recording in FR mode, in cases where the space remaining on the disc is insufficient, it may not be possible to record to the finish of the program.
- The remaining time displayed is based on the current recording mode.
- Approximately 30 seconds at the beginning of subsequent programs is not recorded when you use timer recording to record subsequent programs to a DVD-R.
- If you set DST (Daylight Saving Time) to ON when manually setting the clock (→page 54), timer recording may not work when summer switches to winter and vice versa.
- "□" flashes when the unit couldn't go to timer recording standby (e.g., a disc isn't loaded, a disc that can't be recorded to is loaded, or the disc is protected). Check the disc carefully.



## Timer recording

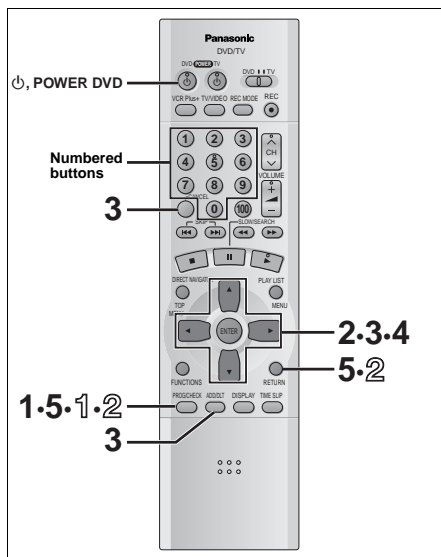

### To change or delete the program

- 1 Press **[PROG/CHECK]**.  
The timer recording list appears.
- 2 Press **[▲, ▼]** to select the program.
  - You may also select programs by inputting a 2-digit number using the numbered buttons.
  - Press **[◀, ▶]** to move to the page preceding or following the one on display.
- 3 Press **[CANCEL]** or **[ADD/HLT]** to delete.  
You cannot delete programs that are currently recording.  
or press **[ENTER]** to change.  
The timer recording setting screen appears.
- 4 If you pressed **[ENTER]** in step 3,  
Move through the items with **[▶]** and change the settings with **[▲, ▼]** and press **[ENTER]**.  
In the case of programs in the process of being recorded, it is possible to alter only the finish time.
- 5 Press **[PROG/CHECK]** or **[RETURN]**.  
The timer recording list disappears and the message "TURN RECORDER OFF FOR TIMER RECORDING" is shown on the television.

### To put the unit on timer recording standby

Press **[⏻, DVD POWER]**.  
The unit turns off and "TV" lights on the unit's display.

### To check programs

- 1 Press **[PROG/CHECK]**.

The timer recording list appears.

TIMER RECORDING		Remaining Recording Time		1:57 LP		
No	CHANNEL	DATE	ON	OFF	MODE	CHECK
01	64 ABC	3/26 TUE	1:19 PM	1:22 PM	LP	Enable
02	64 ABC	SUN-SAT	2:30 PM	2:40 PM	LP	→ 32%
03	64 ABC	3/26 TUE	2:30 AM	3:30 AM	SP	Overlap
04	64 ABC	3/25 WED	9:00 AM	10:00 AM	SP	
05	64 ABC	3/25 WED	8:00 AM	9:00 AM	SP	
06	64 ABC	3/25 WED	10:00 AM	11:00 AM	SP	

New Timer Program

### Icon explanations

- The times overlap those in another program.
- This program is currently recording.
- The disc was full or the maximum number of programs or scenes was reached so the program failed to record.
- The material was copy-guarded so the material failed to record.
- The program failed to record for some other reason.

### Message displayed in the CHECK line

**Enable:** Displayed if the recording can fit in the remaining space on the disc.

→ **(Date):** For recordings made daily or weekly, the display will show until when recordings can be made (up to a maximum of one month from the present time) based on the time remaining on the disc.

! : It may not be possible to record because of write protection, because there is no more space left or because the number of possible programs has reached its maximum. Please check the disc.

### For your reference

Programs that failed to record are displayed gray. They are deleted at 4 a.m. two days later.

- 2 Press **[PROG/CHECK]** or **[RETURN]**.

The timer recording list disappears and the message "TURN RECORDER OFF FOR TIMER RECORDING" is shown on the television.

### To put the unit on timer recording standby

Press **[⏻, DVD POWER]**.  
The unit turns off and "TV" lights on the unit's display.

## Entering text

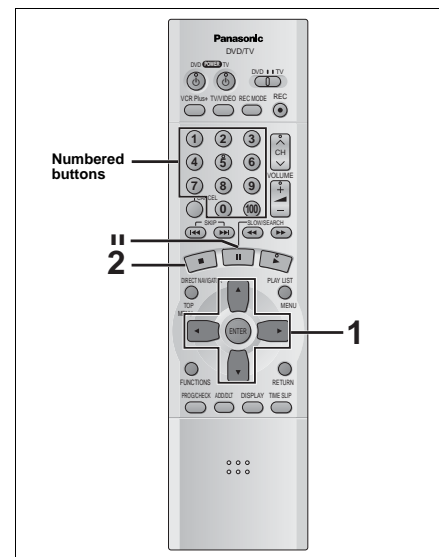

This page shows how to enter text for:

- Disc titles (→page 34)
- Program titles (→page 36)
- Play list titles (→page 38)

RAM DVD-R

- 1 After the titling screen appears  
Press **[▲, ▼, ◀, ▶]** to select the character and press **[ENTER]**.

Title field: shows the text you have entered

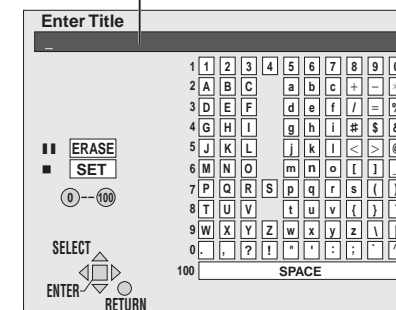

Repeat step 1 to enter other characters.

- 2 Press **[■]**.

The title is entered and the screen disappears.

- You can also finish entering the title by selecting "SET" and pressing **[ENTER]**.

### Using the numbered buttons to enter characters

e.g., entering the letter "R"

- 1 Press **[7]** to move to the 7th row.
- 2 Press **[7]** twice to highlight "R".
- 3 Press **[ENTER]**.

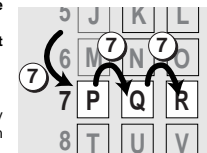

- You may enter a space by pressing **[100]** and then **[ENTER]**.

### To erase a character

- 1 Press **[▲, ▼, ◀, ▶]** to select the character you want to erase in the title field.
- 2 Press **[■]**.  
You can also erase characters by selecting "ERASE" and pressing **[ENTER]**.

# Disc setting

## Operation

While stopped

Press [FUNCTIONS].

Press [▲, ▼, ◀, ▶] to select "DISC SETTING" and press [ENTER].



e.g., DVD-RAM

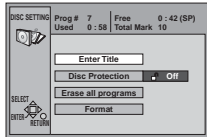

Press [▲, ▼] to select the item and press [ENTER].

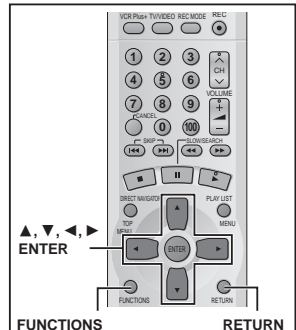

To stop partway through

Press [RETURN], or select "Cancel" or "No" and press [ENTER].

### Enter Title

RAM DVD-R

You can enter up to 64 characters (DVD-RAM) or 40 characters (DVD-R).

Entering text → page 33

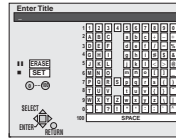

### Disc Protection

RAM

If set, this will protect the disc from accidental erasure. The setting may be activated/deactivated as you wish.

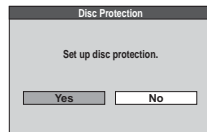

### Erase all programs

RAM

All programs and play lists created from them will be erased irretrievably when you use this procedure. Check it carefully before proceeding.

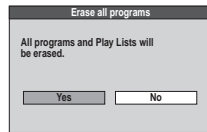

#### For your reference

Nothing will be erased if the disc is write-protected.

### Format

RAM

Some DVD-RAM are unformatted. Format them before using them in this unit. Formatting also allows you to erase the entire contents of a disc.

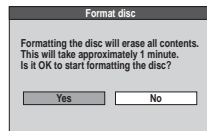

#### For your reference

- The contents on the disc are erased when you format it even if you have set program or disc protection.
- The disc cannot be formatted if the disc is protected with the write-protect tab (→ page 19).
- It may not be possible to use a disc on this unit if you cannot format it.
- Formatting cannot be performed on DVD-R or CD-R/RW.

### Finalize

DVD-R

You can play DVD-R on compatible DVD players by finalizing them on this unit, effectively making them into DVD-Video.

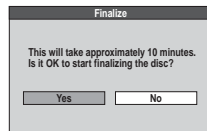

#### For your reference

- You can only finalize DVD-R recorded on this unit.
- You cannot record or perform editing such as giving titles and erasing programs on DVD-R that have been finalized.
- The markers you entered (→ page 25) will be lost.

The DISC SETTING menu screen reappears.

#### Note

- You cannot enter titles if the disc is protected. RAM
- If you enter a long title, only part of it is shown in the menu screen after finalization. DVD-R

Press [◀] to set (or cancel) disc protection and press [ENTER].

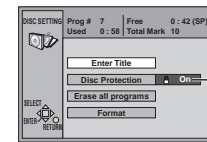

The lock symbol appears closed when the disc is write-protected.

Press [◀] to select "Yes" and press [ENTER].

Press [◀] to select "Start" and press [ENTER].

All programs and play lists are erased.

**Do not turn the unit off or disconnect the AC power supply cord while the message "Now erasing." is on the television.** This can render the disc unusable.

The message "Finish erasing all programs." appears when erasure is finished. Press [ENTER] to complete the procedure.

#### Note

- Data recorded on equipment other than this unit will only be erased if it has been saved in the "DVD-RTAV" folder.
- The disc title will also be erased.

Press [◀] to select "Yes" and press [ENTER].

Press [◀] to select "Start" and press [ENTER].

Formatting starts.

**Do not turn the unit off or disconnect the AC power supply cord while the message "Formatting the disc" is on the television.** This can render the disc unusable.

Formatting takes up to 70 minutes. The message "Formatting is completed." appears when formatting is finished. Press [ENTER] to complete the procedure.

#### Note

If the disc is dirty, clean it with the recommended cleaner (→ page 9) before formatting.

#### To stop formatting

Press [RETURN].

You can cancel formatting if it takes more than 2 minutes. The disc must be reformatted if you do this.

Press [◀] to select "Yes" and press [ENTER].

Press [◀] to select "Start" and press [ENTER].

Finalizing starts.

**Do not turn the unit off or disconnect the AC power supply cord while the message "Finalizing the disc" is on the television.** This will render the disc unusable.

Finalizing takes up to 15 minutes. The message "Finalizing is finished" appears when finalizing is finished. Press [ENTER] to complete the procedure.

#### After finalizing..

The video and audio is recorded according to the DVD-Video specifications, and your very own DVD-Video is created.

- Programs longer than 5 minutes are divided into about five-minute chapters.
- Titles you entered with this unit appear as menus.

• These DVD-R can be played on other DVD players, but this is not guaranteed. Play may not be possible due to the player you are using, the DVD-R, or the condition of the recording. Use this unit to play the disc if the player is unable. Visit Panasonic's homepage for more information about DVDs.

<http://www.panasonic.com/playDVD-R>

# Editing programs

## Operation

Press [DIRECT NAVIGATOR].

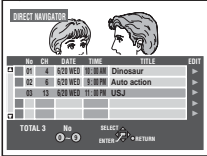

Press [▲, ▼] to select the program.

- You can also select programs by entering a 2-digit number with the numbered buttons. Example: "5": [0] → [5]

Press [▶] so the submenu appears.

Press [▲, ▼] to select the item and press [ENTER].

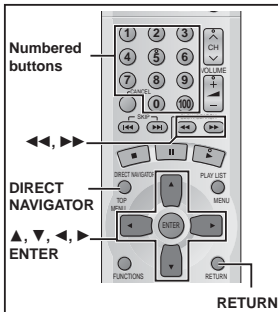

To clear the program list Press [DIRECT NAVIGATOR].

To stop partway through Press [RETURN], or select "Cancel" or "No" and press [ENTER].

For your reference When the disc is write-protected, you can only access "Properties". Release the write-protection to access other items. **RAM**

## Erase Program

**RAM DVD-R**

The program, and play lists created from it, is erased irretrievably when you use this procedure. Check it carefully before proceeding.

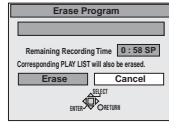

## Enter Title

**RAM DVD-R**

You can enter up to 64 characters (DVD-RAM) or 44 characters (DVD-R).

Entering text → page 33

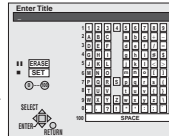

## Properties

**RAM DVD-R**

Program information (e.g., time and date) is shown.



## Protection

**RAM**

If set, this will protect the program from accidental erasure. The setting may be activated/deactivated as you wish.



## Shorten Segment

**RAM**

The program segment, and play list scenes created from it, is erased irretrievably when you use this procedure. Check it carefully before proceeding.



## Divide Program

**RAM**

Select a point at which to divide a program into two.

**Note**

- The divided programs retain the title of the original program. They also remain CPRM property (→ page 8) of the original.
- A minute portion of the recording directly preceding the division point may be lost.

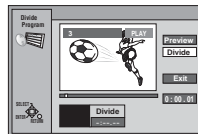

You must be sure you wish to divide a program because once a program has been divided it cannot be returned to its original form.

Press [◀] to select "Erase" and press [ENTER].

The program is erased.

**Note**

- The disc's available recording time may not increase after erasing short programs.
- Computer data cannot be erased.
- The available recording time on DVD-R does not increase when you erase programs.

Press [◀] to set (or cancel) protection and press [ENTER].

The lock symbol appears when the program is write-protected.

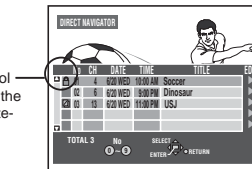

Press [ENTER] at the start point of the section you want to erase.

Press [ENTER] at the end point of the section you want to erase.

Press [▲, ▼] to select "Next" and press [ENTER], then press [◀] to select "Erase" and press [ENTER].

Repeat to enter other sections.

- Use search and slow-motion to find the start and end points.
- Play pauses when the end of the program is reached during this procedure.
- You may not be able to specify points within 3 seconds of each other.
- You cannot specify an end point before a start point.
- You cannot specify points if you have recorded still pictures on other equipment.
- The disc's available recording time may not increase after erasing short segments.

Press [▲, ▼] to select "Exit" and press [ENTER].

Press [◀] to select "Erase" and press [ENTER].

Press [ENTER] at the point you want to divide the program.

Press [▲, ▼] to select "Divide" and press [ENTER].

Press [◀] to select "Divide" and press [ENTER].

The program is divided.

- By selecting "Preview" and pressing [ENTER], play will begin from a point 10 seconds prior to the division point. You may wish to make sure that the division point is at an appropriate location. If it is not necessary to change the division point, select "Exit" and press [ENTER]. To change the division point, press [RETURN], select "Division Program" and redo from the start.
- Use search and slow-motion to find the points.
- It is not possible to carry out Divide Program in the following cases:
  - When the resulting part(s) are extremely short.
  - When the total number of programs is more than 99.

# Editing play lists

RAM

## Operation

While stopped  
Press [PLAY LIST].

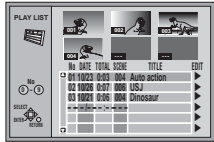

Press [▲, ▼] to select the list.

- To create a new list, select "—" and press [ENTER] (→ page 40).
  - You can also select a play list by entering a 2-digit number with the numbered buttons.
- Example: "5": [0] → [5]

Press [▶] so the submenu appears.

Press [▲, ▼] to select the item and press [ENTER].

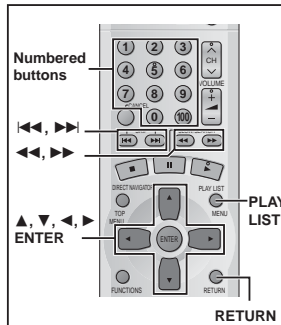

To clear the play list screen  
Press [PLAY LIST].

To stop partway through  
Press [RETURN],  
or select "Cancel" or "No" and press [ENTER].

For your reference  
When the disc is write-protected, you can only access "Play Scenes" and "Properties". Release the write-protection to access other items.

## Play Scenes

→ page 21, Playing play list scenes

## Edit Scenes



Press [◀, ▶] to select the item and press [ENTER].

- Press [▲, ▼, ◀, ▶] to select "Next ▶" and press [ENTER] to show scene 10 and later.
  - You can also select a page of scenes by entering a 3-digit number with the numbered buttons.
- Example: "5": [0] → [0] → [5]  
"15": [0] → [1] → [5]
- One disc can have a maximum of 99 play lists and 999 scenes. These limits may be reduced under some conditions.

## PL Copy



Press [◀] to select "Copy" and press [ENTER].

The copied play list appears at the bottom of the list.

## PL Erase



Press [◀] to select "Erase" and press [ENTER].

The play list is erased.

## Enter Title

You can enter up to 64 characters. The full title is shown in the Properties screen, but if you enter a long title, only part of it is shown in the play list screen.

Entering text → page 33

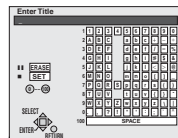

## Properties

Play list information (e.g., time and date) is shown.



## Add

Press [▲, ▼, ◀, ▶] to select the position you want to add the scene and press [ENTER].

Press [ENTER] at the start point of the scene.

The new scene is inserted before the highlighted scene.

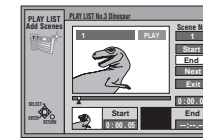

The scene is added.

Press [ENTER] at the end point of the scene.

Press [▲, ▼] to select "Exit" and press [ENTER].

Press [▲, ▼] to select "Next" and press [ENTER]. (Repeat to add other scenes.)

## Move

Press [▲, ▼, ◀, ▶] to select the scene and press [ENTER].

Press [▲, ▼, ◀, ▶] to select the position to which you want to move the scene to and press [ENTER].

The scene is moved and inserted before the highlighted scene.

The scene is moved.

Repeat to move other scenes.

## Re-edit

Press [▲, ▼, ◀, ▶] to select the scene and press [ENTER].

Press [ENTER] at the start point of the scene.

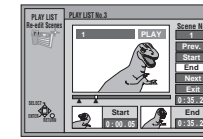

The re-edited scene replaces the old one.

Press [ENTER] at the end point of the scene.

Press [▲, ▼] to select "Exit" and press [ENTER].

Press [▲, ▼] to select "Prev." or "Next" and press [ENTER]. (Repeat to re-edit other scenes.)

## Erase

Press [▲, ▼, ◀, ▶] to select the scene and press [ENTER].

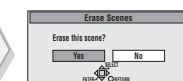

Press [◀] to select "Yes" and press [ENTER].

- The selected scene is erased from the play list.
- The play list itself is erased if you erase all the scenes in it.

Repeat to erase other scenes.

The play list screen reappears.

### Cautionary notes regarding scene edit screens

- Use skip, search and slow-motion to find the points.
- You cannot specify an end point before a start point.
- You may not be able to specify points within 3 seconds of each other.
- Play pauses when the end of the last program is reached during this procedure.
- You cannot specify points if you have recorded still pictures on other equipment.

## Creating play lists

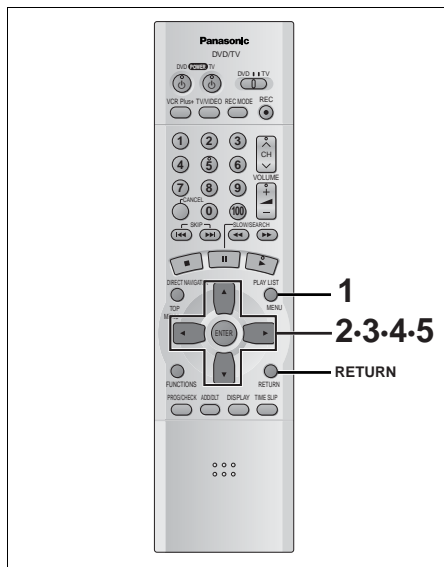

- 1 While stopped  
Press [PLAY LIST].
- 2 Press [▲, ▼] to select “---/---” and press [ENTER].

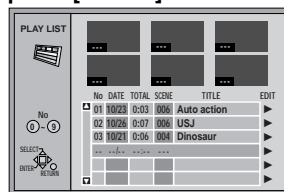

- 3 Press [ENTER] at the start point.



- 4 Press [ENTER] at the end point.



### To specify another scene

Select “Next” and press [ENTER], then repeat steps 3 and 4.

- 5 Press [▲, ▼] to select “Exit” and press [ENTER].

The play lists screen appears.

### To stop partway through

Press [RETURN].

### To clear the play list screen

Press [PLAY LIST].

### For your reference

- You cannot create or edit play lists if the disc is write-protected.
- Play pauses when the end of the last program on the disc is reached during this procedure.
- One disc can have a maximum of 99 play lists and 999 scenes. These limits may be reduced under some conditions.

## Using the FUNCTIONS window

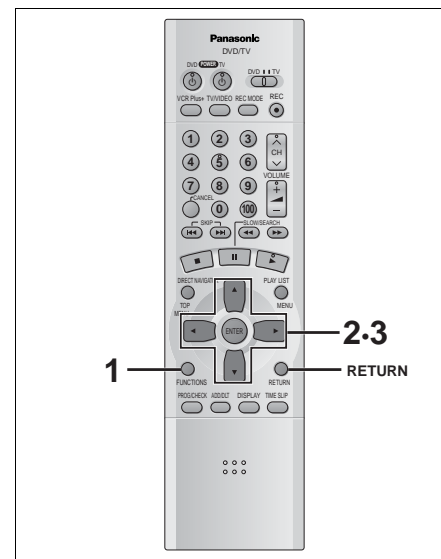

- 1 While stopped  
Press [FUNCTIONS].  
e.g., DVD-RAM

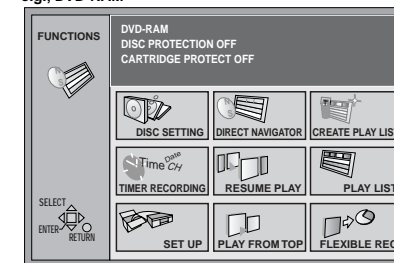

- 2 Press [▲, ▼, ◀, ▶] to select an item.  
Refer to the relevant pages for details.

Icon	Refer to
DISC SETTING	→page 34, Disc setting
TIMER RECORDING	→page 30, Timer recording
SET UP	→page 51, Changing the unit's settings
DIRECT NAVIGATOR	→page 20, Using the Direct Navigator
RESUME PLAY	→page 36, Editing programs
PLAY	→page 17, Playing discs
PLAY FROM TOP	<p><b>RAM DVD-R</b> Play will begin with the oldest program on the disc (Program 1).</p> <p><b>DVD-V</b> Play will avoid playing the introductory parts and begin playing the contents immediately. (The performance of this function varies from disc to disc.)</p>
FLEXIBLE REC	→page 19, Flexible Recording—recording the best quality pictures in a set time
CREATE PLAY LIST	→page 40, Creating play lists
PLAY LIST	→page 21, Playing play lists →page 38, Editing play lists
TOP MENU MENU	→page 17, When a menu screen appears on the television
PROGRAM PLAY	→page 24, Program play
RANDOM PLAY	→page 24, Random play

Functions displayed depend on the type of disc.

- Some items will be grayed out and cannot be selected if:
  - the disc is write protected
  - the disc is not formatted
  - there is nothing recorded on the disc.

- 3 Press [ENTER].

Your selection is entered and the FUNCTIONS window disappears. If the operation requires further selections, another screen appears.

### To clear the FUNCTIONS window

Press [FUNCTIONS] or [RETURN].

## Using on-screen menus

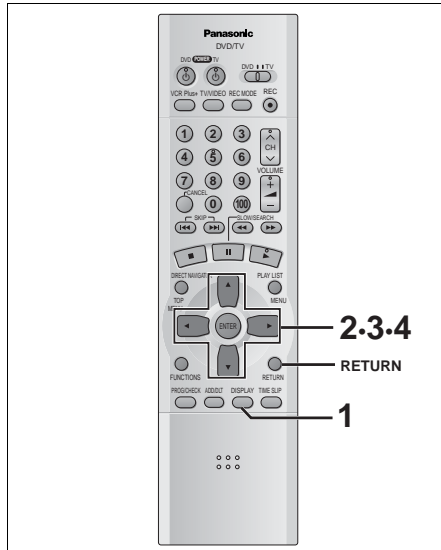

### Common procedures

#### 1 Press [DISPLAY].

e.g. DVD-RAM

Disc	Sound track	1	DD Digital	2/0 ch
Play	Subtitle		OFF	
Video	Audio channel		LR	
Audio				

Menu                      Item                      Setting

#### 2 Press [▲, ▼] to select the menu and press [▶].

#### 3 Press [▲, ▼] to select the item and press [▶].

#### 4 Press [▲, ▼] to select the setting.

#### To return to the previous screen

Press [RETURN].

#### When you are finished

Press [DISPLAY].

#### For your reference

- The screens depend on the disc contents.
- Depending on the condition of the unit (playing, stopped, etc.) and disc contents, there are some items that you cannot select or change.

### Disc menu

RAM DVD-R DVD-V CD VCD

e.g., DVD-RAM

Disc	Sound track	1	DD Digital	2/0 ch
Play	Subtitle		OFF	
Video	Audio channel		LR	
Audio				

Item	Content
Sound track	Soundtrack language DVD-V See <b>A</b> below.
	Audio attribute RAM DVD-R DVD-V See <b>B</b> below.
	Karaoke vocals, on and off (Karaoke DVD-V only) Solo: ON ↔ OFF Duet: OFF ↔ V1+V2 ↔ V1 ↔ V2
Subtitle	Subtitle language DVD-V See <b>A</b> below.
	Subtitle on/off RAM DVD-R DVD-V
Angle	Angle number DVD-V
Audio channel	RAM VCD (→page 26)
PBC	Playback control on/off VCD Indicates whether menu play (playback control) is on or off.

#### A Soundtrack/Subtitle language

ENG: English	SVL: Swedish	CHI: Chinese
FRA: French	NOR: Norwegian	KOR: Korean
DEU: German	DAN: Danish	MAL: Malay
ITA: Italian	POR: Portuguese	VIE: Vietnamese
ESP: Spanish	RUS: Russian	THA: Thai
NLD: Dutch	JPN: Japanese	*: Others

#### B Audio attributes

LPCM/DDigital/DTS/MPEG: Signal type

k (kHz): Sampling frequency

b (bit): Number of bits

ch (channel): Number of channels

Example: 3/2\_1ch

.1:	Subwoofer signal (not displayed if there is no subwoofer signal)
0:	No surround
1:	Mono surround
2:	Stereo surround (left/right)
1:	Center
2:	Front left+ Front right
3:	Front left+ Front right+ Center

#### For your reference

- When playing back recordings of SAP broadcasts, "1+1 ch" will be displayed.
- You can only select subtitles, soundtracks, and angles if they are recorded on the disc.
- Some discs allow changes to soundtracks, subtitles, and angles only by using the disc's menus.
- If the subtitles overlap closed captions recorded on discs, turn the subtitles off.

### Play menu

RAM DVD-R DVD-V VCD

e.g. DVD-RAM

Disc	A-B repeat	---
Play	Repeat play	OFF
Video	Marker	1-10 *****
Audio		

Item	Content	Remarks
A-B repeat	RAM DVD-R DVD-V You can repeat a section between points A and B within a program or title. [ENTER] (start point) → [ENTER] (finish point) To cancel: [ENTER]	<ul style="list-style-type: none"> <li>• A-B repeat does not work if the disc's elapsed play time is not shown on the unit's display.</li> <li>• The unit automatically determines the end of a program/title as point B when the end of the program/title is reached.</li> <li>• Some subtitles recorded around point A or B may fail to appear.</li> <li>• This does not work while playing a play list.</li> </ul>
Repeat play	Each time you press [▲, ▼]: RAM DVD-R DVD-V PRG: Program Chapter ALL: OFF Title PL: Play list (RAM) CD VCD Track OFF All OFF	<ul style="list-style-type: none"> <li>• Repeat play does not work if the disc's elapsed play time is not shown on the unit's display.</li> </ul> <p><b>If the Video CD has playback control</b></p> <ol style="list-style-type: none"> <li>① While stopped (the screen saver is on the television), press the numbered buttons to select a track (→page 23).</li> <li>② Select the repeat mode.</li> </ol>
Marker	RAM DVD-R DVD-V CD VCD (→page 25)	—
Play mode	CD VCD ----: normal play Program Play (→page 24) Random Play (→page 24)	—

### Audio menu

RAM DVD-R DVD-V

e.g., DVD-Video

Disc	V. S. S.	OFF
Play	Dialog Enhancer	OFF
Video		
Audio		

Item	Content	Remarks
V.S.S.	RAM DVD-R DVD-V (Only with Dolby Digital with 2 or more channels) Enjoy a surround-like effect if you are using two front speakers only. The effect is broadened and sound seems to come from virtual speakers on either side if the disc has surround signals recorded on it. Natural ↔ Emphasis ↔ OFF	<ul style="list-style-type: none"> <li>• Turn off the surround effects on the other equipment.</li> <li>• V.S.S. will not work, or will have less effect, with some discs.</li> <li>• Turn V.S.S. off if it causes distortion.</li> </ul>
Dialog Enhancer	DVD-V (Dolby Digital, 3-channel or over only, including a center channel) The volume of the center channel is raised to make dialog easier to hear. ON ↔ OFF	—

Video menu

RAM DVD-R DVD-V VCD

Disc	Picture	Normal
Play	MPEG-DNR	ON
Video		
Audio		

Item	Content
Picture	<p><b>Normal:</b> Soft picture with fewer video artifacts</p> <p><b>Soft:</b> Soft picture with fewer video artifacts</p> <p><b>Fine:</b> Details are sharper</p> <p><b>Cinema:</b> Mellows movies, enhances detail in dark scenes.</p> <p><b>User:</b> You can make further adjustments. See below.</p>
MPEG-DNR	<p>(When any item other than "User" is selected)</p> <p>You can turn on and off the recommended settings for 3D NR, block NR, and mosquito NR.</p> <p>ON ↔ OFF</p>

■ When you have set "TV Type" to "480P" in SETUP (→page 14)

Disc	Picture	Normal
Play	MPEG-DNR	ON
Video	Progressive	ON
Audio	Transfer	Auto 1

Item	Content
Progressive	<p><b>ON:</b> Enables progressive output</p> <p><b>OFF:</b> Disables progressive output</p>
Transfer*	<p>Select the method of conversion for progressive output to suit the type of material being played (→page 57, Film and video).</p> <p><b>Auto1 (normal):</b> For film material</p> <p><b>Auto2:</b> For film material (the same as Auto1, but able to convert 30-frame-per-second progressive video.)</p> <p><b>Video:</b> For video material</p>

\* Only applicable in cases where the "Progressive" function is ON.

■ Regarding Progressive Television Picture

Progressive image aspect (height to width ratio) is set at a standard 16:9. DVD video which has been set at 16:9 will be displayed correctly. However, 4:3 video material (→ below) will be stretched to the right and left when displayed.

To view the picture at the right aspect

- For televisions that allow the aspect of progressive images to be adjusted, use the function provided on the television and adjust as necessary.
- For televisions which do not allow the aspect of progressive images to be adjusted, please turn OFF "Progressive".

4:3 video materials are usually found

- In general television broadcasts (excluding some wide picture broadcasts) and any pictures from discs that recorded such programs.
- In DVDs with a lateral ratio of 4:3 indicated on the jacket.
- Video CD pictures

■ When "User" is selected

Select "Detail picture adjustment".  
("User" → [◀] → [▼] → [ENTER])

Disc	Pic	1/2	Contrast	0	←	→
Play	Det		Brightness	0	←	→
Video			Sharpness	0	←	→
Audio			Color	0	←	→

Page 1/2 of "Detail picture adjustment"

Contrast	Increases the contrast between light and dark parts of the picture (-7 to +7).
Brightness	Brightens the picture (0 to +15).
Sharpness	Adjust the sharpness of the edges of the vertical lines (-6 to +6).
Color	Adjusts the shade of the picture's color (-7 to +7).

Press [ENTER] to enter the setting.

Press [▲] or [▼] until page 2/2 appears.

Disc	Pic	2/2	Gamma	0	←	→
Play	Det		3D NR	0	←	→
Video			Block NR	0	←	→
Audio			Mosquito NR	0	←	→

Page 2/2 of "Detail picture adjustment"

Gamma	Increases the brightness of the center ranges to improve detail and contrast in dark scenes (0 to +5).
3D NR	Reduces overall noise (0 to +4).
Block NR	Smooths block noise (0 to +3).
Mosquito NR	Reduces the smudging that appears around contrasting sections of the picture (0 to +3).

Press [ENTER] to enter the setting.

Refer to the relevant pages for details.

Enjoying CATV broadcasts

What you want to do	How to do it	Reference pages	Settings	Reference pages
Enjoying CATV broadcasts	Connect a cable TV box or satellite receiver.	46	Tune to channels correctly.	55
			Change the necessary settings on the equipment you have connected.	—

Enjoying more powerful sound

<p><b>Enjoying 5.1-channel surround sound with Dolby Digital and DTS</b></p>	<p><b>Digital connection</b> Connect to an amplifier with built-in decoders.</p> <p>47 <b>A</b></p>	<p><b>SETUP—Audio—Digital Audio Output</b></p> <ul style="list-style-type: none"> <li>• Set PCM Down Conversion to suit the equipment.</li> <li>• Set Dolby Digital and DTS to suit the equipment.</li> </ul> <p>Change speaker settings on the amplifier.</p> <p>51 —</p>
<p><b>Enjoying stereo or Dolby Pro Logic</b></p>	<p><b>Analog connection</b> Connect to an analog amplifier or system component.</p> <p>47 <b>B</b></p>	<p><b>SETUP—Audio—Digital Audio Output</b></p> <ul style="list-style-type: none"> <li>• Set PCM Down Conversion to Off.</li> </ul> <p>51</p>
	<p><b>Digital connection</b> Connect to a digital amplifier or system component.</p> <p>47 <b>A</b></p>	<p><b>SETUP—Audio—Digital Audio Output</b></p> <ul style="list-style-type: none"> <li>• Set PCM Down Conversion to suit the equipment.</li> <li>• Set Dolby Digital to PCM.</li> <li>• Set DTS to Off.</li> </ul> <p>51</p>

Other uses

Record to digital recording equipment or cassette deck (→page 47)  
Record from a video cassette recorder (→page 29)

- The equipment connections described are examples.
- Peripheral equipment and optional cables sold separately unless otherwise indicated.
- Before connection, turn off all equipment and read the appropriate operating instructions.
- The signal from the cable TV box or satellite receiver passes through this unit to the television even when this unit is turned off.

### Connecting a cable TV box/satellite receiver

You need to subscribe to a cable TV or satellite TV service, to enjoy viewing their programming.

- Consult your service provider regarding appropriate cable box or satellite receiver.
- Select the applicable input on your television to view the output from your cable box or satellite receiver, Channel 3 or 4 if connected via antenna (RF), or the applicable video input on the television is connected using the audio and video connections.



#### One cable TV box/satellite receiver

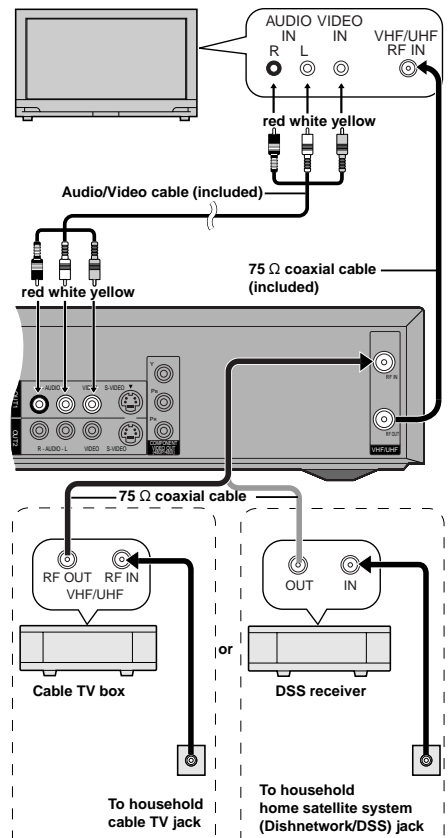

**Note**  
When a home satellite system (Dishnetwork/DSS) is connected, auto tuning and auto clock setting may not operate properly. Set the clock manually (→page 54).

**You cannot**

- view channels other than the one selected when recording.
- do a timer recording unless the channel is first selected on the cable TV box or DSS receiver.

#### Two cable TV boxes

- You can record and view both scrambled and unscrambled channels if connections are made as shown in the diagram below.

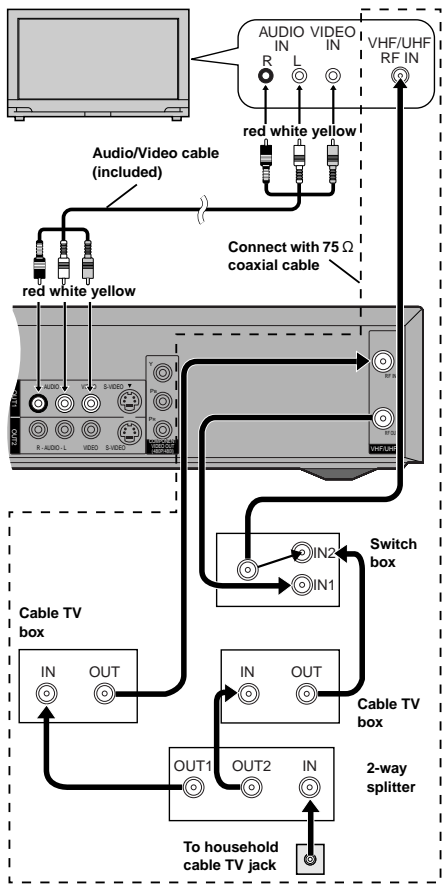

**You cannot**

- view channels other than the one selected when recording.
- do a timer recording unless the channel is first selected on the cable TV box.

Advanced operation

### Connecting an amplifier or system component

This model can play Dolby Digital, but only in two channels. This model does not have a DTS decoder. You must connect a unit with a Dolby Digital or DTS decoder to enjoy surround sound.



#### A Digital connection

**To enjoy multi-channel surround sound**

Connect an amplifier with a built-in decoder or a decoder-amplifier combination.

- Change the settings in "Digital Audio Output" (→page 51).

**Note**

You cannot use DTS Digital Surround decoders not suited to DVD.

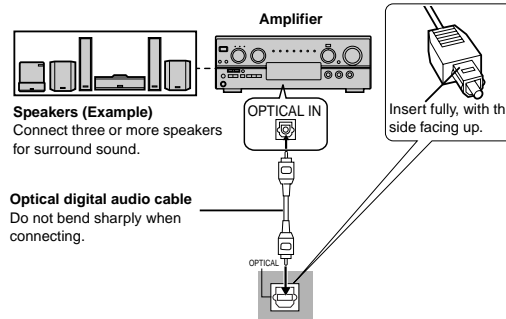

**Speakers (Example)**  
Connect three or more speakers for surround sound.

**Optical digital audio cable**  
Do not bend sharply when connecting.

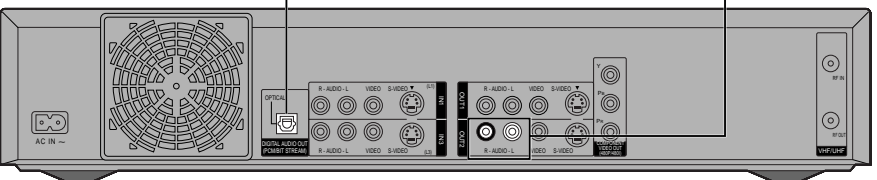

#### Recording to digital recording equipment or cassette tapes

**Digital recording**

You can record the digital signal directly to digital recording equipment (→ Connection A above).

**Note**

- With DVD, the following conditions must be met: (a) the disc doesn't have protection preventing digital recording, and (b) the recording equipment can handle signals with a sampling frequency of 48 kHz.
- You cannot record DTS signals.

When recording DVDs, make the following settings.

- V.S.S.: OFF (→page 43)
- PCM Down Conversion: On (→page 51)
- Dolby Digital: PCM (→page 51)
- DTS: Off (→page 51)

#### B Analog connection

**To enjoy stereo or Dolby Pro Logic**

Connect an analog amplifier or system component.

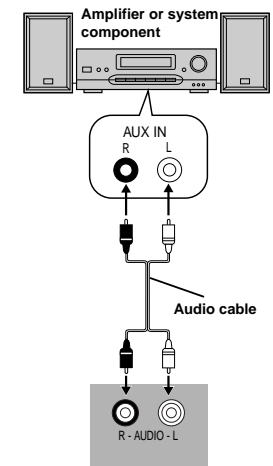

**Analog recording**

You can record to a cassette deck or other recording equipment (→ Connection B above).

There are no limitations on recording analog signals as there are with digital signals.

Advanced operation



Connecting other video equipment



Connecting to the L2 input terminals on the front of the unit

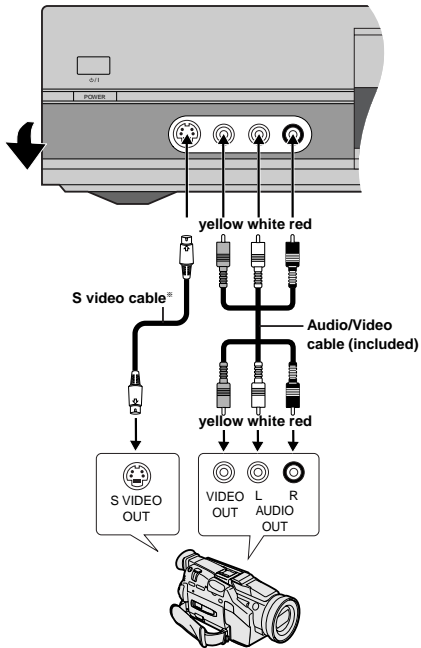

**Other video equipment**  
Connect to the video and audio output terminals.

\* By using the S video cable instead of the yellow video cable you may make recordings of higher picture quality.

**Note**

• If the audio output of the other equipment is monaural, connect to L/MONO. (Both left and right channels are recorded when connected through L/MONO.)

Connecting to the input terminals on the rear of the unit, L1 and L3

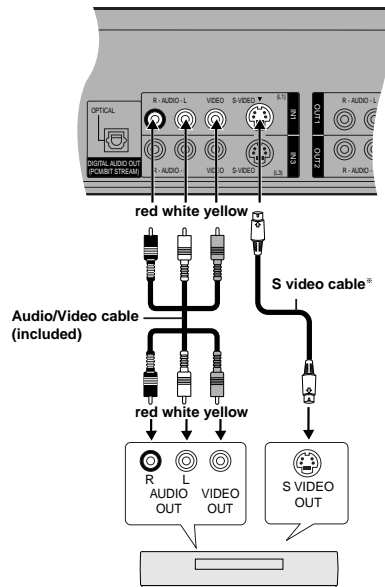

**Other video equipment**  
Connect to the video and audio output terminals.

\* By using the S video cable instead of the yellow video cable you may make recordings of higher picture quality.

**Note**

• If audio output on the other equipment is monaural, use a stereo-monaural conversion cable (not included).

Other antenna connections

Other antenna connection to the unit

Use one of the following connections to suit the antenna lead.

■ A single twin lead

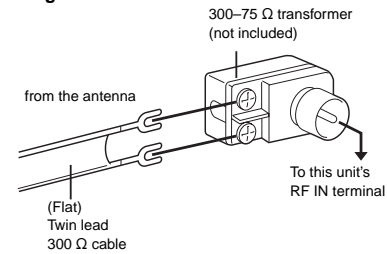

■ A twin lead and a coaxial cable

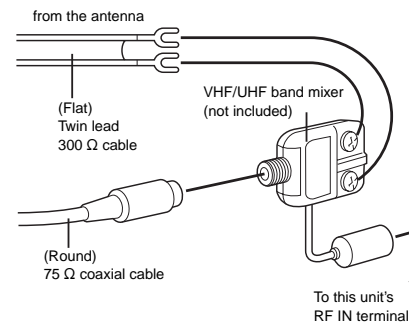

■ Two twin leads

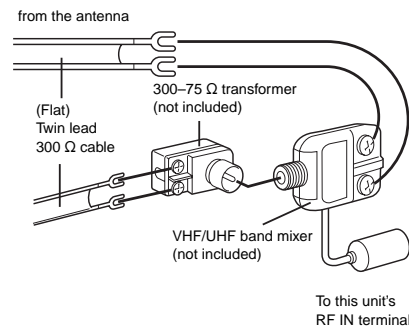

• If your television has both lead and coaxial VHF terminals, use the lead connection to minimize signal loss.

Other antenna connection from the unit to the television

Use one of the following connections to suit the antenna terminals on your television. Refer to the television's operating instructions.

■ A twin lead and coaxial plug terminal

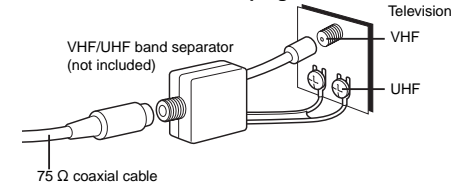

■ A twin lead terminal

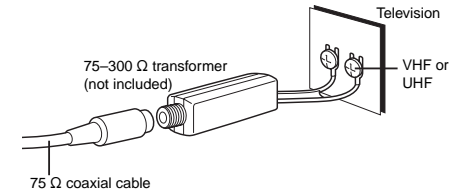

■ Two twin lead terminals

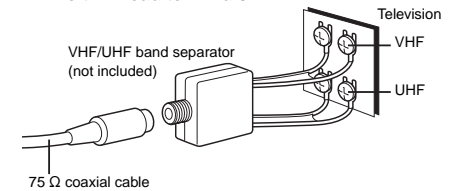

■ Multiple antenna terminals

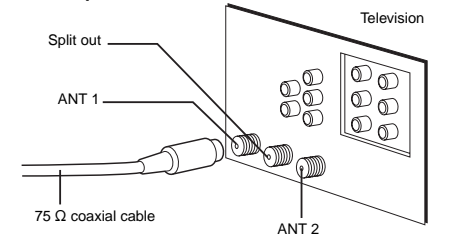

• Connect to one of the terminals, then change the television's setting as necessary.

Advanced operation

Advanced operation

## Changing the remote control code

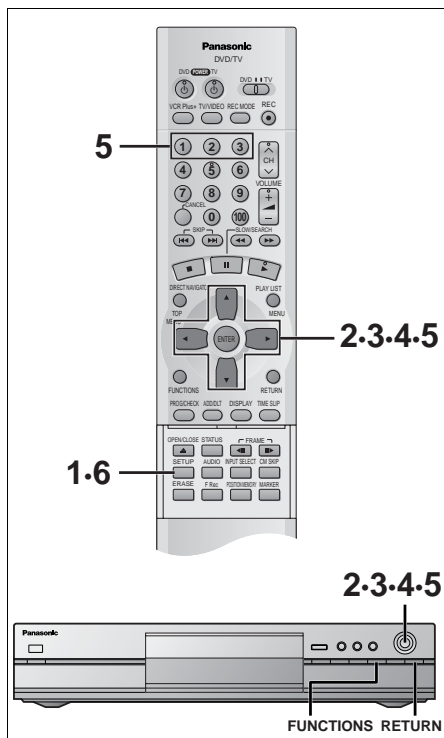

### 1 Press [SETUP] to show the menus.

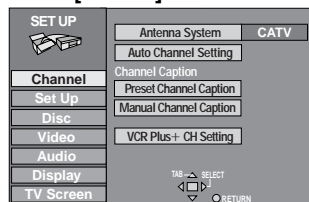

### 2 Press [▲, ▼] to select "Set Up" and press [▶].

### 3 Press [▲, ▼] to select "Remote Control Code" and press [ENTER].

### 4 Press [▲, ▼] to select the code (1, 2, or 3) and press [ENTER].

The remote control code on the unit has been set.

### 5 While pressing [ENTER] on the remote control, press the numbered button ([1], [2] or [3]) corresponding to the code you selected in step 4.

The remote control code on the remote control has been set.

### 6 Press [SETUP]

If the unit doesn't respond, you have entered the wrong code. Repeat step 5 to enter the correct code.

#### Note

- The following display appears on the unit's display if its code and the remote control's code are different. Change the remote control's code to suit the unit. The display disappears after about 5 seconds.



The unit's remote control code

- You can also set the main unit's code without using the remote control.

- Press [FUNCTIONS] on the main unit.
- Press [▲, ▼, ◀, ▶] to select "SETUP" and press [ENTER].
- Carry out procedure 2-4 above.
- Press [RETURN].

## Changing the unit's settings

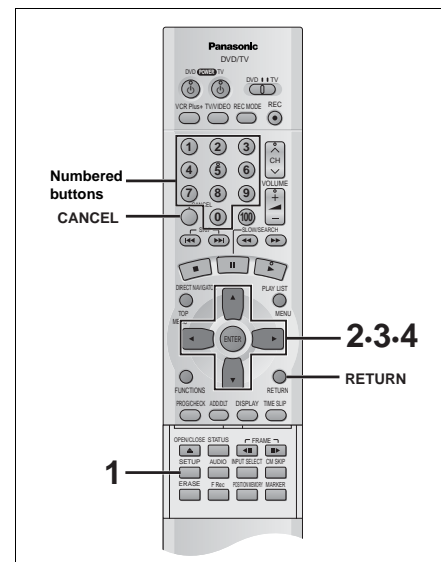

### Entering a password (Ratings)

#### DVD-V

The password screen is shown when you select levels 0 to 7.

- Input a 4-digit password with the numbered buttons.
  - If you enter a wrong number, press [CANCEL] to erase it.
- Press [ENTER].
  - The lock symbol appears closed to show the rating is locked.
  - Do not forget your password.
- Press [ENTER] to confirm the 4 digits.

Now, when you insert a DVD-Video that exceeds the ratings limit you set, a message appears on the television. Follow the on-screen instructions.

### Digital Audio Output

#### DVD-V

Change the settings when you have connected equipment through this unit's DIGITAL AUDIO OUT terminal (→page 47, **A**).

Select the "Audio" tab and then "Digital Audio Output" by following "Common procedures" (→ left) to set up "PCM Down Conversion", "Dolby Digital" and "DTS".

#### PCM Down Conversion

Select how to output audio with a sampling frequency of 96 kHz. Select "On" if the equipment you connect cannot process signals with a sampling frequency of 96 kHz.

- Select "Off" if you use analog connect irrespective of the type of equipment.

**Off** (Factory preset):  
Output as 96 kHz. There is no output if the disc has copy protection. Select "On" in this case.

**On:**  
Converted to 48 kHz for output.

#### Dolby Digital and DTS

**Bitstream** (Factory preset for Dolby Digital):  
Select if the equipment you connected can decode the signal.

**PCM:**  
Select if the equipment you connected cannot decode Dolby Digital signal.

**Off** (Factory preset for DTS):  
Select if the equipment you connected cannot decode DTS signal.

**IMPORTANT**  
If the equipment you connected cannot decode the signal, the setting must be changed to PCM or Off. If not, signals the equipment cannot process will be output by this unit, causing high levels of noise which can damage your hearing and the speakers.

### Common procedures

See page 52 for menu and option details.

### 1 Press [SETUP] to show the menus.

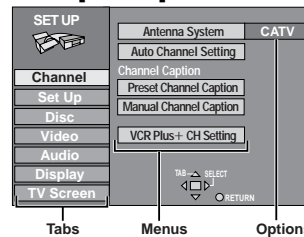

### 2 Press [▲, ▼] to select the menu's tab and press [▶].

### 3 Press [▲, ▼] to select the menu and press [ENTER].

### 4 Press [▲, ▼] to select the option and press [ENTER].

The screen now shows the menu again.

- Some items require different operations. Read the following explanations.

#### To return to the previous screen

Press [RETURN].

#### When you are finished

Press [SETUP].

## Changing the unit's settings

### Summary of settings

This chart shows the initial settings for this unit. See page 51 for details on menu operation.

• Underlined items are the factory presets.

Tabs	Menus	Options
<b>Channel</b>	<b>Antenna System (→page 12)</b> Select to suit the type of antenna you are using. Channels are set corresponding to the antenna system you select.	•TV      •CATV
	<b>Auto Channel Setting (→page 55)</b> The unit sets the channels automatically.	
	<b>Preset Channel Caption (→page 55)</b> You can give preset captions to the channels.	
	<b>Manual Channel Caption (→page 55)</b> You can set channel captions manually.	
	<b>VCR Plus+ CH Setting (→page 13)</b> Set the guide channels for use with VCR Plus+ timer recording.	
<b>Set Up</b>	<b>Off Timer</b> Select how long the unit remains on when it is not being used.	•2 hr      •6 hr      •Off
	<b>Remote Control Code (→page 50)</b> To avoid operating equipment other than the one intended (when more than one remote controlled item is in the same area), change the remote control code.	•Set Code 1    •Set Code 2    •Set Code 3
	<b>Auto Clock Setting (→page 54)</b> The unit adjusts the clock automatically.	
	<b>Manual Clock Setting (→page 54)</b> You can adjust the clock.	
	<b>Time Zone Adjust (→page 54)</b> Adjust the time zone if it was not set correctly after auto clock setting. This appears only after auto clock setting is complete.	•-1      •0      •+1
	<b>Re-initialize Setting</b> This returns all values in the SETUP menus, except for the clock, channel settings, ratings level, and display language, to the default settings.	•Yes      •No
	<b>Audio</b> Choose the audio language.	Some discs start in a certain language despite any changes you make here. •English      •French      •Spanish •Original: The original language of each disc will be selected. •Other ****: Input a code (→page 57).
<b>Subtitle</b> Choose the subtitle language.	•Automatic: If the language selected for "Audio" is not available, subtitles of that language will automatically appear if available on that disc. •English      •French      •Spanish      •Other ****	
<b>Menus</b> Choose the language for disc menus.	•English      •French      •Spanish      •Other ****	
<b>Ratings (→page 51)</b> Set a ratings level to limit DVD-Video play. The password screen is shown when you select levels 0 to 7.	<b>Setting ratings (When level 8 is selected)</b> 8 No Limit: All DVD-Video can be played. 1 to 7: Prohibits play of DVD-Video with corresponding ratings recorded on them. 0 Lock All: Prohibits play of all DVD-Video.	
	<b>Changing ratings (When level 0-7 is selected)</b> •Unlock Recorder      •Change Password •Change Level      •Temporary Unlock	
<b>Video</b>	<b>3-D Y/C Separation</b> Turn 3-D Y/C separation on or off.	•On: Reduces noise for recording by separating the luminance (Y) and color (C) signals received from the television station. •Off: Reduces the ghosting that occurs when recording fast moving images.
	<b>Hybrid VBR Resolution</b> Switch between automatic and fixed hybrid VBR resolution when recording.	•Automatic: The unit automatically switches resolution rates during recording. The unit reduces block noise, which occurs during MPEG compression, by selecting the optimum rate. •Fixed: The resolution rate is fixed to ensure the resolution rate is not reduced.

Tabs	Menus	Options
<b>Video</b>	<b>Still Mode</b> Select the type of picture shown when you pause play.	•Automatic •Field: Less blurred field stills are shown. Select if jittering occurs when "Automatic" is selected. •Frame: Sharper frame stills are shown. Select if small text or fine patterns cannot be seen clearly when "Automatic" is selected.
	<b>Seamless Play</b> Turn seamless play on or off on discs with play lists. •Seamless Play does not effect programs that have been recorded with LPCM sound.	•On: The scenes in play lists are played seamlessly. This may cause shifting of the points where scenes change. Some play lists cannot be played seamlessly. •Off: The points where scenes in play lists change are played accurately, but the picture may freeze for a moment.
<b>Audio</b>	<b>Audio during Search</b> <b>RAM</b> <b>DVD-R</b> <b>DVD-V</b> <b>VCD</b> Choose whether to have sound during the first level of fast-forward.	•On      •Off
	<b>D. Range Compression</b> <b>DVD-V</b> (Dolby Digital only) Change the dynamic range for late night viewing.	•On      •Off
	<b>Select MTS for DVD-R or LPCM (→page 26)</b> Select whether to record the main or secondary audio type (SAP) when recording to DVD-R or when recording using LPCM sound ("Audio Mode for XP Recording" → below).	•Main      •SAP
	<b>Audio Mode for XP Recording</b> Choose the audio type when recording with XP mode. •Sound recordings made using LPCM require more information than usual. Consequently the picture quality of LPCM recordings may be less than that of normal XP mode recordings.	•Dolby Digital (→page 57)      •LPCM (→page 57)
	<b>Digital Audio Output (→page 51)</b>	
	<b>PCM Down Conversion</b>	•On      •Off
	<b>Dolby Digital</b>	•Bitstream      •PCM
<b>DTS</b>	•Bitstream      •Off	
<b>Display</b>	<b>Status Messages</b> Choose whether to show on-screen messages automatically.	•Automatic      •Off
	<b>Language of Display Message</b> Choose the language for these menus and the on-screen messages.	•English      •Français
	<b>Blue Background</b> Select "Off" if you do not want to have the unit show the blue background when reception is weak.	•On      •Off
	<b>FL Display</b> Changes the brightness of the unit's display.	•Bright      •Dim •Dim during Play: The display dims during video playback. •Automatic: The display dims during video playback and goes off completely when the unit is turned off or on timer recording standby. If you press a button the display will brighten briefly. (At this time the power consumed will be 0.6 W.)
<b>TV Screen</b>	<b>TV Aspect (→page 14)</b> Choose the setting to suit your television.	•4:3      •16:9
	<b>TV Type (→page 14)</b> Choose "480P" to enable progressive output.	•480i      •480P
	<b>4:3 TV Settings for DVD-Video</b> Select how DVD-Video widescreen picture is shown on a 4:3 standard aspect television.	•Pan & Scan (→page 57): Video recorded for a widescreen is played as Pan & Scan (unless prohibited by the producer of the disc). •Letterbox (→page 57): Video recorded for a widescreen is played in the letterbox style.
	<b>4:3 TV Settings for DVD-RAM</b> Select how DVD-RAM widescreen picture is shown on a 4:3 standard aspect television.	•4:3: Programs played as recorded. •Pan & Scan: Video recorded for a widescreen is played as Pan & Scan. •Letterbox: Video recorded for a widescreen is played in the letterbox style.

## Changing the unit's settings

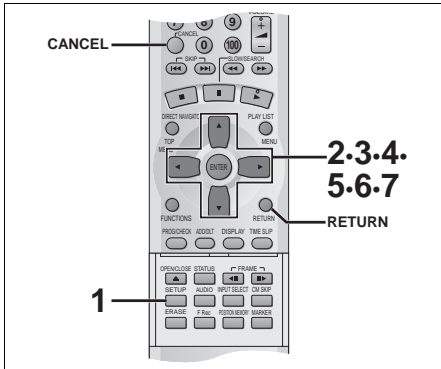

### Clock Settings

- 1 Press [SETUP] to show the menus.
- 2 Press [▲, ▼] to select "Set Up" and press [▶].

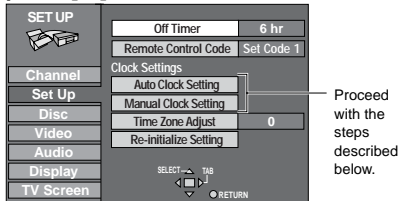

Proceed with the steps described below.

#### Auto Clock Setting

- 3 Press [▲, ▼] to select "Auto Clock Setting" and press [ENTER].

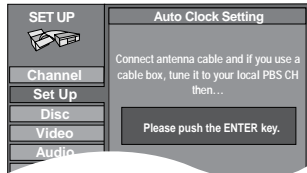

If you have not yet set channels, the "Auto Channel/Clock Setting" screen appears.

- 4 Press [ENTER].

Auto setting starts. This can take some time, up to a few hours in some cases. (To stop auto clock setting, press [RETURN].) The following screen appears when setting is complete. Press [ENTER].

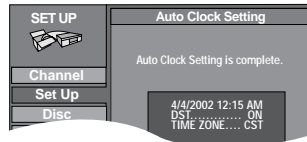

- If the time was not set correctly, use manual clock setting or time zone adjust.
- If you connect the unit through a cable TV box or DSS receiver (→page 46), tune to your local PBS station before starting auto clock setting. Use manual clock setting if this does not work or if there is no local PBS channel in your area.

- DST, Daylight Saving Time, shows the summertime setting.
- TIME ZONE shows the time difference from Greenwich meantime (GMT).  
EST=GMT -5, CST=GMT -6, MST=GMT -7, PST=GMT -8,  
AST=GMT -9, HST=GMT -10, For other areas: xx hr

#### Manual Clock Setting

- 3 Press [▲, ▼] to select "Manual Clock Setting" and press [ENTER].

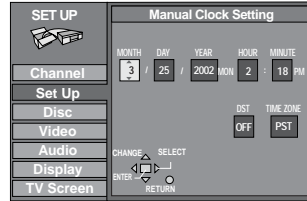

- 4 Press [◀, ▶] to select the item you want to change and press [▲, ▼] to change the setting.

MONTH ← DAY ← YEAR ← HOUR (12-hour display)  
TIME ZONE ← DST ← MINUTE ←

DST (Daylight Saving Time): ON or OFF

If you select "ON", the clock is advanced one hour starting at 2 a.m. on the first Sunday in April and ending at 2 a.m. on the last Sunday in October.

TIME ZONE:

EST ← CST ← MST ← PST ← AST ← HST  
(-5) (-6) (-7) (-8) (-9) (-10)

- 5 Press [ENTER].

The "Set Up" screen (→step 2) reappears and the clock starts.

#### Note

When you change the time zone, the recording times for programs recorded before the time zone was changed also change to correspond to the new time zone.

#### Time Zone Adjust

Adjust the time zone (-1 or +1) if it was not set correctly with auto clock setting.

You cannot change this setting if you set the clock manually.

- 3 Press [▲, ▼] to select "Time Zone Adjust" and press [ENTER].

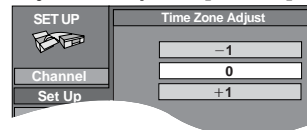

- 4 Press [▲, ▼] to select "-1", "0", or "+1" and press [ENTER].

The "Set Up" screen (→ step 2) reappears.

### Channel Settings

- 1 Press [SETUP] to show the menus.
- 2 Press [▲, ▼] to select "Channel" and press [▶].

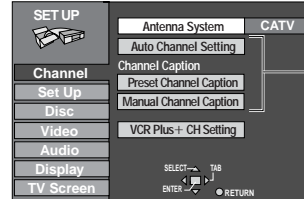

Proceed with the steps described below.

#### Auto Channel Setting

Check the antenna system. Automatic setting is performed based on the current antenna system (→page 12).

- 3 Press [▲, ▼] to select "Auto Channel Setting" and press [ENTER].

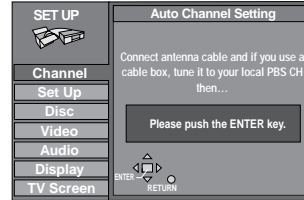

If you have not yet set clock, the "Auto Channel/Clock Setting" screen appears.

- 4 Press [ENTER].

Auto setting starts. This takes a few minutes. (To stop auto channel setting, press [RETURN].) When finished, the Complete screen or time display is shown. Press [ENTER].

#### Preset Channel Caption

- 3 Press [▲, ▼] to select "Preset Channel Caption" and press [ENTER].

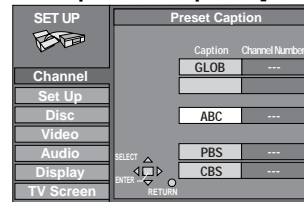

- 4 Press [▲, ▼] to select the caption and then press [▶].

- The screen scrolls a page at a time if you press and hold [▲, ▼].

You can choose from the following captions.  
ABC, PBS, CBS, CNN, FOX, ESPN, NBC, HBO, A&E, AMC, FAM, MAX, MTV, SHOW, TBS, USA, TNT, CBC, UPN, CTV, WB, TSN, DSC, GLOB

- 5 Press [▲, ▼] to select the channel corresponding to the caption and then press [◀].

- Channels are not displayed if they do not contain a station or if captions have been added manually.

- To delete the channel number, press [CANCEL].
- Repeat steps 4 and 5 as necessary.

- 6 Press [ENTER].

The "Channel" screen reappears.

#### Manual Channel Caption

- 3 Press [▲, ▼] to select "Manual Channel Caption" and press [ENTER].

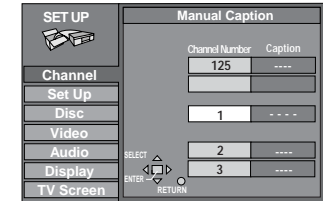

- 4 Press [▲, ▼] to select the channel and then press [▶].

- Channels are not displayed if they do not contain a station or if preset captions have been added.

- 5 Press [▲, ▼] to select the first character and then press [▶].

- You can choose from the following characters:  
A-Z, 0-9, -, &, !, /, (space)

- To delete the caption, press [CANCEL].
- Repeat step 5 to enter the other characters.

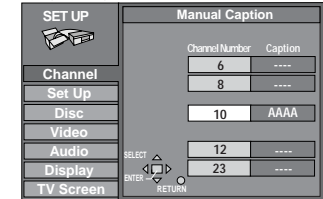

- 6 Press [◀] to return to the Channel Number column when you are finished.

Repeat steps 4, 5, and 6 as necessary.

- 7 Press [ENTER].

The "Channel" screen reappears.

## On-screen displays

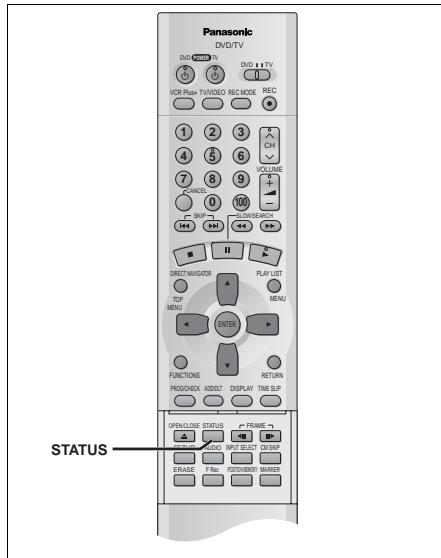

### Changing the information displayed

Displays appear on the television when you operate the unit to let you know what operation was performed and what condition the unit is in.

- You can change the setting in the SETUP menu so these displays do not appear automatically (→page 53, Display—Status Messages).

### Press [STATUS].

The display changes each time you press the button. For example, DVD-RAM

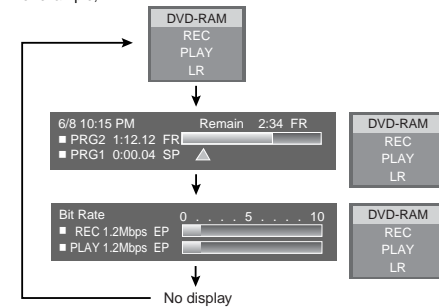

### Display examples

#### Current recording or play status/input channel and caption (if entered)

- REC:Recording
- PAUSE:Recording paused
- PLAY:Playing
- II: Playing paused
- ◀◀:Rewinding
- ▶▶:Fast forwarding
- ⏪: Slow-motion
- ⏩: Reverse slow-motion

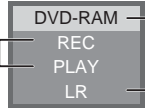

#### Current media

##### Audio type (→page 26)

- Shows the selected audio type.
  - During reception
    - Stereo:Stereo is selected
    - Mono:Monaural is selected
    - SAP:Secondary audio program is selected ("I" appears when the type you have selected is actually being received.)
  - During play
    - LR, R, L:a stereo program is recorded
    - MAIN, SAP:an SAP program is recorded

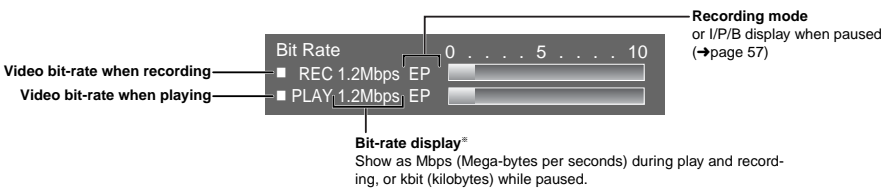
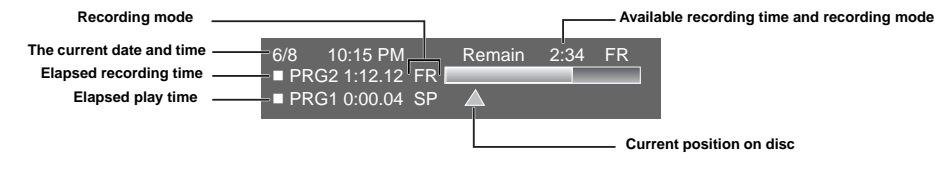

\*The method of calculating bit-rate for recording and playing is different so there may be differences in the figures displayed. (Values are approximate.)

## Glossary

### Bitstream

This is the digital form of multi-channel audio data (e.g., 5.1 channel) before it is decoded into its various channels.

### Decoder

A decoder restores the coded audio signals on DVDs to normal. This is called decoding.

### Dolby Digital

This is a method of coding digital signals developed by Dolby Laboratories. Apart from stereo (2-channel) audio, these signals can also be multi-channel audio. A large amount of audio information can be recorded on one disc using this method.

This unit is set to record using Dolby Digital in all recording modes except for XP mode, where you may choose Dolby Digital or LPCM.

### Dolby Pro Logic

A surround system where a 4-channel audio track is recorded as 2 channels and then is restored to 4 channels for play. The surround channel is monaural and can reproduce up to 7 kHz.

### DTS (Digital Theater Systems)

This surround system is used in many movie theaters around the world. There is good separation between the channels, so realistic sound effects are possible.

### Dynamic range

Dynamic range is the difference between the lowest level of sound that can be heard above the noise of the equipment and the highest level of sound before distortion occurs.

### Film and video

DVD-Videos are recorded using either film or video. Usually, film is recorded at 24 frames per second, the rate movies are filmed at, while video is recorded at 30 frames per second.

### Frame still and field still

Frames are the still pictures that go together to make a moving picture. There are about 30 frames shown each second.

One frame is made up of two fields. A regular television shows these fields one after the other to create frames.

A field still is shown when you pause a moving picture. A frame still is made up of two alternating fields, so the picture may appear blurred, but overall quality is high.

A field still is not blurred, but it has only half the information of a frame still so picture quality is lower.

### Interlace and progressive output

NTSC, the video signal standard, has 480 interlaced (i) scan lines, whereas progressive scanning uses twice the number of scan lines. This is called 480p. The video signals output from this unit's COMPONENT VIDEO OUT terminals (Y, Pb, Pr) allow you to enjoy higher quality pictures than if the signals were output from the VIDEO OUT terminal or S VIDEO OUT terminal.

### I/P/B

MPEG 2, the video compression standard adopted for use with DVD-Video, codes frames using these 3 picture types.

#### I: Intra coded picture

This picture has the best quality and is the best to use when adjusting the picture.

#### P: Predictive coded picture

This picture is calculated based on past I- or P-pictures.

#### B: Bidirectionally-predictive coded picture

This picture is calculated by comparing past and future I- and P-pictures so it has the lowest volume of information.

### Linear PCM (pulse code modulation)

These are uncompressed digital signals. LPCM sound is available when recording in XP mode.

### Playback control (PBC)

If a Video CD has playback control, you can select scenes and information with menus.

### Pan&Scan/Letterbox

In general, DVD-Video are produced with the intention that they be viewed on a widescreen television with an aspect ratio of 16:9. This means you can view most material with the intended aspect ratio on a widescreen television.

Material with this ratio will not fit onto a standard television with an aspect ratio of 4:3. Two styles of picture, "Pan&Scan" and "Letterbox", deal with this problem.

Pan&Scan: The sides are cut off so the picture fills the screen.



Letterbox: Black bands appear at the top and bottom of the picture so the picture itself appears in an aspect ratio of 16:9.



### Language code list Input the code with numbered buttons.

Abkhazian: 6566	Chinese: 9072	Hausa: 7265	Lithuanian: 7684	Romanian: 8279	Telugu: 8469
Afar: 6565	Corsican: 6779	Hebrew: 7387	Macedonian: 7775	Russian: 8285	Thai: 8472
Afrikaans: 6570	Croatian: 7282	Hindi: 7273	Malagasy: 7771	Samoa: 8377	Tibetan: 6679
Albanian: 8381	Czech: 6783	Hungarian: 7285	Malay: 7783	Sanskrit: 8365	Tigrinya: 8473
Ameharic: 6577	Danish: 6865	Icelandic: 7383	Malayalam: 7776	Scots Gaelic: 7168	Tonga: 8479
Arabic: 6582	Dutch: 7876	Indonesian: 7378	Maltese: 7784	Serbian: 8382	Turkish: 8482
Armenian: 7289	English: 6978	Interlingua: 7365	Maori: 7773	Serbo-Croatian:8372	Turkmen: 8475
Assamese: 6583	Esperanto: 6979	Irish: 7165	Marathi: 7782	Shona: 8378	Twi: 8487
Aymara: 6588	Estonian: 6984	Italian: 7384	Maori: 7773	Sindhi: 8368	Ukrainian: 8575
Azerbaijani: 6590	Faroese: 7079	Japanese: 7465	Mongolian: 7778	Singhalese: 8373	Urdu: 8582
Bashkir: 6665	Fiji: 7074	Javanese: 7487	Nauru: 7865	Slovak: 8375	Uzbek: 8590
Basque: 6985	Finnish: 7073	Kannada: 7578	Nepali: 7869	Slovenian: 8376	Vietnamese: 8673
Bengali, Bangla:6678	French: 7082	Kashmiri: 7583	Norwegian: 7879	Somali: 8379	Volapük: 8679
Bhutani: 6890	Frisian: 7089	Kazakh: 7575	Oriya: 7982	Spanish: 6983	Welsh: 6789
Bihari: 6672	Galician: 7176	Kirghiz: 7589	Pashto, Pushto:8083	Sundanese: 8385	Wolof: 8779
Breton: 6682	Georgian: 7565	Korean: 7579	Persian: 7065	Swahili: 8387	Xhosa: 8872
Bulgarian: 6671	German: 6869	Kurdish: 7585	Polish: 8076	Swedish: 8386	Yiddish: 7473
Burmese: 7789	Greek: 6976	Laotian: 7679	Portuguese: 8084	Tagalog: 8476	Yoruba: 8979
Byelorussian: 6669	Greenlandic: 7576	Latin: 7665	Punjabi: 8065	Tajik: 8471	Zulu: 9085
Cambodian: 7577	Guarani: 7178	Latvian, Lettish:7686	Quechua: 8185	Tamil: 8465	
Catalan: 6765	Gujarati: 7185	Lingala: 7678	Rhaeto-Romance:8277	Tatar: 8484	

## Error messages

### On the television

Page

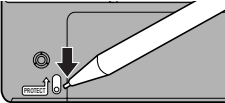
<b>No disc.</b>	<ul style="list-style-type: none"> <li>You haven't inserted a disc. Correctly insert a disc that this unit can use.</li> <li>The disc is upside down. If it is a single-sided disc, insert it so the label is facing up.</li> </ul>	8 17
<b>This is non-recordable disc.</b>	<ul style="list-style-type: none"> <li>The unit cannot record on the disc you inserted. The unit cannot record onto finalized DVD-R, DVD-Video, CDs, or video CDs. Insert a DVD-RAM or unfinalized DVD-R.</li> <li>You inserted an unformatted DVD-RAM. Format the disc with this unit.</li> </ul>	8
<b>This disc is not formatted properly. Please format the disc in 'DISC SETTING' to record.</b>		34
<b>This disc cannot be read.</b>	<ul style="list-style-type: none"> <li>You inserted an incompatible disc. Insert a compatible disc.</li> </ul>	8
<b>Please check write protect tab on the disc.</b>	<ul style="list-style-type: none"> <li>The write-protect tab on the cartridge is set to PROTECT. Use a ballpoint pen or similar to release the write protection.</li> </ul> 	—
<b>Contents of this disc are protected.</b>	<ul style="list-style-type: none"> <li>The program is write-protected. Release the protection with the Direct Navigator.</li> <li>The disc is write-protected. Release Disc Protection with DISC SETTING.</li> </ul>	36
		34
<b>Cannot finish recording completely.</b>	<ul style="list-style-type: none"> <li>The program was copy-guarded.</li> <li>The disc is full.</li> <li>Recording was not completed for some other reason.</li> </ul>	— — —
<b>Cannot record on the disc.</b>	<ul style="list-style-type: none"> <li>The disc is scratched. Use another disc.</li> <li>The disc is dirty.</li> </ul>	— 9
<b>Please set clock.</b>	<ul style="list-style-type: none"> <li>The clock is not set. Set the clock.</li> </ul>	54
<b>This disc may not be played in your region.</b>	<ul style="list-style-type: none"> <li>You tried to play a disc with a region number different from this unit's region number. This unit can only play discs with the region numbers compatible with this unit (1, All, or including the number 1).</li> </ul>	Cover page
<b>Your selection exceeds the recorder's rating limit.</b>	<ul style="list-style-type: none"> <li>A ratings level has been set for DVD-Video with this unit. Unlock the unit with "Ratings" in "Disc" in the SETUP menu.</li> </ul>	51

### On the unit's display

<b>U11 NO DISC</b>	<ul style="list-style-type: none"> <li>The disc is dirty or badly scratched. – Clean the disc if it is dirty. – The disc cannot be played if it is scratched and this display doesn't disappear.</li> <li>You have inserted a disc the unit cannot play or record on. – Insert a disc the unit can play or record on.</li> </ul>	9 — 8
<b>U14</b>	<ul style="list-style-type: none"> <li>The unit is hot. – The unit switches to standby automatically for safety reasons and you cannot operate it. Wait for about 30 minutes for the service number to disappear. – Select a position with good ventilation when installing the unit. – Do not block the cooling fan on the rear of the unit.</li> </ul> 	— — —
<b>U99</b>	<ul style="list-style-type: none"> <li>The unit fails to operate properly. – Press [⏻, DVD POWER] to switch the unit to standby. Now press [⏻, DVD POWER] again to turn the unit on.</li> </ul>	—
<b>CHK REMOTE</b>	<ul style="list-style-type: none"> <li>The remote control and main unit are using different codes. – Change the code on the remote control or main unit.</li> </ul>	50

## Maintenance

The precision parts in this unit are readily affected by the environment, especially temperature, humidity, and dust. Cigarette smoke also can cause malfunction or breakdown.

### To clean this unit, wipe with a soft, dry cloth.

- Never use alcohol, paint thinner or benzine to clean this unit.
- Before using chemically treated cloth, read the instructions that came with the cloth carefully.

### Observe the following points to ensure continued listening and viewing pleasure.

Dust and dirt may adhere to the unit's lens over time, making it impossible to record or play discs. Use **DVD-RAM/PD lens cleaner (LF-K123LCA1)** every 1 to 4 months, depending on frequency of use and the operating environment. Read the lens cleaner's instructions carefully before use.

## Troubleshooting guide

Before requesting service, make the below checks. If you are in doubt about some of the check points, or if the remedies indicated in the chart do not solve the problem:

**In the U.S.A., contact the Panasonic Customer Call Center at 1-800-211-7262, or e-mail [consumerproducts@panasonic.com](mailto:consumerproducts@panasonic.com), or web site (<http://www.panasonic.com>).**

**In Canada, contact Panasonic Canada Inc. Customer Care Centre at 1-800-561-5505, web site ([www.panasonic.ca](http://www.panasonic.ca)), or an authorized Servicentre closest to you.**

Power		Page
<b>No power.</b>	Insert the AC power supply cord securely into a known active AC outlet.	10
<b>The unit switches to the standby mode.</b>	<ul style="list-style-type: none"> <li>This is a power saving feature. You can turn it off if you would prefer (Set Up—Off Timer—Off). Press [⏻, DVD POWER] to turn the unit on.</li> <li>One of the unit's safety devices may have activated. Press [⏻, DVD POWER] to turn the unit on.</li> </ul>	52 —

Operation		Page
<b>The unit is on but cannot be operated.</b>	<ul style="list-style-type: none"> <li>The unit is hot ("U14" appears on the display). Wait for "U14" to disappear.</li> <li>One of the unit's safety devices may have activated. Reset the unit as follows:               <ol style="list-style-type: none"> <li>Press [⏻, DVD POWER] to switch the unit to standby. If the unit doesn't switch to standby, press and hold [⏻, DVD POWER] for about 10 seconds. The unit is forcibly switched to standby. Alternatively, disconnect the AC power supply cord, wait one minute, then reconnect it.</li> <li>Press [⏻, DVD POWER] to turn the unit on.</li> </ol> </li> </ul>	58 —

Picture		Page
<ul style="list-style-type: none"> <li>When progressive output is on, refer also to the section listed under "Progressive video" below.</li> </ul>		
<b>The images from this unit do not appear on the television.</b>	<ul style="list-style-type: none"> <li>Make sure the television is connected to the AUDIO/VIDEO terminal, S-VIDEO OUT terminal or COMPONENT VIDEO OUT terminal on this unit.</li> <li>Make sure the television's input setting (e.g., VIDEO 1) is correct.</li> <li>You have set "TV Type" to "480P" in the SETUP menu, but the television isn't compatible with progressive signal. Press and hold [■] and [■] on the unit at the same time for about 5 seconds. The setting will change to interlace.</li> </ul>	10 — 14
<b>Television reception worsens after connecting the unit.</b>	<ul style="list-style-type: none"> <li>This can occur because the signals are being divided between the unit and the television. It can be solved by using a signal booster, available from audio-visual suppliers. Consult your dealer if reception does not improve.</li> </ul>	—
<b>Screen size is wrong.</b>	<ul style="list-style-type: none"> <li>Check the settings on your television.</li> <li>Check the settings for "TV Aspect", "4:3 TV Settings for DVD-Video" or "4:3 TV Settings for DVD-RAM" in the TV Screen SETUP menus.</li> </ul>	— 14, 53
<b>On-screen messages do not appear.</b>	<ul style="list-style-type: none"> <li>Go to Display in the SETUP menu and select "Automatic" for "Status Messages".</li> <li>Press [STATUS] to show the on-screen messages constantly.</li> </ul>	53 56
<b>The blue background does not appear.</b>	<ul style="list-style-type: none"> <li>Go to Display in the SETUP menu and select "On" for "Blue Background".</li> </ul>	53
<b>There is ghosting.</b>	<ul style="list-style-type: none"> <li>Change the settings for "3D NR", "Block NR", and "Mosquito NR" to "0" or turn "MPEG-DNR" off with the on-screen menus.</li> </ul>	44

Progressive video		Page
<b>There is ghosting when progressive output is on.</b>	<ul style="list-style-type: none"> <li>Select "Video" in the on-screen menu and set "Progressive" to "OFF". This problem is caused by the editing method or material used on DVD, but should be corrected if you use interlace output.</li> </ul>	44
<b>There is no apparent change in picture quality when adjusted with the Video menu in the on-screen menus.</b>	<ul style="list-style-type: none"> <li>The effect is less perceivable with some types of video.</li> </ul>	—

Possible solutions are indicated with "1?" on the relative pages in these instructions.

Sound		Page
<b>No sound. Low volume. Distorted sound.</b>	<ul style="list-style-type: none"> <li>Check the connections. Check the input mode on the amplifier if you have connected one.</li> <li>Turn V.S.S. off if it causes distortion.</li> </ul>	10, 46, 47, 48 43
<b>Cannot hear the desired audio type.</b>	<ul style="list-style-type: none"> <li>Press [AUDIO] to select the desired audio type.</li> <li>Go to Audio in the SETUP menu and choose the correct setting with "Select MTS for DVD-R or LPCM".</li> </ul>	26 53
<b>Cannot switch audio during stereo or SAP broadcasts.</b>	<ul style="list-style-type: none"> <li>You have used digital connection. Set "Dolby Digital" to "PCM" or connect to other equipment using audio cables (analog connection).</li> <li>You cannot change the audio type when using DVD-R or with LPCM recordings.</li> </ul>	47, 51 —

Play		Page
<b>Play fails to start even when [▶] (PLAY) is pressed. Play starts but then stops immediately.</b>	<ul style="list-style-type: none"> <li>Insert the disc correctly with the label facing up.</li> <li>This unit cannot play discs other than DVD-RAM, DVD-R, DVD-Video, Video CD, and CD.</li> <li>The disc is dirty. Clean it.</li> <li>The disc may be badly scratched.</li> <li>You inserted a blank DVD-RAM or DVD-R.</li> <li>Condensation has formed: Wait 1 to 2 hours for it to evaporate.</li> </ul>	17 8 9 — — —
<b>A title or chapter doesn't play when it is selected.</b>	<ul style="list-style-type: none"> <li>Some titles and chapters on DVD-Video are not played when you have changed the ratings level.</li> </ul>	51
<b>Picture distorted during search.</b>	<ul style="list-style-type: none"> <li>Some distortion is normal.</li> </ul>	—
<b>Alternative soundtrack and subtitles cannot be selected.</b>	<ul style="list-style-type: none"> <li>The languages are not recorded on the disc.</li> <li>You may have to use the disc's menus to select languages.</li> </ul>	— 17
<b>No subtitles.</b>	<ul style="list-style-type: none"> <li>Subtitles are not recorded on the disc.</li> <li>Turn the subtitles on.</li> </ul>	— 42
<b>Angle cannot be changed.</b>	<ul style="list-style-type: none"> <li>This function depends on software availability. Angles can only be changed during scenes where different angles are recorded.</li> </ul>	—
<b>You have forgotten your ratings password.</b>	<ul style="list-style-type: none"> <li>Return the ratings setting to "8". While the disc tray is open, press and hold [◀◀/▶▶] and [▶▶/▶▶] on the main unit at the same time for 5 or more seconds.</li> </ul>	—

Displays		Page
<b>The display is dim.</b>	<ul style="list-style-type: none"> <li>Go to Display in the SETUP menu and change the display's brightness with "FL Display".</li> </ul>	53
<b>"12:00" is flashing on the unit's display.</b>	<ul style="list-style-type: none"> <li>The clock is not set. Go to Set Up in the SETUP menu and set the clock with "Clock Settings".</li> </ul>	54
<b>The displayed recording time and actual recording time differ.</b>	<ul style="list-style-type: none"> <li>Displayed recording time is calculated based on the number of frames recorded per second. This number is subject to minute variation. When the recording time is long the cumulative effect of these small differences may result in the slight variation you may sometimes find between displayed recording time and actual recording time. This is normal.</li> </ul>	—

Remote control		Page
<b>The remote control doesn't work.</b>	<ul style="list-style-type: none"> <li>[DVD, TV] is not switched to "DVD". Switch to "DVD" when operating this unit.</li> <li>The remote control and main unit are using different codes. Change the code on the remote control or main unit.</li> <li>The batteries are depleted. Replace them with new ones.</li> <li>Point the remote control at the remote control sensor on the main unit.</li> <li>Remove obstacles from between the remote control and main unit.</li> </ul>	6 50 9 9 —
<b>Cannot operate the television.</b>	<ul style="list-style-type: none"> <li>Change manufacturer code. Some televisions cannot be operated even if you change the code.</li> <li>[DVD, TV] is not switched to "TV". Switch to "TV" when selecting the receiving channel for the television.</li> </ul>	15 6

## Troubleshooting guide

Possible solutions are indicated with "1?" on the relative pages in these instructions.

### Recording and timer recording

Page

<b>Cannot record.</b>	• You haven't inserted a disc or the disc you inserted cannot be recorded on. Insert a disc the unit can record onto.	8
	• The disc is unformatted. Format the disc so this unit can record on it.	34
	• The disc is protected with the write-protect tab. Use a ballpoint pen or similar to release the write protection.	19
	• The disc is protected with DISC SETTING. Release the disc protection.	34
	• The disc is full or nearly full. Erase unneeded programs or use another disc.	36
<b>VCR Plus+ programming does not work properly.</b>	• The guide channels are incorrect. Go to Channel in the SETUP menus and correct them with "VCR Plus+ CH Setting".	13
	• The clock is wrong. Go to Set Up in the SETUP menus and correct it with "Clock Settings".	54
<b>Timer recording does not work properly.</b>	• The timer program is incorrect. Correct the program.	32
	• The unit is not on timer recording standby. ("□" on the unit's display is not on.) Press [⏻, DVD POWER] to turn "□" on.	—
	• Different timer program times overlap.	—
	• The clock is wrong. Go to Set Up in the SETUP menus and correct it with "Clock Settings".	54
<b>The unit switches to standby while making a timer recording.</b>	• The disc has run out of space. Use a disc that has enough space to record the program.	—
<b>The timer program remains even after recording finishes.</b>	• The program remains if you select "DAILY" or "WEEKLY".	31
	• The program remains if recording failed for some reason, but is cleared automatically at 4 a.m. two days later.	—
<b>Timer recording does not stop even when [■] is pressed.</b>	• Press [■] and then [ENTER] within 5 seconds to turn "□" off. Recording stops.	—
<b>The available recording time doesn't increase even after erasing recordings on the disc.</b>	• As this unit is unable to erase data written to DVD-RAM with a computer, the available recording time does not increase. The data will be erased if you reformat the disc.	34
	• If the disc is dirty, wipe with the DVD-RAM/PD disc cleaner (optional) before formatting.	9

Discs make sounds as they rotate. This does not indicate a malfunction.

## Product Service

- 1. Damage requiring service**—The unit should be serviced by qualified service personnel if:
  - (a) The AC power supply cord or AC adaptor has been damaged; or
  - (b) Objects or liquids have gotten into the unit; or
  - (c) The unit has been exposed to rain; or
  - (d) The unit does not operate normally or exhibits a marked change in performance; or
  - (e) The unit has been dropped or the cabinet damaged.
- 2. Servicing**—Do not attempt to service the unit beyond that described in these operating instructions. Refer all other servicing to authorized servicing personnel.

- 3. Replacement parts**—When parts need replacing ensure the servicer uses parts specified by the manufacturer or parts that have the same characteristics as the original parts. Unauthorized substitutes may result in fire, electric shock, or other hazards.
- 4. Safety check**—After repairs or service, ask the servicer to perform safety checks to confirm that the unit is in proper working condition.

### Product information

For product information or assistance with product operation:

**In the U.S.A., contact the Panasonic Customer Call Center at 1-800-211-7262, or e-mail [consumerproducts@panasonic.com](mailto:consumerproducts@panasonic.com), or web site (<http://www.panasonic.com>).**  
**In Canada, contact Panasonic Canada Inc. Customer Care Centre at 1-800-561-5505, web site ([www.panasonic.ca](http://www.panasonic.ca)), or an authorized Servicentre closest to you.**

## Specifications

<b>Recording system:</b>	DVD video recording standards (DVD-RAM), DVD video standards (DVD-R)	<b>Audio system</b>	
<b>Optical pick-up:</b>	System with 1 lens, 2 integration units (662 nm wavelength for DVDs, 790 nm wavelength for CDs)	<b>Recording system:</b>	Dolby Digital (XP/SP/LP/EP) LINEAR PCM (XP mode only)
<b>Recordable discs:</b>	12 cm 4.7 GB DVD-RAM discs 12 cm 9.4 GB DVD-RAM discs 8 cm 2.8 GB DVD-RAM discs 12 cm 4.7 GB DVD-R discs (for General Ver. 2.0)	<b>Input:</b>	LINE (pin jack) Reference input: 309 mVrms FS: 2 Vrms (1 kHz, 0 dB) Input impedance: 47 kΩ
<b>Recording time:</b>	Max. 6 hours (using 4.7 GB disc) XP: 60 minutes SP: 120 minutes LP: 240 minutes EP: 360 minutes	<b>Output:</b>	LINE (pin jack) Reference output: 309 mVrms FS: 2 Vrms (1 kHz, 0 dB) Output impedance: 1 kΩ (Load impedance: 10 kΩ)
<b>Discs played:</b>	12 cm 4.7 GB DVD-RAM discs 12 cm 9.4 GB DVD-RAM discs 8 cm 2.8 GB DVD-RAM discs 12 cm 4.7 GB DVD-R discs (for General Ver. 2.0) DVD-VIDEO discs CD-Audio discs (CD-DA) Video CD discs CD-R/CD-RW discs (CD-DA, Video CD formatted discs)	<b>Number of channels:</b>	Recording: 2 channels Playback: 2 channels
<b>Video system</b>	NTSC system, 525 lines, 60 fields	<b>Other input/output connectors:</b>	Digital audio optical output connector
<b>TV system:</b>	MPEG2 (Hybrid VBR)	<b>Operating temperature range:</b>	5°C–40°C (41°F–104°F)
<b>Recording system:</b>	LINE (pin jack), 1.0 Vp-p; 75 Ω	<b>Operating humidity range:</b>	10%–80% RH (no condensation)
<b>Input:</b>	S connector Y: 1.0 Vp-p; 75 Ω C: 0.286 Vp-p; 75 Ω	<b>Clock unit:</b>	Quartz-controlled 12-hour digital display
<b>Output:</b>	LINE (pin jack), 1.0 Vp-p; 75 Ω S connector Y: 1.0 Vp-p; 75 Ω C: 0.286 Vp-p; 75 Ω	<b>LASER Specification</b>	
<b>Component video output (525p/525i):</b>	Y: 1.0 Vp-p; 75 Ω Pb: 0.7 Vp-p; 75 Ω Pr: 0.7 Vp-p; 75 Ω	<b>Class I LASER Product</b>	
<b>Antenna reception input:</b>	TV Channel: 2ch–69ch, 75 Ω CATV Channel: 1ch–125ch, 75 Ω	<b>Wave length:</b>	775–815 nm 655–666 nm
		<b>Laser power:</b>	No hazardous radiation is emitted with the safety protection
		<b>Power supply:</b>	AC 120 V, 60 Hz
		<b>Power consumption:</b>	26 W
		<b>Dimensions:</b>	Approx. 430 (W) × 79 (H) × 306 (D) mm [Approx. 16 <sup>5/16</sup> " (W) × 3 <sup>1/8</sup> " (H) × 12 <sup>1/16</sup> " (D)] (excluding protrusions)
		<b>Mass:</b>	Approx. 3.5 kg (7.7 lbs)
		<b>Power consumption in standby mode:</b> approx. 3 W	
		<b>Note</b>	Specifications are subject to change without notice. Mass and dimensions are approximate.



## Limited Warranty (ONLY FOR U.S.A.)

Panasonic Consumer Electronics Company,  
Division of Matsushita Electric Corporation of America  
One Panasonic Way Secaucus, New Jersey 07094

Panasonic Sales Company, Division of Matsushita Electric  
of Puerto Rico, Inc.  
Ave. 65 de Infantería, Km. 9.5  
San Gabriel Industrial Park, Carolina, Puerto Rico 00985

### Panasonic DVD Player/Recorder Limited Warranty

#### Limited Warranty Coverage

If your product does not work properly because of a defect in materials or workmanship, Panasonic Consumer Electronics Company or Panasonic Sales Company (collectively referred to as "the warrantor") will, for the length of the period indicated on the chart below, which starts with the date of original purchase ("warranty period"), at its option either (a) repair your product with new or refurbished parts, or (b) replace it with a new or a refurbished product. The decision to repair or replace will be made by the warrantor.

Product or Part Name	Parts	Labor
DVD Player	One (1) Year	Ninety (90) Days
DVD Recorder	One (1) Year	One (1) Year
Rechargeable Batteries, DVD-RAM Disc (in exchange for defective item)	Ten (10) Days	Not Applicable

During the "Labor" warranty period there will be no charge for labor. During the "Parts" warranty period, there will be no charge for parts. You must carry-in or mail-in your product during the warranty period. If non-rechargeable batteries are included, they are not warranted. This warranty only applies to products purchased and serviced in the United States or Puerto Rico. This warranty is extended only to the original purchaser of a new product which was not sold "as is". A purchase receipt or other proof of the original purchase date is required for warranty service.

#### Carry-In or Mail-In Service

For Carry-In or Mail-In Service in the United States call 1-800-211-PANA(7262) or visit Panasonic Web Site: <http://www.panasonic.com>  
For assistance in Puerto Rico call Panasonic Sales Company (787)-750-4300 or fax (787)-768-2910.

### Customer Services Directory

**For Product Information, Operating Assistance, Literature Request, Dealer Locations, and all Customer Service inquiries please contact:  
1-800-211-PANA (7262), Monday-Friday 9 am-9 pm; Saturday-Sunday 9 am-7 pm, EST.**

**Web Site: <http://www.panasonic.com>  
You can purchase parts, accessories or locate your nearest servicenter by visiting our Web Site.**

#### Accessory Purchases:

1-800-332-5368 (Customer Orders Only)  
Panasonic Services Company 20421 84th Avenue South, Kent, WA 98032  
(6 am to 5 pm Monday-Friday; 6 am to 10:30 am Saturday; PST)  
(Visa, MasterCard, Discover Card, American Express, Check)

**Service in Puerto Rico  
Matsushita Electric of Puerto Rico, Inc. Panasonic Sales Company/Factory Servicenter:  
Ave. 65 de Infantería, Km. 9.5, San Gabriel Industrial Park, Carolina, Puerto Rico 00985  
Phone (787) 750-4300 Fax (787) 768-2910**

## Limited Warranty (ONLY FOR CANADA)

Panasonic Canada Inc.  
5770 Ambler Drive, Mississauga, Ontario L4W 2T3

### PANASONIC/TECHNICS PRODUCT—LIMITED WARRANTY

Panasonic Canada Inc. warrants this product to be free from defects in material and workmanship and agrees to remedy any such defect for a period as stated below from the date of original purchase.

#### Panasonic DVD Recorder One (1) year, parts and labour

#### LIMITATIONS AND EXCLUSIONS

This warranty does not apply to products purchased outside Canada or to any product which has been improperly installed, subjected to usage for which the product was not designed, misused or abused, damaged during shipping, or which has been altered or repaired in any way that affects the reliability or detracts from the performance, nor does it cover any product which is used commercially. Dry cell batteries are also excluded from coverage under this warranty.

This warranty is extended to the original end user purchaser only. A purchase receipt or other proof of date of original purchase is required before warranty service is performed.

**THIS EXPRESS, LIMITED WARRANTY IS IN LIEU OF ALL OTHER WARRANTIES, EXPRESS OR IMPLIED, EXCLUDING ANY IMPLIED WARRANTIES OF MERCHANTABILITY OR FITNESS FOR A PARTICULAR PURPOSE.**

**IN NO EVENT WILL PANASONIC CANADA INC. BE LIABLE FOR ANY SPECIAL, INDIRECT OR CONSEQUENTIAL DAMAGES.**

In certain instances, some jurisdictions do not allow the exclusion or limitation of incidental or consequential damages, or the exclusion of implied warranties, so the above limitations and exclusions may not be applicable.

#### WARRANTY SERVICE

**For product operation and information assistance**, please contact your Dealer or our Customer Care Centre at: Telephone #: (905) 624-5505 Fax #: (905) 238-2360 Web: [www.panasonic.ca](http://www.panasonic.ca)

**For product repairs**, please contact one of the following:

- Your Dealer who will inform you of an authorized Servicentre nearest you.
- Our Customer Care Centre at (905) 624-5505 or [www.panasonic.ca](http://www.panasonic.ca)
- A Panasonic Factory Servicentre listed below:

#### Richmond,

#### British Columbia

Panasonic Canada Inc.  
12111 Riverside Way  
Richmond, BC  
V6W 1K8  
Tel: (604) 278-4211  
Fax: (604) 278-5627

#### Calgary, Alberta

Panasonic Canada Inc.  
6835-8<sup>th</sup> St. N. E.  
Calgary, AB  
T2E 7H7  
Tel: (403) 295-3955  
Fax: (403) 274-5493

#### Mississauga, Ontario

Panasonic Canada Inc.  
5770 Ambler Dr.  
Mississauga, ON  
L4W 2T3  
Tel: (905) 624-8447  
Fax: (905) 238-2418

#### Lachine, Québec

Panasonic Canada Inc.  
3075, rue Louis A. Amos  
Lachine, QC  
H8T 1C4  
Tel: (514) 633-8684  
Fax: (514) 633-8020

#### CUSTOMER'S RECORD:

Customer Name: \_\_\_\_\_

Model Number: \_\_\_\_\_ Serial Number: \_\_\_\_\_

Date of Purchase: \_\_\_\_\_

Dealer's Name: \_\_\_\_\_

Address: \_\_\_\_\_ Phone Number: \_\_\_\_\_

#### IF YOU SHIP THE PRODUCT TO A SERVICENTRE

Carefully pack and send prepaid, adequately insured and preferably in the original carton.  
Include details of the defect claimed, and proof of date of original purchase.

## Conexiones de antena y televisor

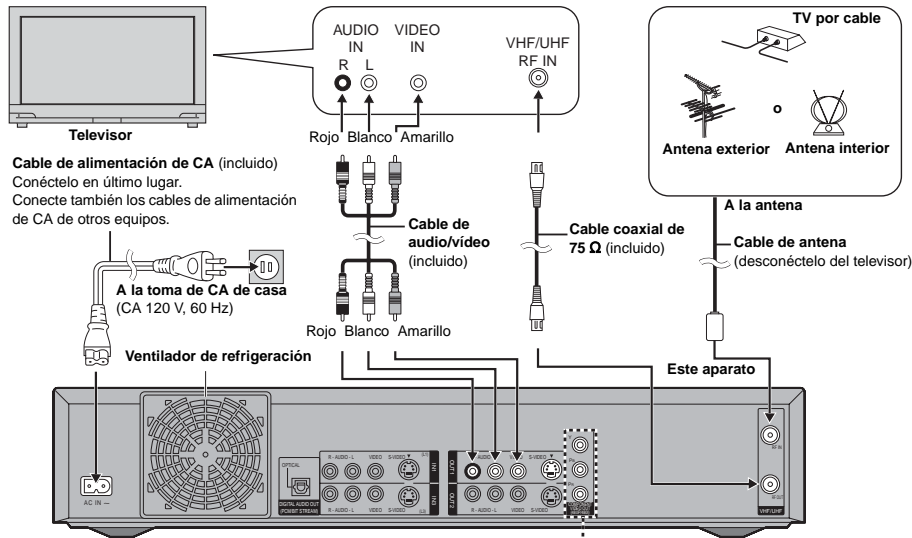

### Para disfrutar del vídeo progresivo

- Haga la conexión a los terminales de entrada de vídeo componente (480p) de un televisor que sea compatible con el sistema de protección contra el copiado de este aparato. (La imagen no se visualizará correctamente si se hace la conexión a un televisor incompatible.)
- Ponga "TV Type" en "480P" (→ abajo).
- Durante la reproducción
  1. Pulse [DISPLAY].
  2. Pulse [▲, ▼] para seleccionar "Video" y pulse [▶].
  3. Pulse [▲, ▼] para seleccionar "Progressive" y pulse dos veces [▶].
  4. Pulse [▲, ▼] para establecer "Transfer" según el tipo de material que esté siendo reproducido.

Disc	Picture	Normal
Play	MPEG-DNR	ON
Video	Progressive	ON
Audio	Transfer	Auto 1

- Auto1:** Para material de películas
- Auto2:** Para material de películas (Lo mismo que para Auto1, pero capaz de convertir vídeo progresivo de 30 cuadros por segundo.)
- Video:** Para material de vídeo

Después de enchufar el aparato en la toma de corriente de su casa y pulsar [⏻, DVD POWER] para encender el aparato por primera vez, éste sintonizará automáticamente todos los canales que pueda recibir y pondrá en hora el reloj. Utilice [ENTER] y siga las instrucciones de la pantalla.

## Selección del tipo de pantalla del televisor

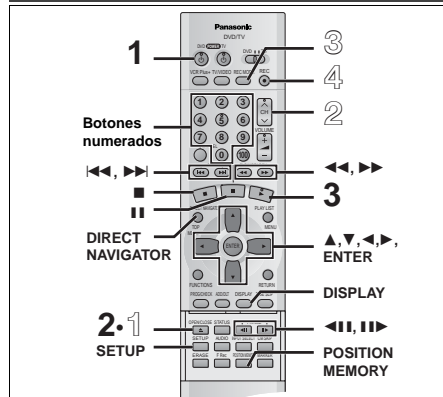

### Cambie los ajustes si:

- Conecta el aparato a un televisor de pantalla panorámica con una relación de aspecto de 16:9. → Ponga "TV Aspect" en "16:9".
  - Conecta el aparato a través de los terminales de vídeo COMPONENT a un televisor compatible con señales de vídeo progresivo (480P). → Ponga "TV Type" en "480P".
1. Pulse [SETUP] para mostrar los menús.
  2. Pulse [▲, ▼] para seleccionar la ficha "TV Screen" y pulse [▶].
  3. Pulse [▲, ▼] para seleccionar "TV Aspect" y pulse [ENTER].
  4. Pulse [▲, ▼] para seleccionar "16:9" y pulse [ENTER].
  5. Pulse [▲, ▼] para seleccionar "TV Type" y pulse [ENTER].
  6. Pulse [▲, ▼] para seleccionar "480P" y pulse [ENTER].
  7. Pulse [SETUP].

## Reproducción de discos

RAM DVD-R DVD-V CD VCD

**1** Pulse [⏻, DVD POWER] para encender el aparato.

**2** Pulse [▲, OPEN/CLOSE] para abrir la bandeja e inserte un disco.

Inserte el disco con la etiqueta hacia arriba y la flecha indicando hacia adentro.

Inserte con la etiqueta hacia arriba.

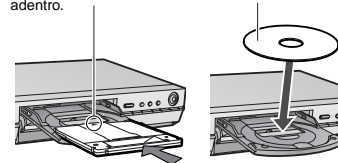

Cargue los discos de dos lados de forma que la etiqueta del lado que quiera reproducir quede hacia arriba.

- Pulse de nuevo [▲, OPEN/CLOSE] para cerrar la bandeja.

**3** Pulse [▶] (PLAY).

El aparato tarda algo de tiempo en leer el disco antes de empezar la reproducción.

RAM DVD-R

La reproducción empieza desde el principio de la grabación más reciente. Si ese programa es muy breve, la reproducción empieza desde la siguiente grabación más reciente.

- Para detener la reproducción, pulse [■].
- Para hacer una pausa en la reproducción, pulse [⏸].

■ Cuando aparece una pantalla de menú en el televisor

Pulse los botones numerados para seleccionar un elemento.

■ Inicio de la reproducción desde donde usted la detuvo—Función de reanudación

1. Durante la reproducción  
Pulse [■].  
El aparato recuerda la posición.
2. Pulse [▶] (PLAY) mientras parpadea "PLAY" en el visualizador.  
La reproducción empieza desde donde usted la detuvo.

### Para cancelar la función de reanudación

Pulse [■] hasta que se apague "PLAY".

### Para iniciar la reproducción desde una posición memorizada después de apagar el aparato

Pulse [POSITION MEMORY] durante la reproducción. (El mensaje "Position Memorized" aparece en el televisor.) Ahora, cuando pulse [▶] (PLAY) después de poner el aparato en el modo de espera y luego volver a encenderlo, la reproducción empezará desde la posición memorizada y la posición se cancelará.

## Salto

Puede saltar al comienzo de las pistas (CD y CD de vídeo) y de los capítulos (DVD-Vídeo) y reanudar la reproducción desde ese punto.

En los discos DVD-RAM y DVD-R, puede saltar al principio de un programa o a un marcador e iniciar la reproducción desde ese punto.

Durante la reproducción o la pausa  
Pulse [◀◀] o [▶▶].

## Avance rápido y rebobinado—SEARCH

Durante la reproducción  
Pulse [◀◀] o [▶▶].

## Reproducción a cámara lenta

Durante la pausa  
Pulse [◀◀] o [▶▶].

## Visión cuadro a cuadro

Durante la pausa  
Pulse [◀◀] o [▶▶].

- Pulse [▶] (PLAY) para reanudar la reproducción.
- Durante los modos de reproducción a cámara lenta y cuadro a cuadro de CDs de vídeo no es posible retroceder.
- [◀◀], [◀], [▶], [▶▶]: Retroceso
- [▶▶], [▶], [▶▶]: Avance

## Grabación de programas de televisión

RAM DVD-R

**1** Pulse [▲, OPEN/CLOSE] para abrir la bandeja e inserte un disco.

- Pulse de nuevo [▲, OPEN/CLOSE] para cerrar la bandeja.

**2** Pulse [▲, V, CH] para seleccionar el canal.

**3** Pulse [REC MODE] para seleccionar el modo de grabación.

**4** Pulse [●, REC] para iniciar la grabación.

- Para hacer una pausa en la grabación, pulse [⏸].
- Para detener la grabación, pulse [■].

## Reproducción desde el principio del programa que está grabando—Reproducción en persecución

RAM

Durante la grabación  
Pulse [▶] (PLAY).

La reproducción empieza desde el comienzo del programa que está siendo grabado.

## Grabación y reproducción simultáneas

RAM

Durante la grabación  
Pulse [DIRECT NAVIGATOR], pulse [▲, ▼] para seleccionar el programa y luego pulse [ENTER].

# Index

A-B repeat	43	Marker	25
Angle	42	Mosquito NR	44
Antenna system	12	MPEG-DNR	44
Audio attribute	42		
		On-screen display	56
Block NR	44	On-screen menu	42
Brightness	44		
		PCM Down Conversion	51
Channel caption	55	Picture	44
Channel setting	55	PLAY FROM TOP	41
Chasing play	28	Play list	21, 38, 40
Cleaning		Position memory function	17
disc	9	Program play	24
lens	59	Progressive	10, 14, 44, 57
main unit	59	Properties	
Clock setting	54	play list	38
CM Skip	22	program	36
Color	44	Protection	
Connection		disc	19, 34
amplifier, system component	47	program	36
antenna	49		
antenna, television	10	Random play	24
cable TV box, satellite receiver	46	Ratings password	51, 61
video equipment	48	Recording mode	19
Contrast	44	Re-initialize setting	52
CPRM system	8	Repeat play	43
		Resume function	17
Dialog Enhancer	43		
Direct Navigator	20	Seamless play	53
Divide Program	36	SETUP menu	51
		Sharpness	44
Edit Scenes	38	Shorten Segment	36
Enter title		Simultaneous rec and play	28
disc	34	Sound track	42
play list	38	Subtitle	42
program	36		
Erase		Time Slip	28
all program	34	Timer recording	30-32
play list	21, 38	Transfer	44
play list scene	21, 38	TV Aspect	14
program	23, 36	TV Type	14
Finalize	34		
Flexible Recording (FR)	19, 41	VCR Plus+	
Format DVD-RAM	34	guide channel	13
FUNCTIONS window	41	timer recording	30
		V.S.S.	43
Gamma	44		
		3D NR	44
Language code list	57		
LPCM	53, 57		

Apparatus Claims of U.S. Patent Nos. 4,631,603, 4,577,216, and 4,819,098, licensed for limited viewing uses only.

This product incorporates copyright protection technology that is protected by method claims of certain U.S. patents and other intellectual property rights owned by Macrovision Corporation and other rights owners. Use of this copyright protection technology must be authorized by Macrovision Corporation, and is intended for home and other limited viewing uses only unless otherwise authorized by Macrovision Corporation. Reverse engineering or disassembly is prohibited.

Panasonic Consumer Electronics  
Company, Division of Matsushita  
Electric Corporation of America  
One Panasonic Way Secaucus,  
New Jersey 07094  
<http://www.panasonic.com>

Panasonic Sales Company,  
Division of Matsushita Electric  
of Puerto Rico, Inc. ("PSC")  
Ave. 65 de Infantería, Km. 9.5  
San Gabriel Industrial Park, Carolina,  
Puerto Rico 00985

Panasonic Canada Inc.  
5770 Ambler Drive  
Mississauga, Ontario  
L4W 2T3  
[www.panasonic.ca](http://www.panasonic.ca)

