



PVI 50KW

PVI 60KW

PVI 75KW

PVI 85KW

PVI 100KW

INSTALLATION AND OPERATION MANUAL

Revision B

© 2015 Solectria Renewables, LLC



IMPORTANT REGISTRATION AND WARRANTY INFORMATION

For warranty to become active, this inverter must be registered. To activate warranty and register inverter, please visit the link below.

www.solectria.com/registration

IMPORTANT SAFETY INSTRUCTIONS

SAVE THESE INSTRUCTIONS

In this manual “inverter” or “inverters” refers to the inverter models: PVI 50KW, PVI 60KW, PVI 75KW, PVI 85KW, and PVI 100KW unless one of the specific models is noted.

This manual contains important instructions that shall be followed during installation and maintenance of the inverter.

To reduce the risk of electrical shock, and to ensure the safe installation and operation of the inverter, the following safety symbols are used to indicate dangerous conditions and important safety instructions:



WARNING: *Use extreme caution when performing this task.*

This indicates a fact or feature very important for the safety of the user and/or which can cause serious hardware damage if not applied appropriately.

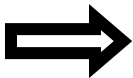

NOTE: *This indicates a feature that is important either for optimal and efficient use or optimal system operation.*



EXAMPLE: This indicates an example.

IMPORTANT SAFETY INSTRUCTIONS

- All electrical installations shall be performed in accordance with applicable local, state, and national codes.
- The inverter contains no user serviceable parts. Please contact Solectria Renewables or a Solectria Renewables authorized system installer for maintenance. See Appendix C for Solectria Renewables contact information and authorized system installers.
- Before installing or using the inverter, please read all instructions and caution markings in this manual, on the inverter, as well as on the PV modules.
- Connection of the inverter to the electric utility grid must be completed after receiving prior approval from the utility company and must only be performed by qualified personnel.
- PV modules produce dangerous electrical voltage and current when exposed to light and could create hazardous conditions. Completely cover the surface of all PV modules with an opaque material before wiring them or do not connect inter-module cables, PV source circuits, and/or PV output circuits under load.
- The inverter enclosure and both disconnect switches must be locked (requiring a tool or key for access) for protection against risk of injury to persons. The enclosure includes a lockable handle and comes with a key. Keep the key in a safe location in case access to the cabinet is needed. A replacement key can be purchased from Solectria Renewables.

SAVE THESE INSTRUCTIONS

PRESCRIPTIONS DE SECURITE IMPORTANTES

- Tous les travaux d'installation électrique doivent être exécutés en conformité aux normes électriques locales ainsi qu'à la norme nationale américaine et canadienne.
- Le PVI ne contient aucune pièce requérant un entretien effectué par l'utilisateur. Pour toute maintenance, veuillez consulter Solectria Renewables ou un installateur agréé par Solectria Renewables (les coordonnées de Solectria Renewables et des installateurs agréés sont indiquées sur le site web de Solectria Renewables: www.solectria.com).
- Avant d'installer ou d'utiliser le PVI veuillez lire toutes instructions et toutes les mises en garde présentes dans ce manuel, sur le PVI et sur les modules PV.
- Le raccordement du PVI au réseau électrique ne doit être effectuée qu'après avoir obtenu une entente d'interconnexion auprès de la compagnie locale de distribution électrique et uniquement par du personnel autorisé et qualifié.
- La surface de tous les capteurs PV doivent être recouverte entièrement d'un matériel opaque
- (noir) avant de procéder au câblage. Les capteurs PV exposés a la lumière produisent du courant électrique susceptible de créer une situation de risque.

CONSERVEZ CES INSTRUCTIONS

Table of Contents

1 Introduction	7
2 Site Preparation and Inverter Placement	9
2.1 Clearance Requirements.....	10
2.2 Inverter Dimensions.....	11
3 Installation	11
3.1 Checking For Shipping Damage.....	11
3.2 Inverter Lifting.....	11
3.3 Mounting Details.....	12
4 DC Connections from the PV Array and AC Connections to the Grid.....	14
4.1 Grounding	14
4.2 AC Grounding Connections	16
4.3 DC Grounding Connections.....	17
4.4 AC Power Connections.....	18
AC Cable Entry.....	19
Neutral Kit Option	22
4.5 AC Ground Fault Detection	23
4.6 DC Power Connections.....	24
DC Cable Entry	24
Standard DC Disconnect Switch.....	27
Fused DC Subcombiner	27
DC Breaker Subcombiner	28
DC Breaker Damage	28
4.7 DC Ground Fault Detection and Interruption	29
4.8 Lightning and Surge Protection.....	31
4.9 Remote Shutdown and Revenue Grade Meter Terminals.....	31
5 Commissioning the Inverter.....	33
5.1 Turning on the Inverter.....	33
5.2 Operation	34
5.3 Turning Off the Inverter	34
6 Inverter Control and Communications” in the PVI 50-100.....	35
LED Indicators	37
6.1 Button Descriptions	38
6.2 Main Display.....	39
6.3 Accessing the Menu	39
6.4 Navigating the Menu Structure	40
6.5 Displaying Inverter Measurements.....	41
6.6 Controlling the Inverter	43
6.7 Stopping and Starting the Inverter	44
Quick Stop and Start	44
6.8 Accessing Password Protected Functions.....	45
6.9 Changing the Inverter Password.....	46

- 6.10 Changing Voltage and Frequency Trip Settings 47
- 6.11 Establishing Ethernet Connectivity 50
- 6.12 Setting up TCP/IP Networking 51
- 6.13 Viewing Current TCP/IP settings:..... 51
- 6.14 Manually Configuring Network Settings..... 53
- 6.15 Automatically Configuring Network Settings 56
- 6.16 Setting Fallback IP Address 57
- 6.17 Enabling SolrenView Web-based Monitoring..... 60
- 6.18 Viewing and setting the Date/Time 61
- 6.19 Rebooting the SolrenView Gateway 64
- 6.20 Resetting the SolrenView Gateway to Factory Defaults..... 65
- 6.21 Inverter Counts and Logs 66
- 6.22 Displaying Error Counts..... 67
- 6.23 Displaying Error Logs..... 69
- 6.24 Clearing Error Counts or the Log..... 71
- 6.25 HMI Menu Structure 73
- 7 Troubleshooting and Maintenance 74
 - 7.1 Inverter Messages..... 74
 - 7.2 Troubleshooting 76
 - 7.3 Preventative Maintenance 77
 - 7.4 Intake Louver Vent Cleaning..... 78
 - 7.5 Opening Main Enclosure, DC Disconnect Switch, and AC Disconnect Switch 78
 - 7.6 Fuse replacements 80
- 8 Product Warranty and RMA Policy 81
- 9 Technical Data..... 82
 - 9.1 Input DC (PV) Specifications..... 82
 - 9.2 Output AC Specifications 83
 - 9.3 Other Specifications 84
 - 9.4 Internal Circuit Diagram..... 86
- 10 Appendices..... 87
 - 10.1 Appendix A – PVI 50KW, 60KW, 75KW, 85KW, 100KW Data Sheet 87
 - 10.2 Appendix B – String Sizing Tool..... 87
 - 10.3 Appendix C – Contact Information 87
 - 10.4 Appendix D – Authorized Distributors 87
 - 10.5 Appendix E – UL1741/IEEE 1547 Authorization Letter to Mark Product 88

1 Introduction

The PVI 50-100KW inverter series are commercial, three-phase grid-tied PV inverters designed to be interconnected to the electric utility grid. By following this manual the inverter can be installed and operated safely. This installation guide is used as a reference for commissioning and as a guideline on how to use the inverter most effectively.

Feeding power onto the grid involves conversion of the DC voltage from the PV array to grid compatible AC voltage by inverting DC to AC. This unit feeds power into a standard, three-phase commercial, industrial, institutional or electrical utility facility’s electrical system which is connected to the electrical grid.

If the PV system and inverter are providing the same amount of electrical power that the facility is using, then no power is taken from or fed into the utility grid. If the facility is using more power than the PV system is providing, then the utility grid provides the balance of power. If the facility is using less power than the PV system is generating, then the excess is fed into the utility grid.

Be sure to follow local regulations regarding net metering and interconnection in your local area. Note that some utilities need to change their revenue kWh meter for proper net metering measurement and billing.

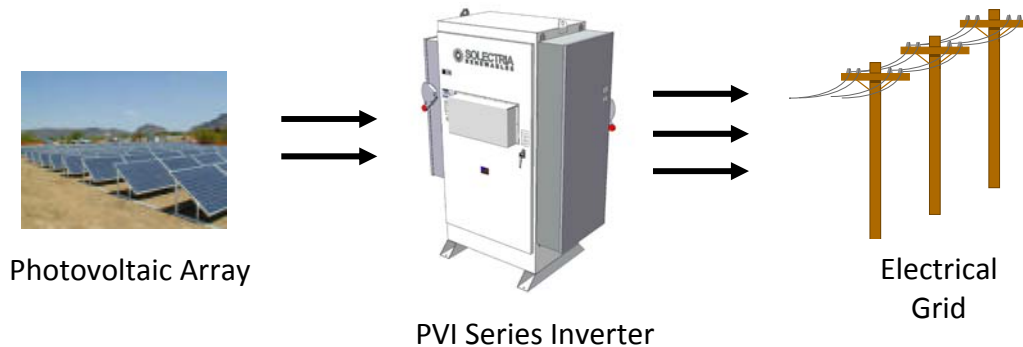

Figure 1.1 – Grid-Tied Inverter Application

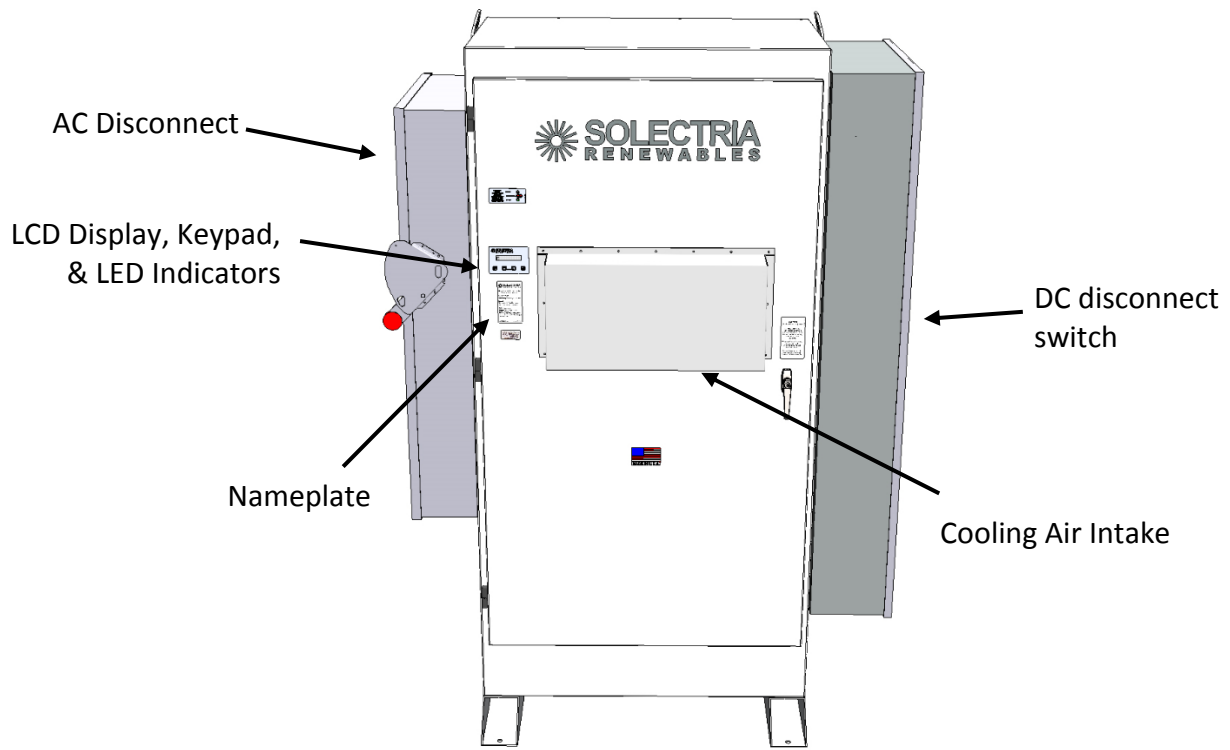

Figure 1.2 – PVI Inverter (Front View)

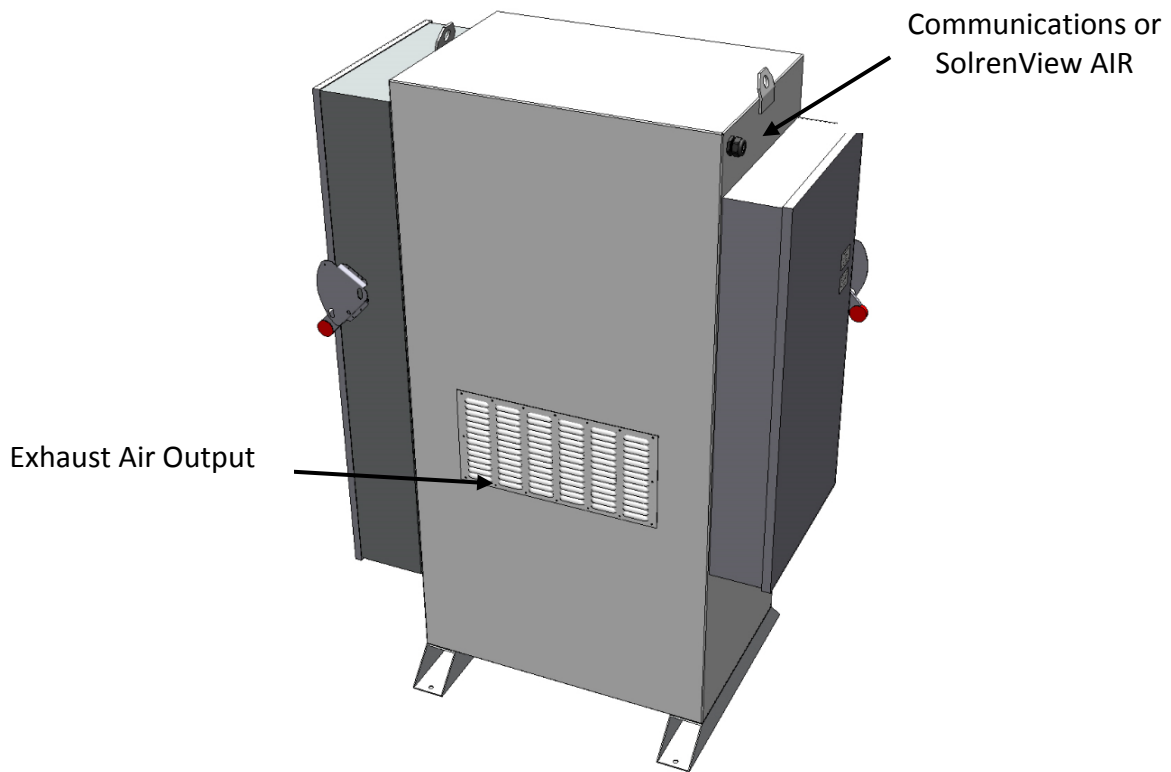
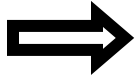

Figure 1.3 – PVI Inverter (Rear View)

2 Site Preparation and Inverter Placement

The inverter is comprised of a rainproof, industrial enclosure containing electrical and electronic components and AC and DC integrated disconnecting means.



NOTE: *If the inverter is mounted outside, ensure that the enclosure and disconnect switch doors remain closed during the installation process in case of rain or snow. Leaving these doors open during installation will void the warranty.*



NOTE: *It is recommended to store the inverter indoors before installation. If the inverter is to be stored outdoors for more than one month before being installed and commissioned, care must be taken to avoid condensation inside the unit. Removing the protective shipping wrap and placing a small space heater inside the unit minimizes the amount of condensation that can occur during onsite outdoor storage. Once operational, the inverter will generate its own heat to prevent condensation.*

Criteria for Device Mounting:

- Because the power electronics are within the rainproof enclosure, the inverter can be mounted outdoors.
- The longest life for the inverter can be achieved by mounting the unit in a clean, dry and cool location.
- For optimal electrical system efficiency, use the shortest possible AC and DC cables and use the maximum allowable cable size.
- Avoid installation in close proximity to people or animals, as there is an audible high-frequency switching noise.
- Install the inverter in an accessible location following local electric codes for enclosure and disconnect switch door clearances and proximity to other equipment.
- Although the inverter is designed to function at full power continuously in up to 55°C ambient temperature, for longest inverter life and performance, do not mount the inverter in direct sunlight, especially in hot climates. If the unit must be mounted in direct sunlight a metal sun-shield is recommended. It is recommended that the inverter is mounted on the north side of buildings or on the north side of a ground mount PV array.



CAUTION: *Be sure to verify load capacity of floor, roof or pad, and ensure that lifting equipment has adequate lifting capacity to lift the unit.*

Inverter Model	Weight
PVI 50-60KW	1,450 lbs
PVI 75-85-100KW	1,875 lbs

Table 2.1 – Weight of PVI 50-100 Inverters

- Installations in most US jurisdictions are subject to NFPA 70, known commonly by electricians as the National Electric Code (NEC). The NEC requires that the inverter be connected to a dedicated circuit and no other outlets or devices may be connected to this circuit. The NEC also imposes limitations on the size of the inverter and the manner in which it is connected to the utility grid. See applicable revision of the NEC for more information. It is the installer’s responsibility to follow all applicable electric codes.

2.1 Clearance Requirements

- The ambient temperature must be between –40°F and +130°F (–40°C and +55°C) for full power, continuous operation. The inverter will automatically reduce power or may shut down to protect itself if ambient air temperature at the intake rises above 130°F (55°C).
- The cooling air exhausts at the rear and bottom of the enclosure. Nothing should block the 4 inch clear space under the enclosure between the mounting feet.
- A minimum distance of 8 inches (200mm) must be clear *behind* the inverter for rear cooling air exhaust. 12 inches (300mm) is recommended.
- A minimum distance of 12 inches (300mm) must be clear above the inverter for ventilation.
- Make sure the AC and DC disconnect switches are accessible during operation and that all doors may be fully opened for maintenance. Install the inverter in an accessible location following applicable electrical codes for working clearance requirements and proximity to other equipment.
- If you are installing the inverter in an electrical closet, the air circulation must be sufficient for heat dissipation. Provide external ventilation to maintain an ambient condition of less than 130°F (55°C). The ambient temperature should be kept as low as possible at all times for optimal inverter operation and life.

Model	Max. Heat Loss
PVI 50KW	7,000 Btu/hr
PVI 60KW	8,250 Btu/hr
PVI 75KW	8,000 Btu/hr
PVI 85KW	12,000 Btu/hr
PVI 100KW	14,000 Btu/hr

Table 2.2 – Indoor Cooling Requirements

2.2 Inverter Dimensions

Refer to the customer interface drawing (DOCR-070190) for detailed inverter dimensions.

3 Installation



WARNING: *Before installing the inverter, read all instructions and caution markings in this manual and on the inverter as well as on the photovoltaic modules.*



WARNING: *Electrical installation shall be performed in accordance with all local electrical codes, the National Electrical Code (NEC), NFPA 70, or Canadian Electrical Code for Canada (CEC).*



WARNING: *Connecting the inverter to the electric utility grid must only be completed after receiving prior approval from the utility company and installation performed only by qualified personnel/licensed electrician(s).*

3.1 Checking For Shipping Damage

The inverter is thoroughly checked and tested rigorously before it is shipped. Even though it is bolted onto a rugged, oversized pallet for delivery, the inverter may have been damaged during shipping by poor handling, trucking or transfer station activity.

Please inspect the inverter thoroughly after it is delivered. If any damage is seen, immediately notify the shipping company to make a claim. If there is any question about potential shipping damage, contact Solectria Renewables. Photos of the damage will be helpful in documenting potential shipping damage.

- Do not accept the unit if it is visibly damaged or if you note visible damage when signing shipping company receipt.
- Note damage on shipping papers with the truck driver. Report damage immediately to the shipping company.
- Do not remove the unit from pallet/package if damage is evident.
- If it is determined that the unit must be returned, a RMA number must be obtained from Solectria Renewables prior to shipping the unit back.

3.2 Inverter Lifting



WARNING: *The inverter may tip over if improperly moved, potentially causing damage to equipment, personal injury or death. Do not tilt the pallet or inverter while moving it.*

- Use a forklift or fork attachment or other equipment if lifting from the bottom. The forks should be set with a 27" outside spacing so they fit just in between the inverter's 4 x 4" aluminum tube feet. Before lifting, make sure forks are against the inside edges of both feet.
- Once off the pallet, a pallet jack can also be used to roll the unit on a floor. Use a 27" wide jack.
- Alternatively, the inverter can be lifted using the lifting tabs on the top. If using this lifting method, lift with vertical chains and hooks connected to a proper lifting device. Please refer to the customer interface drawing (DOCR-070190) for the minimum recommended chain length to prevent damage to the inverter.

3.3 Mounting Details



WARNING: Do not install the inverter on or over combustible surfaces or materials.

The inverter includes mounting feet with four holes sized for ½" diameter hardware. Refer to the diagram below and the customer interface drawing (DOCR-070190) for detailed mounting dimensions.

It is recommended to use four bolts for the mounting feet. Hot dip galvanized grade 5, grade 8, or stainless steel bolts ½" (13mm) in diameter are acceptable. Use a lock washer and flat washer with each bolt.

Once mounting is completed, remove shipping aids from the inverter including packing material under cowl on front door, packing material between large power cables and the contactor inside upper portion of the inverter, and packing material inside the DC disconnect switch enclosure near the switch mechanism.

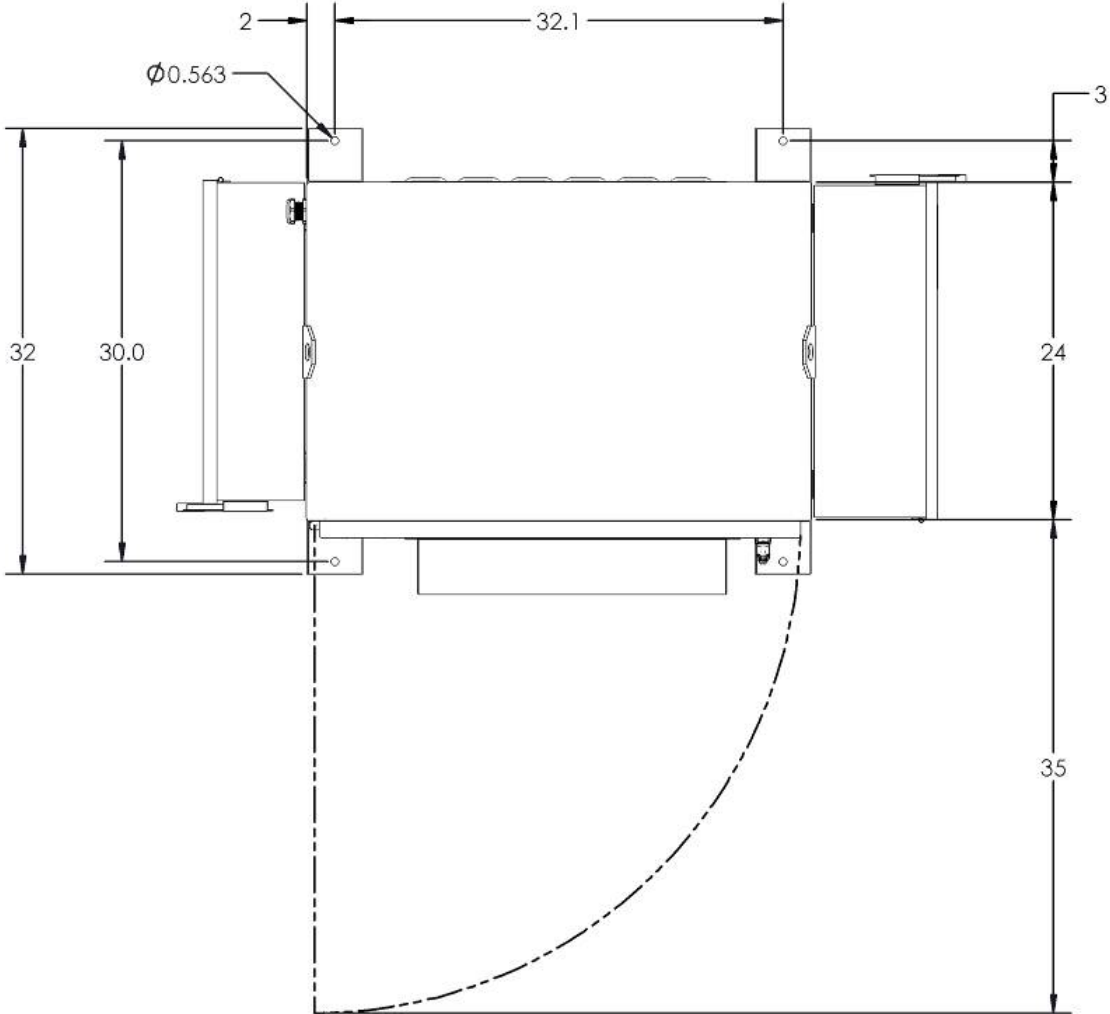

Fig. 3.3 Mounting Hole Diagram (View from top of Inverter)

4 DC Connections from the PV Array and AC Connections to the Grid



WARNING: *All electrical installations shall be performed in accordance with applicable local, state, and national electric codes.*



WARNING: *Only connect the DC and AC power and grounding wires with the AC and DC disconnect switches off and the circuits isolated from AC power from the grid and DC power from the array.*



WARNING: *Make sure to connect the inverter and other exposed metal equipment in the system to the grounding electrode system through the installation of the Grounding Electrode Conductor(s) and Equipment Grounding Conductors before proceeding to connect any DC or AC power wires.*



WARNING: *Only make AC connections directly to the lugs within the AC disconnect switch and DC connections to the lugs within the DC disconnect switch.*



NOTE: *All grounding and power wiring terminals are dual rated for Copper and Aluminum Wire. When using aluminum wire exercise best industry practices to ensure a reliable connection; thoroughly clean the conductor just prior to making the electrical connection and use an oxide inhibitor to prevent the formation of aluminum oxide.*

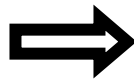

NOTE: *Grounding and power wiring terminals are rated to 167°F (75°C).*



NOTE: *When conduit hubs are used for DC and AC cable entry in an outdoor or wet location, rain-tight or wet location hubs that comply with the requirements in the Standard For Fittings For Conduit and Outlet Boxes, UL514B, are to be used.*

AC grounding and power connections are made in the AC disconnect switch of the inverter. The type of AC disconnect switch provided with the inverter depends on the inverter power rating, output voltage, and fusing specified by the customer (i.e. fused or unfused).

DC grounding and power connections are made in the DC disconnect switch of the inverter. The type of DC disconnect switch provided with the inverter depends on the inverter power rating and DC overcurrent protection specified by the customer (i.e. fuses or breakers, amperage, and quantity).

4.1 Grounding

The PVI 50-100KW inverter has grounding connection points in the DC and AC disconnect switches as listed below. These points are used for Grounding Electrode Conductor (GEC) and Equipment Grounding Conductor (EGC) connections. PV systems have EGC and GEC conductor requirements

on both the AC and DC points of entry. GEC(s) and EGC(s) should be sized and installed per the electrical code requirements of the Area Having Jurisdiction.

- DC Disconnect Switch
 - Ground Lug – For DC GEC connection. Depending on the grounding system configuration, the DC ground lug may serve as the connection point for combined:
 - DC GEC and AC GEC
 - DC GEC, AC GEC, and AC EGC
 - Ground Bar – For DC EGC connection(s)

- AC Disconnect Switch
 - Ground Lug (400A AC disconnect switch only) – For AC GEC in systems with separate DC and AC GEC's.
 - Ground Bar – For AC EGC connection(s). Depending on the grounding system configuration, the AC ground bar may also serve as the connection point for the AC GEC.

The DC and AC grounding connection points are internally bonded within the inverter along with the inverter enclosure, disconnect switches, and other internal metal components and circuits that require a connection to ground. The grounding circuit is isolated from the internal isolation transformer neutral point and optional neutral kit.

4.2 AC Grounding Connections

AC grounding connection locations, connection quantity, conductor range, and terminal torque requirements are shown below.

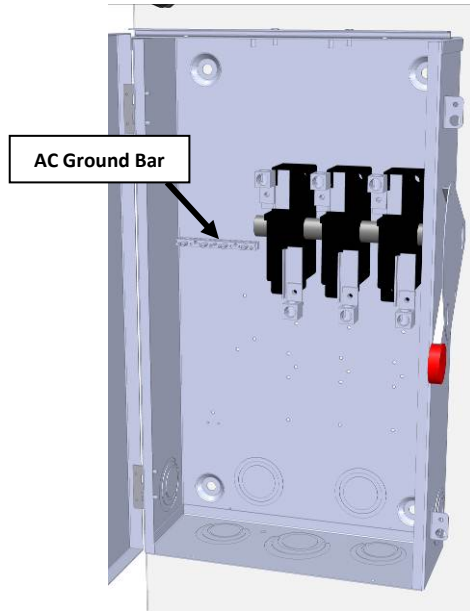

**Fig. 4.1a AC Ground Connection – 200A
(200A Unfused AC Disconnect Switch Shown)**

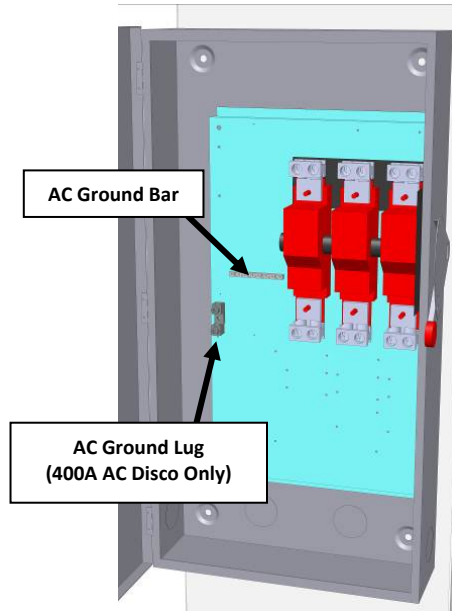

**Fig. 4.1b AC Ground Connection – 400A
(400A Unfused AC Disconnect Switch Shown)**

AC Disconnect Switch Type*	AC Ground Connection	Max Number of Connections	Conductor Range	Torque
200A	Ground Bar	2	6 AWG - 1/0 AWG	40 in-lbs
400A	Ground Bar	2	4 AWG - 1/0 AWG	40 in-lbs
	Ground Lug	1	2 AWG– 250 kcmil	275 in-lbs

*See Tables 4.3 & 4.4 to determine the AC disconnect switch type by inverter model.

Table 4.1 – AC Ground Conductor Sizes & Torques

4.3 DC Grounding Connections

DC grounding connection locations, connection quantity, conductor range, and terminal torque requirements are shown below.

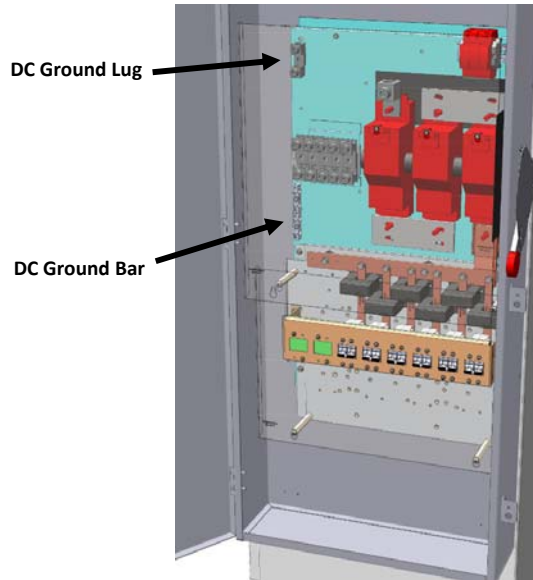

**Fig. 4.2 DC Ground Connection
(600A DC Disconnect Switch w/ DC Breakers Shown)**

DC Disconnect Switch Type*	DC Ground Connection	Max Number of Connections	Conductor Range	Torque
400A	Ground Bar	4	14 - 1/0 AWG	40 in-lbs
	Ground Lug	1	6AWG - 250kcmil	275 in-lbs
600A	Ground Bar	5	14 - 6 AWG	40 in-lbs
	Ground Lug	1	6AWG - 250kcmil	275 in-lbs

**See Table 4.6 to determine the DC disconnect switch type by inverter model.*

Table 4.2 – DC Ground Conductor Sizes & Torques

4.4 AC Power Connections

➔ NOTE: Each AC lug is designed for single conductor use only. Where multiple lugs per phase are provided, each lug is designed for single conductor use only.

➔ NOTE: Note that each inverter power rating is offered with the option of either a fused or unfused AC disconnect switch. The installer should refer to the current requirements for the specific inverter power rating, AC voltage, and disconnect switch type (fused/unfused) to determine the appropriate wire sizes.

➔ NOTE: The phase rotation of the grid connections to the inverter must follow the L1/A, L2/B and L3/C **clockwise** order.

➔ NOTE: When a fused AC disconnect switch is not provided, overcurrent protection of AC power output cables shall be provided by others according to local, state, and national code requirements.

The PVI 50-100KW models come with either a standard AC disconnect switch without fuses or optional fused AC disconnect switch (depending on what was ordered). The AC Power Wiring connections are made within the inverter's AC disconnect switch as shown below.

Note that the AC disconnect switches of PVI 50-100KW inverters are load break rated.

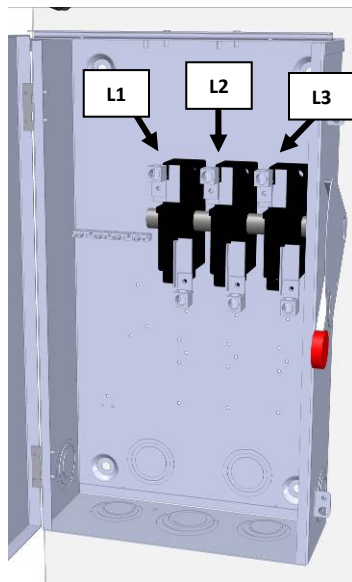

Fig. 4.3 AC Power Connections - 200A
(200A Unfused AC Disconnect Switch Shown)

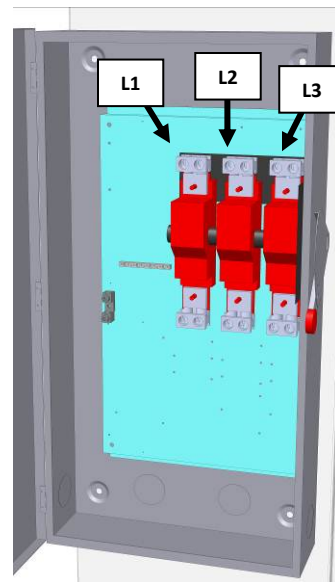

Fig. 4.4 AC Power Connections - 400A
(400A Unfused AC Disconnect Switch Shown)

AC Cable Entry

The AC cable entry location depends on the AC disconnect switch current rating and orientation (side facing or forward facing). Use the following tables to determine which disconnect switch your inverter uses, and then refer to the customer interface drawing (DOCR-070190) for AC cable entry locations.

AC Voltage Drop

AC voltage drop should be minimized to avoid nuisance tripping resulting from increased AC voltage seen at the inverter's output terminals as the inverter feeds current into the grid. Minimizing AC voltage drop also results in higher system efficiency. An AC voltage drop of less than 1% is recommended.

The table below pertains to the standard AC disconnect switches without fuses. It includes requirements for the AC conductor size, the number of terminals available, proper terminal torque, and AC disconnect switch current ratings for all PVI 50-100KW inverter models. The PE models use the same AC disconnect switches as the standard models.

AC VOLTAGE	INVERTER MODEL With Unfused AC Disconnect Switch	TERMINALS PER PHASE	WIRE GAUGE	TERMINAL TORQUE	DISCONNECT SWITCH SIZE
208V	PVI 50KW 208V	1	2/0AWG - 250kcmil	275 in-lbs	200A
	PVI 60KW 208V	1	4/0AWG - 250kcmil	275 in-lbs	200A
	PVI 75KW 208V	1	300kcmil - 750kcmil	500 in-lbs	400A
		2	1/0AWG - 300kcmil	500 in-lbs	
	PVI 85KW 208V	1	350kcmil - 750kcmil	500 in-lbs	400A
		2	1/0AWG - 300kcmil	500 in-lbs	
PVI 100KW 208V	1	500kcmil - 750kcmil	500 in-lbs	400A	
	2	2/0AWG - 300kcmil	500 in-lbs		
240V	PVI 50KW 240V	1	1/0AWG - 250kcmil	275 in-lbs	200A
	PVI 60KW 240V	1	3/0AWG - 250kcmil	275 in-lbs	200A
	PVI 75KW 240V	1	4/0AWG - 750kcmil	500 in-lbs	400A
		2	1/0AWG - 300kcmil	500 in-lbs	
	PVI 85KW 240V	1	300kcmil - 750kcmil	500 in-lbs	400A
		2	1/0AWG - 300kcmil	500 in-lbs	
PVI 100KW 240V	1	350kcmil - 750kcmil	500 in-lbs	400A	
	2	1/0AWG - 300kcmil	500 in-lbs		
480V	PVI 50KW 480V	1	4AWG - 250kcmil	275 in-lbs	200A
	PVI 60KW 480V	1	3AWG - 250kcmil	275 in-lbs	200A
	PVI 75KW 480V	1	2AWG - 250kcmil	275 in-lbs	200A
	PVI 85KW 480V	1	1AWG - 250kcmil	275 in-lbs	200A
	PVI 100KW 480V	1	1/0AWG - 250kcmil	275 in-lbs	200A
600V	PVI 50KW 600V	1	6AWG - 250kcmil	275 in-lbs	200A
	PVI 60KW 600V	1	4AWG - 250kcmil	275 in-lbs	200A
	PVI 75KW 600V	1	3AWG - 250kcmil	275 in-lbs	200A
	PVI 85KW 600V	1	2AWG - 250kcmil	275 in-lbs	200A
	PVI 100KW 600V	1	1AWG - 250kcmil	275 in-lbs	200A

Table 4.3 – AC Power Conductor Sizes & Torques for Standard AC Disconnect Switches

The table below pertains to the optional AC disconnect switches with fuses. It includes requirements for the AC conductor size, the number of terminals available, proper terminal torque, and AC fuse and disconnect switch current ratings for all PVI 50-100KW inverter models. The PE models use the same AC disconnect switches as the standard models.

AC VOLTAGE	INVERTER MODEL With Fused AC Disconnect Switch	AMPERAGE OF INTEGRATED FUSING	TERMINALS PER PHASE	WIRE GAUGE	TERMINAL TORQUE	DISCONNECT SWITCH SIZE
208	PVI 50KW 208V	175A	1	2/0AWG - 250kcmil	275 in-lbs	200A
	PVI 60KW 208V	225A	1	4/0AWG - 750kcmil	500 in-lbs	400A
			2	1/0AWG - 300kcmil	500 in-lbs	
	PVI 75KW 208V	300A	1	300kcmil - 750kcmil	500 in-lbs	400A
			2	1/0AWG - 300kcmil	500 in-lbs	
	PVI 85KW 208V	300A	1	350kcmil - 750kcmil	500 in-lbs	400A
2			1/0AWG - 300kcmil	500 in-lbs		
PVI 100KW 208V	350A	1	500kcmil - 750kcmil	500 in-lbs	400A	
		2	2/0AWG - 300kcmil	500 in-lbs		
240	PVI 50KW 240V	150A	1	1/0AWG - 250kcmil	275 in-lbs	200A
	PVI 60KW 240V	200A	1	3/0AWG - 250kcmil	275 in-lbs	200A
	PVI 75KW 240V	225A	1	4/0AWG - 750kcmil	500 in-lbs	400A
	PVI 85KW 240V	300A	1	300kcmil - 750kcmil	500 in-lbs	400A
			2	1/0AWG - 300kcmil	500 in-lbs	
	PVI 100KW 240V	300A	1	350kcmil - 750kcmil	500 in-lbs	400A
2			1/0AWG - 300kcmil	500 in-lbs		
480	PVI 50KW 480V	110A	1	2AWG - 250kcmil	275 in-lbs	200A
	PVI 60KW 480V	110A	1	2AWG - 250kcmil	275 in-lbs	200A
	PVI 75KW 480V	125A	1	2AWG - 250kcmil	275 in-lbs	200A
	PVI 85KW 480V	150A	1	1AWG - 250kcmil	275 in-lbs	200A
	PVI 100KW 480V	150A	1	1/0AWG - 250kcmil	275 in-lbs	200A
600	PVI 50KW 600V	110A	1	2AWG - 250kcmil	275 in-lbs	200A
	PVI 60KW 600V	110A	1	2AWG - 250kcmil	275 in-lbs	200A
	PVI 75KW 600V	110A	1	2AWG - 250kcmil	275 in-lbs	200A
	PVI 85KW 600V	110A	1	2AWG - 300kcmil	500 in-lbs	200A
	PVI 100KW 600V	125A	1	1AWG - 250kcmil	275 in-lbs	200A

Table 4.4 – AC Power Conductor Sizes & Torques for Fused AC Disconnect Switches

Neutral Kit Option

A neutral is not required for proper inverter operation; hence, the inverter is most often connected as a 3-wire system with no connection point for a neutral conductor. For the interconnection of the inverter as a 4-wire system, a neutral kit option is available. As shown in Figure 4.5, the kit includes a factory installed neutral lug inside the AC disconnect switch to connect a neutral conductor. When configured with the neutral kit, a jumper from the neutral lug to the isolation transformer neutral point is installed at the factory (see Simplified One-Line Drawing – Section 8.4). The neutral kit circuit is fully isolated from ground.

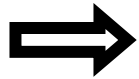

NOTE: *When a neutral conductor is connected to the inverter, currents may flow on the neutral due to site specific characteristics of the electric service feeding the project site, such as voltage imbalance and voltage harmonics. This neutral current may increase the inverter's operating temperature, reduce inverter efficiency, and shorten the inverter's life. If a neutral is connected at the inverter, it is the customer's responsibility to determine if the site will be impacted by neutral currents and to determine if additional overcurrent protection is required to protect the inverter and neutral conductor.*

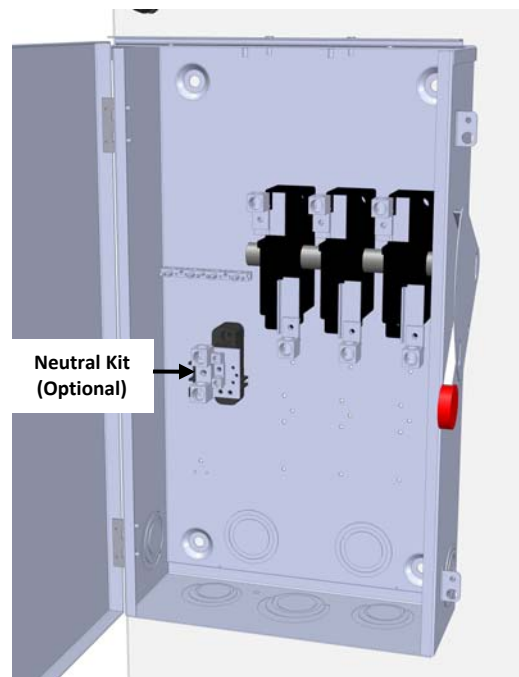

Fig. 4.5 Neutral Kit (200A Unfused AC Disconnect Switch shown)

The following table shows the number and size of neutral conductors and the torque specifications for the neutral connection. The type of neutral kit installed is determined by the AC disconnect switch. Refer to Tables 4.3 and 4.4 to find the AC disconnect switch for your specific PVI 50-100KW model.

AC DISCONNECT SWITCH TYPE	NO. OF NEUTRAL CONDUCTORS	WIRE GAUGE	TERMINAL TORQUE
200A	1	6AWG - 250kcmil	275 in-lbs
400A	3	6AWG - 250kcmil	275 in-lbs
	1 or 2	1/0AWG - 750kcmil	500 in-lbs
		1/0AWG - 300kcmil	

**See Tables 4.3 & 4.4 to determine the AC disconnect switch type by inverter model.*

Table 4.5 – AC Neutral Conductor Sizes & Torques

4.5 AC Ground Fault Detection

The PVI series of inverters are not equipped with AC ground fault protection. When AC ground fault protection is used on the onsite electrical service, determine if the ground fault device is listed to be backfed. The inverter AC output should be connected on the supply side of the device unless the device is specifically listed for a backfeed application, then the inverter may be installed on either the load or supply side of the device. Always consult the AC ground fault manufacturer for guidance on backfeeding their devices in a Code compliant manner.

4.6 DC Power Connections

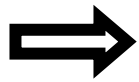

NOTE: *The PVI 50-100KW inverter models are designed for negative-grounded PV arrays only. Contact Solectria Renewables before you install a system with positive-grounded PV arrays.*



NOTE: *The maximum current from the PV array must be below the rating of the DC disconnect switch. The DC disconnect switches of the PVI 50-100KW inverters are load break rated.*

The PVI 50-100KW models come with either a standard DC disconnect switch or optional DC subcombiner located inside the DC disconnect switch enclosure. The table below indicates the DC disconnect switch current ratings for PVI 50-100KW inverters.

Inverter Power Rating	DC Disconnect Voltage Rating	DC Disconnect Current Rating
50KW, 60KW, 75KW	600 VDC	400 Amps
85KW, 100KW	600 VDC	600 Amps

Table 4.6 DC Disconnect Switch Types

Optional string subcombiners are offered. See Tables 4.8 & 4.9 and inverter spec sheet (link provided in Section 9.1) for more information on DC disconnect switch integrated overcurrent protection options (fusing or breakers, amperage, and quantity).

DC Cable Entry

The DC cable entry location depends on the DC disconnect switch current rating and orientation (side facing or forward facing). Use Table 4.7 to determine which disconnect switch your inverter uses, and then refer to the customer interface drawing (DOCR-070190) for DC cable entry locations.

The DC Power Wiring connections are made within the inverter's DC disconnect switch enclosure. The grounded conductor is bonded to the inverter's internal ground bus through the ground fault detection and interrupt circuit (GFDI). Grounded conductors should not be bonded to ground at any other point in the system. The ungrounded conductors must never be bonded to ground.

Figures 4.6a and 4.6b on the following pages show the locations of ungrounded and grounded DC power connections for some typical PVI 50-100KW DC disconnect switch and subcombiner options.

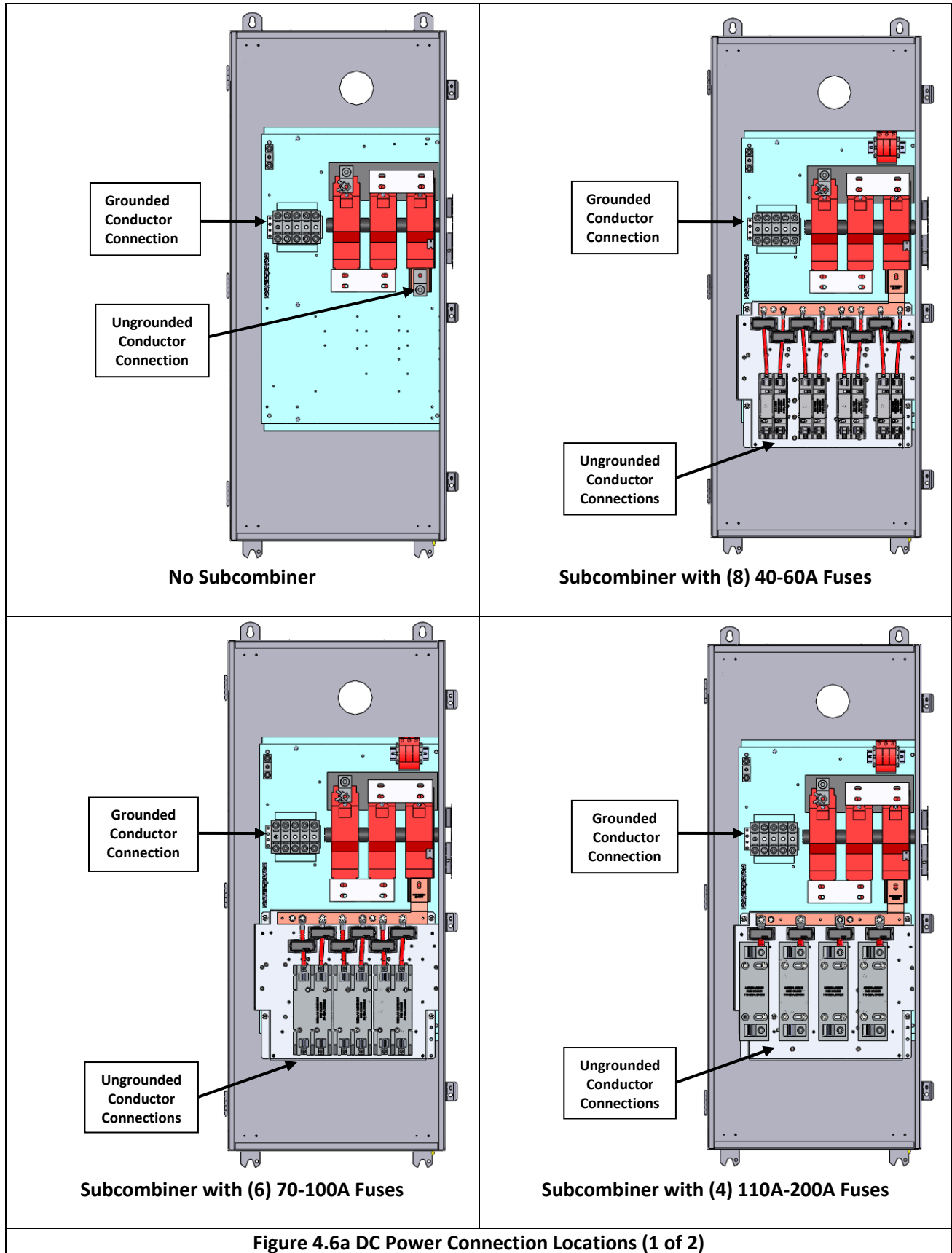

Figure 4.6a DC Power Connection Locations (1 of 2)

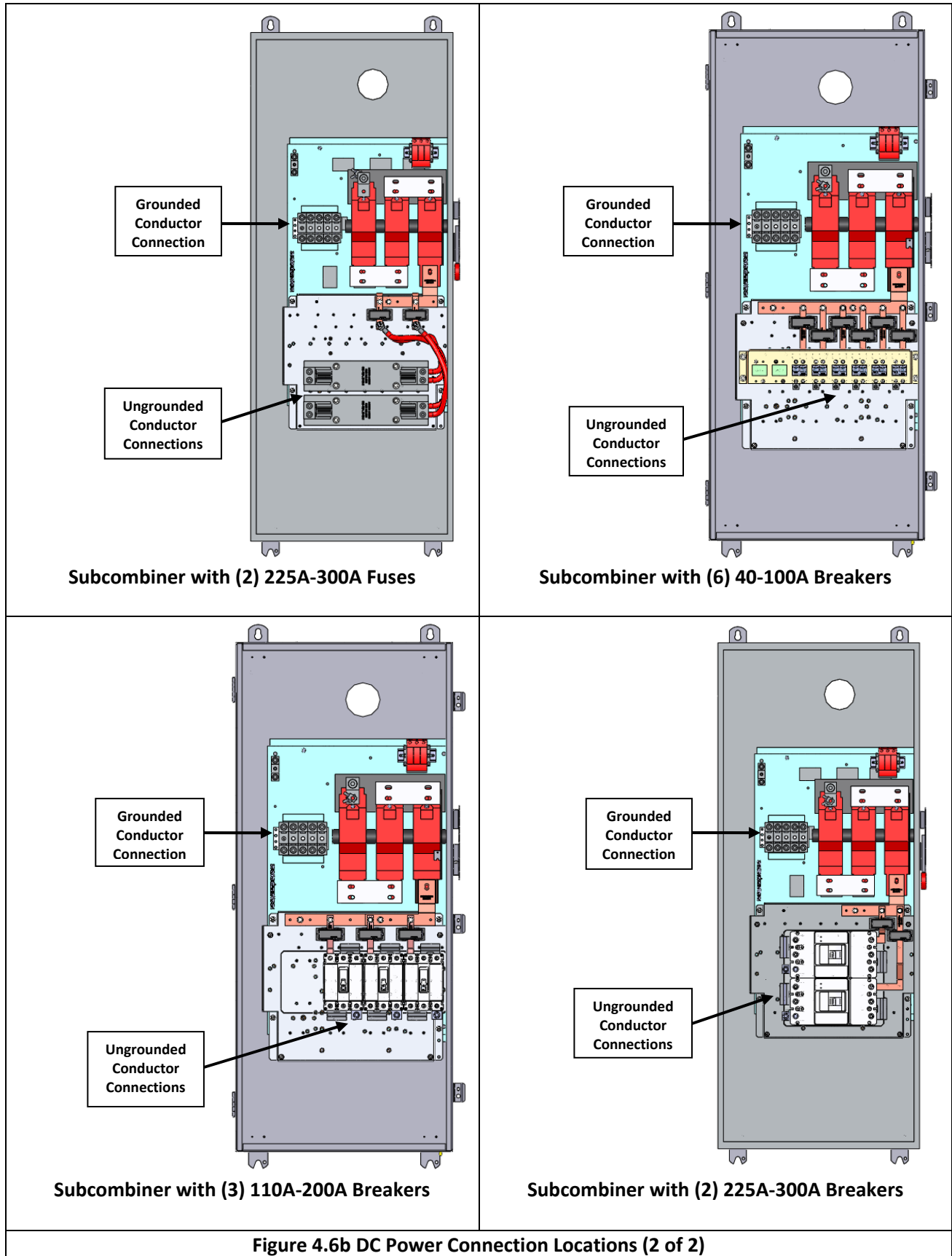
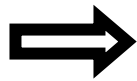

Figure 4.6b DC Power Connection Locations (2 of 2)

Standard DC Disconnect Switch

The table below includes requirements for the DC conductor size, the number of terminals available, proper terminal torque, and DC disconnect switch current ratings for the standard DC disconnect switches provided (no subcombiner) on the PVI 50-100KW. The PE models use the same DC disconnect switches as the standard models.



NOTE: *The torque is different for the grounded and ungrounded terminals on the DC disconnect switch.*

INVERTER MODEL	NO. OF TERMINALS	WIRE GAUGE	TERMINAL TORQUE (GROUNDED)	TERMINAL TORQUE (UNGROUNDED)	CURRENT RATING
PVI 50KW	2	1/0AWG - 300kcmil	275 in-lbs	500 in-lbs	400A
PVI 60KW					
PVI 75KW					
PVI 85KW	2	1/0AWG - 350kcmil	275 in-lbs	375 in-lbs	600A
PVI 100KW					

Table 4.7 DC Disconnect Switch Conductor Size and Torques

Fused DC Subcombiner

The table below includes requirements for the DC conductor size, the number of terminals available and proper terminal torque for the fused DC subcombiner options on the PVI 50-100KW.

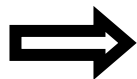

NOTE: *The torque is different for the grounded and ungrounded terminals on the fused DC subcombiner.*

FUSE CURRENT RATING	FUSE QUANTITY	NO. OF TERMINALS (per Fuse)	WIRE GAUGE	TERMINAL TORQUE (GROUNDED)	TERMINAL TORQUE (UNGROUNDED)
40A, 50A, 60A	6, 8	1	6AWG - 2AWG	275 in-lbs	45 in-lbs
70A, 80A, 90A, 100A	2, 4, 6	1	6AWG - 1/0AWG	275 in-lbs	100 in-lbs
110A, 125A, 150A, 175A, 200A	2, 3, 4	1	2AWG - 350kcmil	275 in-lbs	375 in-lbs
225A, 250A	2	2	2AWG - 350kcmil	275 in-lbs	275 in-lbs

Table 4.8 Fused DC Subcombiner Conductor Size and Torques

DC Breaker Subcombiner

The table below includes requirements for the DC conductor size, the number of terminals available and proper terminal torque for the fused DC subcombiner options on the PVI 50-100KW.

➔ NOTE: *The torque is different for the grounded and ungrounded terminals on the DC breaker subcombiner.*

BREAKER CURRENT RATING	BREAKER QUANTITY	NO. OF TERMINALS (per Breaker)	WIRE GAUGE	TERMINAL TORQUE (GROUNDED)	TERMINAL TORQUE (UNGROUNDED)
40A, 50A, 60A, 70A, 80A, 90A, 100A	2 - 8	1	8AWG - 1/0AWG	275 in-lbs	45 in-lbs
110A, 125A, 150A, 175A, 200A	2, 3, 4	1	2AWG - 300kcmil	275 in-lbs	275 in-lbs
225A, 250A, 300A	2	1	4/0AWG - 350kcmil	275 in-lbs	275 in-lbs
		2	2/0AWG - 250kcmil	275 in-lbs	375 in-lbs

Table 4.9 Fused DC Subcombiner Conductor Size and Torques

DC Breaker Damage

When tightening the DC breaker lugs use a wrench (positioned as shown below) to prevent rotation of the lug while the connection is being torqued. This method must be used when the wires are installed, inserted and mechanically torqued. This method helps prevent damage to the breaker housing.



Figure 4.7 – Lug Damage Prevention

4.7 DC Ground Fault Detection and Interruption

The inverter is equipped with an automatic DC Ground Fault Detection and Interruption (GFDI) circuit. When a single ground fault exceeding the ground fault fuse pickup value is present in the PV array or in the DC wiring to the inverter, the DC GDFI fuse will blow and a ground fault will be signaled by means of a yellow LED and a message on the front LCD display.

	DC Ground Fault Current Pickup
PVI 50KW PVI 60KW PVI 75KW PVI 85KW PVI 100KW	2 Amps (PN: Bussmann KLM-2, 2A DC, 600 VDC rated) REPLACE ONLY WITH SAME MAKE/MODEL

Table 4.10 – DC GFDI Specifications



WARNING: *In the event of a ground fault, DO NOT TOUCH any equipment (including, but not limited to: the inverter, the PV array disconnect switch, the PV array combiners, the PV panels, the PV racking system). Immediately contact the installer or another qualified person to locate and repair the source of the ground fault. Be aware that normally grounded conductors and equipment may be energized and may pose a significant shock and / or fire hazard.*



WARNING: *If the GFDI fuse blows upon connection of one or more combined strings, a ground fault in the array must be located and eliminated before proceeding. The DC ground fault is eliminated when the GFDI fuse is replaced and remains intact. Failure to obey these instructions may cause the grounded conductor to rise to potentially unsafe voltage levels.*



WARNING: *Even when the DC disconnect switch is in the off position, the ungrounded DC conductor leading up to the DC disconnect switch will remain energized on the PV side as long as the PV modules are in daylight. The inverter side of the DC disconnect switch will also remain energized after the disconnect switch has been shut off until 60 seconds after the LEDs turn off, as the DC bus capacitors in the inverter discharge.*

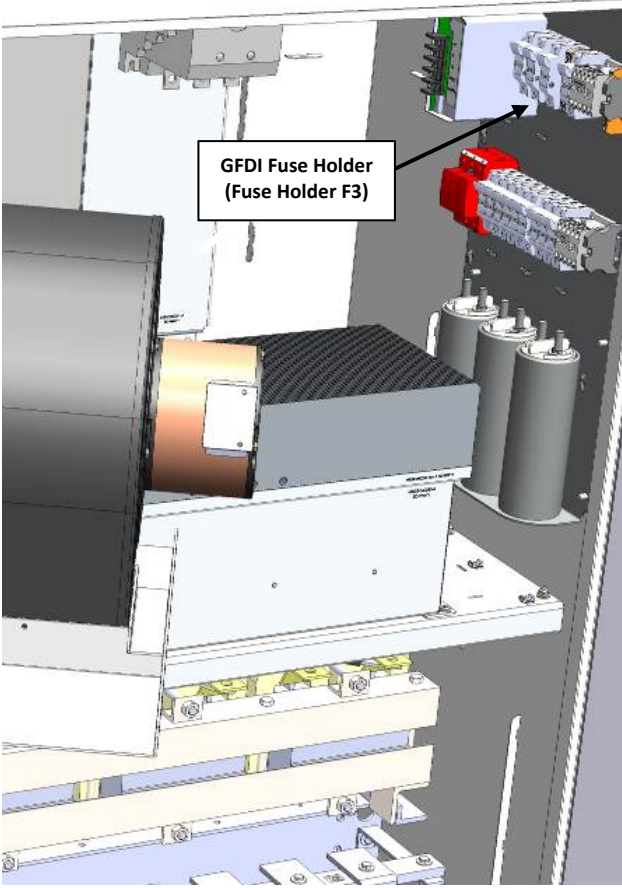

Figure 4.8 Location of GFDI Fuse

4.8 Lightning and Surge Protection

The inverter is designed with certain protections against voltage surges in accordance with IEEE 1547. The DC inputs are equipped with IEC 61643-1/-11 Class II, EN 61643-11 Type 2 surge protection devices (SPD). The SPD helps protect the inverter from surges by creating a temporary low impedance path to ground. On the DC input, separate surge paths exist from positive (+) to ground and negative (-) to ground. Each path is made by a separate insert within the SPD. A red indicator flag will mark that an insert requires replacement. The SPD's can be installed inside the DC disconnect switch. Added protection and proper grounding provisions will help protect against utility surges and surges created by indirect lightning strikes. In some instances surge and lightning can damage the equipment. Please review the warranty section for details.

4.9 Remote Shutdown and Revenue Grade Meter Terminals

The PVI 50-100KW provides dedicated terminal blocks for customer connections for remote shutdown and an RS-485 based revenue grade meter. The terminal blocks are found on a separate DIN rail located on the left wall of the inverter as shown below:

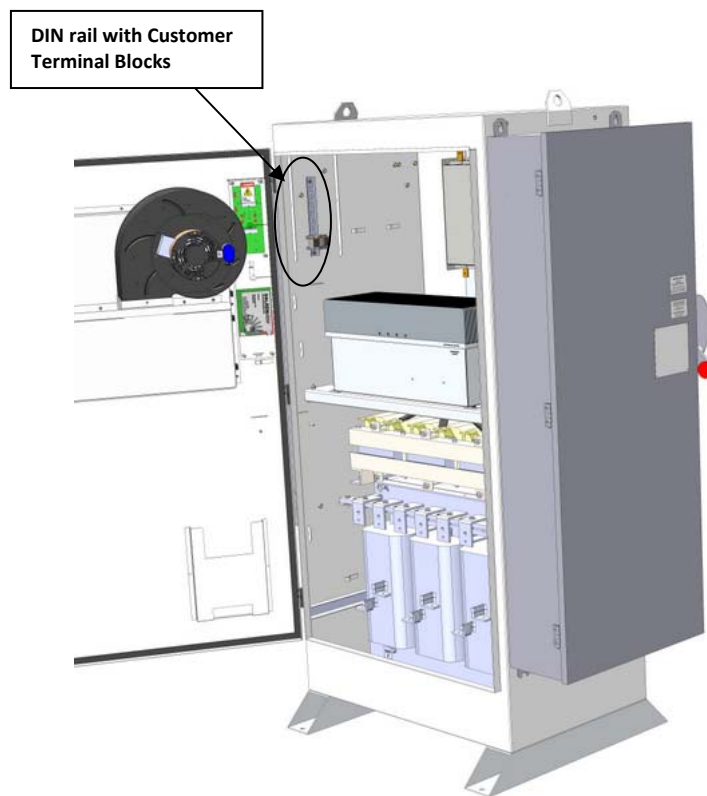

Figure 4.9 Location of Customer Connections

The terminal blocks are labeled 9-13 and are wired per the picture and table below:

Location	Connection
Terminal Block 9	Remote Shutdown Input
Terminal Block 10	Remote Shutdown Return
Terminal Block 11	Revenue Grade Meter (RS485A)
Terminal Block 12	Revenue Grade Meter (RS485B)
Terminal Block 13	Revenue Grade Meter (RS485-Gnd)

Table 4.11 – Customer Terminal Block Definition

Remote Shutdown Wiring

The PVI 50-100KW inverters feature a remote shutdown input to allow for advanced remote command and control systems. The input required is an isolated 24VDC signal that is wired to the terminal blocks on the left panel of the inverter by the installer. Once the signal is activated, the inverter will slowly ramp down power and then disconnect from the grid. The inverter will not reconnect until the signal is removed.

Typical Shutdown Ramp Time	Nominal Input Voltage	Minimum Input Voltage	Maximum Input Voltage	Minimum Current Capability	Terminal Wire Size
1 second	24VDC	21.6VDC	26.4VDC	100mADC	26 – 14AWG

Table 4.12 – Remote Shutdown Specifications

5 Commissioning the Inverter

Before commissioning, ensure that the inverter is properly secured to the mounting structure and that all power and grounding connections are made to ensure that the inverter is ready to power up.

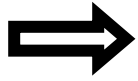

NOTE: *Make sure all tools, parts, etc. are removed from the inverter cabinet, DC and AC disconnect switches, and around the vicinity of the inverter before turning on.*



WARNING: *Make a final check of all AC and DC power and grounding wiring at the inverter and within the system before turning the inverter on.*

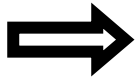

NOTE: *With the PV modules connected and inverter disconnect switches still off, perform a final check of the PV voltage and polarity using a digital volt meter by probing the positive (+) and negative (-) PV connections.*

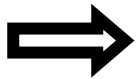

NOTE: *Verify clockwise AC phase rotation for L1, L2, L3 using a phase rotation meter.*

5.1 Turning on the Inverter



WARNING: *The inverter may only be turned on by trained and qualified personnel only. Before attempting to operate the inverter, please read the entire manual.*

1. Turn on the dedicated three-phase interconnection circuit breaker or disconnect switch at the system's point of interconnection.
2. Turn on the inverter's AC disconnect switch.
3. Turn on the inverter's DC disconnect switch.
4. Watch the LED indicators for initialization (green and red LEDs on), then a slow blinking green LED followed by a faster blinking green LED. Watch the LCD display for prompts and system status.
5. Listen for contactor closing (inverter on-line).
6. Listen for slight 60 Hz hum (transformer on-line).
7. Following the blinking green LED and high frequency switching sound you should see a solid green LED. This confirms that the inverter is operating normally. The LCD display will show the AC Power (PAC) and Energy (EAC).

5.2 Operation

The control electronics and DSP will be active as soon as DC (PV) voltage reaches 245 VDC. The inverter will go on-line with the utility/building 3-phase grid when the DC voltage first exceeds 400 VDC (strike voltage). Next, the inverter will load the array, bringing the DC voltage down from 400 VDC. Once there is enough PV power to back-feed the grid, the inverter will produce power according to what is being delivered by the PV array.

There is a 24 VDC power supply inside the inverter. This supply is powered from the PV array and begins operation when the voltage is above 250 VDC. 24 volts is required for the display, control relays, GFDI circuits, SolrenView, and the SolrenView AIR and Switch options.

5.3 Turning Off the Inverter

1. Use the SolrenView HMI keypad to temporarily disable the power output by pressing and holding the **ESCAPE** button for two seconds.
2. Turn off the inverter's DC disconnect switch.
3. Turn off the inverter's AC disconnect switch.
4. Wait at least one minute for the capacitor bank to discharge before restarting the inverter.

6 Inverter Control and Communications” in the PVI 50-100

Every Solectria Renewables commercial inverter includes a SolrenView gateway integrated into the inverter door. This device performs multiple functions including control, monitoring and data logging.

From the inverter a user can configure, monitor and control the inverter using a human-machine interface (HMI). This HMI consists of the LCD display, four buttons, and LED indicators for power, ground fault, and error.

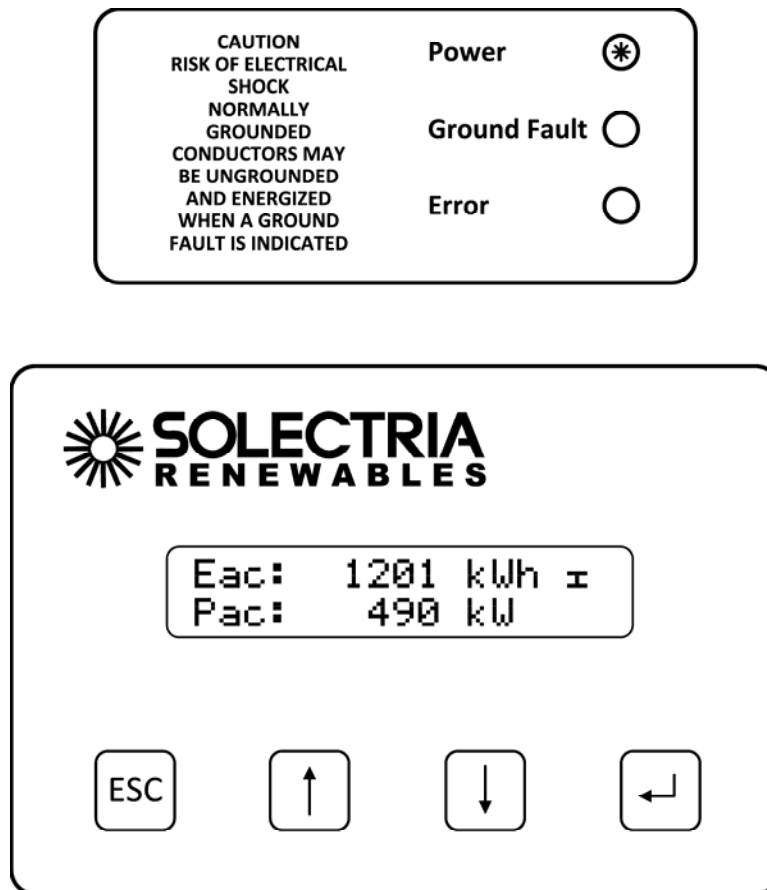

Figure 6.1 – SolrenView Gateway HMI (Front)

The back side of SolrenView gateway, which can only be physically accessed when the inverter door is open, provides connectivity to data monitoring systems. Solectria Renewables’ own SolrenView.com data monitoring system can be interfaced using Ethernet over twisted pair. Third-party monitoring systems can be connected to the inverter using Modbus RTU protocol (RS-485.)



WARNING: SolrenView gateway connections must be made by qualified personnel only. To reduce the risk of electric shock, you should never attempt to open the inverter, DC, or AC enclosure doors, or perform any service or troubleshooting without prior training. Before attempting to service or troubleshoot the inverter, please read the entire manual.

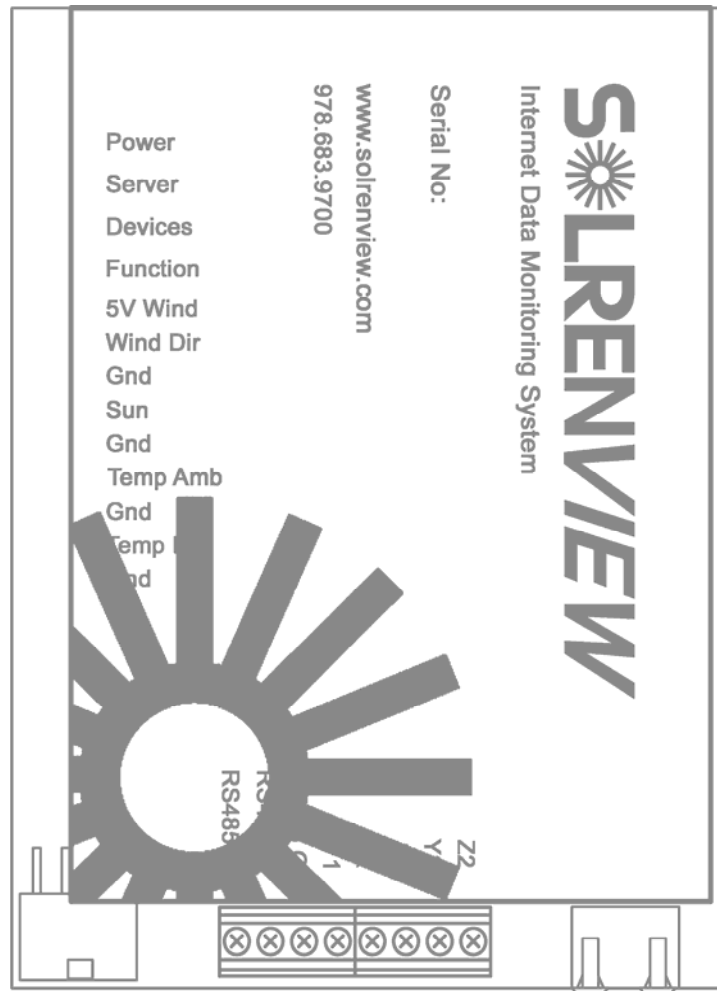

Figure 6.2 – SolrenView Gateway Data Monitoring Connectivity (Back)

LED Indicators

The LED indicators mounted on the front left of the inverter enclosure just above the LCD screen allow the installer and user to see the current status of the inverter.

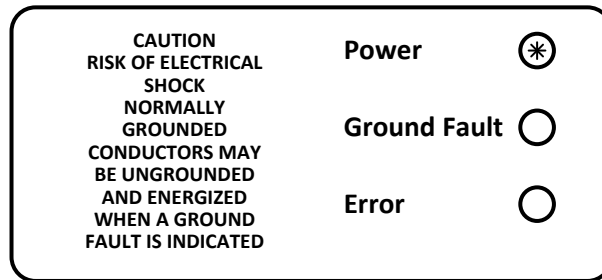







Figure 6.3 – LED Indicators at Normal Status

The basic LED indicator statuses are as follows:

- | | | |
|---------------------|--------------------------------------------------------------------------------------------|------------------------------------------------------------------------------------------------------------------------------------|
| Power |  GREEN | The inverter is powered and able to feed the grid. |
| |  UNLIT | The inverter is unpowered. |
| Ground Fault |  YELLOW | A ground fault in the PV array has been detected. The ground fault must be located and repaired before the inverter will function. |
| |  UNLIT | No ground fault has been detected. |
| Error |  RED | The inverter is not providing power because of an error or fault. |
| |  UNLIT | The inverter is operating normally. |

For other LED indications please contact Solectria Renewables Customer Support.







WARNING: *If the yellow Ground Fault indicator is lit then normally grounded conductors may be ungrounded and energized. Do not touch the inverter as there is a risk of electrical shock. For maintenance, please contact Solectria Renewables or an authorized installer by visiting <http://www.solectria.com> or by calling +1-978-683-9700.*

6.1 Button Descriptions

The SolrenView HMI is controlled by four buttons that are integrated into the inverter door. These buttons are operated by momentarily pushing the center of the button.

The buttons perform the following functions:

ESCAPE		To move up a level from the current menu. To cancel changing a data value. Hold for two seconds to STOP or START the inverter from the Main Display
UP		To scroll up within the individual menu items. To increase a data value.
DOWN		To scroll down within the individual menu items. To decrease a data value.
ENTER		To enter into the selected menu. To begin to edit a data value. To accept a data value.

6.2 Main Display

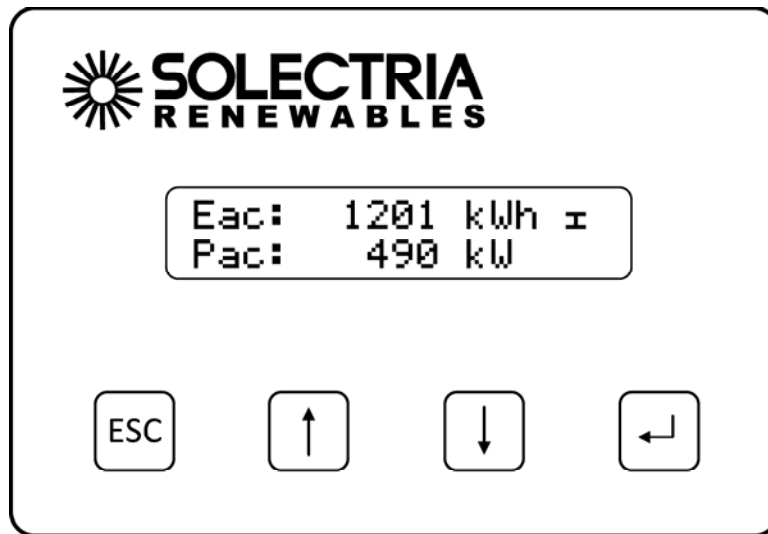

Figure 6.4 Main Display

During normal inverter operation the Main Display shows **AC Energy (Eac)** and **AC Power (Pac)**. The display updates every few seconds with new data from the inverter. Units are dynamically displayed based on the energy and power levels.

6.3 Accessing the Menu

From the **Main Display** press the **ENTER** button to access the menu.

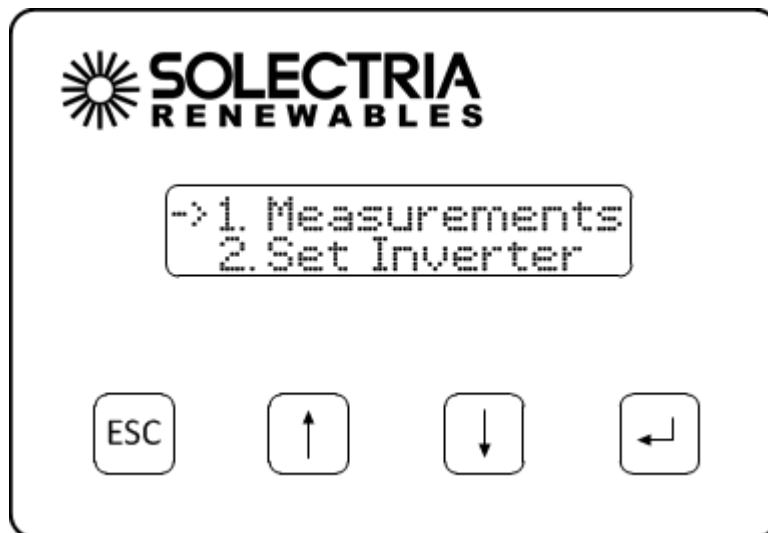
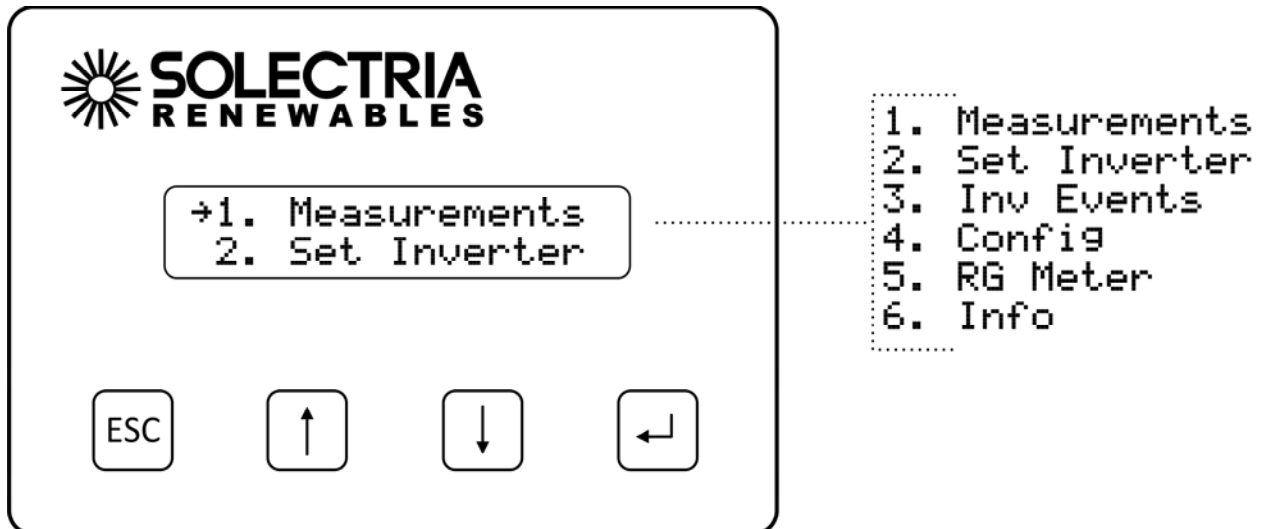

Figure 6.5 Main Menu

6.4 Navigating the Menu Structure

The **Main Menu** allows the user to configure, monitor and control inverter functions. The selected menu option is shown with an arrow on the left. Please note that the display only shows two menu options at a time and will scroll to show the other options.



Press the **DOWN** or **UP** button to change the selected menu option, as indicated by the arrow.

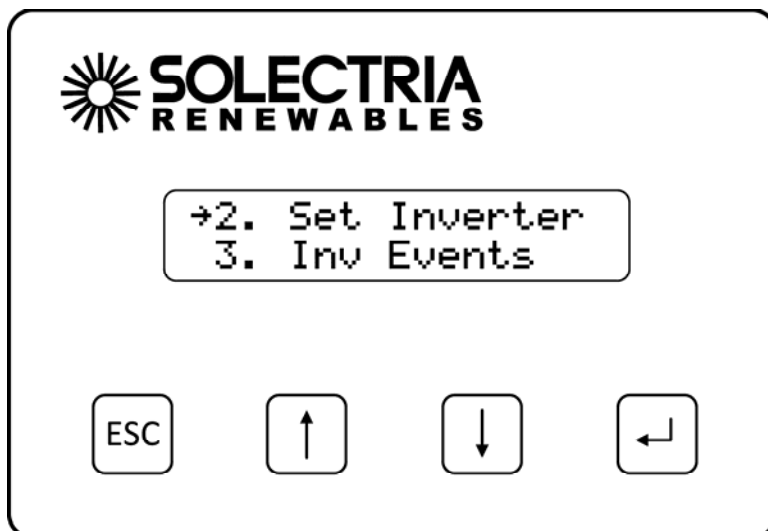

Press the **ENTER** button to activate the selected function or submenu.

Hint: All menus wrap around. Pressing the **UP** button when the at the top of a menu will select the bottom-most menu option. Pressing the **DOWN** button when at the bottom of a menu will select the top-most menu option.

6.5 Displaying Inverter Measurements

1. From the **Main Menu** select the **Measurements** function and then press the **ENTER** button.

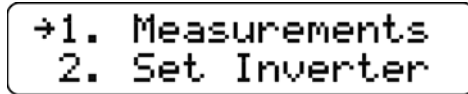

2. The display will show the AC Energy readout:

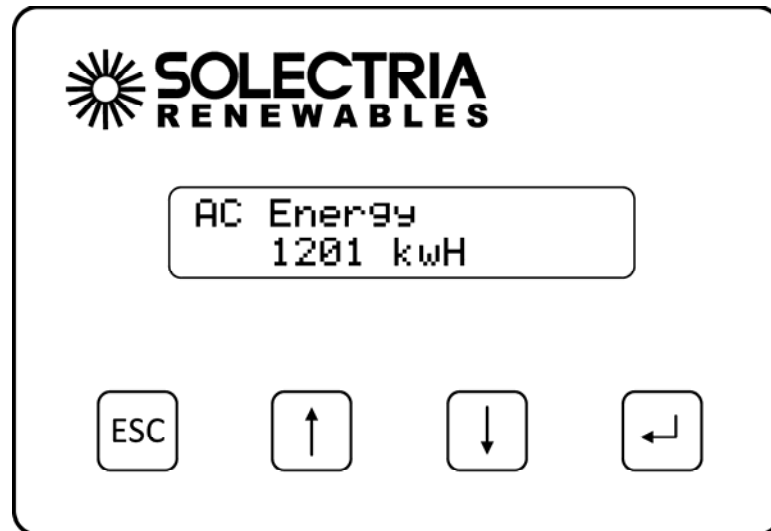

Figure 6.6 – Measurements Function

3. Press the **DOWN** or **UP** buttons to display different measurement values.
4. Press the **ESCAPE** button to return to the **Main Menu**.

The following table summarizes the measurements available:

AC Energy	<i>Cumulative AC Energy (kWh)</i>
AC Power	<i>AC Power output (W)</i>
AC Voltage	<i>AC Voltage, Three-phase (V)</i>
AC Frequency	<i>AC Frequency (Hz)</i>
AC Current	<i>AC Current, Three-phase average (A)</i>
DC Current #1-2	<i>DC Current(A) #1- 2 (Only available with SolZone)</i>
DC Current #3-4	<i>DC Current(A) #3-4 (Only available with SolZone)</i>
DC Current #5-6	<i>DC Current(A) #5-6 (Only available with SolZone)</i>
DC Current #7-8	<i>DC Current(A) #7-8 (Only available with SolZone)</i>
DC Voltage	<i>DC Voltage (V)</i>
Apparent Power	<i>Apparent AC Power output (VA)</i>
Reactive Power	<i>Reactive AC Power output (VAr)</i>
Reactive Power Avail.	<i>Available Reactive AC Power output (Var)</i>
React. Energy (+)	<i>Cumulative reactive energy generated (kVArh)</i>
React. Energy (-)	<i>Cumulative reactive energy received (kVArh)</i>
Int. Temp Sensor 1	<i>Internal temperature Sensor #1 (°C)</i>
Int. Temp Sensor 2	<i>Internal temperature Sensor #2 (°C)</i>
Int. Temp Sensor 3	<i>Internal temperature Sensor #3 (°C)</i>



NOTE: *Data for measurements is only available when inverter is operating.*

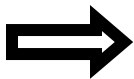

NOTE: *DC Currents 1-8 are only available if the SolZone sub-array monitoring option is installed.*

6.6 Controlling the Inverter

Many inverter functions can be controlled through the HMI under the **Set Inverter** menu option. The power can be temporarily disabled or curtailed. Third-party RS-485 Modbus settings can be viewed and modified, including inverter id and baud rate. Inverter AC voltage and frequency trip settings can be viewed and modified.

The following table summarizes the control functions:

Power Disable	<i>Temporarily disables the AC output of the inverter</i>
Inverter ID	<i>Serial port address/ID of the inverter</i>
Baud Rate	<i>Serial port baud rate (19200 or 9600)</i>
Vac Very High	<i>AC Voltage Critical High Trip Setting</i>
Vac High	<i>AC Voltage High Trip Settings</i>
Vac Low	<i>AC Voltage Low Trip Settings</i>
Vac Very Low	<i>AC Voltage Critical Low Trip Setting</i>
Fac Low	<i>AC Frequency Low Trip Setting</i>
Fac Very Low	<i>AC Frequency Critical Low Trip Setting (not adjustable)</i>
Fac High	<i>AC Frequency High Trip Setting (Not adjustable)</i>
Limit Power	<i>AC Power Curtailment (%)</i>
Restart Delay	<i>UL Reconnect wait time in minutes/seconds</i>
Password	<i>4-digit pin code to protect settings</i>

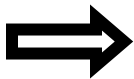

NOTE: *Data for many functions is only available when inverter is operating.*

6.7 Stopping and Starting the Inverter



WARNING: *Before conducting any maintenance or service on the PV System the inverter disconnect switches must be set to the “OFF” position and the absence of voltage must be verified by qualified personnel. Do not rely on HMI functions to stop the inverter as a reset might cause the inverter to start unexpectedly.*

Quick Stop and Start

The Inverter can be temporarily stopped so that it ceases to export power to the grid. Hold down the **ESCAPE** button for two seconds to **temporarily stop** the inverter if it is running. Likewise, hold down the **ESCAPE** button for two seconds to **initiate inverter starting** if it is stopped.

Alternatively, the inverter can be started and temporarily stopped through the menu.

1. From the **Main Menu** select the **Set Inverter** function and then press the **ENTER** button.

```
→2. Set Inverter
  3. Inv Events
```

2. The **Power Stopped** status will be displayed, indicating the current status.

```
1. Power Stopped:
→No
```

3. Press the **ENTER** button. The display prompt will change to **Power Stop** and the setting can be modified. Press the **DOWN** button to change the setting to **Yes**.

```
Power Stop:
  Yes
```

4. Press the **ENTER** button to accept the setting. The inverter will shut down.

```
Power Stop:
  Stopping...
```

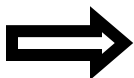

NOTE: *To start the inverter, change the **Power Stop** setting in step 3 to **No** instead of **Yes**.*

6.8 Accessing Password Protected Functions

Certain menu functions can only be accessed after the four digit password (or PIN) is entered through the HMI interface.

1. Select the **Set Inverter** submenu from the **Main Menu**.



→2. Set Inverter
3. Inv Events

2. Select the **Password** function at the bottom of the **Set Inverter** submenu.

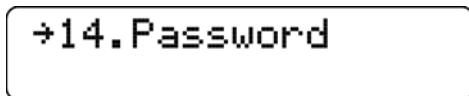

→14. Password

Hint: This option can quickly be accessed by pressing the **UP** button from the top of the **Set Inverter** submenu, as the menu wraps around.

3. The Password screen will appear.

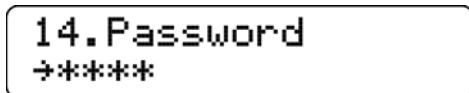

14. Password
→*****

4. Press the **ENTER** button to begin entering the default password (PIN).

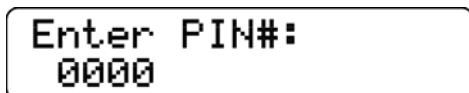

Enter PIN#:
0000

5. Specify each of the four PIN digits one at a time. Press the **UP** button to increment the digit. Press the **DOWN** button to decrement the digit. Press the **ENTER** button to accept the digit. Press the **ESCAPE** button to cancel PIN entry at any point. When the fourth digit is entered the PIN entry will be evaluated and the “Password Correct” message will flash if the PIN is verified.

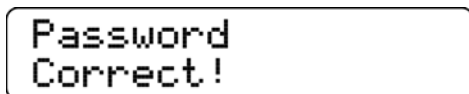

Password
Correct!

6. The **Password** screen will be shown again. Press **ESCAPE** twice to return to the **Main Menu**.

6.9 Changing the Inverter Password

The inverter password ensures that unauthorized users are not able to access certain menu functions. **The default password (0000) should be changed on commissioning. Please use a password that you can easily remember. Solectria Renewables does NOT have a master password to reset the unit.**

1. Enter the inverter password (PIN) as shown in section 6.9.
2. Once the current password has successfully been entered the password can be changed by pressing the **ENTER** button from the **Password** screen. (Second time allows changing the PIN.)

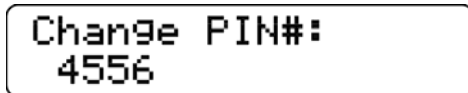

Change PIN#:
4556

3. Specify each of the four password digits one at a time. Press the **UP** button to increment the digit. Press the **DOWN** button to decrement the digit. Press the **ENTER** button to accept the digit. Press the **ESCAPE** button to cancel password entry. When the fourth digit is entered the password entry will be changed.

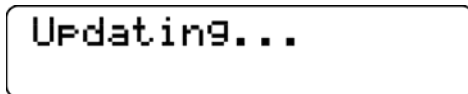

Updating...

4. The **Password** screen will be shown again. Press **ESCAPE** twice to return to the **Main Menu**.

6.10 Changing Voltage and Frequency Trip Settings

The inverter is designed to operate within certain voltage and frequency ranges, as specified by the utility. When the inverter senses that the inverter and/or grid is outside any of these ranges the inverter ceases exporting power and disconnects from the grid. This action is referred to as an inverter trip.

Inverter trip settings that can be reviewed include:

- Vac Very High Voltage
- Vac Very High Trip Time (not changeable)
- Vac High Voltage
- Vac High Voltage Trip Time
- Vac Low Voltage
- Vac Low Voltage Trip Time
- Vac Very Low Voltage
- Vac Very Low Voltage Trip Time (not changeable)
- Fac Low Frequency
- Fac Low Frequency Trip Time
- Fac Very Low Frequency (not changeable)
- Fac Very Low Frequency Trip Time (not changeable)
- Fac High Frequency (not changeable)

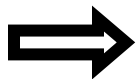

NOTE: *Prior to changing trip settings, the password must be entered through the HMI. See section 6.9 for details on entering the password.*

1. To change trip settings, first select **Set Inverter** on the Main Menu:

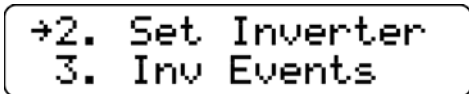

2. Next, select **VAC Very High** function on the **Set Inverter** submenu:

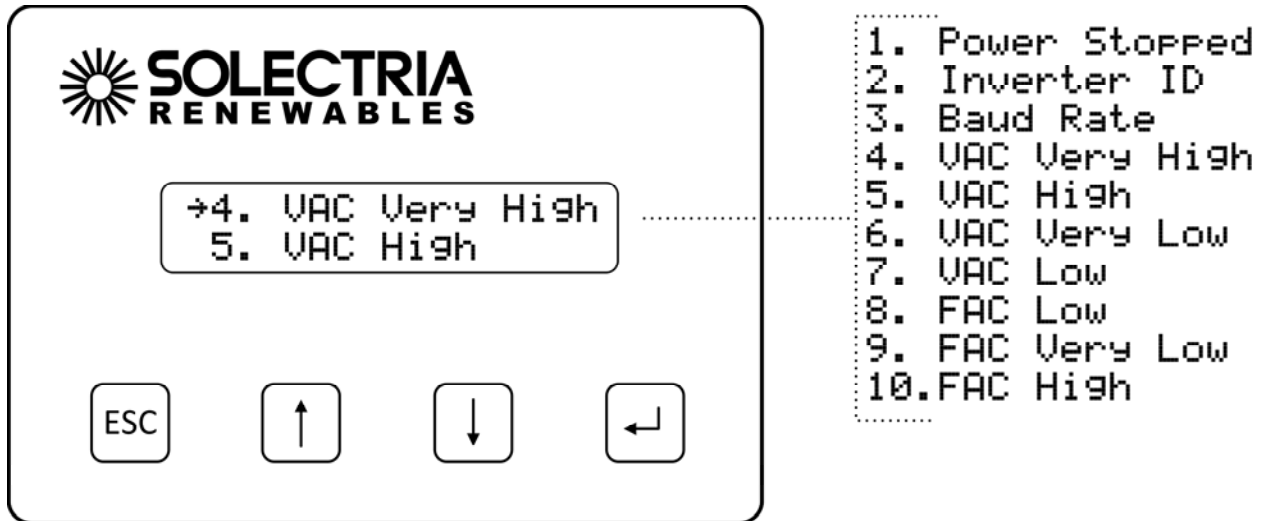

3. The **VAC Very High** function will be displayed. Press **ENTER** to modify the setting. The voltage value will flash, indicating that it can be changed. Press the **DOWN** and **UP** buttons to change the voltage setting.

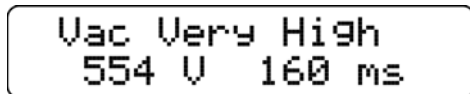

4. Press the **ENTER** button to accept the voltage setting change.
5. If the trip time is adjustable, it will flash to indicate that it can be changed. Press the **DOWN** and **UP** buttons to change the trip time setting.
6. Press the **ENTER** button to accept the trip time setting change.
7. Press the **DOWN** button to step to the next trip setting (VAC High).

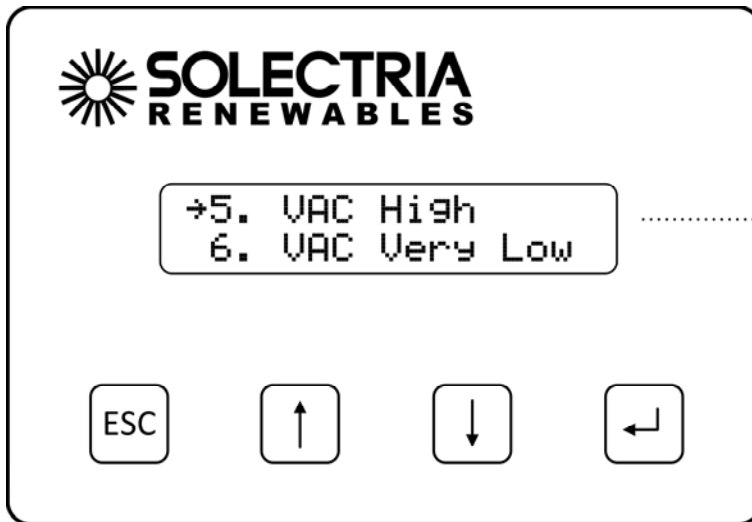

- 1. Power Stopped
- 2. Inverter ID
- 3. Baud Rate
- 4. VAC Very High
- 5. VAC High
- 6. VAC Very Low
- 7. VAC Low
- 8. FAC Low
- 9. FAC Very Low
- 10. FAC High

8. Repeat steps 3–6 for each trip setting to be modified.

6.11 Establishing Ethernet Connectivity

Before SolrenView web-based monitoring can function the inverter must be networked to the Internet. Customers ordering the SolrenView AIR 3G Router have network connectivity turned on in the factory; no additional steps are required.



WARNING: *Before conducting any maintenance or service on the PV System the inverter disconnect switches must be set to the “OFF” position and the absence of voltage must be verified by qualified personnel. Do not rely on HMI functions to stop the inverter as a reset might cause the inverter to start unexpectedly.*

To connect the inverter to the network in preparation for using SolrenView web-based monitoring:

1. Locate the Ethernet port on the back of the SolrenView gateway.

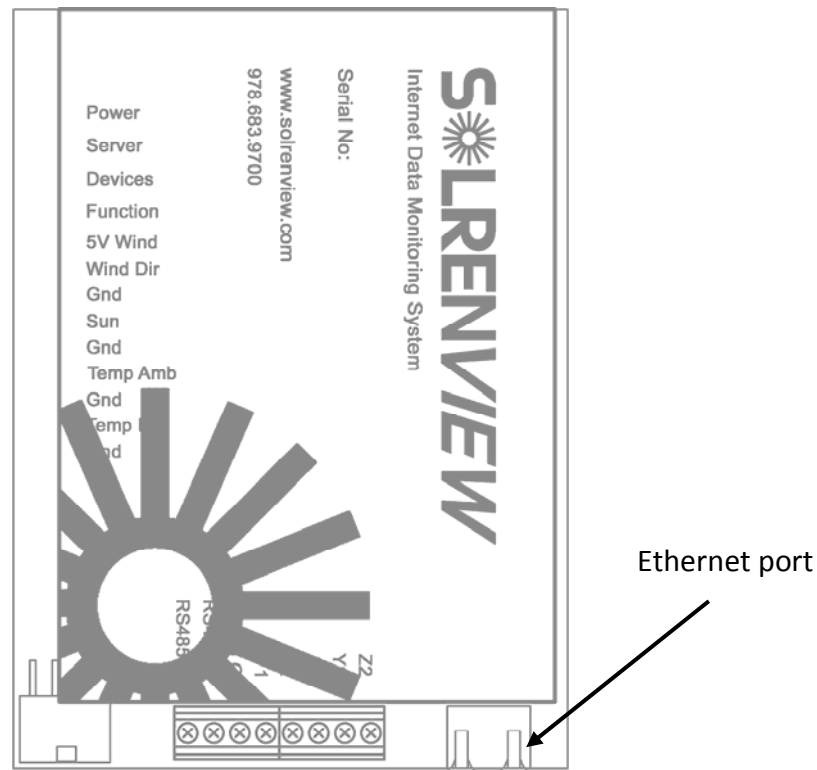
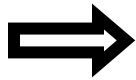

Figure 6.7 – Ethernet Connection to the back of the SolrenView gateway.

2. Install a CAT5, CAT5e, or CAT6 networking cable between the SolrenView gateway and router/switch/firewall. If molded cables cannot be used we suggest using a network cable tester to ensure cable and crimp quality.



NOTE: *The green link and yellow activity LEDs only light when the SolrenView gateway is powered.*

6.12 Setting up TCP/IP Networking

Connection to the Internet and to the SolrenView web-based monitoring service requires functioning TCP/IP protocol. This protocol runs over twisted pair Ethernet wiring and requires certain connections to properly operate. See Section 6.11 or details on establishing Ethernet connectivity.

By default the SolrenView gateway should automatically configure TCP/IP address from a network router by using the DHCP protocol. In certain cases it may be necessary to override these settings or to manually configure the TCP/IP settings.



NOTE: *The network router must be 10T capable.*

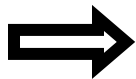

NOTE: *Customers using SolrenView AIR do not need to setup TCP/IP as this is done in the factory prior to shipping the inverter.*

6.13 Viewing Current TCP/IP settings:

1. Select the **Info** function on the **Main Menu** and the press **ENTER** button.

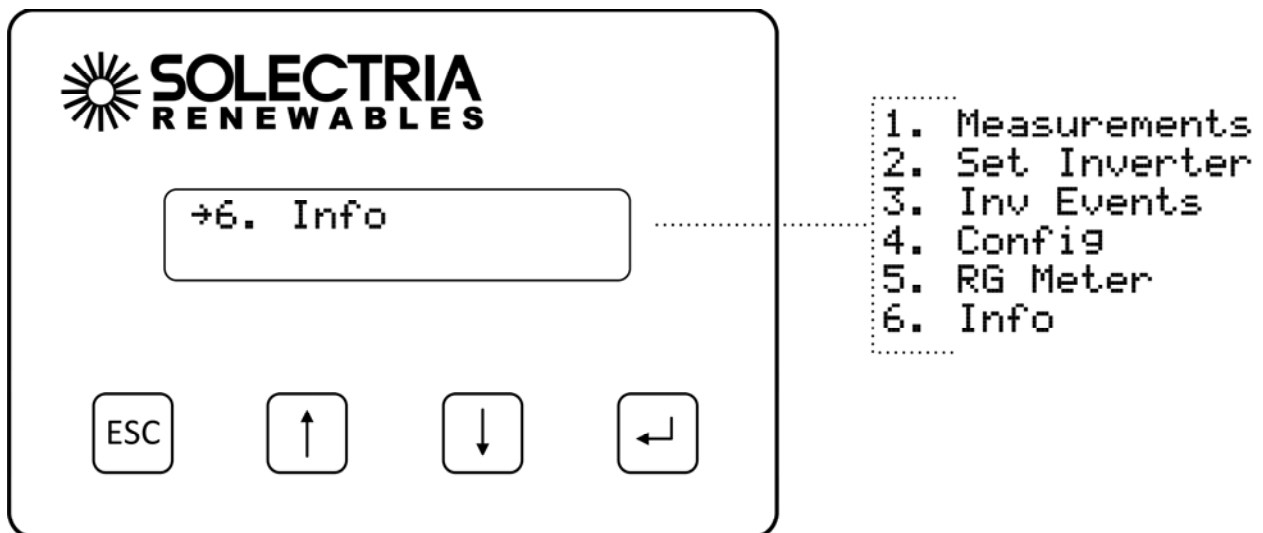

- Information on the inverter will be displayed including the IP, gateway, and netmask settings. Press the **ENTER** button to hold the display on the item of interest.

```
IP (DHCP):  
10.0.0.101
```

```
Gateway (DHCP):  
10.0.0.1
```

```
Netmask (DHCP):  
255.255.255.0
```

In the above example, the IP address, gateway and netmask values are being automatically being set through the DHCP service. The exact values displayed will depend on the configuration of the network, but typically are in one of three ranges:

```
10.0.0.0      - 10.255.255.255  
192.168.0.0  - 192.168.255.255  
172.16.0.0   - 172.31.255.255
```

- If the network is working on the Ethernet protocol level, but the SolrenView is unable to obtain settings through the DHCP service the following will typically be displayed:

```
IP (Fallback):  
192.168.1.1
```

```
Gateway:  
0.0.0.0
```

```
Netmask:  
255.255.255.0
```

If the network is not working on the Ethernet protocol level, such as if the twisted pair Ethernet cable is not plugged in, the following will be displayed:

```
LAN IP:  
Unknown
```

```
Gateway:  
0.0.0.0
```

```
Netmask:  
255.255.255.0
```

6.14 Manually Configuring Network Settings

To manually configure network settings:

1. Select **Config** from the **Main Menu** and press **ENTER**.

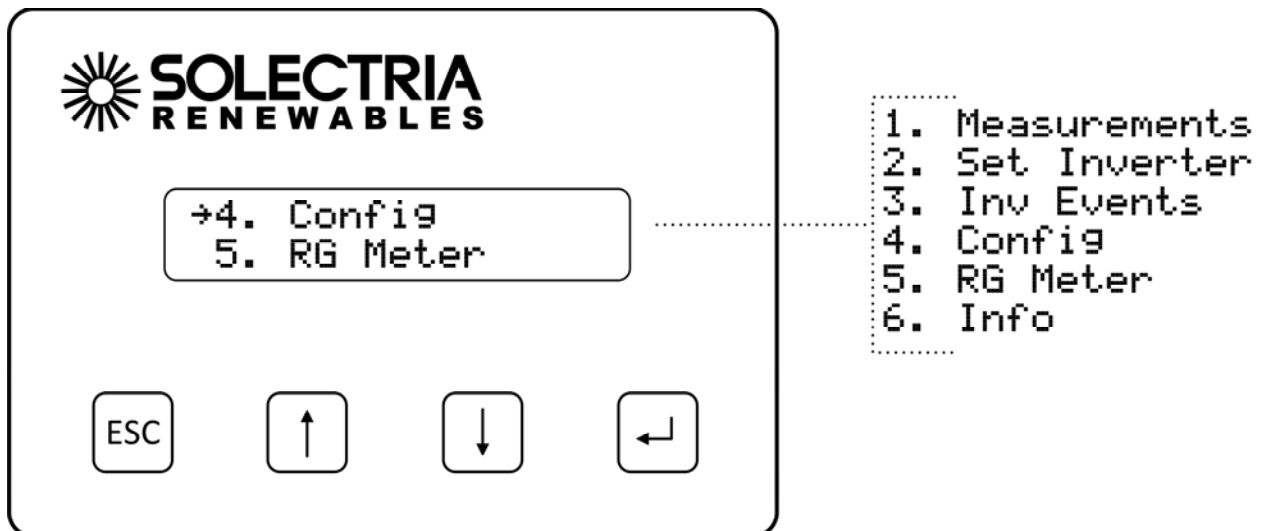

2. Select **LAN** from the **Config Menu** and press **ENTER**.

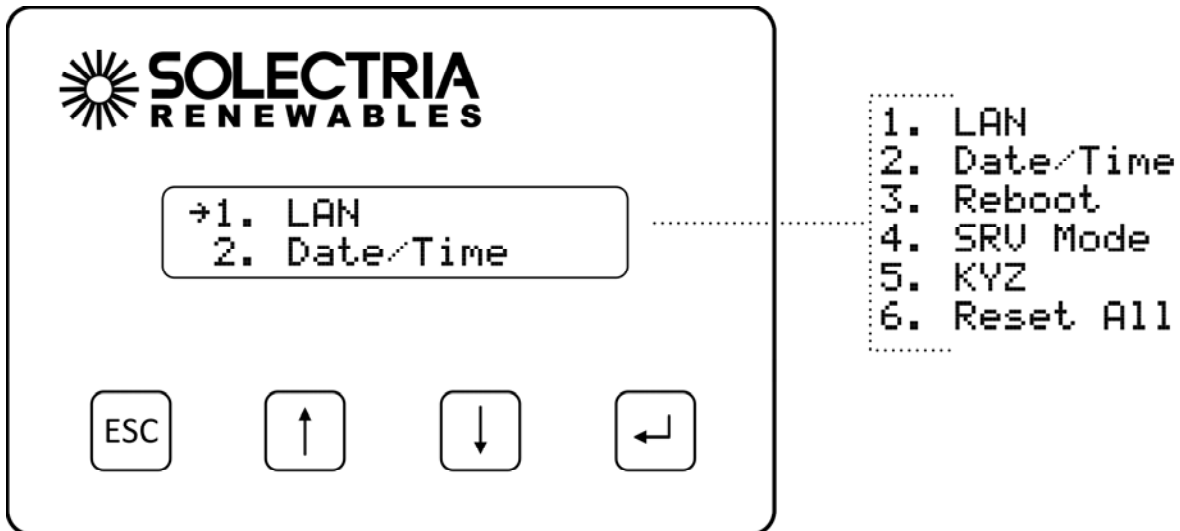

3. Select the **DHCP** function and press **ENTER** to edit this setting.

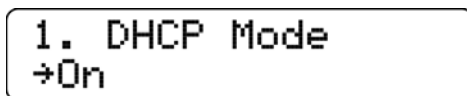

4. Press the **DOWN** button to turn **DHCP Mode Off** and press **ENTER** to save this setting.

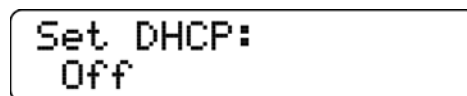

5. The **DHCP Mode** setting will now show **Off**.

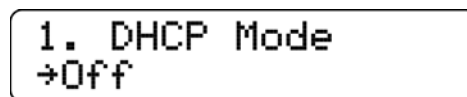

6. Press the **DOWN** button to access the **Static IP** setting.

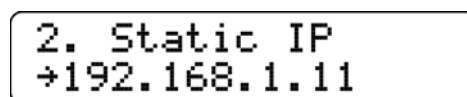

7. Press **ENTER** to modify the **Static IP** value.

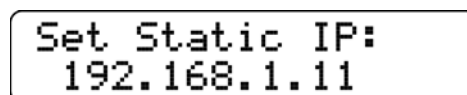

- Specify each of the four octet values (0-255), one at a time. Press the **UP** button to increment the octet. Press the **DOWN** button to decrement the octet. Press the **ENTER** button to accept the octet. Press the **ESCAPE** button to cancel entry at any point. When the fourth octet is entered the entry will be saved.

```
2. Static IP  
→192.168.1.11
```

- Press the **DOWN** button to access the **Gateway** setting. Change in the same manner that the **Static IP** was modified.

```
3. Gateway IP:  
→0.0.0.0
```

- Press the **DOWN** button to access the Netmask setting. Change in the same manner that the **Static IP** was modified.

```
4. Netmask IP:  
→255.255.255.0
```

6.15 Automatically Configuring Network Settings

When shipped from the factory, the SolrenView gateway uses DHCP to configure the TCP/IP settings. If the gateway has been changed to use static IP address the following instructions will explain how to turn on DHCP.

To configure the SolrenView gateway to use DHCP:

1. Select **Config** from the **Main Menu** and press **ENTER**.

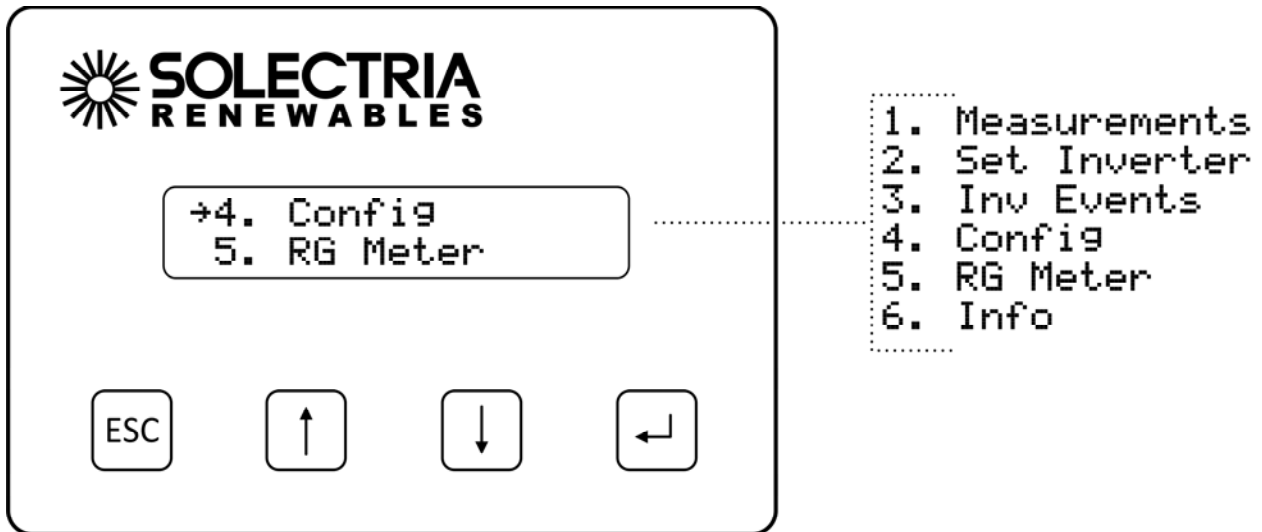

2. Select **LAN** from the **Config Menu** and press **ENTER**.

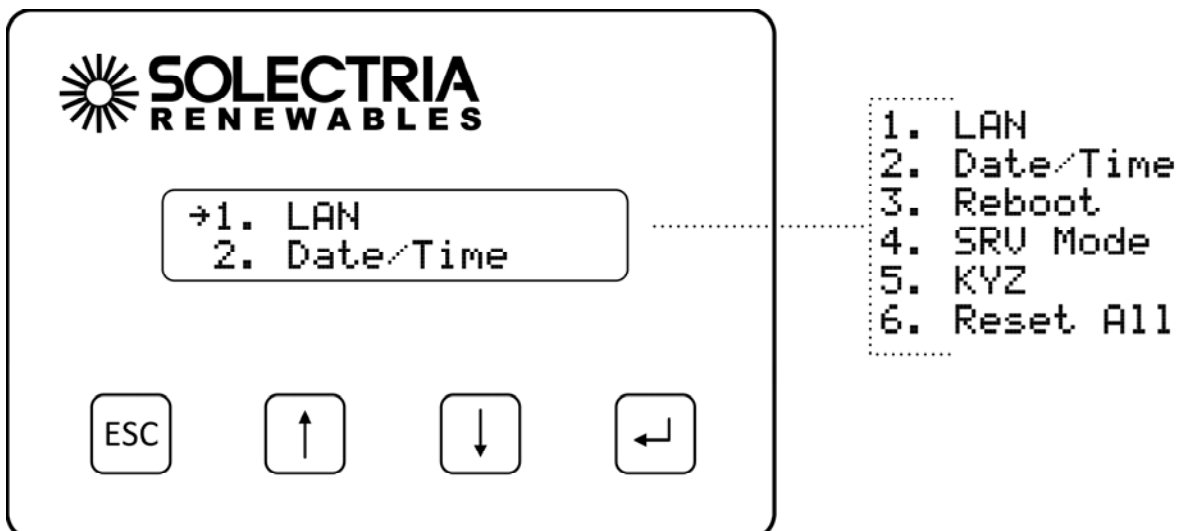

3. Select the **DHCP** function and press **ENTER** to edit this setting.

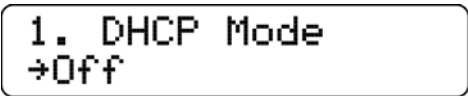

4. Press the **DOWN** button to turn **DHCP Mode On** and press **ENTER** to save this setting.

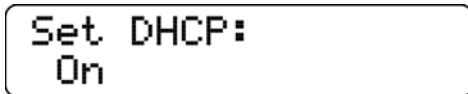

5. The **DHCP Mode** setting will now show **On**.

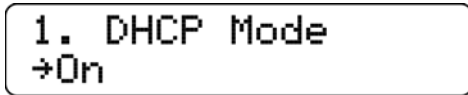

6.16 Setting Fallback IP Address

When the SolrenView gateway is set to use DHCP, but is unable to acquire an IP address lease, it will “fallback” to using a specified IP address after a few seconds.

1. To specify a fallback IP, first select **Config** on the **Main Menu** and press **ENTER**.

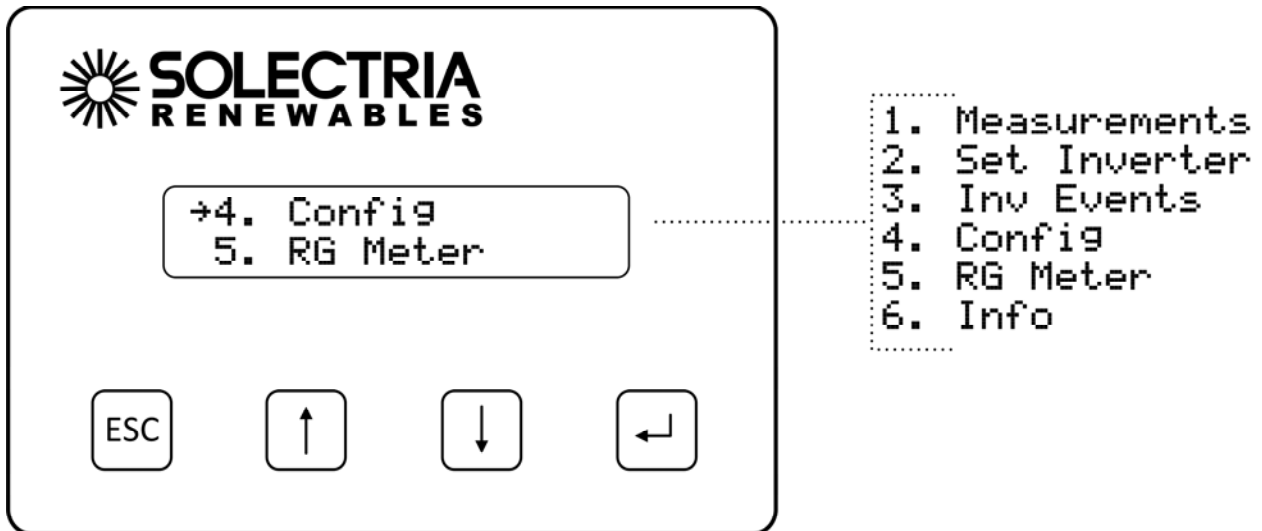

2. Select **LAN** from the **Config** Menu and press **ENTER**.

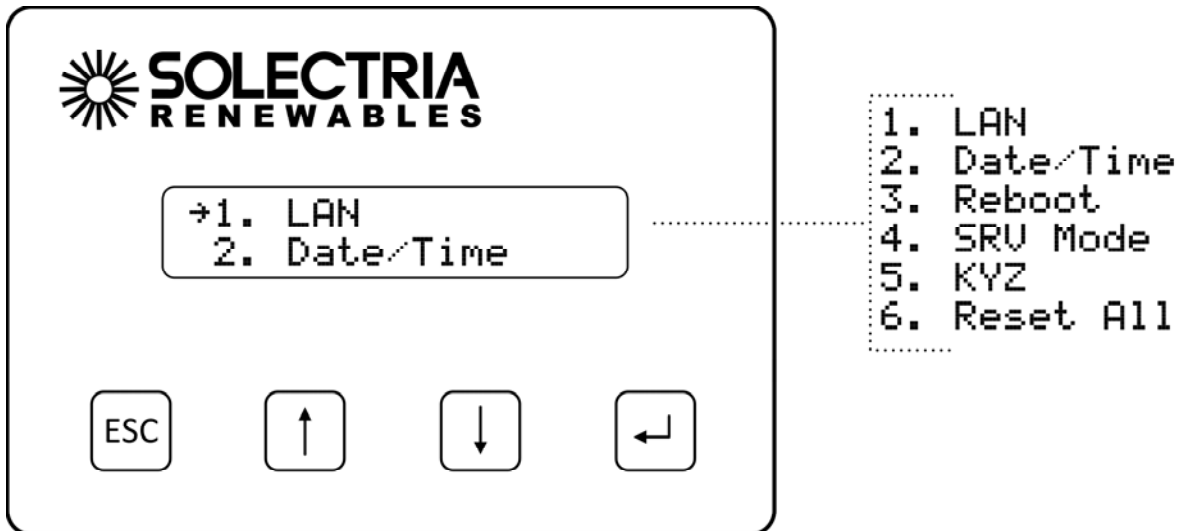

3. Confirm that the **DHCP Mode** setting shows **On**. The **Fallback IP** is only available when DHCP is turned on.

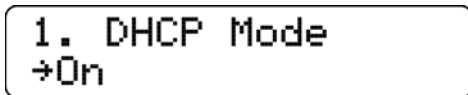

4. Press the **Down** button to show the **Fallback IP** setting.

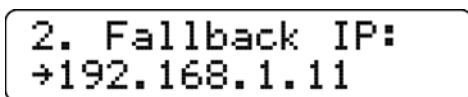

5. To change the **Fallback IP**, press the **ENTER** button.

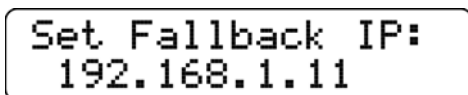

6. Specify each of the four octet values (0-255), one at a time. Press the **UP** button to increment the octet. Press the **DOWN** button to decrement the octet. Press the **ENTER** button to accept the octet. Press the **ESCAPE** button to cancel entry at any point. When the fourth octet is entered the entry will be saved.

7. Press the **DOWN** button to show the **Gateway IP** setting.



```
3. Gateway IP:  
→Autodetect
```

8. To change the Gateway, press the **ENTER** button.
9. When DHCP is on, the Gateway can either be autodetected or manually specified.
10. To configure the SolrenView gateway to autodetect the gateway from the DHCP server, select the “Autodetect” option in using the HMI. **Autodetect** is the special gateway value of 0.0.0.0.
11. To configure the SolrenView gateway to use a manual gateway, specify each of the four octet values (0-255), one at a time. Press the **UP** button to increment the octet. Press the **DOWN** button to decrement the octet. Press the **ENTER** button to accept the octet. Press the **ESCAPE** button to cancel entry at any point. When the fourth octet is entered the entry will be saved.
12. Press the **DOWN** button to access the **Netmask** setting. Change in the same manner that the Fallback IP was modified.

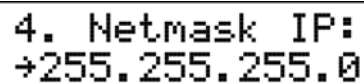

```
4. Netmask IP:  
→255.255.255.0
```

6.17 Enabling SolrenView Web-based Monitoring

Before SolrenView web-based monitoring can function the inverter must be networked to the Internet, see sections 6.12 through 6.15 for more details.

As explained in section 6, data logging is one of the main functions of the SolrenView gateway. This option is turned on with the **SRV Mode** setting. Once enabled, the SolrenView gateway will periodically update various operational values and send this data to the SolrenView web-based monitoring service.

If **SRV Mode** is turned on and the gateway is unable to transfer data to the monitoring service then data will accumulate in a queue on the SolrenView gateway. This queue is stored in non-volatile flash memory. After a few weeks the data queue will become full and the oldest data will be lost, so it is important to establish Internet connectivity soon after the inverters are commissioned.

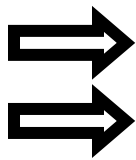

NOTE: *If a third party monitoring service is installed, SRV mode should be set to off.*

NOTE: *Enabling SRV Mode when the SolrenView.com data monitoring service has not been purchased will result in unnecessary wear and tear on the SolrenView gateway.*

1. To enable SolrenView.com data monitoring, first select **Config** on the Main Menu and press **ENTER**:

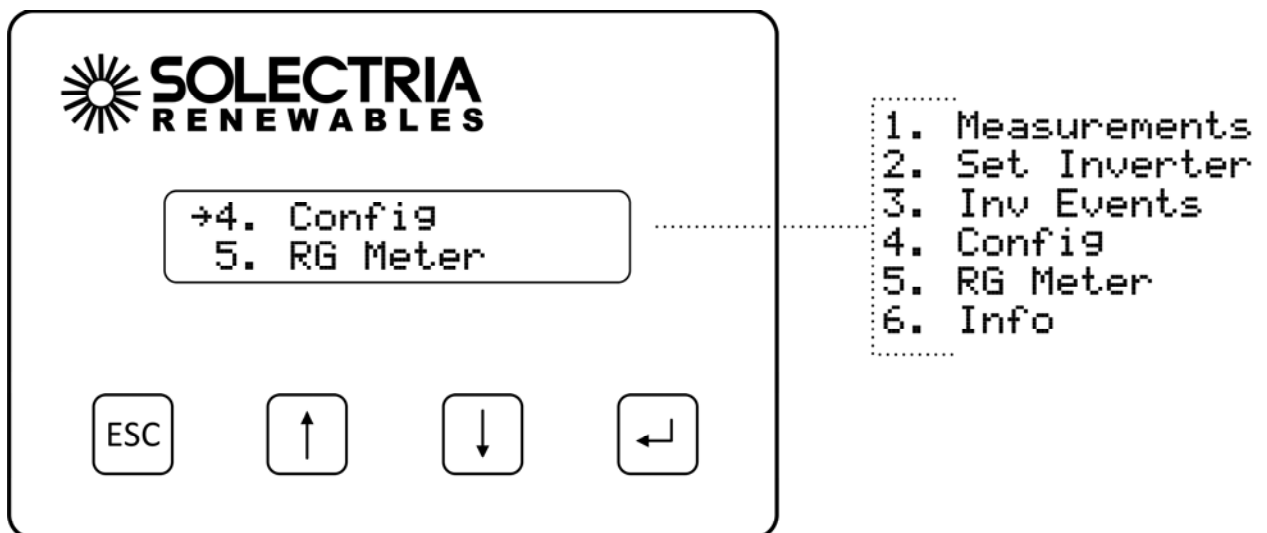

- Next, select **SRV Mode** function on the **Config Menu** and press **ENTER**:

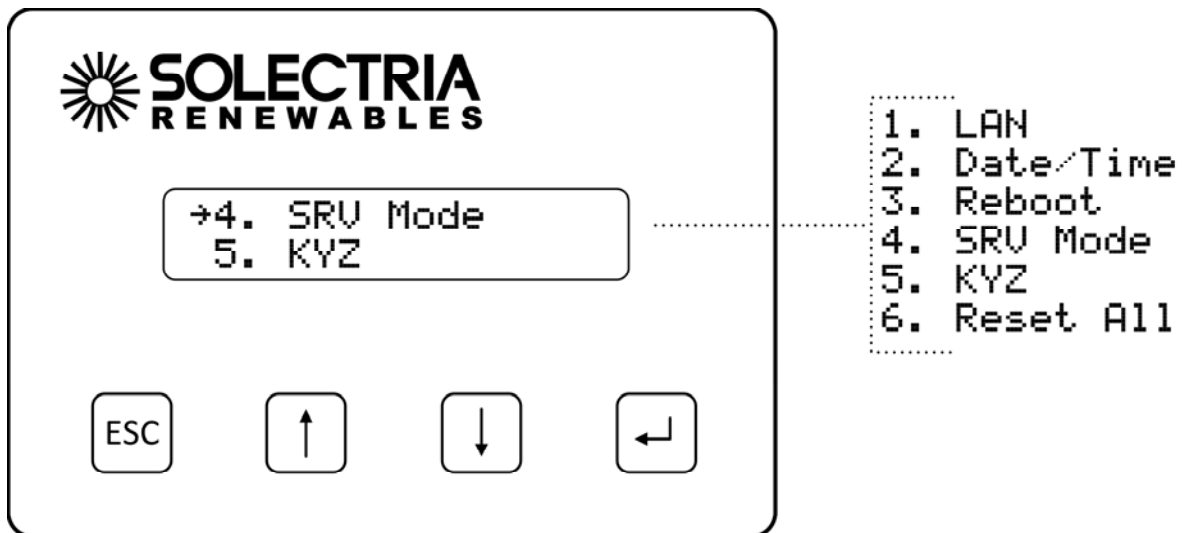

- The **SRV Monitoring** function will be displayed. Press **ENTER** to modify the setting. Press the **DOWN** button to change the setting to **On**.

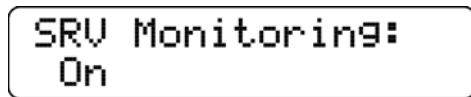

- Press the **ENTER** button to accept the setting change.

6.18 Viewing and setting the Date/Time

When the SolrenView web-based monitoring service is purchased and functioning, it is normally not necessary to set or maintain the time on the inverter. The time will automatically be set and adjusted based on the inverter's time-zone.



NOTE: *The date is only editable if **SRV Mode** is off.*

To view the date and time:

1. First select **Config** on the **Main Menu** and press **ENTER**.

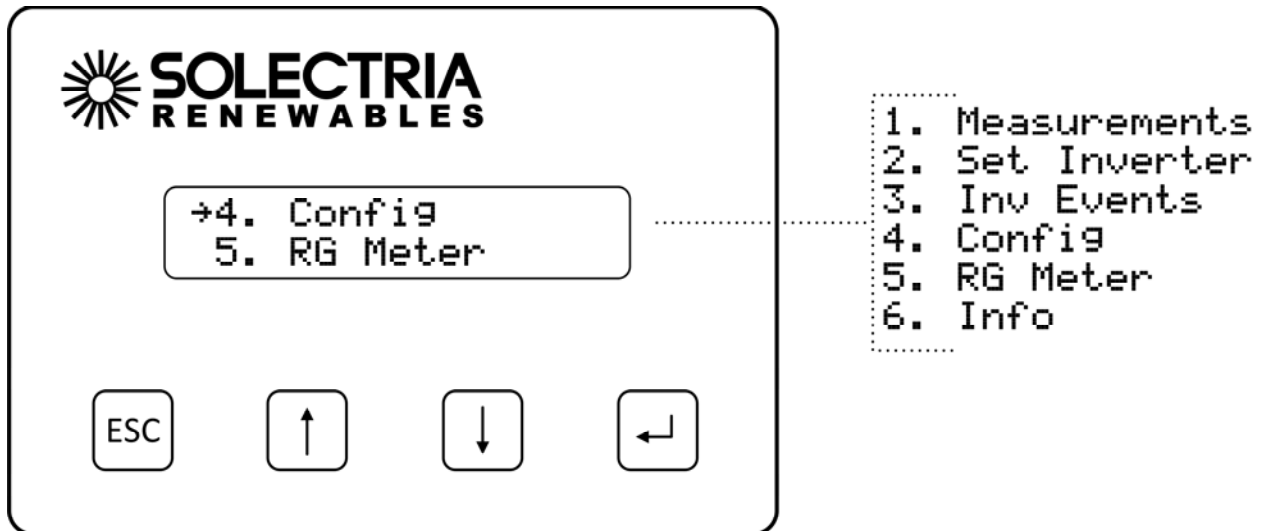

2. Select the **Date/Time** option on the **Config Menu** and press **ENTER**.

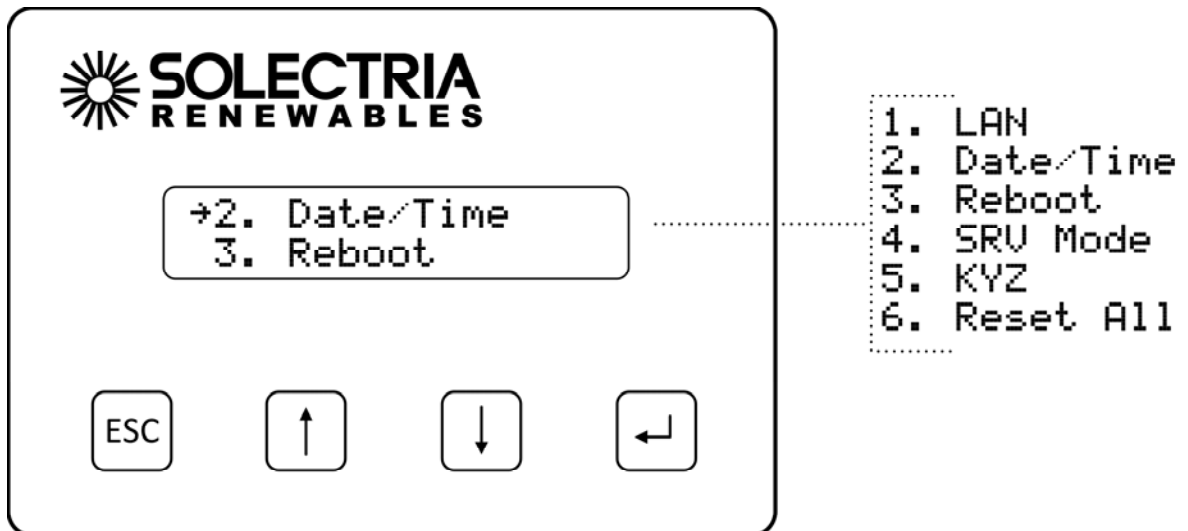

3. The current date will be displayed. If the date can be modified an arrow will appear just before the month. Note: The date is only editable if **SRV Mode** is off. When **SRV Mode** is on, the date and time is automatically set.

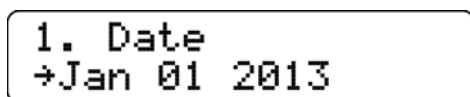

4. Press the **ENTER** button to begin changing the date. The month will flash, indicating that this portion of the date can be changed with the buttons. Press the **UP** button to increment the month and the **DOWN** button to decrement the month. Press the **ENTER** button to accept the month. Press the **ESCAPE** button to cancel and return to the menu.
5. The day will flash, indicating that this portion of the date can be changed with the buttons. Press the **UP** button to increment the day of the month and the **DOWN** button to decrement the day of the month. Press the **ENTER** button to accept the day value. Press the **ESCAPE** button to cancel and return to the menu.
6. The year will flash, indicating that this portion of the date can be changed with the buttons. Press the **UP** button to increment the year and the **DOWN** button to decrement the year. Press the **ESCAPE** button to cancel and return to the menu. Press the **ENTER** button to accept the year value and save the date to the SolrenView unit's memory.
7. After modifying the date, the new date will be shown. Press the **DOWN** button to proceed to the time.

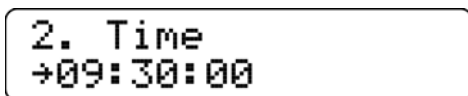

```
2. Time
+09:30:00
```

8. Press the **ENTER** button to begin changing the time. The format is HH:MM:SS and hours are shown in 24 hour format. The hour will flash, indicating that this portion of the time can be changed with the buttons. Press the **UP** button to increment the hour and the **DOWN** button to decrement the hour. Press the **ENTER** button to accept the hour value. Press the **ESCAPE** button to cancel and return to the menu.
9. The minute will flash, indicating that this portion of the time can be changed with the buttons. Press the **UP** button to increment the minute and the **DOWN** button to decrement the minute. Press the **ENTER** button to accept the minute value. Press the **ESCAPE** button to cancel and return to the menu.
10. The second value will flash, indicating that this portion of the time can be changed with the buttons. Press the **UP** button to increment the seconds and the **DOWN** button to decrement the seconds. Press the **ESCAPE** button to cancel and return to the menu. Press the **ENTER** button to accept the second value and save the time to the SolrenView unit's memory.

6.19 Rebooting the SolrenView Gateway

If the SolrenView Gateway cannot communicate over the Internet or is not updating inverter data it may need to be rebooted. To reboot SolrenView gateway:

1. First select **Config** on the Main Menu and press **ENTER**:

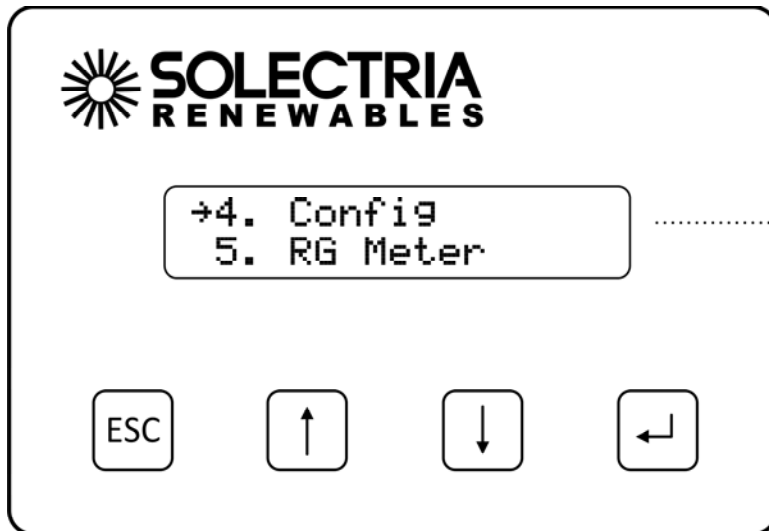

- 1. Measurements
- 2. Set Inverter
- 3. Inv Events
- 4. Config
- 5. RG Meter
- 6. Info

2. Select the **Reboot** option from the menu and press **ENTER**.

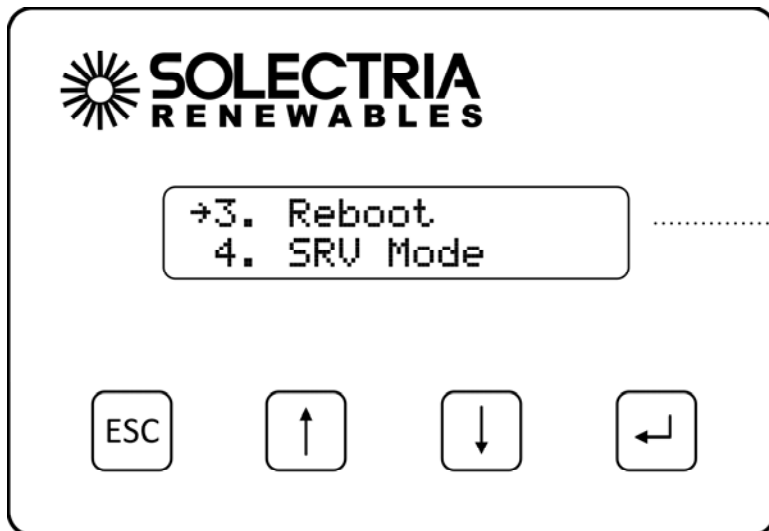

- 1. LAN
- 2. Date/Time
- 3. Reboot
- 4. SRU Mode
- 5. KYZ
- 6. Reset All

3. The **Reboot monitor** prompt will be shown. Press the **ENTER** button to reboot the SolrenView gateway.

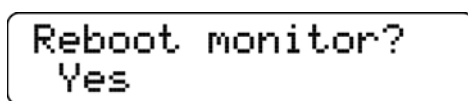

6.20 Resetting the SolrenView Gateway to Factory Defaults

It may be necessary to reset the SolrenView gateway to factory defaults. This does not reset the inverter core, nor shutdown the inverter for any period of time.

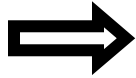

NOTE: *Resetting the SolrenView gateway will also clear events, revenue-grade KYZ counters and SolrenView.com data queue. Caution should be used with this function to avoid data loss.*

To reset the SolrenView gateway:

1. First select **Config** on the **Main Menu** and press **ENTER**.

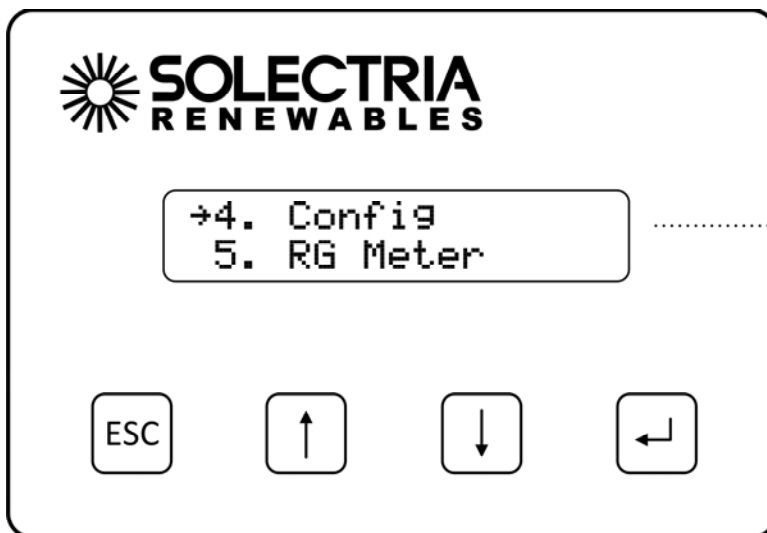

1. Measurements
2. Set Inverter
3. Inv Events
4. Config
5. RG Meter
6. Info

2. Select the **Reset All** option from the menu and press **ENTER**.

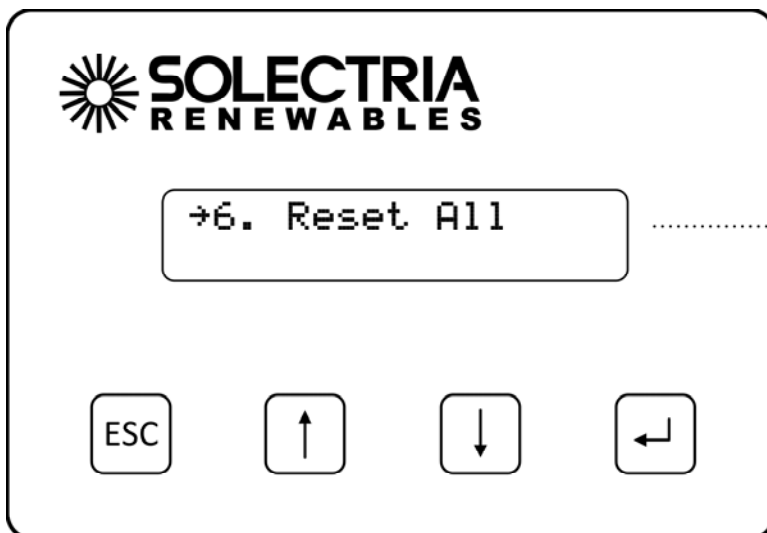

1. LAN
2. Date/Time
3. Reboot
4. SRU Mode
5. KYZ
6. Reset All

3. A message warning that the SolrenView gateway is about to be set to factory defaults is shown. Press the **ESCAPE** button to cancel the reset.

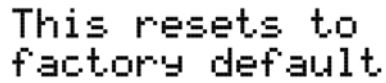

This resets to
factory default

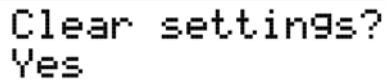

Clear settings?
Yes

4. Select the **Yes** option under Clear settings to reset the SolrenView gateway to factory defaults. The **Reset Storage** screen will appear for a moment.

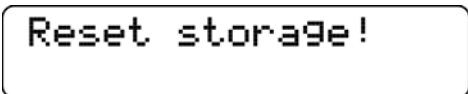

Reset storage!

6.21 Inverter Counts and Logs

The inverter keeps track of various events and errors through error logging and cumulative counters.

Error logs are a record of events (changes of state), with the earliest event shown first. There are a total of 30 log entries available and newer entries overwrite older entries. Each entry in the log is time stamped in MM/DD/YY format.

Error counts display cumulative counters for each supported event/error, with the highest error count shown first.

6.22 Displaying Error Counts

1. Select **Inv Events** from the Main Menu and press **ENTER**.

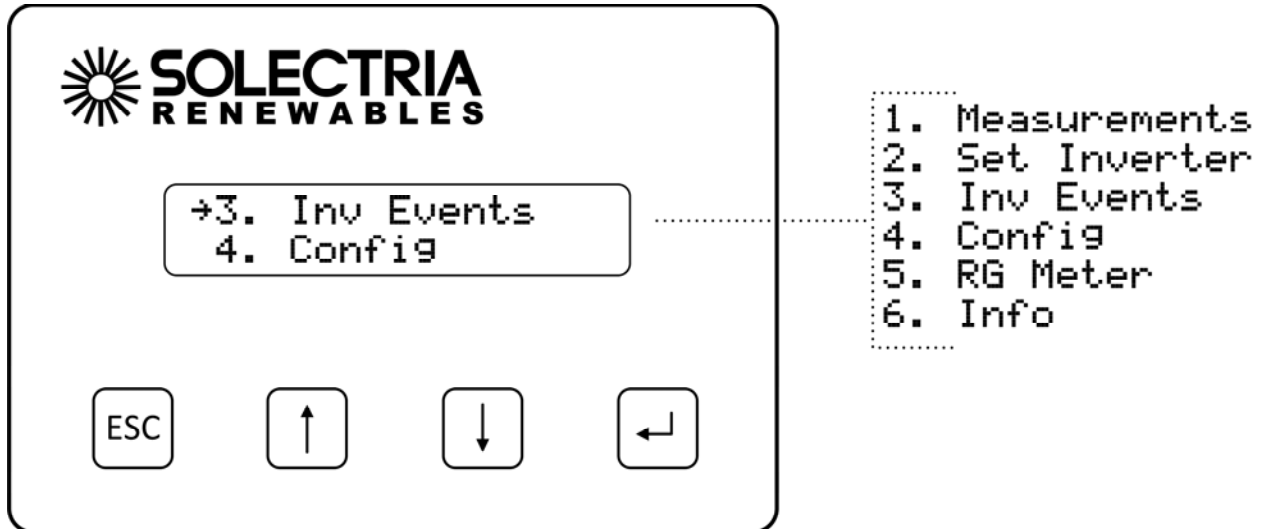

2. Select **Err Counts** from the **Inv Events Menu** and press **ENTER**.

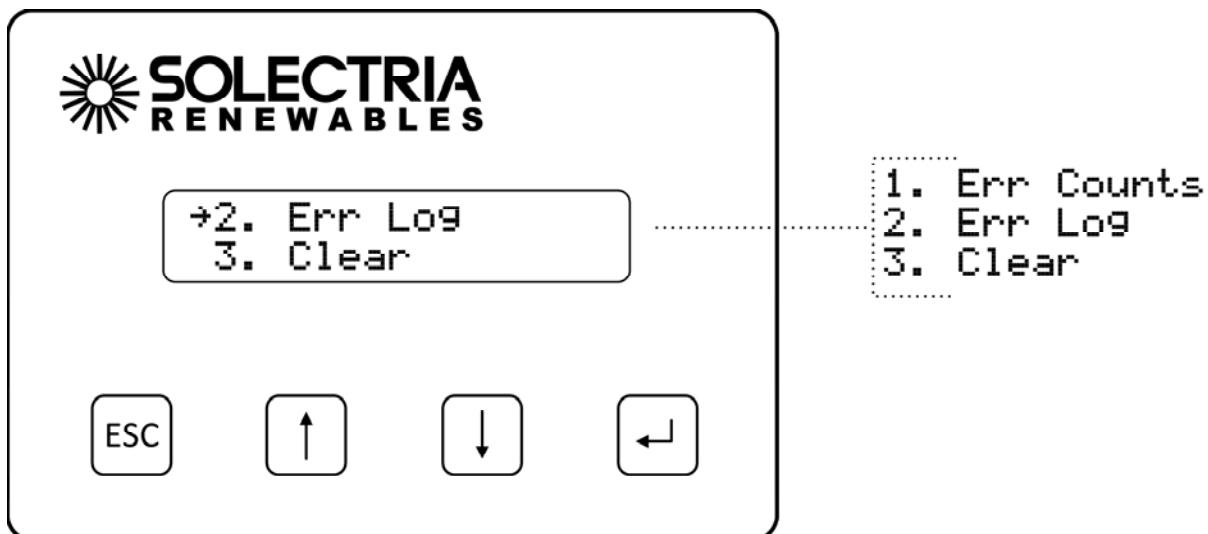

- The Error Counts are displayed in order of occurrence, with the most frequent error displayed at index position 1. In this example the most frequent error is Contactor Failure; two contactor fail events were logged with the last one logged on Jan 02, 2013 at 7:12 am.

```
1. 1/02/13 2x  
Contactor Fail
```

```
1. 7:12 am 2x  
Contactor Fail
```

The data format is index number, date/time and occurrences on the first line. The second line is the type of the event.

- Press the **DOWN** button to see the next Error Count entry. Continuing our example, the second most frequent error is Lost Frequency lock, which occurred once on Jan 01, 2013 at 7:10 am.

```
2. 1/01/13 1x  
Lost Freq Lock
```

```
2. 7:10 am 1x  
Lost Freq Lock
```

- If no Count data is recorded, the date and time that the Counts were last cleared is displayed.

```
Counters cleared  
1/01/2013
```

```
Counters cleared  
08:15 am
```

- Press the **ESCAPE** button to return to the **Inv Events** menu.

6.23 Displaying Error Logs

1. Select **Inv Events** from the **Main Menu** and press **ENTER**.

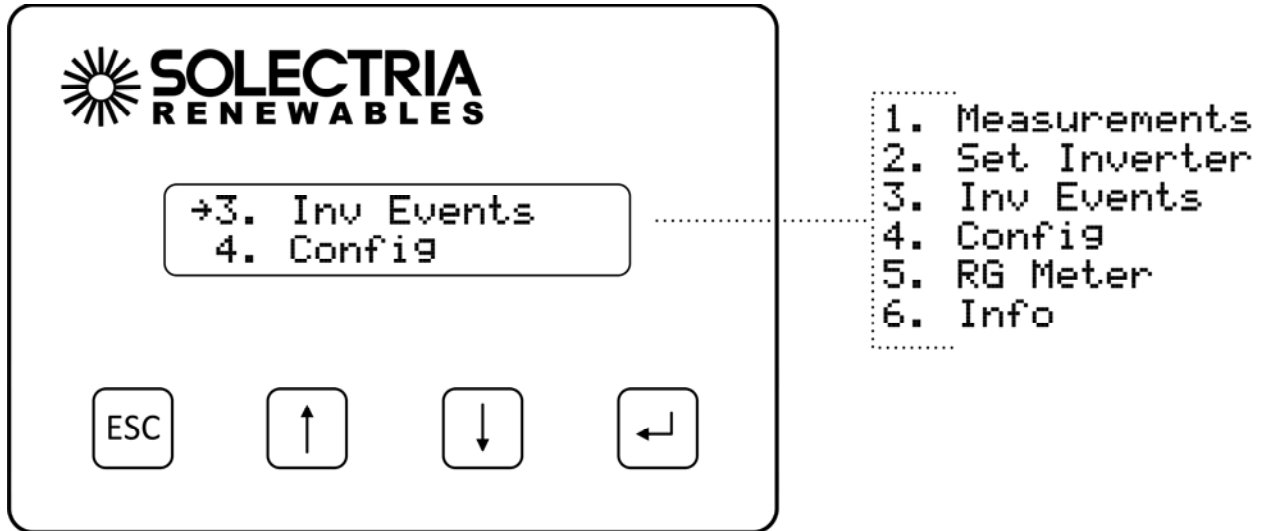

2. Select **Err Logs** from the **Inv Events Menu** and press **ENTER**.

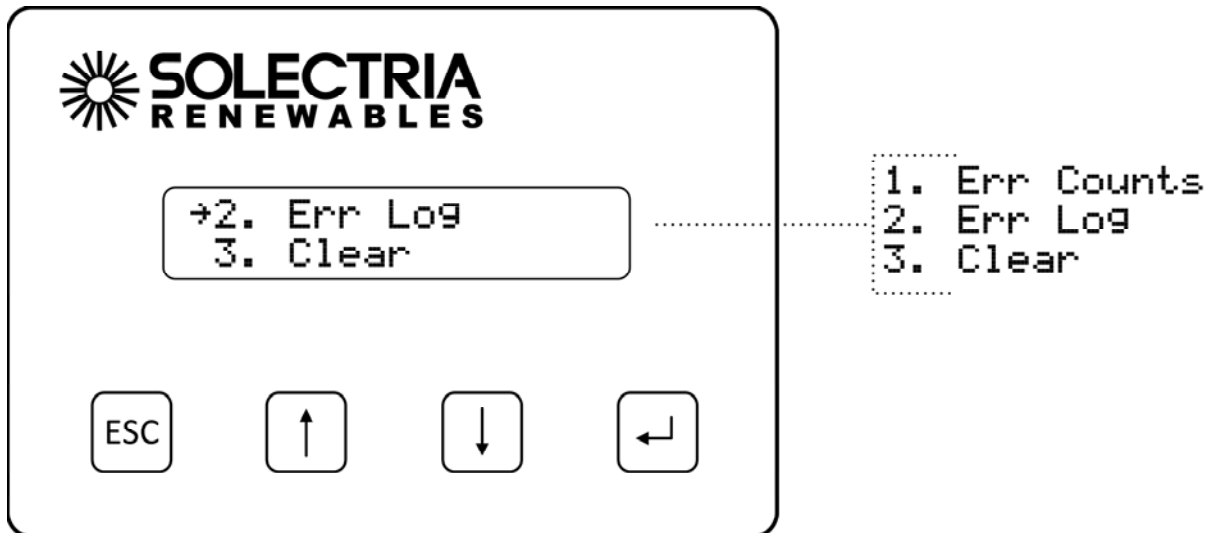

- The most recent Error Log entries is displayed at index position 1.

```
1. 1/01/13  On
Lost Freq Lock
```

```
1. 7:10 am  On
Lost Freq Lock
```

The data format is index number, date/time and event state on the first line. When the Error first is asserted the event state is shown as "On". When the Error ceases the event state is shown as "Off". The second line is the type of the event.

- Press the **DOWN** buttons to see the next event stored in the log.

```
2. 1/01/13  Off
Lost Freq Lock
```

```
2. 7:11 am  Off
Lost Freq Lock
```

In this example, the inverter asserted a Lost Freq Lock error on Jan 01, 2013 at 7:10 am and ceased to assert the Lost Freq Lock error on Jan 01, 2013 at 7:11 am.

- If no Events are recorded, the date and time that the Events were last cleared is displayed.

```
Events cleared
1/01/2013
```

```
Events cleared
08:15 am
```

- Press the **ESCAPE** button to return to the **Inv Events** menu.

Hint: Press the **UP** button from Error log index 1 to see the most recent Error logged.

6.24 Clearing Error Counts or the Log

1. Select **Inv Events** from the **Main Menu** and press **ENTER**.

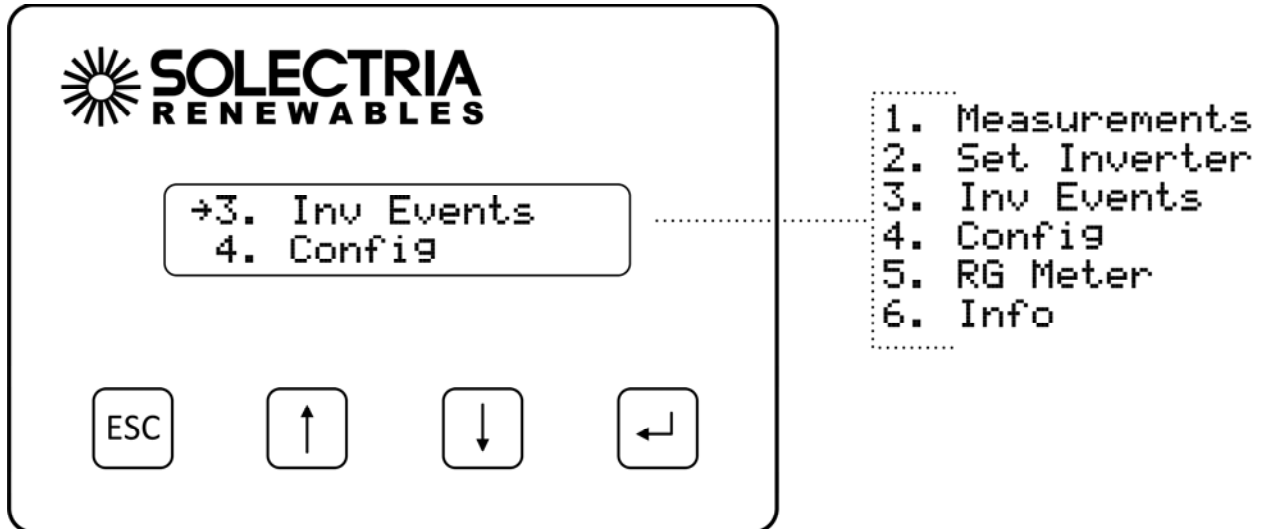

2. Select **Clear** from the **Inv Events Menu** and press **ENTER**.

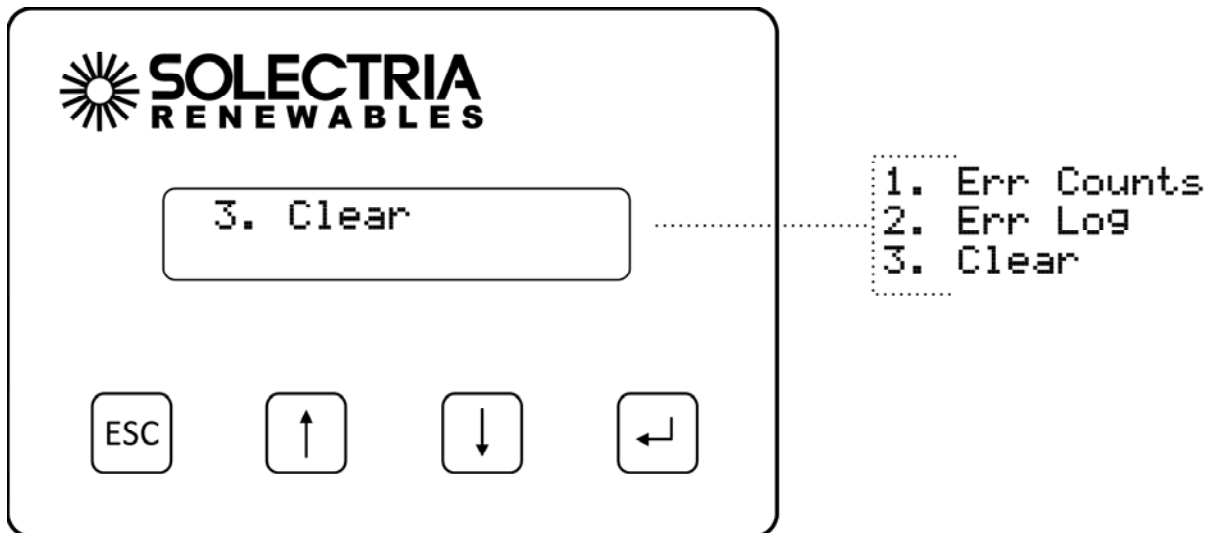

The **Clear History** prompt will be shown. Select the type of history to be cleared by pressing the **UP** and **DOWN** buttons. Press **ENTER** to clear the history based on one of these settings. Press the **ESCAPE** button to cancel.

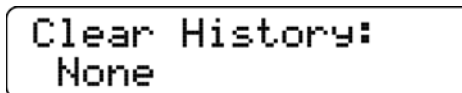

None: History is not cleared.

Err Log: Clears the Error Log only.

Err Counts: Clears the Error Counts only.

All: Clears the Error Counts and Error Log.

List of Logged Events

The following events are logged and counted:

- AC Contact Open
- AC Frequency High
- AC Frequency Low
- AC Islanding
- AC Voltage High
- AC Voltage Low
- Contactor Err
- CT Failure
- DC GND FAULT
- DC Voltage High
- Desat Error
- DMGI Overtemp
- Fan Life Reached
- IGBT Overtemp
- Lost Freq Lock
- MAG Fail
- Min Vmpp Reached
- MOV Fault
- NTC Failure
- Open Phase
- Power Derated
- Power stage failure
- PS Wake Fail
- VDC Ctrl. Fail
- Vsense Err

List of Displayed Events

The following events are frequently encountered or events that only occur during installation:

- AC Disconnect switch
- DC Disconnect switch
- PS Config Fail
- Reconnecting
- Reverse phase & restart PVI!
- Wait for grid

6.25 HMI Menu Structure

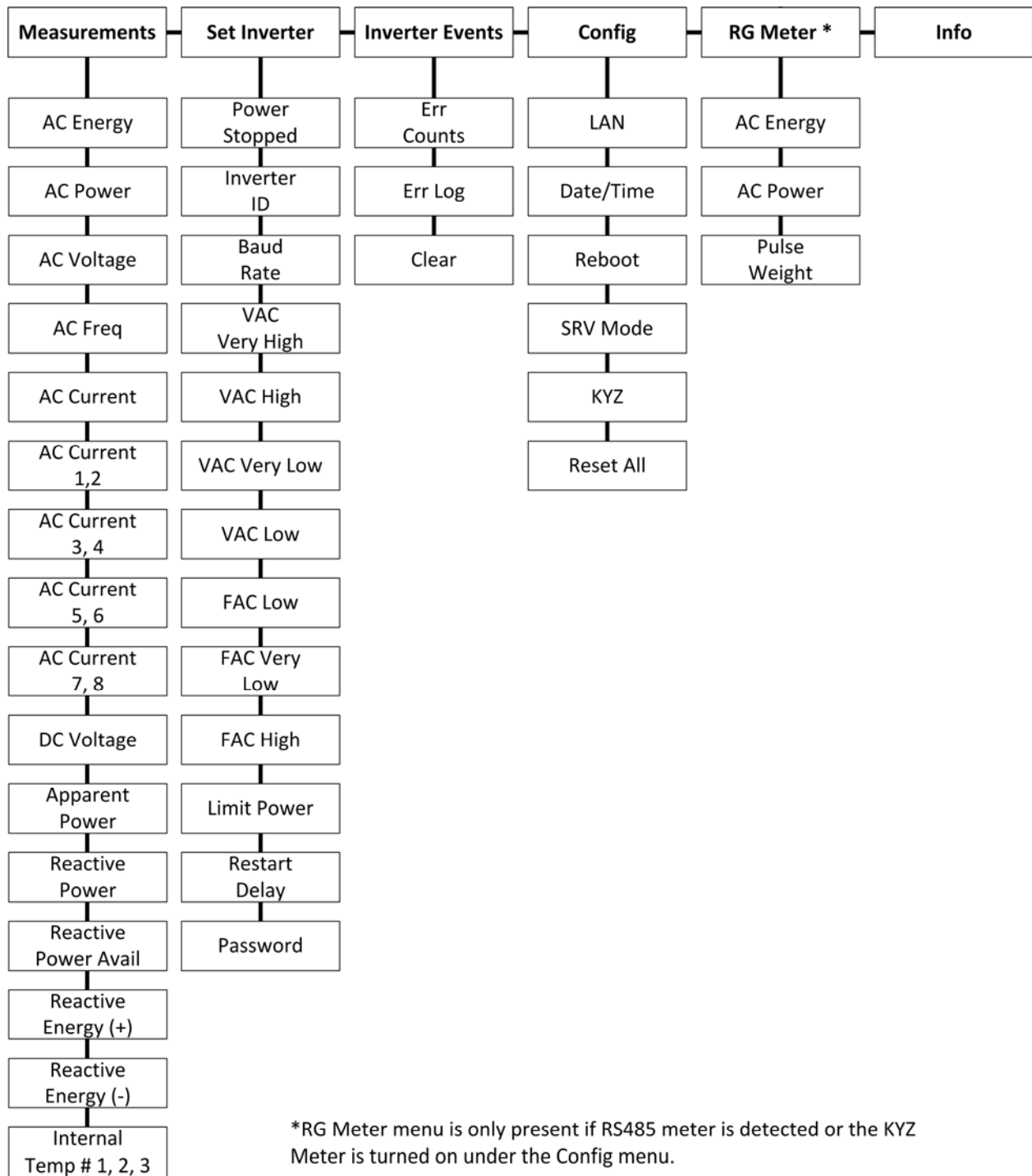

*RG Meter menu is only present if RS485 meter is detected or the KYZ Meter is turned on under the Config menu.

7 Troubleshooting and Maintenance

This section provides guidelines for troubleshooting and routine maintenance of your inverter.



WARNING: *These troubleshooting and maintenance instructions are for use by qualified personnel only. To reduce the risk of electric shock, you should never attempt to open the inverter, DC, or AC enclosure doors, or perform any service or troubleshooting without prior training. Before attempting to service or troubleshoot the inverter, please read the entire manual.*

7.1 Inverter Messages

Although the inverter is designed for many years of uninterrupted power production, there may be instances where messages are displayed on the LCD screen. For ease of diagnostics most messages are displayed as an error message. Examples of Error Messages, Descriptions, and Corrective Actions are found in this section.

Pac: XXXX W Power Derating	The inverter is in derating mode. Can be caused by high input power, high temperature, AC line impedance.	Check string sizing, ambient temp, fans operating, vents are clear, AC wire sizing
Pac: XXXX W AC Voltage High	The AC grid voltage is exceeding the high limit.	Measure the actual VAC compared to the LCD display VAC. If VAC is greater than acceptable limits, the inverter will restart when VAC returns to normal range.
Pac: XXXX W AC Voltage Low	The AC grid voltage is less than the low limit.	Measure the actual VAC compared to the LCD display VAC. If VAC is less than acceptable limits, the inverter will restart when VAC returns to normal range.
Pac: XXXX W AC Freq High	The AC grid frequency is exceeding the high limit.	If possible measure the frequency or contact local utility provider. If AC frequency is above acceptable limits, the inverter will restart when frequency returns to normal range.
Pac: XXXX W AC Freq Low	The AC grid voltage is less than the low limit.	If possible measure the frequency or contact local utility provider. If AC frequency is below acceptable limits, the inverter will restart when frequency returns to normal range.
Contactora Fail 978-683-9700	The AC contactor or sensing circuit has failed	Turn off the inverter and contact Solectria Renewables. The inverter may need to be serviced by an authorized service provider.
CT Failure 978-683-9700	The internal current monitoring has failed	Turn the DC and AC off, restart the inverter. The inverter may need to be inspected and serviced by an authorized service provider.
Thermal disc. 978-683-9700	The AC contactor is open when it is being commanded to be closed	Turn off the inverter and contact Solectria Renewables. The inverter may need to be serviced by an authorized service provider.

NTC Failure 978-683-9700Pac:	The internal temperature sensor has failed.	Turn the DC and AC off, restart the inverter. The inverter may need to be inspected and serviced by an authorized service provider.
IGBT Overtemp 978-683-9700	The internal temperature is exceeding operational limits	Turn the DC and AC off, let the inverter cool to ambient temperature and restart the inverter.
Desat Error 978-683-9700	Internal component sensing fault	Turn the DC and AC off, restart the inverter. The inverter may need to be inspected and serviced by an authorized service provider.
DC GND Fault Check DC Wiring	A ground fault has been detected in the PV array	DO NOT TOUCH any equipment (including, but not limited to: the inverter, the PV array disconnect switch, the PV array combiners, the PV panels, the PV racking system). Immediately contact the installer or another qualified person to locate and repair the source of the ground fault.
VAC Low Reconnecting	The inverter experienced an abnormal AC voltage condition and is in the 5 minute reconnect wait	Wait for the inverter to restart
Pac: XXXX W Waiting for grid	Grid voltage may not be present	Check for grid voltage on all phases
Reverse phasing & restart PVI!	The VAC grid connection phasing does not match the inverter’s phasing	Swap two of the phase wire positions at the inverter AC wiring terminals in the AC disconnect switch, then restart
Pac: XXXX W Min Vmpp reached	The power point tracking has been reached	The inverter will hold the DC voltage at this level until Vmpp increases.
AC Contact Open 978-683-9700	The AC contactor is open when it is being commanded to be closed	Turn off the inverter and contact Solectria Renewables. The inverter may need to be serviced by an authorized service provider.
Vsense Err 978-683-9700	An internal failure of the voltage sensing circuit has occurred	Turn off the inverter and contact Solectria Renewables. The inverter may need to be serviced by an authorized service provider.
Open Phase 978-683-9700	One of the AC phases is not present at the inverter	Verify that there is AC voltage on all phases at the inverter and all fuses are intact.
Pac: XXXX W PS Fail	An internal failure of the power stage	Turn off the inverter and contact Solectria Renewables. The inverter may need to be serviced by an authorized service provider.
Pac: XXXX W Lost Freq Lock	An internal failure of the voltage sensing circuit	Turn off the inverter and contact Solectria Renewables. The inverter may need to be serviced by an authorized service provider.
Pac: XXXX W VDC Ctrl Fail	The DC voltage is outside of the regulation specifications	Turn off the inverter and contact Solectria Renewables. The inverter may need to be serviced by an authorized service provider.

7.2 Troubleshooting



WARNING: *These troubleshooting instructions are for use by qualified personnel only. To reduce the risk of electric shock, you should never attempt to open the inverter, DC, or AC enclosure doors, or perform any service or troubleshooting without prior training. Before attempting to troubleshoot the inverter, please read the entire manual.*

Steps to Perform when PV system not functioning:

- Check inverter LED indicator status and LCD screen for inverter status and error messages
- Check to ensure that inverter is connected to AC power
- Check for clockwise phase rotation of AC power connections
- Check to ensure that DC (PV) input is connected
- Verify proper polarity of DC (PV) positive (+) and negative (-) input pairs
- Verify PV string Maximum Power Point Voltage at design high temperature and PV string Open Circuit Voltage at design low temperature is compatible with inverter input voltage specifications.
- Contact installer or Solectria Renewables if malfunction persists

If contacting Solectria Renewables for assistance, please provide:

1. Inverter Model Number/Part Number
2. Inverter Serial Numbers
3. Short Description of Problem (LCD messages, when problem started, how often problem occurs, under what conditions the problem occurs)
4. Design Information (PV modules, string sizing, output power, short-circuit current and open circuit voltage string layout)

See **Appendix** for Solectria contact information.

Some specific problems that can be identified quickly:

GFDI Problem: If the LED indicators show a ground fault problem but the GFDI fuse is not blown then a ground fault in PV array or wiring must be found. If the LED indicators show that the GFDI fuse is blown, the fault in PV array or wiring must be found and GFDI fuse replaced. For fuse replacement, see section 4 “Power, GFDI and Error LED Indicators”. GFDI fuse must be replaced with identical make/model. Do not use larger amperage fuse.

Inverter over-heating and power de-rating: If the power output is lower than normal and there is an LED indication of power de-rating due to high temperature, check the following

- Is the ambient air temperature above 130°F (55°C)?
- Is the intake (front) louver grill or output (rear or bottom) visibly blocked?

Unit overheating, power de-rating, or unit not putting out power

- Check the insect screens in the front louver grill on the main enclosure door for clogging from dust, pollen and debris. The louver/grill can be removed with 16 Philips screws holding it on and the insect screen can be cleaned or replaced. See Section 7.4 about turning the inverter off before performing this service.
- Fan not running, blocked or slow
 - Check the fan fuses inside the main enclosure (10A AC).
 - Check the fan relay inside the main enclosure.
 - Check the fan and make sure it spins freely.
 - See Section 7.4 about turning the inverter off before performing this service.
- No grid sensing:
 - Grid sensing fuses blown (1A AC or as labeled) inside the main enclosure. Contact Solectria Renewables (Do not replace fuses, as this represents an abnormal failure).
- No LED indications when the sun is shining. If the grid voltage and DC (PV) voltage is present and no response from inverter is evident:
 - Verify AC & DC (PV) voltages are within proper ranges.
 - Verify fuses in AC & DC (PV) disconnect switch are good (if equipped with AC fuses and/or PV sub-combiner).

If it is determined that the unit or any part of the unit should be shipped to Solectria Renewables for repair or replacement, be sure to get an RMA# from Solectria Renewables and use the same packing method as when it was shipped to you, or request instruction on packing and/or packing materials from Solectria Renewables to help insure a safe shipment.

7.3 Preventative Maintenance



WARNING: These maintenance instructions are for use by qualified personnel only. To reduce the risk of electric shock, you should never attempt to open the inverter, DC, or AC enclosure doors, or perform any service or maintenance without prior training. Before attempting to service the inverter, please read the entire manual.

For most installations PM should be performed once every 12 months. If the inverter is installed in harsh environments the frequency of some items should be increased. Please review the table below:

Installation Specifics	Visual inspection	Clean front screen and rear louvers	Verify electrical connections	Verify signal connections
Inside climate controlled	Once per 12 months	Once per 12 months	Once per 12 months	Once per 24 months
Outside covered	Once per 12 months	Once per 6 months	Once per 6 months	Once per 12 months
Outside exposed	Once per 6 months	Once per 6 months	Once per 6 months	Once per 12 months
Outside harsh environment	Once per 3 months	Once per 3 months	Once per 6 months	Once per 12 months
Outside extremely harsh environment	Once per 1 month	Once per 1 month	Once per 6 months	Once per 12 months

A harsh environment is defined as any of the following conditions:

- Excessive temperature either hot or cold
- In a desert area with sand or other debris constantly in contact with the inverter
- In an area with excessive pollen or dust
- Indoors if located in a manufacturing area with airborne particles
- Coastal regions exposed to salt water

7.4 Intake Louver Vent Cleaning



WARNING: *The intake louver vent can be cleaned only when the inverter is off, both DC and AC Disconnect switches off and completely locked and tagged out. Absence of dangerous voltages must be verified by qualified personnel before performing any service.*

Intake louver vent cleaning is recommended at the intervals specified in Section 7.3. Consider cleaning intake louver vent during the early morning or late evening so little or no energy generation is lost.

Method 1: Remove the shroud by removing all Philips Pan Head #2 machine screws around the shroud (sides and top only, do not remove bottom screws), and remove the shroud. Without removing the vent, use a powerful vacuum and clean entire louver vent/screen.

Method 2: Remove the shroud by removing all Philips Pan Head #2 machine screws around the shroud (sides and top), and remove the shroud. Next remove the remaining bottom screws holding the louver vent onto the inverter. Use compressed air from the back (insect screen) side of the louver vent/screen unit to remove all debris.

Re-assemble putting all screws in LOOSELY first and then tighten snug (do not over-tighten).

7.5 Opening Main Enclosure, DC Disconnect Switch, and AC Disconnect Switch

Normally the main enclosure, DC, or AC disconnect switches will not have to be opened for any reason by the user. If opening the unit is necessary follow these guidelines:



WARNING: *The inverter, DC, and AC Disconnect switches should only be opened up by authorized and qualified service personnel.*



WARNING: *If the inverter is outdoors, only open the inverter, DC, and AC disconnect switches when it is clear and dry outside. As with any electrical system do not work on it if there is a potential of an electrical storm.*



WARNING: *Both DC and AC disconnect switches must be in the off position and wait 60 seconds after the LED indicators are off before opening as electrolytic capacitors on the internal DC "bus" are discharging during this time.*

Opening the Main Enclosure



WARNING: *The enclosure can only be opened when the inverter is off, both DC and AC Disconnect switches off and completely locked and tagged out. Absence of dangerous voltages must be verified by qualified personnel before performing any service.*

1. Use the SolrenView HMI keypad to temporarily disable the power output by pressing and holding the **ESCAPE** button for two seconds.
2. Switch off DC disconnect switch
3. Switch off AC disconnect switch
4. Watch until all LED indicators have been off for 60 seconds to allow capacitors to discharge
5. Open handle on door (use key if locked)

Before closing the main enclosure always check for any signs of problems such as corrosion, loose parts, insect or animal infestation, excessive dirt/dust or over heated or deformed/aged-looking parts.

Opening the DC Disconnect Switch Enclosure



WARNING: *DC Input wiring from the array may be energized even with inverter off and DC Disconnect Switch open.*

1. Disconnect inverter from DC power from array to ensure that live DC is not entering DC disconnect switch enclosure.
2. Use the SolrenView HMI keypad to temporarily disable the power output by pressing and holding the **ESCAPE** button for two seconds.
3. Switch off DC disconnect switch
4. Switch off AC disconnect switch
5. Watch until all LED indicators have been off for 60 seconds to allow capacitors to discharge
6. Remove DC disconnect switch cover door retention screws

Opening the AC Disconnect Switch Enclosure



WARNING: *AC output wiring leaving the AC Disconnect Switch Enclosure to point of interconnect may be energized even with inverter off and AC Disconnect switch open.*

1. Disconnect inverter from AC power at point-of-interconnection to ensure that live AC is not entering AC disconnect switch.
2. Use the SolrenView HMI keypad to temporarily disable the power output by pressing and holding the **ESCAPE** button for two seconds.
3. Switch off DC disconnect switch.
4. Switch off AC disconnect switch.
5. Watch until all LED indicators have been off for 60 seconds to allow capacitors to discharge.
6. Remove AC disconnect switch cover door retention screws.

7.6 Fuse replacements

AC Fuses (if equipped)



WARNING: *If inverter is equipped with the fused AC disconnect switch, fuses must only be replaced with 600VAC rated fuses of the same type and rating.*

The following table includes current ratings of fuses provided with fused AC disconnect switch option according to inverter power rating and AC output voltage.

AC Voltage	Inverter Model				
	PVI-50KW	PVI-60KW	PVI-75KW	PVI-85KW	PVI-100KW
208V	175A	225A	300A	300A	350A
240V	150A	200A	225A	300A	300A
480V	110A	110A	125A	150A	150A
600V	110A	110A	110A	110A	125A

Table 7.1 – AC Disconnect Switch Fuse Specifications

DC Input Fuses (if equipped)



WARNING: *If inverter is equipped with the fused PV sub-combiner, fuses in DC disconnect switch must only be replaced with 600VDC rated fuses of the same type. Always refer to PV module and combiner fuse ratings and specification before selecting or replacing fuses.*

GFDI fuse



WARNING: *Only replace GFDI fuse with Bussmann KLM-2 (2A, 600 VDC rated)*

Other Fuses



WARNING: *Unless otherwise specified, only replace other fuses with fuses of same type and rating. See fuse schedule located along inverter enclosure interior right wall for complete list of fuse ratings and types.*

8 Product Warranty and RMA Policy

The Solectria Renewables Warranty Policy and RMA Policy is available at the following web location:

http://www.solectria.com//site/assets/files/1091/inverter_warranty-1.pdf

9 Technical Data

See Appendix for links to PVI 50-100KW data sheet and the string sizing tool.

Input (DC) from PV array:



WARNING: *NEC 690-7 must be followed to calculate the maximum number of PV modules allowed for a maximum inverter open circuit voltage (OCV) of 600V DC in extreme cold temperatures for the installation location.*



The open circuit voltage of PV modules depends on the cell temperature and the solar irradiation. The highest open circuit voltage occurs when the PV modules are at the coldest temperature and in bright sun.

Because the PV modules also have a reduction in voltage at high cell temperatures, you must make sure the MPPT voltage of the strings will not drop below the minimum inverter DC input voltage in hot temperature conditions.

Both the maximum open circuit voltage (OCV) when at maximum cold temperatures and minimum MPPT voltage when at maximum hot temperatures can be calculated for a PV module using its specification sheet. PV module string sizing can then be used to determine how many modules can be used in a string. Visit http://www.solectria.com/?page_id=30 to use Solectria Renewables’ interactive string sizing tool.

9.1 Input DC (PV) Specifications

	PVI 50KW	PVI 60KW	PVI 75KW	PVI 85KW	PVI100KW	Unit
Standard Units						
Operating voltage range	300-600					VDC
Input voltage MPPT range	300-550					VDC
Startup Voltage	400V					VDC
Maximum operating input current	176	211	264	299	351	ADC
Low Voltage (LV) Units*						
Operating voltage range	285-600					VDC
Input voltage MPPT range	285-550					VDC
Startup Voltage	380V					VDC
Maximum operating input current	185	222	278	314	370	ADC
All Units						
Maximum open circuit voltage	600					VDC
Absolute Maximum open circuit voltage	630					VDC
DC voltage measurement accuracy	+/- 2%					
DC current measurement accuracy (SolZone option only)	+/- 2%					

DC Ground Fault Protection	Per UL 1741	
DC Ground Fault Trip Setting	2	ADC
Maximum backfeed current	0	A
DC Subcombiner Options	40A – 300A fuses available, 2-8 pole 40A – 300A Breakers available, 2-8 pole	
DC Disconnect switch	Break load rated, NEMA 3R, Breaks Ungrounded Conductor	
DC Disconnect Voltage Rating	600	VDC
DC Disconnect Current Rating	400A or 600A, Varies by model, see Table 4.6	ADC

**Low Voltage (LV) Units are not CEC listed, contact Solectria for availability*

Table 9.1 – DC Input Specifications

9.2 Output AC Specifications

The inverters are designed to feed power into a standard 60Hz, three-phase AC utility service provided within a facility by a transformer with a rating of not less than the rating of the inverter(s) connected to it.

The inverter is designed to work with the range of AC voltages for a three-phase service defined by IEEE 1547-2003 and ANSI C84.1.

	PVI 50KW	PVI 60KW	PVI 75KW	PVI 85KW	PVI100KW	Unit
Operating AC voltage range	88 – 110%					
Turn-on AC voltage range	92 – 105%					
Operating frequency (Default)	59.3 – 60.5					Hz
Continuous Output Power	50	60	75	85	100	kW
Continuous Output Current						
208VAC	139	167	208	236	278	Arms
240VAC	120	144	180	205	240	Arms
480VAC	60	72	90	102	120	Arms
600VAC	48	58	72	82	96	Arms
Maximum Output Fault Current and Duration (Line to Ground)	5.04kA (P-P), 1.41kArms, 60.0ms (duration)					
Frequency measurement accuracy	± 0.1					Hz
AC Voltage measurement accuracy	± 1%					
AC current measurement accuracy	± 2%					
AC real power and energy measurement accuracy	± 5%					
Total Harmonic distortion (THD, @ full power)	< 3%					
Power Factor, Rated Power	1.0					
Anti-islanding protection	per UL1741 / IEEE1547 / CSA22.2#107.1					
AC Disconnect switch	Break load rated, NEMA 3R					
AC Disconnect Voltage Rating	600					VAC
AC Disconnect Current Rating	200A or 400A, Varies by model, see Tables 4.3 & 4.4					Arms

Table 9.2 – AC Output Specifications

Trip Setting	ANSI Device Number	Factory Default		Adjustment Range	
		Voltage Limit (p.u.)	Clearing Time (s)	Voltage Limit (p.u.)	Clearing Time (s)
Undervoltage (fast)	27	$V < 0.5$	0.16	$V < \{0.5, \text{fixed}\}$	0.16
Undervoltage (slow)	27	$V < 0.88$	2.00	$V < \{0.5 \text{ to } 1.0\}$	0.16 to 300
Overvoltage (slow)	59	$V > 1.1$	1.00	$V > \{1.1 \text{ to } 1.2\}$	0.16 to 300
Overvoltage (fast)	59	$V > 1.2$	0.16	$V > \{1.2, \text{fixed}\}$	0.16

Table 9.3 – Voltage Trip Settings

Trip Setting	ANSI Device Number	Factory Default		Adjustment Range	
		Frequency Limit (Hz)	Clearing Time (s)	Frequency Limit (Hz)	Clearing Time (s)
Underfrequency (fast)	81U	$f < 57.0$	0.16	$f < \{57.0, \text{fixed}\}$	0.16
Underfrequency (slow)	81U	$f < 59.3$	0.16	$f < \{57.0 \text{ to } 59.8\}$	0.16 to 300
Overfrequency (fast)	81O	$f > 60.5$	0.16	$f > \{60.5, \text{fixed}\}$	0.16

Table 9.4 – Frequency Trip Settings

9.3 Other Specifications

Operational Ambient Temperature, full power	-40° to +55°C (-40°F to +131°F)
Storage Temperature	-40° to +55°C (-40°F to +131°F)
Cooling	Automatic Forced Convection
Inverter Enclosure	Rain Proof per UL1741
Switching Electronics Enclosure	IP-62 (sealed design)
Standby/Tare Loss	208Vac models – 1W 240Vac models – 1W 480Vac models – 3W 600Vac models – 3W
EMI Compliance	FCC Part 15, Subpart B, Class A

Table 9.5 – Other Specifications

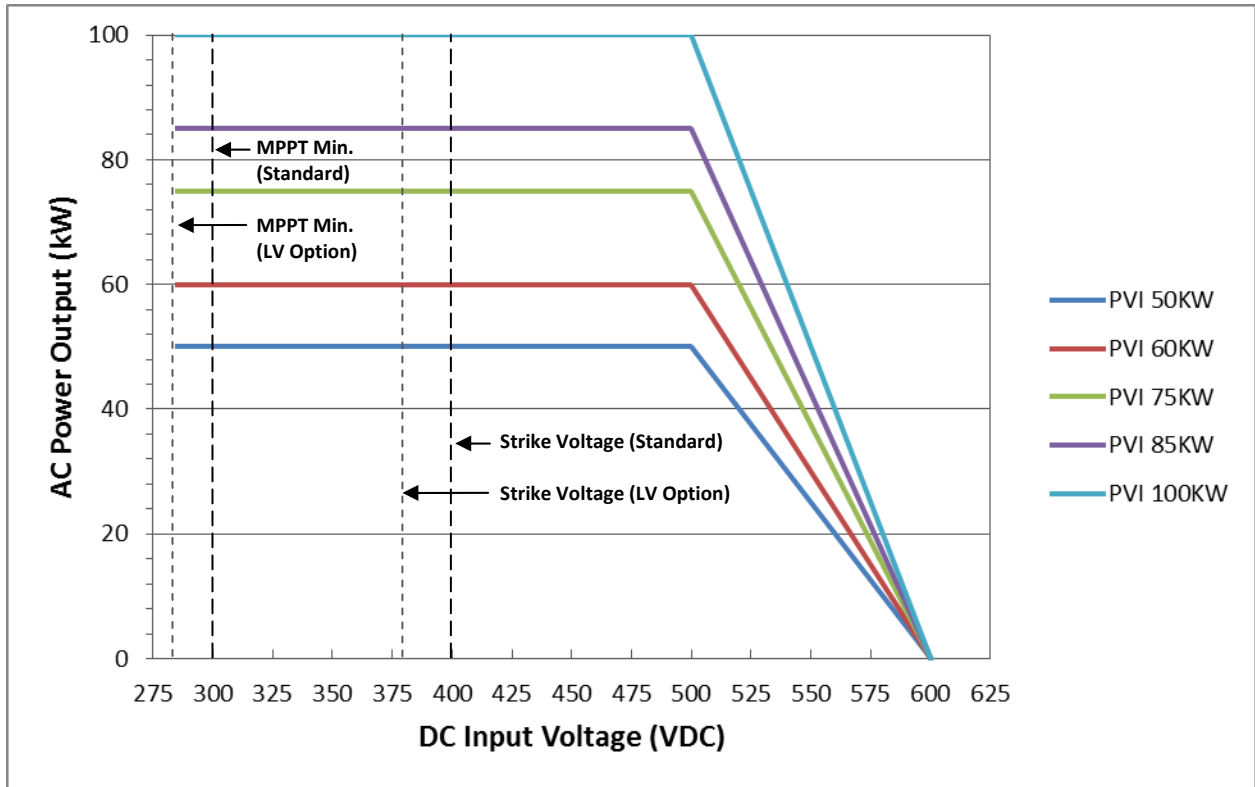

Figure 9.1 AC Output Power vs. DC Input Voltage of PVI 50-100KW Series Inverters

9.4 Internal Circuit Diagram

The basic power flow within the PVI 50KW-100KW series inverters is shown in the simplified one-line diagram below. Note that grounding and GFDI circuit is not depicted.

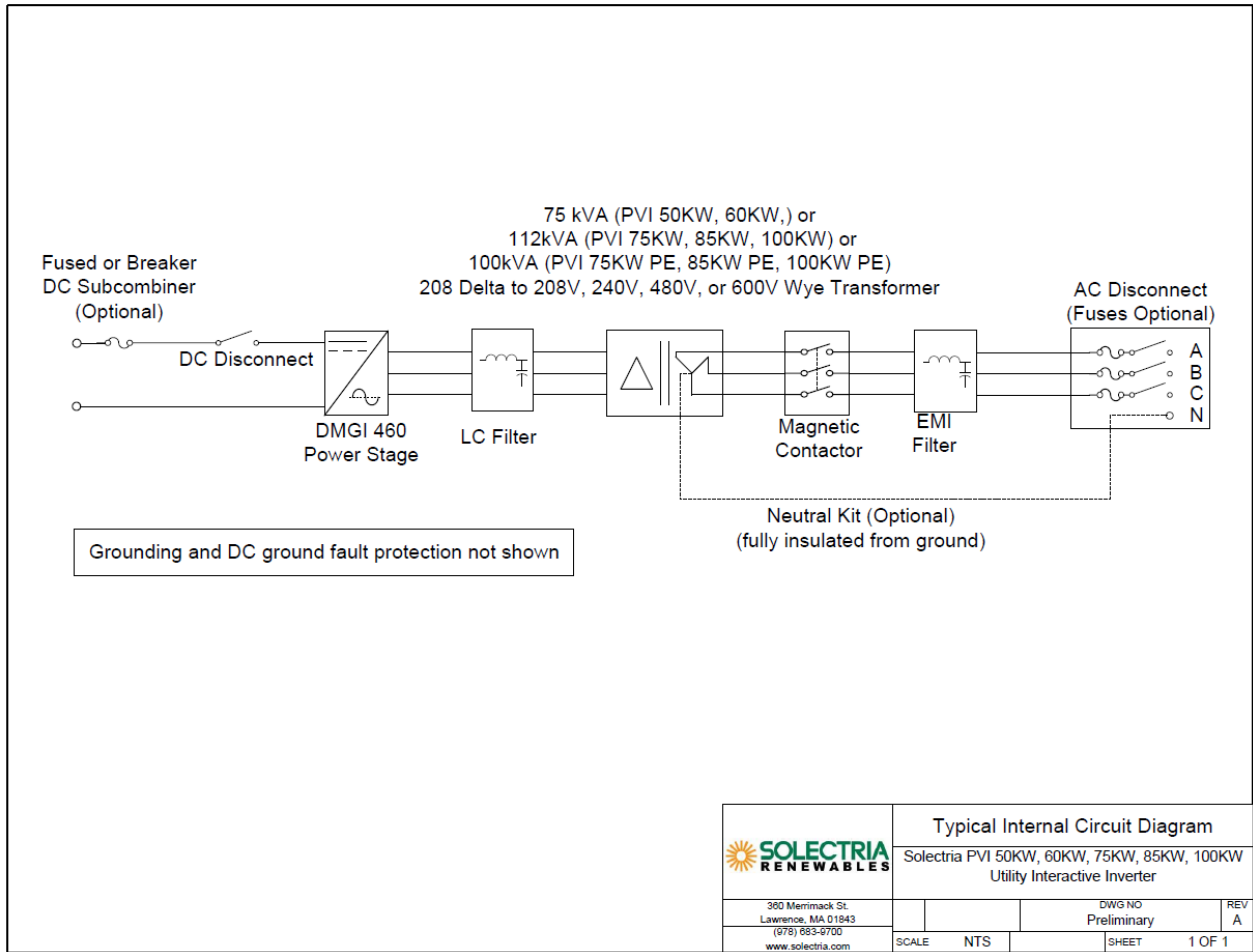

Figure 9.2 – Simplified One-Line Diagram of PVI 50-100KW Series Inverters

10 Appendices

10.1 Appendix A – PVI 50KW, 60KW, 75KW, 85KW, 100KW Data Sheet

http://www.solectria.com/datasheets/PVI_50-100KW_Datasheet.pdf

10.2 Appendix B – String Sizing Tool

http://www.solectria.com/?page_id=30

10.3 Appendix C – Contact Information

Solectria Renewables LLC

360 Merrimack Street

Building 9, 2nd floor

Lawrence, Massachusetts 01843

USA

Tel: 978.683.9700

Fax: 978.683.9702

Sales/General Info: inverters@solectria.com

Customer Support: service@solectria.com

Website: www.solectria.com

10.4 Appendix D – Authorized Distributors

See website for complete and updated listing: www.solectria.com

10.5 Appendix E – UL1741/IEEE 1547 Authorization Letter to Mark Product



AUTHORIZATION TO MARK

This authorizes the application of the Certification Mark(s) shown below to the models described in the Product(s) Covered section when made in accordance with the conditions set forth in the Certification Agreement and Listing Report. This authorization also applies to multiple listee model(s) identified on the correlation page of the Listing Report.

This document is the property of Intertek Testing Services and is not transferable. The certification mark(s) may be applied only at the location of the Party Authorized To Apply Mark.

Applicant: Solectria Renewables, LLC Address: 360 Merrimack Street Lawrence, MA 01843 Country: USA Contact: Mr. James Worden Phone: (978) 683-9700 FAX: (978) 683-9702 Email: www.james@solren.com	Manufacturer: Solectria Renewables, LLC Address: 360 Merrimack Street Lawrence, MA 01843 Country: USA Contact: Mr. James Worden Phone: (978) 683-9700 FAX: (978) 683-9702 Email: www.james@solren.com
--------------------------------------------------------------------------------------------------------------------------------------------------------------------------------------------------------------------------------------------------------------------------	-----------------------------------------------------------------------------------------------------------------------------------------------------------------------------------------------------------------------------------------------------------------------------

Party Authorized To Apply Mark: Same as Manufacturer
Report Issuing Office: Cortland, NY 13045

Control Number: 3058249 **Authorized by:** *Catherine Dwyer*
 for Thomas J. Patterson, Certification Manager



This document supersedes all previous Authorizations to Mark for the noted Report Number.

This Authorization to Mark is for the exclusive use of Intertek's Client and is provided pursuant to the Certification agreement between Intertek and its Client. Intertek's responsibility and liability are limited to the terms and conditions of the agreement. Intertek assumes no liability to any party, other than to the Client in accordance with the agreement, for any loss, expense or damage occasioned by the use of this Authorization to Mark. Only the Client is authorized to permit copying or distribution of this Authorization to Mark and then only in its entirety. Use of Intertek's Certification mark is restricted to the conditions laid out in the agreement and in this Authorization to Mark. Any further use of the Intertek name for the sale or advertisement of the listed material, product or service must first be approved in writing by Intertek. Initial Factory Assessments and Follow up Services are for the purpose of assuring appropriate usage of the Certification mark in accordance with the agreement, they are not for the purpose of production quality control and do not relieve the Client of their obligations in this respect.

Intertek Testing Services NA Inc.
 545 E. Algonquin Road, Arlington Heights, IL 60005
 Telephone 800-345-3851 or 847-439-5667 Fax 847-439-7320

Standard(s):	UL 1741 Standard for Safety Inverters, Converters, Controllers and Interconnection System Equipment for use with Distributed Energy Resources- 2nd Edition, Issued 2010/01/28. CSA C22.2 # 107.1-01, Issued 2001/09/01 Ed:3 General Use Power Supplies - (R2011) IEEE 1547-Issued:2003/06/12- Standard for Interconnecting Distributed Resources with Electric Power Systems IEEE 1547.1- Issue: 2005/06/09 IEEE Standard Conformance Test Procedures for Equipment Interconnecting Distributed Resources with Electric Power Systems
Product:	Utility – Interactive Photo Voltaic (PV) inverters
Models:	PVI 50 KW, PVI 60 KW, PVI 75 KW, PVI 82 KW, PVI 85 KW, PVI 95 KW and PVI 100 KW