

DOCUMENT RESUME

ED 091 164

SE 017 106

TITLE Skylab Experiments, Volume 6, Mechanics.
INSTITUTION National Aeronautics and Space Administration,
Washington, D.C.
REPORT NO EP-115
PUB DATE May 73
NOTE 40p.; For related documents, see SE 016 464 and 465,
SE 016 991, and SE 017 788-790
AVAILABLE FROM Superintendent of Documents, Government Printing
Office, Washington, D.C. 20402
EDRS PRICE MF-\$0.75 HC-\$1.85 PLUS POSTAGE
DESCRIPTORS *Aerospace Technology; *Demonstrations (Educational);
*Instructional Materials; *Mechanics (Physics);
Physics; Science Activities; Science Education;
Science Materials; Secondary School Science
IDENTIFIERS NASA; *Skylab Education Program

ABSTRACT

Volume 6, one of a series of booklets designed to acquaint teachers with the Skylab Program, is focused on mechanics. Introductory material provides background information on Skylab and its related education program. Section 1 of the booklet presents relevant physics content concerning the concept of mechanics. Section 2 contains a discussion of astronaut mobility aids. Section 3 focuses on mass measurement devices while section 4 is concerned with space guidance and crew/vehicle disturbances. All four sections contain specific background information concerning the topic of the particular section, experiment objectives and data from the Skylab Program, related curriculum topics, and ideas for classroom demonstrations. Section 5 consists of a selected bibliography.
(PEB)

EP-115

U.S. DEPARTMENT OF HEALTH
EDUCATION & WELFARE
NATIONAL INSTITUTE OF
EDUCATION

THIS DOCUMENT HAS BEEN REPRODUCED EXACTLY AS RECEIVED FROM THE PERSON OR ORGANIZATION ORIGINATING IT. POINTS OF VIEW OR OPINIONS STATED DO NOT NECESSARILY REPRESENT THE NATIONAL INSTITUTE OF EDUCATION POSITION THEREON.

SE

ED0091164

Skylab Experiments

Volume 6 Mechanics

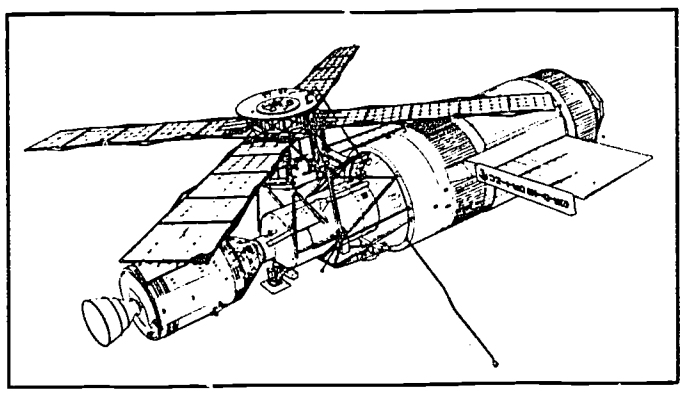
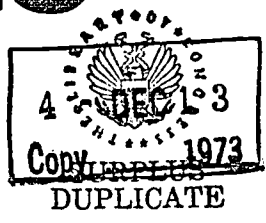

SE 017 106

information for Teachers, Including Suggestions
on Relevance to School Curricula.

ED 091164

Skylab Experiments

Volume 6 Mechanics

Produced by the Skylab Program and NASA's Education Programs
Division in Cooperation with the University of Colorado

NATIONAL AERONAUTICS AND SPACE ADMINISTRATION
Washington, D.C. 20546, May 1973

PREFACE

Characteristically, new scientific knowledge reaches general application in classrooms years after it has been obtained. This long delay stems, to a large extent, from a lack of awareness that information is available and that it has relevance to secondary school curricula. To accelerate this process, the National Aeronautics and Space Administration has prepared a series of documents concerning Skylab experiments to apprise the educational community in detail of the investigations being conducted in the Skylab Program, and the types of information being produced.

The objective is not to introduce the Skylab Program as a subject in the classroom, but rather to make certain that the educational community is aware of the information being generated and that it will be available for use. Readers are urged to use these books as an aid in planning development of future curriculum supplement material to make the most appropriate use of this source of scientific knowledge.

National Aeronautics and Space Administration
Washington, D. C. 20546
May 1973

CONTENTS

SECTION 1—INTRODUCTION	1
SECTION 2—MOBILITY AIDS	7
Foot-Controlled Maneuvering Unit (FCMU) Equipment	13
Astronaut Maneuvering Unit (AMU)	15
SECTION 3—MASS MEASUREMENT DEVICES	19
Inertia Balance	22
SECTION 4—SPACE GUIDANCE CREW/VEHICLE DISTURBANCES	23
Force Measuring System	23
SECTION 5—SELECTED BIBLIOGRAPHY	27
Suggested Additional Reading	27

INTRODUCTION

The Skylab Education Program

This year the United States' first manned scientific space station, Skylab, was launched into orbit to be the facility in which successive crews of astronauts can perform more than 270 scientific investigations in a variety of fields of interest. These investigations can be divided into four categories: physical sciences, biomedical sciences, earth applications, and space applications.

The Skylab Program will produce information that will enhance present scientific knowledge and perhaps extend the frontiers of knowledge on subjects ranging from the nature of the universe to the structure of the single human cell. It is the objective of the National Aeronautics and Space Administration that the knowledge derived from the Skylab Program's investigations be made available to the educational community for applications to high school education at the earliest possible date.

For this reason, the Skylab Education Program was created to assure that maximum educational benefits are obtained from the Skylab effort, documentation of Skylab activities is adequately conducted, and understanding of scientific developments is enhanced.

This document, one of several volumes prepared as part of the Skylab Education Program, has the dual purpose of (1) informing high school teachers about the scientific investigations performed in Skylab, and (2) enabling teachers to evaluate the educational benefits the Skylab Program can provide.

These books will define the objectives of each experiment, describe the scientific background on which the experiment is based, outline the experimental procedures, and indicate the types of data anticipated.

In preparing these documents an attempt has been made to illustrate relationships between the planned Skylab investigations and high school science topics. Concepts for classroom activities have been included that use specific elements of Skylab science as focal points for demonstrations of selected subjects. In some areas these address current curriculum topics by providing practical applications of relatively familiar, but sometimes abstract principles; in other areas the goal is to provide an introduction to phenomena rarely addressed in high school science curricula.

It is the hope of the National Aeronautics and Space Administration that these volumes will assist the high school teacher in recognizing the educational value of the information resulting from the Skylab Program which is available to all who desire to make use of it.

Application

Readers are asked to evaluate the investigations described herein in terms of the scientific subjects taught in secondary schools. The related curriculum topics identified should serve as suggestions for the application of Skylab Program-generated information to classroom activities. As information becomes available from the Skylab Program, announcements will be distributed to members of the educational community on the NASA Educational

Programs Division mailing list. To obtain these announcements send name, title, and full school mailing list (including zip code) to:

National Aeronautics and Space Administration
Washington, D.C. 20546
Mail Code FE

Some of the aspects of space flight which because of the near weightless environment significantly restrict solutions to such problems as mass transfer, astronaut mobility, and mass measurement, are discussed in this volume.

In Section I the reader is introduced to a concept of weight, which while it departs from the classical physics view provides a concept for weight that satisfies both the laws of mechanics and our sensible notions of weight.

The related Skylab investigations are described in detail in Sections 2 through 4. The relationship between the experimental goals and the scientific basis for the experimental hardware and protocols are discussed.

Wherever possible, relationships have been developed between the Skylab scientific investigations and classroom curricula and activities. These relationships are discussed in each section as appropriate.

Acknowledgments

Valuable guidance was provided in the area of relevance to high school curricula by Dr. James R. Wailes, Professor of Science Education, School of Education, University of Colorado; assisted by Mr. Kenneth G. Jacknicke, Research Associate on leave from the University of Alberta, Edmonton, Alberta, Canada; Mr. Russel Yeany, Jr., Research Associate, on leave from the Armstrong School District, Pennsylvania; and Dr. Harry Herzer and Mr. Duane Houston, Education and Research Foundation, Oklahoma State University.

The Skylab Program

The Skylab orbiting space station will serve as a workshop and living quarters for astronauts as they perform investigations in the following broad categories: physical sciences, biomedical sciences, Earth applications, and space applications.

The spacecraft will remain operational for an eight-month period, manned on three occasions and unmanned during intervening periods of operation. Each manned flight will have a crew of three different astronauts. The three flights are planned for durations of one month, two months, and two months, respectively.

A summary of objectives of each of the categories of investigation follows.

Physical Science

Observations free of filtering and obscuring effects of the Earth's atmosphere will be performed to increase man's knowledge of (1) the sun and of its importance to Earth and mankind, and (2) the radiation and particulate environment in near-Earth space and the sources from which these phenomena emanate.

Biomedical Science

Observations under conditions different from those on Earth will be made to increase man's knowledge of the biological functions of living organisms, and of the capabilities of man to live and work for prolonged periods in the orbital environment.

Earth Applications

Techniques will be developed for observing from space and interpreting (1) Earth phenomena in the areas of agriculture, forestry, geology, geography, air and water pollution, land use and meteorology, and (2) the influence of man on these elements.

Space Applications

Techniques for adapting to and using the unique properties of space flight will be developed.

The Skylab Spacecraft

The Skylab cluster contains five modules (see illustration).

- 1) The *orbital workshop* is the prime living and working area for the Skylab crews. It contains living and sleeping quarters, food preparation and eating areas, and personal hygiene equipment. It also contains the equipment for the biomedical science experiments and for some of the physical science and space applications experiments. Solar arrays for generation of electrical power are mounted outside this module.
- 2) The *airlock module* contains the airlock through which suited astronauts emerge to perform activities outside the cluster. It also contains equipment used to control the cluster's internal environment and the workshop electrical power and communications systems.
- 3) The *multiple docking adapter* provides the docking port for the arriving and departing command and service modules, and contains the control center for the telescope mount experiments and systems. It also houses the Earth applications experiments and materials science and technology experiments.
- 4) The *Apollo telescope mount* houses a sophisticated solar observatory having eight telescopes observing varying wavelengths from visible, through near and far ultraviolet, to X-ray. It contains the gyroscopes and computers by which the flight attitude of Skylab is controlled. Solar arrays mounted on this module generate about half of the electrical power available to the cluster.
- 5) The *command and service module* is the vehicle in which the crew travels from Earth to Skylab and back to Earth, and in which supplies are conveyed to Skylab, and experiment specimens and film are returned to Earth.

Skylab will fly in a circular orbit about 436 kilometers (235 nautical miles) above the surface of the Earth, and is planned to pass over any given point within latitudes 50° north and 50° south of the equator every five days. In its orbital configuration, Skylab will weigh over 91,000 kilograms (200,000 pounds) and will contain nearly 370 cubic meters (13,000 cubic feet) for work and living space (about the size of a three bedroom house).

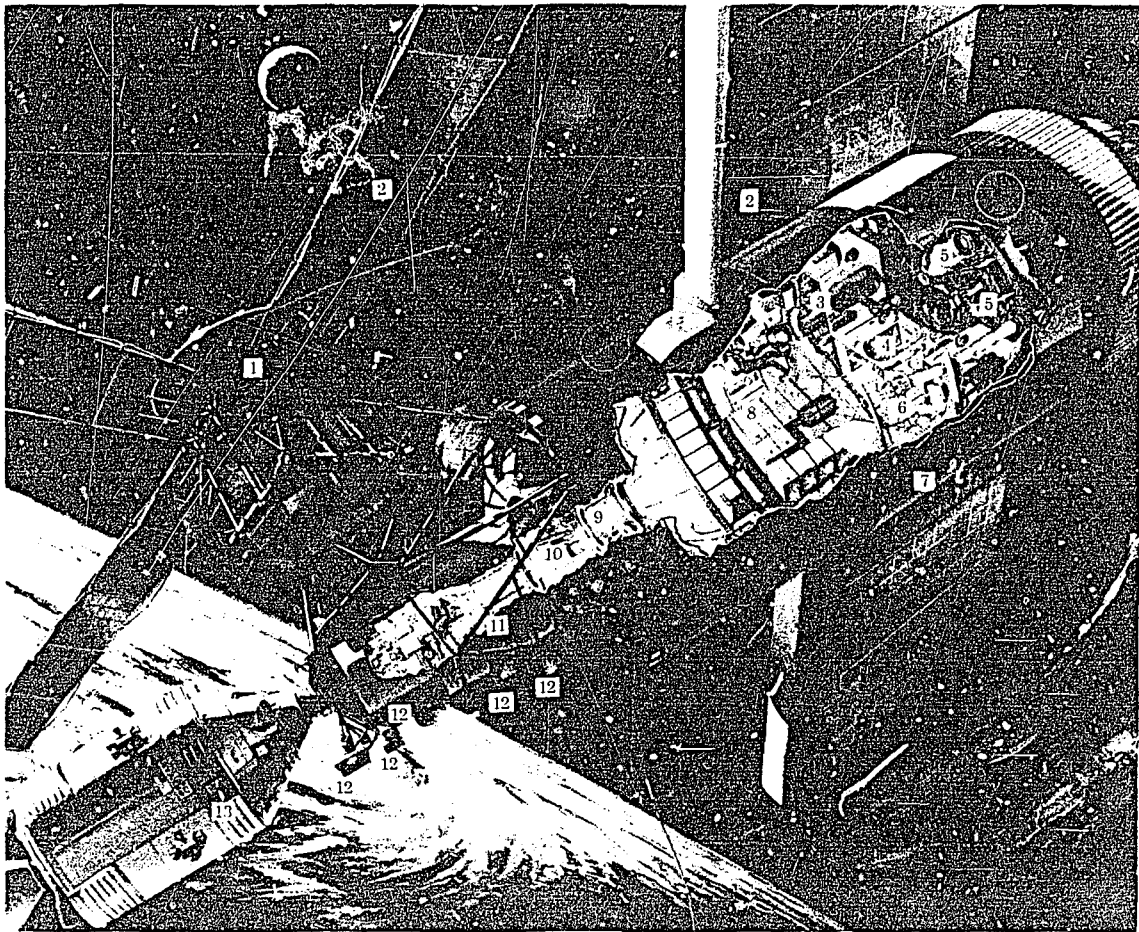

- | | |
|---------------------------------|--------------------------------|
| 1 Apollo telescope mount | 7 Orbital workshop |
| 2 Solar arrays | 8 Experiment compartment |
| 3 Sleeping quarters | 9 Airlock module |
| 4 Personal hygiene | 10 Airlock external hatch |
| 5 Biomedical science experiment | 11 Multiple docking adapter |
| 6 Ward room | 12 Earth resources experiments |
| | 13 Command and service module |

Skylab Orbiting Station

Section 1

Introduction

EXPERIMENT BACKGROUND

In physics, the study of the effects of forces upon bodies at rest or in motion is called mechanics. In general, the term may be applied whether the phenomena studied involve fluids, gases, or solids. Practically speaking, the term is restricted to rigid or elastic properties of solid materials. The science of mechanics is sometimes subdivided into Statics, Kinematics, and Kinetics. Modern usage favors the term "dynamics" reserving the term "mechanics" for the more practical phases of the field (machinery, building, etc).

The idea that the forces applied to a body control the motion of the body was described clearly for the first time by Sir Isaac Newton (1642–1727). In describing this motion, Newton postulated three laws that are now accepted as being universally true. Newton's three laws of motion may be stated as:

First Law—a body continues in its state of rest or uniform motion unless acted upon by an unbalanced force.

Second Law—the acceleration of a body acted upon by an unbalanced force is directly proportional to the unbalanced force, inversely proportional to the mass of the body, and in the direction of the unbalanced force.

Third Law—for every force or action there is an equal and opposite force or action.

The property of matter that is responsible for Newton's first law is attributed to inertia. Galileo performed a thought experiment that led him to an understanding of inertia even before Newton stated his laws of motion. In this experiment, Galileo noted that if a ball rolls down one inclined plane and up another, it will reach almost the same height on the second plane as its original height on the first incline. Galileo concluded that the difference was attributable to friction and that if friction could be eliminated, the heights would be identical. He further reasoned that regardless of the slope of the second plane, the ball would reach the same height. He argued that if the second slope were eliminated, the ball would keep rolling indefinitely. This behavior is, of course, a manifestation of Newton's first law. This property of matter, inertia, is exhibited by all matter and results in the body resisting any change in its state of motion, i.e., inertia keeps a stationary body stationary and keeps a moving body moving. The measure of inertia of an object is its mass so that mass defines the inertia of an object.

Two very simple experiments serve to demonstrate Newton's second law. In the first experiment, a small mass is subjected to successive unbalanced forces as measured with a spring

Statics deals exclusively with bodies at rest in equilibrium under the action of forces and torques.

Kinematics comprises the purely descriptive study of the motion of bodies without regard to the causative forces.

Kinetics deals with the relationship between forces and the resultant particle motions.

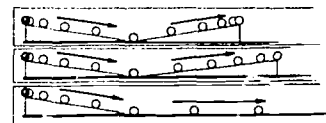

Galileo's Thought Experiment—the balls will reach the same height or continue to move indefinitely at constant velocity on a level surface. Relative velocities are illustrated by the distance between the balls.

scale. Using a stop watch and a meter stick, the time, t , to move the small mass one meter is measured and the acceleration, a , is computed from

$$a = \frac{1}{t^2}$$

When the acceleration, a , is plotted for the three successive forces, it will be observed that a straight line results.

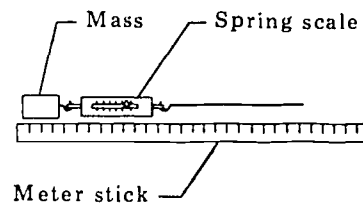
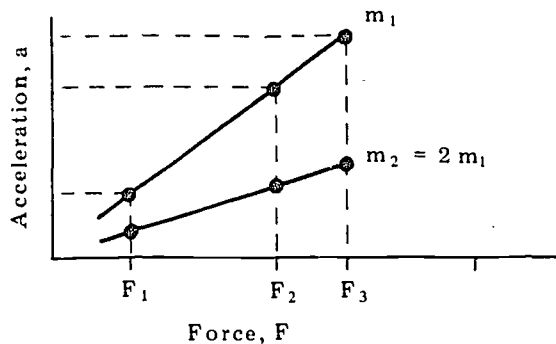

From this experiment, we conclude that acceleration, a , is proportional to force, F , that is,

$$a \propto F \quad [1]$$

Repeating the experiment using a constant force but doubling the mass of the weight each time, we find that acceleration, a , when plotted against mass is inversely proportional to mass, i.e., when mass is doubled for the same accelerating force, the acceleration will be one half as much.

So that

$$a \propto \frac{1}{m} \quad [2]$$

By combining Equations [1] and [2], we can say that

$$a \propto \frac{F}{m} \quad [3]$$

Inserting a proportionality constant and solving for F we obtain,

$$F = Kma$$

Defining the units of force in terms of mass and acceleration and letting the constant $K = 1$, yields

$$F = ma \quad [4]$$

In the MKS system, the unit mass is the kilogram and the unit acceleration has the dimensions meter per second² (m/sec^2). Thus, the force that produces a unit acceleration of a unit mass is $1 \text{ kg } m/sec^2$. This force has been defined as the Newton, n .

MKS—a system based on the fundamental units of the metric system, i.e., the meter, the kilogram, and the second

$$1n = 1 \text{ kg m/sec}^2$$

Newton's third law may be illustrated by considering the forces exerted when this book is placed on a table top. The weight of the book presses downward against the table while the table reacts with an upward force against the book. As long as the action force and reaction forces are equal in magnitude, the body continues at rest or unaccelerated movement. An airplane in unaccelerated flight at constant altitude is in equilibrium with four major forces which act as shown.

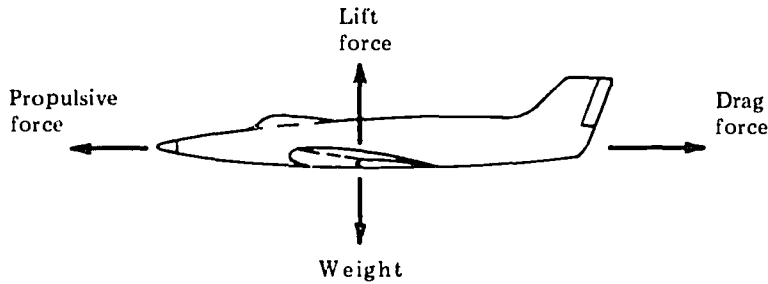

Increasing the propulsive force will cause the aircraft to accelerate to some new higher velocity where increased interaction with the atmosphere will cause the drag force to increase until it equals the propulsive force. The same equality exists between the lift force and weight so that lift always equals weight for constant altitude flight.

Newton's investigation of the effects of forces on masses included the behavior of falling bodies. Although Newton was the first to clearly describe gravity forces, he, of course, did not discover gravity. The discovery which Newton did make was the result of an intuitive leap which hypothesized gravitational forces as the forces that hold the planets in their orbits. Newton theorized that if this were true, then a single law could be used to explain the motion of celestial bodies in all parts of the universe. Using the earlier works of Tycho and Kepler, Newton deduced his law of gravitational attraction which states:

“The force of attraction between two objects is directly proportional to the product of the masses of the objects and inversely proportional to the square of the distance between them.”

Newton called this attractive force “gravitation.” Newton's universal law of gravitation can be written

$$F = G \frac{m_1 m_2}{S^2} \quad [5]$$

where F is the force of gravitation, m_1 , m_2 are the masses of the attracting objects, S is the distance between their centers of gravity, and G is a proportionality constant called the universal gravitational constant. Although Newton was able

to deduce the form of Equation [5], he was unable to measure the value of G with the instruments available to him. Cavendish made the first measurement of G in 1797 using the experimental setup shown in the sketch. Modern methods yield a value for G equal to $6.67 \times 10^{-11} \text{ n m}^2 / \text{kg}^2$.

Returning to Equation [5] we find that the force exerted on a body on or near the Earth's surface is a constant directly proportional to the mass of the body, m_p . This force may be calculated from Equation [5],

$$F = G \cdot \frac{m_E m_p}{R^2}$$

where m_E , R are respectively the mass and radius of the Earth. Dividing by m_p ,

$$\frac{F_w}{m_p} = G \frac{m_E}{R^2}$$

but

$$F_w = m_p g \tag{6}$$

where g is the acceleration the body would experience if it were free to move. In physics, this force F_w is called weight.

By substitution,

$$\frac{m_p g}{m_p} = G \frac{m_E}{R^2}$$

we obtain

$$g = G \frac{m_E}{R^2} \tag{7}$$

Since both G and m_E (mass of the Earth) are constant, the acceleration that the body would experience is dependent only on its distance from the center of the Earth. Since Equation [7] is perfectly general, substitution of the mass of any other celestial body will yield g for that body. (See table.)

This discussion touches on some rather interesting widely held notions regarding space flight. These notions hold that space flight is accompanied by a weightless and zero-gravity condition. It should be apparent that such notions are in conflict with the classical definition of weight since, in Equation [6], m_p is a constant independent of position, while g in Equation [7] approaches zero only at distances infinite from any celestial body. Our common sense understanding of weight results from responses felt in hefting a mass under the action of its mutual gravitational attraction with the Earth. We have all experienced the feeling of an

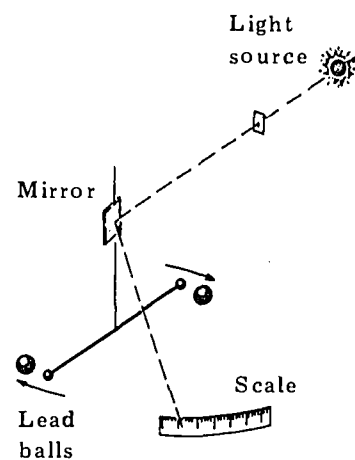

Simplified drawing of the Cavendish experiment. By observing the deflection of the light beam, the gravitational attraction between the lead balls can be measured.

Surface Gravities, m/sec^2
(Approximate)

Earth	9.8
Moon	1.57
Venus	8.72
Mars	3.82
Jupiter	23.23
Saturn	8.82
Mercury	3.92

apparent increase or decrease in body weight during accelerated motion; for example, on an elevator, roller coaster, automobile, or airplane. These apparent weight changes are easily understood if one accepts a somewhat simplified definition for weight proposed by H. Haber. This simplified definition avoids making a distinction between weight and apparent weight. Haber bases his definition on D'Alembert's principle. In applying this principle to dynamical problems, Newton's first law might be written as

$$F_g + F_i + F_E = 0$$

where F_g is the gravitational force (classically called weight $F_g = mg$), F_i is the inertial force defined by $F = ma$, and F_E is the sum of all external forces that act on the body. So that the apparent weight of a body becomes

$$W_A = F_g + F_i = -F_E$$

The distinction between weight and apparent weight is unnecessary because the resultant of combined gravitational and inertial forces is indistinguishable phenomenologically from the force of gravity alone. Hence, we may define weight as:

$$W = F_E = -(F_g + F_i)$$

It should be understood that this concept of weight is in conflict with the classical textbook definition of weight. This simplified definition has, however, the virtue of separating the concept of weight from its total reliance upon gravitational forces. Under such a definition, the gravitational force (mg) might be called, as Haber has suggested, the "normal weight." Using this concept of weight, it can be seen that there are essentially two sets of conditions under which all external forces vanish and weightlessness results. These occur for a body in (1) unrestrained free fall, or (2) in certain maneuvers in an aircraft where the propulsive force of the aircraft is directed equal and opposite to the vector sum of lift and drag. The conditions for (2) can be satisfied in so-called parabolic flight trajectories for short periods of time. The conditions of (1) are always met for coasting flight outside the atmosphere, as in an Earth satellite or spacecraft.

The resulting weightlessness and the absence of a sensible atmosphere during spaceflight contribute to two classes of operational problems during spaceflight. The first class of problems includes a related series of operational activities associated with astronaut movement, mass transfer, and attitude stabilization and orientation. The weightlessness and resulting lack of normal forces between bodies minimize frictional forces and complicate the movement of personnel between locations within and between spacecraft, while the

"Gravity, Inertia, and Weight," Chapter 9, *Physics and Medicines of the Upper Atmosphere* University of New Mexico Press, 1952.

D'Alembert's Principle—"The sum of the forces acting on a body in static or dynamic equilibrium is zero."

absence of an atmosphere negates the use of traditional air foils to generate steering forces. This operational problem will require the design, development, and evaluation of specialized propulsion and steering systems for efficient transfer of men and materials in the space environment.

The second class of operational problems is exemplified by the necessity to measure food intake, waste products, and body weight, and to perform a variety of other mass measurements and related activities. The weightlessness inherent in the environment of space makes the measurement of mass by conventional mass balance and force balance systems impossible and requires the design, development, and evaluation of sensitive, and accurate mass measurement devices.

The Skylab experimental program includes a variety of experiments and experimental hardware for evaluation of techniques to accomplish the required tasks. These hardware, protocols, and expected results are discussed in the following sections.

Section 2

Mobility Aids



EXPERIMENT BACKGROUND

The astronaut maneuvering unit (backpack assembly) and foot-controlled maneuvering unit are included in the Skylab scientific program to explore a variety of techniques for achieving astronaut maneuverability and stability in the weightless environment of space.

To date man's exploration of space other than lunar surface exploration has been limited to closely confined travel inside small spacecraft, with some crawling and drifting around the outside of the spacecraft, usually remaining connected to it by an umbilical cord through which oxygen is passed for breathing, control of the temperature of his suit, and for the rejection of waste gases. Biomedical instrumentation measurements and communications signals have also been transmitted via the umbilical cord.

Mobility on past missions

The scope of the activities that the astronaut has been required to perform was sometimes limited to single-handed operation, as the other hand was needed to hold him in place and provide a reaction to the force he was applying to the task. Strategically placed foot restraints allowed the use of both hands where the location of the planned task could be controlled.

If future astronauts are to perform productive work in space, they must be provided with mobility and stability capabilities approximating those found on Earth. The mobility aids required must provide means for translation between fixed locations as well as rotation about a prescribed axis. Some of the considerations related to these motions are described in the following paragraphs.

Requirements of future missions

Translation

The principal and novel characteristic of space flight, free fall through the frictionless vacuum of space, confronts the space traveler with a constraint on mobility that can be only roughly approximated on Earth by buoyant suspension in water or parabolic flight in aircraft. Suitably protected, the astronaut in space flight can drift with relative ease from one place to another. In this drifting mode, if he misses his destination, this same characteristic will cause him to continue his drift along a course that may never allow him to reach his destination, or return to the spacecraft he left. This characteristic of space flight affects the trajectory of a ball thrown across the room in a space station just as much as the path of the astronaut floating freely from one spacecraft to another. This unique trajectory, or flight path, is not common to conventional travel on or near the Earth's surface. In order to understand how the situation differs in orbital flight, it is necessary to understand the forces that act on a body and its contents as it circles the Earth.

Movements between locations in Earth orbit involve unique considerations

Consider the forces acting on a body that is traveling at constant speed along a curved path of constant radius as in Figure 2-1.

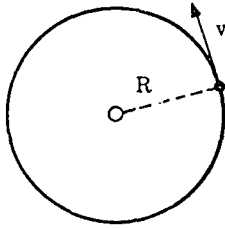

Figure 2-1 Uniform Circular Motion

This type of motion is called uniform circular motion. We recognize that some force must be acting on the body to cause it to follow such a path, otherwise, Newton's first law would require the body to travel along a straight line defined by the instantaneous direction of v . It is apparent that this force acts radially inward. The value of this force can be calculated as follows. (See Figure 2-2).

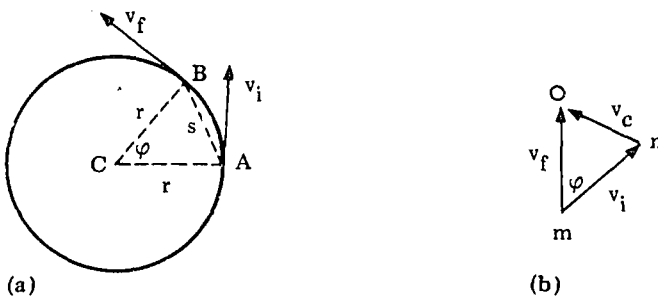

Figure 2-2 Velocity Vectors

The initial velocity of the body at A is v_i and after a small time interval t , the body will have advanced through the angle, ϕ to B where its velocity is v_f . Since v_f is the resultant velocity, we may calculate the change in velocity, v_c , by constructing the vector diagram as shown in Figure 2-2(b). The $\triangle MNO$ is similar to $\triangle ABC$ since v_i and v_f are equal and \perp to their respective radii, r , and $\sphericalangle\phi = \sphericalangle\phi$. Therefore, we may write for similar triangles,

$$\frac{v_c}{\text{chord AB}} = \frac{v_i}{r}$$

By taking the time interval, t , small enough, chord AB equals the arc length, s ,

and

$$\frac{v_c}{s} = \frac{v_i}{r},$$

but

$$s = \dot{v}_i t.$$

By substitution and letting

$$|\dot{v}_i| = |\dot{v}_f| = v,$$

we obtain

$$\frac{v_c}{t} = \frac{v^2}{r}.$$

But the change in velocity, v_c , divided by time, t , is acceleration which gives

Centripetal accelerations

$$a = \frac{v^2}{r} \quad [1]$$

From Newton's second law, $f = ma$, and Equation [1], we have

$$f = m \frac{v^2}{r} \quad [2]$$

The force, F , is the force that acts to cause the body, m , to travel a circular path of radius, r , at the constant speed, v .

Returning to the orbiting satellite and examining the situation for a source of such a force, we recognize that this force must be the gravitational attraction which is $F = mg$. Therefore, we may equate

$$m \frac{v^2}{r} = mg$$

which yields

$$v = \sqrt{rg} \quad [3]$$

The significance of this is that a satellite in circular orbit at radius, r , about any planetary body will have a precisely defined velocity, v , given by Equation [3] and will be acted upon by an accelerating force, mg , which is directed radially inward. The presence of this accelerating force acting at right angles to the velocity of the satellite causes the path or trajectory to be curved. The study of these motions is called "Orbital Mechanics." The study of orbital mechanics is very important in understanding how the body behaves because, for practical purposes, every change in velocity would inject the body in a new and different orbit. The following discussion shows some of the complexities associated with orbital flight.

Circular velocity of orbiting satellites

Kepler's second law of motion states that the area included in the angle subtended by a planet's (satellite's) motion in a unit time is always constant. In a circular orbit, the orbital velocity of the satellite is constant $v_{co} = \sqrt{rg}$. In an elliptical orbit the orbital velocity changes. At the lowest point of the satellite's orbit around Earth (perigee), the velocity and kinetic energy are the highest, and at the highest point (apogee), the velocity and kinetic energy are lowest. On the way "up," kinetic energy is traded for potential energy; on the way "down," the reverse applies.

The orbital velocities associated with the three orbits shown in the accompanying sketch are related so that the circular orbital velocity of orbit 1 (v_{co1}) is less than that of orbit 2 (v_{co2}). In the elliptical orbit of orbit 3, with an apogee at the altitude of orbit 1 and a perigee at the altitude of orbit 2, the orbital velocity at apogee is less than the circular orbital velocity of 1 $v_{a3} < v_{co1}$, and at perigee the velocity is greater than the circular orbital velocity of 2 ($v_{p3} > v_{co2}$).

In order to transfer from orbit 1 to orbit 2, the satellite first must decelerate to the apogee velocity of orbit 3, (v_{a3}), and then when it has fallen to the altitude of orbit 2, it must decelerate again to equal the velocity of orbit 2 (v_{co2}). The reverse applies to a transfer from orbit 2 to orbit 1.

How does this apply to an astronaut planning to transfer from one orbiting vehicle to another?

If the vehicle he wants to reach is in an identical orbit (and therefore of identical velocity) to that of his own vehicle but a short distance ahead, he must accelerate toward it. But this would send him into an orbit more elliptical than the one he left, and one that might take him over the top of his target. By precisely calculating and applying the appropriate acceleration (termed delta V—a change in velocity), he could enter an elliptical orbit that would cross his original orbit at a place and time coinciding with the target vehicle sometime later. A slight miscalculation of acceleration would expose him to the risk mentioned earlier—that of missing everything. The appropriate acceleration would vary, depending upon whether the astronaut wished to minimize the energy expended in making the transfer or the time spent in transit.

These same considerations apply, of course, to an astronaut who performs any activities outside his spacecraft. Since movement outside the spacecraft involves velocity changes carefully calculated and directed forces to remain adjacent to the spacecraft, or some form of tethering may be re-

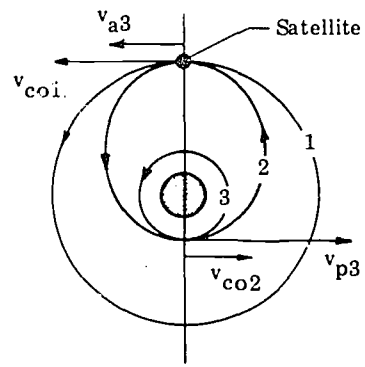
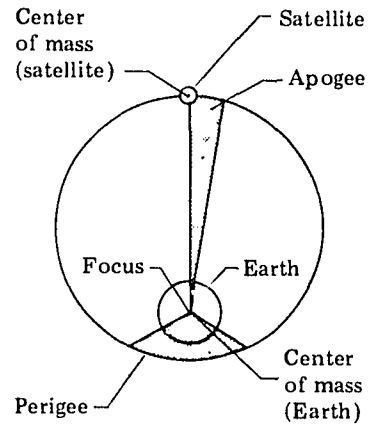

quired. Except in special cases where the distances traversed are small so that fuel expended and the transfer time are unimportant, the calculation of ideal acceleration profiles for transitioning between two orbital locations must be performed by computers and effected on command by suitably designed hardware.

Rotation

It is clear from this discussion that transfer between two orbital locations requires a precise computation of the magnitude and direction of application of forces to effect the transfer. It is convenient in the design of spacecraft and astronaut mobility aids to physically fix the force thrusters and rotate the entire assembly about its center of mass as a means of directing the thrust force. Control of these rotational motions is provided by an attitude control system. By convention, the motions (rotational displacements) about the center of mass are called pitch, roll, and yaw. These motions are described in the figure with the indicated directions being assigned positive values.

In the introduction to this book, Newton's laws of motion were stated. It is logical to assume that the rotational motion of bodies could be defined by similar considerations. Thus, we may conduct a thought experiment similar to Galileo's inclined plane experiment. Consider that the wheel in the sketch is comprised of a heavy rim and massless spokes and axle, and is supported on frictionless bearings. Extending our understanding of Newton's laws to this situation, it is logical to assume that the wheel, starting at rest, will remain at rest unless acted upon by an unbalanced force acting at right angles to the spokes in the plane of the wheel. Forces such as this, which act about a center of rotation, are called "torques." It is also logical that if the wheel were initially rotating at some constant rate, which we shall call ω , it would, in the absence of friction, continue to rotate indefinitely unless acted on by an unbalanced force or torque acting to increase or decrease wheel speed (ω). From these considerations, it is apparent that the wheel possesses a property similar to inertia, which causes it to resist any change in its state of motion or rest (Newton's first law). In the case of linear translation, this resistance was found to be directly related to mass, i.e., mass is the measure of inertia. If this experiment could be performed, it would be noted that this property of the wheel, resistance to change of its rotational state, is not determined by mass alone. Thus, two wheels having the same mass but different diameters would exhibit a different resistance. This new property is called "moment of inertia" and can be calculated as follows:

A massless rod, r , has a small mass, m , attached at one end, and the other end is attached to an axis of rotation at A. Assume that the rod and mass are in rotation on a flat fric-

Bodies in rotation exhibit properties similar to inertia

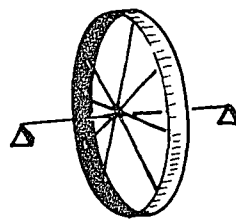
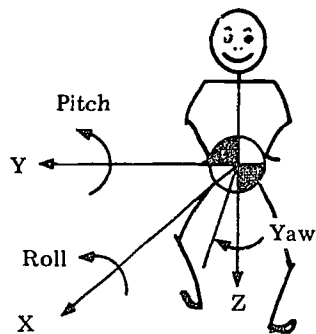

tionless table top so that we may ignore the gravity force. Let a force, F , assumed always perpendicular to the rod, act at R . The work done on the system by the force, F , will equal the increase in kinetic energy of the mass, m . If the system is initially rotating at the angular velocity, ω , after a short time interval, dt , the rod will have rotated through a small angle, $d\theta$ (For the mathematically uninitiated, the d can be taken to mean "very small."), and the angular velocity will have increased by $d\omega$. The work done in this time interval will be dW , so that

work = force x distance

$$dW = F ds \quad [1]$$

but

$$ds = R d\theta \quad [2]$$

and

$$dW = FR d\theta \quad [3]$$

now FR is the torque, T , that acts about the axis A , so

$$dW = T d\theta. \quad [4]$$

Since the initial circumferential velocity is

$$v = r\omega$$

then the initial kinetic energy is

$$K_i = \frac{1}{2}mv^2 = \frac{1}{2}mr^2 \omega^2. \quad [5]$$

Also the final velocity is the initial velocity, ω , plus the change in velocity, $d\omega$, so that the final kinetic energy is

$$K_f = \frac{1}{2}mr^2 (\omega + d\omega)^2 \quad [6]$$

completing the square yields

$$K_f = \frac{1}{2}mr^2 (\omega^2 + 2\omega d\omega + d\omega^2). \quad [7]$$

We can now find the change in kinetic energy, dK , which results from the application of the torque T . Subtracting Equation [5] from [7] and dropping the $d\omega^2$ term, which approaches zero, we obtain

$$dK = (mr^2) \omega d\omega \quad [8]$$

Recalling that the work done on the system must equal the change in kinetic energy, we may set Equation [4] equal to Equation [8] and

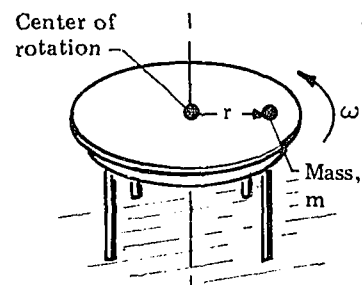
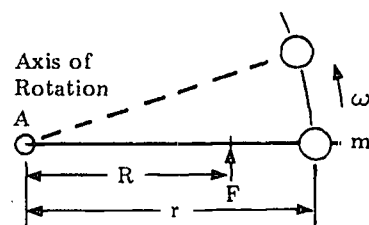

$$T d\Theta = mr^2 \omega d\omega$$

Dividing both sides by dt (time), we have

$$T d\Theta/dt = mr^2 \omega d\omega/dt$$

but $d\Theta/dt$ is the angular velocity of the wheel, ω , and $d\omega/dt$ is the angular acceleration of the wheel, a , hence

$$T = (mr^2) a \quad [9]$$

The similarity between Equation [9] and Newton's equation $f = ma$ for linear motion of a mass acted on by an unbalanced force is apparent. So that torque is the rotational analog of force; a is the rotational analog of acceleration; and mr^2 is the rotational analog of mass (inertia). In rotational systems, mr^2 is called moment of inertia and is designated by the letter I .

So that

$$T = Ia$$

The calculation of moment of inertia for other than very simple bodies must be performed by the methods of calculus and the reader is referred to the numerous literature available on this subject.

The Skylab program incorporates several unique pieces of hardware which will be evaluated by the crew for future orbital operations. These experiments are discussed in the following paragraphs.

EXPERIMENT OBJECTIVES

The objectives of these experiments are to evaluate the design of maneuvering devices in a weightless environment and to demonstrate the capabilities of the devices. The data and experience gained during the performance of these experiments will be related to ground-based analysis and simulation.

Figure 2-3 illustrates the foot-controlled maneuvering unit (FCMU). This device consists of a framework with a saddle seat and restraining straps to secure the crewman to the unit. Two 4-nozzle thruster assemblies, which are controlled by the foot motion of the crewman, are attached to the framework to provide attitude and translational accelerations. The backpack assembly contains the nitrogen gas supply for the thrusters.

Control is provided by the platform assembly which consists of two foot pedal assemblies, thrust control valves, two thruster assemblies, and propellant lines.

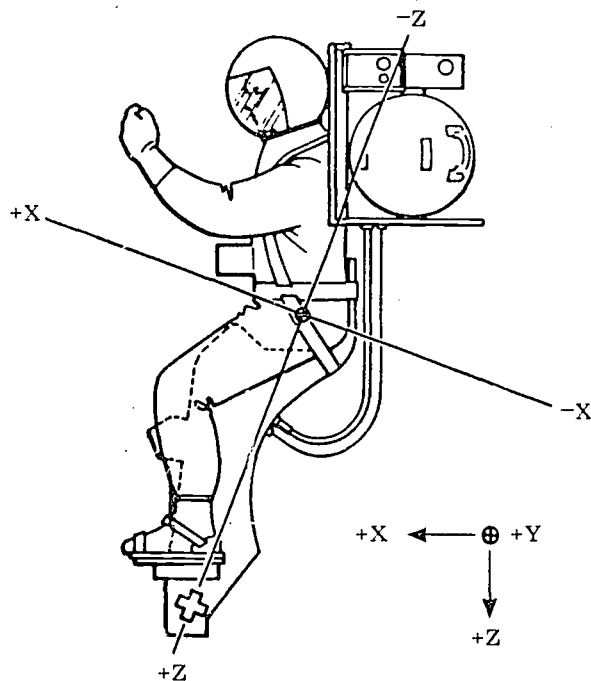

Figure 2-3 Foot-Controlled Maneuvering Unit

EXPERIMENT OPERATION

The foot pedal assembly operates the thrust control valves when activated by either foot. The resultant movement of the crewman is determined by the movement of his feet, as shown in Table 2-1.

A thruster assembly is mounted outboard of each foot. Each assembly consists of four nozzles to provide thrust forces in four directions as shown in Table 2-1. The top and bottom thrusters each produce 4.464 n of thrust and the fore and aft thrusters each produce 1.339 n of thrust.

Table 2-1 Operation of Foot Pedal Assembly

Foot Movement	Resultant
Both feet up	Translate head first
Both feet down	Translate feet first
Right and left toes up	Pitch up
Right and left toes down	Pitch down
Right toes up, left toes down	Yaw left
Left toes up, right toes down	Yaw right
Right foot up, left foot down	Roll left
Left foot up, right foot down	Roll right

Astronaut
Maneuvering
Unit (AMU)

The Astronaut Maneuvering Unit (AMU) consists of two different maneuvering unit configurations: (1) a backmounted unit with fixed position thrusters, called the automatically stabilized maneuvering unit, and (2) a handheld unit with manually positioned thrusters, called the handheld maneuvering unit.

The equipment will be operated in four modes to determine the response of each mode. The handheld maneuvering unit will be operated to evaluate man's maneuvering capability with a simple, small, lightweight, and completely manual handheld propulsion device to provide translational and rotational acceleration. The crewman must visually determine his attitude and attitude rates.

The direct mode uses the backpack with optimally placed thrusters. Rotational and translational accelerations are provided by two hand controllers. The left-hand controller controls translation along the X, Y, and Z axes; the right-hand controller controls rotations about these same axes. In the direct mode the crewman visually determines rates and displacements.



Figure 2-4 Astronaut Maneuvering Unit

Another mode will use the backpack with a rate-sensing attitude control system. A fourth mode will use a torque balance control moment gyro attitude control system. This mode is similar to the rate-sensing attitude except that attitude control is provided through momentum exchange instead of through use of the thrusters.

EXPERIMENT OPERATION

The operation of the handheld unit and the backpack in the direct mode is similar in principle to the foot-controlled maneuvering unit in that rotation and translation are controlled manually by the operator.

The rate gyro mode employs the gas expulsion system also, but in an automatic mode for the attitude control. Three rate gyros detect rotational rates in roll, pitch, and yaw and, with associated electronics, fire the appropriate thrusters to maintain the astronaut in the correct attitude.

The fourth mode also uses gas expulsion for accelerating the astronaut, but has a momentum exchange system to provide attitude control. The momentum exchange system consists of a series of control moment gyros and associated electronics.

EXPERIMENT DATA

The FCMU experiment uses two motion picture cameras, one mounted in the workshop dome and one mounted within the frame of the foot-controlled maneuvering unit, to provide the principal data for that device. Additional data is supplied by recorded voice commentary and logbook entries.

It is anticipated that at least one of the test subjects will operate both the AMU and the FCMU for comparison purposes. The AMU uses one motion picture camera mounted in the workshop dome and another mounted on the workshop wall. Analysis of camera data will permit determination of the astronaut's position and velocity. This equipment is instrumented to record numerous significant engineering data points including pertinent information on the handheld maneuvering unit and biomedical data during the pressure-suited runs. This data is sensed, collected, and telemetered from the maneuvering device to a receiver within the workshop and, together with recorded voice commentary, is later sent to ground stations. Crew performance while flying computer modeled systems on the ground will also be available.

RELATED CURRICULUM TOPICS

These experiments are related to physics and its associated mathematics. The manned operation of the mobility aids can also be related to man's inherent physiological and psychological limitations and functions.

SUGGESTED CLASSROOM ACTIVITIES

Modern physics textbooks contain a number of suggested demonstrations that adequately show the principles involved in this section. One suggested activity is to list the various methods that can be used to demonstrate action-reaction, momentum, gyroscopic energy, and other principles identified.

DISCUSSION

Referring to the sketch, explain which of the thrusters would provide the following motions:

Forward (+X) Translation

Backward (-X) Translation

Pitch Forward

Pitch Backward

Yaw Right

Yaw Left

Roll Right

Roll Left

Up (-Z) Translation

Down (+Z) Translation

Left (+Y)

Right (-Y)

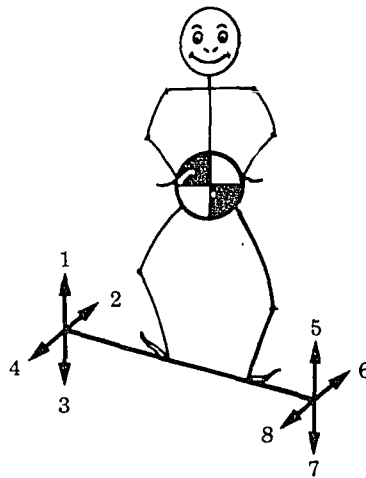

Other thruster configurations may be used in this discussion to obtain up to six degrees of freedom.

CLASSROOM DEMONSTRATION

Angular
Momentum
Exchange and
Body Rates

The forces generated by the control moment gyros can be demonstrated in the classroom. Materials required for this demonstration are—

- 1) Bicycle wheel
- 2) Swivel chair

The procedure is as follows:

- 1) Have a student sit on the swivel chair and hold the wheel by the axle with the plane of the wheel in a vertical position.
- 2) Have another student start the wheel rotating away from the student holding the wheel.
- 3) Slowly rotate the wheel to a horizontal position, first to the right, then to the left.
- 4) Repeat the above with the wheel rotating towards the student.

Discuss the relationship between the direction of the spin of the wheel to the reaction of the student when he rotates the axle to the right and the left.

An innovative use of these principles can be found from the following experiment.

Instead of rotating the axis of the wheel while the wheel is spinning, start the student rotating slowly. Note what happens to the wheel. This same principle is employed in a device called a "rate gyro." Rate gyros operate in the same way as control moment gyroscopes (CMG) except that their small physical size provides negligible torquing action on the spacecraft. Sensitive electronic pickoffs, however, provide electrical signals from which the rotational rates of the vehicle can be determined. These rates can be used as commands to the thrusters to control body rotations.

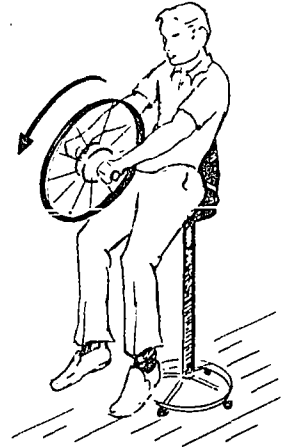

Section 3

Mass Measurement Devices

EXPERIMENT BACKGROUND

Studies from the Mercury, Gemini, and Apollo programs indicated the requirement for extensive inflight biomedical investigations since inflight bone, muscle, and body fluid changes were noted which may adversely affect performance during extended space flights. A group of experiments designed to investigate these phenomena are included on Skylab and are discussed in Volume 4, Life Science, of this series.

These experiments, Mineral Balance Assay of Body Fluids and Metabolic Activity, require the inflight measurement of each crewman's mass (weight) as well as the determination of the mass of any vomitus, feces, or unused food.

Because of the requirement to determine these masses a ground-based program was undertaken to provide a mass measurement device that would function in the environment of space. The concept chosen for these devices depends upon measuring the period of oscillation of a linear spring-mass system.

The principles are used in a device called an "inertia balance." This type of balance consists of a horizontal platform that is supported by two leaf springs. In operation, an object is placed on the platform and the system is set in vibration; the platform will oscillate (move back and forth) at a specific rate or frequency. The frequency of this motion is dependent upon the stiffness of the springs and the mass of the specimen. It is known that inertia is the property of matter which causes it to resist any change in its state of rest or motion. If two objects offer the same inertial resistance to a given accelerating force under identical conditions, they must have the same mass.

The weights of two specimens will be in the same ratio as their masses. If a known mass, M_1 , is set on the platform and the oscillations timed, T_1 , we can find the mass, M_2 , of an unknown specimen by timing, T_2 , the oscillations when the object is set into vibration. The relationship is

$$\frac{M_1}{M_2} = \frac{T_1^2}{T_2^2} \text{ or } M_2 = M_1 \frac{T_2^2}{T_1^2} \quad [1]$$

EXPERIMENT OBJECTIVES

The prime purpose of the experiments, Specimen Mass Measurement and Body Mass Measurement, is to support biomedical experiments requiring mass determination. Since the inertia balance method has not been previously used in a "weightless" environment, a secondary purpose is to validate the practicality of such a device. The experimental de-

VICES and protocols are in the nature of support equipment on Skylab but demonstrate scientific principles that will have utility on future missions.

EQUIPMENT

The operating principle of both experiments involves the measurement of periodic motion of an oscillating spring mass system. In each experiment, the mass is supported by a leaf-spring system which in normal operation results in simple harmonic motion. As previously stated, the frequency of motion is mathematically related to the mass of the oscillating body providing that the masses are homogeneous and rigid, or can be constrained to eliminate internal motions that can modify the simple harmonic motion of the balance.

Although the Body Mass Measurement System uses the same basic concept and scientific principles, the size and shape of the equipment differs according to the intended use. The Body Mass Measurement employs a chair and is designed to measure the mass of human subjects up to 100 kilograms in both Earth-based and orbital environments, whereas the Specimen Mass Measurement has a tray for measuring mass up to 1 kilogram in orbit and 500 grams during Earth-based operation.

In the case of the body mass measurement device, the test subject is neither homogeneous nor entirely rigid. Consequently, he must perform a "rigidizing" activity using special straps and bracing himself against the device, and holding his breath to stabilize his internal organs as much as possible. (See Figure 3-1.)

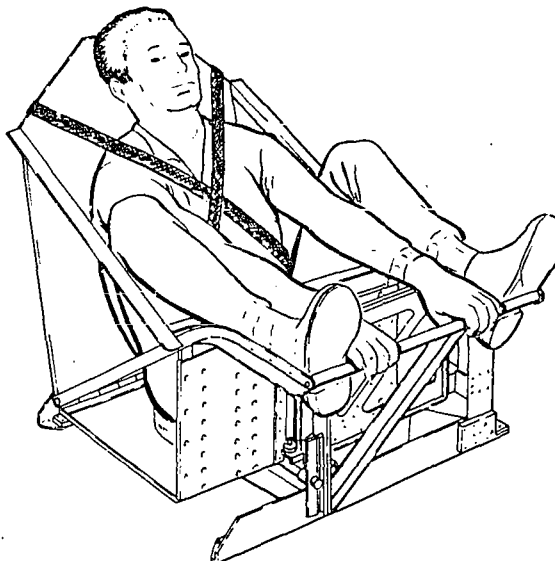

Figure 3-1 Body Mass Measurement Device

Both experiments are equipped with an electronics module that precisely times the oscillations of the device, displays the readings, and measures and displays the temperature. The electronics module contains an electro-optical transducer, consisting of a solid-state light emitting diode and a photosensitive transistor. This transistor generates a pulse each time a knife edge device attached to the chair or the tray breaks the light beam between them. This photodetector principle is illustrated in Figure 3-2. This pulse is used to turn a counter on and off and the oscillatory period is determined by counting clock pulses during a selected number of oscillations.

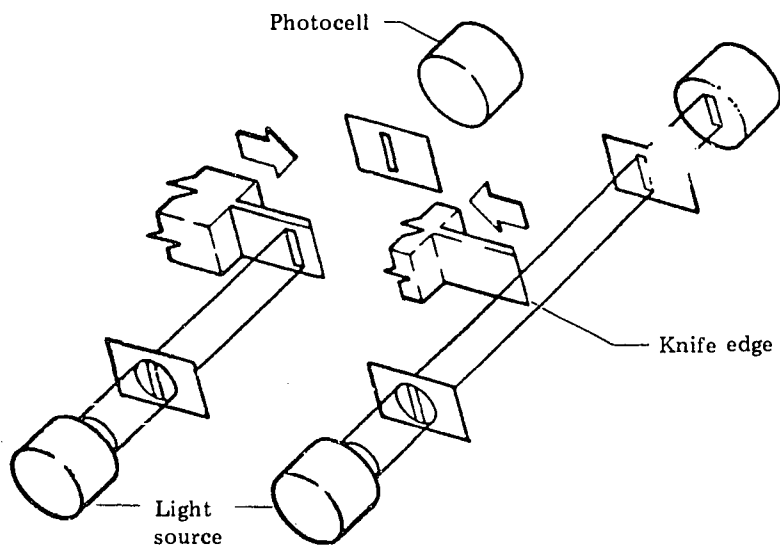

Figure 3-2 Photodetector Principle

The average of these clock pulses gives the time per oscillation. This time and the time for a calibrating mass can be used in Equation [1] to determine the unknown mass.

EXPERIMENT DATA

The Body Mass Measurement device will be used each day by each crewman daily in order to ascertain any weight changes. The Specimen Mass Measurement devices will be used daily to measure the masses of feces, vomitus, and other portions of food.

All readings are logged and voice transmitted to the ground.

RELATED CURRICULUM TOPICS

The concepts employed in the design and utilization of the mass measuring devices are related to a number of high school programs. These include physics, electronics, home economics, chemistry, and biology.

CLASSROOM DEMONSTRATION

Inertia Balance A simple inertia balance can be constructed to demonstrate the principles involved in the mass measuring devices. Materials required for this experiment are:

- 1) 2 hacksaw blades
- 2) 2 wood blocks, 2x4x4 in. long
- 3) Screws
- 4) Stopwatch
- 5) Various masses
- 6) Clamp
- 7) Putty

The materials are assembled as shown in the sketch. Extra holes are drilled in the hacksaw blades to accommodate extra screws to stabilize the device.

The device is operated as follows:

- 1) Set a known solid mass on the platform and secure with putty so it will not shift.
- 2) Set the system into vibration and time the oscillation. (This can best be determined by timing a certain number of complete cycles, 50 to 100 and dividing the time by the number of cycles.)
- 3) Repeat Steps 1 and 2 using other unknown masses. (CAUTION: The same quantity of putty must be used each time.)
- 4) Using equations, calculate the unknown masses.

Additional experiments to be conducted by the class are—

- 1) Try the balance in a different orientation; rotate 90 degrees so the oscillation is up and down. Compare results with the same masses used in the previous experiment. Discuss how this can be used to demonstrate that this balance functions with or without a gravity field.
- 2) Determine the mass of a liquid such as water. (Try measuring an ice cube, restrained as shown.) Repeat using the resulting water. Discuss what the oscillation of the liquid does to the period of the balance.
- 3) A Student Experiment (ED74) on Skylab uses a single-leaf spring in order to measure small masses. Discuss the significant differences that this approach would involve, i.e., linear vs combined linear and rotational dynamics.

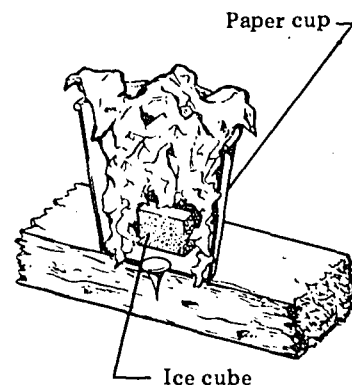
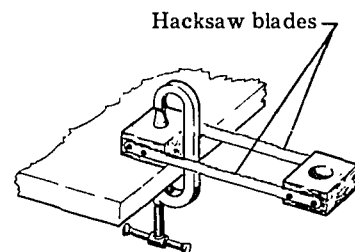

Section 4

Space Guidance

Crew/Vehicle Disturbances

EXPERIMENT BACKGROUND

There is an obvious need for an attitude control system on an orbiting spacecraft. Some of the most stringent requirements imposed upon a spacecraft in regard to attitude control arise from the operation of photographic experiments that require long exposure times. Some of these requirements are discussed in Volumes 1, 2, and 5 of this series. In order to establish an optimum design for such a system, it is necessary to know more precisely how the vehicle is affected by the forces acting upon it. In this regard it should be noted that forces acting on the vehicle (crew motions) internal to the vehicle can only produce net rotational disturbances; external forces can produce both net translational and rotational disturbances. For this reason, an experiment related to crew vehicle disturbances is included and the reaction of the experiment pointing control system of the Skylab will be monitored to ascertain the effect of various crew disturbances.

Translation between locations requires control of attitude so that forces are properly directed

EXPERIMENT OBJECTIVES

The objectives of this experiment are to obtain a series of measurements under controlled conditions to evaluate spacecraft disturbances caused by typical inflight crew motions and to verify the data from a ground-based simulation program.

EQUIPMENT

The equipment for this experiment consists of a Force Measuring System, a Limb Motion Sensor Assembly and associated electronics for collecting and storing the data.

FORCE MEASURING SYSTEM

The Force Measuring System consists of two force measuring units (FMU) located on the wall of the workshop, as shown in Figure 4-1. These units measure the actual forces and moments that will be imposed on the cluster during the experiment by a maneuvering crewman. Figure 4-2 illustrates one of the force measuring units that is basically a platform with foot restraints to secure the crewman to the plate. A series of load cells are arranged on the underside. Each load cell senses both tension and compression forces along its axis. Through the use of proper transformations, these forces can be resolved into forces along the reference axes and the resulting moments can be determined.

The limb motion sensor assembly provides the means for accurately measuring the degree of movement of the major joints of the human body. This is accomplished by using

Limb Motion
Sensor
Assembly

electrical transducers. The assembly is composed of a suit incorporating an exoskeletal structure that has one or more pivots at the major body joints. Figure 4-3 illustrates the exoskeletal structure which consists of a stick figure configuration conforming to the basic human form that is adjustable to fit a range of crewman sizes. Each of the sixteen joints houses a potentiometer that produces an output proportional to a movement of the joint.

Exoskeletal Structure—a stick figure device conforming to the basic human form that moves with the subject.

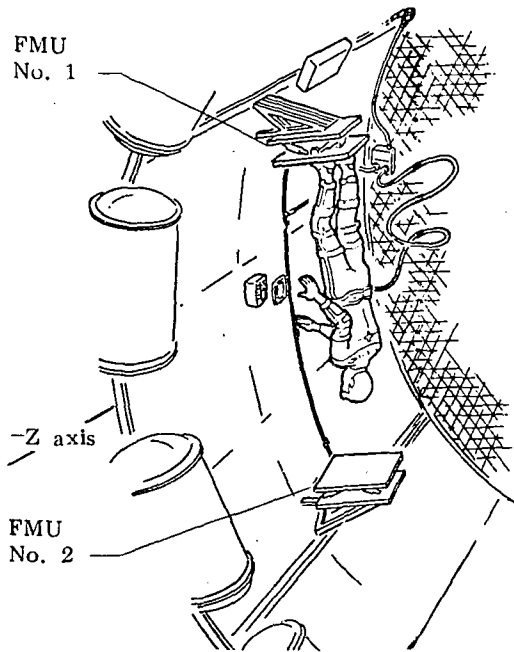

Figure 4-1 Force Measuring System Location

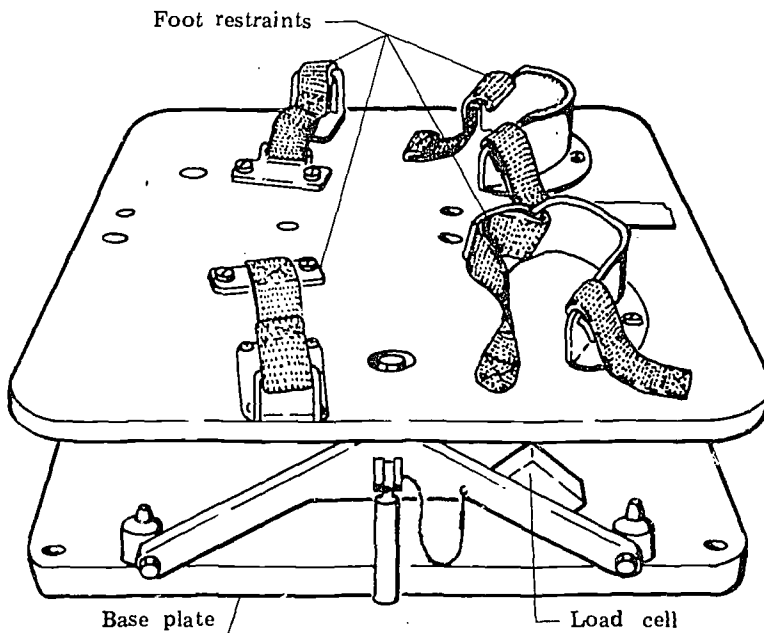

Figure 4-2 Force Measuring Unit

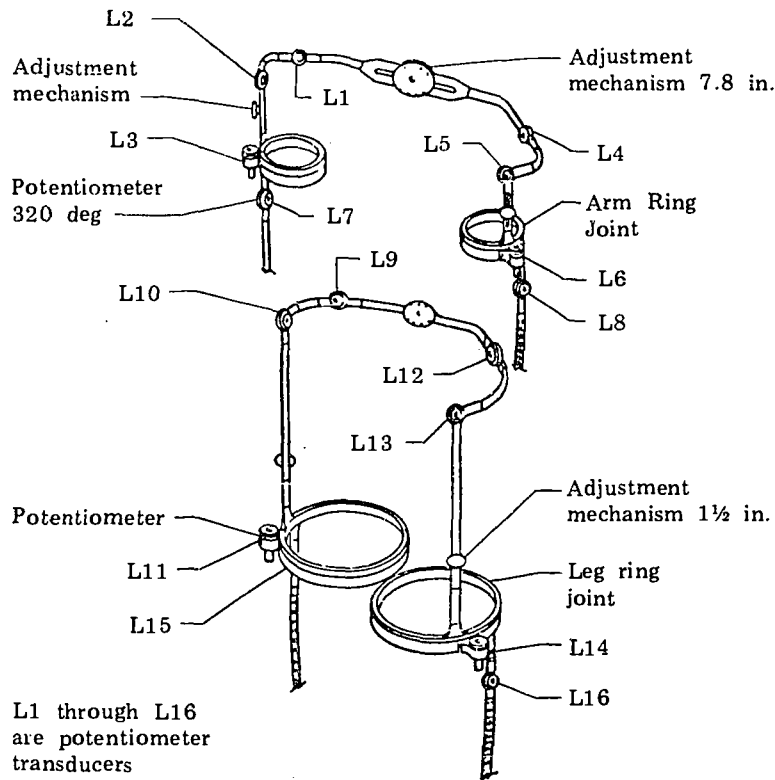

Figure 4-3 Exoskeletal Structure

EXPERIMENT OPERATION

A crewman wearing the limb motion sensor assembly will secure his feet to the force measuring system and perform various movements. In addition to various limb and body movements and translations between FMUs, the crewman will simulate such actions as coughing and sneezing. Other experiment sequences require the astronaut to maneuver between FMUs and to stop his motions with his hands.

EXPERIMENT DATA

While a crewman is performing the maneuvers, motion pictures will be taken to provide a photographic time history of the experiment. Subsequent evaluation of the photographic data will permit determination of the position of the astronaut's center of mass relative to the spacecraft's center of mass. In addition, the outputs of the load cells, the potentiometers, and the reaction of the cluster attitude control system will be recorded along with voice reactions of the crewmen.

RELATED CURRICULUM TOPICS

This experiment can be related to high school curriculum in such areas as physics and its associated mathematics. These

data can be used to enhance design of anthropometric mechanisms, and, in a limited way, may supplement anatomical studies.

CLASSROOM ACTIVITIES

Have a student sit on a swivel chair (as in the bicycle wheel demonstration) and slowly extend one arm out to one side.

The student must then rapidly swing the extended arm forward. How much does the chair rotate? How much does the chair rotate if one arm is extended to the side and one forward, and both swing rapidly in the *same* direction? What happens if both arms are extended sideways and then swing rapidly forward?

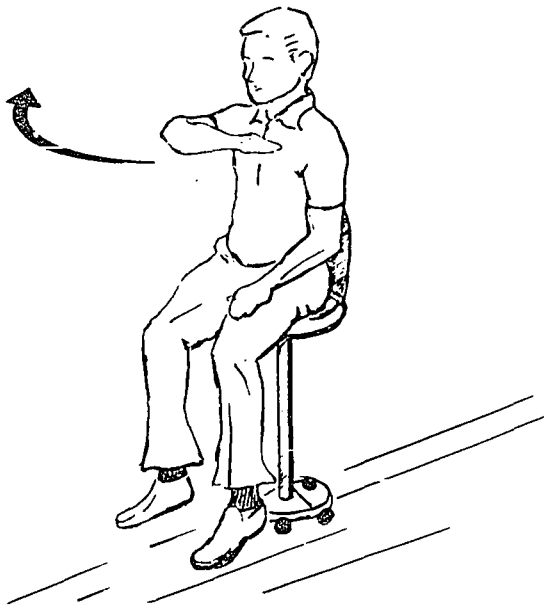

Section 5

Selected Bibliography



SUGGESTED ADDITIONAL READING

1. *Space Technology*, Edited by Howard S. Seifert, 1959, Library of Congress Catalog Card Number: 59-13033.
2. J. L. Meriam. *Mechanics*, Second Edition, Part II Dynamics, 1959, Library of Congress Catalog Card Number: 59-5877.
3. *Physics*, Second Edition, Physical Science Study Committee, 1965, Library of Congress Catalog Number: 65-24096.
4. Williams, Metcalfe, Trinklein, Lefler. *Modern Physics*. 1968, Library of Congress Catalog Number 03-063545-4.
5. *Space Resources for Teachers—Space Science*. EP-64 National Aeronautics and Space Administration 1969, for sale by the U.S. Government Printing Office, Washington, D.C. 20402. Price \$2.00.
6. *Space Mathematics, a Resource for Teachers*. EP-92 National Aeronautics and Space Administration, 1972, for sale by the U.S. Government Printing Office, Washington, D.C. 20402. Price \$2.00
7. H. Haber. "Gravity, Inertia, and Weight," Chapter 9, *Physics and Medicine of the Upper Atmosphere*, edited by O. J. Benson and C. S. White, University of New Mexico Press, Albuquerque, 1952.

* U. S. GOVERNMENT PRINTING OFFICE : 1973 728-990/971