

DOCUMENT RESUME

ED 115 486

SE 019 821

AUTHOR Resnick, Lauren B.
 TITLE Task Analysis in Instructional Design: Some Cases from Mathematics.
 INSTITUTION Pittsburgh Univ., Pa. Learning Research and Development Center.
 SPONS AGENCY National Inst. of Education (DHEW), Washington, D.C.
 REPORT NO LRDC-1975/20
 PUB DATE 75
 NOTE 51p.; Small type used in figure material

EDRS PRICE MF-\$0.76 HC-\$3.32 Plus Postage
 DESCRIPTORS Cognitive Development; Curriculum Design; *Educational Psychology; Elementary School Mathematics; Elementary Secondary Education; Information Processing; *Instructional Design; *Learning Theories; *Mathematics Education; Psychological Studies; Research; Secondary School Mathematics
 IDENTIFIERS Research Reports

ABSTRACT

Task analysis as a tool in the design of instruction is the subject of this paper. Some of the major historical approaches (associationist/behaviorist, gestalt, and Piagetian) are described using examples from mathematics. The usefulness of these approaches to instructional design is evaluated on the basis of four criteria: instructional relevance, psychological formulation, instructability, and recognition of stages of competence. A detailed discussion of rational and empirical information-processing analyses for instructional purposes follows. It includes descriptions of empirical studies carried out to validate and elucidate formal and informal task analyses of mathematical skills, such as addition and subtraction, and generalized "learning-to-learn" abilities.
 (Author/JBW)

 * Documents acquired by ERIC include many informal unpublished *
 * materials not available from other sources. ERIC makes every effort *
 * to obtain the best copy available. Nevertheless, items of marginal *
 * reproducibility are often encountered and this affects the quality *
 * of the microfiche and hardcopy reproductions ERIC makes available *
 * via the ERIC Document Reproduction Service (EDRS). EDRS is not *
 * responsible for the quality of the original document. Reproductions *
 * supplied by EDRS are the best that can be made from the original. *

ED115486

U S DEPARTMENT OF HEALTH,
EDUCATION & WELFARE
NATIONAL INSTITUTE OF
EDUCATION

THIS DOCUMENT HAS BEEN REPRODUCED EXACTLY AS RECEIVED FROM THE PERSON OR ORGANIZATION ORIGINATING IT. POINTS OF VIEW OR OPINIONS STATED DO NOT NECESSARILY REPRESENT OFFICIAL NATIONAL INSTITUTE OF EDUCATION POSITION OR POLICY



LEARNING RESEARCH AND DEVELOPMENT CENTER

1975/20

TASK ANALYSIS IN INSTRUCTIONAL DESIGN:
SOME CASES FROM MATHEMATICS

LAUREN B. RESNICK



University of Pittsburgh

5E019 821

2



ED1115486

TASK ANALYSIS IN INSTRUCTIONAL DESIGN:
SOME CASES FROM MATHEMATICS

Lauren B. Resnick

Learning Research and Development Center

University of Pittsburgh

To appear in David Klahr (Ed.), Cognition and Instruction. Hillsdale,
N. J.: Lawrence Erlbaum Associates, in press.

Preparation of this paper was supported by the Learning Research and Development Center, supported in part as a research and development center by funds from the National Institute of Education (NIE), United States Department of Health, Education, and Welfare. The opinions expressed do not necessarily reflect the position or policy of NIE, and no official endorsement should be inferred. The author wishes to express special thanks to Wendy W. Ford who assisted her at several stages of writing and editing this paper.

178 019 821

TASK ANALYSIS IN INSTRUCTIONAL DESIGN:
SOME CASES FROM MATHEMATICS

Lauren B. Resnick

Learning Research and Development Center
University of Pittsburgh

This paper takes as its general theme the actual and potential role of task analysis, particularly information-processing analysis, in instructional theory and instructional design. Some definitions are needed to make this opening statement sensible. The term instruction is used here in its most general sense to refer to any set of environmental conditions that are deliberately arranged to foster increases in competence. Instruction thus includes demonstrating, telling, and explaining, but it equally includes physical arrangements, structure of presented material, sequences of task demands, and responses to the learner's actions. A theory of instruction, therefore, must concern itself with the relation between any modifications in the learning environment and resultant changes in competence. When the competence with which we are concerned is intellectual, development of a theory of instruction requires a description of states of intellectual competence, and ultimately, of relations between these states and manipulations of the learning environment.

In developing a theory of instruction for intellectual or cognitive domains, task analysis is central. I mean by task analysis the study of complex performances so as to reveal the psychological processes involved. These analyses translate "subject-matter" descriptions into psychological descriptions of behavior. They provide psychologically rich descriptions of intellectual competence and are thus critical in bringing the constructs of psychology to bear on instructional design.

Psychological analysis of complex tasks is not a new idea. Task analyses are performed, although not usually under that name, in virtually all psychological investigations of cognitive activity. Whenever performances are analyzed into components--for experimental, interpretive, or theoretical purposes--task analysis of some kind is involved. Although the study of complex cognitive tasks has never dominated empirical psychology, significant occasions exist in which psychologists have turned their attention to such tasks. Not all have been instructional in intent but several important attempts bear examination because they have substantially influenced instructional theory or practice, or because, considered with instructional questions in mind, they offer insight into the possible nature of a theory of instruction based on cognitive psychology.

Because task analysis is pervasive in psychological research, delineating the scope of its usefulness is important when instructional concerns are central. Several criteria can be used to evaluate the potential contribution to instruction of different approaches to the psychological analysis of tasks. Four such criteria seem particularly important:

Instructional relevance. Are the tasks analyzed ones we want to teach? That is, are the tasks studied because of their instructional or general social relevance, or simply because they are easy to study, have a history of past research that makes results easy to interpret, or are especially suited to elucidating a point of theory? The criterion of instructional relevance implies that most tasks analyzed will be complex relative to many of the laboratory tasks that experimental psychologists find useful when pursuing non-instructional questions.

Psychological formulation. Does the analysis yield descriptions of the task in terms of processes or basic units recognized by the psychological research community? Task analysis is a means of bringing complex tasks, which have generally resisted good experimental analysis, into contact with the concepts, methods, and theories of psychology. Thus, while

the starting point for instructional task analysis is prescribed by social decisions--what is important to teach--the outcomes of such analysis, the terms used in breaking apart complex performances, must be determined by the state of theory and knowledge in psychology.

It is not always easy to fulfill both these criteria at once; instructional relevance is defined in terms different from those which psychological researchers use in building their theories. Nevertheless, it is important to try to analyze instructional tasks in terms that contact the current body of knowledge and constructs in psychology so that instructional practice can profit from scientific findings as they exist and as they develop.

Instructability. Because our concern here is with task analysis as an aid to instruction, an obvious question is whether the results of a particular analysis are useable in instructional practice. In other words, does the task analysis reveal elements of the task that lend themselves to instruction, i. e., that are "instructable?" It is the function of task analysis to examine complex performances and display in them a substructure that is teachable--either through direct instruction in the components, or by practice in tasks that call upon the same or related processes.

Recognition of stages of competence. Does the task analysis recognize a distinction between early and later forms of competence? Analyses for instructional purposes cannot just describe the expert's performance (although such description will almost always be a part of such analyses). They must also describe performance characteristics of novices and attempt to discover or point to key differences between novices and experts, suggesting thereby ways of arranging experiences that will help novices become experts. Instructional task analysis, in other words, should elucidate the relation between activity during learning and competence that results from learning. It should suggest ways of organizing knowledge to assist in acquisition, recognizing that this organization may differ from organizations that are most efficient for expert use of that knowledge.

In summary, four criteria can be applied in assessing the contributions of psychological task analyses to instruction: (a) instructional relevance, (b) psychological formulation, (c) instructability, and (d) recognition of stages of competence. I shall examine several prominent approaches to the psychological analysis of complex tasks and consider their contributions to instruction in light of these criteria. I begin with some important past efforts to describe intellectual competence in psychological terms, and then turn to current information-processing approaches to task analysis. In order to make the domain of the paper manageable, discussion is limited to analysis of mathematics tasks. The work discussed, however, does not exhaust task analysis efforts in mathematics. Rather, it highlights certain cases that have considerably influenced psychology or instruction, or both, and that form landmarks in whatever might today be written of the history and current status of this branch of instructional psychology.

A Selective History of Task Analysis

I will discuss first the work of three predecessors of modern information-processing task analysis, in each case using work on mathematics as the substantive example. These are: (a) work in the associationist/behaviorist tradition (Thorndike, Gagné); (b) work of the Gestalt school (especially Max Wertheimer); and (c) the Piagetian task analyses. Both substantively and methodologically, the approaches of these groups to task analysis reflect differences in their theoretical positions, differences which in turn affect the kinds of contributions that each can make to instruction.

The Associationist/Behaviorist Tradition

Thorndike's analyses in terms of S-R bonds. In the early part of this century, experimental and educational psychology were closely allied. Many of the major psychologists of the period up to about 1930 were actively engaged in both laboratory research and applied research, some of it relevant

to instructional practice. One of the foremost of these was Edward L. Thorndike. His work on The Psychology of Arithmetic, published in 1924, represents his attempt to translate the associationist theory of "laws of effect," which he himself was active in developing, into a set of prescriptions for teaching arithmetic. In the preface to the book, Thorndike states that there is now a "new point of view concerning the general process of learning. We now understand that learning is essentially the formation of connections or bonds between situations and responses, that the satisfyingness of the result is the force that forms them, and that habit rules in the realm of thought as truly and as fully as in the realm of action" (p. v). Based on this then widely agreed upon theory of psychological functioning, Thorndike proposed a pedagogy that has extensively influenced educational practice for many years.

Thorndike proposed the analysis of arithmetic tasks in terms of specific connections, or bonds, between sets of stimuli and responses, and the organization of instruction to maximize learning of both the individual bonds and the relations among them. His book began by discussing the general domains of arithmetic for which bonds must be formed--for example, the meanings of numbers, the nature of decimal notation, the ability to add, subtract, multiply, and divide, and the ability to apply various concepts and operations in solving problems. Thorndike then spent some fifty pages discussing the types of bonds that give precise meaning to this broad definition of the domain of arithmetic. His analysis did not approach the level of individual stimulus-response pairs but remained on the more general level of connections between situations and sets of responses. Citing numerous examples, he argued that certain kinds of bonds taught in many of the standard textbooks of the day were misleading and should not be taught, while other helpful bonds were neglected in pedagogical practice. For example, verifying results of computations, learning addition and subtraction facts for fractions, and solving equations (even before algebra was added to the curriculum) were considered "desirable"

bonds; while senseless drill in finding the lowest common denominator of fractions (when use of any common denominator would lead to solution of problems) and the posing of problems unrelated to real-life situations led to formation of "wasteful and harmful" bonds which made arithmetic confusing and unpleasant. Discussion of appropriate and inappropriate forms of measurement of the bonds or elements of arithmetic knowledge were also included. Thus, the book translated a standard school subject into terms--collections of bonds--that suggested applications of known laws of learning to the problems of instruction.

The laws of learning, and thus of pedagogy, were for Thorndike those dealing with such drill and practice as would strengthen the bonds. Questions such as amount of practice, under- and over-learning, and distribution of practice were considered. These are easily recognized as topics that have continued to occupy psychologists--although rarely directly in the context of school instruction--and that heavily though indirectly influence instructional practice even now. What is important about Thorndike's work, however, is that he was concerned not only with the laws of learning in general, but also with the laws of learning as applied to a particular discipline, arithmetic. He left the laboratory to engage in applied research, but brought with him the theory and to a large extent the methodology of the experimental laboratory. He thus began a tradition of experimental work in instruction by psychologists. This tradition was interrupted for many years but is now being revived.

Gagné's hierarchies of learning sets. While Thorndike recognized the need for a theory of sequencing in his presentation of bonds as constituting the subject matter of arithmetic, he proposed no systematic theory of sequencing. In the decades following Thorndike's work, mathematics educators and educational psychologists (e.g., Brownell & Stretch, 1931; Hyde & Clapp, 1927) studied, with varying degrees of care and precision, the relative difficulty of different kinds of mathematical problems. They

thus empirically, if not theoretically, extended Thorndike's work in instructional analysis and suggested that arranging tasks according to their order of difficulty would optimize learning, especially of the more difficult tasks. Skinner's (1953) prescription for the use of "successive approximations" in instruction represented a refinement of this basic idea. But neither Skinner nor his immediate interpreters proposed a systematic strategy for generating the order of successive approximations--i. e., the sequence of tasks in instruction. Not until the 1960s and Gagné's (1962, 1968) work on hierarchies of learning did any organized theory of sequencing for instructional purposes appear within the behaviorist tradition.

Learning hierarchies are nested sets of tasks in which positive transfer from simpler to more complex tasks is expected. The "simpler" tasks in a hierarchy are not just easier to learn than the more complex; they are included in or are components of the more complex ones. Acquiring a complex capability, then, is a matter of cumulating capabilities through successive levels of complexity. Transfer occurs because simpler tasks are included in the more complex. Thus, learning hierarchies embody a special version of a "common elements" theory of transfer.

Widespread use of hierarchy analysis has begun among instructional designers, particularly in mathematics and science (see White, 1973). For the most part, the analyses have been of the kind Gagné originally described. Thus, hierarchies for instruction are typically generated by answering, for any particular task, the question, "What kind of capability would an individual have to possess to be able to perform this task successfully, were we to give him only instructions?" One or more subordinate tasks are specified in response to this question, and the question is applied in turn to the subordinate tasks themselves.

Figure 1 shows an example of one of Gagné's hierarchies. The tasks described in the top boxes are the targets for instruction. Lower boxes show successive layers of subordinate capabilities, simpler tasks whose

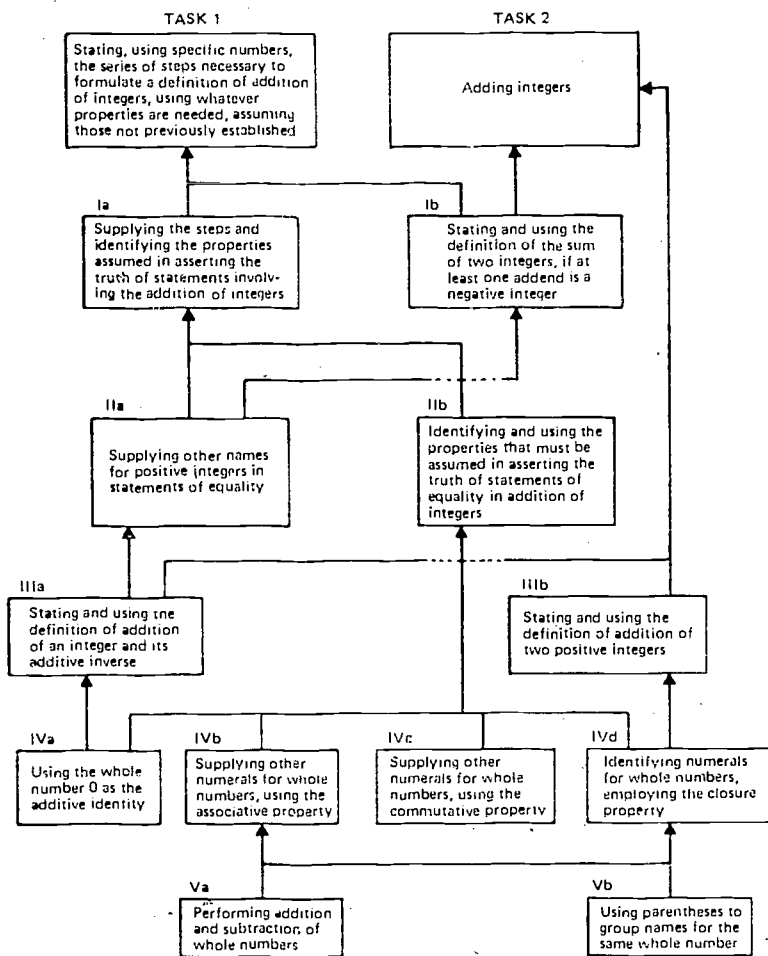

Figure 1. A learning hierarchy pertaining to the addition of integers. (From "Factors in Acquiring Knowledge of a Mathematical Task" by R. M. Gagne, J. R. Mayor, H. L. Garstens, and N. E. Paradise, *Psychological Monographs*, 1962, 76 (7, Whole No. 526). Copyright 1962 by the American Psychological Association. Reprinted by permission.)

mastery facilitates learning the more complex ones. Instruction begins with the lowest-level capabilities not already mastered and proceeds upward. The tasks at the low end of the hierarchy can further be analyzed, depending on assumptions about the learner's knowledge. The more elementary capabilities are assumed to involve more elementary types of learning. In other words, implicit in a complete learning hierarchy for tasks such as shown in Figure 1 is another hierarchy of "types of learning," progressing from simple S-R learning, through chaining and discrimination, to higher-level concept and rule learning, as shown in Figure 2. A more complex task such as problem solving would involve more concept and rule learning and would lead to the discovery of progressively higher-order generalizable rules. There is a kind of implicit process analysis involved in the method of hierarchy generation. Presumably, to answer the question that generates subordinate tasks, one must have some idea of what kinds of operations--mental or otherwise--an individual engages in when he performs the complex task. But this model of performance is left implicit in Gagné's work.

Gestalt Psychology and the Analysis of Mathematical Tasks

Gestalt psychology was an immigrant in America. In its first generation it spoke a language so unlike the rest of American psychology that it was barely listened to. Now, in a period when we speak easily of cognition and mental operations, the gestalt formulations take on more interest. Gestalt theory was fundamentally concerned with perception and particularly the apprehension of "structure." With respect to the complex processes of thinking, the concept of structure led to a concern with "understanding" or "insight," often accompanied by a visual representation of some kind. With respect to problem solving, the central concern was with the dynamics of "productive thinking." Several gestalt psychologists, particularly Wertheimer (1945/1959) and his students (Katona, 1940; Luchins & Luchins, 1970), attempted to apply the basic principles of

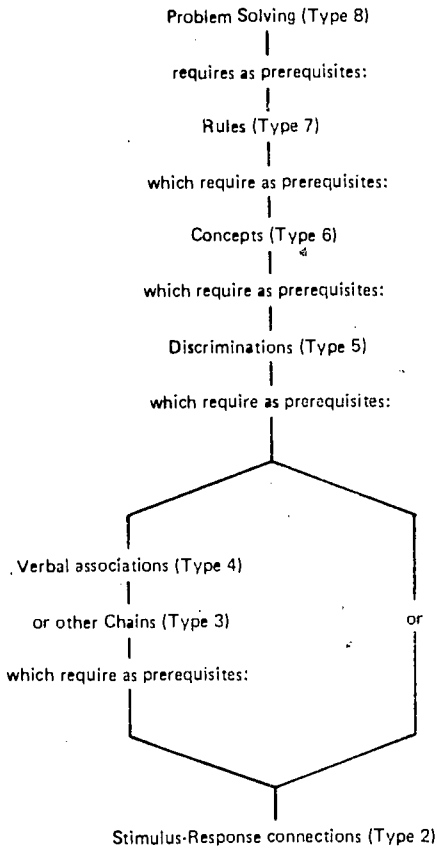

Figure 2. Gagné's hierarchy of types of learning. (From R. M. Gagné, *The Conditions of Learning* (2nd ed.). New York: Holt, Rinehart, and Winston, 1970. Copyright 1970 by Holt, Rinehart, and Winston, Inc. Reprinted by permission.)

gestalt interpretation to problems of instruction and, in particular, to the teaching of mathematics. It is reasonable to imagine that mathematics, especially geometry, was of particular interest to gestalt theorists because of its high degree of internal structure and its susceptibility to visual representation.

Wertheimer contrasted his theory of productive thinking both with traditional logic and with associationist descriptions of problem solving. Neither of these, he claimed, gave a complete picture of how new knowledge is produced by the individual. With respect to teaching, he was concerned that prevalent methods of teaching, with emphasis on practice and recall, produced "senseless combinations" rather than productive problem solving based on the structure of the problem.

Wertheimer's (1959) book, Productive Thinking, originally published in 1945, discussed work on several mathematics problems--for example, finding the area of a parallelogram, proving the equality of angles, Gauss's formula for the sum of a series, symmetry of oscillations, arithmetic calculations, and the sum of angles of a figure. Analysis of these tasks, for Wertheimer, consisted of displaying the problem structure on which algorithms are based, rather than analyzing actual performance. Thus, for example, the problem of finding the area of a parallelogram was seen as a problem of "gap fitting"--too much on one side, too little on the other (see Figure 3). Once the gap was filled and a rectangle formed, a general principle for finding area could be applied. Recognizing the nature of the problem--the possibility of transforming the parallelogram into a rectangle--constituted for Wertheimer "understanding" or "insight." Solutions that followed from this understanding were for him true solutions, elegant ones. Those that "blindly" applied an algorithm, even if the algorithm should work, were "ugly."

Though Wertheimer talked little about general schemes for instruction, he implied the necessity of analyzing tasks into components, perceptual and structural, so that their nature in relation to the whole problem would be

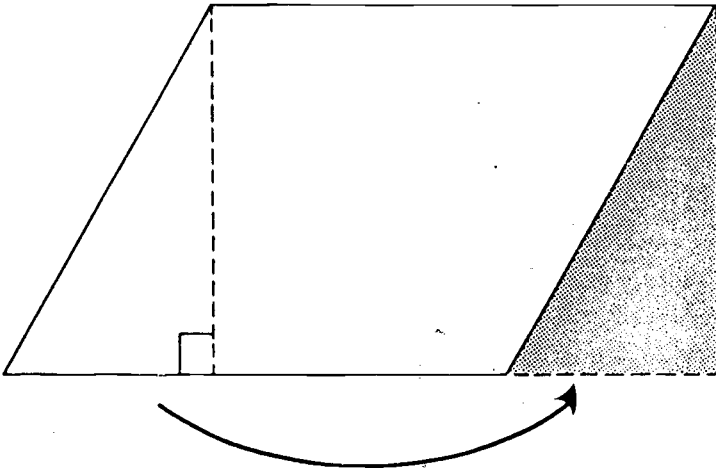

Figure 3. Wertheimer's area of a parallelogram problem.

clear. Only when the true structures of problems were understood could principles derived from them be properly generalized. Whenever possible, the student should be left to discover both the problem and its solution. Instruction, if necessary, should proceed consistent with the internal structure of the problem and in the proper sequence, so that a true understanding leading to solution would be gained. Just how the understanding of components and their part-whole relations was to be taught was not made clear. Wertheimer suggested the introduction of exercises to focus students' attention on certain aspects of the problem structure, thereby increasing the likelihood of insight. He also spoke of operations involved in thinking--grouping, reorganizing, structuring--for which ways of teaching might be devised.

Piagetian Analyses *

In discussing Piagetian task analysis, we will consider two quite distinct bodies of literature in succession: (a) Piaget's own work (and of others in Geneva), and (b) attempts--largely by American and British psychologists--to isolate the specific concepts and processes underlying performance on Piagetian tasks.

Genevan work. Much of Piaget's own work (on number, geometry, space, etc.) is heavily mathematical in orientation. It seeks to characterize cognitive development as a succession of logical structures commanded by individuals over time. Piaget's "clinical method" of research yields great quantities of raw process data--protocols of children's responses to various tasks and questions. The protocols are interpreted in terms of the child's "having" or "not having" structures of different kinds. Explanation of a task performance for Piaget consists of descriptions of the logical structures that underlie it, and of the structures that ontologically preceded and therefore in a sense "gave birth to" the current ones.

Piaget's tasks are chosen to exemplify logical structures that are assumed to be universal. Many turn out to involve mathematics, but not

by and large the mathematics taught in school. One result has been considerable debate over whether the Piagetian tasks should become the basis of the school curriculum, whether they are teachable at all, and whether they set limits on what other mathematical content can be taught (for differing points of view on this matter, see Furth, 1970; Kamii, 1972; Kohlberg, 1968; and Rohwer, 1971). Although Piaget's work has not until recently been motivated by instructional concerns, others have tried to interpret his work for instruction. Such interpretation has often resulted in at least partially competing interpretations.

Piaget's most important contribution to task analysis is probably his pointing out, in compelling fashion, the important differences between children and adults in the way they approach certain tasks, the knowledge they bring to them, and the processes they have available. But his particular form of logical analysis leaves questionable the extent to which his descriptions elucidate the "psychologics" of behavior on these tasks, i. e., what people actually do. Certainly for psychologists accustomed to the explicit detail of information-processing analyses, Piaget's leaps from observations to inferences about logical structure are often difficult to follow.

Experimental analyses of Piaget's tasks. Much of the English-language research on Piaget has focused on locating specific concepts or component processes underlying the ability to perform well on particular tasks. Conservation tasks have been most heavily studied, classification tasks probably next most heavily, with relatively little study of tasks characteristic of the formal rather than concrete stages of operational thinking (see Glaser & Resnick, 1972).

Two basic strategies can be distinguished in this research. One varies the task in small ways to allow inferences about the kinds of cognitive processes being used. For example, Smedslund (1964, 1967a, 1967b) presented double classification tasks with attributes covered or uncovered, labelled or perceptually presented. From performance on these variations, he concluded

that processing was probably done at a symbolic rather than a perceptual level, that memory was involved, and that some kind of analytic mechanism might be involved in committing perceptions or symbols to memory.

The second research strategy is to instruct children in a concept or process hypothesized to underlie performance on some Piagetian task, and then to see whether they thereby become able to perform the task. Examples are Gelman's (1969) training of conservation by teaching discrimination of length, density, and number; and Bearison's (1969) induction of conservation by training in equal-unit measurement of liquid quantity. Of the two approaches, the second is more relevant to the present context, because the strategy of instruction demands an analysis in terms of instructable components.

Assessment of the Approaches with Reference to Instruction

How do these past approaches to task analysis match the criteria outlined for instructional relevance? To what extent does each address itself to tasks of instructional interest? To what extent do the terms of analysis provide a link to the main body of psychological theory and knowledge? Are instructable units identified? Do the analyses distinguish usefully between performance of learners and of experts?

Instructional relevance. With respect to the choice of tasks, only Thorndike and Gagné show a clear instructional orientation. Their tasks are drawn from school curricula, and where formal validation studies of their analyses occur, they are to a large extent based on the effectiveness of actual instruction in the units identified (e.g., Gagné, Mayor, Garstens, & Paradise, 1962). Wertheimer and the others of the Gestalt school analyze a few tasks drawn from mathematics, but make no attempt to analyze a whole range of subject matter. Further, despite some discussion of productive thinking as a generalized phenomenon of educational concern, there is no analysis of it as such in Wertheimer's work. Wertheimer probably

chose tasks from mathematics that would best lend themselves to analysis in terms of perceptual "Gestalten" rather than selecting those of particular importance to instruction. On the criterion of types of tasks analyzed, Piaget's work is even less directly relevant to instruction. There is, in fact, serious question whether the tasks he has studied ought to be the objects of instruction, because they are psychological "indicators" of general cognitive status rather than socially important tasks, and because they appear to be acquired in the course of development, at least in Western and certain urbanized cultures, without formal schooling (Glaser & Resnick, 1972). It may be, however, that formal operations need to be taught explicitly, because it is by no means clear that formal operational thinking is universally acquired (Neimark, 1975).

Psychological formulation. Each approach addresses well the analysis of complex tasks in terms of the fundamental psychological constructs relevant to their own times and theories. Thus, Thorndike's analyses describe arithmetic in terms of the basic psychological unit of then current theory, the associationist bond, and thus suggest specific pedagogical practices drawn from known principles of learning. Gagné's analyses interpret instructional tasks in terms of behavioral learning psychology: transfer, generalization, and so forth. His concern for the learning of "higher processes" such as rules and principles suggests some concern shared with cognitive psychology, but basic cognitive processes such as memory and perception are alluded to only as general abilities assumed to be neither instructable nor further analyzable. Wertheimer's analyses of mathematical tasks explicitly indicate how gestalt field theory would interpret problem solving and learning in these domains. Finally, Piaget's analyses, like Wertheimer's, attempt to show that performance on complex tasks can be interpreted in terms of underlying structures. For Piaget and Wertheimer, explication of the structures constitutes psychological explanation of the performance. Both are concerned with characterizing the broad outlines of cognitive structures rather than with detailing the processes involved in

building or using these structures. Only in the experimental analyses of Piagetian tasks do we begin to find attempts to interpret performance more explicitly, that is, in information-processing terms.

Instructability. With respect to the criterion of instructability, Thorndike and Gagné are directly on target. Their aim in task analysis is to facilitate instruction, and the bonds or subordinate capabilities identified are quite clearly described as instructable components. Wertheimer is more difficult to assess with respect to this criterion. His analyses are specific to particular tasks. They do display the basic structure of each task and therefore quite directly suggest ways of teaching that are likely to produce maximum understanding, transfer, and elegance of solution. But there are no general units identified which would be useful across a number of tasks. Piaget's own analyses involve no identification of instructable units. However, a review of studies involving instruction in Piagetian tasks (Glaser & Resnick, 1972) suggests that Piagetian concepts are indeed instructable, or at least lend themselves to analysis into certain prerequisite skills which may be instructable. The studies also suggest how delicate the process of task analysis and instruction is for tasks of any psychological complexity. It is necessary both to identify the appropriate underlying processes or concepts and to find effective ways of teaching them. Identifying one underlying concept will rarely suffice for full success in instructional efforts because there may be several abilities which must be combined, and the absence of any one may lead to failure to learn the target task. Further, "instruction" itself is a very delicate matter. No rules suggest how to construct situations that will convey the concepts or processes to be taught in a clear way. Even with an appropriate task analysis, the mapping from identified components to instructional strategies remains very much a matter of artful development.

Recognition of stages of competence. Finally, we turn to the novice-expert distinction, the criterion of recognition of stages of competence. On

this matter Thorndike is not very explicit. He recognizes a need for sequencing instruction scientifically, but offers no psychological theory as to how to proceed. Indeed, the impression left is that the difference between novices and experts lies solely in how many bonds have been learned and how well practiced these are. That there may be important differences in the organization of knowledge for novices and experts is at best only hinted, and not seriously explored. Gagné's particular contribution within the behavioral perspective is a practical method for generating sequences of instructable tasks. In his general notion of transfer--inclusion of simple tasks in more complex ones--Gagné offers a strong suggestion for how to organize instruction for purposes of acquiring higher-order knowledge and skills. Thus, at a certain level, the criterion of recognizing and dealing with differences between novices and experts is explicitly met in learning hierarchy analyses. Wertheimer's analyses, by contrast, attend not at all to the distinction between novices and experts. The implicit assumption is that behavior in accord with good structural principles is "native" and has simply been stamped out by the drill orientation of schools.

Piaget, of course, is particularly attuned to changes in the structures available at different stages of intellectual development. In fact, with respect to instruction, Piaget's largest contribution is very possibly the identification of substantive changes in competence in the course of development. In Piaget's work it is impossible to ignore differences between performance strategies of novices and experts--whether or not we find his particular analyses convincing or accept his (partially nativist) explanation of how these changes occur. By contrast, the experimental or neo-Piagetian work is uneven on this criterion. For the most part, these studies investigate single tasks and look for competence versus incompetence rather than for stages or transformations of competence. There are a few exceptions, largely in recent attempts to interpret changes in performance on Piagetian tasks in terms of information-processing constructs (see Klahr, in press). Investigators have attempted to analyze sequences

of Piagetian tasks so that adding one or two simple processes to an individual's repertoire, or modification of extant processes, can be shown to account for successively more complex performances on the Piagetian tasks. This work takes "information processing" as its theoretical orientation and makes heavy use of computer simulation strategies for formal analyses. It thus forms a useful bridge to the second part of this paper, which is concerned specifically with the present and potential role of information-processing task analysis in instructional design.

Information-Processing Analyses for Instructional Purposes

A major branch of cognitive psychology today carries the label "information processing." As is often the case with an emerging branch of study, it is easier to point to examples of information-processing research than to give a complete or consensual definition of it. Nevertheless, psychologists working in this area tend to share certain assumptions and research strategies.

Information-processing studies attempt to account for performance on cognitive tasks in terms of actions (internal or external) that take place in a temporally ordered flow. A distinction is generally drawn between data, or information, and operations on data, or processes. Thus, the concern of information-processing psychology is with how humans act upon (process) data (information). Frequently, but not universally, information-processing models for cognitive tasks are expressed as "programs" for performance of particular tasks. These are often formalized as computer programs whose theoretical validity is judged by their ability to simulate actual human performance.

Most information-processing theories and models find it useful to characterize the human mind in terms of the way information is stored, accessed, and operated upon. Distinctions are made among different kinds or "levels" of memory. While the details and labels vary, most theories

distinguish between a sensory intake register of some kind through which information from the environment enters the system, a working memory (sometimes called short-term or intermediate-term memory) in which processing occurs and a long-term (semantic) memory in which everything one knows is stored, probably permanently. Within this general structure, working memory is pivotal. It is only by being processed in working memory that material from the external environment can enter the individual's long-term store of knowledge, and it is only by entering working memory that information from the long-term store can be accessed and used in the course of thinking. Processing in working memory is usually assumed to be serial--one action at a time. Further, working memory is considered to have a limited number of "slots" that can be filled, so that it is only by rehearsing or by "chunking" material into larger units (so that a body of interrelated information takes up a single slot) that loss of information from working memory can be avoided.

Information-processing analyses of instructional tasks share these general assumptions as well as a body of research methods developed for testing the validity of models of cognitive performance. Information-processing analyses are clearly distinguished from behaviorist ones (Thorndike and Gagné in the present case) by their explicit attempts to describe internal processing. They differ from the cognitivist gestalt and Piagetian positions in their attempts to describe the actual flow of performance--to translate "restructuring" or "logical operations" into temporally organized sequences of actions.

In characterizing information-processing analyses of complex tasks, it is useful to distinguish between rational and empirical analyses. Rational analyses are descriptions of "idealized" performances--that is, performances that succeed in responding to task demands, often in highly efficient ways, but not necessarily in the ways in which humans actually perform the tasks. Work in artificial intelligence can be considered a form of rational task analysis which is today being applied to increasingly complex

kinds of tasks. So can some much less ambitious analyses of simple tasks, some of which are discussed below. Empirical task analyses are based on interpretation of the data (errors, latencies, self-reports, eye or hand movements, etc.) from human performance of a task; the aim of such analyses is to develop a description (model) of processes that would account for those data. In practice, rational and empirical analyses are rarely sharply separated. Rational analyses, for example, may provide the starting point for empirical data collection, leading to an iterative process in which successively closer matches to human performance models are made. Nevertheless, the distinction is a useful one in considering the kinds of investment in information-processing analyses that will be most valuable for instruction.

The remainder of this paper considers information-processing analyses of several of these kinds. I describe first some of our work in rational process analysis, work that was explicitly concerned with instructional-design requirements. Next, I describe some empirical analyses of the same kinds of relatively simple tasks, and consider the relation between rational and empirical analysis for instructional purposes. In a final section, I consider the problem of more complex tasks--problem solving, reasoning, tasks that we use as measures of "intelligence" and aptitude--and what the role of formal simulations and empirically studied information process models might be in such domains.

Rational Task Analysis for Curriculum Design

Rational task analysis can be defined as an attempt to specify processes or procedures that would be used in the highly efficient performance of some task. The result is a detailed description of an "idealized" performance--one that solves the problem in minimal moves, does little "backtracking," makes few or no errors. Typically, a rational task analysis is derived from the structure of the subject matter and makes few explicit assumptions about the limitations of human memory capacity or perceptual encoding processes. In many cases, informal rational task analysis of this

kind can serve as a way of prescribing what to teach (i. e., teach children to perform the processes laid out in the analyses), and instructional effectiveness serves as a partial validation of the analysis.

To convey the flavor and intent of rational process analysis as applied to instruction, I will describe in some detail part of our own early work on simple arithmetic tasks. The work initially grew out of an attempt to apply learning hierarchy theory to the problem of designing a preschool and kindergarten mathematics curriculum. We found it necessary, in order to secure agreement among our own staff on the probable ordering of tasks, to introduce a method in which the processes hypothesized to be involved in a particular task performance were explicitly laid out (see Resnick, Wang, & Kaplan, 1973). Figures 4 and 5 show examples of the analyses that resulted. The top box in each figure shows the task being analyzed, the entry above the line describing the presented stimulus and the entry below the line the expected response. The second row in each figure shows a hypothesized sequence of behaviors engaged in as the presented task is performed. Arrows indicate a temporally organized procedure or routine. The lower portions of the charts identify capabilities that are thought to be either necessary to performance (i. e., prerequisite to) or helpful in learning (i. e., propaedeutic to) the main task. The identified prerequisite and propaedeutic tasks were used to build hierarchies of objectives that formed the basis of a curriculum.

At the outset, the process analyses functioned as aids in developing prescriptions for instruction. We carried out the kind of research that seemed most directly relevant to that prescriptive function. That is, we looked at the extent to which the analyses generated valid task sequences, sequences which aided learning of the most complex tasks in the set. Two research strategies were involved. First, we conducted scaling studies. In these studies, tests on a number of tasks were given to a sample of the children prior to instruction, and the results were evaluated for the extent

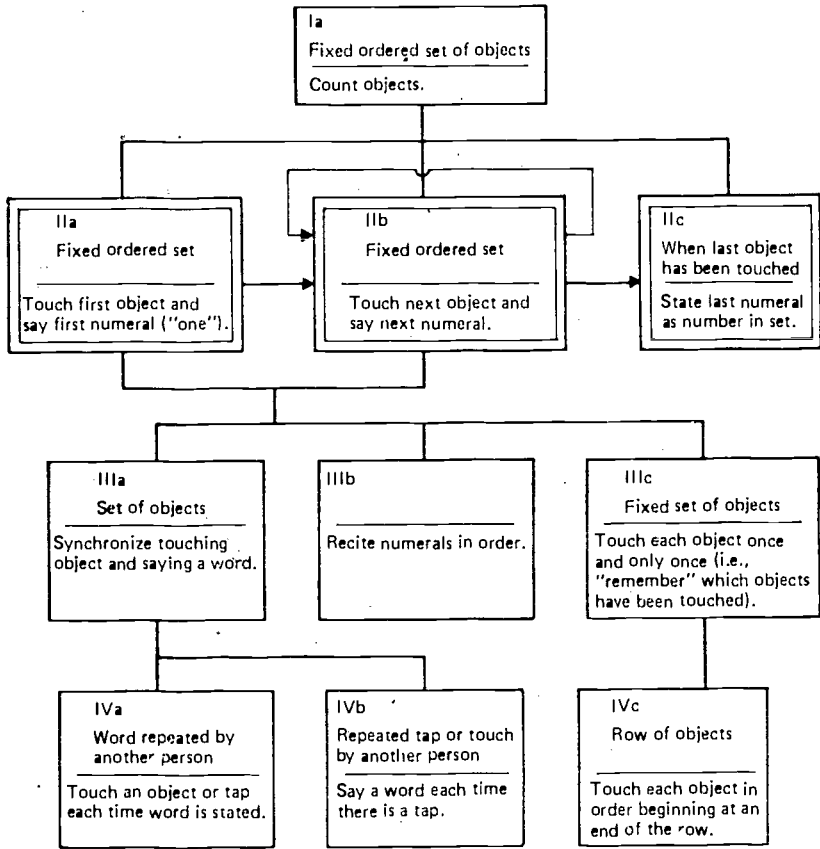

Figure 4. Analysis of Objective 1-2:C, "Given a fixed ordered set of objects, the child can count the objects." (From "Task Analysis in Curriculum Design: A Hierarchically Sequenced Introductory Mathematics Curriculum" by L. B. Resnick, M. C. Wang, and J. Kaplan, *Journal of Applied Behavior Analysis*, 1973, 6, 679-710. Copyright 1973 by the Society for the Experimental Analysis of Behavior, Inc. Reprinted by permission.)

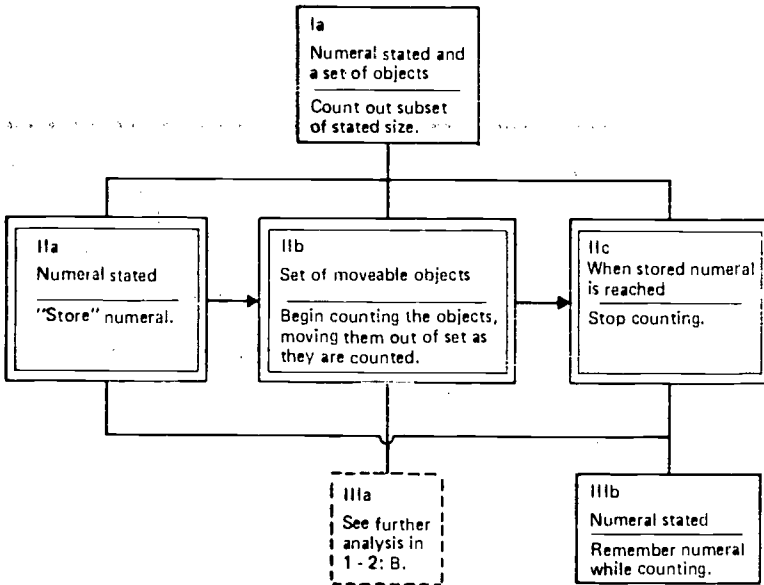

Figure 5. Analysis of Objective 1-2:E, "Given a numeral stated and a set of objects, the child can count out a subset of stated size." (From "Task Analysis in Curriculum Design: A Hierarchically Sequenced Introductory Mathematics Curriculum" by L. B. Resnick, M. C. Wang, and J. Kaplan, *Journal of Applied Behavior Analysis*, 1973, 6, 679-710. Copyright 1973 by the Society for the Experimental Analysis of Behavior, Inc. Reprinted by permission.)

to which the tests formed a Guttman scale in accord with the predicted prerequisite relations (e.g., Wang, 1973; Wang, Resnick, & Boozer, 1971). A good approximation to a Guttman scale implied strong prerequisite relations among the tasks--relations that specified optimal teaching orders. A second set of studies (Caruso & Resnick, 1971; Resnick, Siegel, & Kresh, 1971) involved more direct assessment of transfer relations among small sets of tasks. Tasks in a small hierarchy were taught in simple-to-complex and complex-to-simple orders. We then looked at transfer effects on trials to criterion and related measures. These studies showed that teaching in hierarchical sequence was the best way of assuring that most or all of the children in a group learned all the objectives. For the minority who were capable of learning the more complex objectives without intervening instruction, however, "skipping" of prerequisites was a faster way to learn. What these children apparently did was to acquire the "prerequisites" in the course of learning the most complex tasks. An important instructional question raised by these results is whether we can match instructional strategies to individuals' relative ability to learn on their own--i. e., without going through direct instruction in all of the steps of a hierarchy. Before we are likely to answer that question well, however, we will probably need more systematic theories than are now available of how learning occurs with minimal instruction (see Resnick & Glaser, in press).

The kind of task analysis used in these studies served to describe performance in temporally organized sequences and identify general information-processing abilities, such as perceptual processing (e.g., Figure 4, IIIc and IVc), memory (e.g., Figure 5, IIa and IIb), and temporal synchrony (e.g., Figure 4, IIIa), that are called on in performing a specific complex task. As information-processing models, however, the analyses were incomplete because they did not specify every step (for example, stop rules were not typically specified where recursive loops occurred), nor did they explicitly deal with overall control mechanisms or total memory load. In addition,

they were not empirically verified as process analyses. Although many observations of performance were made, there was no attempt to match predicted or "ideal" performance against actual performances. The hierarchy tests confirmed the validity of the task sequencing decisions made on the basis of the analyses, but they did not necessarily confirm the details of the analyses. Performance strategies different from those in our analyses might have produced similar sequences of acquisition or transfer effects. Thus, while the scaling and transfer studies met instructional needs quite well, they did not constitute validations of the models' details. For this purpose, the strategies of empirical task analysis are needed.

Empirical Analyses of Specific Tasks

What can empirical analyses suggest about teaching specific tasks? An obvious possibility is that we might use process models of competent performance as direct specifications for what to teach. Such models of skilled performance are potentially powerful. However, these alone do not take into account the capabilities of the learner as he or she enters the instructional situation. I want to describe some experiments we have done that suggest a different way of looking at the relation between what is taught and how skilled performance proceeds. The experiments suggest that what we teach children to do and how they perform a relatively short time after instruction are not identical--but neither are they unrelated. They suggest that children seek simplifying procedures that lead them to construct, or "invent," more efficient routines that might be quite difficult to teach directly.

Subtraction. In one study (Woods, Resnick, & Groen, in press) we examined simple subtraction processes (e.g., $5 - 4 = ?$) in second and fourth graders. The method was borrowed from Groen and others' work on simple addition processes (Groen & Parkman, 1972) and open-sentence equations (Groen & Poll, 1973). That is, we gave children a set of subtraction problems and collected response latencies. Five possible models

for performing subtraction problems (of the form $m - n = ?$; with $0 < m \leq 9$, $0 \leq n < 9$) were hypothesized, and predicted response latencies for each problem for each performance model were worked out based on the number of steps that would be required according to the model. Regression analysis was then used to fit observed to predicted latency functions and thus select the model an individual child was using.

Of five models tested, two accounted for the performance of all but a few subjects:

Decrementing Model. Set a counter to m , decrease it n times, then "read" counter. For this model, latencies should rise as a function of the value of n , and the slope of the regression line should reflect the speed of each decrementing operation. This function is shown in Figure 6.

Choice Model. Depending on which has fewer steps, perform either the decrementing routine (previously described) or another in which a counter is set to n and is then incremented until the counter reading matches m . The number of increments is then "read" as the answer. For this model, it is necessary to assume a process of choosing whether to "increment up" or "decrement down." We assume that the choice process takes the same amount of time regardless of the values of m and n . On this assumption, latencies should rise as a function of whichever is smaller, n or $(m - n)$. This function is shown in Figure 7.

Individual data were analyzed first and a best-fit model selected for each child. Then children were grouped according to the model they fit, and the pooled data were analyzed. All fourth graders and most second graders were best fit by the choice model. It seems unlikely that the children had been directly taught the choice model for solving subtraction

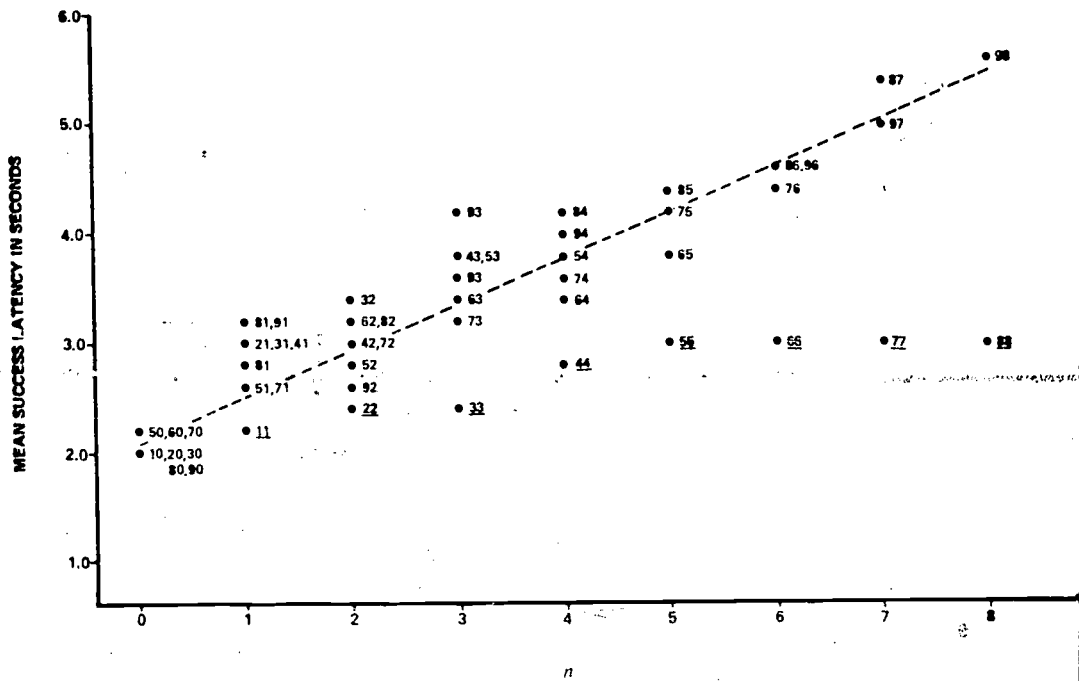

Figure 6. Plot of reaction times for second graders solving subtraction problems of the form $m - n = ?$: Decrementing Model. Numbers beside solid dots denote actual problems (e.g., • 54, 65 signifies that problems 5 - 4 and 6 - 5 both had a mean success latency specified by the •). Underlined problems were omitted in the regression analysis. (From "An Experimental Test of Five Process Models for Subtraction" by S. S. Woods, L. B. Resnick, and G. J. Groen, *Journal of Educational Psychology*, 1975, 67(1), 17-21. Copyright 1975 by the American Psychological Association. Reprinted by permission.)

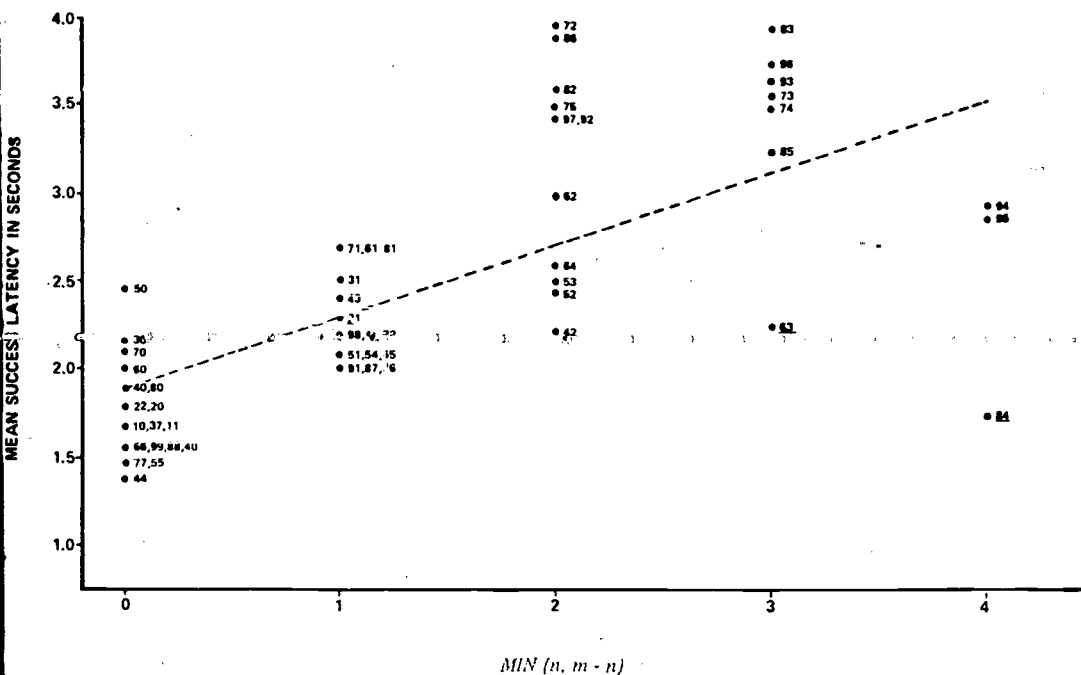

Figure 7. Plot of reaction times for second graders solving subtraction problems: Choice Model. $MIN(n, m - n)$ reads "the smaller of n and $(m - n)$." (From "An Experimental Test of Five Process Models for Subtraction" by S. S. Woods, L. B. Resnick, and G. J. Groen, *Journal of Educational Psychology*, 1975, 67(1), 17-21. Copyright 1975 by the American Psychological Association. Reprinted by permission.)

problems during their arithmetic training. The procedure would be difficult to communicate to 6- and 7-year-olds, and might confuse rather than enlighten children at their first exposure to subtraction. Most probably, the children had been taught initially to construct the m set (increment the counter m times), count out the n set (decrement n times), and then count ("read-out") the remainder. This algorithm is close to the one described as the decrementing model. The decrementing model is in fact derivable from the algorithm we assume is typically taught by simply dropping the steps of constructing the m set and counting the remainder. Thus, it seems reasonable that a child would develop the decrementing model quite quickly. The choice model, however, cannot be derived from the teaching algorithm in so direct a way. Instead, an invention (the possibility of counting up from n) must be made. This invention is probably based on observation of the relations between numbers in addition and subtraction over a large number of instances. Yet the invention appears to have been made as early as the end of second grade by most of the children.

Addition. In another study, Guy Groen and I are looking more directly at the relation between the algorithm taught and later performance. In the subtraction study we could only guess at what children had been taught, based on our general knowledge of elementary school practice. In the addition study, we controlled the teaching by doing it ourselves. We taught 4-year-olds to solve single-digit addition problems of the form $m + n = ?$ (where m and n ranged from 0 to 5) by using the following algorithm: (a) count out m blocks, (b) count out n blocks, (c) combine the subsets, and (d) count the combined set. We then kept the children coming back for about two practice sessions a week for many weeks. As soon as each child was performing the addition process smoothly using blocks, we took the blocks away and asked the children to give their answers on a device that allowed us to collect latency data. The children's typical response when blocks were removed was to begin counting out sets on their fingers. Eventually, however, most shifted to internal processing.

Suppes and Groen (1967) had earlier shown that by the end of the first grade, most children added using a choice-type model in which they set a counter to m or n , whichever was larger, and then incremented by the smaller of the two numbers. This is known as the min (minimum) model (because the latencies fit min [m, n]). A few children used a model of incrementing m times, then incrementing n more times, and then reading the counter. This is known as the sum model (latencies fit [$m + n$]). The sum model can be derived from the procedure we taught by simply dropping steps (c) and (d) of our algorithm, and it requires no choice. The min model, however, requires an invention based on the recognition that sums are the same regardless of the order in which numbers are added and that it is faster to increment by the smaller quantity.

For five of the six children whose data have been analyzed thus far, it is clear that by the final two test sessions the min model gave significant and "best" fit. In general, the trend over blocks of trials was for subjects' data to be fit well by the min model as soon as they stopped counting overtly on most of the trials. It is as if these children discovered commutativity as soon as they were confident enough to stop counting on their fingers. In these studies, children are taught one routine derived from the subject matter. After some practice--but no direct instruction--they perform a different and more efficient routine. The efficiency is a result of fewer steps (not, apparently, faster performance of component operations), which in turn requires a choice or decision on the part of the child. A strictly algorithmic routine, in other words, is converted into another routine which turns out to solve the presented problem more efficiently.

Wallace (Note 1) has reported a similar finding in a study of information-processing models of class inclusion. After training in the prerequisite skills as hypothesized on the basis of an information-processing analysis, subjects were presented a typical class inclusion task in which they were asked to tell, for example, "Which is more, the red ones or the triangles?" They

had been taught to pass through the object array twice, each time quantifying the objects on one of the different value dimensions named and then comparing them to determine which was more. At the posttest administered immediately after training, some of the children were able to perform more efficiently by quantifying on the first pass objects having only one of the dimensions named by the experimenter. For example, Wallace presented a subject with eight triangles, seven of which were red and one green. Asked "Which is more, the red ones or the triangles?", one subject answered, "There's one green triangle and that makes it more triangles" (Wallace, Note 1). Because the set having only one of the named dimensions in the class inclusion task is usually the minor subset, this procedure quickly yields the answer. It seems likely that a phenomenon of this kind, that is, the transformation of algorithms by the learner, is more general than we have thought up to now. At least some process data that appear difficult to interpret when averaged over time may show interpretable regularity when early and later phases of performance are examined separately.

Implications for instruction. What are the implications of findings of this kind for instruction? On the face of it, it would seem that we ought to abandon the algorithmic routines suggested by rational task analysis in favor of directly teaching the more environmentally responsive processes that appear to characterize even semi-skilled performance. We ought, in other words, to conclude that the initial rational analyses are wrong because they do not match skilled performance, and that therefore they should not be used in instruction. Rather, we should perform detailed empirical analyses of skilled performance on all of the tasks that a curriculum comprises, and teach directly the routines uncovered in the course of such analyses.

Such a conclusion, I believe, would be mistaken. It rests on the assumption that efficient instruction is necessarily direct instruction in

skilled performance strategies, rather than instruction in routines that put learners in a good position to discover or invent efficient strategies for themselves. That is what the children did in the studies just reported. They learned a routine but then invented a more efficient performance for themselves. It seems reasonable to suppose--although empirical tests comparing different instructional strategies are needed to draw a strong conclusion--that the teaching routines were good ones, because they taught the specific skills in a way that called upon children's discovery and invention abilities.

Task Structure, Skilled Performance, and Teaching Routines

To put the case in its most general form, it would seem useful to think in terms of a "triangulation" between the structure of a task as defined by the subject matter, the performance of skilled individuals on a task, and a teaching or acquisition routine that helps novices learn the task. There are three terms in this conceptualization; all three must stand in strong relation to each of the others--thus the image of triangulation. These relations are schematized in Figure 8. Most empirical information-processing analyses have been concerned with the relations between the elements defining the base of the triangle--that is, with the relations between the structure of the subject matter, or "task environment" (A), and performance (C). Thus, most information-processing task analyses are state theories, describing performance on a given kind of task at a given point in learning or development, but not attempting to account for acquisition of the performance. The rational process analyses that we have developed in the course of our instructional work have been concerned primarily with the structure of the task (A) and an idealized routine that represents the subject matter well and thus prescribes a good teaching routine (B). Our validation studies have in effect been tests of the extent to which the teaching routines and sequences derived through these analyses succeeded in conveying the subject

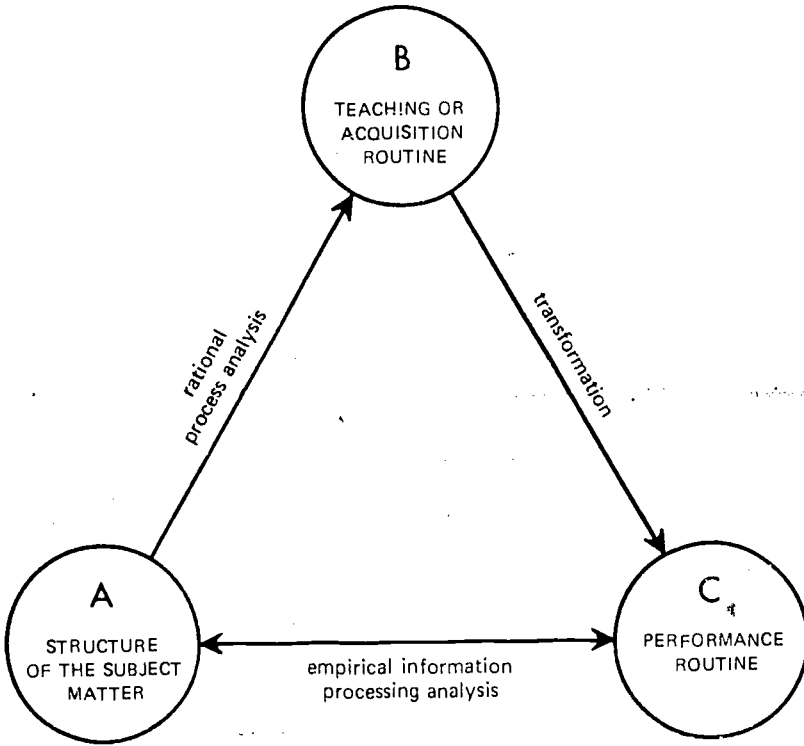

Figure 8. Relations between teaching routines, performance routines, and structure of subject matter.

matter to learners. The preceding discussion has concerned the relation between teaching routines (B) and performance routines (C). Gaining understanding of the "transformation" processes that link these two routines is necessary to complete the triangulation that clearly relates information-processing models to instructional design.

According to this "triangulation," there are three criteria to be met in choosing a teaching routine:

1. It must adequately display the underlying structure of the subject matter.
2. It must be easy to demonstrate or teach.
3. It must be capable of transformation into an efficient performance routine.

The teaching routine, then, is designed to help facilitate acquisition. It provides the connecting link between the structure of the subject matter and skilled performance--which is often so elliptical as to obscure rather than reveal the basic structure of the task.

Teaching routines, in other words, are constructed specifically to aid acquisition. The design of teaching routines may require considerable artistry, and not all routines will be successful in meeting the criteria just laid out. Let us consider some examples. To begin with our own work, the addition routine Groen and I taught is an instance of the "union of sets" definition of addition. Thus, it is a mathematically "correct" procedure and represents the subject-matter structure clearly. The routine is also easy to demonstrate and to learn. Our 4-year-old subjects (who knew only how to count objects when they began the experiment) were performing addition virtually perfectly, using the blocks, after about a half hour of practice. The routine we taught is awkward and slow to perform, however, None of us would like to have to use it in our daily activities, and neither apparently did the 4-year-olds. Nevertheless, the data show that the routine is

transformable--by a series of steps we can imagine but cannot for the moment document empirically--to the more efficient performance routine of the min model. Further, this performance routine exemplifies another aspect of the subject-matter structure, commutativity. Thus, the proposed triangulation is completed. A teaching routine derived by rational process analysis of the subject-matter structure is transformed to a performance routine that reflects an even more sophisticated definition of the subject matter.

The case is similar for the subtraction study. The routine that we presume was taught exemplified a partitioning-of-sets definition of subtraction. The performance routine derived by the children is not only more efficient; it also reflects a more sophisticated aspect of the subject-matter structure, namely the complementary relation between addition and subtraction operations.

Not all teaching routines meet the criteria enumerated above. Some are awkward to teach; such would be the case, for example, were one to undertake to teach 4-year-olds the min model for addition. Others fail to display the subject-matter structure in a way that is transparent to children. This is true, for example, in the case of traditional algorithmic methods of teaching carrying and borrowing that do not display the underlying structure (base arithmetic and its notation) from which the routines are derived.

Sometimes instructional routines are developed in order to display the subject-matter structure but do not meet the transformability criterion--that is, they are not easily mapped onto a performance routine that is efficient and direct. An example of a performance routine that fails on the criterion of transformability is one that was proposed by Bruner (1964) for teaching factoring of quadratic expressions. Bruner was successful in teaching third graders to perform the factoring operation by creating a "model" of the expression using blocks. As shown in Figure 9 (a), the large square is x units long and x wide, thus (x^2) . The rod is x units

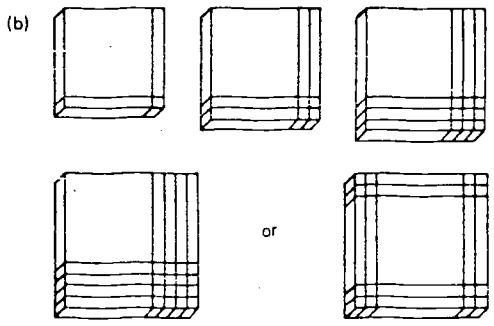
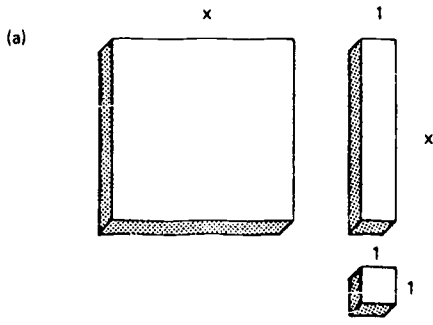

Figure 9. (a) Three components for quadratic construction. (b) Squares of ever increasing size constructed with components. (From "Some Theorems of Instruction Illustrated with Reference to Mathematics" by J. S. Bruner, in E. R. Hilgard (Ed.), *Theories of Learning and Instruction, The 63rd Yearbook of the NSSE* (Part 1). Chicago: University of Chicago Press, 1964. Copyright 1964 by the National Society for the Study of Education. Reprinted by permission.)

long and one unit wide, thus (x) . The small cube is 1×1 , thus (1) . As shown at the right of the figure (b), children can arrange these three elements in squares which will have equal factors--e.g., $(x + 1)(x + 1)$; $(x + 2)(x + 2)$ --and which can also be expressed as quadratics--e.g., $(x^2 + 2x + 1)$; $(x^2 + 4x + 4)$. Allowing children to manipulate the blocks may be excellent for displaying and promoting insight into the structure of the subject matter, but there appears to be no way to transform the square-arrangement routine to a factoring procedure used without the blocks.

Certain other teaching routines in early mathematics do meet the transformability criterion while still representing the mathematical structure. For example, measurement can be taught as a process of dividing into equal units. Wertheimer (1945/1959) did this when he used division of a figure into squares as means of finding its area. Bearison (1969), in a less widely known experiment, induced a generalized conservation concept by showing children how to count the number of 30-milliliter beakers of liquid that were poured into beakers of different sizes, and demonstrating the principle of conservation by pouring equal quantities of liquid into containers of different shapes. This generalized principle of measurement, exemplified in the liquid measurement procedure taught, produced conservation responses in tests of number, mass, length, and continuous and discontinuous area and quantity that lasted for at least six months. Similarly, the number base system (including carrying and borrowing) can be taught using blocks in sizes of one, ten, and one hundred, placed in units, tens, and hundreds columns, as in Figure 10 (cf. Dienes, 1966, 1967). With these blocks, carrying can be represented by trading or exchanging extra (i. e., more than nine) blocks in a column for a larger block that is placed in the next column. Such an exchange would be necessary for the bottom display in Figure 10 before the block display could be notated. A reverse exchange operation can be used to represent subtraction. In each of these cases, as the physical representation is dropped, a performance routine

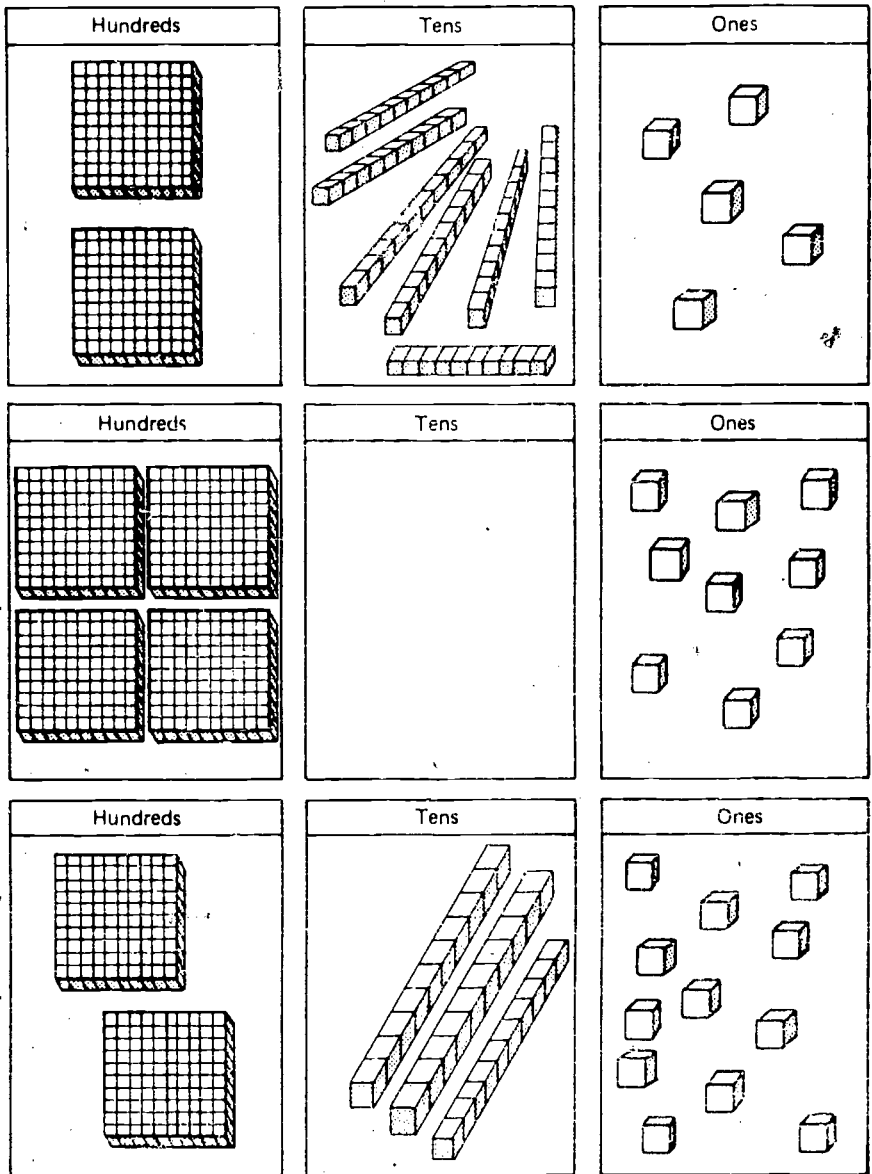

Figure 10. Block displays for notation problem. (From "Problem Solving and Intelligence" by L. B. Resnick and R. Glaser, in L. B. Resnick (Ed.), *The Nature of Intelligence*. Hillsdale, N. J.: Lawrence Erlbaum Associates, in press.)

can be constructed which initially performs "as if" the representation were present, and then gradually becomes more abstracted from it. This is the kind of thing we believe occurred in our addition teaching experiment.

The general suggestion that I would like to draw from these observations is that most people--even quite young children--use environmental feedback to simplify performance routines. They do not accept the routines they are shown as "givens" but rather as starting points. They invent even when we teach them algorithms. One implication is that the traditional line between algorithmic and inventive teaching disappears. We are not faced so much with a choice between teaching by rules and teaching by discovery, as with a problem of finding teaching rules that will enhance the probability of discovery--rules that somehow invite simplification or combination with other rules. This way of thinking also draws attention to the extent to which we presently depend, in our normal instructional practices, on this kind of invention and discovery by learners. Our instruction is rarely complete, and rather than taking care to point out the simplifying and organizing principles that underlie what we teach, we often not only choose less than elegant instances but also expect learners to find the underlying principles for themselves. This suggests that differences in learning ability--often expressed as intelligence or aptitude--may in fact be differences in the amount of support individuals require in making the simplifying and organizing inventions that produce skilled performance. Some individuals will seek and find order in the most disordered presentations; most will do well if the presentations (i. e., the teaching routines) are good representations of underlying structures; still others may need explicit help in finding efficient strategies for performance.

Analyzing and Teaching Generalized "Learning-to-Learn" Abilities

People apparently invent even within the confines of algorithmic instruction of particular tasks. Nevertheless, as just suggested, individuals

differ substantially in how good they are at these inventions. Thus, one appropriate concern for instruction is the possibility of teaching general strategies for invention and discovery--strategies that will help learners to be less dependent on the instructor's elegance in presenting particular tasks. An interest in teaching such general "learning-to-learn" abilities, as they are often called, has been widely expressed by educators and psychologists. But few successes have been reported, and there is little scientific basis at the present time for such instruction. As in the instruction of any other ability, the first step in teaching general learning abilities is developing a psychological description--a task analysis--of the competence sought. Such analyses are only now beginning to become available.

A growing number of information-processing analyses of problem-solving tasks of various kinds provide a potential basis for instruction. However, it is by no means evident, without further testing and experimentation, that analysis of skilled performance on complex problems can be directly translated into instructional interventions. One test of this possibility has been carried out recently by Thomas Holzman (1975). In an effort to determine the instructability of a generalized pattern detection skill, Holzman looked at an analysis of behavior on series completion tasks that had been carried out earlier by Kotovsky and Simon (1973). The Kotovsky and Simon analysis identified three principal subroutines for discovering the pattern in letter-series completion tasks similar to those used on many intelligence tests. These were: (a) detecting the "period" of the pattern--i. e., the repeating units of a certain number of letters, such as three in the pattern abmcdmefm . . . or four in the pattern defgefghfg . . .; (b) determining the rule that generates each symbol in the period; and (c) testing the inferred rule to see if it holds for all the letters that have been presented. These subroutines in turn were shown to be dependent upon recognizing three basic relations between items in the series presented: identity (e. g., f to f); next in the alphabet (e. g., f to g); or backward next (e. g., h to g). These three

relations exhaust those that were used in the Thurstone letter-series completion task (Thorndike & Thurstone, 1941) which the Kotovsky and Simon study used as a basis, although a much more extended and complex list of relations could of course be used in generating series completion problems.

Based on the Kotovsky and Simon analysis, Holzman taught children from first through sixth grade the strategies for recognizing the three basic relations and for finding periods. Instruction in finding periods was done in such a way as to prevent extrapolation to other subroutines. Children trained in these relations and periodicity subroutines improved significantly on the letter-series completion task from pre- to posttest. They also improved significantly more than control children who simply took the pre- and posttest and did not practice the series completion task. Comparisons of particular types of errors for the training and control groups showed that the trained children improved significantly more than the controls where there were more difficult relations (e.g., next as opposed to identity) and on the generally more difficult problems. Control children showed a practice effect, due to experience with the test itself, which was limited largely to improvement on the most easily detectable relation (i.e., identity). This study suggests that as information-processing analyses succeed in identifying the processes underlying problem solution, these processes--at least some of them--can be directly taught, and that individuals will then be able to apply them to solving relatively large classes of problems.

What possibilities exist for analyses of problem-solving abilities that are even more general than those Holzman found, and what might these yield as a basis for instruction that would truly generate learning-to-learn abilities? Robert Glaser and I have considered this question in another paper (Resnick & Glaser, in press) in which we describe several studies of invention behavior in mathematics and related tasks. We argue there that the processes involved in problem solving of certain kinds are probably the same ones involved in learning in the absence of direct or complete

instruction, and that instruction in those processes may constitute a means of increasing an individual's intelligence.

We have developed a model of problem solving in which three interacting phases are identified: (a) problem detection, in which the inapplicability of "usual routines" is noted and a problem or goal formulated; (b) feature scanning, in which the task environment (the external situation, which includes both physical and social features) is scanned for cues to appropriate responses; and (c) goal analysis, in which goals are successively reformulated, partly on the basis of external task cues, in order to yield soluble subgoals that contribute eventually to solution of the task as presented. A study by Pellegrino and Schadler (Note 2) has shown that requiring the subject to verbalize the goals of the problem and his or her strategies for solving it before making overt moves toward solution greatly enhances the likelihood of invention. Along similar lines, it seems likely that ways can be found to make individuals more conscious of the role of environmental cues in problem solving. Strategies of feature scanning and analysis may perhaps be taught that will enhance the likelihood of their noticing cues that prompt effective actions, while recognizing and somehow "deactivating" those that prompt ineffective actions. Extending this general argument of self-regulation as a major characteristic of successful learning and problem solving, Resnick and Beck (in press) have suggested that a similar form of instruction in self-questioning and self-monitoring strategies might be an effective way of enhancing reading comprehension abilities.

The specific suggestions that can now be offered for instruction of generalized learning abilities are limited, because relatively little work has been done thus far on developing task analyses that characterize these general processes in instructable terms. Rational analysis seems less likely to yield good suggestions for generalized abilities than for specific tasks; thus empirical task analyses seem to be called for. Further, the rigor of formal models seems especially important where the processes

are little understood and the task environments loosely structured, as is often the case where problem solving and discovery are called for. Thus, with respect to this most important goal of instruction, it will probably be necessary to engage in the most costly and extended forms of task analysis, that is, those that are formally stated and empirically validated. To the extent that the analyses identify instructable processes, instructional experiments can serve as one of the major forms of empirical validation of the performance models proposed. A mutual interaction between scientific and instructional concerns can thus be envisaged. With respect to these general abilities in learning, thinking, and problem solving, information-processing analysis may have the most to offer to instruction, just as instructional efforts may have the most to offer to psychological knowledge.

Reference Notes

1. Wallace, J. G. The adaptation of instruction to individual differences: An information-processing approach. Paper presented at the meeting of the American Psychological Association, Honolulu, September 1972.
2. Pellegrino, J. W., & Schadler, M. Maximizing performance in a problem solving task. Unpublished manuscript, University of Pittsburgh, Learning Research and Development Center, 1974.

References

- Bearison, D. J. The role of measurement operations in the acquisition of conservation. Developmental Psychology, 1969, 1, 653-660.
- Brownell, W. R., & Stretch, L. B. The effect of unfamiliar settings on problem solving. Durham, N. C.: Duke University Research Studies in Education, 1931. (No. 1)
- Bruner, J. S. Some theorems on instruction illustrated with reference to mathematics. The Sixty-third Yearbook of the National Society for the Study of Education (Pt. 1), 1964, 63, 306-335.
- Caruso, J. L., & Resnick, L. B. Task sequence and overtraining in children's learning and transfer of double classification skills. Pittsburgh: University of Pittsburgh, Learning Research and Development Center, 1971. (LRDC Publication 1971/18).
- Dienes, Z. P. Mathematics in the primary school. New York: St. Martin's Press, 1966.
- Dienes, Z. P. Building up mathematics. London: Hutchinson Educational Press, 1967.
- Furth, H. G. Piaget for teachers. Englewood Cliffs, N. J.: Prentice-Hall, 1970.
- Gagné, R. M. The acquisition of knowledge. Psychological Review, 1962, 69, 355-365.
- Gagné, R. M. Learning hierarchies. Educational Psychology, 1968, 6, 1-9.
- Gagné, R. M. The conditions of learning (2nd ed.). New York: Holt, Rinehart, & Winston, 1970.
- Gagné, R. M., Mayor, J. R., Garstens, H. L., & Paradise, N. E. Factors in acquiring knowledge of a mathematical task. Psychological Monographs, 1962, 76(7, Whole No. 526).
- Gelman, R. Conservation acquisition: A problem of learning to attend to relevant attributes. Journal of Experimental Child Psychology, 1969, 7, 167-187.

- Glaser, R., & Resnick, L. B. Instructional psychology. Annual Review of Psychology, 1972, 23, 207-276.
- Groen, G. J., & Parkman, J. M. A chronometric analysis of simple addition. Psychological Review, 1972, 79, 329-343.
- Groen, G. J., & Poll, M. Subtraction and the solution of open-sentence problems. Journal of Experimental Child Psychology, 1973, 16, 292-302.
- Holzman, T. G. Process training as a test of computer simulation theory. Unpublished master's thesis, University of Pittsburgh, 1975.
- Hyde, L. L., & Clapp, F. L. Elements of difficulty in the interpretation of concrete problems in arithmetic. Bureau of Educational Research Bulletin No. 9. Madison: University of Wisconsin, 1927.
- Kamii, C. An application of Piaget's theory to the conceptualization of a preschool curriculum. In R. K. Parker (Ed.), The preschool in action: Explaining early childhood programs. Boston: Allyn & Bacon, 1972.
- Katona, G. Organizing and memorizing. New York: Columbia University Press, 1940.
- Klahr, D. Steps toward the simulation of intellectual development. In L. B. Resnick (Ed.), The nature of intelligence. Hillsdale, N. J.: Lawrence Erlbaum Associates, in press.
- Kohlberg, L. Early education: A cognitive-developmental view. Child Development, 1968, 39, 1013-1062.
- Kotovsky, K., & Simon, H. A. Empirical tests of a theory of human acquisition of concepts for sequential patterns. Cognitive Psychology, 1973, 4, 399-424.
- Luchins, A. S., & Luchins, E. H. Wertheimer's seminars revisited: Problem solving and thinking. Albany: Faculty-Student Association, State University of New York, 1970.
- Neimark, E. D. Development of formal operations thinking. In F. D. Horowitz (Ed.), Review of child development research (Vol. 4). Chicago: University of Chicago Press, 1975.
- Piaget, J. Science of education and the psychology of the child. New York: Grossman Publishers, 1970.

- Piaget, J. Structuralism. New York: Harper & Row, Harper Torchbooks, 1970.
- Resnick, L. B., & Beck, I. L. Designing instruction in reading: Interaction of theory and practice. In J. T. Guthrie (Ed.), Aspects of reading acquisition. Baltimore, Md.: Johns Hopkins University Press, in press.
- Resnick, L. B., & Glaser, R. Problem solving and intelligence. In L. B. Resnick (Ed.), The nature of intelligence. Hillsdale, N. J.: Lawrence Erlbaum Associations, in press.
- Resnick, L. B., Siegel, A. W., & Kresh, E. Transfer and sequence in learning double classification skills. Journal of Experimental Child Psychology, 1971, 11, 139-149.
- Resnick, L. B., Wang, M. C., & Kaplan, J. Task analysis in curriculum design: A hierarchically sequenced introductory mathematics curriculum. Journal of Applied Behavior Analysis, 1973, 6, 679-710.
- Rohwer, W. D. Prime time for education: Early childhood or adolescence? Harvard Educational Review, 1971, 41, 316-341.
- Skinner, B. F. Science and human behavior. New York: Macmillan, 1953.
- Smedslund, J. Concrete reasoning: A study of intellectual development. Monographs of the Society for Research in Child Development, 1964, 29(2, No. 93), 1-39.
- Smedslund, J. Determinants of performance on double classification tasks. I. Effects of covered vs. uncovered materials, labeling vs. perceptual matching, and age. Scandinavian Journal of Psychology, 1967, 8, 88-96. (a)
- Smedslund, J. Determinants of performance on double classification tasks. II. Effects of direct perception and of words with specific, general, and no reference. Scandinavian Journal of Psychology, 1967, 8, 97-101. (b)
- Suppes, P., & Groen, G. Some counting models for first-grade performance data on simple addition facts. In J. M. Scandura (Ed.), Research in mathematics education. Washington, D. C.: National Council of Teachers of Mathematics, 1967.
- Thorndike, E. L. The psychology of arithmetic. New York, Macmillan, 1924.

- Thorndike, E. L., & Thurstone, T. G. Factorial studies of intelligence. Chicago: University of Chicago Press, 1941.
- Wang, M. C. Psychometric studies in the validation of an early learning curriculum. Child Development, 1973, 44, 54-60.
- Wang, M. C., Resnick, L. B., & Boozer, R. F. The sequence of development of some early mathematics behaviors. Child Development, 1971, 42, 1767-1778.
- Wertheimer, M. Productive thinking (Enlarged ed.). New York: Harper & Row, 1959. (Originally published in 1945.)
- White, R. W. Learning hierarchies. Review of Educational Research, 1973, 43, 361-375.
- Woods, S. S., Resnick, L. B., & Groen, G. J. An experimental test of five process models for subtraction. Journal of Educational Psychology, in press.