

| Program Record | |
|---|-------------------------------|
| Record #: 19006 | Date: October 31, 2019 |
| Title: Hydrogen Class 8 Long Haul Truck Targets | |
| Originator: Jason Marcinkoski | |
| Reviewed by: Fuel Cell Technologies and Vehicle Technologies Offices; Members of the 21 st Century Truck Partnership; Strategic Analysis, Inc.; Argonne National Laboratory; Hydrogen Truck, Truck Component Suppliers, and Freight Industry Stakeholders; North American Council for Freight Efficiency; and Deputy Assistant Secretary for Transportation, EERE | |
| Approved by: Sunita Satyapal and David Howell | Date: 12/12/2019 |



DOE Advanced Truck Technologies Subsection of the Electrified Powertrain Roadmap Technical Targets for Hydrogen-Fueled Long-Haul Tractor-Trailer Trucks 10/31/2019

Jason Marcinkoski,¹ Ram Vijayagopal,² Jesse Adams,¹ Brian James,³ John Kopasz,² Rajesh Ahluwalia²

1 DOE Technical Targets for Advanced Truck Technologies

A key activity within DOE’s Office of Transportation within Energy Efficiency and Renewable Energy (EERE) is setting technology targets for achieving performance, durability, and cost required to be competitive with incumbent or other advanced technologies. These targets guide early stage research and development (R&D) and serve as benchmarks for tracking technology. As electrified powertrains are becoming an important part of the advanced truck technology portfolio, DOE is setting detailed technical targets for both hydrogen-fueled fuel cell-powered trucks and battery electric trucks.

Technical targets for advanced truck technologies are developed with input from the 21st Century Truck Partnership (21CTP) and will be included in new Electrified Powertrain Roadmaps to provide the technical foundation for research priorities, addressing one of four key research areas covered under 21CTP. This document presents the technical targets for Class 8 long-haul tractor-trailer trucks powered by hydrogen and fuel cells. Targets for battery electric tractor-trailer trucks will also be added to the Electrified Powertrain Roadmap. These hydrogen targets were developed for the long-haul use case, assuming trucks can be driven the maximum daily range (750 miles) between refueling. Other use cases will be considered for battery powered

¹ U.S. Department of Energy (DOE)

² Argonne National Laboratory

³ Strategic Analysis, Inc.

trucks that can be driven for 250 to 500 miles between charging events, where charging opportunities may exist at hubs, delivery points, or destinations. Future updates will take into account technological progress, additional analysis, and stakeholder feedback. The DOE offices within EERE's Transportation sector plan to expand these targets to include vocational and regional haul use cases within the class 4 to 8 range for various electrified and combustion-based powertrains.

A number of stakeholders including industry experts and the 21CTP partners provided feedback during the target setting process. These targets were arrived at with industry input obtained through a Request for Information (RFI) and workshop feedback from relevant stakeholders on draft targets at the DOE H2@Scale⁴ End Use Applications: Fuel Cell Truck Powertrain R&D Activities and Target Review Workshop (DOE Fuel Cell Truck Powertrain Workshop)⁵ held in July 2018. Overall comments from the workshop stressed that the ultimate targets must be set such that fuel cell technologies can be cost competitive with incumbent technology and meet the required vehicle performance metrics.

2 DOE Advanced Truck Technologies

The Department of Energy (DOE) focuses on research and development (R&D) on a wide portfolio of transportation technologies such as advanced combustion, biofuels, battery electric vehicles, and fuel cell electric vehicles to support greater fuel economy, freight efficiency, and reduced emissions.

DOE and industry co-lead the 21CTP to share information and coordinate efforts to advance commercially viable technology between the truck industry and government entities. The 21CTP includes the U.S. Department of Energy Vehicle Technologies Office, Fuel Cell Technologies Office; National Laboratories; industry; U.S. Army Ground Vehicle Systems Center (GVSC); and Department of Transportation (DOT) National Highway Traffic Safety, Federal Motor Carrier Safety, and Federal Highway Administrations (NHTSA, FMCSA, FHWA). The 21CTP aims to foster technological innovation in improving the energy efficiency and reducing the costs of the nation's economically vital truck freight transportation system. The Partnership is developing new roadmap documents with additional details to provide the technical foundation for research priorities. These targets will become part of the 21CTP Electrified Powertrain Roadmap, one of four key research areas covered under the 21CTP.

The SuperTruck I program, which was launched by DOE in 2010 to improve heavy-duty freight efficiency by 50%, focused on internal combustion engine (ICE) technology as well as

⁴ H2@Scale is a concept that explores the potential for wide-scale hydrogen production and utilization in the United States to enable resiliency of the power generation and transmission sectors, while also aligning diverse multibillion dollar domestic industries, domestic competitiveness, and job creation.

⁵ H2@Scale End Use Applications: Fuel Cell Truck Powertrain R&D Activities and Target Review Workshop, Chicago, IL, July 30–31, 2018. <https://www.energy.gov/eere/fuelcells/fuel-cell-truck-powertrain-rd-activities-and-target-review-workshop-h2-scale-end-use>

aerodynamics, and led to more than 20 fuel saving technologies that have reached the commercial market. SuperTruck II builds on the successful SuperTruck I program. In 2016, DOE funded the SuperTruck II program (\$100M) to develop and demonstrate cost-effective technologies that more than double the freight efficiency of Class 8 trucks compared to a 2009 baseline, and achieve 55% or greater engine brake thermal efficiency (demonstrated on a dynamometer at 65 mph).

2.1 Background on the Domestic Truck Market

The domestic market for Class 8 trucks is large and growing. Figures 1 and 2 below show annual truck sales approaching 250,000 units per year (2015, 2017, and 2018), and sustained growth for Classes 4 to 7 trucks approaching 240,000 trucks per year in 2018.⁶ The long-haul use case is important as 40% of trucks travel between 250 and 750 average miles per workday (261 days per year), covering 70% of tractor trailer mileage (based on Vehicle Inventory and Use Survey⁷ [VIUS] annual miles traveled, see vehicle range assumption section below).

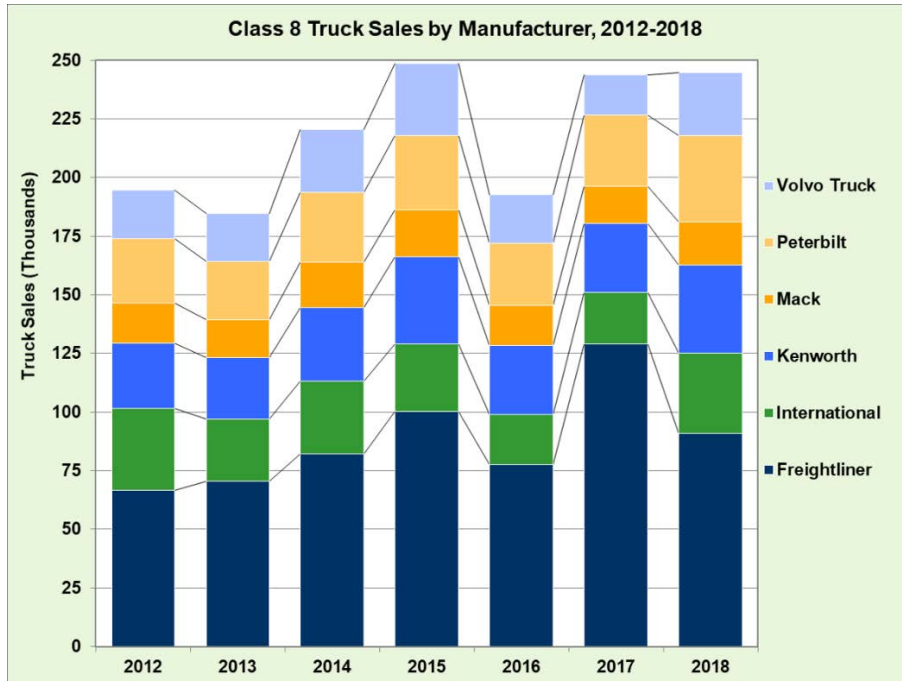

Figure 1. Class 8 truck sales by manufacturer, 2012–2018

⁶ 2016 Vehicle Technologies Market Report, Oak Ridge National Laboratory, <http://cta.ornl.gov/vtmarketreport/index.shtml>, updated for 2018

⁷ 2002 Vehicle Inventory and Use Survey (VIUS): <https://www.census.gov/prod/ec02/ec02tv-us.pdf>

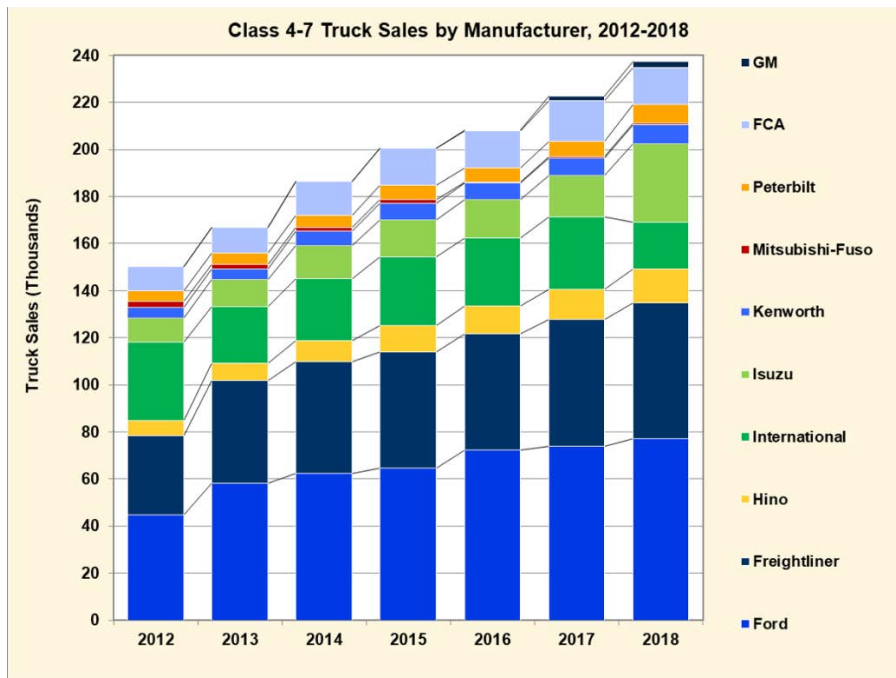

Figure 2. Class 4–7 truck sales by manufacturer, 2012–2018

2.2 Role of Hydrogen and Fuel Cell Technologies

Fuel cell technology is part of a portfolio of options for the advancement of zero emission vehicles (ZEV). In particular, fuel cells powered by hydrogen (H₂) are emerging as an attractive technology platform for larger weight classes such as medium-duty and heavy-duty vehicles. Hydrogen can offer high gravimetric energy storage density and fast refueling/recharging times, enabling longer driving range and higher vehicle utilization factors. The high energy storage density offered by these hydrogen fuel cell-powered vehicles provides sufficient vehicle range to meet at least 95% of the daily routes based on preliminary analysis of data collected from U.S. Census survey results and real-world drive cycle data collection.⁸ Additionally, overnight hotel loads can use clean and efficient power produced from the same fuel cell used for primary traction power in conjunction with the powertrain’s hybrid battery storage, eliminating the need for auxiliary power generation.

While several vocational uses may be assessed, this document focuses on Class 8 long-haul tractor trailers.

⁸ Vehicle Inventory and Use Survey (VIUS): <https://www.census.gov/prod/ec02/ec02tv-us.pdf>

3 Target Tables for Hydrogen Fueled Long-Haul Trucks

Table 1. Technical System Targets: Class 8 Long-Haul Tractor-Trailers (updated 10/31/19)

| Characteristic | Units | Targets for Class 8 Tractor-Trailers | |
|--|---|--------------------------------------|--------------------------|
| | | Interim (2030) | Ultimate ⁹ |
| Fuel Cell System Lifetime ^{1,2} | hours | 25,000 | 30,000 |
| Fuel Cell System Cost ^{1,3,4} | \$/kW | 80 | 60 |
| Fuel Cell Efficiency (peak) | % | 68 | 72 |
| Hydrogen Fill Rate | kg H ₂ /min | 8 | 10 |
| Storage System Cycle Life ⁵ | cycles | 5,000 | 5,000 |
| Pressurized Storage System Cycle Life ⁶ | cycles | 11,000 | 11,000 |
| Hydrogen Storage System Cost ^{4,7,8} | \$/kWh (\$/kg H ₂ stored) | 9 (300) | 8 (266) |

- ¹ The fuel cell system excludes hydrogen storage, power electronics, batteries, and electric drive.
- ² The lifetime target is intended to cover the entire useful life of the vehicle. Fuel cell system lifetime is defined as hours of use with an appropriate duty cycle that considers real world driving conditions (i.e., not steady state operation). Corresponding vehicle lifetime range is 1M miles (Interim) and 1.2M miles (Ultimate) based on an average speed of 40 mph.
- ³ Interim and ultimate cost targets assume 100,000 units per year production volumes (except where specified within parenthetical references). Note that meeting fuel cell and hydrogen storage component cost targets may require leveraging automotive production volumes to achieve the necessary economies of scale for cost competitiveness. Current (2019) heavy-duty vehicle fuel cell technology was estimated to cost ~\$190/kW at 1,000 units per year manufacturing volume (Fuel Cell Systems Analysis, 2019 DOE Hydrogen and Fuel Cells Program Review Presentation, https://www.hydrogen.energy.gov/pdfs/review19/fc163_james_2019_o.pdf).
- ⁴ Costs are in 2016 dollars.
- ⁵ The storage system cycle life target is intended to represent the minimum number operational cycles required for the entire useful life of a vehicle used in long-haul operation. This target is technology agnostic.
- ⁶ Pressurized storage systems must meet cycle life requirements in applicable codes and standards (i.e., SAE J2579 and United Nations Global Technical Regulation No. 13). These codes and standards cycle life requirements require significantly more cycles than Storage System Cycle Life. For example, the baseline initial pressure cycle life in the United Nations Global Technical Regulation can require 11,000 cycles for a heavy-duty application.
- ⁷ Hydrogen storage system cost includes the storage tank and all necessary balance-of-plant components. This target is technology agnostic.
- ⁸ Current (2019) 700 bar hydrogen storage system was estimated to cost ~\$36/kWh at 1,000 units per year manufacturing volume and \$15/kWh at high volume (extrapolated from DOE Hydrogen and Fuel Cells Program Record #15013 “Onboard Type IV Compressed Hydrogen Storage System—Cost and Performance Status 2015,” https://www.hydrogen.energy.gov/pdfs/15013_onboard_storage_performance_cost.pdf). Note: Hydrogen storage targets will be updated and are currently based on U.S. DRIVE fuel cell electric vehicle targets.
- ⁹ Analysis based on 2050 simple cost of ownership assumptions and reflects anticipated timeframe for market penetration.

4 Targets Rationale

Fuel Cell System Lifetime

The targets for fuel cell system lifetime were derived from vehicle lifetime durability in miles (based on the total useful life of the vehicle) and an estimated average driving speed over the life of the vehicle. Vehicle lifetime assumptions are discussed in the assumptions section below.

The Class 8 tractor-trailer fuel cell system lifetime target of 30,000 hours corresponds to an average driving speed of 40 mph over a vehicle lifetime of 1,200,000 miles assumed (see assumptions section below) for Class 8 tractor-trailer trucks. Forty mph was chosen as an average speed based on the assumption that a typical Class 8 long-haul vehicle spends half of its life in long-haul operation (generally at highway speeds) and the remainder of its life in more regional usage (at lower speeds) as vehicle reliability decreases. The assumed average speed of trucks on interstate highways is between 50 and 60 mph based on the Federal Highway Administration studies⁹ on traffic volume and flow on major truck routes, tracking more than 500,000 trucks. The assumed average speed of trucks in regional use is 30 mph.

These targets do not consider overnight use of the fuel cell for hotel loads, which would add as much as 10,000 hours of operational time over the course of 500,000 miles. Using the fuel cell to directly meet the hotel loads would require the fuel cell to operate at low power/high cell voltage over these 10,000 hours, conditions that increase cell degradation. Since fuel cell systems are hybrid systems with batteries, it is envisioned that the battery would provide hotel loads, with the fuel cell providing intermittent recharging or recharging before shutdown, allowing the fuel cell to operate at a more beneficial/less-damaging power level, decreasing the durability impact of hotel loads to a minor contribution.

Interim fuel cell lifetime targets were set to 80% of the ultimate fuel cell lifetime targets.

Defining End of Life

Acceptable levels of degradation were discussed at the DOE Fuel Cell Truck Powertrain Workshop to define the end of life. While vehicles can be repurposed for other uses, degradation also reduces efficiency and fuel economy, payload, or grade speed. For purposes of measuring progress in fuel cell technology, a 10% voltage degradation at rated power will be used for benchmarking purposes (also consistent with U.S. DRIVE Fuel Cell Technical Team Targets).

4.1 Fuel Cell System Cost

Cost targets for the fuel cell system were determined by considering the manufacturing cost of advanced diesel engines with after-treatment technologies, the current state of the art of fuel cell technology projected to 100,000 units per year manufacturing volume, and comparison of

⁹ U.S. Department of Transportation, Federal Highway Administration, Office of Freight Management and Operations, Freight Facts and Figures 2010, Figure 3-13 and Table 3-8, https://ops.fhwa.dot.gov/freight/freight_analysis/nat_freight_stats/docs/10factsfigures/index.htm

the simple cost of ownership defined by capital cost of the truck plus fuel cost. Fuel cell cost targets for trucks are higher than fuel cell cost targets for light-duty vehicles (LDVs), primarily because of the higher durability required for trucks vs. cars (i.e., 25,000 to 30,000 hours for trucks vs. 8,000 hours for cars), but also because highway trucks have a relatively higher continuous load compared with automotive systems necessitating a larger fuel cell stack size. Fuel cost for long-haul trucks is much higher than the capital cost of truck, so investing in higher efficiency reduces the overall cost of ownership.

Argonne National Laboratory (Argonne) estimated the cost for a diesel engine with after-treatment technologies meeting the vehicle acceleration, grade speed, and cruising speed requirements for a Class 8 tractor-trailer truck. After-treatment technology included in the estimate consisted of a diesel oxidation catalyst, diesel particulate filters, and selective catalytic reduction system using a diesel exhaust fluid (urea solution). The diesel engine and after-treatment were estimated to have a manufacturing cost of approximately \$25,000 (for ~440 hp engine). Argonne specified a fuel cell system to meet the same vehicle requirements, resulting in a 390 kW fuel cell system. The fuel cell system ultimate cost target was set to approximately match the \$25,000 cost of the diesel engine plus after treatment, resulting in a cost target for the fuel cell system of \$60/kW. Consistent with the U.S. DRIVE Tech Team assumptions, the fuel cell system does not include electric drive or power electronics components.

Interim and Ultimate fuel cell system cost targets were projected to various manufacturing production rates up to 100,000 units per year. References indicate that the market for Class 8 trucks is approximately 200,000 per year.¹⁰ Class 8 truck fuel cell system manufacturing cost estimates were performed by Strategic Analysis Inc. (SA) for current (2019 technology) and projected Interim (2030) and Ultimate (2050) future technology. The manufacturing cost was projected to be \$283 per kW for 2019 fuel cell technology at 200 units per year manufacturing rate.¹¹ The 2019 technology analysis was then extended to project hypothetical 2030 and 2050 technology costs assuming improved efficiency and durability consistent with achievement of DOE targets, and assuming advancement in performance necessary to drive down cost.

While it appears in this analysis that performance is constant in terms of Watts per cm² active cell area, the overall performance improvement projected in the system is credited to reductions in catalyst loading and operating pressure. While there are several other possible pathways to achieve cost reduction, these projections provide a basis for selection of the \$80/kW (Interim) and \$60/kW (Ultimate) cost targets at 100,000 units per year. Successfully reducing the catalyst loading and operating pressure while maintaining power density is just one viable pathway to reduce costs to target levels.

¹⁰ 2016 Vehicle Technologies Market Report, Oak Ridge National Laboratory, <http://cta.ornl.gov/vtmarketreport/index.shtml>

¹¹ "Mass Production Cost Estimation of Direct H₂ PEM Fuel Cell Systems for Transportation Applications: 2018 Update- DRAFT PREPRINT," Brian D. James, Jennie M. Huya-Kouadio, Cassidy Houchins, and Daniel A. DeSantis, Strategic Analysis, Inc., October 2019.

Key configurations and costing parameters used in the fuel cell system cost analysis are shown in Table 2. Required power is expected to drop as SuperTruck-related vehicle improvements are adopted. Stack conditions at peak power are reported as they are used to establish the physical size (and cost) of the fuel cell system. The cost projections are based on a non-proprietary representative design. Features were included in the design for improved durability such as including relatively high catalyst loading, graphitic bipolar plates, a moderate operating temperature, and thicker membranes. While these features are similar to stack designs used in Ballard 40-foot transit buses, which have demonstrated in excess of 25,000 hours of operation, stacks have yet to be evaluated under appropriate conditions for truck applications. Additionally, large fuel cell stacks were chosen to increase efficiency at load by reducing the current density. These choices reduce fuel consumption and heat rejection requirements but result in a physically larger and more expensive fuel cell system. Details of the cost analysis methodology and current cost status can be found in DOE Hydrogen and Fuel Cells Program Record 17007: Fuel Cell System Cost—2017¹² and in the report Mass Production Cost Estimation for Direct Hydrogen PEM Fuel Cell Systems for Automotive Applications: 2017 Update.^{13,14} The cost methodology is consistent with light-duty vehicle targets.

Table 2. Fuel Cell System Parameters Assumed for Guiding the Cost Targets

| | 2019 Status | Interim (2030) | Ultimate (2050) |
|---|-------------|----------------|-----------------|
| Net Fuel Cell System Power [kW] | 308 | 270 | 240 |
| Peak Power Conditions | | | |
| Cell Voltage [volts] | 0.769 | 0.769 | 0.769 |
| Power Density [mW/cm ²] | 840 | 840 | 840 |
| Pressure [atm] | 3 | 2 | 1.3 |
| Total Catalyst Loading [mg Pt/cm ²] | 0.4 | 0.3 | 0.25 |
| Air Compressor | Centrifugal | Centrifugal | Centrifugal |
| Exhaust Gas Expander | None | Radial Inflow | None |

While more rigorous analysis is needed to support a realistic cost of ownership estimate, a simplified cost of ownership (SCO) estimate was performed to roughly compare the total costs of advanced diesel technology and fuel cell powertrains running on hydrogen. The SCO was calculated by adding the initial capital cost of the truck divided by total lifetime mileage, plus the fuel cost per mile, plus the maintenance cost per mile. While advanced diesels have not been widely tested on standard duty cycles, modern diesel trucks have been able to achieve 10.1 mpgd at an average fleet speed of 54 mph, and average gross weight of 55,498 lb.¹⁵ Based

¹² DOE Hydrogen and Fuel Cells Program Record 17007: Fuel Cell System Cost—2017, https://www.hydrogen.energy.gov/pdfs/17007_fuel_cell_system_cost_2017.pdf

¹³ https://www.energy.gov/sites/prod/files/2017/06/f34/fcto_sa_2016_pemfc_transportation_cost_analysis.pdf

¹⁴ https://www.energy.gov/sites/prod/files/2018/04/f51/fcto_webinarslides_2018_costs_pem_fc_autos_trucks_04_2518.pdf

¹⁵ Run-On-Less Report, North American Council for Freight Efficiency, Feb 28, 2018, <https://nacfe.org/run-on-less-report/>

on conservative 2020 model assumptions simulated on the EPA 55 drive cycle and with 36,000 lb cargo, fuel cell truck technology could currently achieve 9.4 mpkg (10.7 mpgde).¹⁶

Table 3 summarizes the fuel economy assumed for the SCO analysis. The SCO analysis assumed improvements in diesel engine peak efficiency to 59% (Ultimate) with a waste heat recovery device (achieving 54% drive cycle efficiency), as well as aerodynamic, rolling resistance, frictional loss, and accessory system efficiency improvements that will allow diesel trucks to achieve 15.6 mpgd. Using the same vehicle improvements, an advanced (Ultimate) fuel cell powered truck is projected to have 16% efficiency improvement over the diesel engine (i.e., 66% fuel cell X 95% electric motor = 62.7% fuel cell drive cycle efficiency vs. 54% diesel drive cycle efficiency) and achieve 17 mpkg (19.4 mpgde) with the same aerodynamic, rolling resistance, frictional loss, and accessory system efficiency improvements (assuming 36,000 lb cargo and EPA 55 drive cycle). Because hydrogen trucks are powered with both batteries and fuel cells, the overall fuel economy improvement achieved is 24% higher than diesel trucks due to both regenerative braking and the ~16% higher powertrain efficiency based on Argonne analysis. Note that diesel trucks could also benefit from hybridization, and targets for fuel cells and other advanced technologies would need to be more aggressive to compete with further advancements in incumbent technologies. The Fuel Economy Assumptions section below provides more detail on the rationale for the fuel economy assumptions.

Table 3. Fuel Economy Assumed for Simple Cost of Ownership Analysis

| | Ultimate Peak Efficiency | Ultimate Drive Cycle Efficiency ¹ | Ultimate Fuel Economy (w/ advanced vehicle improvements) |
|-----------------|--------------------------|--|--|
| Diesel Truck | 59% | 54% | 15.6 mpgde |
| Fuel Cell Truck | 72% | 66% x 95% = 62.7% | 17 mpkg/19.4 mpgde |

¹ Fuel cell drive cycle efficiency includes a 95% electric motor efficiency.

The cost of hydrogen was assumed to be \$5 per kg based on meeting DOE ultimate cost targets for delivered hydrogen (\$4/kg), adjusted inflation to 2015 and \$0.50 tax. Cost for diesel was projected to be \$4.09¹⁷ based on 2018 EIA Annual Energy Outlook 2050 projections.

Based on fuel economy and fuel cost, lifetime fuel cost saved over the 1,200,000-mile life by using a fuel cell truck vs. an advanced diesel was estimated to be \$33,000 when comparing a 17.0 mpkg fuel cell truck to a 15.6 mpgd diesel truck.

The fuel cell truck was estimated to cost approximately \$2,500 less than an advanced diesel truck with waste heat recovery, based on:

¹⁶ Argonne modeling by Ram Vijayagopal

¹⁷ U.S. Energy Information Administration Annual Energy Outlook 2018, Transportation Diesel Fuel (distillates fuel oil) Diesel fuel for on-road use. Includes Federal and State taxes while excluding county and local taxes. \$31.25/MMBtu x 0.139 MMBtu/gal.

- Meeting the fuel cell system cost target of \$60/kW
- Hydrogen storage cost of \$266/kg¹⁸
- Electric traction motor and power electronics cost of \$12/kW based on the 2025 \$6/kW light-duty vehicle cost targets for electric traction drive systems¹⁹ multiplied by a factor of 2 for heavy-duty applications.

Maintenance costs are unknown for fuel cell truck powertrains as the supply chain and service networks are not yet fully mature, but industry feedback indicates that ultimately fuel cell powertrain maintenance costs would fall between lower battery-electric powertrain maintenance and higher diesel powertrain maintenance. While maintenance on transit buses is likely different than trucks, there is some data available for transit buses that have similar powertrains.²⁰ Figure 4 shows a comparison of maintenance between transit bus powertrain technologies. Table 4 shows the transit agencies and buses included in this data set. The maintenance for fuel cell bus propulsion systems appears to be coming down a learning curve but still remains higher than mature diesel technology after four years of service. Workforce skills, parts volume, and supplier competition are likely major factors that could take another decade or more to mature. The American Transportation Research Institute published “An Analysis of the Operational Costs of Trucking: 2018 Update.” They report that repair and maintenance costs in 2017 were \$0.167 per mile, steadily increasing from \$0.123 per mile in 2009 (tires are a separate cost and not included in this data).

For the SCO, we assumed maintenance cost to be \$0.17 per mile for both the diesel and the hydrogen ultimate case. We increased the maintenance by 25% (to \$0.21 per mile) for the hydrogen Interim case and by 50% (to \$0.25 per mile) for the hydrogen Current case.

¹⁸ For the Ultimate case, the advanced diesel engine with after-treatment (\$20,000), waste heat recovery (\$5,000), transmission (\$8,700), fuel tank (\$363), and battery (\$218) were estimated to cost a combined \$41,000 after a 20% estimated manufacturer markup. The fuel cell powertrain consisting of the fuel cell system (\$14,400), hydrogen storage system (\$11,700), battery (\$1,500), electric traction motor and power electronics (\$4,500) was estimated to cost a combined \$38,500 after 20% manufacturer markup.

¹⁹ U.S. DRIVE Electrical and Electronics Technical Team Roadmap October 2017 (page 9):

<https://www.energy.gov/sites/prod/files/2017/11/f39/EETT%20Roadmap%2010-27-17.pdf>

²⁰ Technology Acceleration: Fuel Cell Bus Evaluations, Leslie Eudy, May 1, 2019.

https://www.hydrogen.energy.gov/pdfs/review19/ta013_eudy_2019_o.pdf

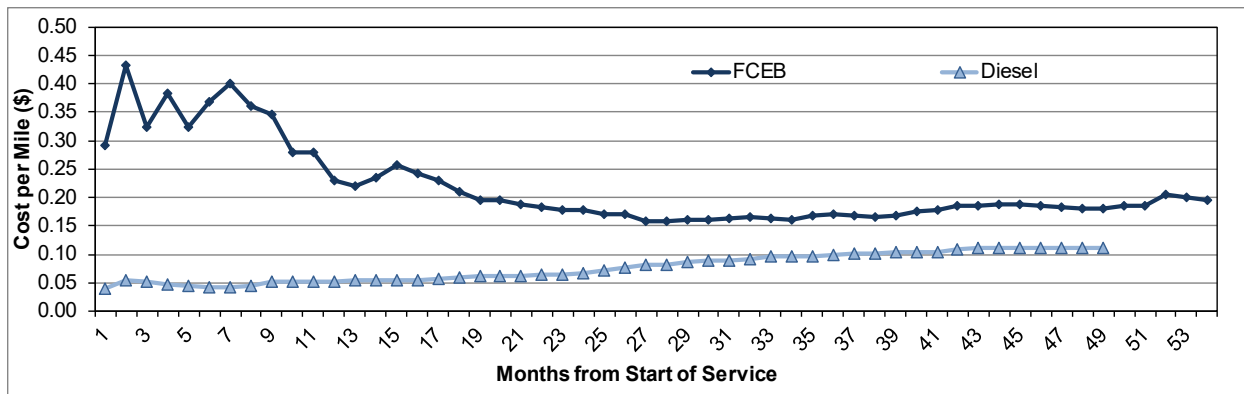

Figure 4. Cumulative cost per mile—propulsion system only

Table 4. Overview of Projects Included in Maintenance Data²⁰

| | FCEB | Diesel |
|------------------|---------------------------|---------------------|
| Transit Agencies | SunLine, SARTA, OCTA | AC Transit |
| Bus OEM | ENC/ BAE Systems/ Ballard | Gillig |
| Model Year | 2014, 2015, 2017 | 2013 |
| Length | 40 | 40 |
| # Buses | 14 | 10 |
| Data Period | June 2014–Dec 2018 | July 2013–July 2017 |
| Total Miles | 539,087 | 2,187,987 |
| Total Hours | 45,492 | - |

4.2 Hydrogen Fill Rate

The long-haul tractors use case requires the most fuel and highest fill rate because they have the largest range requirement and carry the heaviest loads. For reference, diesel tractors are filled at rates exceeding 60 gallons per minute (using two hoses simultaneously) and can have tanks as large as 150 gallons on each side of the truck. With a 5-minute refuel, a conventional diesel truck can travel more than 1,800 miles with 300 gallons of diesel. While these vehicle ranges can span multiple days, for the long-haul use case with relatively quick refueling, we assumed that a maximum fueling frequency of once per day is acceptable. For other use cases, fill rates may be less demanding because of lower distance or use of range per day, or higher frequency fueling may result in less fuel per fill.

Storing and dispensing fuel is relatively cheap for a diesel truck, but significantly more expensive for a hydrogen-fueled truck. In addition to higher compressor costs, additional pre-cooling costs may be incurred to account for the increased heat of compression seen with higher fill rates. It is therefore important to limit the hydrogen fill rate, and as a result the vehicle range, to match what is realistically required (i.e., the maximum daily range), in order to keep the cost of onboard hydrogen storage and dispensing as low as possible while meeting necessary requirements.

The hydrogen fill rate was determined from three assumptions: filling time, vehicle range, and fuel economy (usable onboard hydrogen is determined from vehicle range and fuel economy). The filling time requirement was determined from feedback at the DOE Fuel Cell Truck Powertrain Workshop. Time spent refueling impacts the economics for both the refueling station operator and the truck/fleet operator, and should be minimized to enable a favorable business case for each. It was stressed that time on the road is critical to shipping operations and monitored in tenths of an hour (6-minute increments). A 6-minute fill allows truck operators to complete all tasks (i.e., time waiting for an available pump, dispensing, payments, using the restroom, etc.) and be back on the road in 15 to 18 minutes, and also provides sufficient customer turnover at the pump for station operators. Assuming a 12.4 mpkg fuel economy (discussed in assumptions section below) for Class 8 tractor-trailer trucks, approximately 60 kg of H₂ will be required to achieve a 750-mile range. Thus, an ultimate target of 10 kg/min is needed to achieve a 750-mile range (~60 kg H₂ in 6 minutes).

While the 6-minute fill time assumption for the ultimate hydrogen fill rate target is ideal for providing fast fueling capability for the larger fuel capacity requirements of long-haul tractor-trailer trucks, the tradeoffs between extra time at the pump and extra costs of higher throughput compression and additional cooling that may be needed to provide such a fast fill have not been fully determined. Thus, the interim hydrogen fill rate target relaxes the fill time assumed to 10 minutes. A 10-minute fill, while slower than the incumbent, is considered passable by some developers. The interim target, 8 kg/min, is set to provide a fill sufficient for a 750-mile range in under 10 minutes, assuming 11 mpkg interim target.

At a higher fuel economy than 12.4 mpkg, the tank capacity can be reduced while still providing 750-mile range, or the vehicle range can increase. It should be noted that hydrogen demand for hydrogen powered freight refrigeration systems have not been considered in these calculations.

4.3 Time Fills

At the DOE Fuel Cell Truck Powertrain Workshop, “time fills” were discussed in one of the breakout sessions. Time fills take advantage of situations when there is ample time to refuel the vehicle such as 7 to 10 hours overnight or up to 16 hours between single-shift operations. DOE opted not to develop a technical target for time fills, because fundamental technology advancement is not needed to make lower throughput station equipment. As with all refueling technology, standard protocols will still be needed to ensure compatibility between onboard hydrogen storage systems and fueling station equipment.

4.4 Storage System Cycle Lifetime

Class 8 tractor-trailer truck Storage Tank Cycle Lifetime targets are for guidance of early stage R&D and not for certification purposes. These targets are technology agnostic and meant to be applicable to low-pressure or low-temperature approaches as well as high-pressure or ambient-temperature options. Additionally, these targets are not equivalent to the durability test cycles, which require significantly more cycles to ensure safe performance. For example, the safety of critical components (i.e., cylinder, relief valves, etc.) involved in managing pressure and temperature conditions requires a durability cycle life exceeding the DOE Storage Tank Cycle

Lifetime targets, as specified in the applicable codes and standards (i.e., SAE J2579 and the United Nations Global Technical Regulation)—see Pressurized Storage System Cycle Life target section below.

The number of operational cycles was calculated as the design lifetime mileage of the vehicle divided by the effective range of the vehicle between refills. Customers expect the fuel system to last the life of the vehicle (i.e., 1,200,000 miles). Assuming a cycle definition of a quarter full to full tank (i.e., 560 miles), ~2,140 fill cycles (i.e., 1,200,000 / 560 miles) would be needed to achieve the desired vehicle life. For vehicles that extend beyond their expected lifetimes or are fueled more frequently, a ~2x factor was used resulting in the 5,000 cycle Ultimate target.

4.5 Pressurized Storage System Cycle Life

This target is specific to required certifications for pressurized hydrogen storage tanks. In order to meet the necessary durability test cycles, pressurized hydrogen storage tanks must meet applicable codes and standards (i.e., SAE J2579 and the United Nations Global Technical Regulation). These codes contain significant detail and nuances specific to cycle requirements for pressurized tanks to ensure their safe operation.

4.6 Hydrogen Storage System Cost

The hydrogen storage cost targets for Class 8 long-haul tractor-trailer trucks are technology agnostic and based on existing LDVs on a per kg hydrogen basis.²¹ While these truck targets are based on a lower expected manufacturing rate (100,000 units per year for Class 4–8 trucks compared to 500,000 units per year for LDVs), medium- and heavy-duty truck applications will likely require multiple tanks per vehicle due to packaging constraints and will benefit from leveraging LDV production volumes to achieve the necessary economies of scale. Additional balance of plant (e.g., valves, regulators, piping, mounting brackets, etc.) will likely be required to accommodate multiple tanks for truck applications, but this additional cost will be divided over multiple large tanks and therefore it is reduced on a per mass basis (compared to smaller tanks typically used in LDV applications). It should be noted that additional analysis is being performed to further vet these cost targets and thus DOE may update them as additional information is gathered.

²¹ Target Explanation Document: Onboard Hydrogen Storage for Light-Duty Fuel Cell Vehicles:
https://www.energy.gov/sites/prod/files/2017/05/f34/fcto_targets_onboard_hydro_storage_explanation.pdf

5 Assumptions

In the development of targets for Class 8 tractor-trailer trucks and Classes 4–8 vocational trucks, we assumed the vehicle lifetime, vehicle range, and fuel economy based on industry input.

5.1 Vehicle Lifetime

Table 5. Vehicle Lifetime Status Estimate, Interim and Ultimate Assumptions for Hydrogen Trucks

| | Status Estimate (Hydrogen Truck) | Long-Haul Tractor Trailer Trucks (Diesel and Hydrogen) | |
|---|--|---|----------------|
| | | Interim | Ultimate |
| Vehicle Lifetime [years / miles] | 8.4 / 237,483 ¹ | 10 / 1,000,000 | 12 / 1,200,000 |

¹ Status for fuel cell bus real-world operation is shown because of a lack of durability data on fuel cell-powered trucks. Fuel cell power-plants in buses have exceeded the 25,000-hour target; however, these power-plants have not been shown to meet cost targets. Cost and durability targets must be met simultaneously, while meeting acceptable end-of-life performance and efficiency.

For the purpose of determining hydrogen truck targets, vehicle lifetime is assumed as the entire useful life of the vehicle.

The vehicle lifetime assumption allows for vehicle operation that is similar to the incumbent technology (i.e., diesel trucks). Feedback from the DOE Fuel Cell Truck Powertrain Workshop²² indicated that Class 8 tractor-trailer trucks should meet a lifetime of 10 years and 1,000,000 miles. These trucks usually spend half of their life in long-haul operation and then operate in more regional usage as reliability decreases due to wear and tear. Further discussions with industry indicated lifetime mileage is increasing to 1,200,000 miles and possibly higher.

Fuel cells in existing transit bus demonstrations have shown over 30,000 hours operation and provide some confidence that fuel cells are durable enough for truck applications. Assuming this existing durability is transferable to truck applications within 10 years, the Interim target is set to 1,000,000 miles, equivalent to the existing durability of diesel tractor-trailer trucks. The Ultimate target is set to 1,200,000 miles to match the trend toward higher durability.

²² Fuel Cell Truck Powertrain R&D Activities and Target Review Workshop: H2@Scale End Use Applications, Chicago, IL, July 30–31, 2018. <https://www.energy.gov/eere/fuelcells/fuel-cell-truck-powertrain-rd-activities-and-target-review-workshop-h2-scale-end-use>

5.2 Fuel Economy

Table 6. Fuel Economy Status Estimate, Interim and Ultimate Assumptions

| | Status Estimate ² | Tractor-Trailer Trucks | |
|-------------------------|------------------------------|------------------------|-----------|
| | | Interim | Ultimate |
| Hydrogen Trucks [mpkg] | 9.4 ¹ | 11.1–14.0 | 12.4–17.0 |
| Hydrogen Trucks [mpgde] | 10.7 ¹ | 12.6–15.9 | 14.1–19.4 |
| Diesel Trucks [mpgd] | 10.0 ³ | 10.9–13.0 | 11.9–15.6 |

- ¹ Based on Argonne Autonomie 2020 conservative model fuel cell truck simulated with 36,000 lb payload on EPA 55 drive cycle. The Argonne model aligns with Run on Less, Annual Fleet Fuel Study, and Navistar reports.
- ² Hydrogen powered trucks are compared to advanced state-of-the-art diesel vehicles, i.e., late model year trucks, with commercially available and cost-effective high efficiency options. The national average fuel economy for over-the-road tractor-trailer population is 6.4 mpgd.²³
- ³ See section 5.3.

Fuel economy assumptions were used for determining the hydrogen fill rate targets and SCO calculations that were used to support the hydrogen storage system cost and fuel cell system cost targets. The baseline fuel economy was determined by reviewing reports of real-world data from recent testing, fleets, and demonstrations. Interim and Ultimate (2030 and 2050) fuel economy assumptions for hydrogen-fueled trucks were determined and validated by:

- Assuming advancement in:
 - Aerodynamic, rolling resistance, accessory loads, and light-weighting common to both diesel and fuel cell vehicles
 - Diesel engine and waste heat recovery system efficiencies
 - Fuel cell and electric motor efficiency.
- Modeling advanced trucks (using Argonne’s vehicle simulation tool, Autonomie²⁴) that achieve acceleration, cruising, and grade requirements equal to incumbent, as well as the vehicle range target.
- Simulating advanced vehicles (using Autonomie) on the EPA 55 cycle with 36,000 lb payload.
- Reviewing drive cycle powertrain efficiencies computed by the simulations.
- Reviewing the fuel economy improvement achieved from advancing diesel technology.
- Comparing fuel economy estimated from powertrain drive cycle efficiencies to the Autonomie simulation results.

²³ <https://nacfe.org/annual-fleet-fuel-studies/>

²⁴ <https://www.anl.gov/es/autonomie-vehicle-system-simulation-tool>

- Comparing a baseline truck model on steady state and EPA 55 and 65 mph cycles with GVW ranging from 50 to 66 k-lb to:
 - North American Council for Freight Efficiency (NACFE) 2017 Run-on-Less²⁵ (ROL)
 - NACFE 2018 Annual Fleet Fuel Studies²⁶ (AFFS)
 - 2017 Navistar report on the 2018 International LT Series Fuel Efficiency Test²⁷ (Navistar report).

When projecting technology advancements, the expected improvements in aerodynamic drag, rolling resistance, accessory efficiency, and driveline efficiency, that are common to both diesel and fuel cell-powered vehicles, were applied to both types of trucks equally.

5.3 Diesel Baseline Fuel Economy

For Class 8 tractor-trailer trucks running on diesel, 10.0 mpgd was assumed to be the status of new state-of-the-art commercial Class 8 truck fuel economy and was determined by reviewing real-world data presented in the NACFE 2018 AFFS, which showed 2018 model year trucks have fuel economy from 7.5 to 9.5 mpgd across 20 fleets; the NACFE 2017 ROL demonstrations, which showed an average of 10.1 mpgd across seven vehicles; and a Navistar report showing 7.8 mpgd average for the leading vehicle.

The AFFS study includes 20 fleets and determined the fuel economy of model year 2018 trucks in real regional and long-haul operation, but it provides no information on drive cycles or payloads. The Navistar report included four different truck models (six total trucks) and is not clear on vehicle speed but only ran a single route spanning ~1,200 ft elevation. The recent Run on Less²⁸ demonstration by NACFE, including seven trucks covering over 50,000 miles over 17 days in real-world conditions and varying weather, achieved average on-road fuel efficiencies for Class 8 diesel trucks of 10.1 mpgd as shown in Figure 5. Fleets participating in the Run on Less demonstration used late model trucks equipped with current, commercially available technologies. Fleets excluded technologies that improved fuel economy if they had already decided not to pursue the technology in their purchases. Run on Less reported payloads and speeds, but had relatively flat routes, mild temperatures allowing reduced HVAC use, wind speed affected by storms, and did not include typical driver behavior, but used expert drivers for achieving the highest fuel economy.

²⁵ <https://nacfe.org/run-on-less/>

²⁶ <https://nacfe.org/annual-fleet-fuel-studies/>

²⁷ https://www.internationaltrucks.com/-/media/navistar/trucks/spotlight/fuel-economy/lta26_wp-06-vf.pdf

²⁸ Run-On-Less Report, North American Council for Freight Efficiency, Feb 28, 2018, <https://nacfe.org/run-on-less-report/>

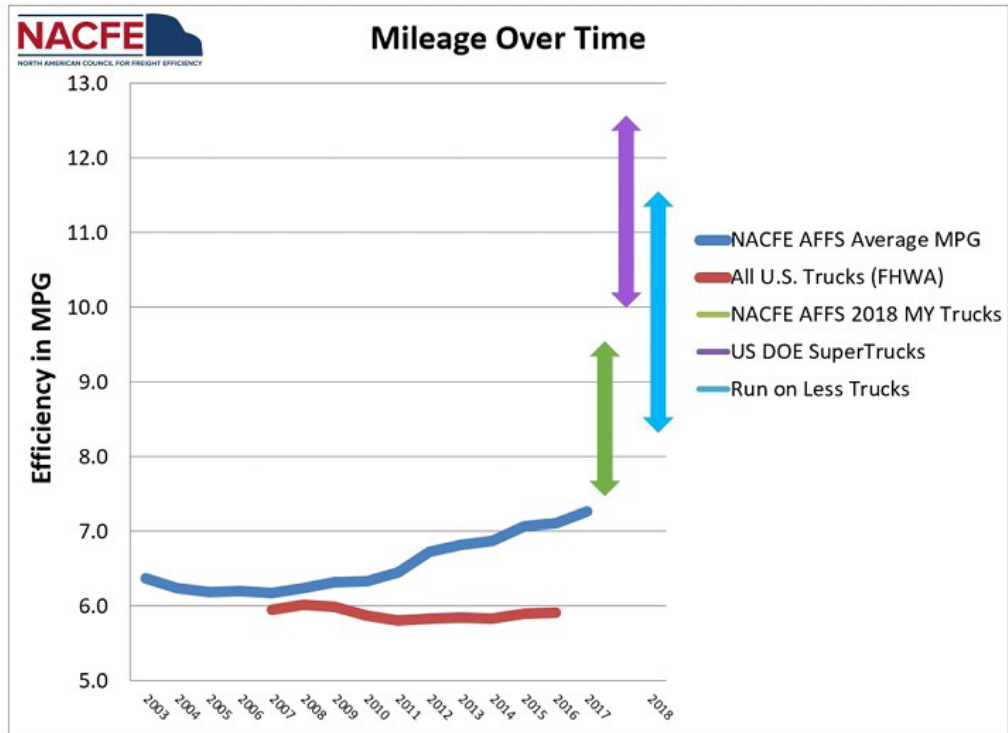

Figure 5. Comparison of fuel efficiency for NACFE AFFS Average mpgd, DOE SuperTrucks, and Run on Less trucks

Real fuel economy depends on many factors including speed, wind speed, traffic, grade, climate, tires, pavement, payload, number of stops, and the overall dynamics of the route driven. Analysis at Argonne showed that the differences in fuel economy across the three reports can be accounted for by payloads and drive cycles as shown in Figure 6. Argonne characterized the best-in-class commercial vehicles (see Table 7) using parameters obtained from aero, tire, and accessory improvements demonstrated by DOE SuperTruck Technology.²⁹ Varying the payload and drive cycle in models reproduced the range of results seen in the ROL, AFFS, and Navistar reports, validating the model against the data available.

The Autonomie model for the Class 8 line haul truck uses component test data obtained from national labs and other government agencies such as EPA and NHTSA. The assumptions on the level of technology improvements achieved in 2017, and the expected improvements in the near future, were reviewed by industry experts and DOE’s Sustainable Transportation technology managers.³⁰

To examine how such a model compares against real-world driving conditions, two test cases were used. The first is the Run on Less program conducted by NACFE, and the second was a test

²⁹ TA Engineering Inc., “DOE SuperTruck Program Benefits Analysis,” Dec. 2012

³⁰ T.S. Stephens, R. Vijayagopal, et al. “Vehicle Technologies and Fuel Cell Technologies Office Research and Development Programs: Prospective Benefits Assessment for Medium- and Heavy-duty Vehicles,” 2019

conducted by Navistar. Both tests involved trucks from multiple manufacturers, so it would be fair to assume that their average fuel economy values are a good indicator of the modern trucks.

Navistar tested the vehicles in Canada where the posted speed limit was 100 kmph (62.5 mph). We expect the EPA 65 cycle to represent this operation. The lower speed limit in Canada could result in a slightly higher mpgd compared to the EPA 65. Trucks that were part of ROL were trying to achieve better fuel economy and had an average speed of 54 mph. A steady 55 mph run would be a close enough proxy for evaluating the ROL test case.

The average fuel economy results from ROL and the Navistar tests are shown in Figure 6 on the left and right edges. The simulation results with various test weights, over different cycles, are shown between those results. It can be seen that for 55 k-lb test weight, the result from a steady 55 mph run matches the ROL results very closely (10.3 mpgd simulated vs. 10.1 ROL demo average). Similarly, results reported by Navistar trucks, which weighted 66 k-lb, are quite close to EPA 65 cycle results (7.8 mpgd).

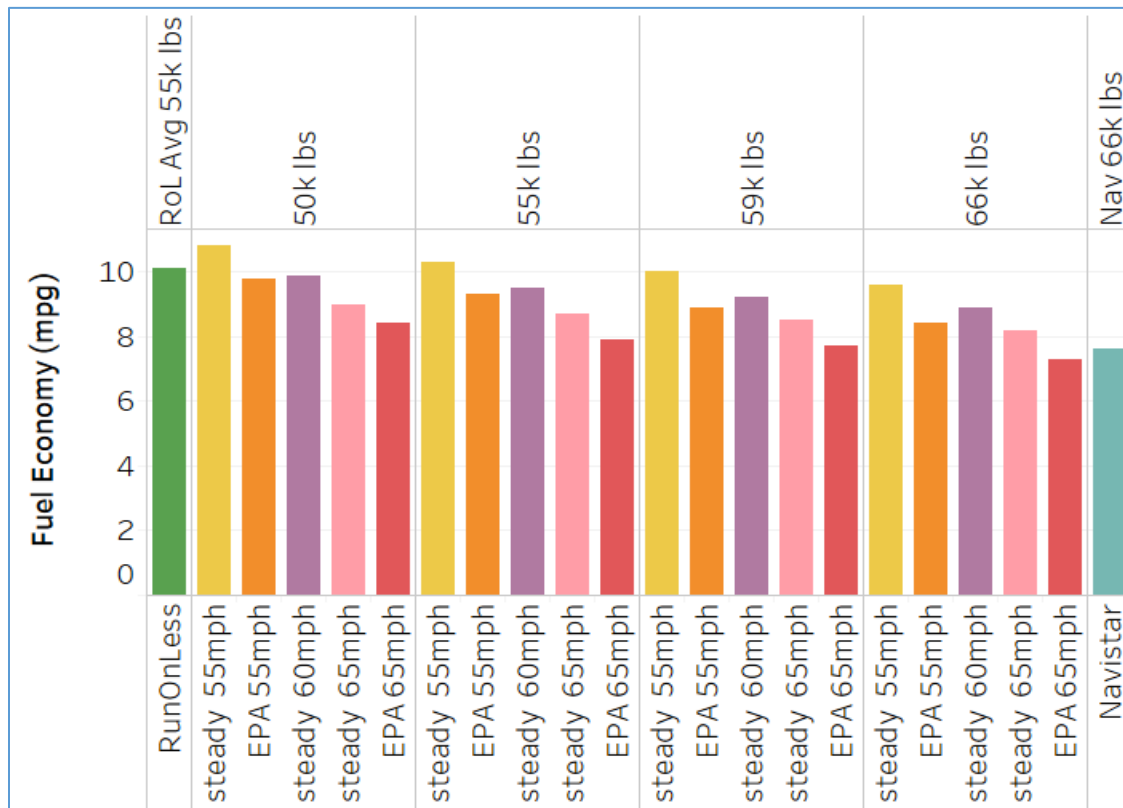

Figure 6. Comparison of Argonne’s 2017 modeled truck at various loads and drive cycles with reported performance of recent Run-on-Less and Navistar demonstrations

ROL data was filtered to examine trucks that had performed at typical speeds and at higher loads that provide for overall freight efficiency. Vehicle cargo weight of 36,000 lb was used to ensure a fair comparison across vehicles. ROL trucks that had a GVW close to 66 k-lb

demonstrated an average of 9.3–10.8 mpgd depending on their average speed. As expected, lower speed operation resulted in higher mpgd.

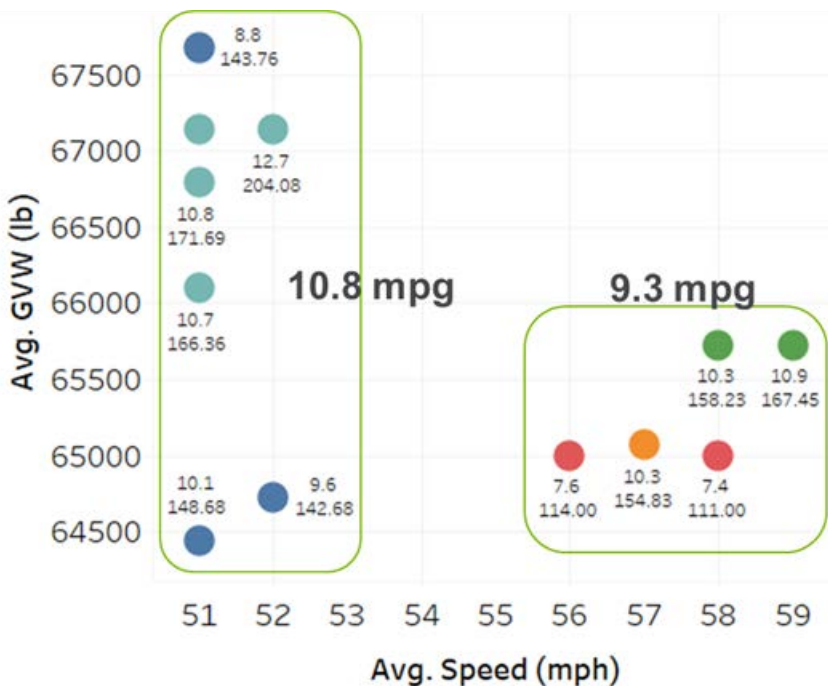

Figure 7. 2017 Run-on-Less trucks averaging over 50 mph with payloads near 66,000 lb. Each color represents a specific truck. Labels indicate fuel economy (mpgd) and freight efficiency (ton-mile per gallon).

Argonne simulated trucks on both EPA 55 drive cycle and at a steady 55 mph at 66,000 lb resulting in 9 and 10.3 mpgd. The EPA 55 regulatory cycle has the average speed observed for these vehicles, and the grade profile used in EPA 55 is expected to be representative of the truck routes in the United States. The average for the ROL demonstration trucks at comparable speed and GVW, 10.2 mpgd, falls in between the EPA 55 and steady state speed simulation results.

While the Argonne model vehicle was closer to average performance of the Run-on-Less demonstration (10.1 mpgd with 55 k-lb load at 54 mpgd), 10.0 mpgd was selected as the status because leading trucks in Run-on-Less consistently achieved over 10.0 mpgd above 55 mph and loaded to 65 to 66 k-lb GVW. With additional technical progress since the 2017 ROL demonstration, it is likely that all Class 8 trucks have progressed to this level of performance or beyond.

Going forward, it will be important to evaluate technical progress in a manner consistent with the target. The baseline Autonomie model assumed approximately 30,000 lb for the tractor and empty trailer, with a 36,000 lb cargo load to reach a 66,000 lb GVW for the simulation. Because the targets were set using the EPA 55 drive cycle and the objective of long-haul trucks is to move freight, it is fair to evaluate technologies with a controlled cargo mass. While 36,000 lb is not the maximum load attainable, it allows for comparison across powertrains that may include

much higher weight components. Also, many trucks reach volume limits before they reach maximum GVW limits. Fuel economy status should be measured under the same or equivalent drive cycle with the same 36,000 lb cargo mass. Lower weight components will benefit the fuel economy and increase maximum payload and maximum freight efficiency for the vehicle. Freight efficiency for Class 8 trucks could be measured at 36,000 lb and at max GVW to obtain maximum freight efficiency for the vehicle (assuming fuel efficiency doesn't drop off with maximum payload).

5.4 Technology Advancement

Interim and Ultimate fuel economy were determined from simulated long-haul sleeper trucks on regulatory cycles with a 36,000 lb cargo load. Table 7 below shows the vehicle and powertrain assumptions used for projecting advances in fuel economy (interim and ultimate). This includes both a conservative (low) and aggressive (high) range of technical progress. The DOE Vehicle Technologies Office established a 55% thermal efficiency goal for diesel engines for the SuperTruck II projects with the use of waste heat recovery, and 59% diesel engines (including waste heat recovery) are considered for the 2050 timeframe. It is expected that the diesel incumbent will use a waste heat recovery system to achieve peak diesel efficiency assumed. Fuel cells can currently achieve over 64% peak efficiency (60% efficiency at highway speeds) and 72% efficient fuel cells are considered for the 2050 timeframe. Automotive fuel cell systems currently in low volume commercial production achieve 63.7% peak efficiency.³¹

Table 7. Class 8 Tractor-Trailer Fuel Economy Assumptions Summary

| <i>Class 8 Sleeper High Roof</i> | Baseline | Interim | Ultimate |
|------------------------------------|----------|---------|----------|
| Coefficient of Drag Low | 0.49 | 0.43 | 0.41 |
| Coefficient of Drag High | 0.49 | 0.34 | 0.30 |
| Rolling Resistance Low (kg/tonne) | 5.4 | 4.9 | 4.8 |
| Rolling Resistance High (kg/tonne) | 5.4 | 4.2 | 3.6 |
| Diesel Peak Eff. Low | 49% | 53% | 55% |
| Diesel Peak Eff. High | 49% | 55% | 59% |
| Fuel Cell Peak Eff. Low | 61% | 64% | 68% |
| Fuel Cell Peak Eff. High | 64% | 68% | 72% |
| Electric Machine Peak Eff. | 96% | 96% | 96% |
| Accessory Load (W) Low | 3400 | 2600 | 2000 |
| Accessory Load (W) High | 3400 | 1900 | 1000 |
| Glider Weight Reduction Low | 0 | 5% | 9% |
| Glider Weight Reduction High | 0 | 8% | 15% |

³¹ Technology Assessment of a Fuel Cell Vehicle: 2017 Toyota Mirai, https://www.hydrogen.energy.gov/pdfs/review18/tv149_lohsebusch_2018_p.pdf

The Interim and Ultimate powertrain drive cycle efficiencies over the EPA 55 drive cycle are shown in Table 8 below for both diesel and fuel cell powerplants. Fuel cell drive cycle efficiency is 92% to 93% of peak fuel cell efficiency and diesel drive cycle efficiency is 92% to 94% of peak diesel efficiency. Drive cycle efficiencies are reasonable considering the relatively narrow range of operation. This analysis assumed that fuel cell stacks for trucks have a significantly higher cell count than automotive stacks in order to enable efficiency at higher continuous duty cycle loads. The cell count is accounted for in the cost and SCO analyses. The bottom line of Table 8 shows the ratio of fuel cell power-plant efficiency (including electric drive) to diesel engine power-plant efficiency.

Table 8. Class 8 Tractor-Trailer Power-Plant Drive Cycle Efficiency Summary

| <i>Class 8 Tractor Low Case</i> | Baseline | Interim | Ultimate |
|---|----------|---------|----------|
| Fuel Cell (Low) | 56% | 59% | 63% |
| Diesel (Low) | 46% | 49% | 51% |
| Electric Machine (FC only) | 95% | 95% | 95% |
| Overall Ratio of Drive Cycle Eff. (FC/Diesel) | 1.16 | 1.14 | 1.17 |

| <i>Class 8 Tractor High Case</i> | Baseline | Interim | Ultimate |
|---|----------|---------|----------|
| Fuel Cell (High) | 59% | 63% | 66% |
| Diesel (High) | 46% | 51% | 54% |
| Electric Machine (FC only) | 95% | 95% | 95% |
| Overall Ratio of Drive Cycle Eff. (FC/Diesel) | 1.22 | 1.17 | 1.16 |

Table 9 shows the resulting baseline fuel economy, along with projected technology advancement. On the EPA 55 cycle, prescribed vehicle-wide improvements increase diesel fuel economy by 20% and 30% for the 2030 and 2050 low cases compared to the baseline and improve fuel economy by 45% and 70% for 2030 and 2050 high cases compared to the baseline. The DOE SuperTruck 1 results³² show that Class 8 tractor-trailer diesel truck prototypes can achieve 12.5–13 miles per gallon (mpgd). Technological improvements should allow these

³² DOE SuperTruck Program Benefits Analysis Final Report. December 20, 2012. TA Engineering, Inc. Cummins SuperTruck Program; Technology and System Level Demonstration of Highly Efficient and Clean, Diesel Powered Class 8 Trucks: https://www.energy.gov/sites/prod/files/2015/06/f23/ace057_koerberlein_2015_o.pdf
 SuperTruck Program - Engine Project Review: https://www.energy.gov/sites/prod/files/2015/06/f23/ace058_singh_2015_o.pdf
 Navistar SuperTruck – Development and Demonstration of a Fuel-Efficient Class 8 Tractor & Trailer Engine Systems: https://www.energy.gov/sites/prod/files/2016/06/f32/ace059_zukouski_2016_o_web.pdf
 Volvo SuperTruck Powertrain Technologies for Efficiency Improvement: https://www.energy.gov/sites/prod/files/2016/06/f32/ace060_amar_2016_o_web.pdf

prototypes to become cost effective and economically viable for mainstream production trucks over a variety of drive cycles through improved aerodynamic, driveline, and accessory efficiencies, materials or manufacturing processes. SuperTruck I results align well with the Ultimate assumptions in the conservative scenario and the Interim assumptions in the aggressive scenario.

Table 9. Class 8 Tractor-Trailer Fuel Economy Assumptions Summary¹

| <i>Class 8 Tractor-Trailer</i> | Baseline | Interim | Ultimate |
|--------------------------------------|-----------------|----------------|-----------------|
| Diesel Conservative [mpgd] | 9.1 | 10.9 | 11.9 |
| Hydrogen Conservative [mpkg / mpdge] | 9.4 / 10.7 | 11.1 / 12.6 | 12.4 / 14.1 |
| Diesel Aggressive [mpgd] | 10.0 | 13.0 | 15.6 |
| Hydrogen Aggressive [mpkg / mpdge] | 10.7 / 12.2 | 14.0 / 15.9 | 17.0 / 19.4 |

¹ Hydrogen-powered trucks are compared to advanced state-of-the-art diesel vehicles, i.e., late model year trucks, with commercially available and cost-effective high efficiency options (primarily aerodynamics package, tires, and driver feedback devices). The national average fuel economy for over-the-road tractor-trailer population is 6.4 mpgd.

5.4.1 Ultimate

With additional but conservative levels of technological progress, it is assumed that at least 12 mpgd can ultimately be achieved with diesel, over a range of relevant duty cycles. It is assumed that with additional aggressive innovations in materials, manufacturing processes, aerodynamic design, reduction in friction, and increased component efficiencies, over 15 mpgd can be cost-effective and achievable in commercial operation (approximately equivalent to the DOE SuperTruck II goal to double freight efficiency compared to a 2009 baseline).

For the conservative case, a 68% fuel cell peak efficiency and 96% electric drive peak efficiency results in an estimated 12 mpkg hydrogen truck fuel economy. For the aggressive case, a 72% fuel cell peak efficiency and 96% electric drive peak efficiency results in over 17 mpkg fuel economy. As shown in Table 8, the fuel cell has a 16% drive cycle efficiency advantage over the diesel system, but this does not include the 1.1 mpkg improvement achieved from regenerative braking. Adding that benefit increases the overall fuel cell fuel economy to 17 mpkg and a 24% advantage over (non-hybrid) diesel trucks. Note that diesel trucks could also benefit from hybridization. As incumbent technologies improve, fuel cell and other advanced technology targets would need to be more aggressive.

5.4.2 Interim

For the conservative case, a 64% fuel cell peak efficiency and 96% electric drive peak efficiency results in an estimated 11 mpkg fuel economy. For the aggressive case, a 72% fuel cell peak efficiency and 96% electric drive peak efficiency results in an estimated 14 mpkg fuel economy. As shown in Table 8, the fuel cell has a 17% drive cycle efficiency advantage over the diesel system but this does not include the 0.6 mpkg improvement achieved from regenerative

braking. Adding that benefit increases the overall fuel cell fuel economy to 14 mpkg and a 22% advantage over (non-hybrid) diesel trucks.

5.5 Hydrogen Long-Haul Truck Range

Table 10. Long-Haul Range for Hydrogen Trucks, Interim and Ultimate Assumptions

| | Status Estimate | Tractor-Trailer Trucks | |
|-----------------------|------------------------|------------------------|------------|
| | | Interim | Ultimate |
| Vehicle Range [miles] | 300¹ | 600 | 750 |

¹ Based on Toyota Project Portal for drayage applications.

Vehicle range assumptions were determined from the daily range requirements of vehicles. They were vetted with feedback from the DOE Fuel Cell Truck Powertrain Workshop. In addition, they are supported by Part 395 of the Federal Motor Carrier Safety Regulations³³ stipulating that a driver may not exceed 11 hours of driving per day and the Freight Facts and Figures from the Federal Highway Administration³⁴ showing that average truck speeds on interstates are generally between 50 and 60 miles per hour (mph) (660 miles driving + 90 mile margin = 750 miles). The average speed required to achieve 750 miles in 11 hours is 68 mph, which is an implied upper limit for average speed.

A range of 750 miles provides 99% of the average daily trucking range needs, estimated from annual mileage reported in the Vehicle Inventory and Use Survey (VIUS) and assuming vehicles are driven 5 out of 7 days (5 “workdays” per week). Table 11 shows the percentage of tractor-trailers in VIUS that travel 250 miles, between 250 and 500 miles, and between 500 and 750 average miles per workday. It is also important to see that although a larger number of trucks are operating with low mileage per year, more mileage is covered by the trucks operating between 250 and 500 miles.

For range we are assuming we refuel once per day for maximum range vehicles. Those that use less range will not need to refuel as often, which is beneficial. Diesels provide far more mileage than can be driven in one day and trucks are often ordered to provide a range of 1,000 to 1,200 miles according to one truck manufacturer. This is driven primarily by flexibility in fueling location so that fuel can be provided “in-house,” with a contract discount, or by a preferred provider. Fuel price discounts can be as high as 15%. Flexibility comes with a higher cost when purchasing hydrogen fuel systems, so the maximum daily range (750 miles) was considered more cost-effective for hydrogen vehicles than providing range as high as 1,200 miles.

³³ Federal Motor Carrier Safety Administration Interstate Truck Driver’s Guide to Hours of Service, March 2015: https://www.fmcsa.dot.gov/sites/fmcsa.dot.gov/files/docs/Drivers%20Guide%20to%20HOS%202015_508.pdf

³⁴ U.S. Department of Transportation, Federal Highway Administration, Office of Freight Management and Operations, Freight Facts and Figures 2010, Figure 3-13 and Table 3-8, https://ops.fhwa.dot.gov/freight/freight_analysis/nat_freight_stats/docs/10factsfigures/index.htm

Considering the current lack of a hydrogen fueling network for trucks, the fueling network for hydrogen trucks could be quite different than diesel.

Table 11. Percentage of Tractor-Trailers and Tractor-Trailer Mileage by Average Mileage per Workday (annual mileage / 260)

| Category | Percentage of Trucks | Percentage of Truck Mileage |
|--------------------------------------|----------------------|-----------------------------|
| Average <250 miles per workday | 60 | 25 |
| Average 250 to 500 miles per workday | 33 | 55 |
| Average 500 to 750 miles per workday | 6 | 17 |

Hotel loads were considered because of their potential impact on vehicle range. Hotel loads require ~12 kWh per day³⁵ (supported by industry feedback at the DOE Fuel Cell Truck Powertrain Workshop), which requires 0.6 kg H₂ assuming 60% conversion efficiency.

The interim tractor-trailer vehicle range assumption, 600 miles, was set to 80% of the ultimate tractor-trailer vehicle range assumption. Six hundred miles is sufficient to meet approximately 98% of the average daily trucking range needs, estimated from annual mileage reported in VIUS (assuming vehicles are driven 5 out of 7 days).

³⁵ DOE SuperTruck Program: Technology and System Level Demonstration of Highly Efficient and Clean, Diesel Powered Class 8 Trucks. David Koeberlain (Cummins) and Kenneth Damon (Peterbilt). 19 June 2014.

6 Conclusion: Simple Cost of Ownership Estimate

A simple cost of ownership (SCO) was estimated to ensure that meeting the technical targets for cost and efficiency would result in an economically viable and commercially competitive truck. Table 12 below shows the results of the SCO. The SCO for advanced hydrogen trucks meeting the Ultimate targets is compared to advanced diesel trucks meeting aggressive powertrain efficiency goals within the same timeframe. Both diesel and hydrogen truck technologies will require significant R&D activities to achieve the Ultimate targets and goals described. With significant R&D, fuel cell cost can be reduced to \$60/kW with 30,000 h durability and 72% peak efficiency, hydrogen storage cost can be reduced to \$266/kg and capable of 5,000 cycles, and dispensed hydrogen cost can be reduced to \$5 per kg (taxed). Diesel trucks with significant R&D could result in improved engine efficiency and waste heat recovery system resulting in 59% thermal efficiency. The SCO shows that hydrogen trucks can be on par with very advanced diesel trucks. As shown by Table 12, the hydrogen truck cost per mile is \$0.03 per mile more than projected advanced diesel trucks if all targets are met.

Table 12. Simple Cost of Ownership Estimate

| Class 8 Long Haul | Diesel Status (2019) | Hydrogen Status (2019) | Diesel Ultimate (2050) | Hydrogen Ultimate (2050) |
|--|----------------------|------------------------|------------------------|--------------------------|
| Fuel Cost (\$/gal diesel or \$/kg H ₂) | 2.78 | 16 | 4.09 | 5.00 |
| Fuel Economy (mpg or mpkg) | 10 | 11 | 15.6 | 17.0 |
| Lifetime Fuel Cost | \$ 278,000 | \$ 1,496,000 | \$ 315,000 | \$ 353,000 |
| Total Tractor Cost | \$ 134,000 | \$ 266,000 | \$ 131,000 | \$ 129,000 |
| Lifetime Fuel and Capital Cost | \$ 412,000 | \$ 1,762,000 | \$ 446,000 | \$482,000 |
| Fuel Cost (\$/mile) | \$ 0.28 | \$ 1.50 | \$ 0.26 | \$ 0.29 |
| Tractor Cost (\$/mile) | \$ 0.13 | \$ 0.27 | \$ 0.11 | \$ 0.11 |
| Maintenance Cost (\$/mile) | \$ 0.17 | \$ 0.25 | \$ 0.17 | \$ 0.17 |
| Total Fuel and Capital Cost (\$/mile) | \$ 0.58 | \$ 2.0 | \$ 0.54 | \$ 0.57 |

- ¹ Targets are used as inputs for SCO calculations to quantify how the targets affect SCO. These simplified SCO calculations only consider upfront capital cost and lifetime fuel cost, but do not consider any financing, change in fuel cost over vehicle life, or tax credits. All costs are in 2018 dollars. All non-powertrain improvements, e.g., aerodynamics, light weighting, driveline, and accessory efficiency are the same between powertrains.
- ² Improvement in fuel economy allows the size and cost of onboard hydrogen storage and fuel cell power to be reduced to 60 kg H₂ and 240 kW for ultimate assumptions. Cost targets are then used to calculate hydrogen storage and fuel cell system costs. Interim and ultimate costs assume commercial production volume (100,000 units/year). A simplified 20% markup is applied across all components.
- ³ Battery cost is assumed to be \$1,500 for Ultimate. Electric motor and power electronics were assumed to be \$4,500 for ultimate assumptions (twice the light-duty vehicle traction motor and power electronics targets of \$6/kW). Vehicle chassis cost is assumed to be \$75,000. The diesel engine baseline with emissions after treatment is assumed to cost \$20,000 for the ultimate assumptions. The transmission is assumed to cost \$8,700, and waste heat recovery system is assumed to be \$5,000 for the ultimate assumption. A simplified 20% markup is applied across all components.
- ⁴ Values for \$/mile are calculated by dividing the total lifetime cost by the vehicle lifetime targets for the vehicle.
- ⁵ Diesel values assume projected values from the EIA 2018 Annual Energy Outlook for diesel fuel cost. For status (2019): fuel cost = \$2.78/gal; for interim (2030): fuel cost = \$3.73/gal; for 2050 (ultimate): fuel cost = \$4.09/gal. Includes Federal and State taxes while excluding county and local taxes.
- ⁶ The cost target for H₂ is \$4/kg, excluding taxes. Accounting for inflation to 2015 and \$0.50 taxes, consistent with other analysis, \$5/kg is used for H₂ dispensed at the pump for the cost of ownership estimate.
- ⁷ Dispensed hydrogen fuel cost is assumed to be \$4/kg-H₂ for ultimate targets based on DOE hydrogen production targets: <https://energy.gov/eere/fuelcells/downloads/fuel-cell-technologies-office-multi-year-research-development-and-22>.

Appendix: Performance of Fuel Cell Systems for Heavy-Duty Trucks: Results from an Initial Study for Life Cycle Analysis for Setting Cost and Efficiency Targets

Scope and Limitations

This study was conducted in 2017 in support of an effort to understand the potential of fuel cells for deployment in light-duty vehicles (LDV). Subsequently, the results were adapted in a preliminary life cycle analysis for setting cost and efficiency targets for fuel cell systems for heavy-duty trucks.

Given the preliminary nature of this study, the results should not be interpreted to define the performance targets for fuel cells for medium and heavy-duty trucks. In particular, there are on-going research efforts to define the limits on operating temperatures and cell voltages required to satisfy thermal management in trucks; durability of membranes and electrodes required to reach 30,000-h or 1M-mile lifetime; and part-load performance to match and exceed the efficiency of diesel trucks at competitive life-cycle costs.

Main Study Assumptions

Pressurized Fuel Cell System (FCS)

- Stack inlet pressure at rated power: 2.5 atm
- Stack coolant exit temperature at rated power: 94°C³⁶

Air Management System

- Centrifugal compressor-expander module
- Parasitic power at rated flow: 7 kW_e net for 662-mV cell voltage

PEMFC Stack

- Alloy cathode catalyst on high surface-area carbon support³⁷: 0.1–0.4 mg/cm² Pt loading ($L_{Pt(c)}$), Pt/C = 0.3,³⁸ I/C = 1.0, 650 A/g_{Pt} mass activity
- Pt anode catalyst (Pt/C), 0.025 mg/cm² Pt loading
- Reinforced PFSA membrane,³⁹ 850 EW with chemical additive, 14-μm thickness, 4.2 mA/cm² crossover current density at 80°C, 100% RH, 1-atm H₂ partial pressure
- Stoichiometry: 1.5 (cathode), 2.0 (anode)
- Relative humidity: 75% at cathode inlet, 84°C, 2.5 atm; 42% at H₂ inlet, 94°C, 2.5 atm

³⁶ 95°C is the currently accepted coolant exit temperature for meeting the heat rejection constraint in light-duty vehicles. It can be higher or lower for medium-duty and heavy-duty truck fuel cell systems and needs to be determined.

³⁷ Ongoing studies are evaluating the merits of Pt vs. Pt-alloy catalysts at high Pt loadings and high surface-area carbon supports for truck lifetime requirements.

³⁸ Catalyst suppliers may opt to raise Pt/C and lower I/C for thick electrodes with >0.25 mg/cm² Pt loading.

³⁹ Thin membranes may not be appropriate for truck durability requirements.

Other Parasitic Losses⁴⁰

- Coolant pump: 500 W_e
- H₂ recirculation pump: 400 W_e
- Radiator fan: 345 W_e

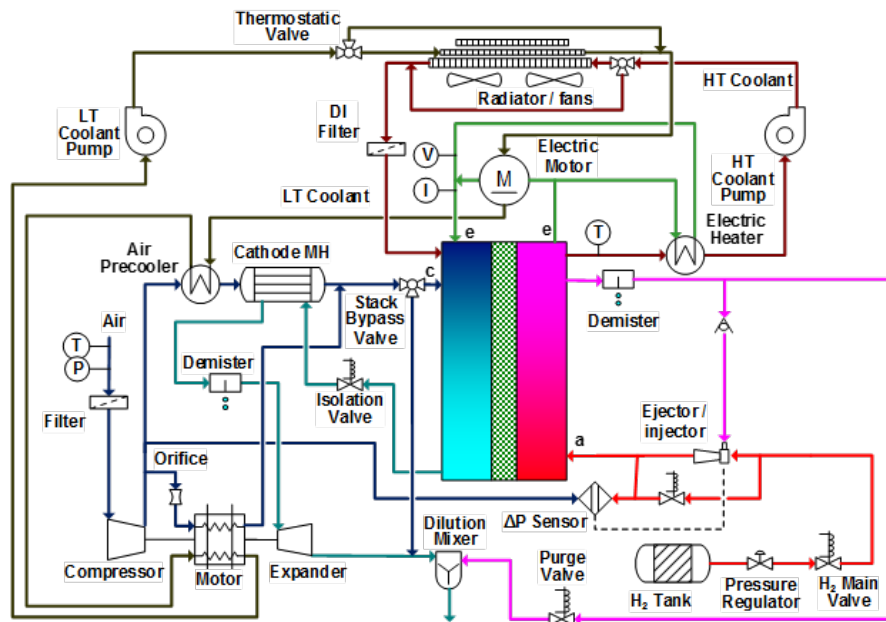

Figure A-1. Argonne 2018 80-kW_e-net FCS reference configuration for light-duty vehicles with passive hydrogen circulation. For this study, multiple LDV systems are combined in one or more modules to produce the desired power for fuel cell trucks and a hybrid fuel system replaces the hydrogen ejector/injector as in Argonne 2017 configuration. In practice, two fuel cell systems may share a single air management system or fuel management system. In addition, a single radiator may serve all the thermal management systems.

⁴⁰ Heavy-duty trucks incur significantly larger parasitic losses than the LDVs. Radiator fans and coolant pumps are sized to reject waste heat during hill climb while towing trailer at specified speeds.

Modeled Power Density

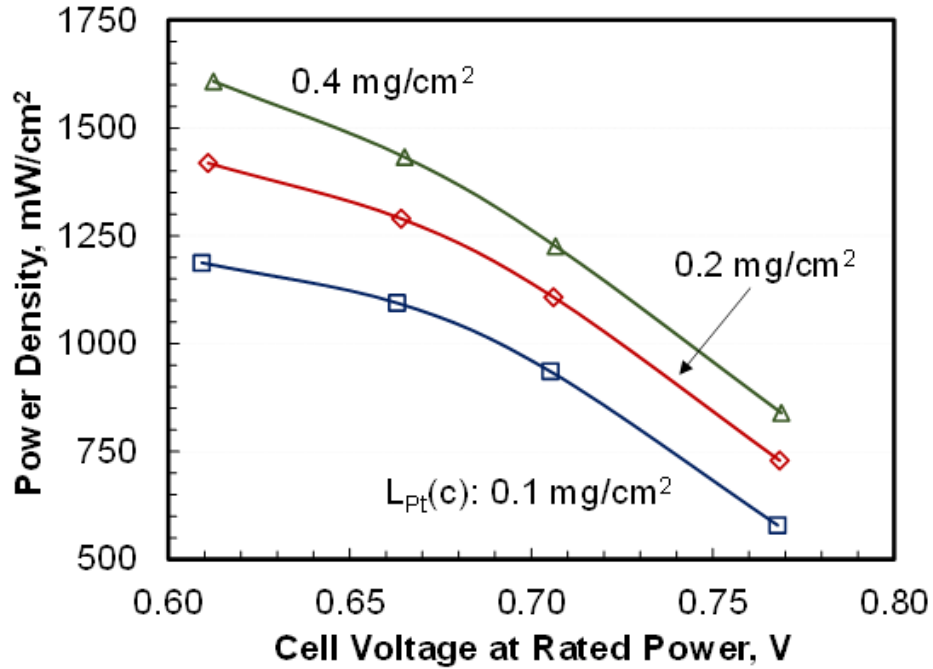

Figure A-2. Modeled stack power density at rated power as function of cell voltage and cathode Pt loading. The stack model is based on differential cell data for de-alloyed Pt-Ni catalyst supported on high surface-area carbon (HSC), see 2016 FC017 AMR proceedings. The results will be revised to reflect higher performance measured with d-PtCo/HSC catalysts as reported in 2019 FC017 AMR proceedings.

Modeled Polarization Curves

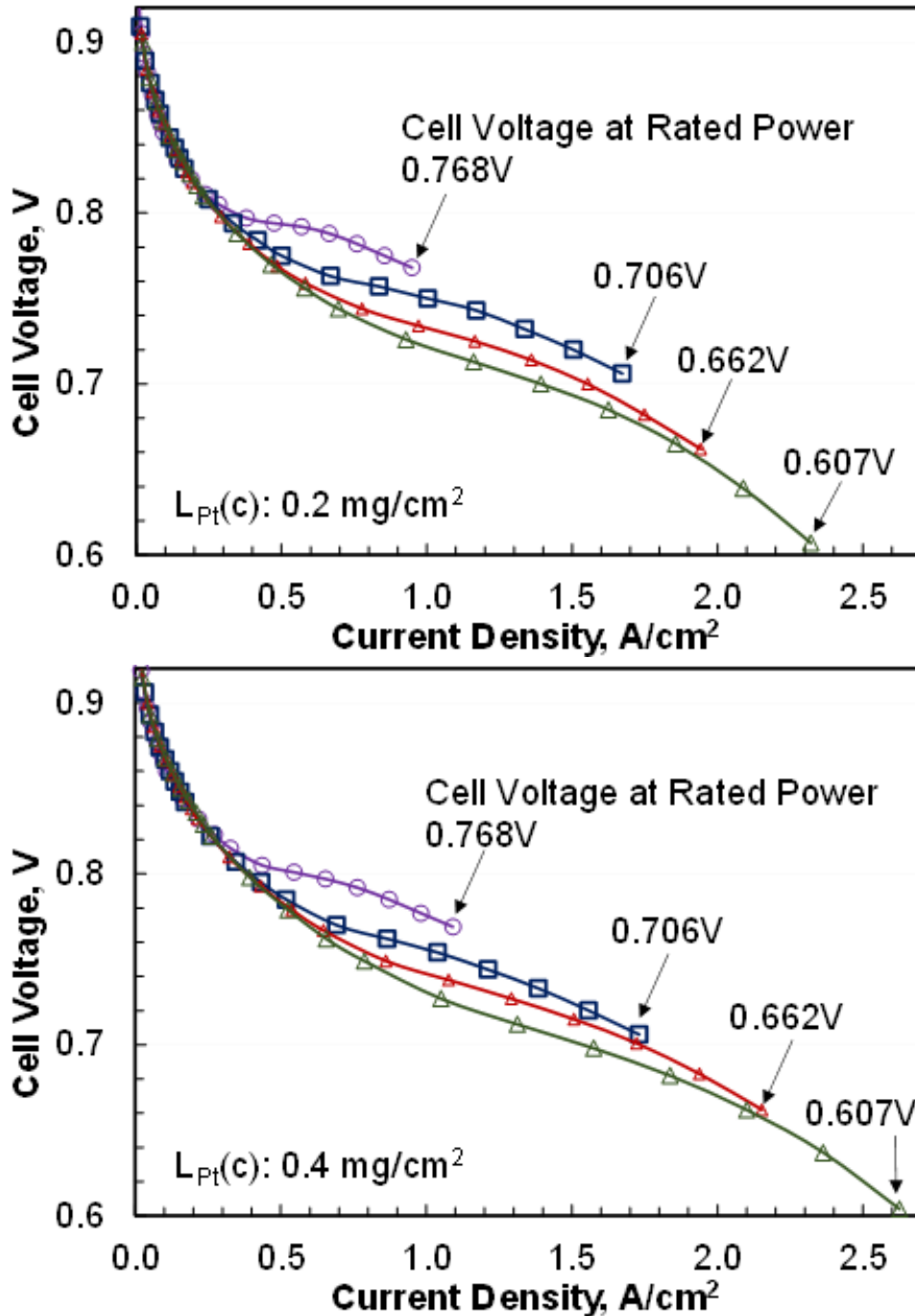

Figure A-3. Modeled stack polarization curves. At rated power, the stack inlet pressure is 2.5 atm, and the coolant temperature rises by 10°C (ΔT_c) to reach 94°C at exit. The stack operating pressure, coolant inlet temperature, inlet H₂ and air relative humidities, and ΔT_c all decrease at lower current densities (i.e., stack power). The local current density in the stack is not constant but varies with position and the average values are plotted on x-axis.

FCS Efficiency Map

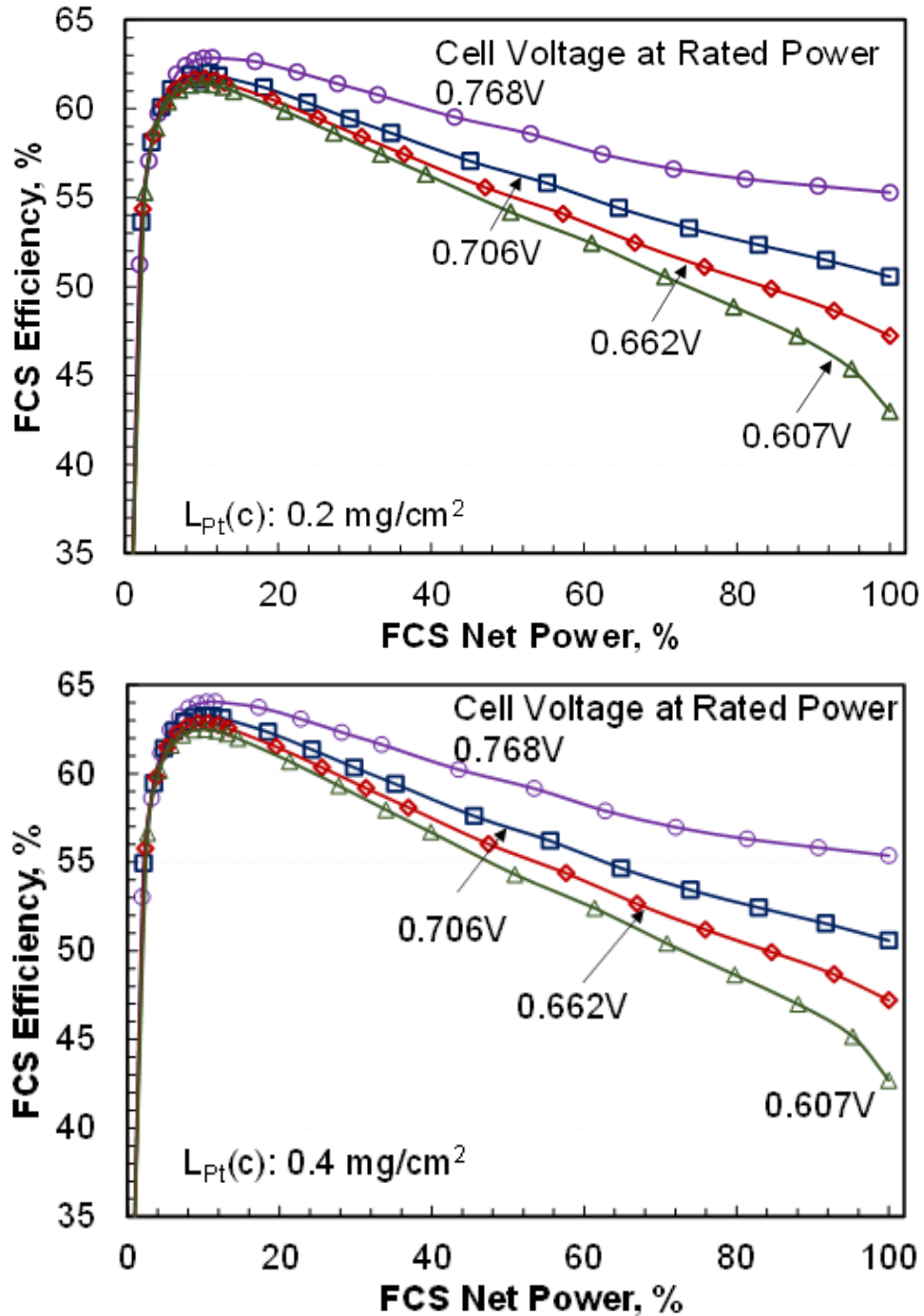

Figure A-4. Modeled steady-state FCS efficiency as function of power. Recent simulations indicate that higher peak efficiencies are achievable by re-optimization of the CEM operating map, stack inlet pressures, and coolant exit temperatures at low power.