

MANUAL No. 99MBE021A
SERIES No. 264

DP-1VR

Digimatic Mini-Processor

User's Manual

In order to obtain the best possible performance from the Mitutoyo
Digimatic Mini-Processor DP-1VR,
read this user's manual thoroughly before operation.
After reading, retain it close at hand for future reference.

Mitutoyo

THE MARKS USED IN USER'S MANUAL

The meaning of symbol mark and contents describe with each symbol mark used in users manual is as follow.

Notice on Safety

In user's manual, to use exactly this unit, and to protect from yours and other peoples damage and property, several chart expression. The expression and meaning are as follows.

- Following expressions shown general notices, cautions and dangers, but not limited.



Neglecting this expression, if you deal with this unit by incorrect way, it will be imminent occurrence of human death or heavy injury.



Neglecting this expression, if you deal this unit by incorrect way, it will be supposed to occur possibility of human death or heavy injury.



Neglecting this expression, if you deal with this unit by incorrect way, it will be supposed to occur possibility of human damage and physical damage.

THE MARKS USED IN USER'S MANUAL

- The following marks show notice, exhibit of action/compulsion



This marks show that there is contents urge the notice (include danger, warning. In the chart, concrete notice meaning is shown (left chart mean electrical shock)



This mark express exhibited action. Concrete exhibited actions are drawn in the charts or near the charts. (left chart means exhibit of disassemble)



This mark express the action under compulsion or direction. Concrete directed actions are drawn in the charts or near the charts. (left chart shows necessity of earth)

THE MARKS USED IN USER'S MANUAL

About several kinds of notice.

Several kinds of "notice" which assist to obtain high reliable measured data show in following words.

-
- Important** ◆ Notice indicates necessary information to achieve the purpose.
Do not neglect this direction.
- ◆ If you do not follow this direction, there are the possibilities to loss or difficult to maintain the performance and accuracy of this unit.
-

Notice This word indicates especially emphasize or supplementary information.

It shows that there are attentions for specified operation (limit of memory, construction of equipment, information concerned with special version of program. etc.)

Reference This word indicates reference information concerned with operating method and procedure described in this manual to apply for particular problem or details explanation of operation and function.

And if there are other reference informations, they may be shown the reference portion

When any damages happen by the method not to depend on this manual, our company does not have any responsibilities.
Contents of this manual may be changed without advance notice.
(c) Copyright Mitutoyo Corporation. All rights reserved.

NOTICE ON SAFETY (PLEASE READ SURELY)

To use safely, you should observe following.



WARNING

-
- ◆ This unit is intended to be used for a general equipment (measuring equipment, or machine tool etc.) Do not use this unit for medical machine, aerospace vehicle, train or atomic power etc. which miss operation of this unit have possibility to injure the human body or treated human life. When you intend to use for such purpose, please inform to our company in advance.
 - ◆ If accidents happen such as smoke, curious smell or abnormal operation, cut power and pullout AC adapter from consent, then inform to service network. If you continue operation, it causes fire or electric shock.
 - ◆ When you drop this unit and it is damaged, cut power and pullout AC adapter from consent, then inform to service network. If you continue operation, it causes fire or electric shock.
 - ◆ Do not repair or modify this unit by user. As it causes fire or electric shock, do not implement absolutely.
 - ◆ When foreign object puts into this unit, cut power and pullout AC adapter from consent, then inform to service network.
-

NOTICE ON SAFETY (PLEASE READ SURELY)



- ◆ Please keep specified power source voltage. When this unit is used with not specified power source voltage. it causes damage of inside, fire or electric shock.
 - ◆ Please do not put this unit at the place opened to direct sunshine or hot temperature. Inner temperature of this unit increases and causes fire.
 - ◆ Do not put this unit close to wall. Inner temperature increases and causes malfunction. And also please put this unit apart about 10 cm from wall as you can pullout the cord of power source without moving this unit.
-

REGARDING TO EC COMMAND CONFORMITY

- ◆ This unit is conformed to following EC Command.
EMC Command EN61326-1997+A1:1998
-

CONTENTS

The marks used in this user's manual	i
Notice on Safety (Please read thoroughly)	iv
WARRANTY	vi
1. OUTLINE	1
1. Introduction	1
2. Features	1
2. SET UP	3
1. Power supply	3
1.1 Setting the battery	3
1.2 Connection of the AC adapter	5
2. Set of recording paper	6
3. Connection of the measuring tool	7
4. Other connection	8
4.1 Attachment of strap	8
4.2 Footswitch	9
4.3 RS-232C Cable • GO±NG judgement cable	9
4. PARAMETER	10
1. Parameter	10
2. In the case of connecting caliper micrometer	10
3. In the case of printout of RS232C linearscale output	12
4. Example of parameters setting	15
4.1 DP-1 parameter setting procedure	15
5. SUMMARY OF FUNCTIONS	19
1. Key functions	19
2. Function of each mode	20
3. Timer input function	21
6. OPERATION	22
1. Power ON/OFF	22
2. Basic Operation 1	23
2.1 Data input, cancel, clear	23

CONTENTS

3. Basic operation 2	25
3.1 Input of tolerance limit data	25
3.2 Confirmation/renew of limit data	27
3.3 Release of limit data	28
3.4 Data input, cancel, clear	29
4. Mode 3	32
5. Print RS232C of counter	34
6. OTHER NOTICES	36
7. MAINTENANCE	37
1. Clean printer head	37
2. Clean paper sensor	37
8. ERROR MESSAGE	39
1. Alarms concerning electric power	39
2. Other alarms	40
9. CALCULATION METHOD	42
1. Significant figure	42
2. Overflow and calculation tolerance	43
3. Calculation tolerance detail	44
4. Calculation formula	45
4.1 Calculation of Mode1, Mode2	45
4.2 Calculation Mode3	46
10. OUTPUT	47
1. Output of GO/±NG Judgment Result	47
2. Output in Accordance with RS-232C Format	47
2.1 Communication Specifications	48
2.2 Data Format	48
2.3 Error Code	49
2.4 Data request command	49
11. TROUBLESHOOTING	50
12. SPECIFICATIONS	52
SERVICE NETWORK	54

1 OUTLINE

1. Introduction

DV-1VR is an exclusive piece of data processing equipment that records data from a Mitutoyo digimatic tool so it can be statistically processed operation is easy and statistical results can be obtained quickly.

2. Features

- (1) Abundant statistical parameters:
Number of samples (N) • Maximum value (MAX) • Minimum value (MIN) • Range (R) • Mean value (\bar{X}) • Standard deviation (σ -n, σ n-1) • Process capability index (Cp, Cpk) • Number of defects (\pm NG) • Percent defective (P)
Limit data 5 types
- (2) Preparation of histogram
- (3) Preparation of a chart of displacement that expresses the time history of measured data D (Displacement).
- (4) Several calculation functions necessary to prepare the \bar{X} -R control chart.
- (5) Timer input function.
- (6) Data output function.
Output of measured data (RS-232C, TTL Level)
Output result of success or failure (+NG, GO, -NG)
It can be connected to Mitutoyo Instrument Network System (μ NET System)
- (7) Output of success or failure by LED.
- (8) Power source system of AC adapter or four AA type Nickel Hydrogen batteries (Ni-MH)/Alkali batteries (LR6)
- (9) Standard equipment of 48 m recording paper.

OUTLINE

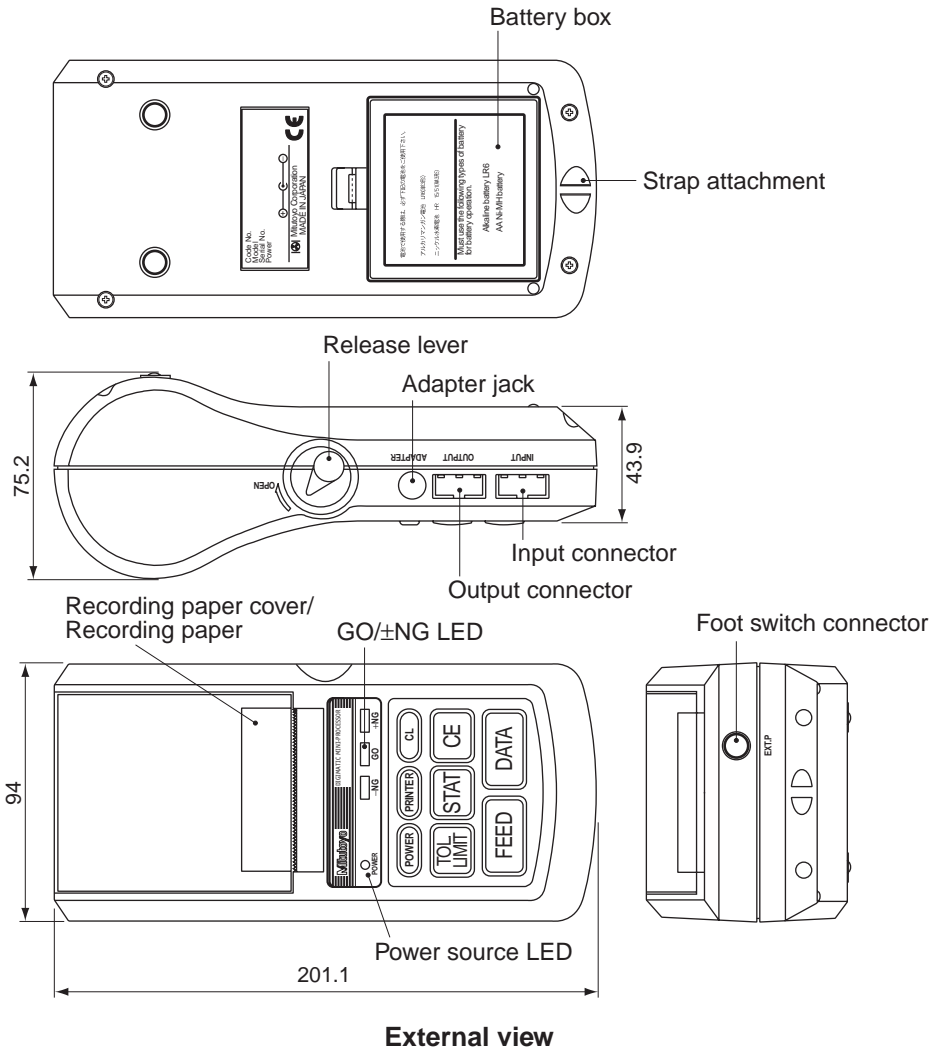

Parts List

Parts name	Quantity
DP-1VR (Main unit)	1
AC adapter	1
Recording paper	1
Strap	1
Quick reference	1
User's manual	1

2 SET UP

1. Power supply

- Power is supplied to this unit by the AC adapter or four AA type Nickel Hydrogen batteries (Ni-Mh)/Alkali batteries (LR6)
- When the AC adapter is used while batteries installed, the power will be supplied from the AC adapter (batteries are not included). The AC adapter cannot charge the batteries, charge them with a dedicated battery charger, if necessary.
- When a voltage drop occurs when using the battery or AC adapter, the power source LED will blink and show an abnormal condition.

1.1 Setting the battery

Set the batteries. If using the AC adapter, refer to section 1.2

- q **Open the battery box.**

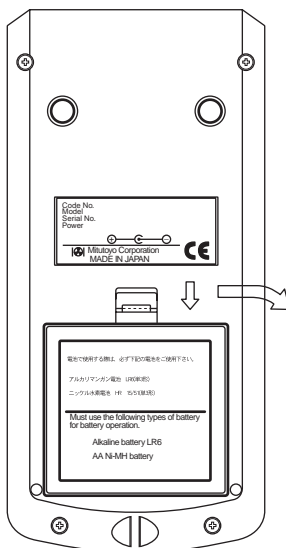

Push down the stopper of the battery box and pull forward.

SET UP

w Set the batteries.

Be sure to set correctly the poles of the size AA Alkali batteries (LR6) or Nickel Hydrogen batteries (Ni -MH AA)

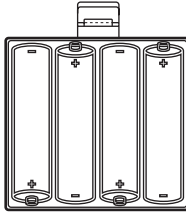

- e Close the battery box by the inverse process of q firmly until you hear the clicking sound.

IMPORTANT

- ◆ Set the poles of batteries correctly.
 - ◆ Do not use different kinds of batteries.
 - ◆ Use either size AA Alkali batteries (LR6) or AA Nickel Hydrogen batteries (Ni-MH AA)
 - ◆ Manganese batteries R6 cannot be used.
 - ◆ When Alkali batteries are used, printed letters may fade accordingly.
 - ◆ When Alkali batteries or Nickel Hydrogen batteries are used, print speed is slower compared with the AC adapter.
 - ◆ In the case of using batteries, if the surface shows peeling or breaks on the pole of the battery, it may cause poor contact and start-up. Please use batteries only after you check there is no peeling or surface breaks on the poles of batteries.
 - ◆ If DP-1VR is not used for a long period, please remove the batteries from DP-1VR. If the batteries remain connected to the DP-1VR for long time, fluid leakage may damage the DP-1VR.
 - ◆ The operational temperature of the batteries must remain over 10°C. If the temperature is less than 10°C, undesirable things, such as printed letters become thin, etc., may occur.
-

NOTE

- ◆ DP-1VR has no charger function. If you need to charge the batteries, a dedicated battery charger is needed.
 - ◆ Battery life is about 10,000 lines, (using 1,600 m Ah Ni-MH, and print large, letter one time per 5 sec.)
 - ◆ Battery life varies drastically in accordance with environmental conditions.
-

1.2 Connection of the AC adapter

Connect the AC adapter to the DP-1VR.

Skip this page when using batteries.

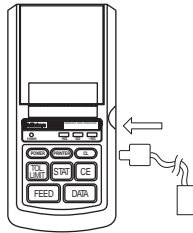

Insert firmly all the way.



- ◆ The AC adapter specified by our company should be used.

100/115V 09EAA088

230V 09EAA088D

230V UK 09EAA088E

- ◆ If the specified AC adapters are not used, print quality and life expectancy will be reduced.
-

SET UP

2. Set of recording paper

q

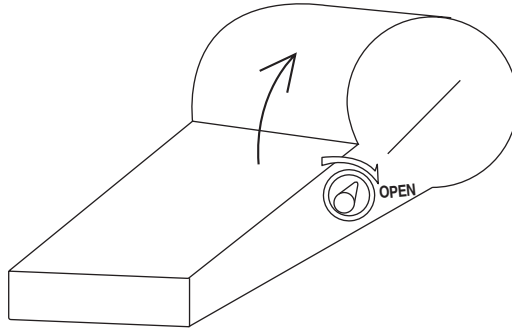

- Push the release lever downward
- Move the cover of recording paper upward, then open it.

w

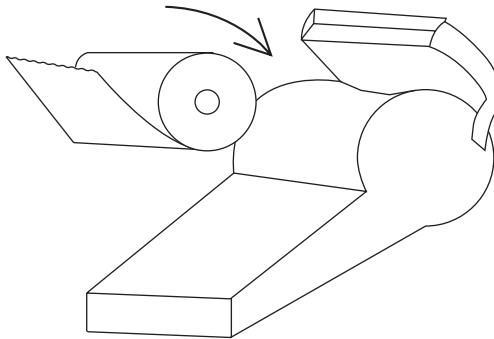

- Peel tape fixing the edge of record paper, then set the recording paper with a little bit of the paper pulled out.
- Set the core of the recording paper firmly in the holder. If the recording paper is wrinkled, it can cause the paper to jam while printing, so be sure it is straight.
- Close the cover of the recording paper, pulling out the edge the recording paper a little bit.
- Press the 'power' key to power ON and press the 'FEED' key, to send out the recording paper about 100 mm.



- When paper is set, be careful not to injure your hand by the paper cutter.

IMPORTANT

- ◆ After setting the recording paper, be sure to press the 'FEED' key. This will perform a self-alignment thereby reducing paper jamming.
- ◆ When you open the recording paper cover, the printer head is exposed. Immediately after printing, the printer head is hot. Do not touch to avoid being burned.
- ◆ DP-1VR recording paper has superior characteristic of conservation, tolerance to chemicals and weather-proof. Please use the recording paper specified by our company. (Part No. 09EAA082 10 roll pack)
- ◆ Print quality is not guaranteed if the specified recording paper is not used.
- ◆ Recording paper should be stored in a cool and dark place.

3. Connection of the measuring tool

Before connection, confirm that electric power to the digimatic measuring tool is OFF.

(1) Connection to the digimatic measuring tool.

Connect one connector of the connecting cable to DP-1VR input connector and the other connector to the output connector of the digimatic measuring tool. Some connecting cables are different, depending on the type of measuring tool, please refer to each user's manual.

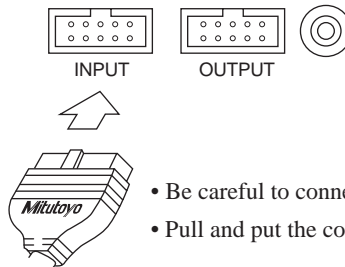

Connection of the input connector

SET UP

4. Other connection

4.1 Attachment of the strap

Attach the strap to the DP-1VR as necessary

- q Take the sling off the hook.
- w Press the sling through the attachment point of the DP-1 as shown in the figure.

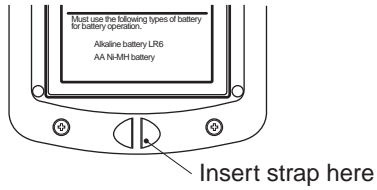

Sling

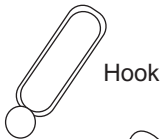

Hook

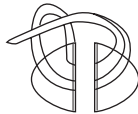

- e Hang the hook on the ring and pull out.

4.2 Footswitch

Data can be input by a foot switch.

Connect to a foot switch connector, part No. 937179T (optional accessory)



4.3 RS-232C Cable • GO±NG judgement cable

q **RS-232C cable (part No. 09EAA084)**

RS-232C output can be obtained from DP-1VR and used for printing RS-232C, output of a linear scale counter. Connect the RS-232C cable to the DP-1VR output connector.

w **GO±NG judgement cable (part No. 965516)**

The results of a judgment can be obtained from the DP-1VR. Connect it to output connector of the DP-1VR.

NOTICE

The RS-232C cable and GO±NG judgement cable can not be used simultaneously.
Be sure to connect / disconnect the cables only when the power is OFF.

3 *PARAMETER*

1. *Parameter*

Parameter functions can customize the actions of the DP-IVR. Set up in accordance with the purpose.

There are two kinds of parameter settings in accordance with connecting measuring equipment to DP-IVR.

Select parameters in accordance with the measuring equipment used.

2. *In the case of connecting calipers or micrometers*

Parameters are established for digimatic interfaces such as calipers or micrometers when connected to DP-IVR.

Start parameter setting mode by pushing the 'DATA' key and 'POWER' key simultaneously.

After parameter mode is started, parameters are printed in order. When you want to change a setting, push the 'STAT' key and when you don't want to change a setting, push the 'DATA' key; then the parameter will be set.

Next, a table of parameters is shown.

PARAMETER

Table 1 Parameter in DP-1 MODE

Order	Item	Setting	Printer operation	Default
1	PARAMETER CLEAR	Parameter clear	PARAMETER CLEAR PARAMETER NO CLEAR	Do not clear parameters
2	SYSTEM MODE	DP-1 mode/Multi	Set DP-1 mode	DP-1
3	WORK MODE	MODE0/MODE1/ MODE2/MODE3	MODE0/MODE1 MODE2/MODE3	Mode1
4	BAUD RATE	1200/2400/4800/ 9600/19200	1200/2400/4800 9600/19200	4800
5	PARITY	None/Even/Odd	NON/EVEN/ODD	EVEN
6	DATA LENGTH	7/8	7/8	7
7	PRINT SIZE	Large/Normal	LARGE/NORMAL	LARGE When mode2 is set only normal printing size is available
8	POWER SAVE	Power save/Normal	SAVE/NORMAL	Normal
9	PRINT DENSITY	Normal/Dark	NORMAL/DARK	Normal
10	BZ MODE	BZ mode ON/OFF	ON/OFF	ON
11	TIME PRINT	TIME PRINT ON/OFF	ON/OFF	
12	DATA FORMAT	DATE FORMAT	YYYY/MM/DD MMM/DD/YYY DD/MMM/YYY	YYYY/MM/DD
13	DATA	DATE SETTING	e.g. When printing Jan. 2, 2000 using data format setting defined in 12. 2000/1 /2 JAN/ 2 /2000 2 /JAN /2000	Japan Standard Time
14	TIME	TIME SETTING		Japan Standard Time
15	UNIT	Automatic (mm/inch) Millimeter Inch None Gram Centigrade Ton Ounce	mm/inch mm inch g ° C t Lb.	Automatic

PARAMETER

IMPORTANT

- ◆ Set DP-1 for action mode.
-

NOTE

- ◆ When entered into parameter input mode, limit data is cleared.
 - ◆ When parameters are cleared, they are set to default, except the date and time. Date and time are reset to 2001/1/1, 0:0.
 - ◆ If a unit setting is selected, the unit set by this parameter is printed, regardless of the unit of the input data. In this case the unit information of input data is neglected.
-

3. *Printout of a RS232C linearscale output*

The following explains the parameter setting when the RS232C interface is attached to the linear scale and printed by the DP-1VR.

To start parameter setting mode: Simultaneously press 'DATA' key and 'POWER' key.

After parameter mode is started, setting parameters are printed in order. When you want to change a setting, press 'STAT' key and when you don't want to change the setting, push 'DATA' key, then the parameter will be set.

Next, a table of parameters is shown.

PARAMETER

Table 2 Parameter in printing RS232CS output of counter

Order	Item	Setting	Printer operation	Default
1	PARAMETER CLEAR	Parameter clear	PARAMETER CLEAR PARAMETER NO CLEAR	Do not clear parameters
2	SYSTEM MODE	DP-1 mode/Multi	Set in MP mode	DP-1
3	WORK MODE	MODE0/MODE1	MODE0/MODE1	Mode1
4	BAUD RATE	1200/2400/4800/ 9600/19200	1200/2400/4800 9600/19200	4800
5	PARITY	None/Even/Odd	NON/EVEN/ODD	EVEN
6	DATA LENGHT	7	7/8	7
7	PRINT SIZE	Large/Normal	LARGE/NORMAL	Large
8	POWER SAVE	Power save/Normal	SAVE/NORMAL	Normal
9	PRINT DENSITY	Normal/Dark	NORMAL/DARK	Normal
10	BZ MODE	BZ mode ON/OFF	ON/OFF	ON
11	TIME PRINT	TIME PRINT ON/OFF	ON/OFF	
12	DATA FORMAT	DATE FORMAT	YYYY/MM/DD MM/DD/YYYY DD/MM/YYYY	YYYY/MM/DD
13	DATA	DATE SETTING	e.g. When printing Jan. 2, 2000 using data format setting defined in 12. 2000/1 /2 JAN/ 2 /2000 2 /JAN /2000	Japanese Standard Time
14	TIME	TIME Setting		Japanese Standard Time
15	UNIT	Millimeter Inch None Gram Centigrade Ton Ounce	mm inch g ° C t Lb.	N/A
16	INPUT AXIS	Set axis to data input	X Y Z	X axis/Y axis/ Z axis
17	CUL AXIS	Set axis of data processing	X Y Z	X axis

PARAMETER

IMPORTANT

- ◆ Set MP in action mode.
 - ◆ Even if you do not perform statistical calculations, data processing axis should still be set.
-

NOTE

- ◆ If the parameter is cleared, it is set to the default, except date and time.
 - ◆ If the parameter is cleared, date and time is reset to 2001/1/1, 0:0
 - ◆ Unit information is not sent out from the linear scale counter. So, if the unit is not set, the unit is not printed in the data.
 - ◆ It's possible to connect with K series counter only.
-

4. Example of parameter settings

Procedure to correctly set parameters is shown.

4.1 DP-1 parameter setting procedure

By entering the parameter mode, parameters can be set. To enter the parameter setting mode when the electrical power is OFF, simultaneously press 'DATA' key and 'POWER' key. Then, the unit will enter the parameter mode.

In the parameter input mode, the following key operations can change setting details.

Parameter setting key	Time setting
<input type="button" value="STAT"/> Setting change	<input type="button" value="PRINTER"/> Increase time
<input type="button" value="DATA"/> Set	<input type="button" value="CL"/> Minutes increase
	<input type="button" value="STAT"/> Prints time
	<input type="button" value="DATA"/> Sets time
Date setting	
<input type="button" value="PRINTER"/> Year increase	
<input type="button" value="CL"/> Month increase	
<input type="button" value="CE"/> Day increase	
<input type="button" value="STAT"/> Prints date	
<input type="button" value="DATA"/> Sets Date	

Additional settings

- Parameter clear
- Letter size
- Date
- Time

Examples of settings are shown on the following pages.

PARAMETER

Table 3 Example of parameter setting procedure

Key operation	Print	Comments
'DATA' + 'POWER' starting	PARAMETER SETUP MODE SYSTEM MODE : DP-1 WORK MODE : MODE1 BAUDRATE : 4800 PARITY : EVEN DATA LENGTH : 7 PRINT SIZE : LARGE POWER SAVE : NORMAL PRINT DENSITY : NORMAL BUZZER MODE : ON TIME PRINT : ON DATE FORMAT : YYYY/MM/DD DATE : 2000/ 1/ 1 TIME : 10:10 UNIT : AUTO PUSH DATA : DATA FIX & GO PUSH STAT : DATA CHANGE PARAMETER NO CLEAR	Print the current setup in parameter setting mode. Print all parameters.
STAT	PARAMETER CLEAR	
DATA	PARAMETER CLEAR SYSTEM MODE : DP-1	If selecting clear, a buzzer sounds 4 times.
DATA	MODE : MODE1	
DATA	BAUDRATE : 4800	
DATA	PARITY : EVEN	
DATA	DATA LENGTH : 7	
DATA	PRINT SIZE : LARGE	If mode 2 is chosen, 'NORMAL' is selected and this item can not be input.
STAT	PRINT SIZE : NORMAL	Letter size can be changed by the 'STAT' key.
DATA	POWER SAVE : NORMAL	Set by the 'DATA' key
DATA	PRINT DENSITY : NORMAL	
DATA	BUZZER : ON	
DATA	TIME PRINT : ON	

PARAMETER

Key operation	Print	Comments
DATA	CE : DAY CL : MONTH PRINTER : YEAR PUSH EACH KEY TO INCREMENT DATE 2001/1/1	Change last 2 digits.
CE	'CE' key increments date Rotate 1~31	
CL	'CL' key increments month Rotate 1~12	
PRINTER	'PRINTER' key increment change by rotating 00~20	
STAT	'STAT' key print date setting is not printed by 'CE' 'CL' 'PRINTER' key operations	
DATA	Finish setting by the 'DATA' key YYYY/MM/DD : 2001/2/2 CL : MIN PRINTER : HOUR PUSH EACH KEY TO INCREMENT TIME 11:11	
CL	'CL' key increments minute Rotate 0~59	
PRINTER	'PRINTER' key increments time Rotate 0~23	Seconds are fixed at 0.
STAT	'STAT' key print time setting is not printed by 'CL' 'PRINTER' keys HH:MM:SS 11:11: 0	
DATA	Finish setting by the 'DATA' key HH:MM:SS 11:11: 0 UNIT : AUTO	Date and time is set and written by the 'DATA' key. In this case, second setting is 0.

PARAMETER

Key operation	Print	Comments
DATA	SYSTEM MODE : DP-1 WORK MODE : MODE1 BAUDRATE : 4800 PARITY : EVEN DATA LENGTH : 7 PRINT SIZE : NORMAL POWER SAVE : NORMAL PRINT DENSITY : NORMAL BUZZER : ON TIME PRINT : ON DATA FORMAT : YYYY/MM/DD DATE 2001/2/2 TIME 11:11 UNIT : AUTO	Printed summary of set parameters

IMPORTANT

- ◆ Parameter input is memorized through the last operation. Do not stop the operation if not completed.
 - ◆ Setting the date and time is written when the time input is set.
 - ◆ Appropriateness of data and time is not checked. Input normal value. Ex: February 30th is incorrect.
 - ◆ Leap years and length of months are calculated automatically.
 - ◆ Clock is stopped during the parameter setting. When you set other parameters, you should set the time too.
 - ◆ Set time in the 24-hour system.
-

NOTICE

- ◆ After input is finished, it is transferred to the data input mode.
-

4 SUMMARY OF FUNCTIONS

1. Key functions

Key	Function			
	Mode 0	Mode1, 2	Mode3	
			During Subgroup measuring	After subgroup measuring is complete
CL (clear key)	● Clears only measured data. (settings remain) push firmly in advance to set limits		● Re-input from No.1	● Clears only measured data (settings remain)
CE (cancel key)	● Deletes measured data just before input		● Cancels measured data just before input	● Deletes subgroup just before finished input
TOL.LIMIT (limit key)	● Press this key when you enter into or exit from the setting operation of upper and lower limits.		● Finish measure of subgroup and calculate X, R and print result	
STAT (stat key)	● No action	● Statistical mode with all data printout calculated result and make histogram	● Calculates and prints out the X-bar and R values then completes the measurement mode and enters the calculation mode	● For the Subgroups whose data input has been completed, calculation of the control limits is carried out and the results are printed.
FEED (feed key)	● When pressed, recording paper is fed out			
DATA (data key)	● Data is input from measuring equipment			
PRINTER ON/OFF (printer on/off key)	● Printer is turned ON/OFF by this switch			
POWER (power key)	● ON/OFF of the electric power			

NOTICE

- ◆ Sample size is determined by 'STAT' of subgroup 1 'STAT' of subgroup 2 and following are effective when data of sample 2 option is input.

SUMMARY OF FUNCTION

2. Function of each mode

Mode 0	Mode 1	Mode 2	Mode 3
<p>● Function</p> <p>To print measured data, and judge tolerance.</p>	<p>● Function</p> <p>To print measured data, judge tolerance, perform statistical calculations, and generate histogram.</p>	<p>● Function</p> <p>To print D-chart (graph that visibly shows the variation of measured data), perform statistical calculations, and generate histogram.</p>	<p>● Function</p> <p>By entering data, it will calculate and draw a R-control chart.</p>
<p>a) Limit setting</p> <p>① If you record judgment limits and prepare a histogram, push 'TOL.LIMIT' key. If you do not, go to measure.</p> <p>② Limit data can be stored in groups of 5. Limit data No. can be changed by pushing the 'STAT' key</p> <p>③ To express upper or lower limit the on the measuring equipment, push 'DATA' key.</p> <p>④ To select another limit value simultaneously on the measuring equipment, push the 'DATA' key.</p> <p>⑤ Set by pushing the 'TOL.LIMIT' key.</p>			<p>a) Subgroup measurement can be conducted by pushing the 'TOL.LIMIT' key</p> <p>MAX of 9999 can be input a subgroup.</p> <p>Sample size of a subgroup is 2~10.</p>
<p>b) Measurement</p> <p>By the 'DATA' key, timer input a or, data the request commands from the RS-232C input, foot switch and data output switch of measuring equipment, and measured data are recorded.</p> <p>GO±,</p> <p>▲over upper limit</p> <p>▼under lower limit</p>	<p>b) Measurement</p> <p>By the 'DATA' key, timer input, data request commands from the RS-232C input, measured data and D chart are recorded.</p> <p>At the same time, judges acceptance or rejection and expresses the following judgment output.</p> <p>▶over upper limit</p> <p>◀under lower limit</p>	<p>b) Measurement</p> <p>By the 'DATA' key, timer input, data request commands from the RS-232C input, foot switch and data output switch of measurement equipment, and measured data are recorded.</p>	
<p>c) Statistical calculation not conducted.</p>	<p>c) Statistical calculation</p> <p>Statistical calculation is conducted for measured data up to that time by the 'STAT' key, and records calculated results and histogram.</p>		<p>c) Calculation management</p> <p>① Push 'STAT' key one time, then the \bar{X}, R, calculation of that group is printed.</p> <p>② Push one more time and each control limit value is calculated with data up to that time and printed.</p>

3. *Timer input function*

This function is used when you intend to take in data automatically from measuring equipment in the same interval.

Press the PRINTER ON/OFF key, and at this state pushing the PRINTER ON/OFF key enters the unit to this function, and the following pressed key can set the interval time. When you finish this function, press the PRINTER ON/OFF key, while pressing the 'CL' key.

NOTE

1. 'CL' 'CE' 'STAT' keys fulfill their functions even if taking in data by the interval timer.
 2. When the interval timer is finished, if data is stored in the buffer, that data may be printed.
 3. During data input by the interval timer, if you intend to change the interval time, finish this mode once, clear data and reset.
-

- Each key and interval times are as follows.

Key	Interval time
STAT	0.25 sec
TOL.LIMIT	1 sec
CE	5 sec
CL	30 sec
DATA	1 sec
FEED	30 minute
PRINTER ON/OFF	60 minute

NOTE

- ◆ Setting 0.25 sec, 1 sec, only statistical calculation results can be printed. Measured data can not be printed. Also, when using 0.25 sec., the data buzzer will not sound.
-

5 OPERATION

1. Power ON/OFF

Operation of power ON/OFF.

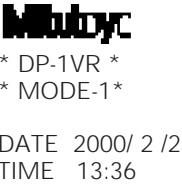
Operation	Key	Print
Power ON	POWER	 * DP-1VR * * MODE-1* DATE 2000/ 2 /2 TIME 13:36
Power OFF	POWER Press more than 2 sec. and release.	

NOTE

- ◆ To prevent mis-operation, power can be cut only when the 'POWER' key is pressed more than 2 sec. Note that the power can not be cut if the pushing time is short.
 - ◆ Contents of printout are a little different in the case of using extended letter size from that of the standard letter size.
-

2. Basic Operation 1

Basic operations that do not have set limits are shown.

Similar operations are conducted in Mode0, Mode1, Mode2 also.

2.1 Data input, cancel, clear

Function	Operation	Print
● Power ON	POWER	POWER * DP-1VR * * MODE 1 * DATE 2000/ 2/ 2 TIME 13: 35
● Data input Data can be input with the foot switch interval timer or the 'DATA' key	DATA DATA	Take data from the measuring tool and print. 1 12.23 mm 2 26.25 mm
● Data cancel Cancel previous input data.	CE	* CANCEL *
● Data all clear Clear all input data	CL	* CLEAR *
● Time printing Print date and time	PRINTER ON/OFF + DATA	DATE 2000/ 2/ 2 TIME 13:36
● Statistical calculation Statistically calculates input data. (This function is not available in mode 0)	STAT	PART NO. ----- DATE 2000/ 2/ 2 TIME 13: 35 ----- NAME: ----- *RESULT* N 56 MAX 81.26 mm MIN 25.66 mm R 55.60 mm X 54.23 mm σ_n 12.5635 mm σ_{n-1} 13.5897 mm

OPERATION

IMPORTANT

- ◆ Recording paper of DP-1 is superior to characteristics of conservation and tolerance to chemicals, but it shares limits with other thermal papers. In the case of long storage (more than 5 years), or if used for public documents, you should make a photocopy.
 - ◆ If cutting fluid comes in contact with the recording paper, and those documents will be stored for a long time, it is recommended to photocopy.
 - ◆ In the case of mode 0
Statistical calculation can not be conducted.
Maximum data that can be handled: 100000
 - ◆ In the case of mode 1
Maximum data that can be handled: 9999.
When 9999 data is input, statistical calculations are conducted automatically.
 - ◆ In the case of mode 2
Maximum data that can be handled: 9999.
When 9999 data is input, statistical calculations are conducted automatically.
Print type is same to mode1.
 - ◆ If the time print parameter is OFF, date and time will not be printed.
-

3. Basic operation 2

Operation procedures when tolerance limits are set is shown. Similar operations are conducted in mode 0, mode 1 and mode 2.

3.1 Input of tolerance limit data

Operation to input limit data. Data is input through the connection of the measuring equipment to the DP-1VR.

<p>● Power ON</p>	<p>POWER</p>	<p>MIUBYC * DP-1VR * * MODE 1* DATE 2000/ 2/ 2 TIME 13: 35 *LIMIT DATA 1* LSL 12.56 mm USL 25.89 mm TOL 13.33 mm</p>
<p>● Tolerance limit input mode Tolerance limit input mode can be entered the 'TOL.LIMIT' key. Limit number can be changed from 5 by the 'STAT' key.</p>	<p>TOL.LIMIT STAT</p>	<p>*LIMIT MODE* *LIMIT DATA 1* *NO LIMIT DATA* *LIMIT DATA 2* LSL 12.56 mm USL 25.89 mm TOL 13.33 mm</p>
<p>● Input of limit data After setting the upper and lower limit for calipers, etc., press the 'DATA' key Input order of the upper or lower limit are performed in either order. Data is recorded by the 'TOL.LIMIT' key.</p>	<p>DATA DATA TOL.LIMIT Finish setting limits</p>	<p>LMT1 15.12 mm LMT2 16.36 mm *NEW LIMIT DATA* *LIMIT DATA 2* DATE 2000/ 2/ 2 TIME 13: 35 LSL 5.12 mm USL 16.36 mm TOL 1.19 mm</p>

OPERATION

NOTE

- ◆ To enter the tolerance limit input mode, q it is necessary that data is not input just after power on, or w all data is cleared by operation of the 'CL' key.
 - ◆ In limit mode, limit data can be changed by operation of the 'STAT' key. Maximum limit data of 5 is recorded. Reset limit data as necessary.
 - ◆ When limit data is input by selecting the number of limit data already set, new data is saved and old data removed.
 - ◆ Limit data remains in memory even if the power is cut.
 - ◆ Just after power ON, limit data used at the time of power cut are selected.
 - ◆ When tolerance limit data is not necessary (when limit judgment is not needed), select the limit number without limit data (refer to 3.2), or delete the set limit data (refer to 3.3).
-

3.2 Confirmation/reset of the limit data

The operation of confirming contents of 5 of tolerance limit data and resetting tolerance limit data to use.



<p>● Confirmation and reset of limit data. If limit data is not input or it is cleared by the 'CL' key, the operation is possible.</p>	TOL.LIMIT	LIMIT MODE* *LIMIT DATA 2* LSL 12.36 mm USL 25.67 mm TOL 13.31 mm
<p>Tolerance limit data is renewed by 'STAT'.</p>	STAT	*LIMIT DATA 3* LSL 12.56 mm USL 25.89 mm TOL 13.33 mm
<p>Press the 'TOL.LIMIT' key, for the required tolerance limit data. Renewed limit data is obtained.</p>	STAT	*LIMIT DATA 4* * NO LIMIT DATA *
<p>Press the 'TOL.LIMIT' key, for the required tolerance limit data. Renewed limit data is obtained.</p>	STAT	*LIMIT DATA 5* LSL 12.36 mm USL 25.67 mm TOL 13.31 mm
<p>Press the 'TOL.LIMIT' key, for the required tolerance limit data. Renewed limit data is obtained.</p>	TOL.LIMIT	*NEW LIMIT DATA* *LIMIT DATA 5* DATE 2000/ 2/ 2 TIME 13: 35 LSL 12.36 mm USL 25.67 mm TOL 13.31 mm

3.4 Data input, cancel, clear

Table 2 DP1 mode1, operation example 2

Function	Operation	Print
● Power ON	POWER	<div style="background-color: black; color: black; display: inline-block; width: 100px; height: 1em; margin-bottom: 5px;"></div> * DP-1VR * * MODE 1* DATE 2000/ 2/ 2 TIME 13: 35 *LIMIT DATA 1* LSL 12.36 mm USL 25.67 mm TOL 13.31 mm
● Time print	PRINTER ON/OFF + DATA	DATE 2000/ 2/ 2 TIME 13: 35
● Data cancel Prior input is canceled.	CE	* CANCEL *
● Data input All input data is cleared.	CL	* CLEAR *
● Data input Limit judgment is conducted for the input data, displayed (LED) and printed.	DATA DATA DATA	H 1 12.00 mm 2 26.25 mm G 3 32.56 mm

Input data, and relationship of display (LED) and print.

Input	Input data < Lower limit value	Lower limit value ≤ Input data ≤ Upper limit value	Upper limit value < Input data
Display (LED)	 -NG GO +NG	 -NG GO +NG	 -NG GO +NG
Print	▼		▲

OPERATION

Input data

Function	Operation	Print
Statistical calculation ● Statistical calculations are conducted, when 9999 or more data is input.	STAT	<hr/> PART NO. <hr/> DATE 2000/ 2/ 2 TIME 13: 35 <hr/> NAME <hr/> *RESULT* N 56 MAX 81.26 mm MIN 25.66 mm R 55.60 mm \bar{X} 54.23 mm σ 12.5635 mm σ_{n-1} 13.5897 mm -NG 2 +NG 4 P 18.56% Cp 0.45670 Cpk 0.30000 *HISTOGRAM* LSL 12.36 mm USL 25.67 mm TOL 13.31 mm DIV 10 -NG 2 LSL N N N N N N N N N A 2 B 4 C 5 D 8 E 9 F 11 G 4 H 9 I 5 J 4 USL N N N N N N

OPERATION

Function	Operation	Print
		N N N
		+NG 4l
		= 2
		A 12.3600p
		B 13.6910p
		C 15.0220p
		D 16.3530p
		E 17.6840p
		F 19.0150p
		G 20.3460p
		H 21.6770p
		I 23.0080p
		J 24.3390p
		25.6700p

IMPORTANT

- ◆ DP-1 recording paper has superior characteristics of conservation and tolerance to chemicals, but it shares limits with other thermal papers. In the case of long storage (more than 5 years), or if used for public documents, you should make photocopy.
- ◆ If cutting fluid comes in contact with the recording paper, and those papers are necessary to be stored a long time, it is recommended to store after photocopying.
- ◆ In the case of mode 0
Statistical calculation cannot be performed.
Maximum data that can be handled: 100000
- ◆ In the case of mode 1
Maximum data that can be handled: 9999.
When 9999 data is input, statistical calculations are performed automatically.
- ◆ In the case of mode 2
Maximum data that can be handled: 9999.
When 9999 is input, statistical calculations are performed automatically.
Printing format of the data will be a D chart (analogical, volume changing print)
- ◆ If the time printing parameter is OFF, date and time will not be printed.

OPERATION

4. Mode 3

Example mode3 operation

Function	Operation	Print
Power ON	POWER	SubGrC * DP-1VR * * MODE 3* DATE 2000/ 2/ 2 TIME 13: 35
Initiate measurement of a subgroup Transfer a subgroup to measuring mode.	TOL.LIMIT	SUB GR. NO.1
Data receiving (Subgroup measure mode)	DATA DATA DATA	Print data received in from measuring equipment. 1 12.00 mm 2 26.25 mm 3 32.56 mm
Data cancel Cancels prior input data. ('CL' key pressed during measurement of a subgroup)	CE	* CANCEL *
Subgroup data is all cleared. Data in subgroup is all cleared, and are measured again from No.1 data. ('CL' key pressed during measurement of subgroups)	CL	* CLEAR SUB DATA*
Time printing	PRINTER ON/OFF + DATA	DATE 2000/ 2/ 2 TIME 13: 35
Finish measurement of subgroup and calculate \bar{X} -R of subgroup. (Normal sub-group measure mode is finished)	STAT	\bar{X} 0.92335 mm R 2.77568 mm <hr/> PART NO. <hr/> DATE 2000/ 2/ 2 <hr/> TIME 13: 35 <hr/> NAME
Stop measurement of subgroup, and release subgroup measure mode. (Subgroup measure mode forced finish)	TOL.LIMIT	* EXIT SUB GR. *

OPERATION

Function	Operation	Print
Measure next subgroup	TOL.LIMIT	SUB GR. 2
Data input	DATA DATA DATA	Input data from measuring equipment. 1 12.00 mm 2 26.25 mm 3 32.56 mm
Finish measurement of subgroup and calculate \bar{X} -R of subgroup	STAT	\bar{X} 0.92335 mm R 2.77568 mm PART NO. <hr/> DATE 2000/ 2/ 2 TIME 13: 35 <hr/> NAME <hr/>
Calculation of control limits is carried out from all the sub-group data which has been input, and the result is printed.	STAT	*CONTROL LIMIT* DATE 2000/ 2/ 2 TIME 13: 35 NO.OF SUB GR. 5 SAMPLE SIZE 8 \bar{X} 4.1999 mm \bar{X} -UCL 6.9057 mm \bar{X} -LCL 1.4970 mm \bar{R} 2.6458 mm \bar{R} -UCL 6.8082 mm \bar{R} -LCL 6.8082 mm
Time stamp	PRINTER ON/OFF + DATA	DATE 2000/ 2/ 2 TIME 13: 35
Cancels prior subgroup data. 'CE' key is pressed after finishing measurement of subgroup.	CE	*CLEAR SUB GR.*
Clears measured data 'CL' key is pressed after finishing measurement of subgroup.	CL	*CLEAR ALL DATA*

OPERATION

5. Print RS232C of counter

Function	Operation	Print
<ul style="list-style-type: none"> ● Power ON If parameter time stamp is 'OFF', data and time are not printed.	POWER	Result * DP-1VR * * MODE 1 * DATE 2000/ 2/ 2 TIME 13: 35 *LIMIT DATA 1* LSL 12.365 USL 25.675 TOL 13.310
<ul style="list-style-type: none"> ● Time stamp 	PRINTER ON/OFF + DATA	DATE 2000/ 2/ 2 TIME 13: 35
<ul style="list-style-type: none"> ● Data cancel Prior data input is canceled.	CE	* CANCEL *
<ul style="list-style-type: none"> ● Data all clear All input data is cleared.	CL	* CLEAR *
<ul style="list-style-type: none"> ● Data input Limit judgment is conducted for input data and displayed (LED) and printed. Meanings of the symbols are as follows. H : DATA Lower limit : Lower limit \bar{m} DATA \bar{m} Upper limit G :Upper limit DATA DATA : Input data	DATA DATA DATA	H 1 X 12.000 Y 23.565 2 X 24.254 Y 23.896 G 3 X 32.566 Y 23.896
Statistical calculation <ul style="list-style-type: none"> ● Statistical calculations are started automatically where the 9999th data is input. 	STAT	*RESULT* PART NO. <hr/> DATE 2000/ 2/ 2 TIME 13: 35 <hr/> NAME <hr/> N 56 MAX 81.26 MIN 25.66

OPERATION

Function	Operation	Print
		R 55.60
		\bar{X} 54.23
		σ_n 12.5635
		σ_{n-1} 13.5897
		-NG 2
		+NG 4
		P 18.56%
		Cp 0.45670
		Cpk 0.30000
		 HISTOGRAM
		LSL 12.36
		USL 25.67
		TOL 13.31
		DIV 10
		 -NG 2
		LSL N N N N N N
		N N N
		A 2
		B 4
		C 5
		D 8
		E 9
		F 11
		G 4
		H 9
		I 5
		J 4
		USL N N N N N N
		N N N
		+NG 4
		= 2
		 A 12.3600p
		B 13.6910p
		C 15.0220p
		D 16.3530p
		E 17.6840p
		F 19.0150p
		G 20.3460p
		H 21.6770p
		I 23.0080p
		J 24.3390p
		25.6700p

6 OTHER NOTES

In order to ensure data reliability of the SDP interface, DP-1VR reads the data twice. Some models (KC counter with code out unit No. 09CAA462 etc.) are incapable of performing the above data checking routine.

For those models, you must perform the following procedures by changing the interface mode.

Interface mode is interchangeable with the former products (DP-1HS) by setting it for COMPATIBLE.

Operation	Printout
CE + POWER	* DP-1VR * SELECT SDPINTERFACE PUSH STAT: MODE CHANGE PUSH DATA: MODE FIX INTERFACE: ADVANCED
STAT	INTERFACE: COMPATIBLE
DATA	Changing to data input mode

STAT: To change modes

DATA: To set the mode and to end the operation

7 MAINTENANCE

Daily maintenance of DP-1VR

1. *Clean printer head*

When dust collects on the printer head, print quality is adversely affected, and sometimes printing is impossible due to damage to the printer head. It is recommended cleaning the printer head periodically.

Cleaning method:

After opening the printer cover the printer head can be seen. Rub the printer head with a cotton swab soaked in a little alcohol. After that, wipe off the remaining alcohol lightly with a dry cotton swab until dry.

2. *Clean paper sensor*

If the paper sensor becomes dirty, detection of the record paper is impossible and normal operation can not be conducted. It is recommended to clean the paper sensor portion periodically.

Cleaning method:

After opening the printer cover the printer sensor can be seen. Rub the printer sensor with a cotton swab soaked in a little alcohol. After that, wipe off the remaining alcohol lightly with a dry cotton swab until completely dry.



WARNING

-
- ◆ Just after finishing printing, do not clean. Printer head is hot; you may burn your hand. Also, that heat may set the alcohol on fire.
 - ◆ Alcohol left on the head should be dried completely, since there is a possibility it could ignite.
 - ◆ Handle the alcohol carefully.
 - ◆ Do not use thinners, benzene etc., only use alcohol.
-

MAINTENANCE

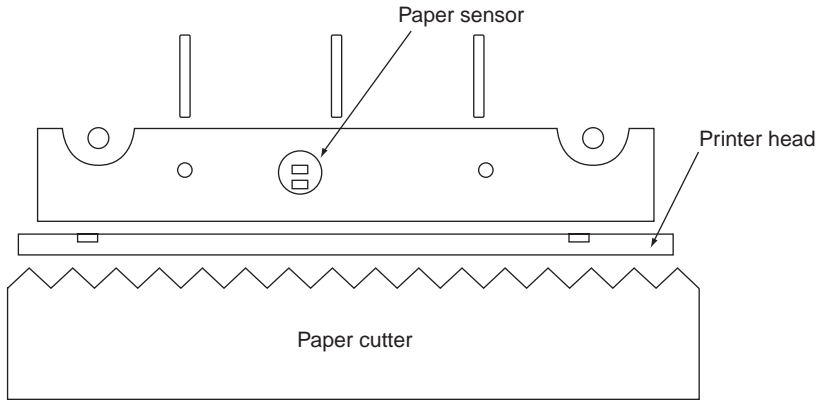

8 ERROR MESSAGE

1. Alarms concerning electric power

Table 1 Power related alarms

Condition	Voltage detection	Power LED flash ON and OFF pattern	Data input	Release condition
Abnormally high voltage	more than 10.0V	0.6 sec on, 0.6 sec off repeat	Impossible	Power on again
Normal	10.0 ~ 4.5V	Always on	Possible	
Slightly low voltage; caution In the case that voltage drops the battery capacity is reduced.	4.5V ~ 4.2V	1.5 sec OFF, 0.3 sec ON 0.3 sec OFF, 0.3 sec ON repeat	Possible	Recover if voltage returns to normal region.
Abnormally low voltage In the case that voltage is low and becomes impossible.	Less than 4.2V	0.6 sec ON, 0.6 sec OFF repeat	Impossible	Power on again

NOTICE

- ◆ If the power goes off, data that was not saved is lost. Be sure to save all data before removing the AC adapter from the DP-1VR during operation, even if the DP-1VR is not being operated by the AC adapter.
 - ◆ Using batteries under 10°C may shorten battery life expectancy. If the operating temperature is under 10°C, use the AC adapter.
-

ERROR MESSAGE

2. Other alarms

Table Error alarm of DP-1VR

Kind of alarm	Symptom	Possible cause	Remedies
● System error	● Just after power on, all LEDs flash on and off and buzzer sounds.	● Fatal error of DP-1 occurred. ● Operating temperature is too high or too low.	● Try to power up again. If trouble reoccurs, inform our nearest office or service network. ● Use between 0° C ~ 45° C
● Overflow	*OVER FLOW* ● is printed.	● It is beyond possible calculating area.	● Clear data by 'CL' key operation.
● No paper	● LED of -NG, +NG flashes on and off. ● A red line appears on the record paper.	● No recording paper.	● Replace recording paper
● Cover open (Head up)	● LED of -NG, +NG flashes on and off.	● Cover of recording paper is open.	● Close cover
● Measurement equipment is not connected.	*NO GAGE* ● is printed.	● Measuring tool is not connected. ● Connecting cable is broken. ● Abnormal contact in connecting cable	● Connect measuring tool equipment ● Change connecting cable ● Confirm the connecting portion of connecting cable.
● Not correct format	*FORMAT ERROR*	● Format of input data is different.	● Change connecting cable. ● Confirm the connecting portion of cable.
● Different unit	*UNIT ERROR*	● Unit of input data is different.	● It is printed when unit of data is different from initial input data. Input data of same unit as initial input data. ● Different unit from set tolerance limit data is input. Input data of same unit as limit data.

ERROR MESSAGE

Kind of alarm	Symptom	Possible cause	Remedies
Error in decimal point	*POINT ERROR*	Decimal point position of input data is different.	<ul style="list-style-type: none">● It is printed when the decimal point position is different from initial input data. The decimal point position should be the same as the initial data.● Different decimal point position from set limit data is input. Input data of the same decimal point position as limit data.
<ul style="list-style-type: none">● Caution of overflow	<ul style="list-style-type: none">● Two beeps for each data input	<ul style="list-style-type: none">● Near to overflow	<ul style="list-style-type: none">● Finish measurement, and conduct statistical calculation. After that, clear data using the 'CL' key.

9

CALCULATION METHOD

1. Significant figure

Significant figures of calculation are as follows.

When significant figures (figures after the decimal point) of input data are A, significant figures are displayed.

Significant Figure

Sign	Meaning	Displayed significant figure (figure after the decimal point)	Error
DATA	Input data	A	—
N	Data count	0	—
MAX	Maximum value	A	—
MIN	Minimum value	A	—
\bar{R}	Range	A	—
X	Mean	A+2	Last figure \pm 1
σ_n	Standard deviation	A+2	Last figure \pm 1
σ_{n-1}	Standard deviation	A+2	Last figure \pm 1
P	Percent defective	3 (**.***%)	Last figure \pm 1
C _P	Process capability index	3	Last figure \pm 1
C _{PK}	Process capability parameter	3	Last figure \pm 1
LSL	Lower limit value	A	Last figure \pm 1
USL	Upper limit value	A	Last figure \pm 1
DIV	Histogram division number	10 division fix	—
	Histogram region express	A+2	Last figure \pm 1
$\bar{\bar{X}}$	Center (\bar{X} control)	A+2	Last figure \pm 1
\bar{X} -UCL	Upper control limit (\bar{X} control)	A+2	Last figure \pm 1
\bar{X} -LCL	Lower control limit (\bar{X} control)	A+2	Last figure \pm 1
\bar{R}	Center (R control)	A+2	Last figure \pm 1
R-UCL	Upper control limit (R control)	A+2	Last figure \pm 1
R-LCL	Lower control limit (R control)	A+2	Last figure \pm 1

IMPORTANT

Range to apply calculation error is revealed in the calculation error detail.

2. Overflow and calculation error

- Overflow and calculation error

Overflow conditions of DP-1VR and calculation error are shown below:

Overflow of DP-1VR is different due to mean value and amount of data.

This is shown in the graph overflow condition.

- Viewpoint of graph

If mean value 10 m is measured with 2 figures after the decimal point (by caliper etc.), how much of data can be measured, is checked.

q Data 10000.00 is changed to 1000000 as no decimal point.

w Vertical axis 1000000 on graph is extended to the horizontal direction and compared to the horizontal axis.

e 2000 is obtained as the number of the data.

r When the data of the mean value 10 m is measured about 2000, it is recognized that the overflow happens.

Condition of overflow

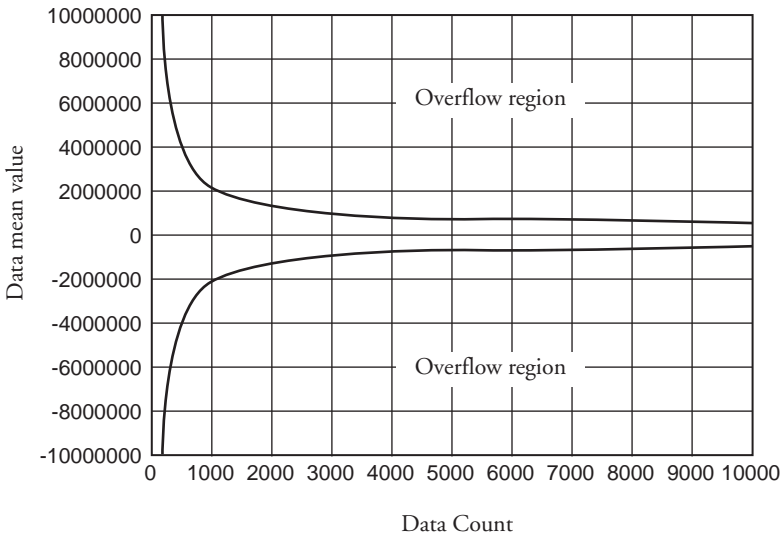

IMPORTANT

- ◆ Overflow seldom happens in usual measurement by calipers or micrometers etc.
- ◆ When this unit is used for printing of a linear scale counter, overflow may happen. Be careful when referring to a graph of this condition that overflow may happen.

CALCULATION METHOD

NOTE

- ◆ Mean value of the data shows the state when the decimal point of the data is neglected.
Ex 10.00 is changed to read 1000
-

3. Calculation error detail

Calculation error of DP-1VR is shown below:

Calculation error of DP-1VR is defined as follows.

- q Last figure ± 1 count. Graph expresses the inside of the overflow limit of the calculation preciseness.
Dispersion of data is set at $\pm 5\%$ of the mean value.
- w When the dispersion of the mean value is far beyond the mentioned value, calculation error is over ± 5 .
- e For A region (± 1000000 , data count less than 2000), in all cases, calculation error is less than ± 1 .

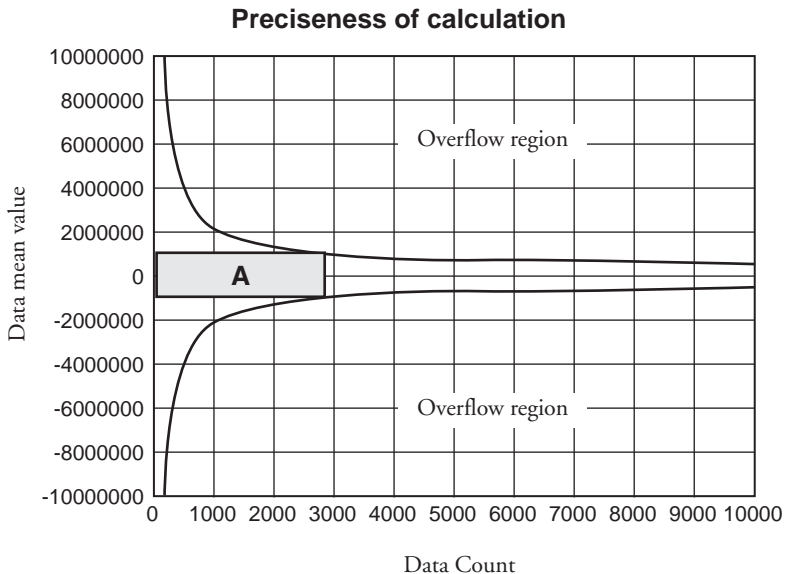

NOTICE

- ◆ Mean value of data shows the state when the decimal point is neglected.
Ex 10.00 is changed to read 1000
-

4. Calculation formula

4.1 Calculation of Mode1, Mode2

Table 2 Calculation formula 1

PRINT	MEANING	FORMULA
N	Data count	
MAX	Maximum value of data	
MIN	Minimum value of data	
R	Range of data	MAX-MIN
\bar{X}	Mean value of data	$\Sigma Xi/N$
σ_n	Standard deviation	$\sigma_n = n$ $((N \Sigma Xi^2 - (\Sigma Xi)^2) / N^2)^{1/2}$
σ_{n-1}	Sample standard derivation	$\sigma_{n-1} =$ $((N \Sigma Xi^2 - (\Sigma Xi)^2) / N(N-1))^{1/2}$
-NG	Amount of data smaller than lower limit	Number of data to become LSL Xi
+NG	Amount of data larger than upper limit	Number of data to become LSL Xi
P	Fraction defective	$P =$ $((-NG) + (+NG))/N$
C _P	Process capability index	$C_P =$ $TOL/(6\sigma_{n+1})$
C _{PK}	Process capability index which considers deviation.	$(TOL:USL+LSL)$ $C_{PK} =$ $Z_{min}/3$ $Z_{min}: Z_{USL}, Z_{LSL}$ Smaller value of Z_{LZL} $Z_{USL} = (USL - \bar{X}) / \sigma_{n-1}$ $Z_{LSL} = (\bar{X} - LSL) / \sigma_{n-1}$

CALCULATION METHOD

4.2 Calculation Mode3

- N : Data count
 MAX: Maximum value of data
 MIN: Minimum value of data
 n : Number of subgroup
 A2 : Refer to table
 D3 : Refer to table
 D4 : Refer to table

Maximum number of data in each subgroup is 10

Table 3 Mode3 table of variables

SAMPLE SIZE n	A2	D3	D4
2	1.880		3.267
3	1.023		2.574
4	0.729		2.282
5	0.577		2.114
6	0.483		2.004
7	0.419	0.076	1.924
8	0.373	0.136	1.864
9	0.337	0.184	1.816
10	0.308	0.223	1.777

Sign	Meaning	Formula
\bar{X}	Mean value of subgroup	$\bar{X} = \Sigma Xi / N$
\bar{R}	Range of subgroup	$\bar{R} = \bar{X}_{max} - X_{min}$
$\bar{\bar{X}}$	Center value	$\bar{\bar{X}} = \Sigma Xi / n$
\bar{X} -UCL	Upper control limit	$\bar{X} - UCL = \bar{\bar{X}} - A2 \bar{N} \bar{R}$
\bar{R}	Center (R control)	$R = \Sigma Ri / n$
R-UCL	Upper control limit (R control)	$R - UCL = D4 \bar{N} \bar{R}$
R-LCL	Lower control limit (R control)	$R - UCL = D3 \bar{N} \bar{R} *1$

ADDITION

*1 R-LCL is not printed, when the number of samples is less than 6

10 OUTPUT

By connecting the optional cable (NO. 965465) to the OUTPUT connector located at the side of this unit, either GO/±NG judgment for the input data or measured data in RS-232C format can be output through the OUTPUT connector.

1. Output of GO/±NG Judgment

When the optional GO/±NG judgment result output cable (NO. 965516) is connected to this unit, and it is in MODE0, MODE1, or MODE2 with the upper and lower tolerance limits set. These judgment results will be output through an open collector.

2SC4047 or equivalent

V_{ceo} (max) = 50V

I_C (max) = 100mA

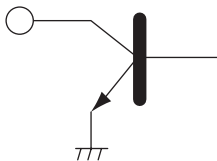

2. Output in Accordance with RS-232C Format

The data entered in the DP-1VR will be output to an external device in RS-232C format when: the 'DATA' key of this unit is pressed, timer signals are input, this unit receives a data request command via the RS-232C, or when the foot switch or data output key is pressed on the measuring unit. However, the results of the calculations performed in this unit are not output to an external device. Use the RS-232C conversion cable (Part No. 09EAA084) to output from this unit. Also use this cable to receive output signals in RS-232C format from the Liner Scale Counter.

OUTPUT

2.1 Communication Specifications

Output Signal Level:	TTL Level	
Communication Method:	Half-Duplex	
Transmission Speed:	1200, 2400, 4800, 9600, 19200	
Bit Construction:	Start bit	1 bit
	Data bit	7/8 bits
	Parity Check	EVEN/ODD/NONE

2.2 Data Format

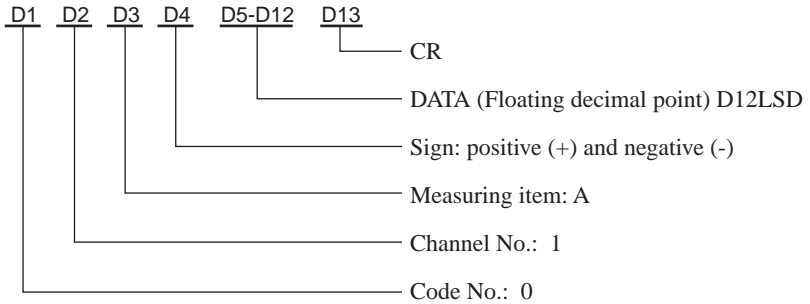

2.3 Error Code

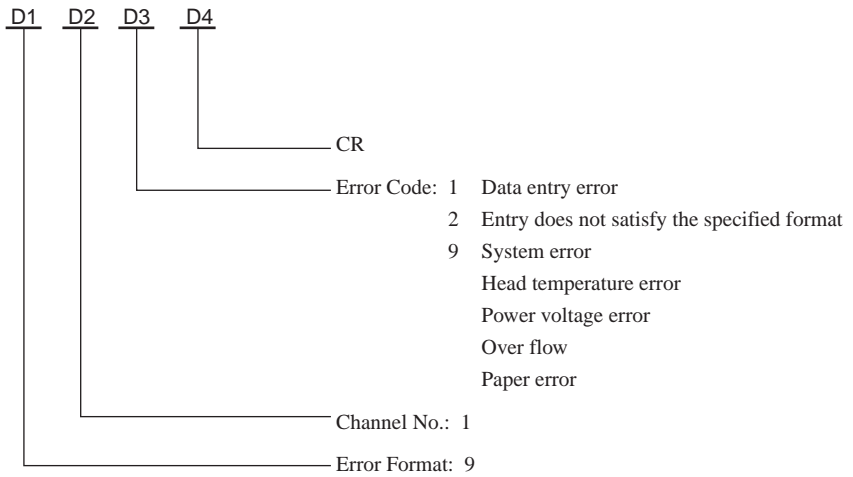

2.4 Data request command

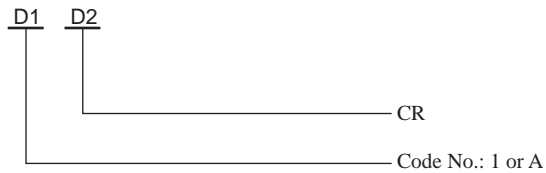

11 ***TROUBLESHOOTING***

Checks and Remedies-Before diagnosing a problem as a defect, check the following information.

When the DP-1VR malfunctions, diagnose the problem and remedy of the situation with the aid of the following table.

If the problem still persists, please contact your dealer or the nearest Mitutoyo sales office. (For the addresses, refer to the end of this manual.)

The warranty period of the DP-1VR is one year from the date of purchase for use.

Repair of this unit may be subjected to charge, depending on the case within and after this period.

TROUBLESHOOTING

Symptom	Possible cause	Remedies
<p>When printing, the DP-1VR unexpectedly returns to the initial state seen after the power is turned ON. Printing is too light</p>	<ul style="list-style-type: none"> ● Manganese dry cells are used by mistake ● Peeling or poor fitting of the seal is present on the battery pole ● The specified AC adapter is not used. ● The DP-1VR supply power is connected to the measuring instrument. ● Input voltage to the AC adapter (i.e. AC line voltage) is too low; falls 5% or more than the rated voltage ● The AC adapter is sharing the same power line with a high-voltage or large-current device ● The printing head is not clean 	<ul style="list-style-type: none"> ● Use properly charged size AA Nickel Hydrogen battery (Ni-Mh) or Alkali battery (LR6) ● Correct the peeling or poor fitting of the seal ● Use the dedicated AC adapter 09EAA088 (100/115V) 09EAA088D (230V) 09EAA088E (230V UK) supplied with the DP-1VR ● The DP-1VR power supply should not be connected to the measuring device. Use a separate power supply for each of them ● Adjust the voltage supply of the power line correctly, and confirm the result ● Connect the AC adapter to a separate power line ● Clean the printing head with a cotton swab, etc
<p>Printer does not print</p>	<ul style="list-style-type: none"> ● [PRINTER ON/OFF] switch is turned to OFF ● The printer is jammed with paper, etc ● The DP-1VR is in the timer input mode and the input interval is set to 0.25 or 1 sec. 	<ul style="list-style-type: none"> ● Press the [PRINTER ON/OFF] switch again to turn on. ● Remove it by tweezers, etc ● When the input interval is set to 0.25 or 1 sec, the printer will be automatically turned off.
<p>Miscounting often occurs on the measuring instrument side</p>	<ul style="list-style-type: none"> ● The AC adapter is sharing the same power line with a high-voltage of large-current device. 	<ul style="list-style-type: none"> ● Connect the AC adapter to a separate power line

12 SPECIFICATIONS

Item	Description	Remarks
Code No.	264-504	100V
Printing Method	Line thermal 384 dot	
Character format	36 × 24 (Large) 24 × 14 (Normal)	
Printing Speed	0.5 sec. per line	When using AC adapter
Printing line numbers per printing roll	7000 lines / 1 roll (normal)/ 1000 lines / 1 roll (large)	
Power supply	AC adapter (6V, 500 mA) Alkali battery size AA (LR6) Or 4 size AA Ni-MH batteries	Dual power supply *AC adapter input voltage within a range of 100VAC ±5%
Operating Temperature	0 ~ 45°C (AC Adapter) 10 ~ 45°C (batteries)	
Storage Temperature	-10 ~ 50°C	In a package as specified by Mitutoyo
Accuracy	±2 min. max / month	
Clock battery life expectancy	Approx. 10 years	Average life expectancy
Battery life	10000 lines 1600 mAh Ni-MH Printing every 5 sec.	Average life expectancy but varies with usage
Dimensions	201.1 × 94 × 75.2 (D × W × H)	
Weight	390 g	Without accessories
Printouts	Measurements, GO/±NG judgment results	Mode 0
	Measurements, GO/±NG judgment results, Number of measurements, MAX., MIN., Range, Standard deviation (σ -n, σ -1), Number of defects, Percentage of defects, Process capability index (C _p , C _{pk}), Histogram	Mode 1
	Same as above plus D-Chart	Mode 2
	Function of calculating the center value between the control limits required for generating various control charts	Mode 3

SPECIFICATIONS

Item	Description	Remarks
Processing capability	100000	Mode 0
	9999	Both Mode 1 and 2
	10 × 9999 = 99990 (Sample size × Number of sub-groups = total number of measurements) 5 sets of limit data	Mode3
Output function	Measured data (RS-232C, TTL level) GO/±NG Judgment results (+NG, GO, -NG)	
Timer-controlled data input	0.25 sec, 1 sec, 5 sec, 30 sec, 1 min, 30 min, 60 min.	
Standard accessories	AC Adapter	110V/115V 09EAA088 230V 09EAA088D 230V (UK) 09EAA088E
	Recording paper: 1 pc. (58 mm (W) × 48 m (L))	When ordering Part No. 09EAA082 (10 pcs.)
	Strap	09EAA079
	Quick Reference	09EAA090
	User's manual	99MBE021

Optional accessories:

Item Name	Parts No.
RS-232C conversion cable 9 pins for AT connector	No. 09EAA084
GO/±NG judgment result output cable	No. 965516
Foot Switch	No. 937179T

Consumables:

Item Name	Parts No.
Printing Paper (10 packs)	No. 09EAA082

SERVICE NETWORK

MTI Corporation

New Jersey Office

18 Essex Road, Paramus, N.J. 07652, U.S.A.
TEL: (201)368-0525 TELEX: 134317 FAX: (201)343-4969

Detroit Office

45001 Five Mile Road, Plymouth, M? 48170, U.S.A.
TEL: (313)459-2810 FAX: (313)459-0455

Chicago Office

965 Corporate Blvd., Aurora, IL 60504, U.S.A.
TEL: (708)820-9666 FAX: (708)820-7403

Dallas Office

2410 Gateway Drive, Irving TX 75062, U.S.A.
TEL: (214)550-8645 FAX: (214)550-8861

Los Angeles Office

16925 East Gale Ave., city of Industry, CA91745, U.S.A.
TEL: (818)961-9661 FAX: (818)333-8019

MTI Canada Ltd.

2121 Meadowvale Blvd., Mississauga, Ont, L5N 5N1,
CANADA
TEL: (905)821-1261-3 FAX:(905)821-4968

Mitutoyo do Brasil Industria e Comercio Ltda.

AV. Joao Carlos da Silva Borges, 1240, CEP 04726
Santo Amaro P.O. Box 4255 Sao Paulo, BRASIL
TEL: (011)522-7755 TELEX: 1123768 MTOY BR
FAX: (011)523-3661

Mitutoyo Mexicana S.A. de C.V.

Ave. Primero de Mayo No. 236-A San Andres, Atoto 53500
Naucaipan, Edo. de MEXICO
TEL: 576-8799 TELEX: 1772007 FAX: (915)576-8039

Mitutoyo Mebgerate GmbH

Borsigstr. 8-10, 41469 Neuss F.R. GERMANY
TEL: (02137)102-0 TELEX: 8517702 FAX: (02137)8685

Mitutoyo Nederland B.V.

Postbus 550, Landjuweel 35, 3905 PE Veenendaal,
NETHERLANDS
TEL: 08385-34911 FAX: 08385-16568

Mitutoyo Scandinavia A.B.

Box 712, Stockholmsvagen 26, 194 27 Upplands-Vasby,
SWEDEN
TEL: (08)590 921 35 TELEX: 15353 FAX: (08)590 924 10

Mitutoyo Belgium N.V.

Hogenakkerhoek straat 8, 9150 Kruibekke, BELGIUM
TEL: (03)8303063 FAX: (03)8278360

Mitutoyo France S.A.R.L.

123, rue de la Belle Etoile, B.P. 50267-Z.I. Paris Nord II
95957 Roissy CDG Cedex, FRANCE
TEL: (01)49 38 35 00 TELEX: 233913 FAX: (01)49 38 35 35

Mitutoyo France S.A.R.L., Agence de Lyon

Bat L133, avenue du Dr. Georges Levy 69200
VENISSIEUX
TEL: (16)78752010

Mitutoyo Italiana S.R.L.

Corso Europa No.7, 20020 Lainate, Milano, ITALY
TEL: (02)935781 FAX: (02)9373290

Mitutoyo Schweiz AG

Steinackerstrasse 35, 8902 Urdorf-Zurich, SWITZERLAND
TEL: (01)7361150 FAX: (01)7361151

Mitutoyo (U.K.) Ltd.

Joule Road, West Point Business Park, Andover,
Hampshire
SP10 3UT UNITED KINGDOM
TEL: (01264)353123 TELEX: 477694 FAX: (01264)354883

Mitutoyo Asia Pacific Pte. Ltd.

Regional Headquarters

24 kallang Avenue, Mitutoyo Building, SINGAPORE 339415
TEL: 294-2211 TELEX: RS 25875 MTYSIN FAX: 299-6666

Malaysia

Head office

Mitutoyo (Malaysia) Sdn. Bhd.

Lots 1-8 Ground Floor, Asia Jaya Commercial Complex,
Section 52, 46200 Peteling Jaya, Selangor, MALAYSIA
TEL: (60)3-757-2524 FAX: (60)3-757-2540

Panan Branch Office

No.9 Jalan Selat, Taman Selat 12000, Butterworth, Penang,
MAYALYSIA
TEL: (60)4-310915/8 FAX: (60)4-310907

Johor Office

20A, Jalan Abiad, Taman Tebrau Jaya 80400, Johor Bahru,
Johor, MAYALYSIA
TEL: (60)4-310915/8 FAX: (60)7-336861

Thailand:

Representative Office

9th Floor, Unit D2-3, MBK Tower, 444 Phayathai Road,
Bangkok, THAILAND 10330
TEL: (66)2-217-9651/3 FAX: (66)2-217-9654

India:

Representative Office

702, Arunachal Building, 19, Barakhamba Road,
New Delhi-110001, INDIA
TEL: (91)11-332-4419 TELEX: 031-62939 MAP IN

Mitutoyo Taiwan Co., Ltd.

5th FL. No. 123, Wu Kung First Road, Wu Ku Industrial
Park, Taipei Hsien, TAIWAN, R.O.C
TEL: (02)299-5266 FAX (02)299-2358

Please contact your nearest technical service center, for problems or questions about this product.

Mitutoyo Corporation

20-1, Sakado, 1-chome, Takatsu-ku, Kawasaki, Kanagawa 213-0012, Japan

Printed in Japan