



MOTORIZED

Owners Manual

COACHMEN RV
a division of Forest River, Inc.

Rear Diesel - Class A - Super C - Class C - Class B+



Welcome Home!

WELCOME to the Forest River family and thank you for selecting a Forest River, Inc. product. Congratulations for choosing a lifestyle that will provide you the freedom to enjoy recreation wherever you may choose.

This owner's manual is designed as a *Quick Reference* guide for the operation and care of your new purchase. For more complete instructions regarding safety, maintenance and operation of the items used in the manufacturing of your RV, carefully read the booklets supplied by the component manufacturers. All information contained in this manual may not relate to your specific model, however booklets supplied by the component manufacturers and included in your Owner's packet will provide any additional information needed.

Your dealership personnel should be able to answer any questions or concerns you may have regarding your new product. If your dealer is unable to do so, please feel free to contact our Customer Service department for assistance. Your dealership will provide you with the appropriate contact information.

Your recreational vehicle was built using the high standards set by Forest River Inc., and following the strict guidelines set forth by the Recreational Vehicle Industry Association, (RVIA) as well as complying with the requirements of all applicable state and federal agencies.

Please carefully read the Limited Warranty in the front of this manual. Forest River, Inc. has no other expressed or implied warranties of any type. You, as the owner, are responsible for providing proper maintenance as outlined in this manual and as set forth in the component manufacturers booklets.

FAILURE TO PROPERLY MAINTAIN YOUR UNIT COULD RESULT IN LOSS OF WARRANTY COVERAGE.

Several of our component manufacturers carry their own warranty and require separate warranty information to be filed with them. Please read all component manufacturers owner's manuals provided with your RV and file appropriate individual warranty cards as required. You have joined an elite group and as you begin making great memories using your new Forest River motorhome, we wish you many exciting and adventurous days of RV camping.

Drive Safely and...
'Go RV'ing!'

**LIMITED WARRANTY MOTORIZED PRODUCTS
RECREATIONAL VEHICLES BY FOREST RIVER, INC.**

FOREST RIVER, INC.

Thank you for choosing to purchase a Recreational Vehicle by Forest River, Inc., a fine product in which design and construction have received the care that quality demands. This important warranty covers many items and is indicative of our desire to stand behind our products and assure our customers' complete satisfaction.

WARRANTY COVERAGE

SUMMARY OF WARRANTY: Forest River, Inc., 55470 CR 1, P.O. Box 3030, Elkhart, Indiana 46515-3030 (Warrantor) warrants to the ORIGINAL CONSUMER PURCHASER ONLY, when purchased from an authorized Forest River, Inc. dealer, for a period of (1) one year from date of purchase or (12,000) twelve thousand miles, whichever comes first (Warranty Period), that the body structure of this recreational vehicle shall be free of substantial defects in materials and workmanship attributable to Warrantor.

EXCLUSIONS FROM THIS WARRANTY: Warrantor expressly disclaims any responsibility for damage to the unit where damage is due to condensation, normal wear and tear or exposure to elements. Warrantor makes no warranty with regard to, but not limited to, the motorhome chassis including without limitation, the engine and drive train, any mechanical parts or systems of the chassis, tires, tubes, batteries and gauges, routine maintenance, equipment and appliances, or audio and/or video equipment. Their respective manufacturers and suppliers may warrant some of these items. Warranty information with respect to these items is available from your dealer.

The Warrantor further makes no warranty with regard to any product used for commercial purposes, as a permanent residence or as a rental unit, or any product not registered and normally used in the United States or Canada.

LIMITATION AND DISCLAIMER OF WARRANTIES: WARRANTOR EXPRESSLY LIMITS THE DURATION OF ALL EXPRESS AND IMPLIED WARRANTIES OF MERCHANTABILITY AND ALL IMPLIED WARRANTIES OF FITNESS FOR A PARTICULAR PURPOSE EXCEPT IN THOSE STATES THAT DO NOT ALLOW THIS EXCLUSION. WARRANTOR EXPRESSLY DISCLAIMS ALL IMPLIED WARRANTIES OF MERCHANTABILITY OR FITNESS FOR A PARTICULAR PURPOSE AFTER EXPIRATION OF THE WARRANTY PERIOD. No action to enforce express or implied warranties shall be commenced later than (90) ninety days after expiration of the warranty period. There is no warranty of any nature made by the Warrantor beyond that contained in this Warranty. No person has authority to enlarge, amend or modify this Warranty except this Warrantor.

Some states do not allow limitations on how long an implied warranty lasts, so the above limitation may not apply to you.

No action to enforce express or implied warranties shall be commenced without prior written notice to the manufacture and/or warrantor at the address listed above of the alleged defect or nonconformity or the authorized repair facility's failed repair attempt and MANUFACTURE, AT ITS DIRECT OPTION, shall have a final opportunity to remedy.

DISCLAIMER OF CONSEQUENTIAL AND INCIDENTAL DAMAGES: THE ORIGINAL CONSUMER PURCHASER OF THIS RECREATIONAL VEHICLE AND ANY PERSON TO WHOM THIS UNIT IS TRANSFERRED, AND ANY PERSON WHO IS INTENDED OR UNINTENDED USER OR BENEFICIARY OF THIS UNIT SHALL NOT BE ENTITLED TO RECOVER FROM WARRANTOR ANY CONSEQUENTIAL OR INCIDENTAL DAMAGES.

Some states do not allow the exclusion or limitation of incidental or consequential damages, so the above limitation or exclusion may not apply to you.

WARRANTOR'S OBLIGATIONS: Warrantor will remedy substantial defects in materials and workmanship caused by Warrantor. Warrantor shall elect to remedy the defect from among the following: repair, replacement or refund. Warrantor may not elect refund unless the Purchaser agrees, or the Warrantor is unable to provide replacement and repair is not commercially practicable. Warranty performance can only be obtained at Warrantor's authorized dealers and service centers and from Warrantor, at the discretion of the Warrantor. All costs incurred in transporting this recreational vehicle for warranty service shall be borne by Purchaser. Warrantor shall remedy the defect within a reasonable amount of time after appointment and delivery by Purchaser. All of warrantor's expenses in remedying the defect shall be borne by the Warrantor.

PURCHASER'S OBLIGATIONS: Purchaser must complete and return the owner's registration within (10) ten days of purchase to validate this Warranty. The return of this registration is a condition precedent to warranty coverage; failure to return the completed registration to the Warrantor will invalidate this warranty. Purchaser shall deliver this recreational vehicle for warranty service within a reasonable time after discovery of the defect and in no event after expiration of the Warranty period, which Warranty Period is (1) one year or (12,000) twelve thousand miles, whichever occurs first. All expenses incurred by Purchaser in obtaining warranty service shall be borne by Purchaser. Warranty service shall, whenever possible, be scheduled with the selling dealer by an appointment in order to avoid possible delays. Purchaser can, if necessary, obtain a list of persons authorized to perform warranty service by contacting Warrantor at the above address. **No action to enforce express or implied warranties shall be commenced without prior written notice to the manufacture and/or warrantor at the address listed above of the alleged defect or nonconformity or the authorized repair facility's failed repair attempt and MANUFACTURE, AT ITS DIRECT OPTION, shall have a final opportunity to remedy.**

EVENTS DISCHARGING WARRANTOR FROM OBLIGATION UNDER THIS WARRANTY: Misuse or neglect, including failure to provide reasonable and necessary maintenance, unauthorized alteration, accident, and improper loading, use as a permanent residence, commercial use or leasing of the recreational vehicle shall discharge Warrantor from any obligation under this Warranty.

PARTS AND DESIGN CHANGES: Warrantor reserves the right to change the parts and/or design of its recreational vehicle from time to time, without notice and with no obligation to maintain spare parts or make corresponding changes in its products previously manufactured.

OBTAINING WARRANTY SERVICE: To insure your local dealer's personal interest in your complete satisfaction, it is recommended that all warranty service work, be performed by the authorized dealer from whom you purchased your unit. As you are traveling, or following a move, if warranty service becomes necessary, it may be performed by any authorized dealer in the United States or Canada. In order to avoid delays, whenever possible, schedule an appointment for the warranty work to be completed.

WARRANTY REGISTRATION: A warranty registration is to be completed by the owner at the time of purchase and returned to the Warrantor. The return of this registration is a condition precedent to warranty coverage; failure to return the completed registration to Warrantor will invalidate this Warranty.

OTHER WARRANTIES: As indicated in the paragraph above, entitled "Exclusions From This Warranty," items that are not covered by this Warranty, may be warranted separately by their manufacturers or suppliers. In order to validate those warranties, you may also be required to complete and return to the appropriate manufacturer the warranty forms included with the information package. These other warranties may cover, but are not limited to, such items as motorhome chassis, tires, tubes, batteries, optional generators, and appliances, which are not covered by this Limited Warranty. For service or parts required for these products it may be necessary to write or call the product manufacturer to obtain the nearest authorized service center location. In requesting parts for separately warranted products from the manufacturer of the product or its authorized service center it may also be necessary to first obtain a warranty work authorization number before the work is done. It may also be necessary to provide the Product Name, Model and Serial Number along with the description of the problem and part needed, plus shipping instructions. See these warranties with respect to their terms and conditions.

OWNER ASSISTANCE: Your personal satisfaction and good will are most important to Forest River as well as a confident and pleasant relationship with our dealers. We at Forest River recognize that there may be occasions when a warranty or service problem is not handled satisfactorily, resulting in misunderstandings. **If your problem has not been handled to your satisfaction after discussing it with the dealership management, we welcome you to contact the Forest River Customer Service Manager, at the address stated above, who will communicate with the local dealer, our recommendations for an agreeable solution.**

THIS WARRANTY GIVES YOU SPECIFIC LEGAL RIGHTS. YOU MAY ALSO HAVE OTHER RIGHTS, WHICH VARY FROM STATE TO STATE.

COMPONENT MANUFACTURERS

Antennas	Winegard	800-288-8094	www.winegard.com
Apollo Microwaves	Midwest Sales	800-772-7262	N/A
Awnings	Carefree of Colorado	800-621-2617	www.carefreeofcolorado.com
Awnings	Dometic	800-544-4881	www.dometicusa.com
Batteries	Interstate	888-772-3600	www.interstatebatteries.com
Dash A/C	ACME Radiator	800-552-2263	www.acmeair.com
Dash A/C	Evans Tempcom	800-354-7088	www.evanstempcon.com
Euro Chair Leather	Partner Supply	574-266-8400	N/A
Fireplace	National Supply	574-295-9200	www.nationalsupplyllc.com
Furnace	Atwood	815-877-5700	www.atwoodmobile.com
Furnace	Suburban	800-659-2138	www.suburbanmfg.com
Furniture	Flexsteel	563-556-7730	www.flexsteel.com
Furniture	Mastercraft	260-463-8702 x. 243	www.rvseating.com
Furniture	Scope	888-443-9888	www.scopeseating.com
Furniture	Williamsburg	574-773-7711	N/A
Generator	Generac	574-293-6503	www.guardiangenerators.com
Generator	Onan	800-888-6626	www.cumminsonan.com
Generator	Power Tech	800-760-0027	www.powertech.com
Heating System	Aqua-Hot Vehicle Systems	800-685-4298	www.vehiclesystems.com
Inverter	Magnum	425-353-8833	www.magnumenergy.com
Inverter	Xantrex	408-987-6030	www.xantrex.com
Jacks	Lippert	866-524-7821	www.lci1.com
Jacks	Equalizer	800-846-9659	www.equalizersystems.com
LP Tanks	Manchester	800-877-8265	www.mantank.com
Microwaves	Amana	800-544-5513	www.amana.com
Microwaves	Apollo-Midwest Sales	800-772-7262	N/A
Microwaves	GE	800-432-2737	www.geappliances.com
Microwaves	Magic Chef	800-688-1120	www.magicchef.com
Power Converter	Cheng/ WFCO	877-294-8997	N/A
Power Converter	Parallax	800-443-4859	www.parallaxpower.com
Ranges	Maytag/ Whirlpool	#5)	www.whirlpoolcorp.com
Refrigerators	Dometic	800-544-4881	www.dometicusa.com
Refrigerators	Amana/Maytag/ Whirlpool	#5)	www.whirlpoolcorp.com
Refrigerators	Norcold	800-543-1219	www.thetford.com
Roof A/C	Dometic	800-544-4881	www.dometicusa.com
Roof Vent	Fantastic Vent	800-521-0298	www.fantasticvent.com
Rubber Roof & Sealant	Dicor	574-264-2699	www.dicor.com
Satelite	King Dome	800-982-9920	www.kingcontrols.com
Satelite	KVH	401-847-3327	www.kvh.com
Seat Belts	Am-Safe	574-266-8330	N/A
Shades	Irvine Shade	574-522-1446	N/A
Slide Out Assm	Equalizer	574-522-1446	www.equalizersystems.com
Slide Out Assm	Lippert	866-524-7821	www.lci1.com
Slide Out	Norco	800-347-2232	www.norcoind.com
Slide Out	Power Gear	888-239-2537	www.powergearus.com
Slide Out Topper	Dometic	800-544-4881	www.dometicusa.com
Steps	Kwikee	800-736-9961	www.kwikeeproducts.com
Steps	SCS (Lippert)	800-275-7524	www.scsfrigitte.com
Stereo	ASA	574-264-3135	www.asaelectronics.com
Stereo	CTD	800-777-4856	www.ctdmarketing.com
Tires	Goodyear	800-227-1999	www.goodyear.com
Tires	Michelin	866-866-6605	www.michelin-us.com
Toilet	Sealand	800-321-9886	www.sealandtechnology.com
Toilet	Thetford	800-543-1219	www.thetford.com
TV & DVD	Mito	800-433-6846	www.mitocorpoem.com
TV & DVD	National Supply	866-298-9200	www.nationalsupplyllc.com
TV & DVD	Riverpark	800-442-7717	www.riverparkinc.com
Washer/ Dryer	Majestic	800-678-8002	www.majesticappliances.com
Washer/ Dryer	Splendide	800-736-4127	www.splendide.com
Washer/ Dryer	Whirlpool	#5)	www.whirlpool.com
Water Heater	Suburban	800-659-2138	www.suburbanmfg.com
Water pump	Shurflo	574-262-0478	www.shurflo.com
Windows	Hehr	989-845-3061	www.hehr-international.com

CHASSIS MANUFACTURERS

Freightliner
Workhorse

1-800-385-4357
1-877-946-7731

Ford
Chevrolet

1-800-444-3311
1-800-243-8872

SECTION 1

CUSTOMER INFORMATION

MANUFACTURER'S WARRANTIES

The following list of components has been compiled to help you know which products installed on your recreational vehicle may have their own warranties. If you have any of these components on your RV, be sure to check the manufacturer's literature supplied with your Forest River Owner's packet to confirm whether they require you to register your purchase with them to validate their warranty. These warranties usually apply only to the first owner of the recreational vehicle. We recommend that you send the various warranty registration cards immediately before any time constraints on registration expire.

Manufacturer's literature is supplied by each individual company according to the specific items used in the production of your RV. This information is part of the Owner's packet you received with your RV. Only those products which are used on your unit will be included in this packet. Inspect this literature with your dealer during the pre-delivery inspection and report any literature shortage to the dealer at that time. Below is an example of the types of information you will find.

<u>APPLIANCES</u>	GPS	Water Purifier	<u>MISCELLANEOUS</u>
Range	Back-Up Camera/Monitor	Faucet	Fire Extinguisher
Range Hood		Toilet	CO Detector
Microwave/Convection	<u>ELECTRICAL</u>	Holding Tanks	Smoke Detector
Oven	110/12V Converter	Holding Tank Heaters	LP Detector
Coffee Maker	Inverter		Rear Ladder
Refrigerator	Generator	<u>LP GAS</u>	
Ice Maker	Battery	LP Tank/s	
Roof Air Conditioner		Regulator	
Furnace	<u>WATER & DRAINAGE</u>	<u>CHASSIS</u>	
Radio/Clock	Water Heater	Hitch	
TV/VCR/CD/DVD	Water Pump	Stabilizing Jacks	

NOTE: A COMPONENT MANUFACTURER IS ONE WHO PRODUCES A PRODUCT WHICH IS USED IN THE PRODUCTION OF YOUR MOTORHOME.

DEALER RESPONSIBILITIES

1. The selling dealership is responsible for inspecting both factory and dealer installed components for proper operation. This is known as the pre-delivery inspection and systems check.
2. Your dealer is required to provide a thorough and complete walk-through demonstration. This demonstration should provide a good understanding of how your new RV operates.
3. The owner's information packet should be presented at this time. This information should include all warranty cards, component information, operation and maintenance instructions relating to your new unit.
4. All component warranty forms should be discussed and/or completed at this time. Your selling dealer should assist you in understanding any and all limited warranty provisions, to help you avoid loss of warranty, for any reason. Ask any questions you may have before leaving the dealership.
5. Your dealer should provide you with information concerning any need for service for your unit, whether in or out of their area. They should provide contact numbers for the dealership both during and after hours, along with contact information for the correct Forest River division.

SECTION 1

CUSTOMER INFORMATION

OWNER RESPONSIBILITIES

1. Regular and proper maintenance. As the owner, you have the responsibility to properly maintain your recreational vehicle. Be sure you have service performed in a timely manner, don't ignore a problem. It isn't always necessary to take your unit to a service center; sometimes a phone call is all that's needed. The service technicians can advise you.
2. Familiarize yourself with your RV. Observe all the component manufacturers instructions regarding the use and service of their products.
3. Complete and send in all the warranty cards. Doing so may help you avoid conditions arising from neglect, which are not covered under warranty.

Read your warranties and review them with your selling dealer. The dealer's obligation is to educate you regarding the proper and safe operation of your RV and all its' components.

The following is a list of suggestions to assist you in avoiding most warranty issues:

NOTE

BE SURE TO INSPECT THE ENTIRE UNIT AND NOTE ANY SERVICE ISSUES.

NOTE

LOCATE ALL PAPERWORK AND ASK ANY QUESTIONS YOU MAY HAVE BEFORE LEAVING THE DEALERSHIP.

NOTE

MODIFICATIONS TO YOUR RV, WITHOUT WRITTEN AUTHORIZATION FROM FOREST RIVER INC., COULD RESULT IN REDUCTION OR LOSS, OF WARRANTY COVERAGE. CONTACT YOUR DEALER BEFORE MAKING SUCH CHANGES.

NOTE

FOREST RIVER INC. WANTS YOU TO HAVE THE BEST POSSIBLE ADVENTURE WITH YOUR NEW MOTORHOME. TO GET THE MOST ENJOYMENT OUT OF YOUR NEW PURCHASE, AND TO INSURE YOU FULLY UNDERSTAND HOW YOUR NEW RECREATIONAL VEHICLE OPERATES, PLEASE ADDRESS IMMEDIATELY WITH YOUR DEALER, ANY QUESTIONS OR CONCERNS YOU MAY HAVE , BEFORE LEAVING THE DEALERSHIP, OR BEFORE USING YOUR MOTORHOME FOR THE FIRST TIME.

NOTE

USE YOUR NEW RECREATIONAL VEHICLE RESPONSIBLY. YOUR MOTORHOME WAS NOT DESIGNED TO BE USED AS A PERMANENT DWELLING, BUT FOR SHORT TERM AND RECREATIONAL USE. IF YOU INTEND TO USE YOUR RV AS PERMANENT HOUSING, BE ADVISED THAT IT COULD CAUSE PREMATURE WEAR ON YOUR APPLIANCES, FURNACE, WATER SYSTEMS, CARPET, DRAPES, UPHOLSTERY, BEDDING AND INTERIOR SURFACES. THIS PREMATURE WEAR CAUSED BY PERMANENT RESIDENCY, MAY BE CONSIDERED *ABNORMAL* OR *ABUSIVE* USE, AND COULD REDUCE, OR IN SOME CASES, VOID, YOUR WARRANTY COVERAGE.

NOTE

IF YOU HAVE A REPAIR PERFORMED BY A NON-FOREST RIVER SERVICE CENTER, YOU MUST ENSURE THAT THE DEFECTIVE PART IS SENT BACK TO FOREST RIVER, IN ORDER FOR THE REPAIR TO BE CONSIDERED FOR WARRANTY REIMBURSEMENT.

THE FOLLOWING IS ADDED AS A REQUIREMENT OF THE NATIONAL HIGHWAY TRAFFIC SAFETY ADMINISTRATION (NHTSA).

IF YOU BELIEVE THAT YOUR VEHICLE HAS A DEFECT WHICH COULD CAUSE A CRASH OR COULD CAUSE INJURY OR DEATH, YOU SHOULD IMMEDIATELY INFORM THE NATIONAL HIGHWAY TRAFFIC SAFETY ADMINISTRATION (NHTSA) IN ADDITION TO NOTIFYING THE MANUFACTURER.

IF NHTSA RECEIVES SIMILAR COMPLAINTS, IT MAY OPEN AN INVESTIGATION AND IF IT FINDS THAT A SAFETY DEFECT EXISTS IN A GROUP OF VEHICLES, IT MAY ORDER A RECALL AND REMEDY CAMPAIGN. HOWEVER, NHTSA CANNOT BECOME INVOLVED IN INDIVIDUAL PROBLEMS BETWEEN YOU, YOUR DEALER, OR THE MANUFACTURER.

TO CONTACT NHTSA, YOU MAY EITHER CALL THE AUTO SAFETY HOT LINE, TOLL-FREE AT 1-888-327-4236, HEARING IMPAIRED, 1-800-424-9153, (OR 366-0123 IN WASHINGTON, D.C. 20590.) YOU CAN ALSO OBTAIN ADDITIONAL INFORMATION ABOUT VEHICLE SAFETY FROM THEIR WEBSITE, <http://www.safercar.gov>.

SECTION 1 CUSTOMER INFORMATION

FOREST RIVER WARRANTY REGISTRATION FORM



FOREST RIVER, INC.
CUSTOMER DELIVERY AND WARRANTY REGISTRATION FORM
DEALER TO ASSURE THAT THIS FORM IS PROPERLY COMPLETED & RETURNED TO FOREST RIVER, INC. WITHIN (10) WORKING DAYS AFTER PDLS PERFORMED. (SEE BACK OF FORM FOR CORRECT MAILING ADDRESS)

MOTORIZED

12345

OWNERS NAME:		E-MAIL ADDRESS:		DEALERS NAME:		CHASSIS VIN #	
ADDRESS: Street:	City:	State:	Zip:	ADDRESS: Street:	City:	State:	Zip:
DEL. DATE:	PHONE #:	FOREST RIVER INC. SERIAL # (LAST 7 DIGITS)		ODOMETER READING:	BRAND:	MODEL #:	

PLEASE MARK EACH ITEM OK OR NA (NOT APPLICABLE)

ELECTRICAL SYSTEM	APPLIANCES (cont.)	EXTERIOR
120 VOLT SYSTEM/CIRCUITS, BREAKERS, OPERATION	AIR CONDITIONER & THERMOSTAT	ENT. DOOR(S)/COMP. DOORS/LOCK-ALL KEYS
120 VOLT AUXILIARY GENERATOR OPERATION	MICROWAVE	ENTRANCE STEP(S) LEVEL/SECURE TO FRAME/ALIGNED
12 VOLT/CONVERTOR CIRCUITS, FUSES, OPERATION	WASHER/DRYER	PAINT GRAPHICS, SIDING IN GOOD CONDITION
GROUND FAULT CIRCUIT INTERRUPTOR (GFCI)	CENTRAL VACUUM	TRIM/SEALANTS, WINDOWS, ROOF, BODY
ALL INTERIOR LIGHTS, RECEPES, SWITCHES	LP GAS SYSTEM	AWNING DEMONSTRATED/CANVAS CHECKED
ALL EXTERIOR LIGHTS, RECEPES, SWITCHES	LOCATION OF LP LINES & CONNECTIONS SECURE	STABILIZER JACKS DEMONSTRATED
BATTERY SYSTEM	OPERATION OF REGULATOR	EXTERIOR MAINTENANCE PROCEDURES EXPLAINED
MONITOR PANEL OPERATION	EXTERIOR GRILL USE & OPERATION DEMONSTRATED	SLIDE OUT(S) (IF APPLICABLE)
PHONE/CABLE/SATELLITE FUNCTIONS	LP BOTTLES FILLED AND IN GOOD CONDITION	OPERATION & MANUAL OVERRIDE DEMONSTRATED
AUDIO/VIDEO ENTERTAINMENT SYSTEM FUNCTIONS	WATER/PLUMBING SYSTEM	INTERIOR/EXTERIOR SEALS CHECKED
PROPANE DETECTOR	POTABLE WATER INTAKE/DRAIN LOCATIONS	HYDRAULIC OR ELECTRIC PUMP/LINES CHECKED
SMOKE DETECTOR	DEMAND PUMP DEMONSTRATED	SLIDE OUT TOPPER(S) CANVAS/OPERATION CHECKED
ALL INTERIOR FANS	CITY WATER FILL CONNECTIONS	CHASSIS
STABILIZER JACKS (IF ELECTRIC)	FAUCETS/FIXTURES/TOILET, W/D-WATER PRESSURE CHECKED	CHECK ALL FLUID LEVELS
SHORE CORD INSPECTION & OPERATION	WINTERIZING PROCEDURE BY PASS DEMONSTRATED	TIRE CONDITION & PRESSURE SET @ _____ PSI (INCL. SPARE)
INVERTER OPERATION & FUNCTION	EXTERIOR SHOWER/DIAPHRAGM DEMONSTRATED	WHEEL LUG TORQUE SET PER MFG. INSTRUCTIONS
DRIVER DASH CONTROLS & SWITCHES	BLACK HOLDING TANKS/DATE VALVE OPERATIONS	HANDLING/TRANSMISSION/CRUISE/ETC.-ALL VERIFIED
HYDRAULIC LEVELING JACKS FUNCTION	GREY HOLDING TANKS/DATE VALVE OPERATIONS	GENERAL
BACK-UP CAMERA & MONITOR	FRESH WATER TANK FILLED/EMPTYED	UNIT CLEANED
APPLIANCES	TOILET OPERATION	ALL ACCESSORIES (INCLUDING REMOTES) ARE IN UNIT
FURNACE & THERMOSTAT	BLACK TANK CLEANOUT DEMONSTRATED/EXPLAINED	ALL WARRANTY FORMS ARE COMPLETED & REVIEWED
RANGE/OVEN	WATER FILTER OPERATION DEMONSTRATED	ALL REQUIRED LITERATURE IS IN UNIT
WATER HEATER	ALL FITTINGS TIGHT/NO SYSTEM LEAKS	ALL OWNERS MANUALS IN UNIT & REVIEWED
REFRIGERATOR	P-TRAPS/VENTS TIGHT/CONNECTED	

LIST DEALER INSTALLED OPTIONS (THESE ARE NOT COVERED UNDER THE FOREST RIVER, INC. LIMITED WARRANTY)

OWNER/DEALER INSPECTION REVIEW

- EXTERIOR & INTERIOR FIT & FINISH
- OPERATED ALL APPLIANCES, OPTIONAL EQUIPMENT & ACCESSORIES (REVIEWED MAINTENANCE & SAFETY OF LP GAS SYSTEM)
- EXPLAINED WEIGHT RATINGS, LIMITATIONS & PROPER LOAD DISTRIBUTION, RUNNING GEAR FRAME OR CHASSIS MAINTENANCE
- OPERATED ALL FRESH WATER & PLUMBING COMPONENTS, INCLUDING PROPER WINTERIZATION & DRAIN LOCATIONS
- REVIEWED TOW VEHICLE COWR, HITCH, SWAY CONTROL SET-UP, BRAKE CONTROL & OFFERED A TEST DRIVE WITH MY VEHICLE
- COMPLETE REVIEW OF OWNERS MANUALS & HIGHLIGHT OF SAFETY ISSUES

I have completed the above inspections on this family recreational vehicle to my satisfaction and have been offered a test drive at the time of purchase. I understand that issues regarding damage such as scratches, tears, dents, broken items, etc. will not be warranted except those noted in this space:

I have had the opportunity to review the Forest River, Inc. Limited warranty during the purchase of this unit and I understand that this product is designed to be used for recreational camping and travel. I have been given the opportunity to make notations in the space provided above, have observed or received satisfactory explanations to all questions regarding the items listed during this delivery process.

DATE: _____

PURCHASER'S SIGNATURE: _____

DEALER'S SIGNATURE: _____

F-0910

SEND TO PLANT OF UNIT ORIGIN
FOREST RIVER COPY

FOREST RIVER PRE-DELIVERY INSPECTION SHEET



FOREST RIVER, INC., DEALER PDI CHECKLIST **MOTORIZED**
DEALER IS TO ASSURE THAT THIS FORM IS PROPERLY COMPLETED & RETURNED TO FOREST RIVER, INC. WITHIN (10) WORKING DAYS AFTER PDI IS PERFORMED. (SEE BACK OF FORM FOR CORRECT MAILING ADDRESS)

12345

DEALER:	F.R. D.I.R. #:	BRAND:	MODEL:	MILEAGE:	F.R. SERIAL #:
---------	----------------	--------	--------	----------	----------------

PLEASE CHECK EACH ITEM THAT APPLIES TO UNIT WHEN ITEM IS INSPECTED

WATER SYSTEM/PLUMBING	APPLIANCES (cont.)	EXTERIOR
FRESH WATER TANK LINES CONNECTED	BEDS/PLATFORM MATTRESS/LIFTS/FUNCTION/CLEAN	120 VOLT AUXILIARY GENERATOR OPERATION
DRAIN LINES THROUGH UNDERBELLY	ALL FLOORING/APPEARANCE/FREE OF DEFECT	GROUND FAULT CIRCUIT INTERRUPTER CHECKED
DEMAND PUMP FUNCTIONS	ALL FURNITURE/APPEARANCE/FUNCTIONS/NO DEFECT	SHORE LINE/POWER CORD INSPECTED
AIR PRESSURE TEST PERFORMED ON SYSTEM	FIRE EXTINGUISHER PRESENT	ALL INTERIOR LIGHTS/RECEPES/SWITCHES CHECKED
GRAVITY WATER FILL/INLET CONNECTED	ALL TRIM/SEALANTS/PANELING FREE OF DEFECT	ALL EXTERIOR LIGHTS/RECEPES/SWITCHES CHECK
CITY WATER FILL/INLET CONNECTED	ALL MIRRORS ARE SECURE & CLEAN, NO DEFECT	BATTERY SYSTEM/DISCONNECT CHECKED
ALL FAUCETS/FIXTURES - TIGHT/WATER PRESSURE OK	LP GAS SYSTEM	MONITOR SYSTEM PANEL/OPERATION CHECKED
EXTERIOR SHOWER CONNECTED/TESTED	THE LP GAS SYSTEM WAS CHECKED	PHONE/CABLE/SATELLITE FUNCTIONS CHECKED
TOILET OPERATION CHECKED	AT _____ LOCATION HOLDING _____ IN.	AUDIO/VIDEO ENTERTAINMENT SYSTEM CHECKED
SEWER & HOLDING TANKS/FILLED & DRAINED	WC FOR _____ MIN. THE PRESSURE WAS THEN	PROPANE DETECTOR OPERATION TESTED
GATE VALVES OPERATED/TESTED/HOLD WATER	ADJUSTED TO _____ IN. WC	SMOKE/CO2 DETECTOR OPERATIONAL
SHOWER/TUB/SINKS, DRAINS HOLD WATER	LP TANK CONNECTIONS CHECKED/SECURED	ALL INTERIOR FANS/CHECKED OPERATE
ALL TRAPS & VENTS TIGHT/OPERATE	AUTO CHANGE/OPERATING	MICROWAVE FUNCTIONS TESTED
ALL FITTINGS TIGHT/NO LEAKS	COPPER LINES/NO KINKS/ROUTED PROPERLY	GENERAL APPEARANCE/CLEANLINESS/NO DEFECTS
WATER HEATER BYPASS TIGHT/FUNCTIONS	ALL APPLIANCE AIR/EXHAUST VENTS CHECKED	ENTRANCE DOOR(S) LOCK OPERATIONAL
BLACK TANK CLEANOUT TESTED/NO LEAKS	MOTORIZED PRODUCTS	COMPARTMENT DOORS/LOCK OPERATIONAL
ALL SEALANTS CHECKED AT DRAINS, SINKS, ETC	JACK & TIRE TOOLS PRESENT IF APPLICABLE	ALL KEYS PRESENT WITH UNIT
WATER FILTER CONNECTIONS TIGHT	CHECK ALL CHASSIS FLUID LEVELS	WINDOWS/SEALED & SECURED TIGHT
UNIT WINTERIZED, IF NECESSARY	POWER STEP OPERATES CORRECTLY	ROOF/VENTS/ANTENNA/A/C(S), ETC. SEALED PROPERLY
SLIDE ROOM(S) IF APPLICABLE	INVERTER OPERATION CHECKED	AWNING APPEARANCE/OPERATION CHECKED
MOTOR OR PUMP OPERATION/FLUID LEVEL CHECKED	TIRE CONDITIONS CHECKED/PRESSURE SET @ _____ PSI	GENERAL
ROOM SEALS TIGHT OPEN & CLOSED	MOTORIZED TEST DRIVE	ALL ACCESSORIES (INCL. REMOTE(S)) IN UNIT
ALL OARS/CYLINDERS/HOSE/S/WIRES CHECKED	DRIVER DASH CONTROLS/SWITCHES OPERATIONAL (INCL. HEADLAMP, DIMMER, BRAKE, REVERSE, CRUISE CONTROL, ETC)	ALL WARRANTY FORMS IN UNIT
EXTERIOR/INTERIOR SEALS FREE OF DEFECTS	BACK-UP CAMERA & MONITOR OPERATIONAL	ALL REQUIRED LITERATURE IN UNIT
ROOMS/DOORS SMOOTH IN & OUT	PARKING BRAKE CHECKED	ALL OWNERS MANUALS IN UNIT (INCL. COMPONENTS)
SLIDE OUT TOPPER(S) APPEARANCE/OPERATION	BRAKE PERFORMANCE CHECKED	UNIT CHECKED FOR ALL OPTIONS PER ORDER
INTERIOR	STEERING/HANDLING PERFORMANCE CHECKED	DEALER OPTIONS INSTALLED/CHECKED
GENERAL APPEARANCE/CLEANLINESS	TRANSMISSION PERFORMANCE CHECKED	BURN TESTING OF ALL APPLIANCES
WINDOWS/OPERATION/SCREENS/CLOSE TIGHT	SEAT BELT OPERATION CHECKED/ALL SEATS	FURNACE PILOT BURNER _____ CYCLED
CURTAINS/VALANCES/BLINDS OPERATE/CLEAN	MIRRORS CHECKED	RANGE PILOT BURNERS _____
CABINETS/DOORS/HDRW/TOPS ALIGNED/SECURED	ALL EXTERIOR LIGHTS/INDICATORS CHECK	REFRIGERATOR BURNER _____ ELECTRIC
DRAWERS/HDRW ALIGNED/OPERATE	ELECTRICAL 120/12 VOLT SYSTEM	WATER HEATER PILOT BURNER _____ CYCLED
CLOSETS/CABINET SHELVES/HDRW ALIGNED/SECURED	ROOF A/C(S) OPERATIONAL/CYCLES	EXTERIOR GRILL _____ MANUAL LIGHT & TEST
DINETTE BOOTH/TABLE SET-UP/BED CHECKED	12 VOLT POWER CONVERTOR OPERATION/CIRCUITS/FUSES	
FREE STANDING TABLES/CHAIRS/NO DEFECTS	120 VOLT SYSTEM/OPERATION/CIRCUITS/BREAKERS	

DEALER COMMENTS: _____

DEALER: I CERTIFY THAT THE TESTS & INSPECTIONS LISTED WERE PERFORMED AS INDICATED ON THE PDI CHECKLIST & DONE IN ACCORDANCE WITH ALL ACCEPTABLE INDUSTRY STANDARDS. THE UNIT DESCRIBED ABOVE HAS NO EVIDENCE OF ACCIDENT, MISUSE OR NEGLIGENCE. I ALSO CERTIFY THAT THE LP GAS & 120 VOLT SYSTEMS, THE OPERATION OF ALL COMPONENTS & APPLIANCES, THE COUPLING & UNCOUPLING PROCEDURE, ROAD TESTS & ALL WARRANTIES HAVE BEEN VERIFIED & PERFORMED PER THE RESPECTIVE MANUFACTURER'S SPECIFICATIONS. UNIT IS NOW READY FOR CUSTOMER WALK THROUGH AND DELIVERY INSTRUCTIONS.

DEALER TECHNICIAN AUTHORIZED SIGNATURE: _____ DATE PDI PERFORMED: _____

F-0905

SEND TO PLANT OF UNIT ORIGIN
FOREST RIVER COPY

SECTION 2

SAFETY and IDENTIFICATION

Coach-Net®

Technical & Roadside Assistance

WHEN YOU TAKE DELIVERY OF YOUR NEW FOREST RIVER INC. RECREATIONAL VEHICLE, YOU ARE PROVIDED WITH AN EMERGENCY ROADSIDE ASSISTANCE SERVICE - FREE. WE'VE TEAMED UP WITH THE LARGEST RV EMERGENCY ROADSIDE ASSISTANCE COMPANY IN THE COUNTRY, TO GIVE YOU IMMEDIATE ACCESS TO FAST, DEPENDABLE SERVICE WHEN AND WHERE YOU NEED IT. THIS IS A COMPREHENSIVE EMERGENCY ROADSIDE SERVICE THAT IS AVAILABLE TO YOU 24/7, AROUND THE CLOCK.

FOR COMPLETE DETAILS REGARDING HOW TO ACCESS YOUR FOREST RIVER EMERGENCY ROADSIDE ASSISTANCE AND PRODUCT SUPPORT PLAN BENEFITS, CALL 1-877-801-0333, OR SEE COMPLETE INFORMATION AT THE END OF THIS MANUAL

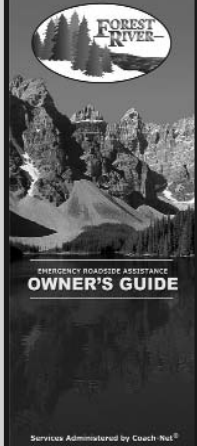

Recreational Vehicle Serial Number, Decals and Data Plates

The recreational VIN, (vehicle identification number), label is generally mounted on the inside wall of the kitchen cabinet, above the sink.

A computer generated number based upon pertinent facts about your RV. For example:

4	X	4	M	T	M	S	2	0	8	Z	0	1	2	3	4	5
(1)			(2)		(3)	(4)	(5)	(6)	(7)	(8)	(9)					
1. WORLD IDENTIFIER (4x4-Forest River)				RV-Ridgeview SS-Sunseeker				7. MODEL YEAR T-1996, V-1997, W-1998, X-1999 Y-2000, 1-2001, 2-2002, 3-2003 4-2004, 5-2005, 6-2006, 7-2007 8-2008, 9-2009								
2. UNIT TYPE (M-Multi-passenger motor vehicle)				4. UNIT LENGTH A-24", B-26', C-27', D28', E-29', F-30', G-31', H-32', J-33', K-34', L-35', M-36', N-37', P-38', R-39', S-40', T-18', U-19', V-20', W-21', X-22', Y-23', Z-24', 8-44', 9-46'				8. PLANT LOCATIONS F- 914 CR 1, Elkhart, In. G-52277 SR 19, Elkhart, In. Z-1800 W. Hively, Elkhart, In.								
3. BRAND TM-Tsunami BE-Berkshire CH-Charleston GT-Georgetown FR-Forester LE-Lexington LG-Lexington (Grand Touring)				5. NUMBER OF AXLES 2-2 Axles				9. SEQUENTIAL SERIAL # Last 6 digits--assigned at the time of manufacture								
				6. COMPUTER GENERATED DIGIT (for security purposes)												

IMPORTANT: Always give model, year, and the last 8 digits of the Forest River serial number when ordering parts. The serial number is a combination of 17 letters and digits, based upon the information listed in the above table. We recommend keeping a copy of that information in a safe place, separate from the motorhome. In the event of theft or vandalism, you may be required to supply a copy of this information to the authorities.

A vehicle data card is also supplied with your coach, listing manufacturer, model, and serial number information, for major factory installed appliances and accessories. A separate copy of this information could be useful to you in the event of theft, vandalism or disaster or when certain service functions may require it.

Decals and data plates placed throughout the recreational vehicle, aid in its' safe and efficient operation, others give service instructions. Read all decals, data and instruction plates before operating your motorhome. If any decal, data or instruction plate, has been removed, is damaged or painted over, it should be replaced.

SECTION 2

SAFETY and IDENTIFICATION

SAFETY REGULATIONS FOR LP

To provide information regarding LP gas safety, the following warnings are posted throughout your recreational vehicle. They have been installed not only because of the requirement to do so, but as a constant reminder to occupants of the motorhome, to exercise proper caution when using or being in close proximity to, LP gas appliances and equipment. We are listing them here so you may study them and be sure that you and your family understand and follow all cautions and warnings.

⚠ WARNING

LP GAS CONTAINERS SHALL NOT BE PLACED OR STORED, INSIDE THE LIVING AREA OF A RECREATIONAL VEHICLE. LP GAS CONTAINERS ARE EQUIPPED WITH SAFETY DEVICES, WHICH RELIEVE EXCESSIVE PRESSURE BY DISCHARGING GAS INTO THE ATMOSPHERE. WHEN USING OR STORING LP GAS, PROPER VENTILATION IS CRITICAL.

⚠ WARNING

IT IS NOT SAFE TO USE COOKING APPLIANCES FOR COMFORT HEATING.

Cooking appliances need fresh air for safe operation. Before operation:

1. Open overhead vent or turn on exhaust fan, **AND**
2. Open a window

A warning label is located in the cooking area to remind you to provide an adequate supply of fresh air for combustion. Unlike homes, the amount of oxygen supply is limited, due to the size of the recreational vehicle, and proper ventilation when using the cooking appliance(s) will avoid dangers of asphyxiation.

IF YOU SMELL GAS:

- Extinguish any open flames, pilot lights and all smoking materials.
- **DO NOT** touch electrical switches.
- Shut off the gas supply at the tank valve(s) or gas supply connection.
- Open doors and other ventilating openings.
- **DO NOT USE THE RANGE HOOD.**
- Leave the area until the odor clears.
- Have the system checked and leakage source corrected before using again.

⚠ WARNING

IT IS ESPECIALLY IMPORTANT THAT COOKING APPLIANCES NOT BE USED FOR COMFORT HEATING AS THE DANGER OF ASPHYXIATION AND/OR CARBON MONOXIDE POISONING IS GREATER WHEN THE APPLIANCE IS USED FOR PROLONGED PERIODS OF TIME.

⚠ WARNING

DO NOT STORE LP GAS CONTAINERS, GASOLINE, OR OTHER FLAMMABLE LIQUIDS INSIDE THE VEHICLE AS A FIRE OR EXPLOSION MAY RESULT.

⚠ WARNING

LP GAS REGULATORS MUST ALWAYS BE INSTALLED WITH THE DIAPHRAGM VENT FACING DOWNWARD. REGULATORS THAT ARE NOT IN COMPARTMENTS HAVE BEEN EQUIPPED WITH A PROTECTIVE COVER. BE SURE THAT THE REGULATOR VENT FACES DOWNWARD AND THE COVER IS KEPT IN PLACE TO MINIMIZE VENT BLOCKAGE WHICH COULD RESULT IN EXCESSIVE GAS PRESSURE CAUSING FIRE OR EXPLOSION.

⚠ DANGER

PORTABLE FUEL BURNING EQUIPMENT, INCLUDING WOOD OR CHARCOAL BURNING GRILLS AND STOVES, SHALL NOT BE USED INSIDE THE VEHICLE. DOING SO MAY CAUSE A FIRE, EXPLOSION, CARBON MONOXIDE POISONING, OR ASPHYXIATION.

DANGER! INDICATES A HAZARDOUS SITUATION WHICH, IF NOT AVOIDED, WILL RESULT IN DEATH OR SERIOUS INJURY.
CAUTION INDICATES A HAZARDOUS SITUATION WHICH COULD RESULT IN VEHICLE DAMAGE OR PERSONAL INJURY.

SECTION 2

SAFETY and IDENTIFICATION

FIRE SAFETY

Fire safety is an important part of owning a recreational vehicle. The following basic rules of fire prevention can help eliminate the possibility of a fire.

1. Never store flammable liquids in the recreational vehicle
2. Never leave cooking food unattended
3. Never smoke in bed and always use an ashtray
4. Never allow children to play with LP gas or electrical equipment
5. Never use an open flame as a flashlight
6. Always have faulty or damaged wiring and electrical components repaired immediately
7. Never overload electrical circuits
8. Locate any LP leaks and have them repaired immediately
9. Keep cooking surfaces clean and free from debris
10. Don't allow rubbish to accumulate
11. Never clean with a flammable substance
12. Spray fabrics annually with a flame retardant

SAFETY TIPS

- Be sure that everyone in your coach is familiar with the location of ALL exits, including exit windows.
- Be sure that everyone in your coach is familiar with the operation and location of fire extinguishers.
- In the event of a fire, immediately evacuate everyone from the recreational vehicle.
- DO NOT attempt to use water to put out a fire. Water can spread some types of fire and electrocution is possible. Get everyone outside, then determine if you should attempt to extinguish the fire. If it is a large fire, or a chemical fire, **DO NOT HESITATE!** Leave the vehicle immediately and call 911.

If you decide it is safe to fight a fire with an extinguisher:

- Remove the tamper tape which covers the discharge push button, (DO NOT SHAKE).
- Hold it upright and stand six to ten feet from the fire, with a clear path to an exit.
- Press the button down completely, aiming at the base of the fire, and spray using a quick, side to side sweeping motion.

TIP: Use the **'PASS'** method. Familiarize yourself and all RV occupants with this procedure:

- **P**ull the pin (some extinguishers may have a cartridge you need to push).
- **A**im the nozzle at the base of the fire.
- **S**queeze the handle to release the extinguishing agent.
- **S**pray the base of the fire. (If you aim at the flames, you won't extinguish the fire.)



NOTE

AVOID INHALING THE DRY CHEMICALS FROM THE FIRE EXTINGUISHER. ALTHOUGH NON-TOXIC, THEY COULD CAUSE TEMPORARY IRRITATION. WHEN THE FIRE IS OUT, CLEAN THE AREA AS SOON AS POSSIBLE. THE DRY CHEMICALS MAY CAUSE SURFACE DAMAGE IF LEFT TOO LONG.

DANGER

DO NOT USE WATER TO EXTINGUISH A FIRE. WATER CAN SPREAD SOME TYPES OF FIRE AND ELECTROCUTION IS POSSIBLE.

DANGER! INDICATES A HAZARDOUS SITUATION WHICH, IF NOT AVOIDED, WILL RESULT IN DEATH OR SERIOUS INJURY.

SECTION 2

SAFETY and IDENTIFICATION

UNDERWRITER LABORATORIES CLASSIFY FIRES INTO THREE TYPES:



Class A: Fires in wood, paper, fabric, rubber and certain plastics.



Class B: Flammable liquids such as grease, cooking oils, gasoline or kerosene.



Class C: Electrical fires started from live electrical wires, shorted motors/switches.

NOTE

THE FIRE EXTINGUISHER PROVIDED WITH THE RECREATIONAL VEHICLE IS A CHEMICAL TYPE SUITABLE FOR EXTINGUISHING SMALL FIRES OF THE CLASS B OR C TYPE. EXTINGUISHERS ARE DESIGNED TO PUT OUT A FIRE IN IT'S INITIAL STAGE, NOT IF IT IS BLAZING OUT OF CONTROL. IF A FIRE CANNOT BE APPROACHED WITHIN 10 FEET WITHOUT THE RISK OF CAUSING PERSONAL HARM, IMMEDIATELY EVACUATE THE MOTORHOME AND CALL 911.

TIRE SAFETY

Use the following information to make tire safety a regular part of your vehicle maintenance routine.

Safety First-Basic Tire Maintenance

Properly maintained tires improve steering, stopping, traction, and load-carrying capability of your vehicle. Under inflated tires and overloaded vehicles are a major cause of tire failure. Therefore, to avoid flat tires and other types of tire failures you should maintain proper tire pressure, observe tire and vehicle load limits, avoid road hazards and regularly inspect your tires.

Finding Your Vehicle's Recommended Tire Pressure and Load Limits

MANUFACTURED BY / FABRIQUE PAR:		DATE:	
DESIGNATED SEATING CAPACITY / NOMBRE DÉSIGNÉ DE PLACES ASSISSES:		X 70 KG = KG (LB)	
GVWR/PNBV		KG (LB)	TIRES/PNEU
GAWR/PNBE		KG (LB)	RIMS/JANTE
FRONT/ AVANT		KG (LB)	COLD INFL. PRESS./PRESS. DE GONFL. A FROID
INTERM/ INTERM		KG (LB)	KPA SINGLE DUAL PSI/LPC) <input type="checkbox"/> <input type="checkbox"/>
REAR/ ARRIERE		KG (LB)	KPA SINGLE DUAL PSI/LPC) <input type="checkbox"/> <input type="checkbox"/>

THIS VEHICLE CONFORMS TO ALL APPLICABLE U.S. FEDERAL MOTOR VEHICLE SAFETY STANDARDS IN EFFECT ON THE DATE OF MANUFACTURE SHOWN ABOVE.
 THIS VEHICLE CONFORMS TO ALL APPLICABLE STANDARDS PRESCRIBED UNDER THE CANADIAN MOTOR VEHICLE SAFETY REGULATIONS IN EFFECT ON THE DATE OF MANUFACTURE. - CE VEHICULE EST CONFORME A TOUTES LES NORMES QUI LUI SONT APPLICABLES EN VERTU DU REGLEMENT SUR LA SECURITE DES VEHICULES AUTOMOBILES DU CANADA EN VIGUEUR A LA DATE DE SA FABRICATION.

V.I.N./N.I.V.: _____ TYPE/TYPE: _____ FR2286

TIRE STICKER

The tire information and vehicle certification label, contains information on tires and load limits. These labels indicate the vehicle manufacturer's information including:



- Recommended tire size
- Recommended tire inflation pressure
- Gross Vehicle Weight Rating (GVWR-the maximum occupant and cargo weight a vehicle is designed to carry)
- Front and rear gross axle weight ratings (GAWR-the maximum weight the axle systems are designed to carry.)

SECTION 3

LOADING, WEIGHING and TOWING

Understanding Tire Pressure and Load Limits

Tire inflation pressure, is the level of the air in the tire that provides it with load-carrying capacity, and affects the overall performance of the vehicle. This number that indicates the amount of air pressure, measured in pounds per square inch (psi) a tire requires to be properly inflated. Vehicle manufacturers determine this number based on the vehicles' design load limit which is the greatest amount of weight a vehicle can safely carry and the vehicle's tire size. The proper tire pressure for your vehicle is referred to as the 'recommended cold inflation pressure'. Tire pressure should always be measured when the tire is 'cold' to get an accurate measurement. A cold tire is one that hasn't been driven on for at least 3 (three) hours. As you drive, your tires get warmer, causing the air pressure within the tire to increase. Therefore, you can not get an accurate measurement of tire pressure unless the tire is cold.

Checking Tire Pressure

Because tires are designed to be used on more than one type of vehicle, tire manufacturers list the 'maximum permissible inflation pressure' on the sidewall. The number is the greatest amount of air pressure that should ever be put in the tire under normal driving conditions. It is important to check your vehicle's tire pressure at least once a month for the following reasons:

- Most tires naturally lose air pressure over time.
- Tires can lose air suddenly if you drive over a pothole or strike the curb when parking.
- With radial tires it is usually not possible to determine under inflation by visual inspection.

NOTE: For your convenience, purchase a tire pressure gauge to keep in your motorhome.

Tire Safety Tips

Preventing Tire Damage:

- Slow down, if you have to go over a pothole or other object in the road.
- Do not run over foreign objects in the roadway, and avoid striking the curb when parking.

Tire Safety Checklist

- Check tire pressure regularly (at least once a month), including the spare.
- Inspect tires for uneven wear patterns on the tread, cracks, foreign objects, or other signs of wear or trauma.
- Remove bits of glass and any other foreign objects wedged in the tread.
- Make sure your tire valves have valve caps.
- Check tire pressure before going on a long trip.
- Do not overload your vehicle. Check the tire information placard for the maximum recommended load for the vehicle.
- If you are towing a car or trailer, remember that some of the weight of the loaded car or trailer is transferred to the towing vehicle.

Tire Fundamentals

Federal law requires tire manufacturers to place standardized information on the sidewall of all tires. This information identifies and describes the fundamental characteristics of the tire, and provides a tire identification number, for safety standard certification, and in the event of a recall.

SECTION 3

LOADING, WEIGHING and TOWING

P

Indicates the tire is for passenger vehicles.

Next (3 Digit) Number

Gives the width in millimeters of the tire from sidewall edge to sidewall edge. In general, the larger the number, the wider the tire.

Next (2 Digit) Number

Gives the tire's ratio of height to width, (known as the aspect ratio). Numbers of 70 or lower indicate a short sidewall for improved steering response and better overall handling on dry pavement.

R

'R' stands for radial. Radial ply construction of tires is the industry standard.

Next number

This two-digit number is the wheel or rim diameter in inches. If you change your wheel size, you will have to purchase new tires to match the new wheel diameter.

Next number

This two or three digit number is the tire's load index. It is a measurement of how much weight each tire can support. Note: You may not find this information on all tires since it is not required by law.

M+S

'M+S' or 'M/S' indicates that the tire has some mud and snow capability. Most radial tires have these markings; hence, they have some mud and snow capability.

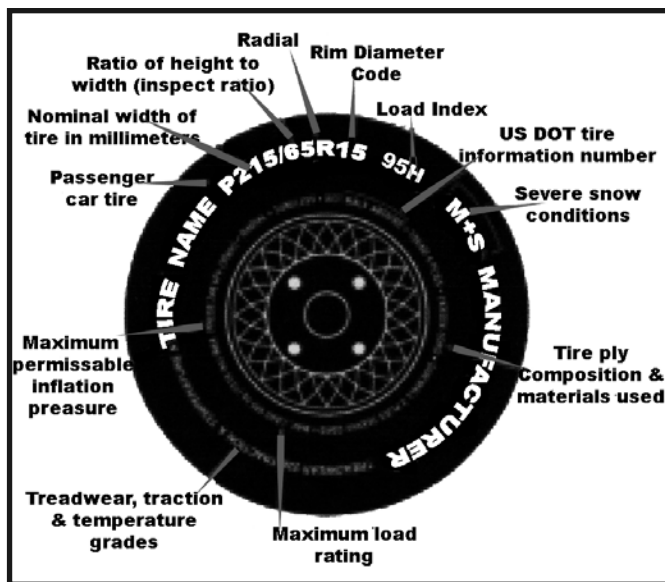

IMPORTANT NOTE:

IF IT BECOMES NECESSARY TO REPLACE A TIRE AND YOU FEEL IT IS A WARRANTY ISSUE, MOST TIRE MANUFACTURERS REQUIRE THE D.O.T. NUMBER TO BE CUT OUT AND RETURNED TO THEM, WITH THE WARRANTY CLAIM, OTHERWISE, THE TIRE WARRANTY COULD BE VOIDED.

Q 99 mph	H 130 mph
R 106 mph	V 149 mph
S 112 mph	W 168 mph*
T 118 mph	Y 186 mph*
U 124 mph	

For tires with a maximum speed capability over 149 mph, tire manufacturers sometimes use the letters ZR. For those with a maximum speed capability over 186 mph, tire manufacturers always use the letters ZR.

SECTION 3

LOADING, WEIGHING and TOWING

S. DOT Tire Identification Number

This number begins with the letters 'DOT', and indicates that the tire meets all federal standards. The next two numbers or letters, are the plant code where the tire was manufactured, and the last four numbers represent the week and year the tire was built. For example, the numbers 3197 means the 31st week of 1997. The other numbers are marketing codes, used at the manufacturer's discretion. This information is used to contact consumers if a tire defect requires a recall.

Tire Ply Composition and Materials Used

The number of plies indicates the number of layers of rubber-coated fabric in the tire. In general, the greater the number of plies, the more weight a tire can support. Tire manufacturers also must indicate the materials used in the construction of the tire, which could include steel, nylon, or polyester, to name a few.

Maximum Load Rating

Load rating indicates the maximum load in kilograms and pounds that can be carried by the tire.

Maximum Permissible Inflation Pressure

This number is the greatest amount of air pressure that should ever be put in the tire under normal driving conditions.

Speed Rating

Speed rating denotes the speed at which a tire is designed to be driven for extended periods of time. Note: This information may not appear on all tires since it is not required by law.

Treadwear Number

This number indicates the tire's wear rate. The higher the treadwear number is, the longer it should take for the tread to wear down. For example, a tire graded 400 should last twice as long as a tire graded 200.

Traction Letter

This letter indicates a tire's ability to stop on wet pavement. A higher graded tire should allow you to stop your car on wet roads in a shorter distance than a tire with a lower grade. Traction is graded from highest to lowest as 'AA', 'A', 'B', and 'C'.

Temperature Letter

This letter indicates a tire's resistance to heat. The temperature grade is for a tire that is inflated properly and not overloaded. Excessive speed, underinflation or excessive loading, either separately or in combination, can cause heat build-up and possible tire failure. From highest to lowest, a tire's resistance to heat is graded as 'A', 'B', or 'C'.

TIRE TIPS

- 
- Make sure all of the lug nuts are secure. Use a torque wrench. **DO NOT** guess.
 - Inspect tires for uneven wear patterns on the tread, for cracks, for foreign objects or for other signs of wear or trauma.

SECTION 3

LOADING, WEIGHING and TOWING



- If you are towing a car or trailer, remember that some of the weight of the loaded vehicle that is being towed, is transferred to the motorhome.
- Your motorhome should have the wheel bearings repacked after being in storage for any prolonged period of time.

DO NOT OVERLOAD YOUR VEHICLE.

CHECK THE TIRE INFORMATION PLACARD FOR THE MAXIMUM RECOMMENDED LOAD FOR THE VEHICLE.

TIGHTEN EACH LUG NUT IN THE ORDER SHOWN

Start all lug nuts by hand to prevent cross threading. Tighten opposite sides of wheel; starting at 1 and go to 2, then 3 and 4, etc. Wheel lug nut torque requirements vary, depending on the size and manufacturer of the wheel. If this information differs from the wheel manufacturer's information, use the wheel manufacturers recommendation. Listed here are some lug nut torque examples, by chassis manufacturer: (The above information is for example only. For more specific information, please refer to the chassis owner's manual that you received along with your Forest River Owner's packet.)

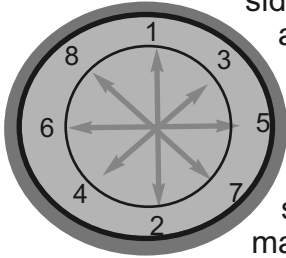

1. Ford E-450	150 ft./lbs.
2. Ford F-53	150
3. Chev/GM	140
4. Workhorse (P)	140
5. Workhorse (W)	475
6. Freightliner	400

NEVER EXCEED THE WHEEL MANUFACTURER'S RECOMMENDATIONS.



IT IS RECOMMENDED THAT WHEEL BEARINGS BE REPACKED YEARLY.



IT IS IMPORTANT TO MAINTAIN PROPER WHEEL NUT TORQUE TO PROVIDE SAFE AND SECURE ATTACHMENT OF THE WHEEL TO THE HUB/DRUM.



BE SURE TO USE WHEEL NUTS THAT ARE COMPATIBLE WITH THE COIN IN THE WHEEL. IMPROPERLY TORQUED WHEEL NUTS CAN CAUSE THE WHEEL TO SEPARATE FROM THE WHEEL MOUNTING SURFACE DURING OPERATION. THIS COULD RESULT IN PROPERTY DAMAGE, SERIOUS PERSONAL INJURY OR LOSS OF LIFE.



DO NOT PLACE A JACK AGAINST THE MOTORHOME UNDERBELLY WHEN CHANGING A TIRE. TO AVOID DAMAGE TO YOUR UNIT, BE SURE THE JACK IS PLACED FIRMLY AGAINST THE CHASSIS FRAME.

CARGO CARRYING CAPACITY

Determining the weight of a vehicle includes more than understanding the load limits of the tires. A weight certification label, located on the back wall of the kitchen cabinet over the sink, will indicate the gross axle weight (GAWR). This is the most weight the fully loaded vehicle can weigh. If there are multiple axles, the GAWR of each axle will be provided. Look in your Yellow Pages under gravel pits, storage companies or recycling facilities to find certified scales. Call in advance to determine if they offer public weighing service, their fees, if any, and hours of operation.



WHEN ESTABLISHING THE CARGO CAPACITY, WEIGH WITH ALL WATER TANKS AS EMPTY AS POSSIBLE. (DO NOT ALLOW ANYONE TO BE IN THE RECREATIONAL VEHICLE WHEN WEIGHING THE MOTORHOME.)

'WARNING' INDICATES A HAZARDOUS SITUATION WHICH, IF NOT AVOIDED, COULD RESULT IN DEATH OR SERIOUS INJURY.
CAUTION INDICATES A HAZARDOUS SITUATION WHICH, IF NOT AVOIDED, COULD RESULT IN VEHICLE DAMAGE OR MINOR TO MODERATE INJURY.

SECTION 3 LOADING, WEIGHING and TOWING

NOTE

CARGO CAN BE ADDED TO THE VEHICLE UP TO THE MAXIMUM WEIGHT SPECIFIED ON THE WEIGHT LABEL. THE COMBINED WEIGHT OF THE RV AND THE CARGO CAN NOT EXCEED THE STATED GVWR.

<p>MOTOR HOME OCCUPANT AND CARGO CARRYING CAPACITY: UVW 27318 VIN: 4UZACBBV57CY97966</p> <p>THE COMBINED WEIGHT OF OCCUPANTS AND CARGO SHOULD NEVER EXCEED:</p> <p>2128 kg or 4682 lbs Safety belt equipped seating capacity:</p> <p>Caution: A full load of water equals 0 kg or 0 lbs of cargo @ 1 kg/l (8.33 lbs/gal) Weight of towed trailer counts as cargo</p>	<p>Seating Capacity (total) (front) (rear)) The weight of Cargo Should Never Exceed: 2128 kgs or 4682 lbs.</p> <p>275/80R22.5/G 759 kpa 110 psi 275/80R22.5/G 759 kpa 110 psi 275/80R22.5/G 759 kpa 110 psi</p>	<p>BAR CODE</p> <p style="font-size: 1.2em;">5NHBGSP207F006652</p>	<p>BAR CODE</p> <p style="font-size: 1.2em;">GSF006652</p>																						
<p>MOTOR HOME OCCUPANT AND CARGO CARRYING CAPACITY: UVW 27318 VIN: 4UZACBBV57CY97966</p> <p>THE COMBINED WEIGHT OF OCCUPANTS AND CARGO SHOULD NEVER EXCEED:</p> <p>2128 kg or 4682 lbs Safety belt equipped seating capacity:</p> <p>Caution: A full load of water equals 0 kg or 0 lbs of cargo @ 1 kg/l (8.33 lbs/gal) Weight of towed trailer counts as cargo</p>	<p>Seating Capacity (total) (front) (rear)) The weight of Cargo Should Never Exceed: 2128 kgs or 4682 lbs.</p> <p>275/80R22.5/G 759 kpa 110 psi 275/80R22.5/G 759 kpa 110 psi 275/80R22.5/G 759 kpa 110 psi</p>	<table border="1" style="width: 100%; border-collapse: collapse;"> <tr> <td style="width: 15%;">GAWR/PNBE</td> <td style="width: 15%;">TIRES/PNEU</td> <td style="width: 15%;">RIMS/ÖANTE</td> <td style="width: 15%;">COLD INFL PRESS/</td> <td style="width: 15%;">PRESS DE FONFL A FROID</td> <td rowspan="3" style="width: 20%; vertical-align: top; font-size: 0.8em;"> THIS VEHICLE CONFORMS TO ALL APPLICABLE U.S. FEDERAL MOTOR VEHICLE SAFETY STANDARDS IN EFFECT ON THE DATE OF MANUFACTURE SHOWN ABOVE. THIS VEHICLE CONFORMS TO ALL APPLICABLE STANDARDS PRESCRIBED UNDER THE CANADIAN MOTOR VEHICLE SAFETY REGULATIONS IN EFFECT ON THE DATE OF MANUFACTURE. CE VEHICULE EST CONFORME A TOUTES LES NORMES QUI UI SONT APPLICABLES EN VERTU DU REGLEMENT SUR LA SECURITE DES VEHICLES AUTOMOBILES DU CANADA EN VIGUEUR A LA DATE DE SA FABRICATION. </td> </tr> <tr> <td>FRONT 5443 KG AVANT (12000 LB)</td> <td>275/80R22.5/G</td> <td>22.5X7.5</td> <td>759 KPA (110 PSI)</td> <td>SINGLE <input type="checkbox"/> DUAL <input type="checkbox"/></td> </tr> <tr> <td>INTERM/ NTERM (LB)</td> <td></td> <td></td> <td>KPA (PSI)</td> <td>SINGLE <input type="checkbox"/> DUAL <input type="checkbox"/></td> </tr> <tr> <td>REAR 9072 KG APRIERE (20000 LB)</td> <td>275/80R22.5/G</td> <td>22.5X7.5</td> <td>621 KPA (90 PSI)</td> <td>SINGLE <input type="checkbox"/> DUAL <input checked="" type="checkbox"/></td> <td></td> </tr> </table>	GAWR/PNBE	TIRES/PNEU	RIMS/ÖANTE	COLD INFL PRESS/	PRESS DE FONFL A FROID	THIS VEHICLE CONFORMS TO ALL APPLICABLE U.S. FEDERAL MOTOR VEHICLE SAFETY STANDARDS IN EFFECT ON THE DATE OF MANUFACTURE SHOWN ABOVE. THIS VEHICLE CONFORMS TO ALL APPLICABLE STANDARDS PRESCRIBED UNDER THE CANADIAN MOTOR VEHICLE SAFETY REGULATIONS IN EFFECT ON THE DATE OF MANUFACTURE. CE VEHICULE EST CONFORME A TOUTES LES NORMES QUI UI SONT APPLICABLES EN VERTU DU REGLEMENT SUR LA SECURITE DES VEHICLES AUTOMOBILES DU CANADA EN VIGUEUR A LA DATE DE SA FABRICATION.	FRONT 5443 KG AVANT (12000 LB)	275/80R22.5/G	22.5X7.5	759 KPA (110 PSI)	SINGLE <input type="checkbox"/> DUAL <input type="checkbox"/>	INTERM/ NTERM (LB)			KPA (PSI)	SINGLE <input type="checkbox"/> DUAL <input type="checkbox"/>	REAR 9072 KG APRIERE (20000 LB)	275/80R22.5/G	22.5X7.5	621 KPA (90 PSI)	SINGLE <input type="checkbox"/> DUAL <input checked="" type="checkbox"/>		<p>MANUFACTURED BY / FABRIQUE PAR: FOREST RIVER, INC. DATE: 3/20/2007 VIN: 4UZACBBV57CY97966 TYPE/TYPÉ BUS: F8038 GSF006652 GVWR/PNBE: 14515 KG (32000 LB) INC. VEL MFG. BY: FORD MOTOR CO DESIG. SEAT CAP. NOMBRE/D'ESIGNE DE PLACES ASSISES: 29 X 70 KG = 1973kg or 25x150 lbs=4350.</p>
GAWR/PNBE	TIRES/PNEU	RIMS/ÖANTE	COLD INFL PRESS/	PRESS DE FONFL A FROID	THIS VEHICLE CONFORMS TO ALL APPLICABLE U.S. FEDERAL MOTOR VEHICLE SAFETY STANDARDS IN EFFECT ON THE DATE OF MANUFACTURE SHOWN ABOVE. THIS VEHICLE CONFORMS TO ALL APPLICABLE STANDARDS PRESCRIBED UNDER THE CANADIAN MOTOR VEHICLE SAFETY REGULATIONS IN EFFECT ON THE DATE OF MANUFACTURE. CE VEHICULE EST CONFORME A TOUTES LES NORMES QUI UI SONT APPLICABLES EN VERTU DU REGLEMENT SUR LA SECURITE DES VEHICLES AUTOMOBILES DU CANADA EN VIGUEUR A LA DATE DE SA FABRICATION.																				
FRONT 5443 KG AVANT (12000 LB)	275/80R22.5/G	22.5X7.5	759 KPA (110 PSI)	SINGLE <input type="checkbox"/> DUAL <input type="checkbox"/>																					
INTERM/ NTERM (LB)			KPA (PSI)	SINGLE <input type="checkbox"/> DUAL <input type="checkbox"/>																					
REAR 9072 KG APRIERE (20000 LB)	275/80R22.5/G	22.5X7.5	621 KPA (90 PSI)	SINGLE <input type="checkbox"/> DUAL <input checked="" type="checkbox"/>																					

- GVWR** - Gross Vehicle Weight Rating - the maximum permissible weight of the fully loaded RV.
- GAWR** - Gross Axle Weight Rating - the allowable weight, including cargo, that can be safely supported by each axle.
- UVW** - Unloaded Vehicle Weight - the weight of the motorhome as manufactured at the factory. It includes all weight at the motorhome axle(s). If applicable, it also includes full generator fluids including fuel, engine oil and coolants.
- CCC** - Cargo Carrying Capacity - equal to GVWR minus UVW and water weight, (water in all tanks, including the water heater), and the weight of fully filled propane containers.
- GCWR** - Gross Combination Weight Rating is the maximum allowable loaded weight of this motorhome and any towed trailer or towed vehicle. (The maximum load capacity is determined by the manufacturer of the motorhome.)
- SCWR** - Sleeping Capacity Weight Rating - the manufacturer's designated number of sleeping positions multiplied by 154 pounds, (70 kilograms).

Water weight and the weight of fully filled propane containers is considered part of the weight of the RV before it is loaded with cargo and is not considered part of the disposable cargo load. Water, however, is a cargo weight and is treated as such. If there is a fresh water storage tank of 100 gallons, when filled this tank would weigh about 800 pounds.

If needed, water can be off-loaded to keep the total amount of cargo added to the vehicle within the limits of the GVWR. Understanding this flexibility allows you to make choices that fit your travel and camping needs.

WEIGHING YOUR MOTORHOME

In order to properly compute your load and load distribution, you must know both actual scale weights, and the GAWR and GVWR, found on the Weight Label on the motorhome. Weigh the motorhome with all anticipated passengers, equipment, luggage, and fluids on board, as if you were beginning your trip. You will also need to weigh the motorhome periodically, to ensure you are maintaining the correct weight and load distribution.

SECTION 3

LOADING, WEIGHING and TOWING

To properly weigh your motorhome, follow this procedure:

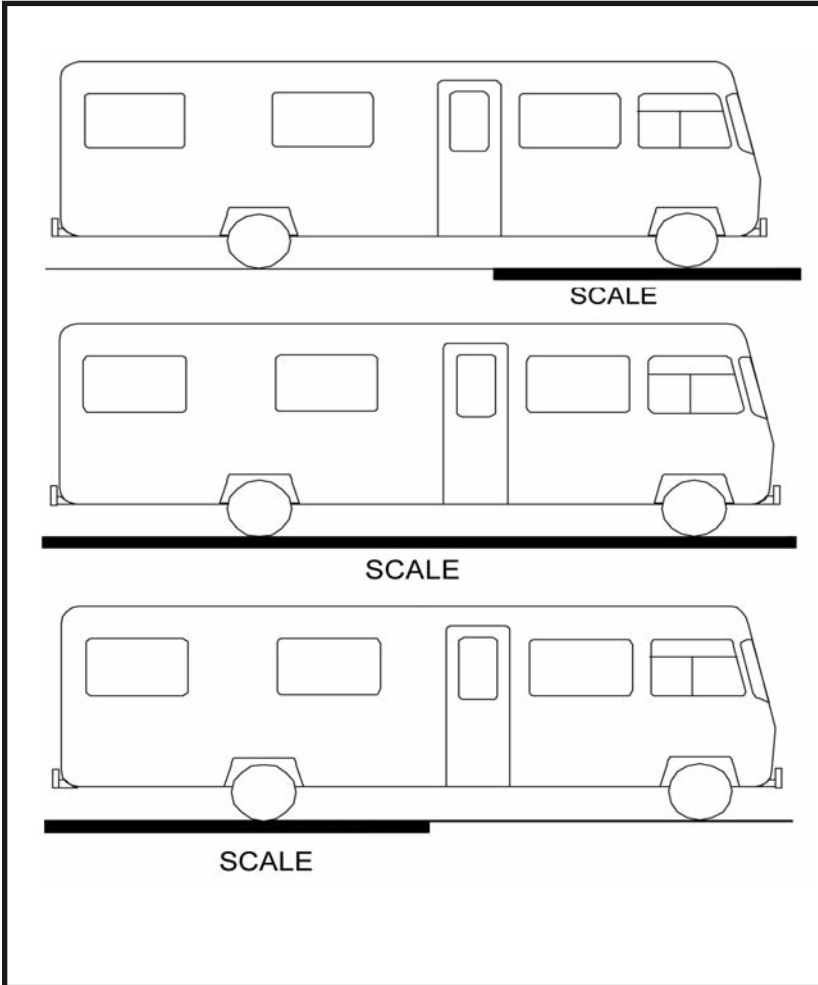

POSITIONING MOTORHOME ON WEIGHT SCALES

1. With all passengers in their seats, the unit fully loaded and level, pull onto the scales until the front axle **ONLY** is on the scale. Check the weight against the front gross axle weight rating.
2. Pull forward until both axles are on the scale. Check the weight against the gross vehicle weight rating.
3. Pull forward again so that only the rear axle is on the scale. Check the weight against the rear gross axle weight rating.

EXAMPLE:

GVWR 14,500 lb.
 GVW 12,570 lb. (scale weight)

Reserve Capacity 1,930 lb.

Front GAWR 5,000 lb.
 Front GAW 3,680 lb. (scale weight)

Front Axle Reserve capacity 1,320 lb.

Rear GAWR 10,000 lb.
 Rear GAW 8,891 lb. (scale weight)

Rear Axle Reserve Capacity 1,110 lb.

(ABOVE WEIGHTS ARE FOR EXAMPLE ONLY AND NOT ACTUAL WEIGHTS)

Properly inflated tires wear longer and contribute to safer handling. Check tire pressure only when the tires are cold (not used for at least 3 hours).

WARNING NEVER LET AIR OUT OF A HOT TIRE TO REDUCE PRESSURE. DOING SO COULD CAUSE AN EXPLOSION, POSSIBLY RESULTING IN PERSONAL INJURY.

At this point, if you have any overload or imbalance, redistribute the weight and reweigh the motorhome. When you become familiar with how to load and weigh your RV, make a list and diagram, to carry with you for easy reference.





NOTE WEIGHT DISTRIBUTION IS EXTREMELY IMPORTANT IN THE HANDLING AND WEAR OF YOUR MOTORHOME. REMEMBER TO ADD THE WEIGHT OF ANY ITEMS PURCHASED ON YOUR TRIP TO THE STARTING WEIGHT OF YOUR COACH, AND TO DISTRIBUTE THE WEIGHT EVENLY. ALSO KEEP IN MIND, THAT IF YOU MAKE ANY MAJOR CHANGES IN THE ITEMS YOU ARE CARRYING, IT WILL BE NECESSARY TO REWEIGH YOUR UNIT.

WARNING INDICATES A HAZARDOUS SITUATION WHICH, IF NOT AVOIDED, COULD RESULT IN DEATH OR SERIOUS INJURY.



SECTION 3

LOADING, WEIGHING and TOWING

WEIGHING TIPS

-  • Weights of stored items vary greatly and will affect the total weight of your recreational vehicle. Always weigh the recreational vehicle at a certified weigh station equipped with platform scales. (Remember that wind and rain can cause weights to be inaccurate.)
-  • Check the telephone directory or with local authorities, for the location of weigh stations in your area. If you find that you have exceeded the GVWR of the recreational vehicle, you will have to remove items until you are within the specified limits. If you find that you have exceeded either of the GAWR's, you will need to redistribute the load within the recreational vehicle to meet the specified limits.
-  • To help insure that items will be evenly distributed, plan ahead before loading your RV. Not only will the recreational vehicle handle and ride better, you will also have reduced tire wear and increased fuel economy.
-  • When weighing the recreational vehicle, weigh both right and left hand sides separately. This will insure that you have not overloaded one side or the other, affecting handling. DO NOT store heavy items near the front or rear of the RV, as doing so could cause damage.
-  • To help keep weight reduced, empty the holding tanks before leaving on a trip, and as often as possible when traveling. Carry only as much water as you will need for traveling. If needed, the water tanks can be used to help balance the weight in the motorhome, (a gallon of water weighs 8 pounds).
- Secure all items stored inside and outside the recreational vehicle, and be sure all doors and drawers are securely latched or shut.

LOADING TIPS:

-  • Make a list of items to pack, (flashlight, electrical cords, rain gear, emergency flares, first aid, etc.) Before storing in an exterior compartment, plastic wrap items that could be damaged by water.
-  • Using the diagram you made, load your unit, from bottom to top, heaviest items on the floor and the lightest items in the cupboards.
-  • Keep your emergency gear and frequently used items, in the front of the storage area, for easy accessibility.
- Cargo should be stored on the exterior of the RV only if the RV was factory equipped with such storage capacity.
- If you won't need much water until you reach your travel destination, avoid filling the water tanks to maximum capacity. Water is very heavy and the weight will decrease the amount of cargo you can carry.

NOTE

FOR EVERY 100 LBS. OF WEIGHT, THERE IS A PENALTY OF 1% ON YOUR FUEL USAGE. A GALLON OF WATER WEIGHS 8 LBS. IF YOU ADD 30 GALLONS OF WATER TO YOUR FRESH WATER TANK, MULTIPLYING 30 GALLONS BY 8 LBS. WILL RESULT IN 240 POUNDS OF EXTRA WEIGHT. (IF NEEDED, YOU CAN ALSO USE YOUR WATER TANKS TO HELP BALANCE YOUR UNIT BY ADDING OR DECREASING THE AMOUNT OF WATER IN THE TANKS.)

WARNING

DO NOT USE YOUR MOTORHOME AS A CARGO CARRIER. DO NOT ADD EXTERIOR ROOFTOP OR REAR-END STORAGE COMPARTMENTS, CABINETS OR CLOSETS. SUCH ADDITIONS COULD CAUSE DAMAGE TO THE RV OR COMPONENTS AND POSSIBLY VOID YOUR WARRANTY.

'WARNING' INDICATES A HAZARDOUS SITUATION WHICH, IF NOT AVOIDED, COULD RESULT IN DEATH OR SERIOUS INJURY.

SECTION 3

LOADING, WEIGHING and TOWING

Following is a list of items you may find useful to take along.

- | | | |
|--|--|---|
| <ul style="list-style-type: none"> • <u>First aid kit</u> • <u>Spare fuses</u>
12 volt automotive type • <u>Tool kit</u>
Phillips, square head and regular slotted screw drivers, pliers and crescent wrench, a bubble level, open-end wrenches that fit the water and gas line fittings), a 'good' tire pressure gauge, electrical tape and a flashlight. • <u>Water hose</u>
Minimum of 25 feet, used to fill water tank and to connect to city water. | <ul style="list-style-type: none"> • <u>Extension cord.</u>
Three or four prong-MUST be rated for the load for which your motorhome was designed, either 30 or 50 amp. • <u>Holding tank chemicals</u> • <u>Registration and insurance information,</u>(for motorhome and towed vehicle). • <u>Spare set of keys</u> • <u>Three pieces of 2" thick x 6" wide x 10" long pieces</u> | <ul style="list-style-type: none"> <u>of wood,</u> for leveling the vehicle in uneven camping areas. Even if you have leveling jacks built in, they may come in handy. The wood can also be used as chocks to help prevent the unit from rolling forward or backward, if you are parked on an uneven site. • <u>Throw rug</u>
Protect the entry area carpet. • <u>Emergency Contact Phone Numbers</u> |
|--|--|---|

ONE FINAL CHECK

After you have loaded your unit for your trip, weighed it, and made sure you are within the specified weight limits, there's one final check you need to perform. Starting on the outside of the vehicle, perform a visual, walk-around check.

Here are some things to look for:

1. All exterior storage doors and hatches are securely shut and latched.
2. Taillights, brake lights, headlights and turn signal lights are functioning properly.
3. City water hose is disconnected and stowed. The connection cap has been tightly secured.
4. Holding tank valves are closed and dump outlet cap is securely fastened, and sewer hose is stowed.
5. Power cord is unplugged and stored.
6. TV/satellite antenna is lowered, (if equipped).
7. Tire pressure is within specified limits. (Always check tire pressure when tires are cold-at least three hours after being driven on.) Releasing air from a heated tire is dangerous.
8. Lug nuts are tight and wheel covers are secure.
9. All liquid levels are adequate, (chassis engine oil, transmission fluid, engine coolant, battery fluid and windshield washer solution.)
9. Roof vents are closed.
10. Fresh water tank, sewage holding tank, and LP tank, are at correct levels.
11. Entrance door is securely closed and locked, and entry step is retracted.
12. Check the campsite for items left behind and that you left it clean and safe for the next campers.

The last thing you need to do before getting on the road, is to check the side view mirror position. If needed, have someone help adjust the mirror from the outside, while you view the mirror position from the drivers seat. Doing so will ensure that the mirror is in the correct position for your height. If your motorhome is equipped with a rear vision system, check it at this time also.

SECTION 3

LOADING, WEIGHING and TOWING

As you sit in the driver's seat, you will notice that you sit up higher, and further to the left than in a passenger car. Your perspective of the road will also be different. Due to the driver's seat location, and the configuration of the motorhome, you will need to rely more on the outside mirrors than if you driving a passenger car. Your motorhome is also longer than your car, therefore be extra observant and cautious when making turns, and when pulling into traffic.

WARNING

SWERVES AND SHARP TURNS, ESPECIALLY AT HIGHER SPEEDS, COULD RESULT IN LOSS OF VEHICLE CONTROL.

BEFORE YOU LEAVE

Become familiar with your coach and its' features. This manual, the chassis manual, and the various appliance and accessory manuals, contain important information about the use and care of your RV and its' components. It is important that you read them carefully, and keep them with your vehicle for future reference.

If you have not had experience driving vehicles larger than passenger vehicles, we recommend that you take several test drives around your neighborhood before your first camping trip. Doing so will help develop a feel for your RV's handling characteristics and gain experience in driving a larger vehicle. While on your test drive, practice parking and backing up. If available, also practice backing up using your back up camera and monitor.

We also recommend that you make your first camping experience a short one and close to home. This will give you the opportunity to learn the use of the vehicle in actual camping conditions. Being close to home will also be more convenient if you need additional instruction from your local dealer. You will also discover which items you didn't bring, that you may need or that would make your camping experience more comfortable and enjoyable.

NOTE

SINCE ONLY ONE CORNER CAN BE WEIGHED AT A TIME, THE REMAINING THREE CORNERS NEED TO BE AS CLOSE TO THE SCALE AS POSSIBLE WITHOUT BEING ON THE SCALE, AND BE SURE THE MOTORHOME IS AS LEVEL AS YOU CAN MAKE IT.

TOWING A VEHICLE, BOAT OR TRAILER

Before deciding whether to tow a car, boat or trailer behind your motorhome, consider the following warnings regarding weights and braking ability:

1. **DO NOT** exceed the motorhome's GCWR (gross combined weight rating), or the hitch rating. You must include the weight of the fully loaded coach (with all occupants, or allowing an average of 150 lbs. per person), and the towed vehicle, combined. The combined weight **MUST NOT** exceed the GCWR. (**DO NOT** assume you can tow a vehicle which is within the capacity of the hitch without considering the fully loaded weight of the motorhome **PLUS** the weight of the towed vehicle. The two combined may exceed the total GCWR of the motorhome. Allow your selling dealer to determine the GCWR of your motorhome.)

'WARNING' INDICATES A HAZARDOUS SITUATION WHICH, IF NOT AVOIDED, COULD RESULT IN DEATH OR SERIOUS INJURY.

SECTION 3

LOADING, WEIGHING and TOWING



- 2. The tongue weight (the amount of weight or pressure pushing down on the hitch), **MUST NOT** exceed 10% of the hitch capacity. (Example: If your hitch capacity is 5,000 lbs. of pulling capacity, **DO NOT** exceed 500 lbs. of weight on the hitch; if your hitch capacity is 3,500, **DO NOT** exceed 350 lbs. of weight on the hitch, etc.) Check the tag on your hitch for pulling and weight limits.

- 3. Always use safety chains between your coach and the towed object. **NEVER** attach the chains to the bumper. Cross the chains under the trailer tongue and allow slack in the chains for turning corners.

- 4. **NEVER** attempt short back up distances when towing. Most towing equipment is designed to be pulled forward, not pushed backward. Doing so could result in damage to the motorhome, towed object, or the towing device.



IF YOUR MOTORHOME SHOULD REQUIRE TOWING, CONSULT YOUR CHASSIS MANUFACTURER'S OWNER'S MANUAL FOR THE CORRECT TOWING PROCEDURE.

BRAKING SYSTEM

Your motorhome braking system is rated for operating within the GVWR, (gross vehicle weight rating), NOT for GCWR, (gross combined weight rating). **NEVER** exceed the GVWR or the GCWR.



A SEPARATE FUNCTIONING BRAKING SYSTEM IS REQUIRED FOR ANY TOWED VEHICLE OR TRAILER, WEIGHING MORE THAN 1,000 LBS., WHEN FULLY LOADED.



FAILURE TO HEED ANY PART OF THE ABOVE WARNINGS COULD CAUSE AN ACCIDENT, RESULTING IN SERIOUS INJURY OR DEATH.

END OF SECTION

DANGER! INDICATES A HAZARDOUS SITUATION WHICH, IF NOT AVOIDED, WILL RESULT IN DEATH OR SERIOUS INJURY.
'WARNING' INDICATES A HAZARDOUS SITUATION WHICH, IF NOT AVOIDED, COULD RESULT IN DEATH OR SERIOUS INJURY.
NOTES:

SECTION 4

LEVELING JACKS and SLIDE ROOM OPERATION

SELECTING A CAMPSITE

Selecting a campground is one of the first things you should consider doing, before beginning your trip. RV campground maps, with directions and available amenities, are available at most camping stores, for a small fee. Below are some tips to help you choose the best campground for your needs.



1. Decide how long you intend to stay at the campground. If you intend to stay for a prolonged period of time, a reservation would ensure your stay at the campground of your choice and that your site is reserved, no matter what time you arrive. As with most reservations, a deposit may be required to hold your space. Most campgrounds provide a 'drop box' where they will place your paperwork, if you will be arriving after hours. Your campsite should be marked on the campground map, and many times, included, will be local places of interest, shopping locations, and restaurants in the area.



2. If you have a preference, you may request that your campsite be close to the pool, playground, lake, showers or campstore, if available. Or, you may prefer to park away from those more populated areas. If you have researched prior to your trip, you will know what type of amenities the campground has to offer, and will be able to make a decision based upon your personal wants or needs.



3. Be sure the campground you choose offers the correct electrical hook-up needed for your coach. It will be either a 30 or 50 amp service.



4. Determine if the campground can accommodate the size of your coach. Know the length of your motorhome before making a choice. (Smaller, older parks may not be able to accommodate larger coaches.)



5. Ask if the parking site for your coach is a PULL-IN or a BACK-IN site. If you have a problem backing your unit, or if you will be arriving after dark, to an unfamiliar campground, you may want to request a PULL-IN site. Definitely request a PULL-IN site if you are towing an object behind your coach. Keep in mind, during peak traveling seasons, reservations may be the best way to ensure you get the type of site that will suit your needs.



6. Other items you may like to take are lawn chairs, extra towels for the pool, sunscreen, and bug repellent. If staying for a length of time, consider bringing a small roll of indoor-outdoor carpet to put by your coach door, to cut down on the amount of dirt and debris that may be tracked into your motorhome, and a small vacuum cleaner. A small, portable hand held vacuum cleaner draws less amperage than standard size ones.

CAMPSITE PARKING

It's best to arrive at the campground before dark, especially if you are unfamiliar with the campground and if you need to back into a site. Before parking on your site, inspect it for rocks, slopes or uneven areas. When pulling onto your site, watch for posts, large rocks, low-hanging limbs, or other obstacles. If possible, pull into the site so the electrical outlets and plumbing connections are on the driver's side of the coach, (most of your coach's connections are on the driver's side). Doing so will enable the driver to maneuver the coach more easily into a position where it will not interfere with these connections. The driver will also be able to see any obstructions more clearly, which could interfere with the slide rooms or awnings, when fully extended .

SECTION 4

LEVELING JACKS and SLIDE ROOM OPERATION

FOLLOW ALL SAFETY WARNINGS LISTED BELOW BEFORE ATTEMPTING TO OPERATE THE JACKS

WARNING

NEVER EXPOSE HANDS OR OTHER PARTS OF THE BODY NEAR HYDRAULIC LEAKS. HIGH PRESSURE OIL LEAKS MAY CUT AND PENETRATE THE SKIN, CAUSING SERIOUS INJURY.

WARNING

NEVER LIFT THE COACH COMPLETELY OFF THE GROUND USING ONLY THE LEVELING JACKS. DOING SO WILL CREATE AN UNSTABLE AND UNSAFE CONDITION. IT COULD CAUSE DAMAGE TO THE SYSTEM AS WELL AS SERIOUS PERSONAL INJURY.

WARNING

NEVER USE THE LEVELING JACKS TO RAISE THE COACH TO CHANGE A TIRE, OR TO PERFORM ANY OTHER TYPE OF REPAIR WORK. ALWAYS USE PROPER EQUIPMENT OR CONTACT A PROFESSIONAL.

CAUTION

KEEP PEOPLE AND PETS CLEAR OF THE COACH WHILE THE LEVELING SYSTEM IS IN USE.

CAUTION

PARK THE COACH ON SOLID, LEVEL GROUND AND CLEAR THE SITE OF DEBRIS AND OBSTRUCTIONS. AVOID PARKING OVER HOLES OR DEPRESSIONS IN THE GROUND. IF PARKING ON SOFT SURFACES, UTILIZE LOAD DISTRIBUTION PADS UNDER EACH JACK.

NOTE

IF YOU HAVE AN AUTOMATIC LEVELING SYSTEM, DO NOT ALLOW PEOPLE TO WALK AROUND WHEN ATTEMPTING TO LEVEL THE COACH. DOING SO COULD DISRUPT THE LEVELING JACKS SENSING MECHANISM.



OPERATING THE LEVELING JACKS

We recommend that your unit be plugged into a 110volt recept, or have the generator running, during jack and slide out operation. This will help ensure the battery maintains proper voltage during operation.

REAR DIESEL MOTORHOME

Prior to Operation

Operate the leveling system **ONLY** under the following conditions:

- 
- 
1. The coach is parked on a reasonably level surface.
 2. The coach 'PARKING BRAKE' is engaged.
 3. The coach transmission should be in the 'neutral' or 'park' position.
 4. The ignition is in the 'run' position, or the engine is running.
 5. Be sure all persons, pets and property are clear of the coach while leveling system is in operation. If you are operating an automatic system, while the unit is occupied, all must stay seated during the leveling process.

CAUTION

TO AVOID POSSIBLE DAMAGE TO THE COACH, LEVELING SYSTEM, OR PERSONAL INJURY, CAREFULLY READ, STUDY, AND UNDERSTAND THE LEVELING SYSTEM OPERATIONAL PROCEDURE AS OUTLINED IN THE LEVELING JACK OWNER'S MANUAL, BEFORE BEGINNING THE LEVELING OPERATION.

CAUTION INDICATES A HAZARDOUS SITUATION WHICH COULD RESULT IN VEHICLE DAMAGE OR MINOR TO MODERATE INJURY.

'WARNING' INDICATES A HAZARDOUS SITUATION WHICH, IF NOT AVOIDED, COULD RESULT IN DEATH OR SERIOUS INJURY.

SECTION 4

LEVELING JACKS and SLIDE ROOM OPERATION

Listed below you will find general operating procedures for leveling jacks. While Forest River uses several different types of leveling systems, the operation of each is similar. If the system you have varies from the procedure listed below, please refer to the Leveling Jack owner's manual that you received with your Forest River owner's packet, and follow those instructions.



AUTO LEVELING

- Put ignition key in 'OFF' position to extend jacks.
- Press and release, the POWER keypad button. The red LED light should be illuminated.
- Press and release, the 'AUTO-LEVEL' button.
- The system will send out a continuous series of beeps, to indicate the system is in the 'LEVELING' mode. When a successful level is complete, the panel will emit a dual-level tone, and will then enter 'SLEEP MODE'.
- Using a bubble level on a flat surface in the center of the coach, adjust the jacks by using the UP or DOWN button, until the bubble is reasonably level.

Retracting the Jacks

- To retract all jacks at the same time, press and release the 'ALL RETRACT' button on the keypad. All jacks will automatically retract, and return to the stowed position. The pump motor will run in retract mode until all of the jacks are fully stowed (plus an additional 5 seconds), up to a maximum of 60 seconds. You may stop the 'ALL RETRACT' by pressing any button on the keypad.
- To retract each jack individually, press the corresponding button, (press the right top button to retract the driver side front jack; press the left top button to retract the passenger side front jack, etc.)

NOTE

IF YOU ATTEMPT TO EXTEND INDIVIDUAL JACKS BY PRESSING THE 'DOWN' BUTTON WHILE IN THE 'AUTO LEVEL' MODE, YOU WILL HEAR A 'DENY' TONE FROM THE PANEL.

CAUTION

DO NOT MANUALLY OVER-EXTEND INDIVIDUAL JACKS. DOING SO MAY CAUSE UNWANTED STRESS ON THE COACH OR THE JACK LEGS.

CLASS A GAS MOTORHOME

Follow the same basic operating procedures as outlined on the previous page for the Rear Diesel motorhome. The basic difference will be in the use of the keypad for the specific leveling product installed on your motorhome.

NOTE

WHEN THE COACH IS PARKED ON AN EXCESSIVE SLOPE, THE LEVELING REQUIREMENTS MAY EXCEED THE JACK LIFT STROKE CAPABILITY. IF POSSIBLE, MOVE THE COACH TO A MORE LEVEL SURFACE BEFORE BEGINNING THE LEVELING PROCESS.

CAUTION INDICATES A HAZARDOUS SITUATION WHICH COULD RESULT IN VEHICLE DAMAGE OR MINOR TO MODERATE INJURY.

SECTION 4

LEVELING JACKS and SLIDE ROOM OPERATION

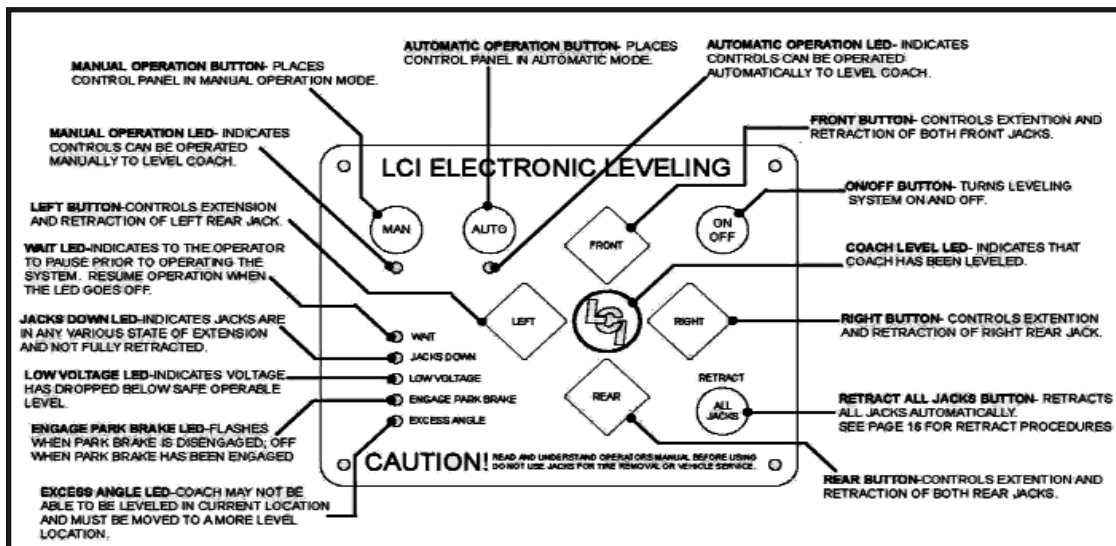

NOTE THE LIPPERT ELECTRONIC LEVELING SYSTEM WILL NOT FUNCTION PROPERLY UNLESS THE COACH ENGINE IS RUNNING.

AUTOMATIC LEVELING OPERATION

1. Push the ON/OFF button on the control panel. The system is now operational and the electronic level lights will become active.
2. Check to see that the control pad ENGAGE PARK BRAKE light is not flashing. (If the light is flashing, engage the parking brake now.)
3. Push the AUTO button to begin the automatic leveling cycle. (See WARNING below)
4. If further adjustments are necessary, push and hold the MAN button for approximately 5 seconds, until the light under this button is illuminated. Push the appropriate jack leg button to override the system and level the coach to your liking.
5. Push the ON/OFF button to de-energize the system.

WARNING AFTER BEGINNING THE AUTOMATIC LEVELING CYCLE, IT IS VERY IMPORTANT THAT THERE IS NO MOVEMENT IN THE COACH, UNTIL THE UNIT IS LEVEL, AND THE GREEN LCI LOGO LIGHT ILLUMINATES, IN THE CENTER OF THE TOUCH PAD. FAILURE TO REMAIN STILL DURING THE LEVELING CYCLE COULD INTERFERE WITH THE LEVELING SYSTEM'S SENSORS AND AFFECT THE PERFORMANCE OF THE LEVELING SYSTEM.

DANGER NEVER LIFT ALL THE WHEELS OFF THE GROUND TO LEVEL THE COACH. LIFTING ALL WHEELS OFF THE GROUND MAY RESULT IN DAMAGE TO THE VEHICLE AND/OR CAUSE SERIOUS PERSONAL INJURY OR DEATH.

NOTE IF LEVELING YOUR COACH MANUALLY, THE COACH SHOULD BE LEVELED FROM FRONT TO REAR FIRST. WHEN THE COACH IS LEVEL FROM FRONT TO REAR, THEN LEVEL IT FROM LEFT TO RIGHT.

DANGER! INDICATES A HAZARDOUS SITUATION WHICH, IF NOT AVOIDED, WILL RESULT IN DEATH OR SERIOUS INJURY.
'WARNING' INDICATES A HAZARDOUS SITUATION WHICH, IF NOT AVOIDED, COULD RESULT IN DEATH OR SERIOUS INJURY.

SECTION 4

LEVELING JACKS and SLIDE ROOM OPERATION

MANUAL LEVELING OPERATION

1. Press the ON/OFF button on the leveling system control panel. The system is now operational and the ON/OFF lights will become active. (If the ON/OFF light is not illuminated, see PRIOR TO OPERATION section, in the leveling system manufacturer's owner's manual.)
2. Press and hold MAN button for 5 seconds.
3. Press FRONT button until jacks contact the ground.
4. Press REAR button until jacks contact the ground.
5. If you have a level onboard, place it on a flat surface and check the position of the bubble. If the bubble is toward the front of the coach, press REAR button. If the bubble is toward the right of the coach, press LEFT button. (Keep button depressed until the bubble is centered.)
7. Repeat steps 2-5 if needed.
8. Turn power OFF, to leveling system, by pressing the ON/OFF button.
9. Visually inspect all jacks, to ensure all shoes are touching the ground. Should one of the rear jack shoes not be touching the ground. press the corresponding LEFT or RIGHT rear jack buttons to lower the corresponding jack to the ground.

RETRACTING THE JACKS

1. Energize the system by pushing the ON/OFF button. If properly engaged, the ON/OFF button will be illuminated.
2. Press the RETRACT ALL JACKS button. All jacks will begin to retract and return to the full retract position. When all jacks are returned to the full retract position, the JACKS DOWN light will go out.
3. When the JACKS DOWN light goes out, press the ON/OFF button to de-energize the system. Before moving your coach, make a brief, visual inspection outside, to verify the jacks are fully retracted.

NOTE IF YOU WISH TO STOP THE JACKS FROM RETRACTING, TURN THE SYSTEM OFF AND BACK ON AGAIN BY PUSHING THE ON/OFF PAD TWICE, YOU CAN THEN RE-LEVEL THE COACH BY FOLLOWING STEPS 1-5 AGAIN.

NOTE WHEN IN THE MANUAL MODE, THE JACKS WILL ONLY RETRACT AS LONG AS THE RETRACT BUTTON IS DEPRESSED. IN THE AUTOMATIC MODE, TO FULLY RETRACT THE JACKS, THE RETRACT BUTTON NEED ONLY BE PRESSED ONCE AND RELEASED.

CLASS B+ AND C MINI MOTORHOME

Automatic Leveling Procedure

1. The ignition key should be in the OFF position.
2. Press the SYSTEM POWER button. The lights on the panel will perform a 15 second diagnostic test. (The lights will flash in a circle.)
3. When the lights stop flashing. press the AUTO button, and release. The system will now begin the leveling process which will take 2-3 minutes to complete. (Be sure there is no movement in the coach during the leveling process. Movement inside the coach can interfere with the leveling sensors and can affect the performance of the leveling system.)
4. When the leveling process is complete, the solid green BIGFOOT logo will be lit. When this occurs, turn the system power OFF by pressing and releasing the SYSTEM POWER button.

SECTION 4

LEVELING JACKS and SLIDE ROOM OPERATION

NOTE

THE SYSTEM WILL NOT OPERATE IN **EXTEND MODE** IF THE IGNITION KEY IS IN THE **ON POSITION**. IF THE LEVELERS ARE DOWN AND THE KEY IS TURNED **ON**, THE ALARM ON THE CONTROL PANEL WILL SOUND.



Automatically Retracting the Levelers

1. With ignition in the OFF position, press the SYSTEM POWER button and wait for the lights to stop flashing.
2. Press and release the RETRACT button. The system will retract all four levelers automatically until they are all in the UP position.
3. Turn the system OFF and do a visual check around the coach to be sure all jacks are up before leaving.

NOTE

TRAVELING WITH A BUBBLE LEVEL WILL ALLOW YOU TO VISUALLY GAUGE THE COACH'S LEVEL STATUS FROM ANOTHER POINT. PLACE THE BUBBLE LEVEL ON THE FLOOR IN THE MIDDLE OF THE COACH AND CONTINUE LEVELING UNTIL THE BUBBLE IS IN THE MIDDLE OF THE LEVELER. (YOUR REFRIGERATOR WILL NOT FUNCTION PROPERLY IF YOUR COACH IS NOT LEVEL.)

Manually Extending the Leveling Jacks

1. Press the SYSTEM POWER button and wait for the lights to stop flashing.
2. Press and hold the MANUAL button until the light (next to the button) comes on, about 3 seconds. This mode allows you to operate the jacks one at a time. However, we HIGHLY recommend that you run the jacks ONLY in pairs, to avoid twisting the frame.
3. On each of the directional buttons, FRONT, REAR, LEFT & RIGHT, in green writing, it displays which button operates which jack. To extend the jacks, press any two buttons at the same time, (example: both front, both right, both rear, or both left side jacks, as indicated by the green lettering on the buttons. Continue doing this until the coach is level,. (You may want to utilize a bubble level, placed in the middle of the coach.)

Manually Retracting the Leveling jacks

1. Press and hold the EMERGENCY RETRACT button until the system shuts off.
2. You can also retract the jacks by pressing and holding the RETRACT button, while at the same time, pressing the button for the jacks that you want to retract. (Note the green writing on the buttons, L Front, R Front, L Rear and R Rear.)

NOTE

MOVING THE JACKS IN PAIRS WILL HELP AVOID TWISTING THE FRAME OF THE COACH.

SECTION 4

LEVELING JACKS and SLIDE ROOM OPERATION

SLIDE ROOM OPERATION

Forest River motorhomes are equipped with hydraulic or electric slide out systems, or a combination of both. In this manual you will find general information that will pertain to all operations, and in addition, some more brand specific information. If the following procedure doesn't apply to your coach, please consult the slide room manufacturer's owner's manual that you received with your motorhome and follow those directions.

NOTE WE RECOMMEND THAT YOUR UNIT BE PLUGGED INTO A 110VOLT RECEPT, OR HAVE THE GENERATOR RUNNING, DURING JACK AND SLIDE OUT OPERATION. THIS WILL HELP ENSURE THAT THE BATTERY MAINTAINS PROPER VOLTAGE DURING OPERATION.

Before Beginning Slide Room Operation

- Remove any devices that may be used to lock the slide room in place during travel.
- Ensure that the motorhome is level and properly supported. (Operating the slide room in unlevel conditions can cause undue strain on the slide out mechanism and is not a warrantable item.)
- Be sure your batteries are properly maintained and fully charged to avoid problems which may be the result of low voltage.
- Avoid using 12 volt lights and appliances when engaging the slide room.
- Driver and passenger seats should be in the extreme forward and upright position.
- Check the exterior of the unit to be sure the room has a clear travel path and that there are no obstructions. Ensure there are no branches, bushes or ground electrical or plumbing connections in the path of the room when it is fully extended.

DANGER DO NOT PERFORM ANY MAINTENANCE WORK ON YOUR SLIDE OUT SYSTEM OR SLIDE ROOM WITHOUT FIRST DISCONNECTING THE BATTERY. FAILURE TO DO SO COULD RESULT IN SERIOUS PERSONAL INJURY OR DEATH.

Extending the Slide Room

After completing the inspection as itemized on the previous page, and above:

- Rear diesel pushers and Class A gasoline motorhomes must have the parking brake applied, turn the battery disconnect switch ON, and turn the ignition key to Auxiliary. Class B+ and C minihomes do not need to have the parking break set or the ignition key turned to Auxiliary.
- Locate the rocker switch labeled SLIDE ROOM, which is generally mounted on the control center on the wall.
- Press and hold the OUT side of the rocker switch until the room is fully extended and immediately release the button. Failure to do so could cause damage to the slide assembly.

WARNING NEVER MOVE THE COACH WITH THE SLIDE ROOM/S EXTENDED.

NOTE ALWAYS CHECK FOR DEBRIS ON THE ROOF OF THE SLIDE ROOM BEFORE RETRACTING. ALSO, CHECK FOR DEBRIS ON THE AWNINGS BEFORE RETRACTING.

Retracting the Slide Room

Take the same safety precautions as previously stated for extending the room, and:

- Be sure there are no obstructions on the floor of the coach or in the path of the room as it is coming in.
- Ensure there is no visible dirt or debris in the track of the slide room or under it. Trapped dirt or debris could cause damage to your carpet or floor.

DANGER! INDICATES A HAZARDOUS SITUATION WHICH, IF NOT AVOIDED, WILL RESULT IN DEATH OR SERIOUS INJURY.
'WARNING' INDICATES A HAZARDOUS SITUATION WHICH, IF NOT AVOIDED, COULD RESULT IN DEATH OR SERIOUS INJURY.

SECTION 4

LEVELING JACKS and SLIDE ROOM OPERATION

- Press and hold the IN side of the rocker switch, until the room is completely in, then immediately release the switch.

IMPORTANT! ALWAYS PERFORM AN EXTERIOR, VISUAL INSPECTION, BEFORE LEAVING THE CAMPGROUND.

MANUAL SLIDE ROOM OPERATION

Retracting the Room-Lippert System

The hydraulic landing gear can be operated with auxiliary power devices like electric drills, ratchet wrenches or cordless screwdrivers. In the event of electrical or system failure, this manual method of extending and retracting the jacks can be used. A standard handheld drill is all that is required. Insert hex bit into coupler found under protective label. Run the drill forward, or clockwise, to extend slideout room and in reverse, or counterclockwise, to retract.



Power Failure

If you have no power, first check the slide room fuse, in the main fuse panel. The fuse panel is located near the floor either in the hallway or bedroom, is clearly marked SLIDE ROOM, and is a 15 amp fuse. In the event of a power failure, or low battery, the slideout room may also be operated manually, by using a crank handle. (If you do not have one, you may order one from your Forest River dealer.) The manual crank shaft is located on the slide out motor assembly. Turn the crank counter clockwise to move the room IN, and clockwise to move the room OUT.

WARNING WHEN THE SLIDE ROOM IS IN, IMMEDIATELY TAKE YOUR COACH TO THE NEAREST DEALER. NEVER DRIVE WITH THE SLIDE ROOM OUT.

MANUAL SLIDE ROOM OPERATION

Retracting the Room-Equilizer System

1. The individual cartridge valves, for the jack legs and slide room/s, are clustered together on the side of the pump manifold. The valves for the slide rooms are labeled 5 & 6.
2. Locate the red knurled knob on the directional valve (DV2). This valve will be on the opposite side of the manifold from the cluster of cartridge valves. Pull the red knob out and turn 1/4 turn. The knob will remain in the OUT position.
3. To retract, locate the red knurled knob on the directional valve (DV1). This valve will be on the adjacent side of the manifold to the cluster of cartridge valves. Pull the red knob out and turn 1/4 turn.
4. Your pump may be equipped with additional directional valves for the slide rooms. If this is the case, these additional valves will need to be shifted along with directional valves DV1 and DV2.

'WARNING' INDICATES A HAZARDOUS SITUATION WHICH, IF NOT AVOIDED, COULD RESULT IN DEATH OR SERIOUS INJURY.

SECTION 5

LIVING QUARTERS, LP GAS and ELECTRIC

PROLONGED OCCUPANCY

Your recreational vehicle was designed for recreational use and short-term occupancy. If you expect to occupy your RV for an extended period of time, be prepared to deal with condensation and the humid conditions that may be encountered.

CONDENSATION

Condensation is the change of water from its gaseous form, water vapor, into liquid water. Just as moisture collects on the outside of a glass of cold water during humid weather, moisture can condense on the inside surfaces of your coach. This condition is increased due to the small volume of space and the airtight construction of your motorhome.

Mold occurs when condensation is left for prolonged periods of time and is extremely difficult to kill. Controlling condensation inside your unit is the best way to avoid not only mold but dampness as well, both of which can cause damage to your coach and/or its' contents.

Condensation can infiltrate the insulation, motors, working parts of appliances or plumbing pipes, to name a few. Even though you may not see condensation, it may be inside the walls, cupboards or under the floor so it is best to take every precaution to avoid it occurring. Generally, an area that is dark, and where moisture can accumulate, is a potential breeding ground for mold.

DAMAGE CAUSED BY MOLD OR MILDEW IS A MAINTENANCE ISSUE AND IS NOT A WARRANTABLE ITEM.

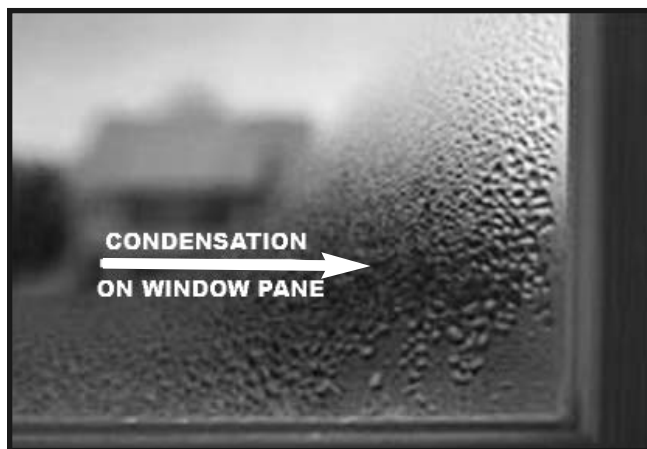

CONDENSATION ON A WINDOW IS AN INDICATION OF TOO MUCH HUMIDITY.

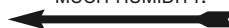

RUST ON PIPES OR OTHER PARTS OF HEATING, PLUMBING OR AIR CONDITIONING EQUIPMENT IS ALSO A SIGN OF TOO MUCH HUMIDITY.

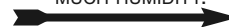

It is especially important to air out your RV when storing, or if you do not anticipate using it for an extended period of time. Empty the refrigerator and freezer and dry them completely. Dry the inside of the shower and shower head. Check for any leaks at the kitchen sink, toilet and bathroom sink. It's also a good idea to check your coach periodically, to insure there is no condensation forming on the windows, which would indicate there is too much moisture in your motorhome.

If you see signs of too much moisture inside your coach, take the steps necessary to remove the moisture, in an effort to prevent possible damage to the contents, or to your motorhome.

SECTION 5

LIVING QUARTERS, LP GAS and ELECTRIC

BELOW ARE TIPS TO HELP CONTAIN HUMIDITY IN YOUR MOTORHOME:



1. Keep indoor humidity low, below 60%, ideally between 30 and 50%, relative humidity. Relative humidity can be measured with a moisture, or humidity meter. The meter is a small, inexpensive (\$10-\$50) instrument available at most hardware stores. Some larger campground stores may also have the meters.



2. Consider using a small dehumidifier to help rid the motorhome of moisture.

3. Avoid hanging wet clothing to dry, inside the unit.



4. When showering or bathing, open the roof vents or turn on a fan, to allow steam and moisture to escape. Wipe down the shower walls to prevent water evaporating into the coach.

5. Be sure there are no obstructions in any vents and that all vents are properly sealed. Pay particular attention to appliances that produce moisture, such as air conditioners, shower, oven vents, and clothes dryer vents.



6. Try using the microwave instead of the stovetop, to boil water or soups. If you choose to use the stove to boil water or soup, open a window or a vent slightly, even in the winter, to provide a passage for the air to flow. This will also help restrict the humidity.

7. Recirculate the air by using vent fans, small oscillating fans or your furnace fan. If condensation occurs, keeping the windows clean and dry will help to prevent the growth of mold and/or mildew.

8. Do not use a ceramic heater, as it provides no air movement and will not aid in reducing condensation in the RV.

NOTE

REMEMBER THAT MOLD IS A MAINTENANCE ISSUE AND AS THE OWNER, PROPER MAINTENANCE OF YOUR MOTORHOME IS YOUR RESPONSIBILITY. CONTROLLING HUMIDITY INSIDE YOUR RV WILL HELP TO PREVENT DAMAGE WHICH MAY OCCUR DUE TO NEGLIGENCE.

NOTE

WHEN IT RAINS, WATER MAY COLLECT IN THE BOTTOM OF THE WINDOW FRAME AND DRAIN OUT THE WEEP HOLES, MADE FOR THAT PURPOSE. IF YOUR UNIT IS NOT LEVEL, THE WATER MAY NOT DRAIN OUT PROPERLY. THIS COULD CAUSE WATER DAMAGE TO THE WINDOW OR WALL AND COULD BREED MOLD DUE TO CONDENSATION.

NOTE

IF YOU HAVE WATER AND/OR MOLD DAMAGE CAUSED BY SEWAGE OR OTHER CONTAMINATED WATER, IT IS BEST TO CALL IN A PROFESSIONAL, WHO HAS EXPERIENCE CLEANING LIVING SPACES DAMAGED BY CONTAMINATED WATER.

IF YOU HAVE HEALTH CONCERNS, CONSIDER CONSULTING A HEALTH PROFESSIONAL BEFORE ATTEMPTING MOLD CLEANUP.

SAFETY DEVICES

- Always have a plan of escape. Update and practice your escape plan every six months.
- Have a meeting and discuss the plan, instruct everyone what to do, including guests.
- Do not waste time by picking up valuables or getting dressed. Sometimes seconds count!
- Using the soft brush attachment, vacuum any dust off the alarms, weekly
- DO NOT spray cleaning agents or waxes directly onto the detectors as it may cause damage to the sensor.



SECTION 5

LIVING QUARTERS, LP GAS and ELECTRIC

⚠WARNING

NEVER IGNORE ALARMS ON SAFETY DEVICES. IF THE ALARM SOUNDS AND YOU ARE NOT ABSOLUTELY CERTAIN OF THE SOURCE, GET EVERYONE OUT OF THE HOUSE IMMEDIATELY.

SMOKE DETECTOR

- Smoke alarms may not have time to sound before the fire causes damage, injury or even death.
- A smoke detector works for only detecting smoke, not fire.
- The alarm will sound only if smoke reaches the sensor.
- Check battery/s at least once a week, while the RV is in use.
- This unit will not alert hearing-impaired residents. (Special alarms with flashing strobe lights are needed for the hearing impaired.)
- Smoke alarms have a limited life and are not foolproof. Never attempt to repair this unit; replace complete unit if faulty.
- Never disconnect the battery to silence the alarm.

CO DETECTOR

- The carbon monoxide detector is designed to detect carbon monoxide from any source of combustion. It is NOT designed to detect smoke, fire, or any other gases.
- This detector doesn't work without batteries. DO NOT remove batteries except for replacement.
- Test alarm each week while RV is in use, and before beginning a trip. Press the 'TEST' button. If the alarm fails to sound and the batteries are fresh, replace the unit immediately. DO NOT attempt to repair the detector.

LP DETECTOR

- This detector senses propane gas in the air, not smoke, fire or any other gases. It detects the presence of propane gas at the sensor. Explosive gases may be present in other areas.
- Test your LP detector weekly. If the alarm is located behind a closed door, it may not be heard.
- DO NOT attempt to repair the detector. If it fails the test, change the batteries. If it still does not function properly, replace the entire unit.

IMPORTANT! LP GAS WILL AUTOMATICALLY SHUT OFF IF THE LP DETECTOR IS DISABLED. THE DETECTOR MUST BE ON AT ALL TIMES TO ENABLE CORRECT LP GAS FLOW.

LP GAS (Liquid Propane)

⚠WARNING

DO NOT bring or store LP gas cylinders, gasoline, or other flammable liquids, inside the vehicle. A fire or explosion could result.

⚠WARNING

DO NOT fill container(s) to more than 80% capacity. Overfilling the LP tanks can result in uncontrolled gas flow, which can result in an explosion or fire.

⚠WARNING

NEVER use any other type of LP gas container, than the one furnished with your RV. If the tank must be replaced, check with your dealer for specifications regarding the correct type of container to use.

'WARNING' INDICATES A HAZARDOUS SITUATION WHICH, IF NOT AVOIDED, COULD RESULT IN DEATH OR SERIOUS INJURY.

SECTION 5

LIVING QUARTERS, LP GAS and ELECTRIC

WARNING

LP gas regulators must always be installed with the regular vent facing downward. Regulators not in compartments, have been equipped with a protective cover. To minimize vent blockage, that could result in excessive gas pressure causing fire or explosion, be sure the regulator cover is kept in place. .

WARNING

DO NOT rely upon being able to smell LP gas leaks, as the odor may not be sufficiently strong enough to detect.

WARNING

DO NOT use butane or butane mixtures in your LP tank. When you fill your tanks, be sure to use propane only.

WARNING

DO NOT make repairs to the LP tank. The LP gas system is designed to meet rigid standards. Except for simple maintenance and occasional tightening of a connection, always take your vehicle to an authorized dealer for LP gas problems.

WARNING

Always have an authorized LP gas supplier fill your LP tanks. When the LP gas container is being filled, **DO NOT** smoke, strike a match or ignite a lighter. A spark or flame could ignite fumes. Also be sure all burner and pilot flames are out, and the service valve is closed.

WARNING

If you detect a sulfur or 'rotten egg' odor, **DO NOT** turn on any appliances. Shut off all operating appliances. Extinguish any open flames, including cigarettes. **DONOT** touch any electrical switches. Open windows and doors and exit the vehicle. Shut off the gas supply at the LP tank (or source). Immediately call a Service Center or LP gas supplier from an outside telephone, and follow their instructions.

WARNING

DO NOT turn on the gas supply until the gas leaks have been repaired.

DANGER

DO NOT attempt to adjust or repair the regulator. Adjustments and repairs require specialized training and tools. Contact a qualified LP Service Technician. **Failure to follow these instructions could result in fire or explosion.**

WARNING

DO NOT MODIFY YOUR LP SYSTEM. DO NOT REMOVE COMPONENTS,, OR REPLACE WITH COMPONENTS THAT ARE NOT OF EQUAL VALUE.

The liquid petroleum (LP) gas system in your recreational vehicle furnishes the fuel for cooking, heating and hot water. LP gas can also be used as an alternate energy source for refrigeration. It is a clean, efficient and safe form of energy when proper handling and safety precautions are observed.

The LP gas is stored under extreme pressure in the tank, with space in the tank to allow for expansion into vapor. The vapor is reduced in pressure, by passing through a regulator. This reduction in pressure is a two step process, which ensures consistent pressure for use, regardless of outside temperatures, weather, or altitude.

DANGER! INDICATES A HAZARDOUS SITUATION WHICH, IF NOT AVOIDED, WILL RESULT IN DEATH OR SERIOUS INJURY.
'WARNING' INDICATES A HAZARDOUS SITUATION WHICH, IF NOT AVOIDED, COULD RESULT IN DEATH OR SERIOUS INJURY.

SECTION 5

LIVING QUARTERS, LP GAS and ELECTRIC

LP REGULATOR

NOTE: YOUR LP TANK COMPARTMENT MAY APPEAR DIFFERENT FROM THE ONE PICTURED BELOW



LP gas in the tank, is under high pressure. The purpose of the regulator is to reduce the pressure inside the tank, to allow for safe use.

A two-stage automatic regulator, regulates the amount of pressure coming out of the hoses and directs the correct amount of gas pressure to each appliance.

WARNING **DO NOT ADJUST OR ATTEMPT TO REPAIR THE REGULATOR.** It is preset at the factory to certain specifications, and should only be adjusted by a qualified propane service technician. To avoid potential problems, have your LP gas system checked at least once a year by an authorized service center and after each extended trip.

WARNING **NEVER** test for a leak by lighting a match, or by having an open flame, when you suspect a leak.

REGULATOR FREEZE-UP

The term 'regulator freeze-up' is a misleading one. Regulators and LP gas do not freeze. However, the moisture that can be contained in the gas will freeze, as the gas expands and cools, passing through the regulator. This freezing of the moisture in the gas can build up and partially or totally block the passage of the gas through the regulator. Freezing can also occur when outside temperatures are low enough to contribute to the freezing of the moisture in the gas.

The source of the moisture is varied. It can occur at the refinery or gas bulk plant, in the cars used to transport the gas, or even within your own LP tanks. Moisture in an LP tank can occur when a tank service valve is left open, allowing moist air to enter and become trapped.

A two-stage regulator helps reduce the possibility of freeze-up, due of its larger orifice size, and that heat is being transferred through the walls of two regulators instead of one.

'WARNING' INDICATES A HAZARDOUS SITUATION WHICH, IF NOT AVOIDED, COULD RESULT IN DEATH OR SERIOUS INJURY.

SECTION 5

LIVING QUARTERS, LP GAS and ELECTRIC

Tips to help prevent regulator freeze-up:



- Be sure your LP tank is free of moisture before refilling
- DO NOT overfill the LP tank
- Be sure to keep the service valve, on an empty tank, closed
- If freezing occurs, have your LP dealer purge the tank before refilling
- Check with your dealer to determine which deicing agent is approved to add to the LP tank
- Keep the regulator covered at all times

NOTE

IF FREEZE-UP DOES OCCUR, TURN THE LP OFF AT THE TANK. A FROZEN REGULATOR MAY PERMIT LP GAS TO FLOW AT HIGH PRESSURE, RESULTING IN LEAKS AT APPLIANCES, OR IN THE LINES. NEVER ATTEMPT TO THAW WITH AN OPEN FLAME. A SMALL LIGHT BULB CAN SOMETIMES BE USEFUL TO PROVIDE HEAT, AND AID THE THAWING PROCESS. ONCE THAWED, TAKE PROPER STEPS TO PREVENT A REOCCURENCE. HAVE THE SYSTEM CHECKED BY YOUR LP SUPPLIER.

Other Cold Weather Factors

As outside temperatures drop, the BTU value of the LP gas is lessened. The colder liquid LP in the tank/s, requires heat from the surrounding air, to vaporize. This lowering of BTU value can significantly affect the performance of the system. Keeping your LP tanks as full as possible in cold weather, and reviewing the BTU/hr rating plates on LP appliances, will help insure proper LP management.

LP PIGTAIL

The LP pigtail is a hose used to connect to the regulator on the tank, through which the LP fuel flows. If an LP leak is detected by the LP sensor solenoid, located inside the valve, the shut-off valve is automatically activated. The valve will close, prohibiting the flow of LP gas to the motorhome.

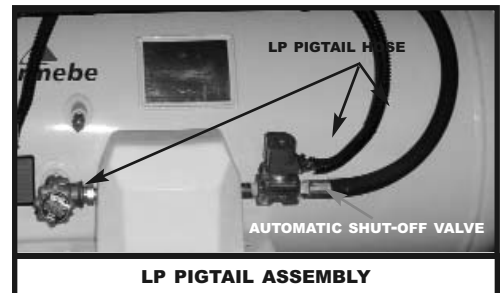

DANGER

DO NOT TAMPER WITH THIS SAFETY FEATURE!

LP DETECTOR

In the Event of an Alarm:

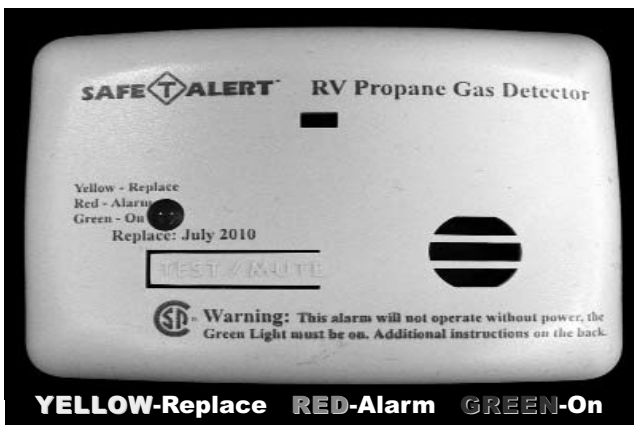

If the detector senses the presence of LP gas, the green light will turn from green to red, accompanied by an audible alarm. If the alarm sounds:

1. Immediately evacuate all occupants from the coach.
2. Extinguish any open flames, pilot lights and all smoking material.
3. DO NOT touch any electrical switches.
4. Shut off the gas supply at the tank.
5. Open doors and windows to ventilate.

DANGER! INDICATES A HAZARDOUS SITUATION WHICH, IF NOT AVOIDED, WILL RESULT IN DEATH OR SERIOUS INJURY.

SECTION 5

LIVING QUARTERS, LP GAS and ELECTRIC

6. DO NOT USE THE RANGE HOOD OR OTHER POWER VENTS.
7. The alarm will continue to sound as long as LP gas is detected or until turned off.

WARNING

THE ALARM MAY SOUND AT TIMES WHEN NO LP GAS IS PRESENT, DUE TO HOUSEHOLD PRODUCT USE, SUCH AS AEROSOL HAIRSPRAY, CERTAIN CLEANERS, ADHESIVES, ALCOHOL, ETC. TO HELP AVOID A FALSE ALARM, BE SURE TO WELL VENTILATE THE AREAS WHERE THESE PRODUCTS ARE IN USE.

ELECTRICAL SYSTEM

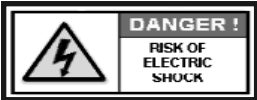

Connecting the power cord to a non-grounded, or improperly grounded, power source, can result in a dangerous and possibly fatal, electric shock. The electrical power supply provided for the recreational vehicle is a dual system, operating on 110 volt AC and/or 12 volt DC.

The 110 volt power may be provided by either connecting the recreational vehicle to an outside power source when parked, or by use of a recreational vehicle generator. When the 110 volt system is operational, power also passes through a system converter/inverter, allowing the full use of all 12 volt functions in the RV. Some 110 volt functions in the RV may include the refrigerator, TV, and electrical outlets.

When 110 volt power is not available, the refrigerator and water heater also have the option of running on LP gas. When not connected to 110 volt power, the 12 volt system functions can be supplied by the batteries. Batteries are recharged by the power converter, when the RV is attached to an outside 110 volt power source, or by the generator. (Be sure the converter power switch is in the ON position. The generator will not charge the batteries, or otherwise operate, when the power switch is in the OFF position.)

CONNECTING TO AN OUTSIDE POWER SOURCE

A 30 amp, (Class C motorhome), or 50 amp, (Class A motorhome), power cord, is provided, to connect the RV to a grounded power source. The electric utility service connection is located on the driver's side, near the rear of the coach.

The power cord is stored inside the electric utility service compartment. (Depending upon the type of RV you have, the power cord could be either permanently mounted, or detachable.)



WARNING

NEVER USE A TWO WIRE EXTENSION CORD, A CHEATER ADAPTER WITH THE GROUND PIN REMOVED, OR PUT A LOWER AMPERAGE PLUG ON YOUR POWER CORD, IN PLACE OF THE MOLDED PLUG.

DANGER! INDICATES A HAZARDOUS SITUATION WHICH, IF NOT AVOIDED, WILL RESULT IN DEATH OR SERIOUS INJURY.
'WARNING' INDICATES A HAZARDOUS SITUATION WHICH, IF NOT AVOIDED, COULD RESULT IN DEATH OR SERIOUS INJURY.

SECTION 5

LIVING QUARTERS, LP GAS and ELECTRIC

AGS (Automatic Generator Start System)

Some coaches are manufactured with an Automatic Generator Start System. The AGS is designed to automatically start your coach generator, based on the inside temperature of the coach or a low battery condition. These features allow you to leave pets and important items in your coach, while you enjoy a day away, and be confident your coach will stay cool and comfortable. The AGS includes settings for 'Quiet Time' so you can comply with park and rally rules. The AGS does not interfere with your air conditioner controls, or the manual generator start/stop switches in your coach.

BATTERIES

The batteries on a Class A rear diesel and Class C minihome, will be located in a separate compartment on the exterior of the coach. Some Class A gasoline motorhomes have a battery compartment located under the entry step. Be sure you know the location of your batteries before leaving the dealership. It is important to keep the batteries fully charged at all times. Take time to turn off all lights or other 12 volt conveniences, when not in use. To prevent draining the batteries, connect the motorhome to a 110 volt power source when ever possible.

The charge condition of the batteries is displayed on the monitor panel, generally located in the Control Center, mounted on the wall. To check, press and hold monitor TEST switch, while reading the charge level on the battery gauge. Charge levels indicated, are divided into sections, from weak to fully charged.

BATTERY MAINTENANCE

Battery maintenance is important. Checking the condition of the battery at regular intervals will help ensure its' proper operation. Here are some recommendations for checking and servicing the batteries.

1. Keep the battery mounted securely. Excessive vibration can cause early battery failure.
2. Check the electrolyte level of the auxiliary batteries at regular intervals. Keep each cell filled with distilled water, to just above the plates. Once the plates have dried out, they cannot be reactivated, and the capacity of the battery is reduced in direct proportion to the area of plate surface that has become dry. This kind of damage can occur quickly.
3. Keep the battery clean. Corroded terminals make poor contact. Battery sulfation occurs when the battery has been standing in a discharged condition over a long period of time, or when the battery has been operated continually in a state of partial discharge.
4. Check the outside condition of the battery. Look for cracks in the case or vent plugs. If the case is cracked, the battery must be replaced, If the vent plugs are cracked, they must be replaced.
5. Watch for overcharging. Three ways to spot overcharging are
 - a. active material on the vent cap (heavy deposit of black, lead-like material on the underside of the vent cap.)
 - b. excessive use of water.
 - c. by testing voltage regulator output.
6. Be sure the battery hold downs and carrier, are kept clean, and free of corrosion.

SECTION 5

LIVING QUARTERS, LP GAS and ELECTRIC

NOTE

WHEN REMOVING A BATTERY, DISCONNECT THE GROUND BATTERY CLAMP FIRST. WHEN INSTALLING A BATTERY, ALWAYS CONNECT THE GROUNDED BATTERY CLAMP LAST. WHEN A BATTERY NEEDS TO BE REPLACED, ALWAYS REPLACE IT WITH A BATTERY OF THE SAME CHARACTERISTICS AS THE ORIGINAL EQUIPMENT. IF NEEDED, CONSULT YOUR DEALER FOR ADVICE ON BATTERY REPLACEMENT.

DUE TO THE POTENTIAL DANGER IN FAILING TO HEED THIS WARNING, THE RECREATIONAL VEHICLE MANUFACTURER CAN NOT BE HELD RESPONSIBLE SHOULD DAMAGE, INJURY OR DEATH RESULT, FROM FAILURE TO CONNECT THE POWER CORD TO A PROPERLY GROUNDED POWER SOURCE.



↔
BATTERY
DISCONNECT
SWITCHES
↔

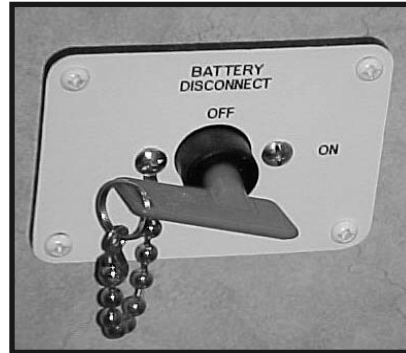

THE BATTERY DISCONNECT SWITCH IS USED TO DISCONNECT THE HOUSE BATTERY DURING STORAGE. IF YOUR BATTERY DISCONNECT SWITCH IS A TOGGLE SWITCH, IT MUST BE IN THE USE POSITION. IF YOUR SWITCH HAS A KEY, THE KEY MUST BE IN THE ON POSITION. IF THE SWITCH IS NOT ON USE, OR ON, YOU WILL NOT HAVE POWER TO YOUR BATTERY.

IF YOUR CHASSIS BATTERY IS DEAD, YOU CAN START THE CHASSIS ENGINE BY USING THE BATTERY BOOST SWITCH, (LOCATED ON THE DASH). HOLD THE SWITCH DOWN, WHILE STARTING THE ENGINE, THEN RELEASE IT WHEN THE ENGINE ENGAGES.

BATTERY SAFETY

WARNING

ALWAYS SHIELD YOUR EYES WHEN WORKING NEAR BATTERIES. BATTERIES CAN EXPLODE. DO NOT SMOKE, OR EXPOSE BATTERY TO AN ELECTRIC SPARK OR FLAME. WHEN CHARGING OR DISCHARGING, BATTERIES GENERATE HYDROGEN. HYDROGEN AND AIR IS A VERY EXPLOSIVE MIXTURE.

WARNING

DO NOT SHORT ACROSS THE BATTERY TERMINALS. THE SPARK COULD IGNITE THE GASES. DO NOT WEAR METAL JEWELRY OR A WATCH, WHEN WORKING ON A BATTERY.

WARNING

DISCONNECT THE BATTERY CABLE AND THE 110 VOLT POWER CORD BEFORE WORKING ON THE ELECTRICAL SYSTEM. DO NOT RECONNECT THE CABLES UNTIL ALL WORK HAS BEEN COMPLETED.

WARNING

BATTERY ELECTROLYTE IS A CORROSIVE, POISONOUS, SULFURIC ACID. AVOID CONTACT WITH SKIN, EYES, CLOTHING, OR ANY PAINTED SURFACE.

BATTERY CHARGING

The converter also operates as a battery charger, when it is connected to a 110 volt power source. If the battery is below its full charge, the converter charger will begin operation at a rate that reflects the level of discharge. When the battery is again fully charged, the converter charger drops its charging level back to a maintenance level, to keep the battery fully charged. When charging a battery, follow these safety precautions:

'WARNING' INDICATES A HAZARDOUS SITUATION WHICH, IF NOT AVOIDED, COULD RESULT IN DEATH OR SERIOUS INJURY.

SECTION 5

LIVING QUARTERS, LP GAS and ELECTRIC

THE BATTERY DISCONNECT SWITCH MUST BE IN THE USE, OR ON, POSITION FOR THE BATTERY TO CHARGE.

1. Disconnect the battery from the recreational vehicle.
2. Check electrolyte status before charging. Be sure each cell is properly filled with distilled water.
3. Use care when connecting and disconnecting the cables from chargers. A poor connection can cause an electrical arc, which can result in an explosion.
4. Remove the battery vent caps before charging, and be sure that the electrolyte solution does not splash out, which could occur as the result of charging too quickly.
5. Read the literature supplied by the battery manufacturer, and follow all their warnings or precautions, as stated in their manual.

POWER CONVERTER/INVERTER

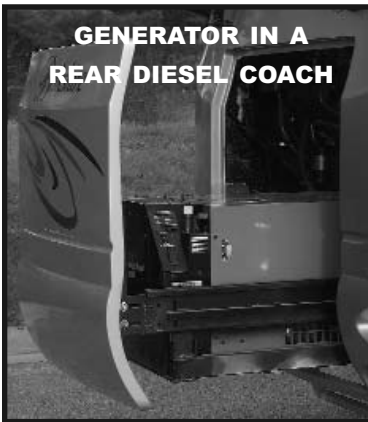

The converter is used to switch 110 volt electricity from an external source or from the generator, to 12 volt electricity. Under normal conditions, the converter requires no maintenance. If the converter does not have a 110 volt supply to convert to 12 volt, it automatically switches the batteries into the electrical circuit, to power 12 volt functions. When reconnected to a 110 volt power source, it will again operate from that source.

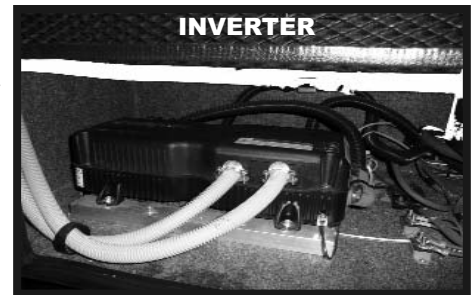

It is normal for the converter to run warm. If, however, it gets too hot, it will turn itself off. After it cools, it will come back on. In most cases, shut down occurs due to poor ventilation. A slight hum during operation is also normal for the converter. If you have no 12 volt power and no hum, check to see if 110 volt power to the converter has been interrupted.

If you have an inverter, the inverter will take over when 120 volt power is not available. The inverter control panel is located above or near the entrance door. Once activated, the inverter converts 12 volt power to 120 volt power, used for operating certain lights and appliances. It most commonly supplies power to the microwave, kitchen, bath, and selected receptacles. The inverter is equipped with an automatic transfer switch, which allows automatic switching from the inverter to the converter. When you are connected to an exterior power source, or running the generator, it will automatically switch on, to charge the 12 volt batteries.

CAUTION KEEP CONVERTER/INVERTER AREA CLEAR OF OBSTACLES AND CLUTTER. THEY MUST HAVE ADEQUATE VENTILATION TO AVOID OVERHEATING.

NOTE DURING STORAGE, TURN OFF INVERTER AND DISCONNECT BATTERY.

GROUND FAULT CIRCUIT INTERRUPTER

The 110 volt outlet in the bath, is equipped with a protective circuit interrupter. The ground fault circuit interrupter (GFCI), is designed to break the flow of current to the protected outlet, when an imbalance of current is detected. If an imbalance is detected, the GFCI will trip, and shut off power to the outlet. Even with GFCI protection, the electrical shock will still be felt,

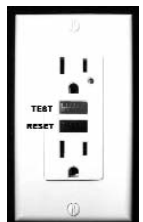

CAUTION INDICATES A HAZARDOUS SITUATION WHICH, IF NOT AVOIDED, COULD RESULT IN VEHICLE DAMAGE OR PERSONAL INJURY.

SECTION 5

LIVING QUARTERS, LP GAS and ELECTRIC

but to a lesser degree. It also does not protect against short circuits or system overloads. Circuit breakers in the main panel, which supply power to the circuit, will trip, if either of these conditions exists. The GFCI receptacle should be tested initially when the recreational vehicle is purchased, and at least monthly thereafter.

⚠ WARNING

EVEN WITH GFCI PROTECTION, PERSONS WITH SEVERE HEART OR OTHER HEALTH PROBLEMS MAY STILL BE SERIOUSLY AFFECTED BY AN ELECTRICAL SHOCK. THE GFCI OUTLET IS NOT A SUBSTITUTE FOR GOOD ELECTRICAL SAFETY. IT DOES NOT PROTECT AGAINST CONTACT OF THE HOT AND NEUTRAL WIRE AT THE SAME TIME. THE GFCI DOES NOT PROTECT ANY CIRCUIT OTHER THAN THE ONE TO WHICH IT IS CONNECTED.

TO TEST THE CIRCUIT, USE THE FOLLOWING PROCEDURE:

1. Be sure power to the circuit is ON.
2. Press the reset button.
3. The red reset button should pop out.
4. All power should be interrupted, to outlets protected by the GFCI.
5. Verify, by plugging in a light at these outlets, and pressing the red reset button. If the button does not pop out after pushing the test button, or GFCI circuit continues to trip, immediately turn off power at the circuit breaker panel, and have a qualified electrician service it.

CIRCUIT BREAKERS

The 110 volt system is protected by circuit breakers. These breakers automatically trip, if the circuit load is too heavy, or a short circuit occurs. If a circuit breaker has been tripped, do not reset the breaker until the cause of the problem is identified and corrected.

The generator also has two AC circuit breakers, and a DC fuse, on the generator control panel. If an interruption in generator operation occurs, check to see if any of these have been tripped. Consult the manuals provided with the generator before attempting maintenance on the generator.

12 VOLT FUSES

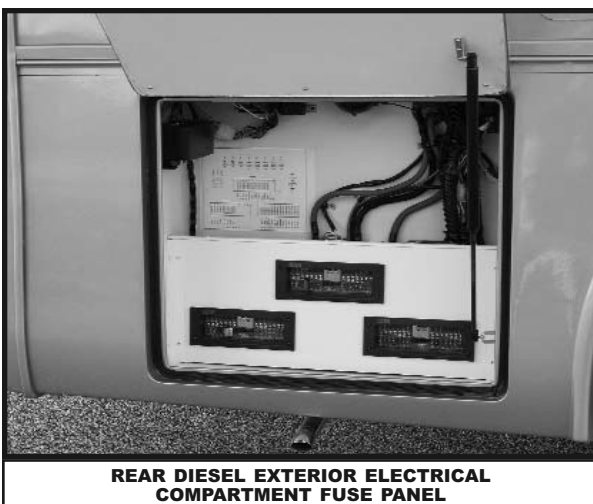

**REAR DIESEL EXTERIOR ELECTRICAL
COMPARTMENT FUSE PANEL**

The 12 volt DC distribution panel on Class A Gas and Class C motorhomes, is located next to the 110 volt circuit breakers. On the Rear Diesel motorhomes, there is a centralized 12 volt distribution area in an drivers' side exterior compartment. The panel contains circuits for both motorhome and chassis, with replaceable fuses, for protection of recreational vehicle 12 volt lines. If any line is loaded beyond the capacity of its fuse, the fuse will blow. A portion of the 12 volt load on the line must be turned off to reduce the total load on the line to a level below the capacity of the fuse. Replace the fuse with the same size fuse. DO NOT replace the fuse with a larger fuse than indicated.

'WARNING' INDICATES A HAZARDOUS SITUATION WHICH, IF NOT AVOIDED, COULD RESULT IN DEATH OR SERIOUS INJURY.

SECTION 6 PLUMBING

PLUMBING

The recreational vehicle plumbing system has the dual ability to be self contained with onboard storage, or use facilities provided by an external pressurized source. The fresh water system consists of those items which are used to deliver water for your use, while the waste water system is made up of the drains and tanks which store and remove water which has been used. Components of the plumbing system consist of strong, lightweight, corrosion resistant materials, which provide long life and easy cleaning. By following the instructions outlined in this manual, you can expect efficient operation of your plumbing system, with minimum maintenance.

FRESH WATER

Potable (fresh water) is supplied by either the fresh water tank onboard the coach, or from an outside source connected through the city water connection. When using the fresh water tank, the water is pumped through the water lines by the water pump. When utilizing an exterior source, such as a campsite water supply, the pump is not needed, as the water is already pressurized and will flow through the water supply lines within the coach, without the aid of the water pump.

EXTERNAL HOOK-UP

Water provided from outside the recreational vehicle, is pressurized by the system from which it is delivered. When connecting your motorhome to an outside source, the fresh water tank and the water pump, are kept separate from the remainder of the system, by in-line check valves. (DO NOT turn the pump on, if the fresh water tank is empty. Doing so could cause damage to the pump, or a blown circuit may occur.)

Attaching to an Outside Source of Water

1. Remove the cap from the fresh water inlet on the side of your motorhome.
2. Attach one end of the fresh water hose to the outside source of water.
3. Connect the other end of the hose to the RV city water inlet.
4. Turn on the outside source of water. Gradually open all the hot & cold water faucets at the sinks and tub, to clear air from the lines. Close the faucets when the water is flowing freely.

NOTE DO NOT TURN ON THE WATER PUMP WHEN USING WATER FROM AN EXTERNAL SOURCE. ONLY USE THE WATER PUMP WHEN OBTAINING WATER STORED IN YOUR ONBOARD FRESH WATER TANK.

FILLING THE FRESH WATER TANK:

1. Remove the water fill cap.
2. Water can now be added directly to the tank through the fill spout by use of a known clean hose, used only for this purpose.
3. When the tank is full, replace the cap.

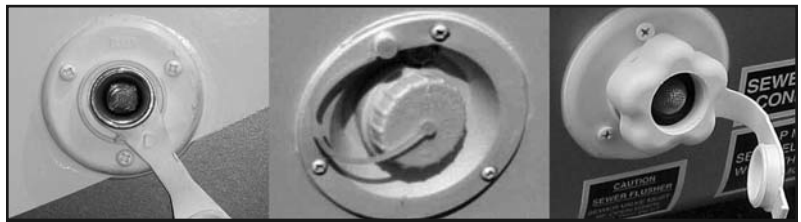

EXAMPLE OF DIFFERENT TYPES OF FRESH WATER FILL SPOUTS

NOTE WATER FROM THE FRESH WATER TANK IS OBTAINED BY USE OF THE WATER PUMP, WHEN FILLING THE HOT WATER TANK AND WATER LINES. REMEMBER, TRAVELING WITH FULL WATER TANKS WILL ADD WEIGHT TO YOUR COACH, CAUSE ADDITIONAL WEAR, AND DECREASE GAS MILEAGE. TRAVEL WITH THE WATER TANKS, BOTH FRESH WATER TANK AND WASTE TANK, AS EMPTY AS POSSIBLE, WHILE STILL MAINTAINING YOUR DESIRED LEVEL OF COMFORT.

SECTION 6 PLUMBING

TRAVELING WITH WATER IN TANKS

When traveling, you may want to drain the tank or keep the quantity of water to a minimum. This will reduce the total weight of the RV, for travel. The location of the fresh water and the waste water tank drain valve, will vary from unit to unit, but is generally located beneath the motorhome, near each respective tank. Water in the tank can be drained by turning the drain valve handle, perpendicular, (vertically) to the coach body. To close the valve, turn the lever parallel (horizontally) to the coach body.

NOTE FOR EVERY 100 LBS. OF WEIGHT, THERE IS A PENALTY OF 1% ON YOUR FUEL USAGE. A GALLON OF WATER WEIGHS 8 LBS. IF YOU ADD 30 GALLONS OF WATER TO YOUR FRESH WATER TANK, MULTIPLYING 30 GALLONS BY 8 LBS., IS AN ADDITIONAL 240 POUNDS OF WEIGHT. HOWEVER, IF NEEDED, YOU CAN ALSO USE YOUR WATER TANKS TO HELP BALANCE YOUR UNIT, BY ADDING OR DECREASING THE AMOUNT OF WATER IN THE TANKS.

TO DISCONNECT FROM THE OUTSIDE WATER SOURCE:

1. Turn off the outside source of water.
2. Disconnect the hose from the supply valve and the inlet on the side of the motorhome.
3. Remove the hose and store.
4. Reinstall the cap on the motorhome inlet.

NOTE WHEN FILLING OR DRAINING THE TANKS, BE SURE THE WATER PUMP SWITCH IS IN THE OFF POSITION. WHEN DRAINING THE ENTIRE ONBOARD FRESH WATER SYSTEM, OPEN ALL FAUCETS, WATER HEATER DRAIN, AND SYSTEM LOW POINT DRAINS, IF APPLICABLE, TO REMOVE ALL FRESH WATER FROM THE SYSTEM.

CHECKING WATER TANK LEVELS Monitor Panel/Command Center



While there are several different styles of monitor panels, they all serve the same purpose. They measure and display information, regarding levels for water, batteries, and LP.

The monitor panel allows you to quickly check the levels in the fresh water and waste water tanks. Electrical sensors at various points on the tanks, send signals to the monitor panel.

To check fluid levels, press and hold the TEST SWITCH, and read the level indicators on the panel. The indicator is proportioned in quarters, with each light displaying the level contained within the tank.



NOTE RESIDUE ON THE SIDES OF A TANK, OR WATER WITH A LOW MINERAL CONTENT, CAN RESULT IN A FALSE READING. HELP PREVENT THIS FROM OCCURRING BY KEEPING YOUR TANKS CLEAN.

Check the levels when you are sure of a tank's contents, and compare it to the reading on the monitor panel. If you are concerned about the accuracy of the monitor panel, have it checked at your local Service Center.

SECTION 6 PLUMBING

PLUMBING SYSTEM

The motorhome plumbing system has basically two water systems; the fresh water system and the waste water system. Potable (fresh) water is supplied by either the fresh water tank you have onboard your coach, or by connecting to the city water fill at the campground.

NOTE WHEN CONNECTING TO CITY WATER, (WATER FROM THE FAUCET AT THE CAMPGROUND) USE ONLY A WATER HOSE WHICH WAS MANUFACTURED AND LABELED FOR POTABLE (DRINKABLE) WATER. THIS WILL ENSURE THE HOSE WILL NOT ALTER THE TASTE OF THE WATER, AND THAT THE HOSE HAS BEEN SANITIZED FOR THAT PURPOSE. TO BE SURE YOU MAINTAIN SANITARY DRINKING AND COOKING WATER, NEVER USE THE HOSE FOR ANY OTHER PURPOSE. YOU CAN PURCHASE THIS TYPE OF HOSE AT MOST ANY CAMPING STORE.

NOTE WHEN CONNECTED TO CITY WATER, BE SURE YOUR WATER PUMP SWITCH IS IN THE **OFF** POSITION. THE PUMP IS NOT NEEDED WHEN CONNECTED TO CITY WATER, SINCE THAT FRESH WATER SOURCE IS ALREADY PRESSURIZED. USE THE PUMP ONLY WHEN OBTAINING WATER FROM YOUR ONBOARD FRESH WATER TANK, AND YOU ARE DISCONNECTED FROM ANY EXTERIOR WATER SOURCE. WHEN USING YOUR ONBOARD WATER, BE SURE YOUR WATER PUMP SWITCH IS IN THE **ON** POSITION.

Water Pump

The RV water pump operates on 12 volt power and is totally automatic, when the pump switch is in the ON position. Operation begins when a faucet is turned ON, providing you are not connected to a city water fill.

When a faucet is turned ON, the pump automatically draws water from the onboard fresh water tank. The pump supplies the pressure needed to move the water through the water lines. The water pump switch is located on the monitor panel.

Before turning the water pump ON:

- Ensure there is adequate water in the the fresh water tank.
- Be sure the water heater BYPASS valve is set to NORMAL FLOW, allowing water to enter.
- Open all faucets, both HOT and COLD, including any tub and/or shower faucets.

Turn the pump switch ON, and allow the pump to fill the water lines and hot water tank. After water is running in a steady stream from all faucets, turn the faucets OFF. The water pump should stop operation automatically, when all faucets are closed. The pump should now run 'ON DEMAND' when a faucet is opened, and stop, when the faucets are closed.

CAUTION NEVER OPERATE THE WATER PUMP IF THE FRESH WATER TANK IS EMPTY. DAMAGE TO THE PUMP MAY OCCUR.



12 VOLT WATER PUMP

CAUTION INDICATES A HAZARDOUS SITUATION WHICH COULD RESULT IN VEHICLE DAMAGE OR MINOR TO MODERATE INJURY.

SECTION 6 PLUMBING

To Sanitize the System:

- Prepare a chlorine solution using a gallon of water and ¼ cup of liquid household bleach, (5% sodium hypochlorinate solution.) Use one gallon of solution for each 15 gallons of tank capacity.
- With an empty tank, and all faucets and drains closed, pour the solution into the fresh water tank.
- Completely fill the tank with fresh water.
- Switch the water pump ON. Open all faucets, one at a time, until all air is purged from the lines and the water is flowing freely.
- Again, add fresh water to the tank, until the water level reaches the fill spout.
- Allow the solution to stand in the tank, undisturbed, for at least 3 (three) hours.
- Drain the system by opening all faucets, and the fresh water tank drain valve, while flushing the system with fresh water of drinking quality, from the city water fill.
- Continue flushing the system, allowing the water to flow for several minutes.
- Close the tank drain valve and all faucets. Refill the system with water of known drinking quality.

Waste Water System

The waste water system in your motorhome can be described as two separate systems. A gray water system, which consists of the drain lines and holding tank for waste water from the sinks and tub, and a black water system, which includes the holding tank and drain for toilet wastes. Each system is self-contained and allows disposal of waste water at designated dump stations, at your convenience.

Components of the gray water system have drain traps, and both tanks (black tank for toilet waste, and gray tank for sinks and showers), are vented, to equalize air pressure, and disperse odors to the outside, caused by drain water and waste. At times, the rocking movement of the coach, while driving, may empty the drain traps of their water, and allow odors from the gray water tank to enter the motorhome.

Residue in the drain water lines can also produce odors. To combat gray water holding tank odors, an RV approved deodorizing agent should be used. An agent that dissolves grease and fats, and contains a detergent, will help keep the tanks and lines clean and free flowing. You can obtain the deodorizer at most campgrounds, and at stores that carry camping supplies.

IF CONNECTING TO A CAMPSITE SEWER INLET:

- DO NOT open termination valves until tanks are ¾ full.
- DO NOT keep black water valve open while parked.



NOTE

SOLID WASTE IS NOT FLUSHED DIRECTLY INTO THE SEWER SYSTEM. ONLY LIQUID WASTE IS DRAINED, THEREFORE, YOU MUST ALLOW WATER TO ACCUMULATE IN THE TANK, AND GIVE THE CHEMICALS TIME TO BREAK DOWN THE SOLIDS, BEFORE EMPTYING THE TANK.

SECTION 6 PLUMBING

NOTE

ALWAYS KEEP ENOUGH WATER IN THE WASTE TANK TO COVER THE BOTTOM. DOING SO WILL HELP PREVENT WASTE FROM SOLIDIFYING, WHICH WILL PREVENT THE WASTE FROM BEING FLUSHED FROM THE SYSTEM. IF DRAINING THE GRAY WATER TANK DIRECTLY INTO THE SEWER INLET WHILE PARKED, BE SURE TO CLOSE THE TERMINATION VALVE FOR A PERIOD OF TIME BEFORE LEAVING, ALLOWING WATER TO ACCUMULATE IN THE TANK FOR USE IN FLUSHING THE DRAIN LINE AND FLEXIBLE HOSE.

Each tank has a separate drain line and dump valve, which permits dumping tanks individually or together. Each tank should be emptied often, and ONLY at dump stations designated for this purpose. Dump stations can be found at most campgrounds and are well marked, and at most truck stops. Many service stations, particularly along interstate highways, also have these facilities. Campground directories list dumping station locations across the nation.

If possible, dump holding tanks before a trip, to reduce the gross vehicle weight. It is very important that you keep enough water in the black water tank to cover the bottom, to prevent hardening of any waste residue that may remain. Never dump black water tank until it is $\frac{3}{4}$ full. (Check the tank level on your monitor panel.) This practice ensures that enough water is in the tank to flush all wastes into sewer line. If necessary, fill the tank to the $\frac{3}{4}$ mark with additional water before draining.

Never put anything in the holding tanks other than normal drain water, body waste, and biodegradable products. Paper wrappers, gum, cigarettes, etc., no matter how small, should NEVER be placed into either the gray or black tanks, as doing so could cause damage to your plumbing system and/or tanks.

NOTE

YOU CAN FIND BIODEGRADABLE PAPER PRODUCTS AT MOST STORES THAT SELL CAMPING SUPPLIES AND AT CAMPGROUNDS THAT HAVE A STORE ON THE PREMISES. YOU CAN ALSO FIND CHEMICAL SUBSTITUTES FOR DEPOSIT INTO THE WASTE TANKS, IF YOU PREFER.

NOTE

IT IS IMPORTANT TO NOTE THAT HARMFUL AND TOXIC MATERIALS CAN ACCUMULATE IF THE HOLDING TANKS ARE NOT REGULARLY DRAINED AND THOROUGHLY RINSED. IT IS ALSO IMPORTANT TO USE HOLDING TANK DEODORIZING AND CLEANING AGENTS IN THE WASTE WATER TANKS, TO REDUCE ODORS, AND KEEP THE LINES OPEN AND FREE FLOWING.

To Empty the Holding Tanks

- 
1. Remove the sewer drain hose from its storage compartment on the side of the coach.
 2. Remove the cap from the RV drain and connect the drain hose.
 3. Attach the other end of the flexible drain line to the dump station inlet. Be sure both ends of the flexible drain line are securely attached.
 4. Drain the black water tank first, by pulling the termination valve handle toward you. Be sure to allow sufficient time for the tank to completely drain, then rinse the tank with several gallons of water by depressing the stool pedal or hand flush handle. Close the valve on the stool and let it fill before releasing to the tank. This creates additional force to flush the tank more completely.
 5. Drain the gray water tank by pulling the termination valve handle toward you. Draining the gray tank last uses the soapy water in the tank to rinse the drain and flexible hose.
 6. When tanks are emptied, close termination valves by pushing handles back to closed positions.
 7. Remove flexible drain hose and wash it thoroughly with clean water. Remove the other end from the dump station inlet, and replace it in its storage compartment. Secure the sewer hose storage cover, and replace the caps on both the motorhome outlet and the dump station inlet.

SECTION 6

PLUMBING

Follow these guidelines to help ensure trouble-free operation:

- 
- Never put anything in black water tank other than biodegradable RV toilet paper.
 - Do not put automotive antifreeze, household toilet cleaners, household drain cleaners, or any solid material, into the waste water system.
 - Always use chemicals in the black water system, made especially for this purpose.
 - When cleaning components of the waste water system, use ONLY cleaners made for RV systems.
 - Always keep the drain cap in place and termination valves closed.
 - After every third time the holding tanks are emptied, fill and flush both tanks with clean, fresh water a couple of times to keep them clear and clean.

NOTE

KEEPING THE BLACK WATER TANK CLEAN ALLOWS THE MONITOR PANEL TO ACCURATELY ASSESS THE STATUS OF THE TANK. ALWAYS CLEAN UP THE DUMP SITE BEFORE LEAVING. NEVER EMPTY YOUR HOLDING TANKS DIRECTLY ON THE GROUND, A ROADWAY, RIVER, OR STREAM. DO NOT POLLUTE!

TOILET

The toilet installed in your recreational vehicle is connected to the pressurized fresh water system. A single lever, located either on the side, or a foot pedal, controls flushing, and the flow of water into the bowl.



- To add water to the toilet before using, lift the flush lever until the desired water level is reached. (As a general rule, more water is required only when flushing solids.)
 - To flush the toilet, push the lever all the way down, and hold, until the sewage leaves the toilet.
 - Release the flush lever. A small amount of water should remain in the bowl. To add more water to the bowl, hold the lever HALF WAY down, until the bowl has the desired amount of water.
- Be sure to hold the flush lever down long enough to release the contents of the bowl, but only as long as necessary, as this will result in excessive water usage.
 - Unnecessary, frequent flushing of the stool, will quickly deplete your fresh water supply and fill your holding tank. If the black water tank becomes full, you will no longer be able to flush the stool until the tank is drained. Be sure all occupants and guests understand this operation.
 - Always use deodorizing agents, specifically designed for use in holding tank systems, and a good biodegradable tissue paper. These products are available directly from your dealer or any store that sells camp supplies.

NEVER use chlorine or caustic chemicals, such as drain openers, or laundry bleach in your toilet.
NEVER allow foreign objects (non-dissolving items) to be flushed through the toilet.

Don't allow a problem to go unsolved. If you should detect a problem, take steps to correct it immediately. It's also a good idea to carry a few spare parts which could correct a small problem, if one should develop. These parts can be obtained from your dealer or larger campground stores.

SECTION 6 PLUMBING

Refer to the toilet manufacturers' information in your Owner's packet, to determine which part you may need, it's correct name, and part number. (If you have a toilet different than the one described or pictured, follow the toilet manufacturer's recommendations for cleaning and maintenance.)

WATER SYSTEM WINTERIZATION

When storing your recreational vehicle through periods of freezing weather, in an unheated environment, it will be necessary to winterize the water system. Damage to water system components will result if the proper winterization steps are not taken.

NOTE

WHEN CONSIDERING WINTERIZING, YOU MUST WINTERIZE ACCORDING TO CLIMATE. ANY DAMAGE THAT OCCURS FROM IMPROPER WINTERIZATION IS A MAINTENANCE ISSUE, AND NOT WARRANTABLE.

NOTE

BEFORE USING THE COMPRESSED AIR METHOD, YOU WILL NEED A SPECIAL ADAPTER KNOWN AS A BLOW-OUT PLUG. THIS PLUG ALLOWS COMPRESSED AIR TO BE DELIVERED THROUGH THE CITY WATER FILL. THIS SMALL, INEXPENSIVE ADAPTER IS AVAILABLE AT MOST RV SUPPLY STORES.

DANGER

NEVER USE AUTOMOTIVE ANTIFREEZE IN YOUR FRESH WATER SYSTEM. AUTOMOTIVE ANTIFREEZE IS TOXIC AND NOT FOR USE IN POTABLE (DRINKABLE) WATER SYSTEMS.

WINTERIZING WITH COMPRESSED AIR

(With By-pass Kit Installed)

Purchase 2 gallons of RV non-toxic antifreeze.

1. Drain the fresh water tank and empty the waste water holding tanks.
2. Turn the water heater bypass valve to the 'bypass' position. (This valve is located near the water heater incoming lines, at the rear of the water heater. The water heater is usually located in a base cabinet, in the kitchen, and it may be necessary to remove an access panel to reach the bypass valve.)
3. Drain the water heater.
4. If you have a water filtering system installed, remove the filter from the assembly and discard. (You will need to purchase a new one and install it, when de-winterizing your unit.)
5. Open all faucets, including shower head sprayer, (if applicable), toilet flushing device, and any other water lines that are closed.
6. Turn on the water pump for at least 30 seconds, to clear any water from the lines.
7. Connect an air hose with an adapter (blow out plug), to the city water fill connection.
8. Set the pressure to no greater than 30# (pounds) and blow out the water lines until no water can be seen coming out of the fixtures and lines.
9. Pour RV anti-freeze into drains, p-traps, toilet and tanks.

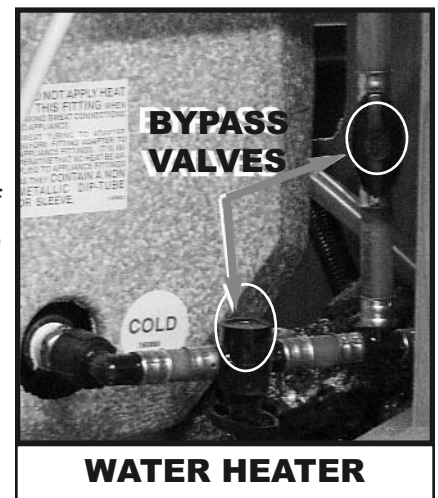

WARNING

DO NOT ATTEMPT TO START THE WATER HEATER, OR USE THE PLUMBING SYSTEM, AFTER THE SYSTEM HAS BEEN WINTERIZED. PRIOR TO USE, YOU MUST DEWINTERIZE, FLUSH, AND SANITIZE THE WATER SYSTEM, AS DIRECTED ON PAGE 46 OF THIS MANUAL.

DANGER! INDICATES A HAZARDOUS SITUATION WHICH, IF NOT AVOIDED, WILL RESULT IN DEATH OR SERIOUS INJURY.

'WARNING' INDICATES A HAZARDOUS SITUATION WHICH, IF NOT AVOIDED, COULD RESULT IN DEATH OR SERIOUS INJURY.

SECTION 6

PLUMBING

WINTERIZING WITH RV APPROVED ANTI-FREEZE

Purchase 4-6 gallons of RV approved, non-toxic antifreeze.

1. Drain all tanks, fresh water, and sewage tanks.
2. Turn water heater bypass valve to 'bypass' position. (See picture on previous page.)
3. Drain water heater.
4. If you have a water filter system installed, remove the filter from the assembly and discard. (You will need to purchase a new one and install it when dewinterizing your unit.)
5. Fill the tank above minimum water pump operation level with the RV antifreeze. (Use of a long funnel may be helpful.)
6. Turn the pump switch 'ON' and open the cold water side of all faucet fixtures. Leave the faucets open until the antifreeze, (generally pink in color), flows out of the faucets. Repeat for the hot water side.
7. Flush toilet until antifreeze is visible inside the bowl and pour one gallon of antifreeze down the toilet to winterize the black holding tank.
8. Pour antifreeze down each shower/tub, lavatory sink and kitchen sink to fill p-traps.
9. To winterize gray tank(s), pour one gallon down each related sink drain.

DEWINTERIZING YOUR RV

DO NOT ATTEMPT TO TURN ON THE WATER HEATER OR USE THE PLUMBING SYSTEM ONCE THE SYSTEM HAS BEEN WINTERIZED. DEWINTERIZE THE WATER SYSTEM, FLUSH AND SANITIZE PRIOR TO USE.

1. Drain all holding tanks, (fresh water and sewage).
2. Attach a garden hose to the fresh water fill and fill tank.
3. Turn 'ON' pump switch and open cold water side of all faucet/shower fixtures. Leave open until the water runs clear, (no pink residue). Repeat for the hot water side.
4. Flush the toilet until clear water runs into the bowl.
5. Dump tanks again.
6. Sanitize the water system. (Refer to page 46 in this manual)
7. If a water filtering system is installed, drain the lines, remove the assembly, clean and reinstall, using a new filter.
8. When ready to use the water heater, turn the by-pass valve to the OPEN position, to allow water to enter and fill the hot water heater tank.

WATER SYSTEM MAINTENANCE AND TROUBLESHOOTING

As with any mechanical system, your plumbing is subject to the development of problems. Most of these problems can be greatly reduced, if not eliminated, by following a schedule of planned inspections and maintenance. Neglect or improper maintenance procedures is the usual cause of most water system problems.

Shocks, road vibrations, and excessive pressure from some city water sources, are the main physical causes of water system damage. It is important to inspect all plumbing joints and fittings often, for cracks and leaks. Left unchecked, water leaking from plumbing joints can cause considerable damage.

SECTION 6

PLUMBING

TROUBLESHOOTING WATER SYSTEM

- A leak in the fresh water system should be suspected if the pump is running and all faucets and valves are closed.
- When the leaking fitting has been identified, attempt to stop the leak by tightening the fitting. **DO NOT** over tighten. Plastic fittings rarely need to be tightened with a wrench.
- If the fittings leak after tightening by hand, disconnect the fitting and check for dirt, scale, or other foreign substances which could be causing the leak.
- Clean the fittings thoroughly and reinstall. If leaking persists, shut off the water supply until the fitting can be properly replaced. Check with your dealer for the correct method of replacement and To obtain replacement parts, if needed.

Proper winterization procedures of plumbing systems will normally be all that is necessary to prevent the damage caused by freezing. Freezing damage can harm any component of the system, including the water tank/s, toilet, pump and all piping. Be sure to follow the winterization procedures outlined in this manual. Also, be sure to discuss with your dealer or repair center, any additional precautions which should be taken, to winterize your RVs plumbing system. Local climates vary and winter maintenance needs may be effected.

In the Owner's packet, check for troubleshooting tips in the literature supplied by plumbing component manufacturers, such as the water pump and toilet. Remember that it is possible for an electrical problem to cause water system problems.

If you are unsure of how to locate and/or repair a plumbing problem, it's best to have your dealer or a qualified plumber who is familiar with the RV water system, to inspect the system and perform any repairs needed.

HOLDING TANKS

Due to the vast array of floor plans and the necessary rearranging of plumbing systems, locations will change, but generally, the holding tanks are located approximately beneath the bathroom area. Drain valves and drain hose storage are usually located on the driver's side. The storage tanks are constructed of strong, light-weight polyethylene, which minimizes both maintenance and weight. Some models may have two gray water tanks, one black, and one fresh water tank.

END OF SECTION

NOTES:

SECTION 7

APPLIANCES

APPLIANCES

Due to the variety of floor plans available at Forest River, and the various shapes and sizes of coaches, we use many different brands of appliances, designed to fit into the designated space in each motorhome. Therefore, all appliances used can not be listed in this section. While we will attempt to touch on the major ones, please keep in mind your best resource is the specific appliance manual that came with your Owner's packet. It will detail the product used in the manufacture of YOUR motorhome. (If, by chance, you don't have the manual you need, many times you can find it on line, where you will have the option of reading it, or printing it for your future use. Be sure you have the model and serial number of your specific appliance handy, so you get the most accurate information.)

Each appliance in your RV is warranted by its' manufacturer. It is very important that you review ALL the literature provided in the Forest River Owner's packet that came with your motorhome. Fill out and mail any warranty registration cards required by the appliance manufacturers. If you have any questions regarding the operation of the appliances in your unit, contact your selling dealer. Also, please notify your dealer of any shortage of literature you may have.

It is important that you read all the manufacturer's information provided, regarding both operation and maintenance of the appliance. Pay close attention to all safety precautions given, and follow them closely. Keep all literature, including this manual, with the motorhome, for easy reference. If service on any appliance is required, contact your dealer or an authorized service representative of the appliance manufacturer. For your convenience, most appliance manufacturers have toll free service telephone numbers. You will find some listed in the front of this manual, under the heading of COMPONENT MANUFACTURERS.

RANGE/OVEN

TO PREVENT FIRE OR SMOKE DAMAGE

1. Keep area around appliances clear and free from combustible materials, gasoline, and other flammable vapors and materials.
2. If the appliance is installed near a window, take proper precautions to prevent curtains from blowing over burners.
3. Never leave any items unattended on the cooktop. The hot air from the vent may ignite flammable items, and may increase pressure in closed containers, which may cause them to burst.
4. Avoid use or storage of aerosol cans near any appliance. Many are EXPLOSIVE when exposed to heat, and may be highly flammable.
5. Do not leave plastic items on the cooktop, as they may melt or soften. If this occurs, discard the container and contents, as the food could be contaminated.

⚠WARNING NEVER TURN EXHAUST FAN ON WITH FILTER SCREEN REMOVED. EXPOSED FAN BLADES POSE AN INJURY THREAT. DIRT AND GREASE DEPOSITS WHICH ARE NORMALLY TRAPPED BY THE FILTER, ARE FREE TO BUILD UP IN THE RANGE HOOD EXHAUST DUCT, CREATING A FIRE HAZARD.

⚠WARNING IT IS NOT SAFE TO USE COOKING APPLIANCES FOR COMFORT HEATING.

⚠WARNING NEVER TURN EXHAUST FAN ON WITH FILTER SCREEN REMOVED. EXPOSED FAN BLADES POSE AN INJURY THREAT. DIRT AND GREASE DEPOSITS WHICH ARE NORMALLY TRAPPED BY THE FILTER, ARE FREE TO BUILD UP IN THE RANGE HOOD EXHAUST DUCT, CREATING A FIRE HAZARD.

IT IS NOT SAFE TO USE COOKING APPLIANCES FOR COMFORT HEATING.

SECTION 7 APPLIANCES

READ ALL INSTRUCTIONS BEFORE USING THIS APPLIANCE. THE FOLLOWING INSTRUCTIONS ARE BASED ON SAFETY CONSIDERATIONS AND MUST BE STRICTLY FOLLOWED TO ELIMINATE THE POTENTIAL RISKS OF FIRE, ELECTRIC SHOCK OR PERSONAL INJURY. HAVE YOUR APPLIANCE INSTALLED AND PROPERLY GROUNDED BY A QUALIFIED INSTALLER AND ACCORDING TO THE INSTALLATION INSTRUCTIONS. HAVE THE INSTALLER SHOW YOU THE LOCATION OF THE GAS SHUT OFF VALVE AND HOW TO SHUT IT OFF IN AN EMERGENCY.

ALWAYS DISCONNECT POWER TO APPLIANCES BEFORE SERVICING

TO ENSURE PROPER OPERATION AND AVOID POSSIBLE INJURY OR DAMAGE TO UNIT, DO NOT ATTEMPT TO ADJUST, REPAIR, SERVICE, OR REPLACE ANY PART OF YOUR APPLIANCE. ALL OTHER SERVICING SHOULD BE REFERRED TO A QUALIFIED INSTALLER OR SERVICER.

The gas oven and burners are operated using LP gas. Cooking appliances need fresh air for safe operation.

Before operating this appliance:



- Open an overhead vent or turn on an exhaust fan, **AND**
- Open a window.

Unlike a stationary house, the amount of oxygen supply in an RV is limited, due to the size of the motorhome, and proper ventilation when using the cooking appliance(s) will help avoid the dangers of carbon monoxide poisoning and/or asphyxiation.

The most common type RV range, is a three or four burner, built-in range with a glass oven door. It may light manually, or by using piezo ignition, which means there is no pilot light for the range. Be sure the main LP gas valve on the LP tank, is in the 'ON' position.

LIGHTING SURFACE BURNERS

The surface burners will feature either matchlit ignition or Piezo pilotless ignition. Be sure all control knobs are in the 'OFF' position, before supplying gas to the appliance. Be sure the main LP gas supply is ON, before lighting the burner.

NOTE IF THE BURNER DOES NOT LIGHT WITHIN ABOUT 4 SECONDS, OR IF THE FLAME SHOULD GO OUT DURING COOKING, TURN THE BURNER OFF. IF GAS HAS ACCUMULATED AND A STRONG GAS ODOR IS DETECTED, OPEN A WINDOW, AND WAIT 5 MINUTES FOR THE GAS ODOR TO DISAPPEAR, BEFORE RELIGHTING THE BURNER.

CAUTION IF THE APPLIANCE HAS NOT BEEN OPERATED FOR A PERIOD OF TIME, THE SURFACE BURNERS MAY BE DIFFICULT TO LIGHT, DUE TO AIR ACCUMULATING IN THE GAS LINE.

WARNING DO NOT TURN THE CONTROL KNOB **ON**, ALLOWING GAS TO ESCAPE, BEFORE LIGHTING THE MATCH.

'WARNING' INDICATES A HAZARDOUS SITUATION WHICH, IF NOT AVOIDED, COULD RESULT IN DEATH OR SERIOUS INJURY.
'CAUTION' INDICATES A HAZARDOUS SITUATION WHICH COULD RESULT IN VEHICLE DAMAGE OR MINOR TO MODERATE INJURY

SECTION 7

APPLIANCES

TO BLEED AIR FROM LINE



- Hold a lighted match next to the burner.
- Turn the surface burner control knob to the LITE position.
- When the burner ignites, turn the knob back to the OFF position.
- Depending upon your model, follow the procedure for either 'Matchlit' ignition, or 'Piezo' ignition.

MATCHLIT IGNITION



1. Place a pan on the burner grate.
2. Hold a lighted match next to the desired surface burner head.
3. Push in and turn the surface burner control knob to the LITE position.
4. When the burner ignites, turn the knob between HI and LOW, to select the desired flame size.
5. After cooking, turn the surface burner knob to the OFF position.



PIEZO IGNITION



1. Place a pan on the burner grate.
2. Push in and turn the surface burner control knob to the 'LITE position. (IMPORTANT: Only light one surface burner at a time.)
3. Immediately, rotate the top burner igniter knob to the right, (clockwise), several clicks, until the burner ignites. The burner should light within 6 clicks, or one full rotation of the knob.
4. When the burner ignites, adjust the surface burner control knob between HI and LOW to select the desired flame size.
5. After cooking, turn the surface burner control knob to the OFF position.



If the piezo ignitor is not functioning:



- Be sure all controls are in the 'OFF' position
- Hold a lighted match to the desired surface burner head. (DO NOT turn the control knob ON before lighting the match. Doing so will allow gas to escape.)
- Push in and turn, the surface burner control knob to the LITE position
- When the burner lights, adjust the knob between HI and LOW to select the desired size
- After cooking, turn the knob to the 'OFF' position



CAUTION

WHEN THE MOTORHOME IS NOT IN USE, OR WHEN TRAVELING, TURN ALL KNOBS TO THE OFF POSITION AND TURN OFF THE MAIN GAS SUPPLY.

CAUTION INDICATES A HAZARDOUS SITUATION WHICH COULD RESULT IN VEHICLE DAMAGE OR MINOR TO MODERATE INJURY.

SECTION 7 APPLIANCES

USING THE OVEN (DO NOT cover bottom, or entire rack, with aluminum foil.)

Whether the oven features pilot or piezo ignition, be sure all control knobs are in the OFF position, before supplying gas to the appliance. Be sure the gas supply to the appliance is ON, before lighting the pilot or oven burner. NOTE: If the appliance has not been operated for a prolonged period of time, the oven pilot may be difficult to lite, due to air in the gas line.

TO LIGHT OVEN PILOT:

1. Be sure all controls are in the OFF position.
2. Push in and turn the OVEN knob to the PILOT ON position.
3. Open the oven door and locate the oven pilot, (beneath the oven bottom, on the left side of the burner). While pushing the knob in, hold a match next to the oven pilot for 10 -15 seconds, or until a small flame is visable.
4. Once the pilot is lit, if you wish to use the oven, leave the OVEN knob in the PILOT ON position. (The standing pilot will remain lit, if the OVEN knob is left in the PILOT ON position.) If the OVEN knob is turned to the OFF position, gas supply to the pilot will be turned off, and the standing pilot flame will extinguish. Since each oven has its own personal baking characteristics, do not assume your new oven will perform exactly like your previous one. You may find that cooking times, oven temperatures, and cooking results differ somewhat from your previous range. Allow a period of adjustment.

NOTE

A DELAY IN THE TIME IT TAKES TO LIGHT THE PILOT, MAY SIGNAL A NEED TO BLEED AIR FROM THE LINE.

OVEN KNOB

The OVEN knob is used to select and maintain the oven temperature. Push in and turn this knob to the desired temperature. DO NOT set it at a higher temperature, then turn it back. Setting it at the desired temperature will provide more accurate oven temperature. Turn this knob to the PILOT ON position if you wish to use the oven. The oven standby pilot will remain lit. Turn the knob to the OFF position if the oven will not be used, or when traveling.

SHUTDOWN INSTRUCTIONS:

When the motorhome is not in use, or while traveling, turn the OVEN knob to the OFF position and turn off the main gas supply. This will turn off the oven pilot.

NOTE

THE MAXIMUM RECOMMENDED PAN SIZE IS 13 x 9 x 2" CAKE PAN, 14 x 10 x 2" COOKIE SHEET, OR 10" FOR A SKILLET. DO NOT USE CANNERS OR OVERSIZED COOKWARE. THE PAN SHOULD NOT BE MORE THAN ONE INCH LARGER THAN THE BURNER GRATE.

MICROWAVE OVEN



- DO NOT attempt to override, or tamper with safety interlocks.
- DO NOT place any object between the oven front frame and the door.
- DO NOT allow residue to build up on sealed surfaces.
- DO NOT subject the oven door to strain or weight
- DO NOT operate the oven if door seals are damaged, door is bent, or hinges are loose or broken.
- DO NOT operate the oven empty.
- DO NOT attempt to dry clothing, newspapers or ANY other material in the oven.
- DO NOT use recycled paper products, as they may contain impurities and cause sparks or fires.
- DO NOT hit or strike the control panel with hard objects.

SECTION 7

APPLIANCES

General Operation



- The oven light in the microwave oven is on only during operation or if the door is open.
- The oven automatically cooks on full power unless set to a lower power level.
- When the STOP/CLEAR pad is touched during the oven operation, the oven stops cooking and all information is retained. To erase all information (except the present time), touch the STOP/CLEAR pad once more. If the oven door is opened during operation, all information is retained.
- If the START pad is touched and the oven does not operate, check the area between the door and door seal for obstructions and be sure the door is closed securely. The oven will not start cooking until the door is completely closed, or the program has been reset.
- There may be a child safety lock on your oven. Check the manufacturers user guide. To set, press STOP/CLEAR pad for 3 seconds and LOCK indicator appears with a 'beep' sound. To cancel, press STOP/CLEAR pad for 3 seconds and LOCK indicator disappears with a beep.

Food



- DO NOT use your microwave oven for home canning.
- DO NOT use the maximum recipe cooking time, unless you have previously done so.
- DO NOT heat eggs in the shell.
- DO NOT cook potatoes, apples, egg yolks, or sausages without first piercing the surface.
- DO NOT attempt to deep fry in your microwave oven.

REFRIGERATOR

Most RV refrigerators operate on the absorption system. In an absorption refrigeration system, ammonia is liquefied in the finned condenser coil at the top rear of the refrigerator. The liquid ammonia then flows into the evaporator, inside the freezer section, and is exposed to a circulating flow.

NOTE WHEN STARTING THE REFRIGERATOR FOR THE FIRST TIME, THE COOLING CYCLE MAY REQUIRE UP TO FOUR HOURS OF RUNNING TIME BEFORE THE COOLING UNIT IS FULLY OPERATIONAL.

Leveling

Leveling is one of the requirements for proper operation of absorption refrigerators. Any time the motorhome is parked for several hours, with the refrigerator operating, the vehicle should be leveled, to prevent loss of cooling. If the refrigerator is operated when the coach is not level, and the vehicle is not moving, liquid ammonia will accumulate in sections of the evaporator tubing. This will slow the circulation, or, in severe cases, completely block it, resulting in a loss of cooling. When the vehicle is moving, the rolling and pitching movement of the motorhome will help to keep the liquid ammonia from accumulating.

Automatic Energy Selector System

The refrigerator may be equipped with an automatic energy selector system, either a 2 way or 3 way system. This system can be set by the user, to be fully automatic, (select AUTO mode), to operate on LP gas only, (AUTO mode is OFF), or DC (battery). If the user turns the refrigerator to AUTO mode, the AES system will automatically select the most suitable energy source available, either 120 volt or LP gas, or battery operation.

SECTION 7 APPLIANCES

Auto Mode

When on AUTO mode, the control system will automatically select between 120 volt (AC) and LP gas, or on a 3 way system, DC current. AC (electricity) has priority over GAS and DC current has priority over both. (If the CHECK indicator lamp is on, the lamp will not turn off until the ON/OFF button is pressed OFF and then ON again.)

Gas Mode

This mode provides LP gas only. The control system activates the ignition system and attempts to ignite the burner for a period of approximately 45 seconds, at 2 minute intervals. If unsuccessful, the CHECK indicator lamp will illuminate.

If the CHECK indicator lamp is illuminated on the control panel, the controls have failed to ignite the burner. To restart an ignition attempt when the CHECK lamp is illuminated, (or to turn off the CHECK lamp), press the ON/OFF button to OFF and back to ON again. The control system activates the ignition system and makes three attempts to ignite the burner. If, after 3 attempts, it fails to ignite, restart the ignition sequence by again, by pressing the ON/OFF button to OFF, and back to ON.

DC Mode

When DC mode is chosen, the refrigerator will operate by drawing power from the battery/s. In most cases, the refrigerator controls will continue to operate when the battery is down to 9.6V DC, causing a drain on the battery.

NOTE WHEN IN AUTO MODE, IF THE REFRIGERATOR FAILS TO OPERATE, REFER TO THE REFRIGERATOR MANUFACTURERS' USER MANUAL, PROVIDED WITH THE FOREST RIVER OWNER'S PACKET.

PURGING AIR FROM THE LINES

If the refrigerator has not been used for a prolonged period of time, or if the LP tanks have just been refilled, air may be trapped in the supply lines. Purge the air from the lines by pressing the ON/OFF button to OFF, and back to ON, 3-4 times. If repeated attempts fail to start the LP gas operation, check to make sure the LP tanks are not empty and that all manual shutoff valves in the lines are open.

WARNING DO NOT CONTINUE TO RESET GAS OPERATION IF THE CHECK INDICATOR LAMP CONTINUES TO BE ILLUMINATED AFTER SEVERAL TRIES. IF THE PROBLEM PERSISTS, PLEASE CONTACT A SERVICE CENTER FOR ASSISTANCE.

F I R E O R E X P L O S I O N H A Z A R D

W A R N I N G

WHEN REFUELING OR PARKED NEAR GASOLINE PUMPS, SHUT OFF ALL LP GAS APPLIANCES. FAILURE TO HEED THIS WARNING COULD CAUSE A FIRE OR EXPLOSION RESULTING IN DEATH OR SEVERE PERSONAL INJURY AS WELL AS DAMAGE TO THE COACH AND/OR SURROUNDING AREA.

'WARNING' INDICATES A HAZARDOUS SITUATION WHICH COULD RESULT IN DEATH OR SERIOUS INJURY.

SECTION 7



APPLIANCES

FURNACE

WARNING

BEFORE OPERATING THE FURNACE, CHECK THE LOCATION OF THE FURNACE VENT, TO BE SURE IT WILL NOT BE BLOCKED BY THE OPENING OF ANY DOOR, OR BY EXTERIOR ITEMS SUCH AS A BUSH OR A TREE.

Tips to assure continued safe operation of the furnace.

- 
- 
1. Inspect furnace venting. Venting must be free of obstruction and soot
 2. Periodically observe the main burner flame to ensure it is burning with a hard blue flame. If the flame appears yellow or lazy, shut the furnace down. The burner may need to be cleaned or replaced.
 3. Keep the furnace area clear of any combustible materials.gasoline or other flammable vapor and liquids.

WARNING

TO PROPERLY OBSERVE BURNER OPERATION, THE FURNACE MUST BE REMOVED. THIS SHOULD BE DONE ONLY BY YOUR DEALER OR A QUALIFIED SERVICE CENTER.

WARNING

DO NOT INSTALL SCREENS OVER THE VENT FOR ANY REASON. DOING SO CAN CAUSE UNSAFE FURNACE OPERATION.

WARNING

SHOULD OVERHEATING OCCUR OR THE GAS SUPPLY FAIL TO SHUT OFF, SHUT OFF THE MANUAL GAS VALVE TO THE APPLIANCE BEFORE SHUTTING OFF THE ELECTRICAL SUPPLY.

WARNING



BE SURE THE FURNACE AND ALL IGNITION SYSTEMS ARE 'OFF' DURING REFUELING AND WHILE VEHICLE IS IN MOTION.

DANGER

READ THE FURNACE MANUFACTURERS USERS MANUAL. IF THE INFORMATION IN THE MANUAL IS NOT FOLLOWED EXACTLY, A FIRE OR EXPLOSION MAY RESULT, CAUSING PROPERTY DAMAGE, PERSONAL INJURY, OR LOSS OF LIFE.

If You Smell Gas:



- Extinguish any open flame. 
- Evacuate all persons from the vehicle. **EXIT**
- Shut off the gas supply at the gas container or source.
- Do not touch any electrical switch or use the phone or radio in the vehicle. 
- Do not start the generator, if so equipped.
- Contact the nearest gas supplier or qualified service center for repairs.
- If you can not reach a gas supplier or qualified service center, call the fire department.



DO NOT TURN ON THE GAS SUPPLY UNTIL THE GAS LEAK(S) IS REPAIRED

WARNING

INSPECT THE FURNACE MONTHLY, DURING THE HEATING SEASON, FOR PRESENCE OF SOOT ON THE VENT. THE PRESENCE OF SOOT INDICATES INCOMPLETE COMBUSTION. OPERATING THE FURNACE UNDER THIS CONDITION COULD LEAD TO SERIOUS PROPERTY DAMAGE, PERSONAL INJURY OR LOSS OF LIFE. IF SOOT IS OBSERVED ON THE VENT, IMMEDIATELY SHUT THE FURNACE DOWN AND CONTACT A QUALIFIED SERVICE AGENCY.

HOT WATER HEATER

CAREFULLY FOLLOW THE WATER HEATER MANUFACTURERS DETAILED INSTRUCTIONS REGARDING THE CORRECT OPERATION OF YOUR WATER HEATER. FAILURE TO DO SO COULD VOID YOUR WARRANTY.

Hot water heaters require very little care. However, the most common cause of problems with your water heater is initiating operation before the tank is filled with water. Even running it for a brief period of time, without water, will damage the electric heating element.

DANGER! INDICATES A HAZARDOUS SITUATION WHICH, IF NOT AVOIDED, WILL RESULT IN DEATH OR SERIOUS INJURY.

'**WARNING**' INDICATES A HAZARDOUS SITUATION WHICH COULD RESULT IN DEATH OR SERIOUS INJURY.

SECTION 7 APPLIANCES

WATER HEATER GENERAL OPERATION

- Prior to operating the water heater for the first time, be sure there is water in the water heater tank.
- Be sure that the water heater by-pass valve, if installed, is open, to allow water flow into the tank.
- Next, connect the RV to a water source, or turn on the onboard water pump. Open a hot-water tap and wait until water is flowing, with no air in the line. When the water heater tank is full, it is safe to operate the water heater. (Your water heater was designed with the option of operating on LP gas when 110 volt power is unavailable.)

WARNING

DO NOT STORE OR USE GASOLINE OR OTHER COMBUSTIBLE MATERIALS OR LIQUIDS NEAR OR ADJACENT TO THE WATER HEATER OR ANY OTHER APPLIANCE.

Automatic Shut Off

The water heater is equipped with a high temperature limit switch, which will shut down the water heater if the temperature reaches above 180°. If the limit switch should fail, the water heater is equipped with a pressure relief valve which is designed to open, if the temperature of the water reaches 210 degrees F, or if excessive pressure builds up. The valve will close automatically once the pressure falls below 50 PSI. Until the pressure falls below 50 PSI, dripping may occur. This is normal and indicates the pressure relief valve is functioning properly by releasing pressure, causing temporary dripping.

Water Odor

Odor from the water is not a warranty or service issue. Many water supplies contain enough sulphur to produce a 'rotten egg' odor. It is not harmful, only unpleasant. The solution is to chlorinate the water. You may add about 6 ounces of common household liquid bleach per 10 gallons of water in the tank.

Run the chlorinated water throughout the system, opening each faucet one at a time until you smell the chlorine. Do not operate the water system for a couple hours, allowing the chlorine to take care of the problem. However, then you must remove the chlorine by flushing the system with fresh water. You may need to do this more than once. If this process does not remove the smell from the water, you may need to replace the anode rod. You may also consider adding a filtering system as a preventive measure.

IF YOU SMELL GAS

- DO NOT light any appliance.
- DO NOT touch any electric switch.
- DO NOT use any telephone in the unit.
- Using an outside phone, immediately call your gas supplier.

IF YOU CANNOT REACH YOUR GAS SUPPLIER, CALL THE FIRE DEPARTMENT.



TURN OFF WATER HEATER



1. Turn switch to OFF position.
2. Turn off electrical power to the appliance.
3. Turn off gas supply.
4. If the motorhome is to be stored or heater is going to be turned off while subject to freezing temperature, drain the water heater.



'WARNING' INDICATES A HAZARDOUS SITUATION WHICH COULD RESULT IN DEATH OR SERIOUS INJURY.

SECTION 7 APPLIANCES

STORAGE AND DRAINING

If your motorhome will be stored during winter months, drain the water heater to prevent damage from freezing.



1. Turn off electrical power to water heater, either at the switch or the breaker.
2. Turn off gas supply to water heater.
3. Turn off water pump on main water system.
4. Open both hot and cold water faucets and allow water lines to drain completely.
5. Remove anode rod from tank.

WINTERIZING

If your water heater plumbing system is equipped with a bypass kit, use it to close off the water heater, drain it completely and leave it closed, (in the bypass position). If you are introducing anti-freeze into the system, be aware that it can be very corrosive to the anode rod, causing premature failure and leaving heavy sediment in the tank. If the plumbing system is not equipped with a bypass kit and you intend to winterize by adding antifreeze, we strongly recommend removing the anode rod, (storing it for the winter), and replacing it with a 3/4" drain plug. For more information regarding this process, contact your dealer.

WATER PUMP

The water pump supplied with your RV is designed to deliver smooth, consistent flow of water at all ranges of operation, while drawing only a low current.

OPERATION

Frequent pump cycling may be caused by excessive pressure created by one or more of the following, within the plumbing system:

- Low flow from partially open faucet.
- Water filters not on separate feed lines.
- Clogged water filters.
- Restrictive elbows and valves as possible in the first 2 feet after the pump.
- Flow restrictors in faucets and showerheads.
- Long lengths of small I.D. (inside diameter) lines.
- If replacing pipe/tubing, be sure it is at least 1/2" I.D. (inside diameter), for main lines.

To minimize cycling, consider removing plumbing restrictions or install an accumulator after the pump. Cycling should be minimized to prevent pulsing flow and to achieve maximum pump life. If the pump is cycling rapidly, increase the setting by turning the screw clockwise 1 1/2 turns maximum, until the pump operates for 1 second, with at least 2 seconds of OFF time'.

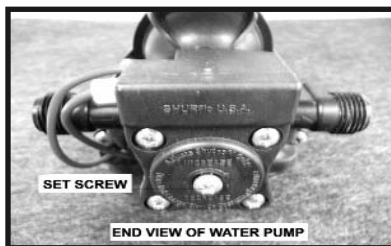

DANGER

DO NOT USE AUTOMOTIVE ANTIFREEZE TO WINTERIZE POTABLE (DRINKABLE) WATER SYSTEMS. AUTOMOTIVE ANTIFREEZE IS HIGHLY TOXIC AND INGESTION MAY CAUSE SERIOUS INJURY OR DEATH.

DANGER! INDICATES A HAZARDOUS SITUATION WHICH, IF NOT AVOIDED, WILL RESULT IN DEATH OR SERIOUS INJURY.

SECTION 7 APPLIANCES

THERMOSTAT - HEATING AND COOLING

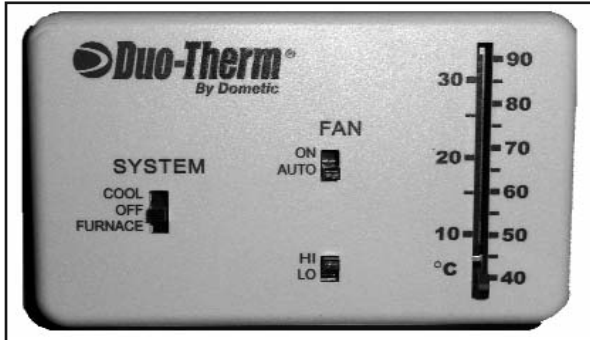

DUO HEAT AND COOL THERMOSTAT



Many factors influence the ambient temperature inside your RV. The purpose of a thermostat is to keep the air temperature at the level you have selected. There are several things you can do to help manage the inside temperature, to avoid over-stressing your heating and cooling appliances.

HEATING



1. Be sure there are no gaps in windows or doors, which would allow loss of heat.
2. Park the motorhome so the front or rear of the unit takes the brunt of wind force.
3. Have your furnace checked to ensure it's operating at its' highest capacity.
4. Keep all vents free of obstruction.

Setting the temperature and leaving the thermostat on AUTO, will allow the device to detect changes in temperature. While some people lower the temperature at night or when leaving the RV, be aware that when returning and resetting the thermostat, the furnace or air conditioner, has to work harder to reach the new temperature you set. We recommend setting it at a comfortable temperature and leaving it.

COOLING

1. Park the RV in a shaded area.
2. Use window shades, blinds or curtains.
3. Keep windows and doors shut or minimize usage.
4. Avoid the use of heat producing appliances.
5. Installing window awnings will reduce heat gain by removing direct exposure to the sun.

AIR CONDITIONER

Starting the air conditioner in the morning and giving it a head start on the expected high outdoor ambient temperature, will greatly improve its' ability to maintain the desired temperature indoors. Whether using the HEATING or the COOLING function of your thermostat, condensation is always an issue. Keeping your RV at a constant temperature helps keep condensation at a minimum. For more information on the effects of condensation on your RV, refer to Section 5 in this manual.

Your motorhome may be equipped with an optional, roof mounted air conditioner. It operates on 110 volt power and is located in the living/dining area and in the bedroom area of some models.

SECTION 7 APPLIANCES

Your motorhome may be factory equipped, with the wiring and necessary bracing for the insertion of an air conditioner, even if it was purchased without the air conditioner installed at the factory. Check with your dealer for additional information.

Refer to the air conditioner manufacturer's users' manual for complete operating and service instructions. Efficiency when using the air conditioning can be increased by closing all windows and curtains and parking your RV in the shade. Air conditioning consumes a large portion of the electric power available in the recreational vehicle and efficient operation can be an important consideration.

Even though your motorhome is equipped with 30 or 50 amp capabilities, be aware that some campgrounds may offer less than 30 amp service. Check with the campground before utilizing excessive power, which may create a fire hazard or trip breakers, in either the recreational vehicle, or the outside power source.

CAUTION

ALWAYS TURN OFF AIR CONDITIONER (AND ALL ELECTRICAL APPLIANCES) BEFORE DISCONNECTING THE RV FROM THE 110 VOLT POWER SOURCE.

CAUTION

IF YOU COVER THE OUTSIDE PORTION OF YOUR AIR CONDITIONER DURING PERIODS OF STORAGE, BE SURE TO REMOVE PROTECTIVE COVER BEFORE REUSING.

TELEVISION

Due to the large selection of televisions used in the manufacturing of Forest River motorhomes, it is impossible to list all of them in this manual. Therefore, you will find general information that will be applicable to most all televisions. For more detailed information regarding the specific television/s installed in your motorhome, please refer to the television manufacturer's users guide included in your Forest River Owner's packet.

CABLE

Your motorhome is prewired for cable. Televisions operate on 12 volt and 110 volt power. Your coach must be connected to shore power, have the generator (optional) running, or the inverter (optional) connected, for the TV to operate.

TELEVISION ANTENNA

The optional roof mounted antenna control is located in the ceiling of the lounge/kitchen area and/or in the bedroom. The antenna can only be used when the recreational vehicle is parked.



CAUTION

CHECK YOUR PARKING LOCATION FOR OBSTRUCTIONS BEFORE RAISING THE ANTENNA. ALSO BE SURE THE POWER BOOSTER SWITCH IS IN THE ON POSITION.

TO RAISE THE ANTENNA

1. The antenna handle is located on the ceiling in the main living area. Crank the HANDLE in the UP direction, as indicated by the arrow on the large control knob.
2. Continue to rotate the handle until you feel resistance (about 13 turns).

CAUTION INDICATES A HAZARDOUS SITUATION WHICH COULD RESULT IN VEHICLE DAMAGE OR MINOR TO MODERATE INJURY.

SECTION 7 APPLIANCES

3. **DO NOT** force the handle beyond the point that resistance is felt.
4. When the antenna is up, fine tune the signal by grasping the large rotating KNOB, pulling it slightly down and turning it until the clearest picture and sound are available.
5. To lower the antenna, rotate it with the large control knob until the pointer on the control knob lines up with the pointer on the ceiling plate. The antenna can now be lowered by cranking the handle in the down direction. Continue to rotate the handle until you feel resistance (about 13 turns.) To be sure the antenna is working properly, tune the TV receiver to the nearest station and rotate the antenna until you get good picture and sound. Then, turn off the switch on the power booster

TV ANTENNA

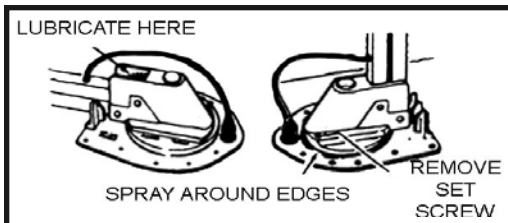

To lubricate the elevating gear, apply a liberal amount of silicone spray to the elevating gear with the lift in the DOWN position. Run the lift up and down several times to distribute the lubricant to the gears.

If rotating the antenna becomes difficult, normal operation can be restored by lubricating the bearing surface between the rotating gear housing, and the base plate. Any spray type silicone lubricant may be used.

Elevate the antenna and remove the set screw from the rotating gear housing (see illustration). Spray lubricant into hole and around the edges of the gear housing. Rotate the gear housing until the lubricant coats the bearing surfaces and the antenna rotates freely. Reinstall set screw.

REAR VISION, STEREO. CD PLAYER, GPS SYSTEM (OPTIONAL)

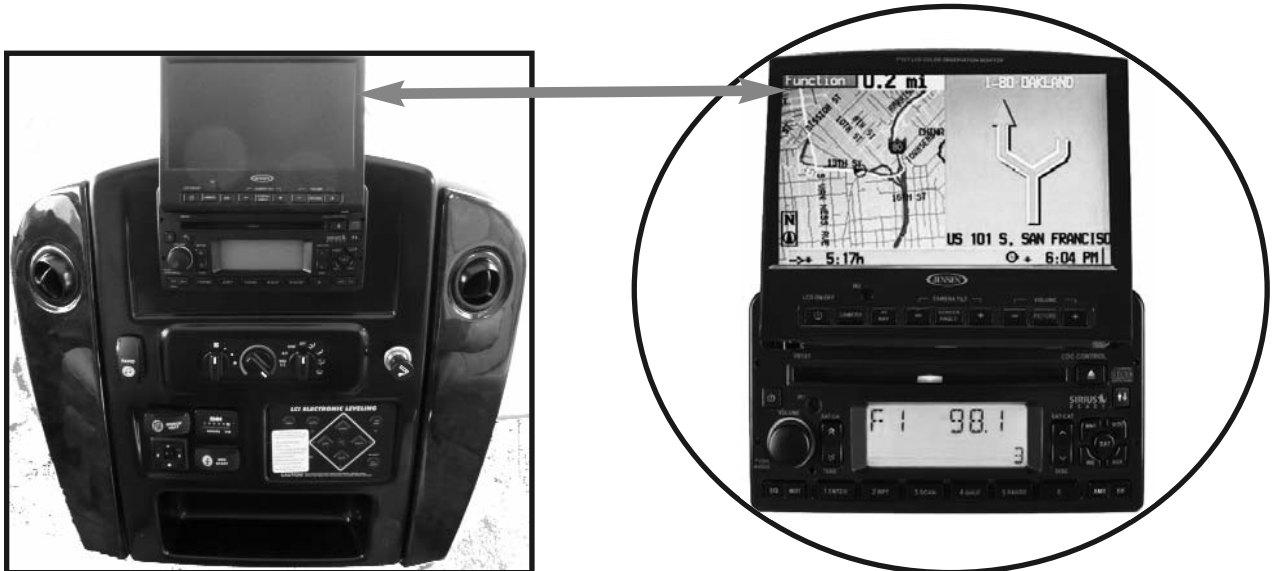

1. Power

Press the power button (1) or any other button on the front of the radio (except the eject button) to turn the unit on. Press the power button again to turn the unit off.

SECTION 8

CARE and MAINTENANCE

CARE AND MAINTENANCE

To retain the dependability, safety, and appearance, that will provide you with many miles of trouble free operation, as well as protecting your investment, periodic maintenance, and keeping your motorhome clean is necessary.

Keep good records of any service and all maintenance functions performed, and be sure to follow all owner obligations as may be required by the chassis manufacturer, to keep your warranty in force.

It is also important to note that operating conditions will effect service timetables. Driving in extreme conditions such as heavy dust, continuous short trips, or prolonged, frequent starting and stopping in heavy traffic, means that the length of time between service appointments will be shortened. Discuss service timetables with both your dealer and the chassis service representative.

Preventative maintenance will pay for itself many times over, by identifying or preventing problems before they occur. Many repair costs are greatly increased by ignoring problems when they are small ones, allowing them to build into larger problems and possibly voiding your warranty, due to neglect, misuse, or abuse. If left unattended, small problems may also begin to effect other parts and systems of the motorhome.

FIBERGLASS SIDING

The care of RV fiberglass siding is basically the same care as any automotive finish. All finishes will deteriorate with time. Dulling and fading can be increased by exposure to extreme sunlight, air pollutants and excessive moisture. Regular washing will help prevent this from occurring. If surface deterioration, such as yellowing or chalking occurs, consult your dealer for proper cleaning procedure.



- Wash the exterior monthly with warm water and a mild detergent.
- Avoid spraying water directly into refrigerator and furnace vents.
- To help avoid staining, immediately remove bird droppings, tree sap, insects or tar.
- Wax the exterior at least once a year, with a standard automotive liquid or paste wax.
- Prolonged storage of unit should be in a sheltered environment, when possible.

NOTE

PHYSICAL DAMAGE TO FIBERGLASS SHOULD BE ADDRESSED IMMEDIATELY TO AVOID MOISTURE ENTERING THROUGH BREAKS AND CAUSING PROBLEMS WITH INTERIOR WALLS AND COMPONENTS. COVER BREAKS IN THE FIBERGLASS WITH PLASTIC, SEALING THE EDGES WITH TAPE UNTIL PROPER REPAIRS CAN BE MADE.

WATER PUMP CARE AND OPERATION

Frequent pump cycling may be caused by excessive pressure created by one or more of the following, within the plumbing system:

- Low flow from partially open faucet.
- Water filters not on separate feed lines.
- Clogged water filters.
- Restrictive elbows and valves as possible in the first 2 feet after the pump.
- Flow restrictors in faucets and showerheads.
- Long lengths of small I.D. (inside diameter) lines.
- If replacing pipe/tubing, be sure it is at least ½" I.D. (inside diameter), for main lines.

If the pump is cycling rapidly, increase the setting by turning the screw clockwise 1½ turns maximum, until the pump operates for 1 second, with at least 2 seconds of OFF time'.

SECTION 8

CARE and MAINTENANCE

To minimize cycling, consider removing plumbing restrictions or install an accumulator after the pump. Cycling should be minimized to prevent pulsing flow and to achieve maximum pump life.

If the pump is cycling rapidly, increase the setting by turning the screw clockwise 1½ turns maximum, until the pump operates for 1 second, with at least 2 seconds of OFF time'.

The water pump supplied with your RV is designed to deliver smooth, consistent flow of water at all ranges of operation, while drawing only a low current.

WINDOWS AND DOORS

Check the seals around the windows regularly, if sealant is present. Follow the above instructions for care and maintenance of window and door seals and repair as necessary and if applicable.

To insure windows remain operative, adjust and lubricate latches and moving parts annually. Also check the condition and operation of door locks, adjusting and lubricating as necessary.

Vinyl seals around windows and doors should be cleaned regularly and kept flexible by using a silicone spray or lubricant. Be sure to follow the directions on the product container.

Keep screens and window slides clean and free of debris. Your windows are designed with a WEEP HOLE in the bottom tray. It's purpose is to allow water and/or condensation to exit through the hole. It's important that this area be kept clean and free of debris to prevent moisture build up. Periodically test the operation of all windows and their components.

CAUTION MOISTURE CAN ACCUMULATE IN LOCKS AND HINGES OF WINDOWS AND DOORS, CAUSING DAMAGE OR FAULTY OPERATION. DO NOT FORCE THE OPERATION OF THESE COMPONENTS IN FREEZING WEATHER.

WARNING **DO NOT** COVER EMERGENCY WINDOW(S). THESE EXIT WINDOWS MUST REMAIN ACCESSIBLE AT ALL TIMES. BE SURE ALL OCCUPANTS AND GUESTS KNOW WHICH WINDOWS ARE THE EMERGENCY EXIT WINDOWS AND UNDERSTAND HOW TO USE THEM.



EMERGENCY EXIT WINDOW



EMERGENCY EXIT CEILING VENT



FRAME, EXTRUSIONS AND ALUMINUM SURFACES

Check the condition of the frame regularly. Keep it clean and repaint as necessary, to help avoid rust. It is especially important to keep underbody components clean when driving your motorhome in the winter, in areas where road salts are used. To help avoid surface pitting, clean and wax all extrusions, when waxing RV sidewalls. Special aluminum cleaners are available to restore the original luster to aluminum surfaces. Be sure to follow the instructions as outlined on the product package.

'WARNING' INDICATES A HAZARDOUS SITUATION WHICH, IF NOT AVOIDED, COULD RESULT IN DEATH OR SERIOUS INJURY.
CAUTION INDICATES A HAZARDOUS SITUATION WHICH COULD RESULT IN VEHICLE DAMAGE OR MINOR TO MODERATE INJURY.

SECTION 8

CARE and MAINTENANCE

ROOF

Inspection of roof components at least twice a year, is very important to make sure seams and seals are not cracked or worn. Proper maintenance of seals is necessary to keep moisture from entering and causing severe damage such as rot, mold or mildew. If you encounter dry, cracked or weathered seals, reseal or replace as necessary. Check with your dealer for the type of caulking required for rubber roofs and correct methods of resealing or replacing. A mild household soap solution and a soft brush can be used to clean a rubber roof.

⚠ WARNING

IF YOUR ROOF SHOULD BECOME PUNCTURED OR RIPPED, COVER THE PUNCTURE OR TEAR TO SEAL OUT MOISTURE AND HAVE IT REPAIRED IMMEDIATELY.

⚠ WARNING

IF A FACTORY INSTALLED ROOF RACK AND/OR LADDER ARE PRESENT, THE ROOF HAS BEEN REINFORCED. IF YOU ADD AN AFTERMARKET ROOF RACK OR LADDER, USE EXTREME CAUTION WHEN ON THE ROOF. YOU MAY NEED TO USE BOARDS ACROSS THE ROOF FOR TEMPORARY REINFORCEMENT. (REMEMBER TO REMOVE THE BOARDS WHEN LEAVING THE ROOF AREA.)

LP GAS SYSTEM

To ensure proper operation, have the LP gas system checked frequently for leaks and road damage. The entire system including regulator pressure, should be checked annually or sooner, if you suspect a problem. Have the system checked by a qualified LP gas service technician using proper equipment. The method of checking the system for leaks and LP gas safety precautions can be found in Section 5 of this manual.

NOTE

LINE PRESSURE FOR LP GAS APPLIANCES SHOULD BE CHECKED AT LEAST EVERY SIX MONTHS. MOST LP GAS SUPPLIERS HAVE EQUIPMENT TO TEST THE LINES. THE CORRECT LINE PRESSURE FOR ALL RV LP GAS APPLIANCES, IS 11 INCHES OF WATER COLUMN PRESSURE.

EXTERIOR LIGHTS

Check the operation of exterior lights often. Check clearance, turn signal, brake and back-up lights to be sure they are working correctly. Replace any cracked, broken or missing light covers to avoid moisture infiltration and possible damage to their electrical system.

WINTER PRECAUTIONS

- **Water Systems** - In severe cold, it is wise to monitor the water temperature in the tank, and take steps to drain and winterize if necessary. It is also a good idea, in severe cold, to open lower cabinet doors in the kitchen and bath to allow warm air to circulate around water fixtures. To minimize freezing damage, insulate drain lines exposed to outside elements.
- **FOOD Storage** - If left in an unheated RV for a period of time, canned goods and other foods packed in water should be stored as high as possible since heat rises. Refrigerators can also be used for storage, even when unplugged, as they are well insulated.
- **Heating** - Use ONLY the RV furnace for heating, as it is properly vented to the outside. NEVER USE THE RANGE FOR HEATING AS FIRE, CARBON MONOXIDE OR ASPHYXIATION COULD RESULT.
- **Condensation** - Moisture can collect on inside surfaces during cold weather when inside humidity is high. While the coach is in use, a family can vaporize up to three gallons of water daily through daily living. Consider using a dehumidifier to remove moisture. See Section 4 of this manual for additional tips regarding how to reduce condensation.

'WARNING' INDICATES A HAZARDOUS SITUATION WHICH, IF NOT AVOIDED, COULD RESULT IN DEATH OR SERIOUS INJURY.

SECTION 8

CARE and MAINTENANCE

STORAGE TIPS



1. Park your RV on a level surface.
2. Winterize the chassis and the generator, (optional) as outlined in the chassis and the generator owner's manuals.
3. Clean your recreational vehicle thoroughly, inside and out, as previously outlined in this section.
4. Turn off all electrical switches and appliances.
5. Close all shades and curtains. Consider protecting the curtains from sun fade by placing foil or paper between the windows and the screens.
6. Be sure all windows, doors and vents are securely closed. Cover exterior appliance vents, to prevent moisture and insects from entering during storage.
7. Check the interior of the RV periodically to be sure leaks have not developed and that condensation has not formed, causing damage to interior components. Condensation can most readily be observed as moisture accumulation on windows and mirrors. To reduce the possibility of condensation, air out the RV occasionally during storage.
8. Be sure that both the chassis and auxiliary batteries have the proper electrolyte level and that they are fully charged. A discharged battery will freeze and crack the case. In storage, a battery will gradually lose charge after 30-45 days, even when disconnected by use of the battery disconnect switch. We recommend that you check the battery for charge once a month. If the charge is 80% or less, it must be recharged. You may wish to remove the battery and store it in a heated area. However, even when warm, the correct battery level must be maintained.
9. Be sure the tires are inflated to correct pressure and check periodically.
10. Keep the roof free from snow and ice. Check it periodically, and after a heavy snowfall.
11. Winterize the water systems and protect exterior hoses and lines from freezing. Follow the winterizing procedure outlined in Section 5 of this manual. Also follow all component manufacturers instruction regarding their particular product. (If their procedure differs from this manual, follow the component manufacturers instructions.)



HOLDING TANK HEATING PADS



EASY TO OPERATE

TANK HEATERS:

1. When the outside temperature is near freezing. Simply turn ON the holding tank heater's 13.5 VDC power switch and/or plug in the 120 VAC power cord.
2. There must be liquid in the holding tank, pipes, and elbows when UltraHeat™ heaters are ON.
3. The tank heater immediately starts protecting your holding tank from freezing up.
4. The thermostat on the heater will turn ON the tank heater as soon as the tank temperature drops in the tank to 44°F (7°C). The tank heater immediately starts protecting your holding tank. When the temperature in the holding tank rises to 64°F (18°C), the tank heater will automatically turn OFF.
5. If using a generator or other power source, which exceeds the heaters voltage requirements, turn the heater OFF and/or unplug the power cord to avoid eventual damage to the heater's thermostat.
6. Turn the power switch OFF (and/or unplug the power cord on the Dual Voltage Model when the outside temperature is above freezing.)
7. Failure to follow these operating instructions could result in the voiding of your warranty. (The control is generally located in the command center.)

NOTE: Tank heaters are thermostatically controlled. This product has been tested and designed to be used as a heating device for RV fresh water supply and waste water holding tanks made of standard grade plastics. UltraHeat™, Inc. assumes no liability for any usage of product for purpose other than what is consistent with the original design and testing.

SECTION 8

CARE and MAINTENANCE

STORAGE PREPARATION

When storing you RV for the winter, certain precautions need to be taken to protect your unit. Be sure to talk with your local dealer concerning any special requirements, for storage, in your particular geographic location. The following steps are general and your dealer can help you choose those which are most appropriate for your needs.

ITEM	EACH TRIP	EACH MONTH	3 MONTHS	6 MONTHS	EVERY YEAR	AS REQ.	PROCEDURE
FIBERGLASS EXTERIOR		X					WASH WITH WARM WATER AND MILD DETERGENT
					X		WAX WITH LIQUID OR PASTE WAX
ROOF AND ROOF COMPONENTS				X			INSPECT AND RESEAL AS NEEDED
					X		LUBRICATE ROOF VENT MECHANISM WITH LIGHT OIL AND CLEAN COMPLETELY
WINDOWS AND DOORS		X					CHECK VINYL SEALS WHEN WASHING EXTERIOR
			X				CHECK SEALS FOR DAMAGE AND REPAIR AS NEEDED
			X			X	LUBRICATE DOOR HINGES & STEP COMPONENTS WITH WD 40
					X	X	ADJUST AND LUBRICATE WINDOW LATCHES WITH WD 40 LUBE ALL DOOR LOCKS & STRIKE POCKETS
SEALS & ADHESIVES		X				INSPECT & RESEAL AS NECESSARY	
LP GAS SYSTEM					X	X	CHECK FOR LEAKS AND ROAD DAMAGE HAVE QUALIFIED SERVICE CENTER CHECK PRESSURES AND COMPLETE SYSTEM
WATER & DRAINAGE	X	X					CHECK HOSES, FITTINGS & CONNECTIONS FOR LEAKS AND WEAR CHECK DRAINAGE SYSTEMS FOR LEAKS AND ROAD DAMAGE
						X	SANITIZE SYSTEM
					X		WINTERIZE SYSTEM DEPENDING ON LOCAL CONDITIONS
ELECTRICAL SYSTEM	X						CHECK GFCI CIRCUITS
						X	MAINTENANCE ON GENERATOR PER GENERATOR MANUAL CHECK AND SERVICE BATTERY/S
APPLIANCES	X						REMOVE FOOD & ICE FROM REFRIGERATOR AFTER EACH TRIP
		X					CLEAN FAN BLADES AND WASH FILTER ON RANGE EXHAUST HOOD CHECK FOR OBSTRUCTIONS & DIRT ON EXT. APPLIANCE VENTS
SAFETY EQUIPMENT	X				X		CLEAN ALL DETECTOR COMPONENTS
		X					TEST ALL DETECTOR COMPONENTS CHECK FIRE EXTINGUISHER PRESSURE & CONDITION
CARPETING	X						VACUUM AFTER EACH TRIP
						X	CLEAN PER CARPET MANUFACTURERS INSTRUCTIONS
WOOD SURFACES		X					CLEAN PREFINISHED PANELS AND WOOD WITH WOOD CLEANER
SEATS						X	LUBRICATE ALL MECHANISMS AND INSPECT FOR PROPER OPERATION
						X	CHECK ALL SEAT BELT BUCKLES, RELEASE MECHANISMS & WEBBING
CHASSIS & COMPONENTS						X	FOLLOW CHASSIS LUBERICATION & MAINTENANCE PROCEDURES
WEIGHT & DISTRIBUTION	X						KEEP WITHIN SPECIFIED LOAD LIMITS
AXLES				X			TORQUE MOUNTING BOLTS TO SPECS. (SEE PAGE 21 IN THIS MANUAL)
WHEEL BEARINGS					X	X	REPACK WHEEL BEARINGS YEARLY
BRAKES				X		X	CHECK OPERATION AND FOR UNEVEN WEAR

NOTE CHASSIS MAINTENANCE SHOULD FOLLOW THE CHASSIS MANUFACTURER'S INSTRUCTIONS FOUND IN THE OWNER'S PACKET YOU RECEIVED WITH YOUR FOREST RIVER COACH.

SECTION 8

CARE and MAINTENANCE

FORMALDEHYDE FROM BUILDING MATERIALS

Certain building products such as particleboard, fiberboard, and hardwood plywood, are manufactured with an adhesive containing urea-formaldehyde. These products emit a small quantity of formaldehyde into the air.

Other products containing formaldehyde or urea-formaldehyde resins are certain carpets, draperies, upholstery, fabrics, deodorizers, cosmetics and permanent press fabrics. Formaldehyde is also a by-product of combustion and is produced by cigarettes and gas appliances.

The concentration of formaldehyde in the indoor air depends upon the quantity and emission rates of all emitting products in the structure compared to the volume of indoor air and the fresh air ventilation rate. As with other indoor pollutants, ventilation should reduce formaldehyde levels.

WARNING

FORMALDEHYDE LEVELS IN THE INDOOR AIR CAN CAUSE TEMPORARY EYE AND RESPIRATORY IRRITATION AND MAY AGGRAVATE RESPIRATORY CONDITIONS OR ALLERGIES.

WATERPUR™



To help you choose quality water treatment products, the Water Quality Association developed its' Gold Seal program. WQA tests water treatment equipment and awards the Gold Seal only to those systems that meet or exceed industry standards for performance, capacity and integrity in removing a variety of drinking water contaminants. **WQA Gold Seal** testing and validation is available for drinking water treatment units. It provides the following assurances:

1. **Performance Testing** - measures contaminant reduction capabilities over the life and capacity of the unit.
2. **Structural Integrity** - measures durability under pressurization beyond the usual demands of home water systems, simulating 10 years of normal use.
3. **Materials Safety** - confirms a product does not add anything harmful to the water being treated.
4. **Literature Review** - verifies clarity and accuracy of product literature sales and advertising copy, installation and maintenance instructions, and product labeling.

Gold Seal labeled products must meet the Water Quality Association's Code of Ethics standards. Only the Water Quality Association can award the Gold Seal, and only products meeting comprehensive industry standards can earn it.

'WARNING' INDICATES A HAZARDOUS SITUATION WHICH, IF NOT AVOIDED, COULD RESULT IN DEATH OR SERIOUS INJURY.

SECTION 8

CARE and MAINTENANCE



LOOK FOR THE **GOLD SEAL** AND BUY WITH CONFIDENCE.

FOR MORE INFORMATION, WRITE:
WATER QUALITY ASSOCIATION
4151 NAPERVILLE RD.
LISLE, IL. 60532-1088

(A NOT-FOR-PROFIT ORGANIZATION.) VISIT OUR WEBSITE
AT: **www.wqa.org**

OPERATING INSTRUCTIONS

MODEL CCI-10CLW12

The **WaterPur™** system filters all water going into your RV, not just drinking water, thereby protecting your complete plumbing system from contaminants, providing filtered cold **and** hot water, and providing filtered water to your bathroom. It also:

- removes over 99% of chlorine, taste and odor
- removes over 99% of turbidity
- removes over 99% of Giardia & Cryptosporidium
- does not channel, fluidize, or bypass like a granular activated carbon filter
- does not permit the passage of cultivated bacteria like a granular activated carbon filter
- does not contain silver nitrate or any other pesticide or harmful chemical
- is constructed from all NSF listed materials
- is rated for 10,000 gallons or one year
- has a flow rate of 2.5 gallons per minute

The **WaterPur™** cartridge is made of activated carbon particles fused into a uniform block, providing micron filtration. Service life is greatly extended by a 15 micron polypropylene prefiltration medium and a layer of 5 micron polypropylene melt blown intermediate filtration medium.

The **WaterPur™** Models

CCI10CLW12 & CCI-5CLW12 have been tested and awarded the **WQA Gold Seal** certifying these systems meet or exceed industry standards for performance, capacity and integrity under WQA S-200 for Household and Commercial Water Filters.

The replaceable cartridge, which is the heart of the **WaterPur™** system, has been tested to meet the material requirements of NSF Standards 42, 53 and 58. It has been tested to meet the performance requirements of NSF Standard 42 for Class 1 Chlorine reduction and Standard 53 for Class 1 Turbidity and Cyst reduction.

Winterize

To winterize your RV's water system, remove the **WaterPur™** cartridge from the housing and follow manufacturer's directions for dewinterizing, then replace the **WaterPur™** cartridge. The cartridge should be replaced every 12 months or 10,000 gallons, whichever comes first.

An easy way to remember to do this is to replace the cartridge when you dewinterize in the spring. Replace the **WaterPur™** cartridge only with a genuine **WaterPur™** cartridge available from your Forest River dealer.

SECTION 8

CARE and MAINTENANCE

Sanitize

Prior to using your RV's fresh water system with the **WaterPur™** CCI-10CLW12 installed, the entire system should be sanitized and rinsed. When sanitizing, make sure the **WaterPur™** filter cartridge is not in the filter housing.

- Place one ounce of household bleach (such as Clorox) in your RV's fresh water tank, for each ten gallons of capacity. (If your tank holds 30 gallons, put 3 ounces of bleach in the tank.) Fill your RV's fresh water tank with potable (drinkable) water.
- SLOWLY open the faucets in the RV and allow water to flow until you smell chlorine at each faucet, then close the faucet. DO NOT PERMIT THE CHLORINATED WATER TO SPLASH ONTO CLOTHES, WALLS, COUNTERS OR FLOORS. Allow the system to sit overnight.
- Drain the fresh water tank and fill with potable water. Run the faucets until the chlorine smell is gone. Repeat as necessary.
- Shut off the fresh water pump or disconnect from your city water supply. Open the kitchen faucets to remove pressure. Place a shallow pan beneath the **WaterPur™** filter.
- Remove the sump from the **WaterPur™** housing by turning counterclockwise being careful not to spill the water in the housing. Empty the water from the housing.
- Unwrap the **WaterPur™** cartridge and place it in the housing. (Either side up). Make certain that the 'O' ring is properly seated, and reattach the housing to the filter cap by turning clockwise. Tighten the housing firmly by hand. DO NOT overtighten.
- Close the kitchen faucets and either turn on your fresh water pump or your city water supply. Check for leaks at the filter housing. Tighten if necessary. Open the kitchen faucet and allow water to flow for ten minutes. Your **WaterPur™** system is now ready to deliver fresh tasting filtered water to all of the faucets in your RV!

Operational Note:

The **WaterPur™** cartridge is not to be autoclaved or steam sterilized. Use the **WaterPur™** cartridge with microbiologically safe water. Activated carbon filters are not designed to kill or remove bacteria or viruses. Actual results obtained will vary with various combinations of organic contaminants, changes in pH or other conditions encountered in actual use. All information presented is based on data believed to be reliable. It is offered for evaluation and verification, but is not to be considered a warranty of any kind. The contaminants removed by the **WaterPur™** cartridge are not necessarily in your water. Some jurisdictions tax, regulate, or restrict devices making health related or aesthetic claims. **WaterPur™** makes no claims in those jurisdictions.

WARRANTY

The **WaterPur™** system is warranted against defects in material and workmanship for a period of one year from date of purchase. Warranty does not cover damage due to abuse, neglect, improper installation, exposure to pressure, temperatures above or below stated operating parameters, or improper winterizing.

SECTION 8
CARE and MAINTENANCE

WARRANTY

The **WaterPur™** system is warranted against defects in material and workmanship for a period of one year from date of purchase. Warranty does not cover damage due to abuse, neglect, improper installation, exposure to pressure or temperature above or below stated operating parameters, or improper winterizing.

The Seller makes no other warranties of any kind, expressed or implied, concerning this product, including warranties of merchantability or fitness for a particular purpose, except that this product should be capable of performing as described in this manual.

Seller's obligation for this product's performance below specifications shall be limited solely to the replacement of product proven defective, at the Seller's sole discretion. Determination of suitability of product for uses contemplated by Buyer, shall be the sole responsibility of Buyer. Use of this product constitutes Buyer's acceptance of this limited liability.

DESCRIPTION:

The **WaterPur™** Model CCI-10CLW12 is a Household Class, Group 2, water filtration device designed for installation in recreational vehicles. It has a micron rating of 1 micron, a capacity of 10,000 gallons of chlorine removal at 2.5 gallons per minute. This capacity was determined under WQA Standard S-200 Test Conditions, and may vary with local water characteristics.

The cartridge consists of activated carbon particles fused into a uniform block with enhanced absorptive capacity and efficiency. The cartridge flows in a radial outside-to-inside direction providing increased dirt capacity and low pressure drop (8 psid @ 1 gpm service flow, maximum differential pressure of 100 psid and a collapse pressure of 200 psid).

Unlike granular activated carbon (GAC) filters, the extruded carbon will not channel or bypass, due to the extreme uniformity of its extruded activated carbon core. Service life is greatly extended by a layer of 15 micron polypropylene spun-bonded prefiltration medium and a second layer of 5 micron polypropylene melt blown filter medium.

Maximum cartridge operating pressure is 125 psid and maximum operating temperature is 125° F. Minimum operating temperature is 40° F. The housing and cartridge are constructed of 100% NSF listed materials.

END OF SECTION

NOTE:

SECTION 8 CARE and MAINTENANCE

FOREST RIVER'S CUSTOMER
'EMERGENCY ROADSIDE ASSISTANCE'
OWNER'S GUIDE

THIS INFORMATION AND
SERVICE IS PROVIDED BY:

Coach-Net®
900 N. LAKE HAVASU AVENUE
LAKE HAVASU CITY, AZ. 86403
1-877-801-0333

Coach-Net®
Technical & Roadside Assistance

WHEN YOU TAKE DELIVERY OF YOUR NEW FOREST RIVER INC. RECREATIONAL VEHICLE, YOU ARE PROVIDED WITH AN EMERGENCY ROADSIDE ASSISTANCE SERVICE - FREE OF CHARGE. WE'VE TEAMED UP WITH THE LARGEST RV EMERGENCY ROADSIDE ASSISTANCE COMPANY IN THE COUNTRY TO GIVE YOU IMMEDIATE ACCESS TO FAST, DEPENDABLE SERVICE WHEN AND WHERE YOU NEED IT. THIS IS A COMPREHENSIVE EMERGENCY ROADSIDE SERVICE THAT IS AVAILABLE TO YOU AROUND THE CLOCK.

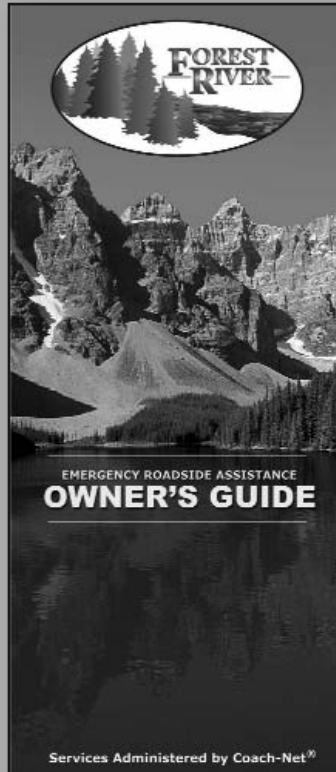

This Owner's Guide is provided to familiarize you with the benefits provided at no charge for your first year of ownership from the date of purchase.

For further details and instructions on how to access your Forest River Emergency Roadside Assistance and Product Support Plan benefits, please refer to your Benefit Guide or call **1-877-801-0333**.

You may continue your Forest River Roadside Assistance benefits in following years for a nominal charge.

Exclusive Benefits

EMERGENCY ROADSIDE ASSISTANCE

Simply show your Forest River Roadside Assistance card for payment of covered benefits with no out-of-pocket expense throughout the U.S. and Canada. (Includes one additional family car!) Free jump-starts, tire changes, fuel delivery and lock out service.

SERVICE ASSISTANCE

We offer over 6,800 qualified service agencies throughout North America. A simple phone call gives you expert direction on where the closest qualified service agency is located.

NATIONWIDE SERVICE APPOINTMENT ASSISTANCE

Here's a "no-hassle" way of arranging a service appointment when and where you travel. We make an appointment for you, give you directions and the time that fits your schedule. We're a toll-free call away!

MOBILE MECHANIC

We will dispatch a mechanic to the site of your mechanically disabled vehicle.* Labor charges and parts are not covered.

* Except where prohibited by warranty

\$2000 TRIP INTERRUPTION REIMBURSEMENT

Getting in an accident while traveling in your RV means you're stuck. We take care of you by paying for a car rental, meals and lodging. Even helping with a plane ticket home.

24-HOUR TOLL-FREE EMERGENCY MESSAGE SERVICE

Stay in touch with family and friends with no cost emergency message service.

CUSTOM TRIP ROUTING AND FULL COLOR MAPS

Make your next trip more enjoyable with these easy to follow maps, travel tips, places to see and much more.

For further details and instructions on how to access your Emergency Roadside Assistance and Product Support Plan benefits, please refer to your Benefit Guide or call **1-877-801-0333**.



When you take delivery of your new recreational vehicle it's just the beginning of our exclusive around the clock Emergency Roadside Assistance and Product Support Plan.

Our extensive support plan provides complete roadside assistance, emergency road service and special motor club benefits that follow you wherever your travels take you! (Just show your card and go!)

We've teamed up with the largest RV emergency roadside assistance company in the country to give you immediate access to fast, dependable service when and where you need it.

Add to that our toll-free warranty and service appointment assistance, plus a technical assistance hotline and you have the security of full-time support at your fingertips wherever the open road leads you. We provide full-time security you would never want to be without!



P.O. Box 30
423 North Main
Middlebury, IN 46540
WWW.COACHMENRV.COM



	<p>Learn More Scan this barcode using a QR Reader on your smart phone to learn more about Forest River.</p>	
<p>A Berkshire Hathaway company.</p>		

Forest River Inc.
Corporate Office
PO Box 3030
55740 County Road One
Elkhart, IN 46515-3030
Phone (574) 389-4600