

# DROPPING OFF AT MALEME?

SCENARIO ASL TAC1 Translated by Coastal Fortress Gaming Group



## Maleme Airport, Crete, May 21, 1941:

The previous day, at the beginning of operation *Merkur*, the *Luftlande-Sturmregiment* underwent heavy losses from the 22nd New Zealand Battalion while attempting to seize the Maleme airport. Having failed, it was forced to entrench near the objective for the night. On the evening of May 20, the German operation really did not seem a success. In spite of its failure, the *Luftlande-Sturmregiment* was the unit which seemed to have established the most promising bridgehead. It confirmed that judgement on May 21 while seizing hill 107 which overlooked the airfield in the south. Paratroops of Fallschirm-jäger-regiments 1 and 2 were en route to reinforce at 1430 hours and landed under the protection of a group of *Junker 87*.

### Board Placement:

#### Balance:

♣ Increase the presence of the Stukas by 1 turn.

⊙ Add a trench to the British OB

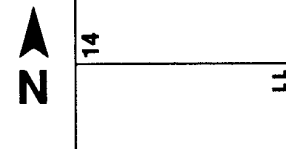

**Victory Conditions:** The German Paratroops win if, at the end of the scenario, the two airfield runways are clear of good order allied units within 2 hexes range; hexes of runway not included (i.e. the zone bounded by the hexes: 11AA10-14L8-M9-O8-O5-M4-L4-I3-G4-G7-E8-E10 inclusive)

⊙ New Zealand sets up first [185]	♣	1	2	3	4	5	6	7	8	END
♣ German moves first [286]										



### Elements of 22nd New Zealand Battalion and B squadron of 7th RTR [ELR:4]

Set up on board 14 {SAN:4} (see SSR 4):

4 <sup>2</sup> -5-8	9-1	8-1	8-0	3 6-14	2 4-12	1 2-7	2 51 [2-11]
12			2			3	3



9 40L -14
--------------

5 MPH/MPH: dr = MP CC: +1/-1	5 Foxhole 5 1S OV, OOA: +4 Other: +2	2 Trench OV, OOA: +4 Other: +2
---------------------------------------	--	---

### Elements of the 156th Light AA Battery Set up on board 14, adjacent to a runway hex:

2 40L (*)	2 2-8
--------------	----------



### Elements of the Luftlande-Sturm Regiment, Battalion I, 4th Company of 3rd Battalion [ELR:4]:

Set up on hill 11X5 {SAN: 3/4} (see SSR 5):

4 <sup>2</sup> -6-8	9-1	8-1	7-0	2 5-12	1 3-9	3 50 * [2-13]	3 5 1S OV, OOA: +4 Other: +2
8					2		3

### Elements of 4th and 123rd Companies of Fallschirm-jäger Regiment 2 [ELR:4]

Enter on turn 1 by parachuting (Air Drop E9.2, see especially E9.4, E9.7, F13.5 & F13.6)

5 <sup>2</sup> -4-8	9-2	8-1	8-0	1 3-9	1 3-9	1
14		2	2	2	6	

Scenario Design: Jean-Luc & Gaël Béchenec '91

#### SSR:

1. EC are dry with no wind at start. The direction of the wind should still be determined by a dr for Air Drop purposes.
2. All Woods are Brush, Orchard is Olive Grove and Grain is Vineyard. All Buildings are single story buildings. All board 14 Buildings are wooden. The buildings of board 11 preserve their characteristics.
3. An air call is available for the Germans in the form of 3 Stukas which enter according to rule E7.2. Their presence is limited to 2 consecutive turns.
4. The British Matilda cannot set up in a building.
5. The German SAN is 3 during the 2 first turns, then goes up to 4.

**Aftermath:** Benefitting from the support of the paratroops the men of *Luftlande-Sturmregiment* succeeded in taking control of one part of the airfield in spite of the resistance of the New Zealanders. A little later, a flood of mortar shells fell down on the runway of the airfield, and a *Junker 52* landed under the fire of the New Zealand machine-guns. It succeeded in discharging cases of ammunition the Germans would soon have missed, and loaded with wounded, took off without damage. The control of the airport was soon in hand, with the airborne troops and the British artillery shelling the runway which didn't stop the landing of the *Ju 52*, unloading 650 *Gebirgs-jäger* of *Gebirgs-jägers-regiment 100*. By the evening of May 21, the German situation in Crete was much better and the conquest of the island could start.

# BETWEEN THE HAMMER AND THE ANVIL

SCENARIO ASL TAC2 Translated by Coastal Fortress Gaming Group



**KHRISTISHCHE, January 26, 1942:**

Benefitting from the winter, Marshal Timoschenko decided to launch a significant offensive against German Army Group South. The Russians managed to create significant openings aimed at reaching the basin of Donetz from Izyum. Khristishche, held by the first battalion of the 196th infantry regiment, controlled the road to Slavyansk. From January 23, the Russians made many expensive attempts to take Khristishche but all were pushed back. It was not until dawn of the 25th that a patrol succeeded in penetrating the city.

**Board Placement:**

**Balance:**

- ★ Replace the 8-0 leader of the Russian reinforcements with one 8-1
- ✦ Add 2 LMG to the OB of company M

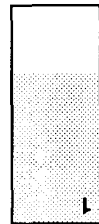

Only rows A through V are playable

**Victory Conditions:**

The winner is the side which, at the end of the scenario, entirely controls building K5.

✦ Germans sets up first	★	1	2	3	4	5	6	7	END
★ Russians moves first									

+

**Elements of 1st Battalion of the 196 Infantry Regiment [ELR:4]**  
set up between the lines D and H inclusive {SAN:0}:

 4-4-7 2	 2-3-7 2	 8-0 2	 3-8 2
----------------	----------------	--------------	--------------

M

**Reserves of Company M [ELR:4]**  
set up between the lines T and V inclusive:

 4 <sup>E</sup> -6-8 2	 4-4-7 6	 8-0 2	 8-0 2	 7-0 2	 7-10 2	 5-12 2
------------------------------	----------------	--------------	--------------	--------------	---------------	---------------

★

**Infiltrating Patrol of the Siberian Fusilliers Regiment, LVII Army [ELR:2]**  
set up within 3 hexes of L5 {SAN:0}:

 5-2-7 1	 4-4-7 1	 2-3-7 1	 8-0 2	 2-8 2
----------------	----------------	----------------	--------------	--------------

+

**Reinforcement Troops [ELR:2]**  
enter on turn one on the southern edge:

 5-2-7 1	 4-4-7 1	 8-0 2	 7-0 2	 4-10 2
----------------	----------------	--------------	--------------	---------------

Scenario Design: Emmanuel Regaudie '91

**SSR:**

1. EC are wet, with no wind at start.
2. The ground is frozen and foxholes are not allowed.
3. All the buildings are wooden and single story.
4. The Russian troops which are placed on the board at the beginning of the scenario cannot setup more than 2 squads or their equivalent in each building.

**Aftermath:** Disguised as Germans, five Russian soldiers succeeded in creating a sufficient breach so that the patrol could penetrate in the city. It took position at 0130 hrs in buildings and tried as much as possible to badger the Germans, already exhausted by three days of uninterrupted combat. However, the commander of Company M delegated on the spot his sections of command and reserve and succeeded in eliminating the pocket. The Russians had to retreat while a commissar and some men heroically defended their positions. The Russian command decided to benefit from the situation to bear down on the hastily reconstituted German line of defense but an artillery barrage of the group attached to the 1st battalion put an end to this offensive. It was only towards 0930 hrs that the last Russian defenders surrendered.

# UNEASY WITHDRAWAL

SCENARIO ASL TAC3 Translated by Coastal Fortress Gaming Group



## Mt. Owen-Stanley, New-Guinea, September 7, 1942:

The task force of General Horii resumed its advance after the battle known as "Chasm". The Japanese were then 80 km from their objective, Port Moresby. Blocking the road, the Australian troops were obliged to retreat, as they had done since August 16. But the Japanese soldiers were exhausted by more than one month of progression on the "Kokoda Trail" and combat at 3000 meters altitude. The ground which separated them from the southern coast was among the most hostile terrain. No white man had crossed the Kokoda Trail for twenty years! The diseases, the terrible conditions of functioning in the jungle, the lack of food and water transformed the courageous Japanese march into one of the worst martyrdoms of the Second World War. But the "Detachment of the South Seas" was still galvanized by its leaders in the pure tradition of Bushido, and General Horii remained determined to reach Moresby port. The Japanese soldiers, underfed and exhausted, maniacally continued to attack the Australians on the luxurious slopes descending to the south.

### Victory Conditions:

The Japanese must exit more VP by the southern edge than the Australian player does, with a minimum of 10.

Board Placement:

36	34
	2

Balance:

● The Japanese reinforcements enter on turn 4

● The minimum VPto exit is 8



● Australian set up first [ 176 ]	1	2	3	4	5	6	7	8	END
● Japanese moves first [ 284 ]									

**Elements of the battalions Tsukamoto, Horie and Kurada (Kusunose regiment) [ ELR:4 ]**  
are placed north of row H { SAN:5 }:

E 4 <sup>+</sup> 4-8	I 4 <sup>+</sup> 4-7	2-2-8	10-1	1-5	8-0	4-11	2-2	55 <sup>+</sup> 11-10 <sup>+</sup>
5	10			2			3	3

**Infiltrated elements of Horie Battalion (Lt Salamoto)**  
enter on turn 3 between rows Q and W inclusive, by the western edge:

E 4 <sup>+</sup> 4-8	9-0	2-2	11-11
4			

**Elements of companies A and B, 2/27th Battalion [ ELR:3 ]**  
set up between rows I and Q inclusive { SAN:3 }:

E 6 <sup>+</sup> 4-8	I 4 <sup>+</sup> 5-7	9-1	8-1	8-0	6-14	4-12	2-7	51 <sup>+</sup> 12-11
4	12		2		2	3	3	

Scenario Design: Robin Reeve & Théophile Monnier '91

### SSR:

1. EC are wet with no wind. PTO Terrain rules apply (G.1).
2. Place overlay 2 in 34T2-T1.
3. The streams are shallow (B20.4).
4. All the Australian units can be placed in foxholes and two squads (or equivalent) can set up HIP.
5. Prisoners do not count for VP (remember that No Quarter applies; G1.621).

**Aftermath:** Day after day, the Japanese continued attacking the Australian units, emerging like devils from every direction. On September 7th, near the village of Efogi, the Australian rear-guard was attacked. The combat was reduced to violent man-to-man fighting under a flood of mortar shells, and again the "Aussies" withdrew under the pressure of the Japanese. But, at the beginning of September, the American-Australian forces pushed back an amphibious attack on Milne Bay (of New Guinea). This danger aside, columns then constantly began reinforcing the Australian defense. By September 17, Horii was stopped for good, within 48 kilometers of Port Moresby. For his troops that meant the impossible: to revive the nightmare of Mt. Stanley in the opposite direction. One month later, the survivors still found themselves on the Kokoda Trail, devouring the corpses of those who had fallen just to survive. While fighting step by step, the Australian soldiers had shown that they were the first that could beat the Japanese, even in the jungle.

# “I REMEMBER”

## SCENARIO ASL TAC4 Translated by Coastal Fortress Gaming Group



### Ortona-Orsogna Road, The Abruzzi, Italy, December 14, 1943:

After the crossing of the Sangro and the Moro, the Eighth army was stopped by a last obstacle on the road towards the port of Ortona. A ravine blocked the way and from the heights the German artillery and armoured tanks broke all the attacks. From the 8th to the 13th, the three brigades of the 1st Canadian Division did not manage to advance. The keystone of the defense was a large masonry building, Casa Berardi, which overlooked the ravine and prohibited access to a significant crossroads to the north. The Royal 2nd Regiment, the last regiment not yet engaged, received the command to attack on the 14th at dawn. Already weakened by the ceaseless artillery battles of the previous days, the “Van Doos” gathered at their starting lines. Beyond, in the mud and under an iron flood, was the ravine from where the artillery was thundering.

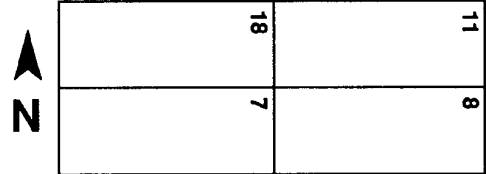

### Balance:

- ☉ Withdraw a MMG from the German OB
- ⚡ The German reinforcements enter on turn 4

**Victory Conditions:** The winner is the side which completely controls (A26.12) building 8W6 at the end of the game.

☙ German sets up first [212]	☉	1	2	3	☉	4	5	☙	6	7	8	9	10	END
☙ Canadian moves first [315]														

### Royal 22nd Regiment:

#### Company C (Captain Triquet) and squadron C of Ontario Regiment [ ELR:4]

enter turn 1 on the southern edge of board 7: {SAN:3}

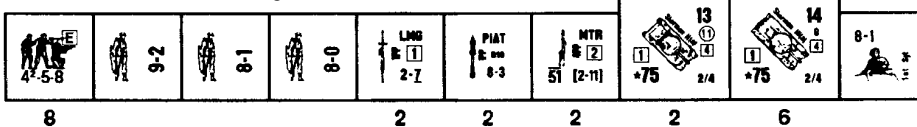

Company D (Captain Garceau) enters on turn 1 on the southern edge of board 8:

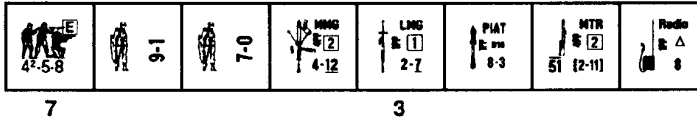

#### Company A (Captain Arnoldi)

enters on turn 6 on the southern edge of boards 7 or 8:

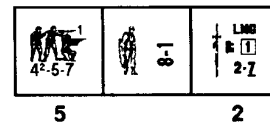

Company B (Major Trudeau) enters on turn 4 on the southern edge of board 7:

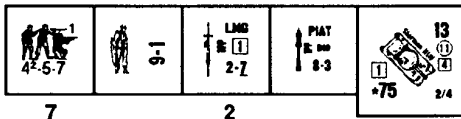

### Elements of PanzerGrenadier Rgt 200 and Armoured PanzerAbteilung 190 (PzrGren. Div. 90. ‘Sardinien’) [ ELR:4]

set up north of the ravine: {SAN:5}

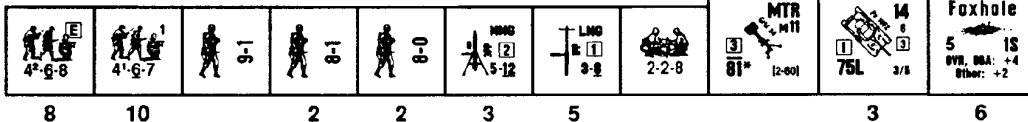

Reinforcements of Sturmgeschütz-Abteilung 242 enter on turn 5 on the northern edge of board 11 or 18:

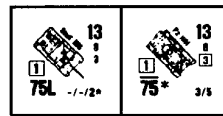

2

Scenario Design: Théophile Monnier '91

### SSR:

- EC are Wet with no wind. All Orchards are Olive Grove (F13.5), all Grain is Vineyard (F13.6), all Marshes and Woods are Brush. All multi-story buildings are 2-story and all Buildings are stone.
- The river represents the ravine. All of this terrain (islands included) is considered level -1 and mud rules (D8.23 and E3.6) apply. For the AFVs, only the hexes traversed in the ravine are taken into account for Bog rules. The terrain of the islands is preserved, but at level -1. The cliffs do not exist; they are simple crest lines of corresponding levels.
- No vehicle may use Schuerzen nor Gyrostabilisers. The Canadians have access to a 88mm OBAModule.

**Aftermath:** Under a flood of fire, company C managed to cross and, slowly, but with a savage will, approached Casa Berardi. With Shermans slowed down by mud, the Canadians destroyed the first tank with a PIAT. But the enemy was everywhere, and the losses were horrible. “ They are on the right, on the left and behind us, only one solution, right in front! “ howled Captain Triquet. Literally crazed, the men gathered themselves and attempted to destroy Casa Berardi with grenades. The attack force was at that point reduced to fifteen valid men and two tanks. The other companies were blocked by the machine-guns which still swept the ravine and their ammunition was becoming exhausted. But the cherished position was held all afternoon. In the evening, the valorous “Van Doos” of the Royal 22nd consolidated their defense; the two following days, they pushed back the furious counter-attacks of the paras of the 3rd regiment. The day of the 14th had seen a hero, Captain Triquet. First of all the Canadians in the countryside of Italy, he would be decorated with the Victoria Cross, the highest British distinction, bringing honor to Quebec and with his currency “I Remember”.

# THE MERVILLE BATTERY

SCENARIO ASL TAC5 Translated by Coastal Fortress Gaming Group



**Meadows of Merville, France, the night of June 5 to June 6, 1944:**

In preparation for the seaborne assault, the 6th Airborne Division received the mission of occupying and holding the zone located between the Dives and the Orne to the north of Caen. The destruction of the four large guns of the Merville Battery in the northeast of this zone is entrusted to the 9th Parachute Battalion. It was the most difficult task entrusted to a paratroop unit during the airdrop since the garrison included approximately 130 men defending the fortified positions with bunkers surrounded by barbed wire and minefields.

*Photo: Men of the 12th Parachute Battalion at tea time.*

**Board Placement:**

5	19	
		14

**Balance:**

☉ Add 1 MTR to the British OB

⊕ Replace a LMG with a HMG



**Victory Conditions:**

The British win as soon as they destroy the four 75 ARTguns placed in the bunkers.

⊕ German sets up first [127]	1	2	3	4	5	6	7	8	9	END
☉ British moves first [238-239](see SSR5)										

**Merville Battery Garrison (2/1716 Artillery Regiment) [ELR:2]**  
set up on board 19 between rows j and FF inclusive {SAN:3}:

4'-6-7	4-4-7	8-1	8-0	7-0	7-16	5-12	3-8	56*(2-13)
6	5	2			2	3		
MPH/RLP dr = MF CC: +1/-1	1+5+7	1+3+5	<b>Trench</b> OVR, OBA: +4 Other: +2	Minefield		75 m	2-2-8	(See SSR 6)
17	3		6	48		4	4	

factors

**Elements of the 9th Parachute Battalion [ELR:5]** enter on turn 1 by parachuting (Air Drop E.9){SAN:2}:

6'-4-8	9-2	8-1	8-0	5	2-7	51 (2-8)	8-3	30-1
14 - 17	2	2	2	2	3	2	6	

(See SSR 5)

*Scenario Design: Jean-Luc Béchennec '90*

**SSR:**

- EC are moderate with a Mild Breeze from the northwest.
- Night rules are used (E1). The basic NVR (E1.1) is 4 hexes with full moon and scattered clouds. (E1.12) The Germans are the defenders (E1.2) and the British the attackers. The British may not utilise Cloaking (E1.41 & (E9.11). The British are Stealthy and the German Normal.
- The German Sniper is placed on the board immediately after the landing of the British paratroopers (E9.4). The British Sniper is placed on the board at the end of the first of British play.
- DC allotted to the British are Bangalore Torpedoes intended exclusively to destroy barbed wire according to standard rules (B26.51, also see B25.45). These DC cannot be employed for other uses.
- The British player has the possibility of exchanging up to three squads for an equal number on the recon dr. (E1.23).
- The four guns and their crews, must be placed in Pillboxes, on board 19, between hexrows M and V inclusive. Only one gun can occupy a hexrow. The CA of Pillboxes must be directed towards the northwest. The guns are placed to be used against targets located at sea and cannot be used against a ground target. Pillboxes and the guns in them can set up HIP in the normal method; but the presence of a pillbox must be revealed if an enemy squad is within two hexes or less provided that the NVR is 2.

- Considering the number of fortifications set up HIP, it is advisable to set up the German fortifications on a second board 19 hidden from sight of the British player, or on a desert board. Management of what is seen or not by the adversary is thus facilitated. When the British player discovers a fortification, transfer it to the game board being played upon.

**Aftermath:**

After gathering his men, Lt. Col. Otway decided to divide his forces into seven groups. Two groups tackled the barbed wire to open the way for four groups, which were to destroy the guns. The last group was to make a diversionary attack at the principal entry of the German position. When the attack started, the two gliders which had to land in the heart of the position appeared. Unfortunately, not managing to locate the site, they landed 200 meters away. The combat intensified and, attacking on several fronts at the same time, the British managed to progress rather quickly in spite of the keen German defense. The garrison finally surrendered. 100 of the 130 defenders and 70 paratroopers were killed or wounded by the end of the battle.

# COUNTERATTACK AT VILLERS-BOCAGE

SCENARIO ASL TAC6 Translated by Coastal Fortress Gaming Group

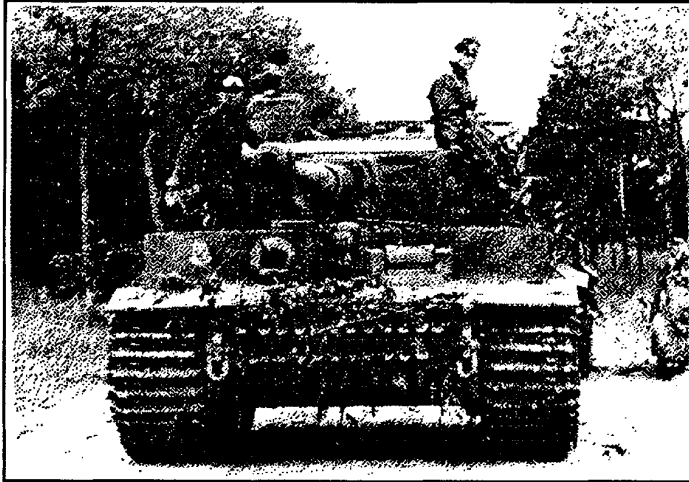

## VILLERS-BOCAGE, FRANCE, June 13, 1944:

Six days after the landing, in the sector reserved for the 2nd British Army, the 12th SS-Panzerdivision and 21st Rifle Brigade held the bastion of Caen too firmly to be taken frontally by the 1st British Corps. The decision was made to attack Caen from both sides, known as operation *Perch*. A little before 0900 hrs squadron B of the 4th County of London Yeomanry arrived, as a point element, at Villers-Bocage with a section of the motorized infantry 1st Rifle Brigade (called Green Jackets) and took up a position in the village. Squadron A continued to a position on the western slope of hill 213. The Germans decided to halt the encirclement. At 0915 hrs, a detachment of tanks from Schwere SS-Panzer-Abteilung 101 controlled by *SS-Obersturmführer* Michael Wittman and supported by Panzergrenadiers, attacked the British at Villers-Bocage.

Illustration: Tiger E of 2nd SS-Pz. Abt. 101 in the Villers-Bocage area, June 1944.

### BOARD PLACEMENT:

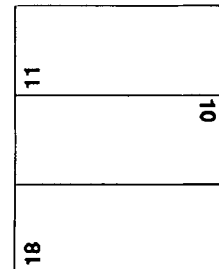

### BALANCE:

✚ Replace Armor Leader 9-1 with a 9-2

⊙ The Queens reinforcements enter on turn 3

**VICTORY CONDITIONS:** The Germans win if, at the end of the game, they control (A26.12) all the multi-hex buildings located on board 10 without losing (through any means, including immobilization and recall) more than 2 fully-tracked AFVs.

⊙ BRITISH sets up first [190]	✚	1	2	3	4	5	✚	6	7	8	9	END
✚ GERMAN moves first [195]												



### Detachment of A Company, 1st Rifle Brigade and B Company of County of London Yeomanry [ELR:4]

set up according to SSR 5 {SAN:4}:

4-5-8	8-1	8-0	4-12	2-7	5-1 [2-11]	8-3	?	13-14	18-2/4	18-2/4
8	2	2	3	3	2	2	12	3	3	3



Queens Detachment [ELR:4] enter on turn 4 along the western edge:

57L	11PP	16	2-2-8	4-5-7	9-1	8-0	2-7	5-1 [2-11]	8-3
2	2	2	2	7	2	2	2	2	2



### Detachment of Schwere SS-Panzer-Abteilung 101 [ELR:4]

Enter along the eastern side of boards 10 and 18 and the south of board 18 between hexes U and GG inclusive on turn 1 {SAN:3}:

5-4-8	9-2	8-1	8-0	7-0	5-12	3-8	12-4	16-17
15	2	2	2	2	2	4	2	2



12-17	9-1
3	2

13-14
2

### Detachment of the Panzer-Lehr Division

Enter along the eastern side of boards 10 and 18 and the south of board 18 between hexes U and GG inclusive on turn 6.

Scenario Design: Jean-Luc Béchenec '90

### SSR:

- EC are moderate with no wind at start.
- The hedges are bocage (B9.5).
- The British cannot use Bore Sighting and Kindling is prohibited.
- Two British squads or their equivalent can setup HIP (A12.3) along with any leader and SW stacking with them.
- The British set up on board 10 between lines Q and GG inclusive. The half-hexes shared with cards 11 and 18 are acceptable (in opposition to rule A2.3). The British vehicles cannot be placed in a building and must be placed ADJACENT to a road hex.

**AFTERMATH:** Benefitting from surprise, and after having destroyed a column of light vehicles on hill 213, Wittmann led the attack of 5 Tigers. Tanks and Grenadiers erupted into the village where a confused fight followed. The British tanks were destroyed one after the other. Overrun, the *Green Jackets* resisted as well as they could until the arrival of reinforcements of the *Queens*. But the very aggressive Germans were also reinforced by armored tanks of Panzer-Lehr. The fighting was house-to-house, and by the end of the day the pressure from the Germans forced the British to withdraw from Villers-Bocage. That evening, *Bomber Command* of the RAF crushed the village, which the Germans partially evacuated. The British attack to widen their bridgehead was stopped. They would make a new attempt two weeks later with operation *Epsom*.

# TRAP IN CARPIQUET

SCENARIO ASL TAC7 Translated by Coastal Fortress Gaming Group



## CARPIQUET, FRANCE, July 4, 1944:

Since the invasion, the English and Canadians had not advanced north of Caen. Their advance was slow and costly, but this pressure tied up many German troops and made it possible for the Americans to advance in the west. Before attacking Caen directly, the 1st British army corps decided to cut off the town a bit more and entrusted the 3rd Canadian DI with capturing the airfield immediately to the west of Caen: this was known as operation "Windsor". The Canadians were determined to drive out of the already strongly bombed village the well dug-in cut-off SS holding it.

### BOARD PLACEMENT:

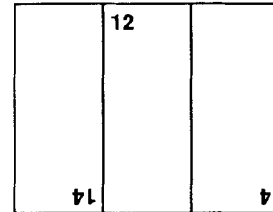

### BALANCE:

☉ Add a dm HMG to the Canadian OB

☙ 2 German squads may set up HIP

**VICTORY CONDITIONS:** Before German setup, the Canadian player must secretly note one of the two following VCs: control all buildings adjacent to the airfield runways, or control all multi-hex stone buildings (even if fully rubble) on board 12. The Canadian player wins immediately when fulfilling the chosen VC.

☙ GERMAN sets up first [173]	1	2	3	4	5	6	7	8	9	10	11	END
☉ CANADIAN moves first [275]												

**Elements of the 1st Battalion, 26th Regiment (12th Panzer Division SS "Hitlerjugend") [ELR:5]**  
Set up on boards 4 and 14 on/south of hexrow X and/or on board 12 on/south of hexrow J {SAN:4}:

6 <sup>2</sup> -5-8	2-2-8	5	6	8	7-16	5-12	3-8	7 <small>min 4</small>
11		2					3	8

75LL 3/8/2	AA 4	Trench DMR, DBA: +4 Other: +2	Minefield 11	AT Mine 12
2		4	12	12

**Elements of the North Shore, De la Chaudière, Royal Winnipeg Rifles regiments of the 10th armored regiment [ELR:4]** Enter on turn 1 along the northern edge {SAN:3}:

4 <sup>2</sup> -5-8	4 <sup>2</sup> -5-7	10-2	9-1	8-1	8-0	dm MTR R 3mm	dm HMG - R	LMG R 1 2-7	PIAT R 7 8-3
15	8				2	2	2	3	3

76LL 1/4	75 1/4	75 7/14 1/4
6		

Scenario Design: Jean Lasnier '91

### SSR:

- EC are moderate with Mild Breeze to the west.
- For every building hex on/between hexrow L and W on board 12, place a Rubble marker in that hex on a dr 2 (+1 drm for a stone building). Moreover, for any multi-story building hex that contains a Rubble marker, make a separate DR. On a white dr 3 place another Rubble marker in the adjacent hex indicated by the colored dr. A chain of results is possible (B24.121).
- All the road hexes are dirt roads (B3.1).
- All the hedges are bocage (B9.5).
- One German squad can setup HIP(A12.3), along with any SW/leader stacked with them.
- APMines may not be exchanged for ATMines.

**AFTERMATH:** Well supported by tanks, the infantry of *North Shore* and the *De la Chaudière* Regiment rushed forward to attack the ruined village held by a few SS squads. The SS, exhausted after a month of uninterrupted combat, fiercely defended themselves, but the clearing of the village had begun. To the south, the *Royal Winnipeg Rifles* attacked the airfield but progressed slowly. After the tanks vainly tried to clear a path through the rubble-filled streets, and some (including a Crocodile) exploded from mines, they emerged on the plain and rushed toward the airfield. There, waiting concealed in hangers were a Panther and 88 guns which dissuaded them from advancing farther. At the end of the day, the village was taken, but not the airfield. That would fall on July 8 and Caen on July 9.

# STROLL TO CHAMPFLEURS

SCENARIO ASL TAC8 Translated by Coastal Fortress Gaming Group

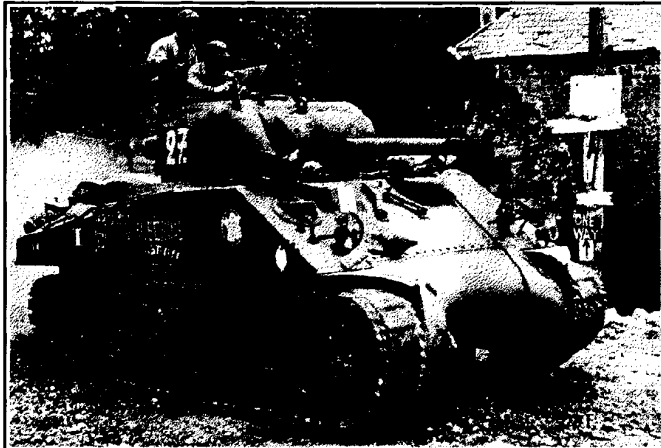

**VICTORY CONDITIONS:** The French win immediately if they score 25 CVP while having destroyed 3 enemy AFVs.

## CHAMPFLEUR, FRANCE, August 11, 1944:

The previous day, the 2nd DB left Le Mans for Alençon. They wanted to advance quickly to cut off the retreat of the 7th German Army. To the south of Alençon, on August 11, Tactical Group Dio was slowed down by elements of the 9th Panzer Division, which were cut off in Bourg-le-Roi. The artillery and airstrikes dislodged them quickly. Captain Noël continued to chase down stragglers. Lieutenant Krebs signalled him that three Panzers were moving toward Champfleur. Noël then ordered Krebs to head toward the village without waiting for him to join. It was 1630 hrs when Krebs saw the first houses.

BOARD PLACEMENT:

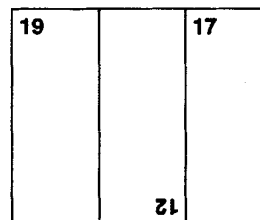

BALANCE:

⊙ Automatic air support of only one fighter-bomber, without bombs, on turn 5.

⊕ Add a PzIVJ to the reinforcements of turn 3.

⊕ GERMAN sets up first.	⊙ 1	2	3	⊕ 4	5	6	END
⊙ FRENCH moves first.							

**Elements of the 9th Panzer Division [ELR:3] {SAN:2}**  
set up on board 12, between hexrows V and M inclusive:

4'-6-7	2-2-8	8-0	7-0	3-8	M12 37L (M)(1)	28 T7 21PP
6				2		

set up on or to the north of hexrow Q on boards 19/12/17:

15 75LL 3/5/2	13 75L 3/5/2
2	

**Reinforcements**  
enter on turn 3, between 19A10 and 19G10 inclusive:

15 75LL 3/5/2
------------------

**Armoured tanks of the 12th Cuirassier, Tactical Group Dio, 2nd DB {SAN:0}:**

**Krebs platoon** enter on turn 1 by the southern side of board 19, and/or between 19GG10 and 19W10:

13 75 2/4/4	8-1
5	

**Noël platoon** enter on turn 4 by the southern side of boards 12/17:

13 75 2/4/4	9-1
5	

Scenario Design: François Bourcier '91

### SSR:

- EC are Dry, without wind at start. Vehicular Dust rules (F11.74) apply to unpaved roads, but with a DRM of +1 in place of +2.
- The German unarmored units must set up on a road hex. The gun must be towed (C10.1). At set up, only the gun crew may be a passenger of the truck. No MMC/Truck can be placed adjacent to another MMC/Truck. During turn 1, the German infantry is considered TI (A4.8) and the truck and its passengers cannot move nor make a Motion Attempt (D2.401). During turn 2, until the end of the German AFPh, the German infantry is considered Pinned (A7.8) and the truck and all its passengers cannot move (but may make a Motion Attempt). At set up, there can be no more than 2 AFVs per board.
- No German unit can set up HIP/concealed nor become concealed during the play.
- Hedges are bocage (B9.5).
- Bore Sighting is prohibited.
- The French are represented by American counters. Use M4 counters for the missing M4A1 counters. Shermans with armor leaders have gyrostabilisers, the other Shermans do not.

**AFTERMATH:** In the village, the German infantry, more occupied with supplying itself from the local inhabitants or finding a means of transport than organizing a defense, was surprised by the violent attack by Krebs, which lost two tanks, destroyed by hidden tanks. The crews, having survived, took some prisoners. Lieutenant Krebs, who's tank had been hit three times, eliminated two Panzers. Captain Noël, who joined the fight, also lost two Shermans in his advance on the village. The machine gun nests were destroyed and Champfleur was liberated, with the Germans withdrawing towards Alençon or the Perseigne forest. At 1800 hrs, General Leclerc set up his PC in the orchards of Champfleur.



# LEZONGAR STRONGHOLD

SCENARIO ASL TAC9 Translated by Coastal Fortress Gaming Group



**VICTORY CONDITIONS:** Americans/FFI win if they control both Pillboxes at the end of the scenario.

**AUDIERNE, FRANCE, September 20, 1944:**

After the surrender of the Brest fortress on September 18, 1944, General Hodge's army corps finished their push through Brittany by eliminating the last pockets of German resistance. To the west of Quimper, in Finistère, the Lezongar stronghold (*Stützpunkt*), close to the locality of Audierne, gathered the running garrison of the area. Since August 5, nearly 300 men, less than half in combat units, were encircled by the FFI under Lieutenant-Colonel Plouhinec. On the 26th they pushed back a large attempt at a German breakout after a hard fight, and wanted to finish them off. Task Force A, under the command of General Earnest, bolstered the encirclement on September 18. Plouhinec and Earnest coordinated their attack, with the partisans accompanying the tanks. There was no chance the Germans would surrender to the "Terroristen" and, even if facing the Americans, the will to fight in the autumn of '44 was still strong in the Atlantic pockets. However, prior to the attack, an intense period of propaganda by loudspeakers carried out by a *Psychological Warfare* team would sap the German morale.

**BALANCE:**

☉ Replace a British LMG with a MMG

☙ Restore the German ELR to 3

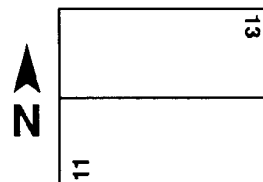

☙ GERMAN sets up first [117]	★ 1	2	3	4	5	6	7	8	END
★ ☉ AMERICAN/FFI moves first [130]									

**Elements of the 898th Infantry Regiment (343rd Infantry Division) reinforced by the garrisons of the ile de Sein and the radar base of Point du Raz [ELR:2]**  
set up on board 11 and in hexes numbered 3 on board 13 {SAN:4}:

4-6-7	4-4-7	4-3-6	9-1	8-0	7-0	5-12	5-12	3-8	50*(2-13)	12-4
3	7	6	2					3		

75L	2-2-8	2+5+7	1+3+5	<b>Trench</b> OVR:OBA: +4 OThr: *	<b>Foxhole</b> 5 OVR, OBA: +4 Thr: +2	15 MPh/ RUPh: dr = MF CC: +1/-1	BU	30
		6	7					30 factors

**Units of 159th Engineer Battalion [ELR:5]**  
set up on board 13 north of the river and in hexes numbered 5 {SAN:2}:

7-4-7	9-1	8-0	30-1	24-1
5		2		

**The FFI (8th Quimper Company and other Breton Companies) [ELR:5]**  
enter on turn 1 along the north edge of board 13:

3-3-7	9-1	8-0	7-0	2-7	51 [2-11]	8
10	2			3		

**Elements of the 6th Tank Destroyer Group**  
enter on turn 1 along the north edge of board 13:

15 76L
3

*Scenario Design: Théophile Monnier '91*

**SSR:**

- EC are moderate with a Mild Breeze blowing from the south.
- The Armored Cupola represents the turret of a Somua. Its characteristics are as follows: 47L (ROF 1, Black to hit). CMG 2FP, penalized by RST, AF:6. It is not regarded as a dug-in tank.
- The partisans OBA consists of 100 mm (5B/2R chits, accuracy dr \* 1) without possibility of Harassing Fire (C1.72) or SMOKE.
- The partisans cannot make multi-hex Fire Groups and may not deploy [EXC: A20.5]. Their SWare British and have no captured equipment penalties. For the Leaders, see A25.241. The FFI utilize the American SWas captured. The Americans utilize the English SWas captured.
- The Trench must be placed adjacent to the Pillbox 2+5+7, which is thus regarded as a bunker (B30.8). The Pillbox cannot set up HIPor concealed.

**AFTERMATH:** The attack benefitted from the support of the battery under Captain Espem, comprised of captured pieces (including one 105mm from 1913 crewed by Géorgiens deserters) which bombarded the position for several days with the support of the Americans. The FFI approached the German positions under heavy fire. Breaches in the barbed wire opened by American engineers and tanks allowed a closer attack. Soon, isolated and encircled, the Germans surrendered in small groups, despite an often stubborn resistance. The FFI were determined and could be considered as the assault victors. But, after two hours of combat, the Americans, not very grateful, took control of the German prisoners and interdicted access to the coastal batteries to the Briton partisans. In spite of this incident, the *Stützpunkt* fell. The Douamenez peninsula and all of Finistère were liberated and cleared of the enemy.

# GET UP KIDS!

## SCENARIO ASL TAC10 Translated by Coastal Fortress Gaming Group

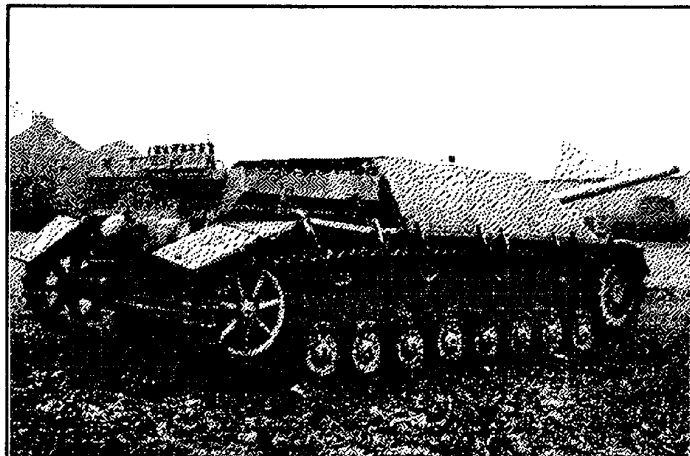

**EASTOF KRINKELT, BELGIUM, December 17,1944:** The German counter-offensive in the Ardennes had started the previous day at dawn. After quick successes due to surprise, the 1st SS-PanzerKorps met increasingly strong opposition from the Americans and soon, certain regiments were blocked. In order to open Rollbahn A with German troops and allow a fast progression, the 277th Volks-Grenadier-Division had to take over the villages of Rocherath and Krinkelt. It was soon obvious to the German command that it would not succeed alone, and KampfGruppe Müller of the 12th SS-Panzer-division was sent in reinforcement. After a difficult night advance through the woods to the east of Krinkelt, the German units got to their attack positions by the morning.

Illustration: JagdPanzer IV/70,photographed in France, end of 1944.

### BOARD

PLACEMENT

	17	4
N	33	5

### BALANCE:

♣ German need only exit 35 VP to win

☆ Add a Hero to the US OB of the 23rd IR

**VICTORY CONDITIONS:** The Germans win immediately after exiting 40 VP(A26.3) along the west edge of boards 17 and 33. Prisoners do not count toward total VP. The German Exit VPs must include at least 3 squads or their equivalents.

☆ Simultaneous set up (see SSR 3) [168]	1	2	3	4	5	6	7	8	9	10	11	END
♣ GERMAN moves first [189]												



**Elements of the 3rd Battalion,393rd Regiment,99 Infantry Division "Battle Babes"[ELR:4]**  
set up on boards 4 and 5 to the west of the hexrow T inclusive {SAN:3} (see SSR 3):

2 5 <sup>2</sup> -4-6	1 8-1	1 8-0	2 4-10	2 60*[3-45]	4 8-4	7 marks
8					2	6

**Elements of the 741st Tank Battalion**  
enter on turn 2 along the western edge of boards 17 and 33:

13 76L 2/4/4	15 75 2/4/4
	2



**Elements of the 3rd Battalion,23rd Infantry Regiment,2nd Infantry Division [ELR:4]**  
set up on boards 17 and 33

1 6 <sup>4</sup> -6-6	1 6 <sup>5</sup> -6-7	2 2-2-7	1 8-1	1 8-0	3 5-12	2 4-10	2 60*[3-45]	4 8-4	5 5 OVR. OOA: +4 Other: +2	1 81 <sup>1</sup> [3-75]
5	3					2		3	5	



**Elements of the 277th Volks-Grenadier-Division [ELR:3]**  
set up on board 4 or 5 east of the hexrow Pinclusive {SAN:2} (see SSR 2):

2 4-4-7	1 9-1	1 8-1	1 8-0	3 7-16	2 5-12	1 3-8	3 50*[2-19]	4 12-4	13 75L -1/-1*
12					2	3		2	2



**Elements of the 25th SS-Panzer-Grenadier Regiment "KampfGruppe Müller",12th SS Panzer Division "Hitler.Jugend" of the SS-PzJg-Abt. 12. [ELR:4]**  
set up on boards 4 or 5 east of hexrow Pinclusive (see SSR 2, SSR 4):

2 6 <sup>4</sup> -5-8	1 10-2	1 8-1	1 8-0	2 5-12	1 3-8	4 12-4	16 75L -1/-1	13 75L 3/16/2	11 75LL 1/-
7					3		2	2	3

Scenario Design: Jean-Luc Béchennec '91

### SSR:

1. EC are Ground Snow (E3.72) with Mild Breeze from the southeast. The roads are plowed.
2. The set up of the Americans and the Germans is simultaneous. Carefully place a screen between the two players. Before set up, a secret dr determines which board each German group sets up on. On a 1-3, the SS are set up on board 4 and the Volks-Grenadiers on board 5. On a 5-6, the SS set up on board 5 and the Volks-Grenadiers on board 4.
3. Two American squads of the 393rd Regiment or their equivalent can place HIP (A12.3) along with any Leader/SWstacked with them.
4. The Panzer IVJ are equipped with Schuerzen.

**AFTERMATH:** The 3rd Battalion of the 393rd Regiment of "Battle Babes", which was making its first engagement, undertook the initial attack. The Americans had to retreat, leaving behind several wounded they could not transport. After travelling a few kilometers, they met up with entrenched positions of the the 3rd Battalion of the 23rd Infantry Regiment. The "Battle Babes" had just finished getting into position when the German tanks appeared and attacked the American positions with their machine-guns. Uncle Sam's soldiers and a few Shermans of the 741st Tank Battalion knocked out several of the German tanks, but the pressure was too strong and the American positions were overrun. The survivors withdrew to Krinkelt as night fell. Sgt. V. Mc Garaty of the 393rd and Pfc. J.M. Lopez of the 23rd received the Medal of Honor for their bravery during these engagements.

# A DANCE WITH THE QUEEN

SCENARIO ASL TAC11 Translated by Coastal Fortress Gaming Group

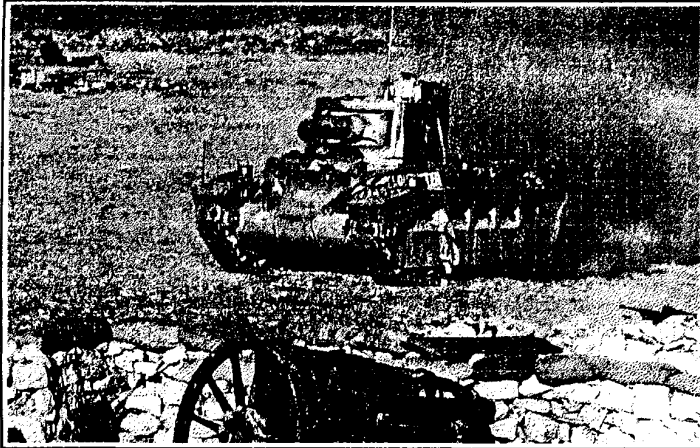

**VICTORY CONDITIONS:** The British win immediately upon controlling all of the trenches, provided they have not lost > 30 DVP.

**NIBEIWA CAMP, SOUTH OF SIDI BARANI, EGYPT, December 9, 1940:**  
In order to drive the Italians out of Cyrenaica, the British organized operation "Compass" to retake the town of Sidi Barani, lost two months earlier. Outnumbered, General O'Connor, head of the Desert Western Forces, wanted to circumvent the city to the south so as to disrupt its supplies. The shortest hook was entrusted to the 4th Indian division and to the 7th Royal Tank Regiment, equipped with 44 Matilda IIs. These units would have to destroy three fortified camps along the road, of which the most significant, Nibeiwa, was first. This camp, an oval of 2000m by 1800m behind a network of barbed wire, was occupied by more than 2000 Italians and Lybians. At 0700 hrs, surprising the camp, the British artillery opened the ball and the tanks of 7th RTR's shook for a small dance.

**BOARD PLACEMENT:**

27	26
	D2
D1	



**BALANCE:**

⊙ British OBAis 88mm

≡ Replace a M11/39 with a M13/40

≡ ITALIAN sets up first	⊙	1	2	3	4	5	6	7	8	9	END
⊙ BRITISH moves first [160]											



**Elements of "Gruppo Maletti" [ELR: 2]**

set up on/south of hexrow Lon board 27, in hexes numbered 4 {SAN: 4}:

3-4-6	9-2	8-0	7-0	2 4-10	1 2-5	2 45-[2-12]
15				2	3	3



2-2-7	24	20 MPA/R1Ph: Dr = MF CC: +1/-1	12 15 or 6m OBA: +3+ Other: +1+	8 OBA, OBA: +4 Other: +2	2 75*	2 M11 20L(4)	2 12 3 1 DZ7 +CMG -74	2 13 0 1 +BMG 4/-
4	24	20	12	8	2	2	2	2

factors



**Elements of 2nd Queen's Own Cameron Highlanders, 11th Indian Infantry Brigade (4th Indian Division) and armoured 7th Royal Regiment Tank. [ELR: 3]**

enter on turn 1 on/between 27A1 and 27J10 {SAN:2}:

4-2-7	9-1	8-1	8-0	4 4-10	2-2	4 1-12	2 40L -74	2 40L 2/4	2 40L -74
16		2		4	4	4	2		

Scenario Design: Robin Reeve & Théophile Monnier '92

**SSR:**

1. EC are dry. There is a mild breeze from the Northwest.
2. The British have a 80mm OBA with an offboard observer, secretly placed before Italian setup at level 1 on the western edge of board 27.
3. Place the following overlays: D1: 27X5-X4 and D2: 26I9-I8. Rule F.4 applies.
4. The 75\*s must be placed in trenches, the 20Ls must be placed in sangars. Bore-sighting is prohibited. There must be at least two trenches placed north of hexrow V exclusive.
5. The DVPOf Matilda is 6. APmines cannot be exchanged for ATmines.

**AFTERMATH:** Thirty-five minutes after the beginning of the attack, the British tanks penetrated the camp without infantry support. It was a wave of Matildas that then caused an indescribable disorder. The Italians reacted with all available weapons: machine-guns, high-explosive shells, 37mm guns, grenades, rifles. A cloud of projectiles surrounded each tank as they traversed the camp in all directions, moving and firing. Only the valorous 75mm gun crews kept their positions, immobilizing about half of the British tanks. But soon they were all crushed or buried alive. General Maletti was mowed down by a burst of machine-gun fire as he came out of his tent, light machine-gun in hand, and his son behind him was seriously wounded. After one hour of this attack, the entire camp surrendered to the coming infantry. The Matilda became "Queen of the Battlefield". In 6 months, a much more frightening king took the throne: the 88 of Rommel.

# COMMANDO SCHENKE

SCENARIO ASL TAC12 Translated by Coastal Fortress Gaming Group



**VICTORY CONDITIONS:** The Germans win at the end of the scenario if they control (A26.12) building X4.

## LIEPĀJA, LATVIA, June 28, 1941:

The evening of June 24, Infantry-Regiment 505 was established within 12km of Liepāja in Latvia. The following day, jointly with Kriegsmarine commandos, the 505th attempted to take the maritime fortress by surprise but, in spite of the energy of the assailants, the attack failed. Worse, benefitting from the disorganization of the German troops, the garrison of Liepāja, supported by armored tanks, counter-attacked, succeeding in releasing the fortress. They even managed to threaten the enemy artillery positions. On the 27th, after a difficult advance, the men of the 505th got a foothold in the southern part of the fortress. The following day, a bloody street battle was engaged against the particularly combative Russian defenders.

### BOARD PLACEMENT:

#### BALANCE:

♣ Add 1 turn

★ Remove 1 FT from the German OB



★ RUSSIAN sets up first	1	2	3	4	5	6	END
♣ GERMAN moves first [180]							

**Elements of Infantry-Regiment 505 (291st Infantry-Division) [ELR:4]**  
set up in woods and building hexes on/south of hexrow N {SAN:0}:

 4 <sup>1</sup> -6-7	 9-1	 8-1	 8-0	 7-12	 5-12	 3-2
10						2

**Elements of commando "Schenke" of the Kriegsmarine [ELR:5]**  
set up in woods and building hexes on/south of hexrow N:

 8 <sup>E</sup> -3-9	 10-2	 8-0	 24-1	 30-1
5			2	4

**Elements of the Liepāja garrison, VIIIth army [ELR:2]**  
set up on/north of hexrow P {SAN:0}:

 5-2-7	 4-4-7	 8-1	 8-0	 4-10	 2-8	 7 unknown
3	10				2	13

Scenario Design: Jean-Luc Béchenec '92

#### SSR:

1. EC are moderate, with no wind at start.
2. All buildings are single-story.
3. Building X4 is fortified (B23.9)

**AFTERMATH:** The defensive positions which the Russians had prepared in the fortress were discovered to be very difficult to destroy. The tactics of the Russians, mixing thorough fortification of buildings with the tenacity of the troops, foreshadowed the disaster of Stalingrad. It was necessary to call upon field howitzers and reserve attack troops to defeat the defenders. In spite of this, Liepāja held 3 days.

# SNOW AND BLOOD

**SCENARIO ASL TAC13** Translated by Coastal Fortress Gaming Group

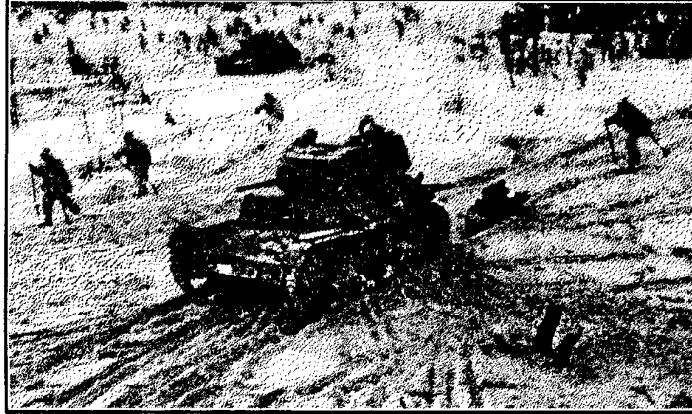

**VICTORY CONDITIONS:** The Russians win at the end of the scenario if they exit more VP through the northern edge of the board (A26.3) than the Spanish/Lettons, with a minimum of 4 VP being infantry.

## BOLSHOYE UTSCHNO, THE USSR, January 17, 1942:

To the south of Lake Ilmen, the 290th Infantry-Division was overrun by the violence of the Soviet winter offensive. On January 8th, 543 men of this division were encircled by the 71st Ski Battalion in the village of Vsad. The German command required the intervention of Azul division. The 206 men of the ski company thus undertook to cross Lake Ilmen. The temperature went down to -56°C. By January 14th, the cold had done its work and the company was reduced to 76 combatants. On January 17th, Lt. Otero de Arce led a reconnaissance to the southwest, accompanied by 36 Spaniards and 40 Lettons of the 81st Infantry-Division. After having crossed Maloye Utshno and Bolshoye Utshno, they encountered the enemy at Shiloy Tscherez just as they got settled in the town. The Russians did not hesitate to react.

**BOARD PLACEMENT:** 3

**BALANCE:**

★ Add one turn

♣ Add an ATR to the Spanish/Letton OB



♣ SPANISH/LETTONS set up first [104]	★ 1	2	3	4	5	6	7	8	END
★ RUSSIAN moves first [154]									

**Elements of a detached ski company, 250th Infantry-Division "Azul" and Letton volunteers of the 81 Infantry-Division [ELR:3]**  
set up on board 3 on/between hexrows V and Z {SAN:3}:

 4-6-8	 9-2	 8-1	 8-0	 5-12	 9-9	 1-12	 7 INFAN
8					2		6

**Elements of the 71st ski battalion [ELR:2]**  
enter on turn 1 along the southern edge of the board {SAN:2}:

 4-5-8	 9-1	 8-0	 7-0	 2-9	 1-12	 45L -/4	 45L -/4"
14				3	2	2	

Scenario Design: Jean-Luc Béchenec '92

### SSR:

- EC are deep snow (E3.73), with no wind at start.
- Building M2 and hills have no level 2. All buildings are wooden.
- The Spanish/Lettons are considered Russian for Heat of Battle (A15.1)
- Extreme Winter (E3.74) applies. All Spanish/Letton units and the Russians have skis (E4) and thus have Winter Camouflage (E3.712, E4.4). The Russian vehicles also have Winter Camouflage.
- The Russian vehicles have only half of their MP when they enter on turn 1.

**AFTERMATH:** Faced with the power of the Soviet attack, the Spaniards, pursued by many ski troops and six T26 tanks, were obliged to quickly withdraw. In Bolshoye Utshno, Lt. Otero de Arce, leading a small group, succeeded in holding the Russian units while the remainder of the company fled to the north, succeeding in rejoining the HQ at Pagost Ushin. The Lieutenant, flanked by a few exhausted survivors, managed to retreat under cover of darkness.

# BETWEEN THE HAMMER AND THE ANVIL II

SCENARIO ASL TAC 14 Translated by Coastal Fortress Gaming Group



**VICTORY CONDITIONS:** The Russians win if they completely control building K5 at the end of the scenario. The German player wins starting from turn 4 inclusive as soon as there are no more good order Russian MMC north of hexrow D at the end of a German turn.

**KHRISTISHCHE, January 26, 1942:**

Benefitting from the winter, Marshal Timoshenko decided to launch a significant offensive against the German Army Group South. The Russians managed to create significant openings aimed at reaching the Donetz basin from Izyum. Khristishche, held by the first battalion of the 196th infantry regiment, controlled the road to Slavyansk. From January 23rd, the Russians made many expensive attempts to take Khristishche but all were pushed back. It was only at dawn on the 25th that a patrol succeeded in penetrating the city.

*This scenario appeared in Tactiques #1 to illustrate the initial course. Here is the "professional" version with additional precise details concerning the units.*

**BALANCE:**

- ★ Replace the 8-0 leader of the Russian reinforcements with one 8-1
- ♣ Add 2 LMG to the OB of company M.

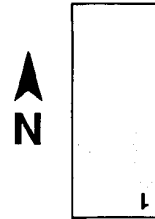

Only hexrows A through Pare playable

★ RUSSIAN sets up first [149]	★	1	2	3	4	5	6	7	END
♣ GERMAN moves first [163]									

**Elements of the 196th Infantry-Regiment (68th Infantry-Division) [ELR:3]**  
set up between hexrows D and H inclusive

 4'-6-7 6	 2-4-7 2	 8-0 2	 3-2 2
-----------------	----------------	--------------	--------------

**Reserves of Company M [ELR:3]**  
enter on turn 1 along the north edge (hexrow P)

 4'-6-8 3	 4'-6-7 6	 9-1 2	 8-0 2	 7-0 2	 5-12 2	 3-2 2
-----------------	-----------------	--------------	--------------	--------------	---------------	--------------

**Infiltrating patrol of the 351st Siberian Rifles division, LVIIth Army [ELR:2]**  
set up within 3 hexes of L5 {SAN:2}:

 5-2-7 4	 4-4-7 3	 2-3-7 3	 9-0 2	 2-2 2
----------------	----------------	----------------	--------------	--------------

**Reinforcing troops [ELR:2]**  
enter on turn 1 along the southern edge

 5-2-7 3	 4-4-7 12	 8-0 2	 7-0 2	 2-2 2
----------------	-----------------	--------------	--------------	--------------

*Scenario Design: Emmanuel Regaudie '92*

**SSR:**

1. EC are deep snow, with no wind at start. Extreme Winter applies.
2. Night rules (E1) apply. The NVR is 4 with Scattered Clouds and No Moon. Only the German units of the 1st battalion are considered the Scenario Defender and must apply all of the rules of E1.2 (but their ELR remains 3). The Russian patrol units can set up Concealed but are neither Defender nor Attacker. The Russian and German units who enter the board are both considered Scenario Attacker (E1.4). Remember that according to E1.62, the Majority Squad Type of the Germans are Lax (see also E1.63).
3. All the buildings are wooden and single story.
4. The Russian troops which are placed on the board at the beginning of the scenario cannot place more than 2 squads or their equivalent in each building.
5. All the Russian units are equipped with skis and have Winter Camouflage.

**AFTERMATH:** Disguised as Germans, five Russian soldiers succeeded in creating a sufficient breach so that the patrol could penetrate in the city. It took position at 0130 hrs in buildings and tried as much as possible to badger the Germans, already exhausted by three days of uninterrupted combat. However, the commander of Company M delegated on the spot his sections of command and reserve and succeeded in eliminating the pocket. The Russians had to retreat while a commissar and some men heroically defended their positions. The Russian command decided to benefit from the situation to bear down on the hastily reconstituted German line of defense but an artillery barrage of the group attached to the 1st battalion put an end to this offensive. It was only towards 0930 hrs that the last Russian defenders surrendered.

# THE VALLEY OF THUNDER

SCENARIO ASL TAC 15 Translated by Coastal Fortress Gaming Group



GROMOVAJA-BALKA, UKRAINE, February 28, 1942:

The Soviets spent the winter readying for a great counter-offensive in the Donetz basin where they ran hard against the Germans, who were determined to hold on to the ground they had acquired since the spring of 1941. For 10 days the volunteers of the Wallonia Legion had established their defensive positions in the village of Gromovaja-Balka. This unit, the "Burgundians", made up of french-speaking Belgian volunteers where one could find many 16 year old officers among the 14-18 year olds, had its training cut short before being sent to the east. Reduced to 350 men by the rigors of the Russian winter, it was supported by 81mm mortars and two 37mm antitank guns crewed by Croatian volunteers. Moreover, Colonel Tröger, on whom they depended, guaranteed the support of a company of panzers and a flotilla of stukas if needed and added "Just hold 20 minutes, then I will send panzers and stukas". The 1st Company defended the northeast of the village, the 2nd the north and the 3rd the west and southeast. On February 28th, at dawn, "les Russes arrivent!" Two regiments supported by twelve tanks progressed on the frozen stretch which extended to the north. The Burgundians were rushing toward their combat positions when the Russians were no more than 500m away.

(Illustration: Pak 35/36 on the cold steppe facing east during the winter of 41/42)

BOARD PLACEMENT:

BALANCE:

★ Add a T-34 M41 to the Russian OB

☛ Replace the radio with a field telephone in the German OB

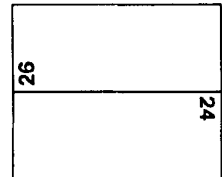

VICTORY CONDITIONS: The Soviets win at the end of the scenario if they control all but 2 of the buildings located in the valley of board 24 (24V3 included).

☛ GERMAN sets up first [185]	★	1	2	3	4	② 5	③ 6	⑥ 7	8	9	END
★ RUSSIAN moves first [216]											

**Elements of the 1st and 2nd companies of Infantry-Battalion 373 "Legion Wallonia" [ELR:4]**  
set up on board 24 and 26 in hexes numbered 9 (see SSR 4-7) {SAN:5}:

4 <sup>+</sup> 6-8	2-4-8	2-2-8	9-2	8-1	8-0	7-16	5-12	3-2	50 <sup>+</sup> [2-19]	1	1
12	3			3		2	3	2		12	

**Point elements of the 100th Jagër-Division**  
enter on turn 7 along the southern edge of board 24:

14	13	9-1	4 <sup>+</sup> 6-7	3-2
75 <sup>+</sup> 3/5	50 3/5			
2		4		

**Elements of LVIIth Army [ELR:2]**  
enter on turn 1 along the northern edge of board 26 (see SSR 2) {SAN:2}:

4-4-7	4-2-6	9-0	8-1	8-0	7-0	2 [4-10]	2-2	50 <sup>+</sup> [3-20]	1-12	17	17
24	12			2		2	4	3	3	76L 2/4	76L -/4
										4	

Scenario Design: Jean-Luc Béchenne '91

SSR:

- EC are ground snow (E3.72) with no wind at start. Steppe rules apply to board 26 (F13.2). The woods located on the half-hexes numbered 10 of board 24 are extended on to board 26 corresponding half-hexes where they become inherent terrain (A2.3, B.6). Hex 24V3 does not have a level 2. The ground is frozen and it is impossible to dig foxholes but the guns can be emplaced.
- The Russian infantry and AFVs have winter camouflage (E3.712).
- The radio represents an OBA module of 105mm with normal ammunition. The leader who has the radio can set up HIP.
- German 4-6-8 squads and 2-4-8 HS are considered SS. Their morale is underlined (A1.23) and their broken morale for both squads and HS is increased by 1 (9 for squads and 8 for HS).
- The Germans receive air support in the form of 3 Stukas with bombs. Starting on turn 5, the German player makes a dr at the beginning of his RPh. The stukas enter if the dr is the circled number of the current turn in the turn roster.
- The sangars represent snow-made fortifications sprinkled with water to turn the snow to ice. All of the rules for sangars (F8) apply to them. Moreover, these "sangars" behave as night fortifications (E1.16 except, of course, the last sentence). These "sangars" are considered concealment terrain - except for the purpose of gaining concealment during play.

**AFTERMATH:** The 37mm antitank guns and mortars did not manage to stop the Soviet attack. The AFVs counterattacked and one Walloon gun was put out of combat. The blood of the killed and wounded dyed the snow red along the lines of the defenders. In spite of the heavy losses inflicted on them by the heavy fire of the German machine-guns, the Russian infantrymen were soon in contact and grenades rained down on both sides. One of the groups of "Burgundians" in forward positions was threatened with encirclement. Under the shock, the defenders retreated from combat after suffering enormous losses, then launched a counterattack. The combat became increasingly confused and the tanks, some equipped with flamethrowers, advanced between the *isbas* (log houses), crushing in their path any soldiers who stood in their way. Towards 1100 hrs, with the situation desperate, three-quarters of the villages were occupied by the Soviets and survivors of the Legion launched counter-attack after counter-attack to try and dam the flood of attackers who further increased the pressure with the cry of Hurrah! victory! By the end of the afternoon, when all seemed lost, Stukas of the Luftwaffe emerged from the twilight and swooped down on the Soviet forces with the characteristic howl of their sirens. Thanks to this much hoped for support, the "Burgundians" launched a last counter-attack and managed to push back the attackers. Finally, a group of Panzers, assisted by a battalion of Wehrmacht, arrived to relieve what remained of the Wallonia Legion at the end of the day. 62 Walloons were killed and 110 were wounded.

# SUMMER CLEANING

## SCENARIO ASL TAC 16

Translated by Coastal Fortress Gaming Group



### Southwest of MALOYE SAMOSHIE, USSR, June 21, 1942:

The Soviet 2<sup>nd</sup> assault army, spearhead of the winter offensive north of Novgorod, bored into the German front between Godorok and Dubvizo on January 13, 1942. In spite of the initial success of the offensive, The Russians could not exploit this opening because the pillars of the breach were firmly held by the 126<sup>th</sup> and 215<sup>th</sup> Infantry Divisions. On March 19, The Germans attacked and closed the pocket around the II<sup>nd</sup> Army. The latter, isolated from any supplies, was trapped and couldn't break the lock. The Germans let the situation worsen until June 21, when the clearing of the pocket began. The 3<sup>rd</sup> battalion of 262<sup>nd</sup> Infantry Regiment had to attack Maloye Samoshie from the south. After having progressed 3km across wooded and marshy ground, the 3/262 was blocked by a hail of Russian machinegun fire.

### BOARD PLACEMENT:

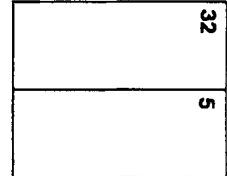

### BALANCE:

- Remove a 7-0 leader from the Soviet OB

- Add 6 "?" to the Soviet OB

**VICTORY CONDITIONS:** The Spaniards win if they have accumulated a minimum of 8 CVP and twice as many as the Russians at scenario end.

★ RUSSIAN sets up first [91]	1	2	3	4	5	6	7	8	END
◆ SPANIARD moves first [229]									

**Elements of 2<sup>nd</sup> assault army [ELR:2]**  
set up on board 32 in hexes numbered 2 and on board 5 in hexes numbered 6 {SAN:5}

5-2-7	4-4-7	9-1	8-0	7-0	4-10	2-6	1-12	50* [3-20]	? 7 morale
5	8					2			10

<b>Foxhole</b> 5 DVR: +4 Vibr: +2	<b>Trench</b> DVR, MIA: +4 DVR: +2	<b>Minefield</b> 24 factors
6	3	

**Elements of 3<sup>rd</sup> Battalion of 262<sup>nd</sup> Infantry Regiment (250<sup>th</sup> Infantry Division "Azul") [ELR:4]**  
set up on board 5 in hexes numbered 4 {SAN:3}

4-2-8	9-2	9-1	8-0	7-0	7-0	5-12	2-8	50* [2-15]
16		2				2	4	3

10 50L (15)	30 TIP 0PP	2-2-8
2	2	2

Scenario Design: Jean-Luc Béchenec '92

### SSR:

- EC are moderate, with no wind at start.
- Brush is Marsh, gullies are shallow streams.
- The Spaniards are considered Russian for Heat of Battle (A15.1).
- Only the Russian units can use the paths.
- 2 Russian squads may set up HIP along with any leader/SW stacked with them.
- The guns may start towed.

**AFTERMATH:** Antitank guns were brought up in the first line. With their support, the Spaniards again began to advance but the Soviet resistance was strong and losses accumulated in both camps. Captain Milans de Bosch, wounded by enemy fire, refused to be evacuated. The battalion continued to advance only to be blocked west of its objective, Maloye Samoshie. The 3/262 carried out the major penetration in this sector but lost 80 men. With its far forward position likely to be encircled, the 3/262 received orders the next day to withdraw and regroup.



# BREN GUNS

SCENARIO ASL TAC 17 Translated by Coastal Fortress Gaming Group



**VICTORY CONDITIONS:** The Germans win immediately by controlling buildings 4P6, 6J8 and 6O4, provided they accumulate more CVP(A26.2, see also SSR4) than the partisans.

## North of SAINT-MARCEL, France, June 18, 1944:

Since the Normandy landing, the St. Marcel Maquis had been very active. Regular night paradrops brought materiel and weapons, and elements of the 2<sup>nd</sup> SAS were parachuted in to assist the partisans with training. All this commotion did not fail to attract German attention, and on June 18<sup>th</sup>, 0430 hrs, Feldgendarmarie 790 was on patrol when it was ambushed by maquis, with all of its soldiers killed or captured. Malestroit garrison, made up of a battalion from 275<sup>th</sup> Infantry Division, was quickly alerted at 0630 hrs, and undertook a reconnaissance at 0900 hrs. The Germans were quickly repelled by heavy fire from the partisans and SAS, both well-equipped with Bren machineguns. The German attack was resumed at 1000 hrs with mortar support.

### BOARD PLACEMENT:

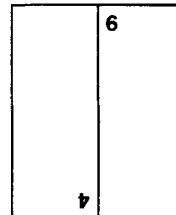

### BALANCE:

- ♣ Add a 4-4-7 and a LMG to the 70<sup>th</sup> battalion of Georgian Infantry
- ⊙ Use E7.21 to determine the number of FBs and their bomb loads.

⊙ PARTISAN sets up first [112]	* 1	2	3	* 4	* 5	6	7	8	END
♣ GERMAN moves first [168]									

**Elements of Le Garrec company and Carro battalion from Saint-Marcel maquis [ELR:5]**  
Set up on board 4 on/north of hexrow H and/or board 6 on/north of hexrow Z {SAN:4}:

3-3-7	1-1	7-0	2-2	1-3	7 mortar	5 5 MOR. LMA: +4 MOR: +2
10			4	2	12	5

**Elements of 2<sup>nd</sup> SAS [ELR:5]**  
Set up in the same area as the partisans:

2-4-1	1-1	2-2	1-3
3		2	

**Elements of 275<sup>th</sup> Infantry Division [ELR:3]**  
enter on turn 1 along the southern edge {SAN:2}:

4-4-7	4-4-7	1-1	1-1	7-0	3-3	1-3	50*(2-13)	1
6	3					3		

**Element of "Kreta" division [ELR:3]**  
Enter on turn 4 along the southern edge:

2-4-5	1-1	1-3
4		

**Elements of 708<sup>th</sup> battalion of Georgian infantry [ELR:3]**  
Enter on turn 5 along the southern edge

4-4-7	1-1	1-3	50*(2-13)
5			

Scenario Design: Jean-Luc Béchennec '92

### SSR:

1. EC are moderate, with no wind at start.
2. Partisans MMC may not form multi-location FG. Partisan units possessing 1 functioning LMG, and all leaders stacked with them are considered fanatic. British LMGs and PIATs are not considered captured by the partisans. 2 Allied squad-equivalents may set up HIP, along with any Leaders/SWs stacked with them [EXC: In the VC buildings]. SAS units are stealthy.
3. Until they lose concealment, the SAS units may be represented by equivalent Russian units (628/328 MMCs, leaders and LMGs and ATRs for PIATs) in order to preserve the fog of war and to keep their locations secret.
4. Starting from turn 5, Allied units (broken or not) may leave the playing area through the northern edge without adding to the German CVPs.
5. The German receives one module of 80mm battalion mortar OBA.
6. Starting from turn 5, the Allied side receives aerial support in the form of American FBs without bombs, with entry determined as per E7.2. Their number is determined by a dr divided by 3 (FRU).

**AFTERMATH:** The Bren guns, placed at the woods edge, held the German attack until their crews were dislodged by mortar shells. The wounded were immediately evacuated to the Sainte-Genevieve castle. Realizing the strength of the attack, the partisans decided to call London for aerial support. After a pause, the German attack resumed at 1400 hrs with the support of the paratroopers of the "Kreta" division, followed by the 708<sup>th</sup> battalion of Georgian infantry. Around 1530 hrs, Thunderbolts from the Normandy bridgehead arrived and strafed the German troops, halting their advance, but after their departure around 1630 hrs the attack was resumed again. By 1730 hrs, the partisans were obliged to withdraw toward the castle, and eventually abandon it. At 1900 hrs, it was briefly retaken by an SAS counter-attack but at 2000 hrs, the arrival of new German reinforcements finally forced the partisans into a total withdrawal; this was successfully completed by 2200 hrs after the Maquis destroyed most of their equipment.



# CHRISTMAS FIELDS

SCENARIO ASL TAC 19 Translated by Coastal Fortress Gaming Group

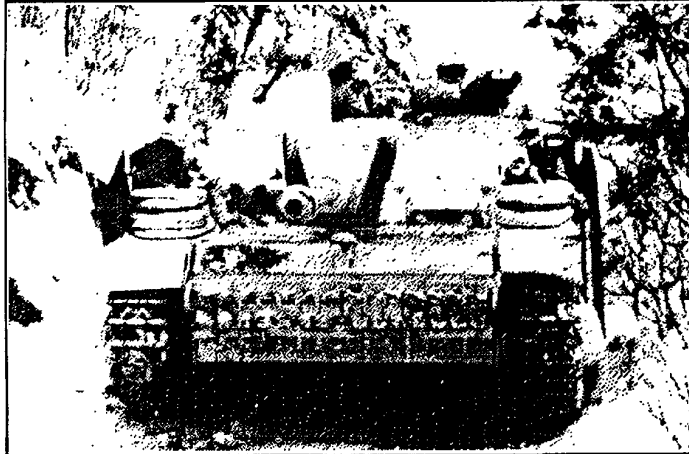

**VICTORY CONDITIONS:** The Germans win if they control all of the stone buildings of board 3 at the end of the scenario.

**CHAMPS, BELGIUM, December 25, 1944:**

In spite of the risks Bastogne represented behind 5<sup>th</sup> Panzer Army, their orders stood to push west. 47<sup>th</sup> Panzerkorps could only engage one Kampfgruppe to take the city. Two simultaneous attacks were envisaged. The first, carried out by 77<sup>th</sup> Panzergrenadier Regiment, of the 26<sup>th</sup> Volksgrenadier Division, had to take the village of Champs held by A Company of the 502<sup>nd</sup> Parachute Regiment. The second operation's goal, to open the front held 2km to the south by the 327<sup>th</sup> Glider Regiment, was assigned to Kampfgruppe Maucke, made up of 115<sup>th</sup> Panzergrenadier Regiment and the armored tanks of 115<sup>th</sup> Panzer Battalion. After an artillery barrage, the attack began.

**BALANCE:**

✦ Add a Pz IVH to the German reinforcements

☆ Add 8 "?" to the US OB



2	3	4
---	---	---

☆ AMERICAN sets up first [238]	1	2	3	4	✦ 5 ☆	6	7	8	9	END
✦ GERMAN moves first [228]										



**Elements of company A of the 502<sup>nd</sup> Parachute regiment [ELR:5]**  
set up on board 3 within 5 hexes of 3Q5 {SAN:4}:

7-4-7	8-1	8-0	8-10	4-10	50*[3-45]	8-4	7 marks
8			2	2	2	9	



**Elements of companies B and C of the 502<sup>nd</sup> Parachute regiment [ELR:5] and of B Coy. of 705<sup>th</sup> TD Battalion**  
enter on turn 5 along the east edge of board 4 on/between Hexrows Q and GG:

7-4-7	9-1	8-0	4-10	50*[3-45]	8-4	24 76L -1-14
9	2			2	2	2



**Elements of 77<sup>th</sup> Grenadier Regiment (26<sup>th</sup> Volksgrenadier Division) [ELR:3]**  
set up on board 2 {SAN:3}

4-6-7	1-6	8-1	8-0	7-10	5-12	3-2	12-4	8
15			2	2	4	2		

**Surviving elements of Battalion I/115 and of 115<sup>th</sup> Panzer Battalion (15<sup>th</sup> Panzergrenadier Division) [ELR:3]**  
enter on turn 5 along the southern edge on/between hexrows 2GG6 and 3GG5:



5-4-8	8-1	8-0	5-12	3-2	12-4	13 75L 3/8	13 75L -14-1*
6			2	2			

Scenario Design: Jean-Luc Béchenec '92

**SSR:**

1. EC are ground snow, with no wind at start.
2. The German infantry and AFVs have winter camouflage. The Panzers have Schuerzen.
3. The german receives one module of 80mm OBA.
4. Hills 534 and 522 do not exist. Treat them as level 0, with the other terrain located on those hills (woods, buildings) being retained.

**AFTERMATH:** Quickly, the men of 77<sup>th</sup> Panzergrenadier Regiment attacked. As the positions of A Company were threatened to be overrun, its commander, Captain Wallace A. Swanson, asked for help from HQ. Companies B and C were sent in reinforcement toward Champs. This detachment was confronted by elements of Kampfgruppe Maucke, which was also moving toward Champs. 5 tanks of 115<sup>th</sup> Panzer Battalion were soon destroyed by bazooka shots and soon two M18s of the 705<sup>th</sup> TD Battalion entered the fight. A Pz IV succeeded in spite of this and penetrated into Champs, where the Volksgrenadiers had already been driven out. The Panzer was soon knocked out and Champs was firmly reoccupied by the paratroops. A new attempt to take Bastogne had failed.

# SAD BAPTISM

SCENARIO ASL TAC 20 Translated by Coastal Fortress Gaming Group



## Gambshheim, North Alsace, January 6, 1945:

To give a new momentum to the battle for the Ardennes, Hitler ordered operation "Nordwind" to take Strasbourg. On December 31<sup>st</sup>, the German forces joined north of Alsace and simultaneously crossed the Rhine to the north of Strasbourg. On the 5<sup>th</sup> they seized Gambshheim, located to the south of the bridgehead, against a weak opposition. The American units in the sector had not fought before. Hurriedly equipped, the US 24<sup>th</sup> Infantry Regiment was assigned to counterattack toward the north of the city while a joint attack was carried out to the south. Starting from Weyersheim, the units encountered the first German advanced positions. Artillery fire caused many losses and the regiment entrenched for the night within one kilometer of the objective. The communication between the companies and the rear was defective, and the German fire continued. As the night went on, stiff with cold, the young Americans were terrified. Some soldiers cried or bled all night. By the morning of the 6<sup>th</sup>, morale was low as the advance began again without any preliminary reconnaissance.

### BOARD PLACEMENT:

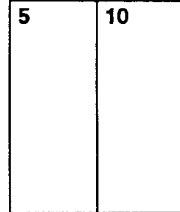

### BALANCE:

- ♣ German reinforcements enter on turn 4
- ☆ Add an 8-1 Armor Leader to the US AFVs

**VICTORY CONDITIONS:** The Americans win if they have 1.5 times as many Good Order squads (or their equivalent) as the Germans on board 10 on/south of hexrow Q at the end of the scenario.

☆ AMERICAN moves first [168]	☆ 1	2	☆ 3	4	5 <sup>♣</sup>	6	7	8	END
♣ GERMAN sets up first [98]									

**Elements of the 2<sup>nd</sup> Battalion of the 242<sup>nd</sup> Regiment, (Linden Task force) [ELR:4] {SAN:2}**  
F Company enter on turn 1 on/between 5I10 and 5M10:

2	8-1	8-0	7-0	2	2	2
12				2	2	2

E Company enter on turn 1 between on/between 5W10 and 5AA10:

2	8-1	8-0	7-0	2	2
12				2	2

**Tanks from A Coy, 781<sup>st</sup> Tank Battalion**  
enter on turn 3 along the western edge:

15 76L 2/4/4
2

**Observer of G Coy**  
enter on turn 3 along the western edge:

7-0	Radio
-----	-------

**Elements of the 553<sup>rd</sup> Volksgrenadier Division [ELR:2]**  
set up on board 10 and board 5 in hexes numbered 4 {SAN:4}:

2	5-1	5-0	8-0	2	2	3	2
14			2	2	3		

**Armoured support of Stürmgeschützkompanie 1553**  
enter on turn 5 along the east edge:

13 75L -1-11
2

Scenario Design: François Bourcier '92

### SSR:

1. EC are Ground Snow (E3.72) with no wind at start.
2. On board 5, no Good Order American unit (EXC: AFVs, leader possessing a radio) may move/advance from a hex of hexrow P to a hex of hexrow Q and from a hex of hexrow Q to a hex of hexrow P. No American unit can voluntary break on board 5.
3. The bazookas suffer from Ammunition Shortage. Only one Sherman has a gyrostabilizer (D11.1).
4. The gullies are non-frozen shallow streams (B20.42) but the bridges remain.
5. No German SW may Bore Sight a hex on board 5 numbered 9.
6. 4 squads German (or their equivalents) and the SMC/SW stacked with them can set up HIP.
7. The Americans receive one module of 80-mm Battalion Mortar OBA with Normal Ammunition

**AFTERMATH:** The two companies were quickly engaged by the machine guns hidden in the forest adjacent to Gambshheim. Only the intervention of tanks made it possible for the progression to continue, but the deadly fire intensified as the first houses were reached. In spite of mortar support, it proved impossible to gain a foothold in the city. Worse, German tanks appeared and bazooka ammunition was lightly distributed before the attack. The attack lost momentum, and when the radio operator lost contact with the artillery, the retreat was sounded. It quickly turned to a rout as the Germans infiltrated on the flanks. Heartbroken, the GIs had to leave their wounded comrades. The initial American attack to reduce the bridgehead ended in a complete disaster (the two companies lost 183 men, killed, wounded or captured) and south of the city the attack similarly failed. The following day, it would be the 3<sup>rd</sup> Algerian Infantry Division's chance.

# THE INFANTRY ATTACKS

SCENARIO ASL TAC21 Translated by Coastal Fortress Gaming Group



**VICTORY CONDITIONS:** The Germans win at the end of the scenario if they control hexes 5X3, X4, W5, V5, V6, S5, R4, R5, N5, N4 provided they have accumulated twice as many Casualty VP than the Belgians (see SSR4).

**CHABREHEZ, BELGIUM, May 10, 1940:**

For several hours, the German army surged along Luxembourg and southern Belgium. Within the framework of "Plan Yellow", a formidable armored mass was to cross the Ardennes to outflank the Allies in Belgium. One of the participating units was the 7th Panzerdivision, commanded by a still little known general: Erwin Rommel. He was in a bad mood, for in addition to the congestion and the obstacles, the division was delayed by the resistance of Belgian soldiers. They were the Ardennes Hunters, light infantry which had only the mission to delay the Germans before withdrawing to join the bulk of the Belgium army. In Montleban, a platoon stopped for two hours the point elements of 7th Panzer before Rommel himself organized a successful assault. More to the west, at the hamlet of Chabrehez, a significant crossroads, settled a company of Hunters. Using the broken terrain, a stream lined with an anti-tank ditch and a small bunker, the Belgians stopped the Germans for the afternoon. Rommel was furious and took the control of the attack.

**BOARD PLACEMENT:**

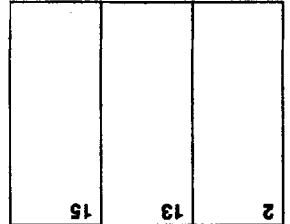

**BALANCE:**

- ⊕ Replace one MMG of Heilbronn company with a HMG
- ⊙ A squad and any Leader/SWstacked with it may set up HIP

⊙ BELGIAN sets up first	⊕ 1	⊕ 2	3	4	5	6	7	8	9	END
⊕ GERMAN moves first										

**3rd Company, 1st Battalion of the 3rd Regiment of of the Ardennes Hunters [ELR:3]**  
set up west of the stream {SAN:4}:

4-5-8	6-8	6-8	6-8	6-12	4-11	50* (4-14)	7 morale		1+5+7
12					3	3	8		

**Krädschutzen 7 and elements of 25th PanzerRegiment, 7th PanzerDivision [ELR:3] {San:3/4}:**

**Elements of the Heilbronn Company set up east of the stream:**

4-6-7	6-8	6-8	5-12	3-8	50* (2-13)
6			2		

**Hagen Company set up east of the stream. The guns cannot be emplaced:**

2-2-8	75+
2	2

**Kleinschmidt Company enter on turn 2 along the northern edge on/west of 13GG4:**

4-6-8	6-8	6-8	6-8	3-8	3-8	50* (2-13)
12			2		3	

**Platoon of light tanks enters on turn 1 along the east edge:**

15	1	18*
		4

Scenario Design: Philippe Naud '92

**SSR:**

1. EC is moderate, without wind at start. Kindling is prohibited.
2. All of the hills are entirely wooded (each hill hex is also a Wood hex of which base level is the hill level. The wood edge is the lower crestline). The hill hexes which contain buildings are treated like hex 219 (see A4.31) [EXC: If the unit enters the hex via a building hexside, it pays only the cost of the building]. The roads present on the hills are Wood-roads. Crags do not exist on board 15. Brush does not exist on the hills. Elevated roads are roads on level 0 and bridges 1Y8 and 13CC5 do not exist. The stream is deep (B20.43). The bottom of the stream is level -2 (i.e. to enter and exit is as a cliff elevation change). The Open Ground hexes adjacent to a stream hex are bog. Hexes 13FF4, 13GG4, 13A4, 13B3, 13C4, 13C3 are Marsh (B16).
3. Starting from Turn 7 to the end of game, a +1 twilight LV Hindrance (E3.1) apply at all ranges. A drm of -1 also applies for concealment gain drs.
4. Starting from Turn 7 to the end of game, Good Order Belgian units which exit along the western edge are not counted towards German Casualty VP.

5. The roadblock is placed on 13K6 and faces hexside K6/J6. The Pillbox sets up HIPas night fortification and must have a LOS to 13K6.
6. The German SAN rises to 4 as soon as a German MMC enters board 15.
7. The Belgian squads have Assault Fire capability.

**AFTERMATH:** The Heilbronn company and four light tanks opened with heavy fire. Captain Hagen's guns were a lot more deadly and destroyed two Belgian machine-guns. A Panzer crossed the ditch but did not push forward. All of this activity masked the infiltration from the north by Company Kleinschmidt which attacked the defenders from behind. At 1845 hours, commands came to withdraw under cover of the falling night. About fifty Hunters succeeded in escaping. Chabrehez was taken by the Germans but the 7th PanzerDivision would go no further that day. Rommel once again put into practice the theory from his book: "The Infantry Attacks".

# THEY FIRED ON ODESSA...

SCENARIO ASL TAC22 Translated by Coastal Fortress Gaming Group

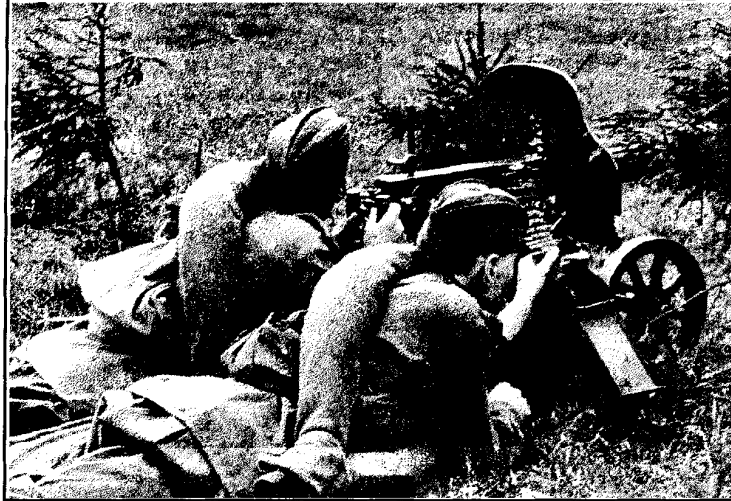

## GRIGORIEVKA, North-East of ODESSA, September 22 1941:

Since the end of July, the Germans had reached the Crimea and the outskirts of Odessa. The Russians fought tooth and nail, but, day after day, the perimeter of defense narrowed. Using their fleet on the Black Sea, the Soviet command decided to launch a counter-attack supported by a landing to the rear of the 9th Rumanian cavalry brigade. The 22nd of September, while the 426th Infantry Division attacked towards the east of Odessa, the 3rd Regiment of sailors of the Black Sea Fleet was beached close to Grigorievka at 0200. Arriving without mishap in the outskirts of the village, the company of Lieutenant Tcharoup launched the assault at 0800.

BOARD PLACEMENT:

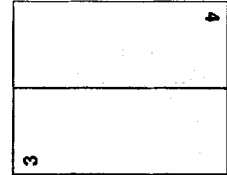

BALANCE:

★ Add a Game Turn

\* 1 Rumanian squad equivalent and all leader/SW stacked with them may set up HIPon board 3.

**VICTORY CONDITIONS:** The Russians win as soon as they control (A26.12) buildings 3N1, 3R3 and 3R5, and have destroyed or captured the three guns.

★ RUMANIAN sets up first	★	1	2	3	4	5	6	7	END
★ RUSSIAN moves first									



### Elements of the 15th division of Rumanian infantry [ELR:2]

set up on board 3, in hexes numbered 8 {SAN:3}:

 3-4-7	 1-3-7	 8-0	 7-0	 MMG 2 5-10 4-10	 LMG 1 5-7 2-7	 MTR 3 60-13-45	 ? 7 morale
8	2			2	2		6



**Battery of the 23rd field artillery regiment**  
set up within 3 hexes of 4V3 and within 3 hexes from each other (see SSR 4):

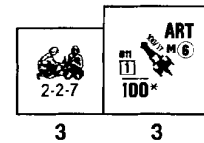







3

3



### Elements of the 3rd Regiment of the sailors of the Black Sea Fleet [ELR:2]

enter on turn 1 along the southern edge {SAN:2}:

 4-5-8	 2-4-8	 9-1	 8-0	 MMG 2 5-10 4-10	 LMG 1 5-7 2-7	 MTR 3 50-13-20
12				2		



Scenario Design: Laurent Forest '92

## SSR:

1. EC is Moist, with no wind at start.
2. No Russian leader can be exchanged for a commissar (A25.22).
3. There are no hills. All terrain on the hill hexes still exist, with their base level of 0.
4. The 100/17 guns cannot set up HIP nor concealed. They can't gain concealment during the game. They cannot be pushed (C10.3). Their crews were not used to close combat. Therefore, the first time a crew has LOS to a known enemy unit (free LOS checks are authorized) it must immediately roll a NMC with a -1 DRM. This Moral Check has the same consequences as if it were due to fire (Pinned, Broken, Casualty, MC...). This NMC is rolled only once per crew for the whole game.
5. The Russians receive an OBAModule of 80mm, with an on-board observer (C1.63) on level 2 on hex 3Q10 and normal ammunition. The only possible Fire Missions are Concentrated HE FFE.
6. Kindling (B25.11) and Bore Sighting (C6.4) are NA

7. Use Italian counters for the 100/17 guns. The Rumanians do not have HEAT ammunition and do not consider these guns as captured. Use 60mm American mortars with a B11 for the Rumanian mortars. The Rumanians do not consider these mortars as captured.

**AFTERMATH:** Lt. Tcharoup divided his company into two groups. The first, supported by artillery, drew Rumanian fire. The second circumented the village to attack the defenders from the rear. The latter were thus obliged to withdraw, closely followed by the Russians. During the pursuit-, Tcharoup's men destroyed a battery of long range artillery pointed at Odessa, on the tubes of which they engraved: "They fired on Odessa: It will never happen again". On September 23rd the 3rd RMMN joined up with the 426th Infantry Division. The successful counterattacks would not save Odessa, which would fall on October 16th, after 73 days of siege. The delay however provided an opportunity to evacuate a great number of wounded and civilians by sea.

# MIDNIGHT BATH AT TOBRUK

SCENARIO ASL TAC23 Translated by Coastal Fortress Gaming Group

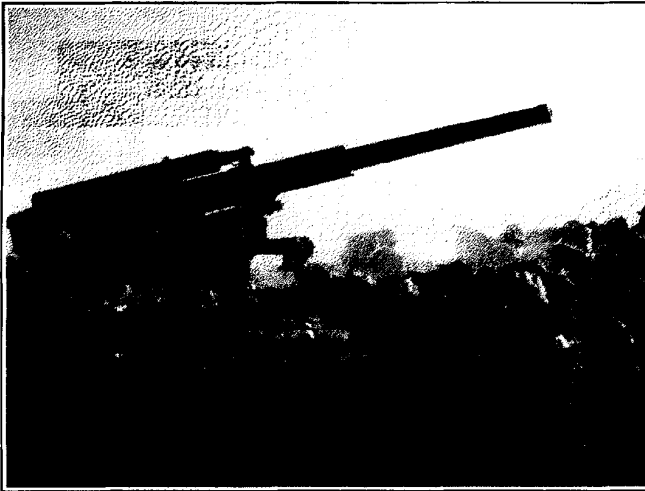

## Northern beach of TOBRUK, September 14, 1942:

British high command in Cairo had wanted for several months to carry out a sabotage operation on the harbor installations of Tobruk and Benghazi, then in the hands of the Italians. In September, an ambitious commando raid was finally prepared. A first group, Force B, made up of 83 soldiers of Special (Boat) Service guided by men from Long Range Desert Group would penetrate the perimeter of Tobruk while being disguised as prisoners being escorted by the Germans. Another group, Force X, composed of SAS and led by Lieutenant-Colonel Stirling, founder of the LRDG, would attack by surprise at Benghazi in order to damage the port and the gasoline stocks. Finally, Force A, the largest group, would be landed north of Tobruk to move towards the city and carry out sabotage on the port. The whole operation rested on surprise and the certainty that the city defenses were held by inefficient Italian troops. As scheduled, on the night of September 14<sup>th</sup>, 91 planes bombarded Tobruk, releasing 70 tons of bombs as a diversion for the raid. Quickly thereafter, towards 0300 hours, Royal Marines of Force A loaded in barges and set out for the beaches.

### BOARD PLACEMENT:

#### BALANCE:

III Add an 81mm mortar and crew to the Italian OB



26	[REDACTED]		
	Ef3		
	H1	Ef2 H3	H5
8	X4	X1	X5

**VICTORY CONDITIONS:** The British win as soon as they exit 20 VP (each DC units as 1 VP, prisoners do not count) along the south edge of board 30 on/between I10 and Y10.

© The British need only to exit 16 VP

III ITALIAN sets up first	1	2	3	4	5	6	7	8	END
© BRITISH moves first									

Elements of the "San Marco" Division of marines [ELR:2]  
set up on board 30 {SAN:3}



4 <sup>-</sup> 4-7	9-2	8-0	3 6-12	2 4-10	1 2-5	2 45° [2-13]
16	2		2		4	2
105	47	20L (4)	81* [3-102]	2-2-7		
	2	2		6		

<b>Sangar</b> 15 of Gun QA: +3 Other: +1*	<b>Trench</b> OUR, QA: +4 Other: +2	1+3+5
6	12	4

First wave of the 11<sup>th</sup> Royal Battalion Marines [ELR:5]  
set up 8 hexes from the north edge of the ocean overlay {SAN:0/2}:



6 <sup>-</sup> 4-8	4 <sup>-</sup> 5-8	9-2	8-0	2-7	1-12	30-1	+2 4 39PP+ AAMG -/-/8*
3	3					2	4

Second wave of the 11<sup>th</sup> Royal Battalion Marines [ELR:5]  
set up 4 hexes from the north edge of the ocean overlay:

6 <sup>-</sup> 4-8	4 <sup>-</sup> 5-8	9-1	8-1	8-0	2-7	1-12	3mm	30-1	+2 4 39PP+ AAMG -/-/8*
3	9				3	3	3	3	8

Scenario Design: Jean-Paul Gonçalves and Jean-Luc Béchenne '92

### SSR:

- EC is moderate with a Mild Breeze which blows from the south. Night rules are used. The NVR is 4 hexes and there is no cloud cover.
- Place the following overlays on Board 26: Be4 with 465-471 on EE9-FF8, Be5 with 565-571 on S9-T8, Be6 with 652-652 on G9-H8, Ef3 in L10-L9, OC3 with 3130-3143 on 463-469, OC2 with 2117-2130 on 563-569 and OC1 with 1143-4456 on 663-669. Place the following overlays on board 30: H1 on I2-J2, H3 on R2-R3, H5 in Z2-AA2, X1 in P8 (the cliffs and the hill do not exist, the TEM is +3), X4 in F9, X5 in V8, Ef2 in N7-N8.
- Board 30 undergoes Pre-game bombardment.
- The Italian guns must set up in Sangars.
- The British Sniper is placed on the board at the end of the turn where 1 British MMC sets foot on the beach, and the SAN raises to 2. Before that the SAN is 0 and is not increased by night rules. The landing barges are neither armed nor armored.
- The beach has Moderate Slope (G13.22).

**AFTERMATH:** Under cover of the naval guns of the destroyers HMS Sikh and HMS Zulu, the commandos reached the beach but encountered a stiff and unforeseen resistance. In fact, the town was controlled by the Italian San Marco Division, marines troops considered as some of the best troops of the Duce. The Royal Marines advanced with difficulty against these combative Italians whose machine-guns swept the beach. Moreover, the destroyers were soon fired upon by coastal guns and had to retreat. On the ground, a few commando squads managed to emerge from the beach but soon were forced to surrender, small group after small group. At dawn, HMS Zulu attempted to come back to support the assault but was sunk by Axis planes intervening from Crete and North Africa. The ambitious operation ended in failure, with the loss of 280 sailors and 300 Royal Marines wounded, killed or captured.

# HELL'S CORNER

SCENARIO ASL TAC24 Translated by Coastal Fortress Gaming Group

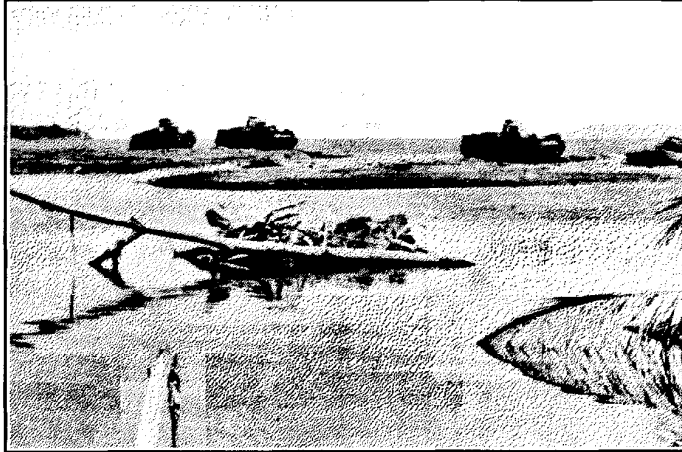

GUADALCANAL, SOLOMON ISLANDS, October 23, 1942:

Firmly reinforced by the arrival of the Tokyo Express and determined to take Henderson Field, once again the Japanese command assembled a general offensive with the 2nd division at the end of October. To the west of the vast airport defense perimeter, a force led by major-general Sumiyoshi with significant artillery concentrated at the mouth of the Matanikau river whose eastern bank was held by the 1st Marine Regiment. Starting October 20, the Japanese tested the American defenses with a succession of attacks led by Chi-ha tanks. At 1800 hours of the 23rd, Sumiyoshi's artillery began a prolonged bombardment of the American perimeter and the coastal road to the rear before the assault began.

**BALANCE:**

● Add a 50mm MTR to the Japanese OB

☆ Add 6 "?" to the US OB

4	S7 S5	37
34	7	

**VICTORY CONDITIONS:** The Japanese win at game end if they have 34 VP/Good Order infantry east of the River. Of these 34 VPs, a minimum of 10 must consist of mobile vehicles (D.7).

☆ USMC sets up first	1	2	3	4	5	6	7	8	END
● JAPANESE move first			☆						

**Elements of the 3rd Battalion, 1st Marine Regiment [ELR:5]**

set up in the hinterland hexes to the east of the river {SAN:3}:

☆

4 <sup>+</sup> 5-8	5 <sup>+</sup> 5-8	2-4-8	9-1	8-1	8-0	8-12	4-10	60 [3-45]	8	7 morale
8	3					2				12

**TD of the 1st Navy SW Battalion**  
enter on turn 3 or later along the eastern edge of board 37:

37LL

AT M12	Trench	Foxhole	MPH/R1Ph
2	2	3	5

19  
75

**Elements of the 4th infantry regiment [ELR:3]**

set up on board 34 {SAN:2/4}:

●

4 <sup>+</sup> 4-7	2-3-7	2-2-8	10-1	9-0	8-0	8-14	4-11	2-8	50 [1-16]	30-1	7 morale
19	2				2			4	5	2	12

**1st independent company of tanks**  
set up on board 34:

57

14	9-2	9-1
2		

9

Scenario Design: Sylvain Ferreira '92

**SSR:**

- EC is moist, with Mild Breeze which blows from the North-West. PTO rules are in effect with Light Jungle. The river is Fordable (B21.122). The Current is slow (B21.121).
- Place Overlays following: 4 on board 34 and S5 on 7X5-X4. S7 on 7BB5-BB6. S5 and S7 base levels are level 0. All the whole wood hexes on board 7 are Palm Trees.
- Board 7 and 37 undergo a Pre-Game Bombardment, resolved secretly by the US player. See C1.82 for HIPunits.
- The islands on board 7 do not exist (they are water hexes instead). All river water hexes adjacent to non-water hexes are Level 0 sand hexes instead. The rules of section F7 are in effect for these hexes as well as for S5 overlay.
- 1 US squads or equivalent may set up HIP along with all leaders/SWs stacked with them.
- The Japanese SAN increases to 4 as soon as 3 Japanese squads (or equivalent) are on board 37.
- The US player receives an OBA module of 105mm (HE only) with a Pre-registered hex (Barrage (E12) is possible). The Pre-registered hex cannot be located on board 34, and the only possible alignment (C12.31) for the Barrages is N-S.

**AFTERMATH:** The bombardment hardly over, a column of 9 Japanese tanks tried crossing the sand banks, followed by the bulk of the infantry. Returning powerful fire, the Marines also lead a series of artillery barrages in front of their positions. The American's 37 AT guns managed to destroy eight tanks. The last one reached the bank and crossed the network of barbed wire but a Marine rose up from his foxhole and immobilized it with a grenade in the tracks. A halftrack armed with a 75mm intervened to destroy it. Under heavy fire and with no support, the Japanese infantry was slaughtered trying to cross the river. The assault was soon halted with considerable casualties estimated at 600 Japanese dead and only 25 Marines killed. After a succession of attacks that were repulsed by the Marines throughout the night, the river's mouth gained the nickname: "Hell's Corner".



# NELLA NEBBIA - IN THE FOG

SCENARIO ASL TAC25 Translated by Coastal Fortress Gaming Group

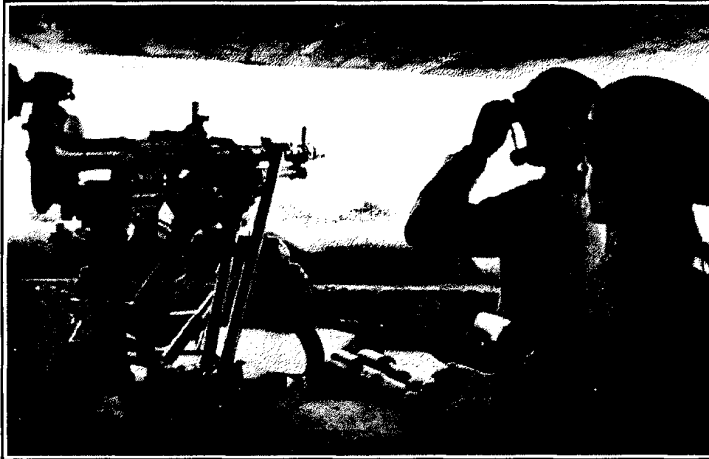

**VICTORY CONDITIONS:** The Italians win as soon as they control 6 hexes of level 3 on hill 714.

**MOUNT LUNGO, ITALY, December 8, 1943:**

Integrated into the US 5<sup>th</sup> Army soon after the armistice, General Dapino's first Italian Motorized Group took part in the assault to break the "Winter Line". This line of defense, in fact a first fortified belt in front of the "Gustav Line", prohibited access to the Liri Valley and the road to Rome. At the beginning of December, after having conquered the heights south of the valley entrance, the 5<sup>th</sup> Army devoted all of its efforts to the northern heights, in particular the two mountains at the entrance of the valley: Mt. Rotondo and Mt. Lungo. Both on these heights and down the valley, the German soldiers were solidly entrenched, with pillboxes covered with logs and stones, while the slopes were covered with barbed wire and minefields. It was "nella nebbia", in a very dense fog, that the Italians began moving towards the mountain after a preparatory bombardment.

**BOARD PLACEMENT:**

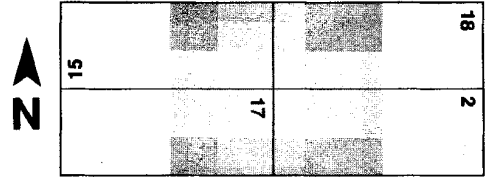

Playable area on board 17 hexrows A through Q inclusive. Playable area on boards 2,15, and 18, is hexrows Q through GG inclusive.

**BALANCE:**

Remove one LMG from the German OB

Replace a 4-6-7 with a 4-6-8 in the German OB

GERMAN sets up first	1	2	3	4	5	6	7	8	9	END
ITALIAN moves first										

**Elements of 3<sup>rd</sup> Battalion, 15<sup>th</sup> Panzergrenadier Regiment, 29<sup>th</sup> Panzergrenadier Division [ELR:4]**  
set up within 5 hexes of 15A6 {SAN:3}:

4	8	1-6	1-8	8-0	7-0	3	2	1	3	1
<b>Trench</b> OVR, OBA: +4 Other: +2		<b>Foxhole</b> 5 OVR, OBA: +4 Other: +2	<b>MPh/RtPh</b> dr = MF CC: +1/-1	<b>1+5+7</b>	<b>1+3+5</b>	<b>Minefield</b> 11		<b>24 factors</b>		

**Elements of the 1<sup>st</sup> Battalion, 61<sup>st</sup> Infantry Regiment (1<sup>st</sup> Italian motorized Group) [ELR:2]**  
set up on board 2 on/east of hexrow DD {SAN:2}:

1	1-8	8-0	7-0	3	2	1	2
<b>Elements of the 51<sup>st</sup> Bersaglieri Battalion (1<sup>st</sup> Italian motorized Group)</b> enter on turn 1 on/between E1 and 17I1:		1	1-6	8-0	1	1	1

Scenario Design: Jean-Luc Béchennec '92

**SSR:**

- EC is moist, with no wind or gusts during the game. Fog fills level 0 (Fog: E3.31), the Fog DRM is +2. Starting on turn 6, in each Italian Rally Phase, the Italian player makes a dr. If the dr is the circled number on the turn roster, the Fog DRM is reduced by 1. When the Fog DRM reaches 0, the fog ceases to exist.
- All the buildings are stone. Building 15R8 does not have a 2nd level. Orchards are Olive Grove (F13.5).
- The Germans receive a 80mm battalion MTR OBA module.
- Starting on turn 4, the Italians receive an OBA105mm module, directed by an off-board observer located on level 4, on board 18, hexrow Q. This placement is secretly recorded before the German set up. This module has all the characteristics of American OBA (US OBADraw Pile, Plentiful Ammo, HE and SMOKE).
- Board 15 undergoes a Pre-Game Bombardment.

**AFTERMATH:** Despite the protection of the fog, the Italians were caught in the crossfire of the German heavy machine-guns as soon as they reached the rocky bald slopes of Mt. Lungo. To support their attack, the entire artillery of US 2<sup>nd</sup> Corps intervened, crushing the entire mountain under the shells. First repulsed by heavy casualties, the Italians of 67<sup>th</sup> Regiment attacked again while the 51<sup>st</sup> Battalion Bersaglieri tried to outflank the mountain from the south. But it was no use; the Germans were strongly entrenched and would not give up. By midday it was obvious that the mountain would not be taken and the attack was halted. As retribution for this failure, and to prevent any German counterattack, American howitzers continued a rain of fire on the defenders positions all afternoon.

# ORANGE AT WALAWBUM

SCENARIO ASL TAC26 Translated by Coastal Fortress Gaming Group



WALAWBUM, NORTH BURMA, March 6 1944:

For their first mission in the Burmese jungle, Merrill's Marauders had to out-flank the 18th Japanese Division to prevent it from escaping the attack of Stilwell's two Chinese divisions in the Hukawng Valley. After a 10 day march in the hills, the Marauders placed several roadblocks on the road to the south and came immediately under attack by determined Japanese forces. In position on the heights since the 3rd of March, Orange Combat Team used its heavy weapons to interdict the route through the village of Walawbum. American observers hidden in the trees directed mortar fire which bracketed any Japanese trucks attempting to move southwards. Several Japanese assaults were repulsed with few losses, despite a continual bombardment by enemy infantry guns. At the end of the day on the 6th of March, one last massive Japanese attack was attempted.

BOARD PLACEMENT:

BALANCE:



37	2
36	1 G4 G5

☆ Add one 6-6-7 squad

● Add one turn

VICTORY CONDITIONS: The Japanese win if they control hex 37oX7 and 4 Level 2 hexes of Hill 526 (Board 36) at the end of any game turn.

☆ AMERICAN setups first	1	2	3	4	5	6	7	END
● JAPANESE moves first								

★ Elements of Orange Combat Team, 5307th Composite Unit "Galahad"[ELR: 5]  
setup east of all stream hexes {SAN: 4}:

	10					2	2	5

81* (3-75)	5 1S (BVR, OBA: +4 other: +2)
2-2-7	10 ?

● Elements of the 56th Infantry Regiment, 18th Infantry Division "Chrysanthemum"[ELR: 4]  
setup on/west of hexrow P{SAN: 4}:

	6	10	2			2			4	3

75*	2-2-8

Scenario Design: Théophile Monnier '92

SSR:

1. EC are Moist, with no wind at start. PTOTerrain rules and Light Jungle are in effect.
2. The streams are shallow. Kindling is NA.
3. Place the following overlays: 1 on 36D2-D1, 2 on 37DD8-DD9, G4 on 36P6-O7, G5 on 36R5-S5. The paths on overlays G4 and G5 exist.
4. American units are Stealthy. Although their ELR is 5, their morale is not underlined. All American units may setup in Foxholes of the appropriate capacity in allowed terrain.

AFTERMATH: Two Japanese companies emerged from the edge of the jungle to mount an attack. Behind them, mortars and several 75mm guns shelled American positions. In the shelter of their foxholes, the Marauders held their fire until the first Japanese soldiers were less than 100 meters away. With difficulty, the Japanese soldiers crossed the river under a deluge of fire. The American mortars and every automatic weapon which could be brought to bear easily broke the enemy charge. Two heavy machineguns, which had an excellent field of fire overlooking the river, created carnage. A few Japanese groups reached the first foxholes but were quickly wiped out. Another Japanese attack with the aim of dislodging the Marauders from the route of retreat had failed with heavy losses. After three days of combat, Orange CT recorded 400 Japanese dead in front of their lines. The 18th Division nevertheless succeeded in escaping over a prepared secret trail to the west.

# LAST OF THEIR STRENGTH

SCENARIO ASL TAC27 Translated by Coastal Fortress Gaming Group



**VICTORY CONDITIONS:** The Japanese win if they control more hut hexes on board 38 than the Americans at the end of the scenario.

## MYITKYINA, NORTH BURMA, May 21 1944:

Myitkyina, the main objective in the campaign for the Ledo road, was reached on the 17<sup>th</sup> of May. After an exhausting two week march through the jungle, the Marauders and attached Chinese units had captured the airstrip to the west of the town by surprise. Despite this first success, subsequent attempts to take the town failed as Myitkyina's garrison was much larger than foreseen. 3000 Japanese under the command of General Mizukami had dug in in the town. The siege soon transformed into trench warfare in deplorable conditions: monsoon rains, malaria, dysentery. The Marauders, sick and exhausted by a campaign of almost six months, had received no reinforcements. Nevertheless, General Stilwell demanded the impossible again from his only American unit. On the 21<sup>st</sup> of May, the remnants of the 3<sup>rd</sup> Battalion of Galahad attempted to tighten the encirclement by attacking the village of Charpate to the north.

### BOARD PLACEMENT:

### BALANCE:

- Reinforcements enter on turn 1 but may not Double Time

- ☆ Ignore SSR3

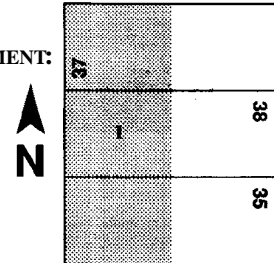

Only hexrows A to P inclusive (board 37) and R to GG inclusive (boards 35 and 38) are playable.

● JAPANESE sets up first	1	2	3	4	5	6	7	END
☆ AMERICAN moves first								

●

**Elements of the Myitkyina Garrison (1st Battalion of the 148<sup>th</sup> Infantry Regiment) [ELR: 4]**  
setup within 3 hexes of 38oY5 {SAN: 4}:

1 4'-4-7	9-0	LMG R: 1 BT: 2-5	MTR R: 2 50' {1-16}	?
5		10		

7 morale

☆

**Reinforcements enter on turn 2 on 35R5:**

1 4'-4-7	2-2-8	10-0	8-0	MMG R: 2	LMG R: 2 BT: 2-5	MTR R: 3 50'
8						

☆

**Elements of 3<sup>rd</sup> Battalion, Galahad ("Merrill's Marauder's") [ELR: 2]**  
setup on board 37 {SAN: 3}:

6'-6-7	10-2	9-1	8-0	MMG R: 2 4-10	MTR R: 3 50' {3-45}
10					

Scenario Design: Théophile Monnier '92

### SSR:

- EC is Mud, with no wind at start. PTO Terrain rules and Light Jungle are in effect. The weather is Overcast(E3.5), Gusty(E3.4) and Mud(E3.6). It is raining. AW ind Change DR 3 does not stop the rain: instead, its intensity is reduced to (or stays) normal. Place overlay 1 on 38T2-T1.
- No American unit may double time. In the CCPh, the Americans are always considered CX, including for Ambush dr purposes, but are not marked with a CX counter. A unit which is already CX (i.e. marked with a CX counter) is not penalized again in the CCPh.
- At the start of every American RPh, the 10-2 leader, if he is Good Order, must undergo a TC. If he fails, he becomes broken (No other consequences of failing a MC apply - casualty, replacement, etc.) [EXC: LLTC, DM]. The leader can immediately attempt to rally. This TC can reoccur several times throughout the course of the scenario.

**AFTERMATH:** The objective of the 3<sup>rd</sup> Battalion was to reach a second airstrip, north of the town. They first tried to seize Charpate, a small group of huts held by the Japanese. As soon as combat began, it was obvious the Marauders were too weak to accomplish their mission. Sick with fever and malnutrition, several men simply fell asleep in the middle of the battle. Colonel McGee, leading his battalion into combat, was also near the end of his strength. He fainted 3 times before being evacuated to a first aid post, where he continued to direct the attack, lying on a stretcher. Taking advantage of their numerical superiority, the Marauders succeeded in dislodging the Japanese from the village but were counter-attacked that same evening, and had to withdraw to their start line. A long agony of three months was just beginning for the Marauders.

# THERE ONCE WAS A LITTLE COLUMN...

**SCENARIO ASL TAC28** Translated by Coastal Fortress Gaming Group



**VICTORY CONDITIONS:** The Germans win if they control 4 buildings on board 12 between hexrows Land W at scenario end.

**MARVIE, BELGIUM, December 28, 1944:**

In the Bastogne sector as elsewhere, the Ardennes offensive was now marking time. Fierce American resistance and German tactical errors were allowing the 101st Airborne to arrive just in time. The 327th Glider Regiment had orders to take charge of the southern section of the perimeter defense of the town. At dawn on the 20th of December, the 2nd Battalion relieved the weakened and exhausted 35th Engineer Battalion who were defending the village of Marvie. A platoon of light tanks from Team O'Hara of the 10th Armored Division reinforced the glider troops. As well, two Shermans were posted on the heights to the north.

**BOARD PLACEMENT:**

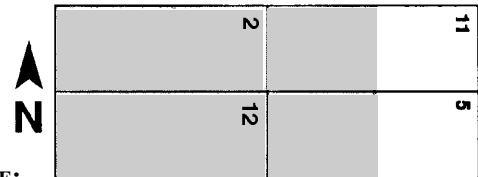

**BALANCE:**

♣ Add one Game Turn

☆ Add an 8-1 armor leader to the elements of C Company

*On boards 5 and 11, only hexrows R-GG are playable*

☆ AMERICAN sets up first	1	2	3	4	5	6	7	END
♣ GERMAN moves first								

**Elements of the 2nd Battalion, 327th Glider Regiment [ELR: 5]**  
setup on board 12 (see SSR2) {SAN: 3}:

7 <sup>3</sup> -4-7	1-1	1-1	8-16	2-10	3-45	9-4	<b>Foxhole</b> 5 OVR. OSA: +4 Other: +2
10	2				3	2	

**Platoon of D Company, 3rd Tank Battalion, Team O'Hara**  
setup on board 12 east of hexrow Q, with a LOS to board 5 (see SSR3):

17  
37LL 2/4/2

5

**Elements of C Company, 21st Tank Battalion, Team O'Hara**  
setup HIP in concealment terrain on board 2:

15  
75 2/4/4

2

**Elements of 2nd Battalion of 130th Panzer Regiment, of 902nd Panzergrenadier Regiment and of 243rd Sturmgeschutz Brigade (Panzer Lehr Division) [ELR:3]**  
setup on/east of hexrow Y on boards 5 and 11 {SAN: 2}:

5 <sup>2</sup> -4-8	1-1	1-1	1-1	3-8	3-8	12-4
9	2				3	

13 75L 3/8/2	13 75L -/-/2+	16 ISPP AAMG -/-/3	8-1
4		6	

*Scenario Design: Philippe Naud '92*

**SSR:**

- EC are Ground snow, with no wind at start. The Gullies/Bridges on board 5 do not exist. Consider the corresponding hexes as the other terrain present.
- All American infantry units in Concealment Terrain may setup Concealed. One US squad (or equivalent) and any Leader/SWstacked with it may setup using HIP.
- As soon as an M5A1 is Destroyed/Immobilized/Shocked, the American player must take a TC based on the morale of a vehicle crew, with a +1 modifier for each M5A1 Destroyed/Immobilized/Shocked after the first (i.e. 2 M5A1: +1, 3 M5A1: +2, ...). If the TC is failed, the surviving M5A1s are Recalled by the north edge of board 2. This TC is made for every M5A1 Destroyed/Immobilized/Shocked.

**AFTERMATH:** At 1125, the M5s and the village began taking fire from armored vehicles in the woods to the east. After having lost one machine, the commander of the light tanks asked for and received permission to withdraw. The German column continued its advance on the village, but without having spotted the Shermans... Two Panzer IVs, an SPW and the only StuG were quickly destroyed. One German tank preferred to withdraw while the last was "bazookaed". By 1300, all the other halftracks were knocked out and their occupants killed or captured in Marvie. A column from Panzer Lehr had just been annihilated.

# KAKAZU RIDGE

SCENARIO ASL TAC29 Translated by Coastal Fortress Gaming Group



OKINAWA, 9 April 1945:

Kakazu Ridge comprised the extreme west of General Ushijima's defense line in the southern part of Okinawa. For Colonel May, the commander of the 383rd US Infantry Regiment, it was an objective which seemed easy to seize, even though a small ravine prevented any armored support. Counting on the effect of surprise to take a position that to May seemed weakly defended, at dawn on the 9th he launched Company A and C against the main hill, and Company I and L against the western end of Kakazu. Almost without any fighting, A and C companies soon occupied their objective, while the others were halfway to theirs. The Japanese presence was about to be revealed as stronger than initially assessed.

**VICTORY CONDITIONS:** The Japanese win if they have more Good Order VP than the Americans on hill hexes at the end of the scenario.

**BALANCE:**

- Add a 50mm mortar to the Japanese reinforcements

- ☆ Replace the 8-1 Leader with a 9-1 Leader



● JAPANESE setup and move first	● 1 ☆	2	3 ☆	4	5	6	END
---------------------------------	-------	---	-----	---	---	---	-----

**Elements of the 13th Independent Battalion [ELR: 4]**  
setup on hexes of Hill 538 {SAN: 4}:

E 4 <sup>2</sup> -4-8	I 4 <sup>1</sup> -4-7	9-0	8-0	LMG M1 2-6	MTR 50* [1-16]*	DC 30-1	<b>Trench</b> OVR, OBA: +4 Other: +2	<b>Foxhole</b> 5 OVR, OBA: +4 Other: +2
2	3			2	2		2	3

**Reinforcements of the 13th Independent Battalion** enter on turn 1 along the south edge on/east of hexrow U:

E 4 <sup>2</sup> -4-8	I 4 <sup>1</sup> -4-7	2-2-8	9-1	8-0	MMR M1 4-1	LMG M1 2-6	MTR 50* [1-16]*	DC 30-1
4	5			2	2	2	2	

**Elements of A and C Company, 383rd Regiment (96th Infantry Division) [ELR: 4]**  
setup on Hill 621 on hexes with coordinates 5 with 1MMC per hex {SAN: 2}:

E 6 <sup>2</sup> -6-7	I 6 <sup>2</sup> -6-6	8-1	8-0	MMR M1 4-10	MTR M2 3-45	<b>BAZAS XII</b> WPS 8-4
5	3			2	2	2

**Elements of L Company, 383rd Regiment**  
enter on turn 1 from the north edge, west of hexrow T inclusive:

E 6 <sup>2</sup> -6-7	I 6 <sup>2</sup> -6-6	E 3-4-7	9-1	8-0	MMR M1 4-10	MTR M2 3-45	<b>BAZAS XII</b> WPS 8-4
6	2				2	2	2

Scenario Design: Jean-Luc Béchemec '92

**SSR:**

- EC are moderate, with a Mild Breeze from the NW at start. PTO Terrain and Light Jungle are in effect.
- After its setup, each US MMC can attempt to Entrench, applying the leadership of any leader it is stacked with as a DRM, and acquiring a Labor Status of -1 in the case of failure.
- The Japanese have a 70mm OBA module (HE only) with 1 pre-registered hex (secretly recorded before US setup) directed by a Level 2 Offboard Observer situated on the south board edge, whose setup hex is recorded before US setup. This module can place a Barrage (E12.) but in this case the Barrage must be aligned parallel to the south board edge or along a hexrow (not an alternate hexrow) oriented either SE-NW or SW-NE (see diagram).
- At the start of turn 3 the Americans receive an OBA module directed by a Level 2 Offboard Observer on the north board edge, whose placement is recorded prior to the Japanese setup. This module can only place smoke (no WP).

**AFTERMATH:** At dawn, when the first American units had reached their objectives, a Japanese observer suddenly noticed the presence of the Americans. Almost immediately, Japanese artillery opened fire with a barrage, followed by a charge carried out by troops of the 13th Independent Battalion under Colonel Munetatsu Hara. Battered by this shock, Company A radioed an SOS asking for reinforcements, and received in reply the order to hold the crest at all costs. Company L, still moving forward, managed to reach the summit of the western ridge despite the Japanese fire, but it was repulsed shortly after by the defenders. It nevertheless remained positioned on the slopes. For the two companies, the situation rapidly became untenable, and a withdrawal was finally undertaken under the cover of a smokescreen. Despite the advantage of initial surprise, the reaction speed of the Japanese had repulsed the American assault.

# YAE DAKE

## SCENARIO ASL TAC30 Translated by Coastal Fortress Gaming Group



### Peninsula of MOTOBU, OKINAWA, April 16, 1945:

In the northern part of Okinawa, Mt. Yae Dake constituted the last bastion defended by the 4 independent mixed brigades of Colonel Udo. The terrain, a succession of peaks and covered ravines of coniferous trees, made the use of vehicles impossible. The Marines of the 6th division would have to fight without the support of the armored tanks and the equipment superiority of the Americans would be less evident. On the mountain, which dominated the area and its approaches, the Japanese soldiers admirably organized their defense and prepared a fanatic resistance. After a progression skillfully slowed down by harassing operations, the Marines finally arrived in attack position on April 14. On the 15th, the mountain was encircled on three sides by the 4th and 29th regiments. The artillery was laid out on the surrounding hills to support the final attack set for the next day.

### BOARD PLACEMENT:

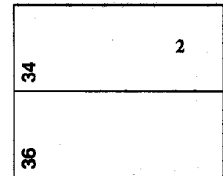

### BALANCE:

- Add a 4-4-8 and a LMG to the Japanese OB
- ☆ US reinforcements from the 29th regiment enter on turn 4



**VICTORY CONDITIONS:** The American wins at game end if they control all Level 3 hexes on Hill 615.

● JAPANESE sets up first	☆ 1	2	3	4	☆ 5	6	7	8	END
☆ AMERICAN moves first									

**Elements of the 44th independent composite brigade "Udo Force" [ELR:4]**  
set up within 7 hexes of 34oW5 {SAN: 6}:

E 4-4-8 5	1 4-4-7 8	2-2-8 2	8-1 2	8-0 2	HMG 3 HT 6-14	MMG 2 HT 4-11	LMG 1 HT 2-5 3	MTR 2 50*(1-16)* 3	DC 3 30-1 3
AA M12 70* [(3)*-70] 2		AA M11 20L (4) 3		Trench OUR, OBA: +4 Other: +2 4		Minefield 1+4+6 6		Minefield IT 24 factors	

☆

**Elements of Company A and C of 1st Battalion, 4th Marines Regiment (6th Marine Division) [ELR:5]**  
set up on/west of row K on board 34 and on/west of K1-P3-P10 hexgrain on board 36 {SAN: 3}:

7-6-8 8	9-2 2	8-1 2	8-0 2	HMG 3 6-12	MMG 2 4-10	MTR 2 60*(3-45)	BAZ45 X11 WPG 8-4	FT X10 24-1	DC 4 30-1	Radio 8
------------	----------	----------	----------	---------------	---------------	--------------------	-------------------------	-------------------	--------------	------------

**Elements of 29th Marines Regiment (6th Marine Division) [ELR: 5]**  
enter on turn 1 from south of board 36, on/east of row Q:

7-6-8 5	8-1 2	8-0 2	HMG 2 4-10	HMG 2 4-10	MMG 2 4-10	MTR 2 60*(3-45)
------------	----------	----------	---------------	---------------	---------------	--------------------

**Reinforcements from 29th Marines Regiment (6th Marine Division) [ELR: 5]**  
enter on turn 5 along the east side:

7-6-8 5	8-1 2	8-0 2	HMG 2 4-10	BAZ45 X11 WPG 8-4	FT X10 24-1	DC 3 30-1
------------	----------	----------	---------------	-------------------------	-------------------	--------------

*Scenario Design: Jean-Luc Béchemec '92*

### SSR:

1. EC are Moderate with no wind at start. PTO terrain is not in effect.
2. Overlay 2 is placed on 34T2-T1. Marsh is Brush. Wood-Road hexes are Paths. Orchard is in season. Bridges are Fords.
3. The Americans receive an 80mm battalion mortar OBAModule.
4. Only Japanese units can take advantage of Paths.

**AFTERMATH:** Shortly after noon, companies A and C of the 4th regiment start climbing the slopes and soon they grappled with the tough Japanese defense. Thrown back a first time they launched a new attack, taking the enemy fortifications on the stony slopes one after the other. The Japanese then launched a charge with 75 men, but the extremely accurate US artillery annihilated the bold Japanese warriors. With a seriously shaken defense, the Marines soon took possession of the mountain top. It would take two more days to mop up the caves that riddled the hills of the last Japanese sniper. Colonel Udo on the other hand had already fled on the 15th with the strong intent to carry on this desperate fight elsewhere.

# BY SAINT GEORGES!

SCENARIO ASL TAC 31 Translated by Coastal Fortress Gaming Group



JANDRAIN, BELGIUM, May 13, 1940:

While the Belgian forces were falling back in disorder, the French Cavalry Corps again deployed over a 40 km front between Tirlemont in the north and Huy in the south. Its mission: to perform a delaying action to give the infantry divisions the needed time to set up according to the Dyle plan. Assigned with covering the north sector, the 3rd DLM made contact as soon as the 12th and its scouting elements were pressed hard. The German push seemed to be applied towards the crossroads of Hannut. On the 13th, 2 Panzerdivisions (3rd and 4th PzD) supported by Stukas and artillery launched the assault.

BOARD PLACEMENT:

33	16
----	----

BALANCE:

- ♣ The German player must exit 20 VP (including 6 infantry VP)
- ⊙ The German player must exit 30 VP (including 6 infantry VP)



VICTORY CONDITIONS: Germans win at the end of the Player Turn if they they exit 25 VP (including 6 infantry VP) along the south edge.

⊙ FRENCH setups first	♣ 1	⊙ 2	♣ 3	4	5	6	7	8	END
♣ AMERICAN moves first									

**Elements of the 3rd squadron, 11th RDP, 3rd DLM [ELR: 3]**  
set up on board 16 on/south of row W {SAN: 3}:

5

**Elements of 10th BDAC**  
set up with the 11th RDP::

3

**Elements of the 1st Cuirassier Regiment, 3rd DLM**  
enter on turn 1 along the west side, on/north of 33Q10:

3

enter on turn 2 along the south side of board 16:

2

enter on turn 5 along the south side of board 33:

2

**Elements of 6th Panzer Regiment, 3rd Panzer Division** enter along the north side with half their MP spent

company 2 enters on turn 1:

3

company 4 enters on turn 2:

2

company 8 enters on turn 3:

2 3

**Elements of the 2nd (motorized) battalion 20th Infantry Division (see SSR 5) [ELR: 4]**  
enter along the north edge on/after turn 3 {SAN: 2}:

6 2 6

Scenario Design: Jean-Paul Gonçalves '93

SSR:

1. EC are Moderate with no wind at start.
2. The 47 AT may not be set up in a Trench. The dm 60\* MTR and the HS must set up as passengers of the Laffly S20TL.
3. Kindling is NA.
4. Place overlays as follows: X7 on 16Y3, X18 on 16CC3-CC4, X9 on 16CC6, X11 on 16EE4-FF4, X12 on 16Z4-Z5 and X13 on 16DD5-EE6.
5. The Opel Blitz's are actually Krupp Protze. Characteristics remain unchanged except: 15 PP, small target.

**AFTERMATH:** Disrupting the French positions in Orp-le-petit the first elements of 6th Panzer Regiment moved into Jandrain. Dragoons from the 1st Battalion from 11th RDP were fiercely resisting there. However it didn't take long for the stronghold to be encircled and Captain Laffargue prepared for a last stand at the village main square. At the same time the H39s came into play. It was a slaughter. The strict German discipline under fire allowed them to stop cold the counterattack. At 1415 the dragoons finally decided to withdraw under the cover of a handful of S-35s. But it was too late: twenty heavy tanks had the road to Jauche under their fire and the Somuas succumbed under a 4 to 1 superiority. With Jandrain lost a very important breach opened in the French defense system while the battle was just beginning.

# COUNTERSTROKE IN CONNAGE

SCENARIO ASL TAC 32 Translated by Coastal Fortress Gaming Group

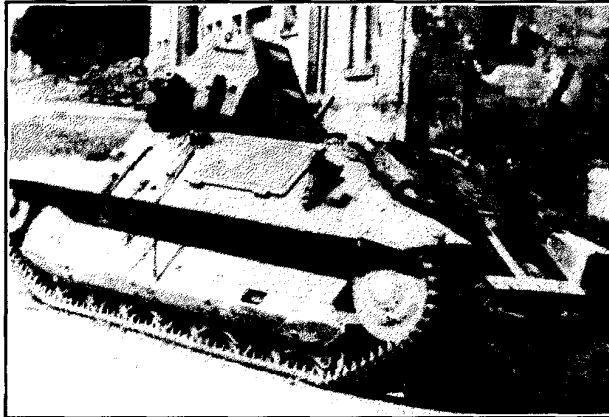

**VICTORY CONDITIONS:** The French win at scenario end if they accumulate 16 VP. This total encompasses VP for Good Order units exited along the north edge and the excess casualty VP score over the German score.

**CONNAGE, FRANCE, May 14, 1940:**

On the previous day the Germans crossed the Meuse in several places, and three three Panzerdivisions (1<sup>st</sup>, 2<sup>nd</sup> and 10<sup>th</sup>) went through in Sedan. The French defenders, demoralized by air bombings, were succumbing under the assault. To face the attack General Lafontaine, commander of the X<sup>th</sup> army corps "holding" the area, ordered a counterstroke south of Sedan. Two tank battalions and two infantry regiments were to "close and recapture" the breach opened by the enemy. The 213<sup>th</sup> Infantry Regiment, with good leadership but poor equipment (officers hadn't had time to supply grenades) set up on the left wing. Support was limited to one antitank platoon and to the 7<sup>th</sup> BCC equipped with FCM 36, but the French soldiers had never performed any combined attack training with tanks. The attack began at 0620 May 14. In spite of some initial success (for example the destruction of enemy machine guns and 37mm guns) the French were getting behind schedule and moved forward without coordination. After taking the weakly defended hamlet of Connage, the 3<sup>rd</sup> company of 7<sup>th</sup> BCC and 213<sup>th</sup> Infantry Regiment marched over Chébery. In front of them the Germans had prepared an antitank defense with disparate but quality elements such as the 14<sup>th</sup> Panzerjäger anti-tank company of regiment Gross Deutschland. The last guns were barely employed when the first French tanks appeared.

**BOARD PLACEMENT:**

**BALANCE:**

- ☉ The PzIVC enters on turn 8
- ☛ Replace a PzIIA with a PzIIIF

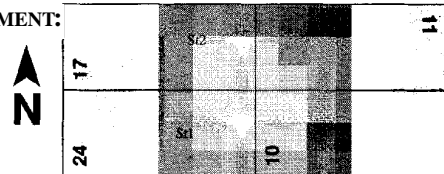

Only hexrows R-GG are playable on boards 17,24 and 11.  
Only hexrows A-P are playable on board 10.

☛ GERMAN sets up first	1	2	3	4	5	6	7	8	9	END
☉ FRENCH moves first										

**Elements of battalion Richter of 1<sup>st</sup> Assault Regiment [ELR:3]**  
set up on boards 11 and 17 east of the stream {SAN: 4};

4 <sup>1</sup> 6-7	2-4-7	9-1	8-0	5-12	3-8	50*(2-13)	1-12
9	2	2	2	2	2	2	2

**Reinforcements of 1<sup>st</sup> Panzer Brigade**  
enter on turn 7 in the same area:

14 37L 10/9	88L 15/4/3*	150*	2-2-8	14 75* -/5
2	3	3	1	1

**Elements of Anti Tank Company of 14<sup>th</sup> Infantry Regiment "GD", from 83<sup>rd</sup> Flak Battalion and Heavy Infantry Gun Company 702 sets up in the same area (see SSR 4):**

12 37L 10/9	88L 15/4/3*	150*	2-2-8
2	3	3	1

**Elements of 3<sup>rd</sup> company of 7<sup>th</sup> BCC**  
enter on turn 1 on/between 24Y10 and 10I10:

37* -/2	9-1
6	3

**Squad of the 506<sup>th</sup> Divisional Anti-Tank Company (see SSR 5)**  
enter on turn 2 on/between 24Y10 and 10I10:

4PP* T12	25LL [45]	2-2-8
3	3	3

**5<sup>th</sup> and 6<sup>th</sup> companies of 2<sup>nd</sup> battalion, 213<sup>th</sup> infantry regiment [ELR:3]**  
enter on turn 2 on/between 24Y10 and 10I10 {SAN: 2};

4-5-7	2-3-7	9-2	8-1	8-0	3PP	2P	2-6	60mm
20	5	2	3	3	3	3	3	

*Scenario Design:  
Philippe Naud & Sylvain Ferreira*

**SSR:**

1. EC is Moderate with no wind at start.
2. French MMC have no grenades. Therefore PBF is NA for them (no doubled FP) and TPBF is treated as PBF (FPs doubled instead of tripled). For the same reason the CCV of MMC is reduced by one (ie: squad 4, crew 3, HS 2).
3. Bore Sighting is NA. German guns may not set up Emplaced (no HIP either).
4. The French antitank squad enters with towed guns.
5. The Valley does not exist (all Level -1 is treated as Level 0). Place overlays as follows: St1 on 24W6-W5, St2 on 17W5-X4. The stream is Shallow and Fordable in 24W2, 17X9 and 17BB2. All Open Ground hexes adjacent to the stream are Soft [EXC: Plowed Field and Route]

**AFTERMATH:** Heavy fire fell upon the FCM 36: PaK 38, 88 guns and even one 150 mm self-propelled gun. Commander Couturier, in charge of the 2<sup>nd</sup> Battalion of the 213<sup>th</sup> Regiment, anxiously observed this strange vehicle that remained out of infantry range. French tanks tried to open a way out, without success. A first tank was immobilized, then a second one got stuck on the boggy side of the Bar stream, and others were destroyed by the sIG and 88's. The attack was at a standstill when several Panzers suddenly appeared, among which were several PzIII. The PCMs are completely unadapted to such a fight: they gave way in front of the enemy tanks maneuverability and firepower. One French tank fired twelve explosive shells against a Panzer with no result whatsoever! Everything was settled for good when a Panzer IV came into play and put an end to the attempt. Only three tanks of the 7<sup>th</sup> BCC eventually managed to retreat and all French anti-tank guns were destroyed. Without support the infantry retreated in turn, trying to contain the German reaction. Indeed the enemy struck back and pushed away the 213<sup>th</sup> RI. The Connage counterstroke had lived...



# FOUR ACES

## SCENARIO ASL TAC 33 Translated by Coastal Fortress Gaming Group

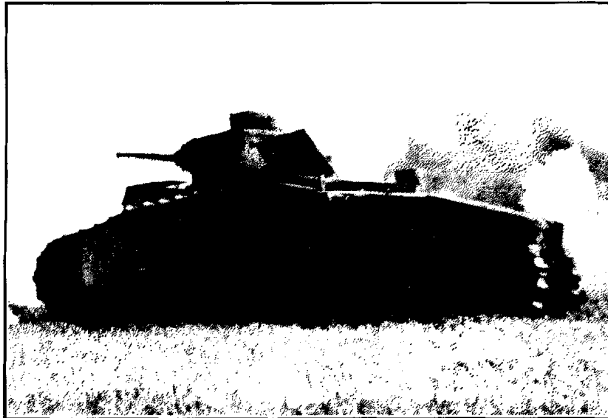

**VICTORY CONDITIONS:** The Germans win if, at the end of the scenario, they exit 40VP between 16A5 and 16A10 (see SSR 5) while having inflicted more Casualty VP than they have lost.

### FLAVION, BELGIUM, May 15, 1940:

In Dinant, 15th Army Corps of General Hoth crossed the Meuse in force and created openings on the first day. The 9th French Army saw its front disintegrate, and it absolutely had to react vigorously. General Bruneau, controlling the 1st Reserve Armored Division, received the command to counterattack in the sector of 9th Army Corps. The axis of attack was Philippeville-Dinant, to reverse the direction of Rommel's 7th Panzer Division... In the scheduled attack, the French suffered from numerous disadvantages: lacking infantry and modern transmissions, no DCA, no recon units and no coordination between infantry, armor and air support. The gasoline supply was chaotic, as much from the Luftwaffe as the gargantuan consumption of the B1-bis. Planned for the evening of the 14th, the attack was postponed to the following day and the French tanks were placed at the entrances to the village of Flavion. The two half-brigades of the tank division (150 machines) unknowingly faced the 5th and 7th Panzer Division that moved in the first hours of May 15th.

### BOARD PLACEMENT:

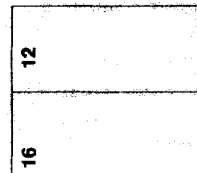

### BALANCE:

- ♣ The Germans must exit 35VP
- ⊙ The Germans must exit 45VP

⊙ FRENCH sets up first	♣ 1	♣ 2	♣ 3	⊙ 4	5	6	END
♣ GERMAN moves first							



**Elements of 26th BCC, 1st DCR**  
sets up on board 12, On/West of hexrow S {SAN:2}:

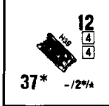

6



**Elements of 28th BCC, 1st DCR**  
enter on turn 3 along the northern edge on/between 12I1 and 12Q1:

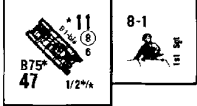

6



**Elements of 25th Panzer Regiment, 7th Panzer-Division {SAN:0}**

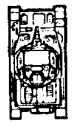

enter on turn 1 on hexes 16GG5 and/or 16GG6 { SAN:0 }:

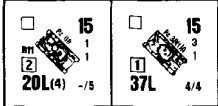

2                  4

enter on turn 2 on hexes 16GG5 and/or 16GG6:

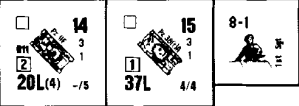

5

enter on turn 3 on hexes 16GG5 and/or 16GG6:

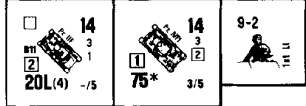

2                  3

*Scenario Design: Sylvain Ferreira '92*

### SSR:

1. EC are moderate, with no wind at start.
2. Gullies and the bridges on board 12 do not exist.
3. Road 16GG5/GG6-Y4-N4-A5/A6 is an Orchard Road.
4. Bore Sighting is prohibited.
5. A German Vehicular Crew that does not exit as Inherent to the AFV does not count towards VP.
6. Use Pz38(t)E counters for missing Pz38(t)Acounters.
7. The B1-bis must enter using Platoon Movement.

**AFTERMATH:** At 0830 hrs, 6 followed by 22 German tanks were spread out in a rather tight formation as they approached Flavion. Immediately, they were attacked by H39 of the 26th BCC, soon reinforced by B1-bis of 28th BCC. A tank battle began and turned initially in favor of the French. The armor superiority and armament of the heavy tanks was obvious, and many of the Pz38 of PzRgt 25 burned on the Phillippeville road. German crews, in spite of this first crushing fight, managed to pass the French tanks and engage them from the sides and rear. The losses were heavy on both sides but the advance of the German armored units was hardly delayed. The 1st DCR, badly supplied and not very mobile, was broken up. Many Panzers were destroyed (30 or 40) but still more French tanks: 65 including approximately 40 B1-bis. 7th Panzer Division completed the destruction of the 1st DCR in the following days. If the French heavy tanks were highly regarded in a tactical confrontation, their defeat was due to their weak autonomy. In effect, whereas the battle was prolonged in the afternoon, the B1-bis ran out of gas one after another and then were either destroyed by the enemy or simply abandoned and sabotaged by their crews. A sad end for the spearhead of the French Army...

# THULIN MUST BE TAKEN!

SCENARIO ASL TAC 34 Translated by Coastal Fortress Gaming Group



**VICTORY CONDITIONS:** The Germans win at game end if they control all multi-level stone buildings.

## THULIN, BELGIUM, May 23,1940:

According to the Dyle plan the French 43<sup>rd</sup> Infantry Division had proceeded to the Maubeuges area. On May 17<sup>th</sup> it was rushed by the 5<sup>th</sup> Panzer-Division withdrew to Bavay. However part of the unit (158<sup>th</sup> Infantry Regiment and 12<sup>th</sup> Artillery Regiment) found itself isolated north of Maubeuges. Their only hope was to reach Valenciennes but two battalions of the 158<sup>th</sup> didn't manage to escape the net. Only the 3<sup>rd</sup> Battalion of the 158<sup>th</sup> and the third company of the 10<sup>th</sup> BCP could pull themselves out of the trap and reach Thulin on May 23. Hoping to find food and ammunition Colonel Pucinelli took the village and captured a few troops from the 269<sup>th</sup> recon Battalion waiting there. The Germans could not allow French troops to their rear and reacted quickly. Colonel von Tschuedi in charge of the 469<sup>th</sup> Infantry Regiment commanded his first battalion to take Thulin back and neutralize the French forces.

### BOARD PLACEMENT:

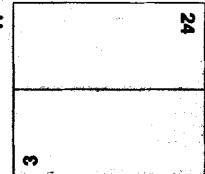

### BALANCE:

- ⊕ Replace the 3x4-6-7 of the 169<sup>th</sup> recon Battalion with 3x4-6-8.
- ⊙ Replace the 2x4-6-8 of the 169<sup>th</sup> recon Battalion with 2x4-6-7.

⊙ FRENCH sets up first	1	2	3	4	5	6	7	8	END
⊕ GERMAN moves first									

**Elements from 3<sup>rd</sup> Battalion, 158<sup>th</sup> infantry regiment, 43<sup>rd</sup> Infantry Division [ELR: 3]**  
set up on/between rows X and J on both boards on hexes numbered 8 on board 24 {SAN: 3}:

1 4-5-7	2 9-2	1 8-1	0 8-0	3 8-11 6-12	2 4-11	1 1-1 8-11 2-8	3 3-42	?	7 morale
13					2			10	

**Elements from 1<sup>st</sup> Battalion, 469<sup>th</sup> Infantry Regiment, 269<sup>th</sup> Infantry-Division [ELR:3]**  
enter on turn 1 along the west edge {SAN: 2}:

1 4-6-7	1 9-1	1 8-1	0 8-0	3 7-16	2 5-12	1 3-8	3 50 * [2-13]
13					2		

**Elements from 269<sup>th</sup> recon Battalion, 269<sup>th</sup> Infantry-Division [ELR: 3]**  
enter on turn 1 along the north edge on/between rows X and J

1 4-6-8	1 4-6-7	2 9-2	0 8-0	2 5-12	1 3-8
2	3				

Scenario Design: Pascal Guet '92

### SSR:

1. EC is Moderate with no wind at start.
2. The Valley and Hills do not exist (treat all ground Levels as Level 0).
3. 1 French squad or equivalent may set up HIP with any Leader/SW stacked with it.
4. The Germans receive a 100mm+ OBA module with an off-board observer located on the west edge on a secretly recorded hex, chosen before the French setup.

**AFTERMATH:** The Germans quickly set up their attack on the village. While the 1<sup>st</sup> Battalion of the 469<sup>th</sup> Regiment attacked from the west with support of the 2<sup>nd</sup> Battalion of the 59<sup>th</sup> Artillery Regiment the 269<sup>th</sup> recon Battalion advanced towards Thulin from the north. The French defended energetically. For a time they contained the Germans on the village edge but the latter had a superiority both in numbers and equipment. The defenders were soon overwhelmed and the wounded Colonel Pucinelli was captured at his command station. A group of die-hards fought until they ran out of ammunition before surrendering. At 1100 the general staff of the 269<sup>th</sup> Infantry-Division received the news of the capture of Thulin and its 300 defenders.

# IN SPITE OF ALL OPPOSITION

## SCENARIO ASL TAC 35 Translated by Coastal Fortress Gaming Group

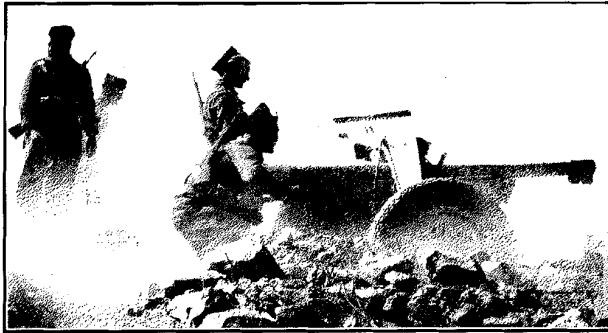

**VICTORY CONDITIONS:** The Axis forces win at game end by exiting 25 VP (at least 16 VP worth of AFVs) between 28A10 and 26GG5.

**BIR-HAKEIM, LYBIA, June 6, 1942:** The 1<sup>st</sup> Free French Brigade had been completely encircled by Axis forces since June 2<sup>nd</sup>. In the north the 8<sup>th</sup> Army hadn't succeeded in reducing Rommel, trapped in the Cauldron. The latter repelled the disorganized English thrusts while maintaining his communications and supply lines. However he must break the position held by Koenig's men to his rear so as to concentrate his strength against the bulk of the 8<sup>th</sup> Army. The bombings grew in intensity on the French positions from June 5 on and the attackers received reinforcements. Since Rommel was not able to break the position "either with artillery, or with planes, or even with tanks", he "will have to send in his infantry", stated Lt. Colonel Broche, chief of the "Pacifiens" of 1<sup>st</sup> Battalion from the Pacific. Indeed the Germans and Italians threw a new powerful attack at the indomitable defenders of Bir-Hakeim.

### BOARD PLACEMENT:

### BALANCE:

☙ Add a PzIIIH to the DAK

☉ Free French Air Support drm is +1

29	26	D5	D1
	H1		D2
		8Z	LZ

☉ FREE FRENCH sets up first	1	2	3	4	5	6	7	8	END
☙ AXIS moves first									

**Elements from 1<sup>st</sup> Battalion from the Pacific [ELR:4] set up on/east of the 29GG10-26Z9-26R5-27P4-27L10 perimeter {SAN: 4}:**

**Reinforcements from 1<sup>st</sup> Free French Brigade enter on turn 5 along the east edge on/between 26GG5 and 27A4:**

**Elements from "Trieste" Division [ELR:3] enter on turn 2 or 3 (in 1 or 2 groups) on/between 29T10 and 29J10 {SAN: 2}:**

**enter on turn 5 on/between 26A8 and 28GG2:**

**DAK: Elements from the 90<sup>th</sup> Light Division [ELR:4] enter on turn 1, 2 or 3 (in 1, 2 or 3 groups) on/between 26A5 and 27GG10:**

### SSR:

- EC are Dry with Light Dust and Intense Heat Haze.
- Place overlays as follows: H1 on 26I4-I3, D5 on 28AA4-BB4, D1 on 27Z6-Y6 and D2 on 27M3-N3. Dummy Minefields must be set up adjacent to one another. The 60 Minefield factors are Known Minefields, the 24 factors are Hidden Minefields. Both may be traded normally for AT mines. Minefields must be set up inside the French perimeter and 3 hexes from it's edges. French guns must set up in Sangars.
- 2 German 4-6-8 are secretly recorded as Sappers. The Pak38 must be towed to a Sdkfz 11 and 81 mm mortar must be dismantled and a passenger of a Sdkfz 11. Both Italian guns must enter towed by Autocarettis.
- The Italian radio gives access to an 80 mm battalion mortars OBA module. The French Field Phone gives access to a 70+ mm OBA module. The Germans get a 100+ mm OBA module with a secretly recorded Offboard Observer on the west edge, chosen before setup. All modules have Plentiful Ammo.

5. F.8 and F.9 apply. The Free French receive Air Support as FB44s. E7.2 applies with +2 drm. The number of planes is determined by a dr divided by 3 (FRU). Axis forces receive Air Support as Stukas, E7.2-21 apply.

**AFTERMATH:** Pouring out of trucks and halftracks in sight of the foremost French positions two German battalions started advancing as the morning ended. Artillery fire did not succeed in neutralizing the Pacific troops positions. The counterattack, of 75 mm guns, anti-aircraft machineguns and mortars, forced the attackers to advance in stages. Grenadiers dug individual holes and set up their 50 and 80 mm mortars. First the Luftwaffe then the RAF made ineffective appearances: Hurricanes riddled already wrecked M13's from the previous days with 20 mm bullets! In spite of a new assault, at the end of the day the French repelled both a German attack and the Italian attempt with its support of 20 tanks. When evening came enemy wrecks once again gave evidence of the tenacity and courage of the "Fighting French".

Scenario Design: Sylvain Ferreira '93

# DEATH FROM THE SKY

SCENARIO ASL TAC 36 Translated by Coastal Fortress Gaming Group

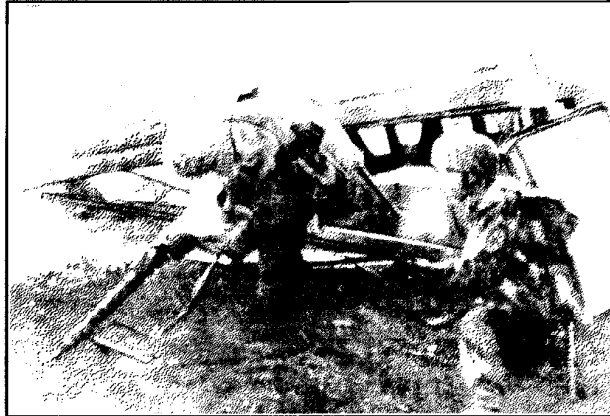

**Drvar, Yugoslavia, May 25, 1944:**

Since the Italian surrender in fall 1944, Tito's communist troops had extended their control area. Deciding to definitively stop this resistance, the Germans prepared operation "Rösselsprung"; a combined assault on the partisan leader HQ, that had been located some months earlier by radio triangulation. When the infantry was ordered to converge toward Drvar, SS paratroopers were given the mission to jump over the city and to destroy the enemy HQ. This audacious attack was given to a formidable shock unit, the 500<sup>th</sup> SS Paratrooper Battalion, a partial disciplinary unit. At dawn of the 25<sup>th</sup>, the surprise was achieved: the German air force had eliminated all enemy anti-aircraft defenses and the gliders approached without opposition. Lieutenant Sieg, commanding the "Panther" Kampfgruppe assigned with capturing Tito, succeeded in landing adjacent to the HQ. The SS paratroopers jumped out the gliders and started fighting.

**BOARD PLACEMENT:**

2	24	18
---	----	----

**BALANCE:**

☛ The Game ends at the end of the 9th German player turn.

★ Partisan units are fanatic while in building 24R4



**VICTORY CONDITIONS:** Germans win at game end if they control all board 24 multihex buildings

★ PARTISAN setups first	☛ 1	☛ 2	3	4★	5	6	7	8	9	END
☛ GERMAN moves first										

**★** Elements of Tito's HQ escort battalion and officer's school [ELR:5] set up on board 24 {SAN:4}:

6-2-8	3-3-7	10-0	9-1	8-0	6-12	4-10	2-5
4	10					2	

Other elements of 1<sup>st</sup> Proletarian Division set up on board 2:

3-3-7	8-1	2-5	45*[2-13]
8			

Elements of 1<sup>st</sup> Proletarian Division set up on board 2:

81* [3-102]	65*	2-2-8
		2

Elements of Lika's 3<sup>rd</sup> Brigade enter on Turn 4 along eastern edge:

5-2-7	3-3-7	9-1	8-0	7-0	2-5
4	8				2

**+** Kampfgruppe "Panther" [ELR:5] Enter on turn 1 by Gliders (E9.) {SAN:2}:

6*-5-8	10-2	9-1	8-1	3-8	3-8	3-8	2-2-8	75* [11]	19PP 29PP 14PP
10		2				4		11	

Other Elements from 500<sup>th</sup> SS paratrooper Battalion: enter on Turn 2 by Air Drop (E8.)

6*-5-8	9-2	9-1	8-1	8-0	3-8	3-8
10					2	4

Scenario Design: Théophile Monnier '93

SSR:

1. EC are moderate, with no wind at start.
2. The board 24 Valley doesn't exist. No Building has stairwells.
3. Partisans use Italians SW/Guns without capture penalties. Their possessed SWs can be kept offboard until their first use (keep a side record). All partisan infantry units have an ELR of 5 and an underlined morale. They cannot deploy but may use multi-locations FGs. No leader can be replaced with a commissar.
4. Germans have no Panzerfausts. The RCL Gun is transported with its crew by a glider as an allied equivalent unit.
5. No Quarter applies. Bore Sighting is NA.
6. 2 Partisan squads may set up HIP along with all Leaders/SWs stacked with them.
7. The German Sniper is placed on the board at the end of the 1st German player turn.

**AFTERMATH:** The glider landing was a total success. In less than one hour of raging fighting, the SS swiped away all resistance in town. But Tito and his allied counselors barely escaped through a cave that emerged in another valley. Having seized their objective, the paratroopers had to hold until the arrival of the infantry. From the heights, the partisan light artillery bombarded the German positions and the partisan reinforcements started to flow toward the town. In spite of their numerical superiority, the Yugoslavian troops did not succeed in gaining a foothold in the town, and at dawn of the 26<sup>th</sup>, the German motorized infantry joined up with the exhausted paratroopers. Even though Tito had managed to escape, the operation was a success: the Yugoslavian losses were very heavy (2 divisions destroyed by the ground offensive), the HQ and radios were destroyed, and a lot of irreplaceable material was lost by the partisans. The communist activity was neutralized for some months in Yugoslavia.

# CHESTNUTS! HOT CHESTNUTS!

SCENARIO ASL TAC 37 Translated by Coastal Fortress Gaming Group

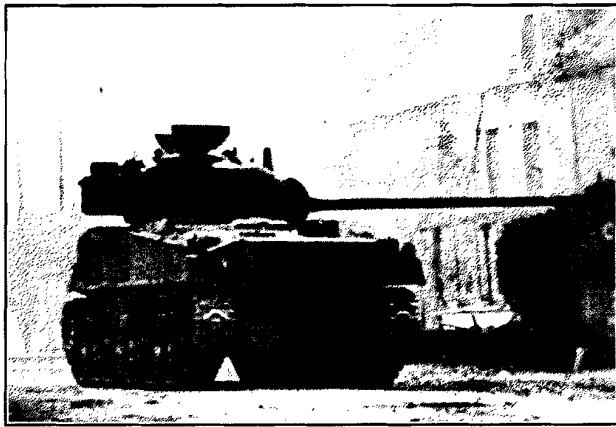

**VICTORY CONDITIONS:** Canadians win at game end if they control all buildings/rubble on board 12 on/between hexrows M and V.

**BURON, FRANCE, July 8, 1944:**

Around Caen, the allied artillery and air force held the bulk of the German forces, but taking Caen was asking for more important measures. For this purpose, Operation Charnwood, with the participation of 3 infantry divisions, 2 armored brigades and the specialized armored vehicles of the 79th Armored Division was launched. The Canadians from the Highland Light Infantry were ordered to take Buron, which was a keypoint to the German defenses, along with the Ardenne abbey. The SS from the Hitlerjugend Division, entrenched behind minefields and anti-tank ditches, guarded the village. At 0730, encouraged by Sergeant Kelly's bagpipes, Colonel Griffiths's troops, supported by some Shermans, assaulted the village.

**BOARD PLACEMENT:**

4	12	17
---	----	----

**BALANCE:**



- ⊙ Add a game Turn
- ⊕ Delete a game Turn

⊕ GERMAN sets up first	⊙ 1	2	3	4	5	6	7	8	9	END
⊙ CANADIAN moves first										

**Elements of 3rd Battalion, 25th Panzergrenadier Regiment, 12th SS Panzer Division [ELR:3]**  
(printed morale stay underlined) set up on/south of hexrow H {SAN:5}:

6 <sup>2</sup> -5-8	5	8	8-0	7-16	5-12	3-8	12-4	7 morale
8						4	2	8

75L	2-2-8	8 DUR, OBA: +4 Other: +2	24 factors	60 factors	3rd platoon of 3rd Battalion, 25th Panzergrenadier Regiment enter on turn 4 along the southern edge:	+15 75LL 3/5/2	9-1
2	2	8				3	

**Elements of Highland Light Infantry of Canada [ELR:4]**  
enter on/after turn 1 along the northern edge {SAN:3}:

4 <sup>2</sup> -5-8	4 <sup>2</sup> -5-7	10-2	9-1	8-1	8-0	1-4-9	1-8	5	2-7	8-3	5mm
12	6	2							5	5	4

13 76LL -1/4	13 75 2/4	9-2	12 75 -1/4	7 75 BF3B -1/4
2	6		2	

**Elements of 27th Armored Regiment (Sherbrooke Fusiliers), 2nd Canadian Armored Brigade**  
enter on/after turn 1 along the northern edge:

**Elements of 30th Armored Brigade and 1st Assault Brigade, Royal Engineers, 79th Armored Division**  
enter on/after turn 1 along the northern edge:

Scenario Design: Frédéric Deglaire '92

**SSR:**

1. EC are moderate, with no wind at start. Kindling is NA.
2. The Trenches in the German OB are AT-Ditches (B27.56). One AT-Ditch placed adjacent to a Wood/Building/Rubble is connected to the Wood/Building/Rubble depiction and prohibits AFVbypass along the shared hexside. Germans have 74 AP-mines factors (that can be normally converted to AT-mines factors), 60 of which must be placed as known minefields (F.7). The known minefields and AT-Ditches must be placed on board before Canadian offboard setup.
3. One German squad-equivalent may set up HIP, along with all leaders/SWs stacked with it.
4. If the terrain permits, the Germans may setup in foxholes of the appropriate size.
5. Before setup, the Germans may place 8 Rubble counters of the appropriate nature in building hexes, or adjacent to Rubbled Building hexes. The Germans may not set up units in building locations without a route to the Ground level.

6. Canadians have a 80mm OBA module, with a level 2 offboard observer placed secretly before German setup along the northern edge.

**AFTERMATH:** With good support from the artillery of the 6th Field Regiment RCA, the Canadians advanced quickly. But when they reached the AT-Ditch, the German defense hardened. Inside Buron, intense fights developed and the Germans defended each building with a desperate energy. Some SS committed suicide rather than surrender. A few tanks of the 12 SS-Pz-Rgt, coming from the Ardenne abbey, attempted a last counter-attack. Despite all the German efforts, Buron was taken, at the cost of heavy Canadian casualties. Their sacrifice (Company C from HLI lost the half of its effectiveness, Company B 2/3 and Company C 1/3) was not in vain, since on July 9th the Allies victoriously entered Caen.

# WHOA MOHAMMED!

SCENARIO ASL TAC 38 Translated by Coastal Fortress Gaming Group



**VICTORY CONDITIONS:** Germans win at game end if the control (A26.12) building 20Z3.

**ARNHEM, HOLLAND, September 19, 1944:**

For two days, 2<sup>nd</sup> Battalion of the 1<sup>st</sup> Airborne Division had held the access ramp of the bridge against repeated assault from two SS armored divisions: the 9<sup>th</sup> SS Panzer Division "Hohenstufen" and the 10<sup>th</sup> SS Panzer Division "Frundsberg". This bridge was vital to the Germans, since it was the only possible crossing point to send troops to retake Nijmegen, controlled by the 82<sup>nd</sup> US Airborne Division. On September 19<sup>th</sup>, the "Frundsberg" Division resumed its eastern attacks to retake the bridge.

**BOARD PLACEMENT:**



**BALANCE:**

- ✦ Add a game Turn
- ⊙ Add a 6-4-8 and a "?" to the British OB.

⊙ BRITISH sets up first	1	2	3	4	5	6	7	END
✦ GERMAN moves first								

**Elements of 2<sup>nd</sup> Battalion, 1<sup>st</sup> Airborne Division [ELR:5]**  
set up on/west of hexrow L {SAN:5}:

6 <sup>2</sup> -4-8	9-1	8-1	8-0	6-14	4-12	2-7	51 [2-8]	8-3	7 morale
11						3	3	3	11

**Elements of 10<sup>th</sup> SS Panzer Division "Frundsberg" [ELR:5]**  
set up on/east of hexrow J {SAN:3}:

6 <sup>2</sup> -5-8	1-5	8-1	8-0	7-16	5-12	9-8
12	2	2	2	3	4	

**10<sup>th</sup> SS Sturmgeschütz Battalion reinforcement**  
enter on Turn 2 on I10 or on A6:

13 8 3 75L -1-12*
----------------------------

Scenario Design: Jacques Merley '91

**SSR:**

1. EC are moderate, with no wind at start
2. Kindling (B25.11) is NA.
3. No Quarter is in effect for both sides. The British troops suffer from Ammunition Shortage (A19.131)
4. On turn 1 the Germans receive a 100mm OBAmodule (HE only) directed by an offboard observer secretly placed before British setup on level 4 on the eastern edge. This module has Scarce Ammo.7. The B1-bis must enter using Platoon Movement.

**AFTERMATH:** Using bayonet charges, screaming "Whoa Mohammed", their motto since their fights in North Africa, the *Red Devils* of the 2<sup>nd</sup> Battalion, despite being critically low on ammunition, pushed back the first enemy infiltration attempt along the river. The support of German Assault Guns did not succeed in undermining the paratrooper's determination. On September 20<sup>th</sup>, the SS had still failed to take the British position. They had to wait until the evening of the 21<sup>st</sup> to see the British defense collapse under their attack. Supported by numerous tanks from both Panzer Divisions, the German infantry nearly destroyed the 2<sup>nd</sup> Battalion. Of the 10,000 troopers from the 1<sup>st</sup> Airborne Division, only 2163 came back from Arnhem. Montgomery had aimed "ABridge Too Far".

# OPERATION ON THE GUDBRANDSDAL

SCENARIO ASL TAC 39 Translated by Coastal Fortress Gaming Group



## TRETEN, NORWAY, April 23, 1940:

Landing on April 19 in Aandalsnes, the 148<sup>th</sup> British Territorial Brigade first had to go north to take back Trondheim harbor. In fact, it quickly appeared that the most serious threat was coming from the south, where the Germans, halted 10 days before in Oslo, were pushing back the Norwegian 2<sup>nd</sup> Division along the railway and the Gudbrandsdal river. The Brigade then turned south, but did not manage to regroup early enough to stop the Germans from seizing Lillehammer. The British were then heavily handicapped by the *Cedarbank* torpedoing, which sank the entire Brigade transportation pool along with the majority of its ammunition and food reserves. Transported with hastily requisitioned trucks and buses, the British soldiers also suffered from a lack of winter clothes. Finally, a strong defensive position was installed at Tretten, where the steep hills west of the Gudbrandsdal interdicted all moves. Despite the support of some surviving Norwegian units, things were not looking too good. Without artillery support and short of ammunition, the British soldiers hadn't slept and had barely eaten during the last thirty-six hours.

**VICTORY CONDITIONS:** The Germans wins at game end if they exit 22 VP (prisoners included) along the northern edge.

**BOARD PLACEMENT:**

**BALANCE:**

☙ Germans must exit 20 VPs in order to win

⊙ Delete SSR3.



7	
	2

⊙ BRITISH sets up first	1	2	3	4	5	6	7	8	9	END
☙ GERMAN moves first										

**Elements of 148<sup>th</sup> Territorial Brigade (Leicestershire Regiment and Sherwood Foresters) [ELR:2]**  
set up on Board 2 Hill hexes, on/north of hexrow M {SAN:3}:

 4 <sup>2</sup> -5-7	 8-0	 8-0	 4-12	 2-7	 5   2-11	 1-12
10			2	2	2	

**Forester Regiment reinforcements**  
enter on turn 4 along the northern edge:

 4 <sup>2</sup> -5-7	 8-0	 2-7	 1-12
5			

**Elements of the 196<sup>th</sup> Infantry Division [ELR:3]**  
enter on turn 1 along the southern edge {SAN:2}:

 4 <sup>1</sup> -6-7	 8-0	 8-0	 8-0	 3-8	 3-8	 8-20
15		2	2	3	2	

15
8-0
CMG

3

*Scenario Design: Théophile Monnier and Robin Reeve*

**SSR:**

1. EC are Ground Snow, with no wind at start.  
The River is not frozen (B21.6 is NA)
2. All Buildings are wooden.
3. British MTRs suffer from Ammunition Shortage
4. The western side of the river cannot be entered from offboard.

**AFTERMATH:** Placed forward on the road, two Forester companies, supported by a Leicestershire company placed on the heights, were attacked by the Germans around 1300. After an hour of fighting, the second company of the Leicestershire was sent from Tretten as reinforcements. Three German light tanks pierced the British positions, without being damaged by numerous antitank rifle shots, and deeply advanced toward Tretten. Unluckily for the British, they intercepted some officers of the Brigade on recon duty, along with the Norwegian military adviser, and cut off all retreat. The village itself was soon under infantry gunfire and had to be abandoned. Only a British rear guard held until the evening to allow all the units of the area to withdraw. On their side, the Norwegian dragoons, positioned farther east to prevent an eventual turning attack, weren't attacked and could return to their trucks safely. Reduced to 9 officers and 300 troopers, the 148<sup>th</sup> Brigade was no longer a sufficient combat force to prevent the Germans from resuming their attack toward Aandalsnes. One week later, the British Corp. had to disengage and the Norwegian 2<sup>nd</sup> Division surrendered on May 2<sup>nd</sup>.

# SCOTTISH NIGHTMARE

SCENARIO ASL TAC 40 Translated by Coastal Fortress Gaming Group

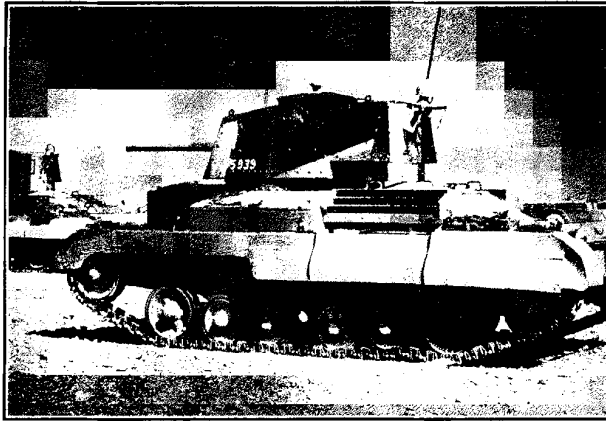

## SIDI OMAR, CYRENAICA, June 16, 1941:

Anticipating the new British offensive Battle-Axe, Rommel opted for a mobile defense. The main reason was that, because of its supply shortage, he could not engage all his Panzers. To anchor this defense, the Halfaya passage, a winding pass, was turned into a fortress. Several of the dreadful 88mm batteries were entrenched there and carefully camouflaged, like around Fort Capuzzo. Behind this shield, Rommel deployed his 15th Panzer and 5th Light Divisions, both ready for a counterattack. A dawn on June 15th the 4th and 7th Armoured Brigades started their progression. The 4th Brigade took Capuzzo at the end of the day after a stiff fight and the 7th Brigade crossed the wire and rushed toward Sidi Azeiz. On the morning of the 16th, the operation resumed. The British were determined to seize Halfaya pass to avoid any blockage in their progression. The 7th Armoured Division had to continue their previous days task: fight the Panzers. Some Matildas were even detached to reinforce the Cruisers, as well as the Support Group covering the western sector. On its side, the 5th Light Divisions (reinforced with 8th Panzer Regiment) objective was to outflank the British on the west side and to emerge behind them from Sidi Omar. At dawn's glow, the 2nd and 8th companies of the 8th Panzer Regiment met the first Cruisers. A whirling melee began, vehicles appearing and disappearing in walls of dust, to strike at point blank range.

**VICTORY CONDITIONS:** The Germans win if they control one hillock summit and have a Good order Infantry MMC on it at game end, while having suffered less DVPhan the British .

### BOARD PLACEMENT:

#### BALANCE:

- ♣ Replace the 8th company 9-1 ALwith a 9-2 AL
- ⊙ One of the 2pdr Portee may setup unloaded

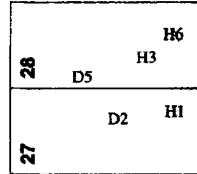

⊙ SET UP is simultaneous	♣	1	2	3	4	5	6	7	END
♣ GERMAN moves first									

**Elements of Support Group of the 7th Armoured Division: 1st King's Royal Rifle Corps & 3rd Royal Horse Artillery [ELR:3]**  
setup on/east of hexrow U {SAN:3}:

4 <sup>2</sup> -5-8 3	4 <sup>2</sup> -5-7 4	9-1 1	8-0 1	MGC [3] 6-14 2	LMG 2-7 2	ATR 1-12 2	MTR [2] 5   [2-11] 8	? 7 morale	Foxhole 5 1S OVR, OBA: +4 Other: +2 7	Sangar 1S or Gun OBA: +3 Other: +1+ 3
--------------------------	--------------------------	----------	----------	----------------------	-----------------	------------------	----------------------------	---------------	---	---

**Matildas of 7th RTR**  
setup on the road (SSR2) on/east of hexrow Q:

25 NAUCA CS 4 40L 2	MTR M11 [2] [6-38] 76* [3 63] 42+ 2	ART M8 88 18 2	9 [2] [1-11] 40L -/-
------------------------------	--	-------------------------	-------------------------------

**Elements of 2nd RTR**  
enter on turn 1 on/between 27Q10 and 27GG10:

16 [2] [3 2] 40L -/-	10 [2] [3 3] 40L 2/4 3
-------------------------------	------------------------------------

**Elements of 2nd Company of 8th Panzer Division and of 115th Schützen Regiment [ELR:4]**  
setup in Motion, on/west of hexrow G (see SSR4) {SAN:2}:

4 <sup>2</sup> -6-8 6	9-2 1	8-0 1	4m MGC 3-8 2	LMG 3-8 2	ATR 1-12 2	9-1 1	13 [2] [3 3] 50 3/5 2	13 [2] [3 3] 50 3/5 2	14 [2] [3 1] 20L(4) -/- 2	16 [2] [3 1] 15PP AANG -/-/3 6
--------------------------	----------	----------	--------------------	-----------------	------------------	----------	-----------------------------------	-----------------------------------	------------------------------------	--

**Elements of 8th Company of 8th Panzer Regiment and of Flak Battalion I/33**  
enter on Turn 1 along the western edge:

14 [1] [3 3] 75* 3/5 3	13 [2] [3 3] 50 3/5 3	17 T-4 18PP 3	AA 88L AS/4/3+ 3	9-1 1	2-2-8 1
---------------------------------	--------------------------------	---------------------	------------------------	----------	------------

Scenario Design: Jean-Paul Gonçalve

### SSR:

1. EC are dry, with a Mild Breeze blowing from the Southwest. Light Dust and Vehicular Dust are in effect
2. Place the following overlays: H1 in 27CC3/DD3, H3 in 28X7/W8, H6 in 28CC4/DD4, D2 in 27T3/T4 and D5 in 28L10/K10. A Dirt Road goes from 28F0 to 27GG4. 28oCC5 is a Hillock Summit.
3. 1 British squad equivalent may setup HIP along with all Leaders/SWs stacked with it. The British may setup up the OB-given "?" in non-concealment Terrain. The 2pdr Portee must setup loaded on the trucks. The British 88mm guns have no APammunition.
4. The German Infantry must setup in the Halftracks as passengers, using Cloaking.
5. Setup is simultaneous. Place a board vertically between the 2 players.

**AFTERMATH:** The Germans envisaged overflowing the British defenses with a combination of moving and firing. They did not take into account the Matildas and the Royal Horse Artillery gunner skills, which took a heavy toll on the Panzers. Even as the German tanks still advanced, the British infantry held. Six hours later, the 8th Panzer Regiment was nearly destroyed, only 30 tanks having crossed undamaged to the British positions. Following closely, the Panzergrenadiers joined the fight and attacked the British infantry, well prepared to receive them. Yet, as early as noon, the losses from the 7th Armoured Brigade were alarming, and with the fighting resuming around 1800, only nightfall managed to save the Brigade from complete destruction. The Desert Fox had regained the initiative.



# LAST STOP BEFORE VICTORY

SCENARIO ASL TAC 41 Translated by Coastal Fortress Gaming Group



**VICTORY CONDITIONS:** The Americans win at game end if they control 10 of the 13 building hexes of Overlay 1.

## YIGO, GUAM, 7 August 1944:

The conquest of Guam was approaching its end. Pursued by American forces, the Japanese were withdrawing towards the northeast of the island. Yigo, the last stronghold before beginning the cleanup phase, remained to be taken. The start line of the 3<sup>rd</sup> Battalion of the 307<sup>th</sup> Regimental Combat Team was fixed at 500 yards south-southeast of Yigo. The main axis of advance was the Finegayan-Yigo road. On the left, the 306<sup>th</sup> Regiment was ordered to follow a parallel route. The infantry were supported by D Company (light tanks) followed by C Company (medium tanks) of the 706<sup>th</sup> Tank Battalion. The objective was the occupation of Yigo as well as the heights which dominated it to the east and the north. The attack was to take place immediately after a bombardment of the village, but the narrow road in the assembly area created traffic jams and it was some 15 minutes after the end of the artillery preparation when the light tanks finally launched themselves into a less-congested area extending south of the village.

### BOARD PLACEMENT:

34	1
	SC

### BALANCE:

☆ 1<sup>st</sup> platoon enters on Turn 3

● One of the two Japanese tanks may setup HIP



● JAPANESE setups first	☆ 1	☆ 2	3	☆ 4	5	6	7	8	9	END
☆ AMERICAN moves first										

**Elements of the 2<sup>nd</sup> Battalion, 18<sup>th</sup> Infantry Regiment, 29<sup>th</sup> Division, of the 48<sup>th</sup> Mixed Independent Brigade [ELR: 4] and of the 2<sup>nd</sup> Battalion, 9<sup>th</sup> Tank Regiment setup on map 35 north on/north of hexrow I, and/or on map 34 on/north of hexrow I in hexes numbered 4 {SAN: 6}**

●

1 4'-4-7	2 3-4-7	2-2-8	9-1	9-0	8-0	3 6-14	2 4-11	1 2-5	5 50-116*	1	1-12
5	6	6						2	3		

14 57 2, 32	3 37L	20L (4)	5 1S OVR, OBA: +4 Dther: +2
2	2		12

☆

<b>Elements of D Coy, 706<sup>th</sup> Tank Battalion enters on Turn 1 on the south edge of board 35:</b>	<b>Elements of C Coy, 706<sup>th</sup> Tank Battalion enters on Turn 2 on the south edge of board 35:</b>	<b>1<sup>st</sup> Platoon, K Coy, 306<sup>th</sup> Infantry Regiment enters on Turn 4 between 34Y10 and 34Q10:</b>
17 37LL 2/4/2	13 75 2/4/4	6-6-7
3	3	3

**Elements of the 3<sup>rd</sup> Battalion, 307<sup>th</sup> Infantry Regiment, 77<sup>th</sup> Infantry Division [ELR:4] enter on Turn 2 on the south edge of board 35 {SAN: 2}:**

6-6-7	6-6-6	9-1	8-0	7-0	3 6-12	2 4-18	8-4	24-1
4	10				2	3		

*Scenario Design: Jean-Luc Béchenec '92*

### SSR:

- EC are Moist, with no wind at start. PTO rules are in effect. The stream is Dry.
- Place Overlay 1 on 35T2-T1. The roads on Board 35 and Overlay 1 do exist [EXC: The roads R6-Q10 and P4-Q1 are Paths].
- Kindling is NA.
- Before the Japanese setup, the American player secretly notes 3 pre-registered hexes with 3 hexes range between each. After both sides setup, the American player successively places on each of the 3 hexes a FFE counter, checks for accuracy as per C1.731, resolves a normal HE FFE of 100+mm, then removes the FFE counter. 5. The Huts of Overlay 1 are considered wooden buildings [EXC: B23.41 does not apply].

**AFTERMATH:** The light tanks rapidly came under an intense machinegun fire coming from entrenchments and from pillboxes along the length of the right side of the road. The M5's rapidly crashed through these positions and continued their progress towards Yigo, leaving their reduction to the medium tanks and infantry. Suddenly, several cannons opened fire on the left of the formation, destroying two of the M5's, the remainder of whom called upon the medium tanks to reinforce them. One of the M4's met the same fate in turn. However, despite the reduction by the flamethrower and grenade wielding infantry, one by one, of the Japanese positions bypassed by the Japanese armor, the Japanese defenses arranged in the jungle to the left of the road remained intact. The commander of the 3<sup>rd</sup> Battalion of the 306<sup>th</sup>, Colonel Kimbrell, hearing the noise of combat, personally led the 1<sup>st</sup> Platoon of Company K to take the Japanese positions from the rear. Surprised by the arrival of the 1<sup>st</sup> Platoon, the Japanese position, designed to repel attacks coming from the direction of the road, rapidly crumbled. The last center of resistance broken, the Americans quickly entered Yigo without opposition. The conquest of Guam was at the point of drawing to a close.

# A WAR OF CORPORALS

SCENARIO ASL TAC 42 Translated by Coastal Fortress Gaming Group

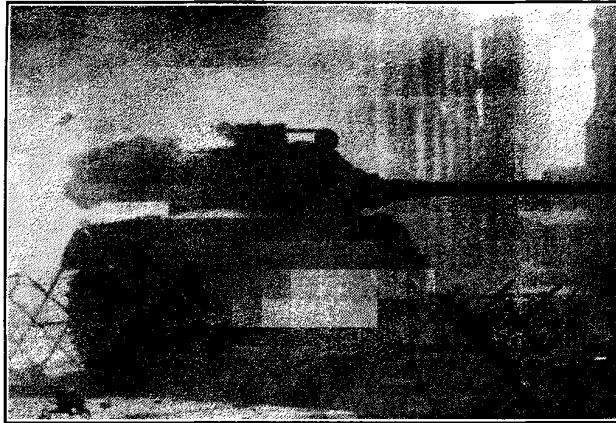

**VICTORY CONDITIONS:** The Americans win at game end if they control buildings 20U2 and 20Z3.

**BREST, FRANCE, 16 September 1944:**

After the piercing of the front at Avranches, the Americans launched their divisions in all directions, notably in Brittany. Their lines of resupply were lengthening, and the capture of the large French ports was deemed essential. Brest became the primary objective of US VII Corps. The city garrison was formidable. Led by General Ramcke it consisted of 30,000 men stiffened by the parachutists of the 2<sup>nd</sup> Fallschirmjäger Division, veterans of the Eastern Front. The assault by three divisions of VII Corps was launched on 25 August, supported by fifteen artillery groups and seven heavy bomber formations. Despite their numerical advantage, the Americans were dealt with harshly. The 23<sup>rd</sup> Infantry Regiment finally managed to reduce the exterior defenses by 8 September, but the paras were still holding firm. It would be necessary to engage in difficult street-fighting.

**BOARD PLACEMENT:**

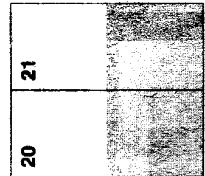

**BALANCE:**

- ☆ Replace one of the 8-0 leaders in the US OB with an 8-1.
- ♣ Remove one MMG from the US OB.

*Only hexrows R to GG are playable.*

♣ GERMAN sets up first	☆	1	2	3	4	5	6	7	8	END
☆ AMERICAN moves first										

**Elements of 7<sup>th</sup> Fallschirmjäger Regiment and of the 266<sup>th</sup> Infantry Division [ELR:4/3] (see SSR 6)**  
set up on board 20 and/or on board 21 in hexes numbered 5 {SAN: 4}.

5 <sup>2</sup> -4-8	4 <sup>1</sup> -6-7	4-4-7	9-2	8-1	8-0	7-0	7-16	5-12	3-8	12-4	7 rubble
7	3	2							3	2	12

50L [75]	81* [2-60]	2-2-8
		2

**Elements of 23<sup>rd</sup> Infantry Regiment, 2<sup>nd</sup> Infantry Division "Indian Head" [ELR: 4]**  
enter on turn 1 on the north edge. {SAN: 3}

6 <sup>2</sup> -6-7	6 <sup>1</sup> -6-6	9-1	8-1	8-0	7-0	6-12	4-10	8-4	24-1	8
8	12			2		2	3	4		

24
76L [1-14]
2

*Scenario Design: Pascal Guet '92*

**SSR:**

1. EC are Moderate, with no wind at start.
2. The German player can, before placing his units, place 10 Rubble counters of the appropriate colour at Ground Level wherever he wishes in the playing area. Any Rubble counter not placed in a building hex counts as 2 Rubble counters and must be positioned adjacent to a Rubble counter of the same type situated in a multi-story building hex. No building can contain more than one Rubble counter. No Rubble can be placed in a Stairway hex of buildings 20U2 and 20Z3.
3. The German player cannot place a unit in an Upper Level of a building if that unit cannot trace a path to Ground Level of that building.
4. One German squad or equivalent can setup using HIPalong with any Leaders/SWstacked with it.
5. The German player can fortify 4 building Locations. Kindling is NA.
6. German Elite squads and SMC have ELR 4, all other German units have ELR 3.
7. Americans receive a 100mm+ OBAmodule.

**AFTERMATH:** The US soldiers slowly progressed into a city reduced to ruins by aviation and artillery. Despite the support of tank destroyers, each house had to be taken in hand-to-hand or by flamethrowers. It was a war of corporals according to General Robertson. It required eight further days of heavy and bloody advances and reduction of a fortified strongpoint by the railway station to reach the Old City. On 18 September, Oberst Pietsonka, commanding the paras, surrendered his regiment to the 2<sup>nd</sup> Division, preceding the surrender of the Brest garrison itself which took place on 21 September. The port, in ruins, would not be operational for several weeks. General Ramcke had accomplished his mission and was awarded the Oak Leaves with Swords and Diamonds to his Knights Cross of the Iron Cross (he became the 28<sup>th</sup> holder of this high decoration).

# MASSACRE IN PARADISE

SCENARIO ASL TAC 43 Translated by Coastal Fortress Gaming Group



**LE PARADIS, South of MERVILLE, FRANCE, 27 May 1940:**

The Allied Command was building Operation Dynamo to allow the evacuation of encircled Franco-British troops at Dunkirk. To the extent possible, a defense perimeter was put in place. But the German pressure was strong. Among the assailants was the Totenkopf Division of the Waffen-SS. It was made up of members of the "Death's head groups", guard units from concentration camps. Its head, Theodor Eicke, was a former commander of the Dachau camp. The formation of this division aroused the hostility of the Wehrmacht, which refused to equip it. Himmler finally obtained Czech cannons and machineguns for the division. Engaged at the moment of the British counterattack at Arras, and then at Bthune, the Totenkopf was sorely tried due to the inexperience of its troops and leaders. On 27 May, the division isolated the soldiers of the 2<sup>nd</sup> Royal Norfolk Regiment to the south of the hamlet named Le Paradis.

**BOARD PLACEMENT:**

**BALANCE:**

- ♣ Increase the number of turns to 6.5
- ⊙ Add 6 "?" to the British OB.



01

**VICTORY CONDITIONS:** The Germans win if, at scenario end, they control 21 Stone Locations.

⊙ BRITISH sets up first	1	2	3	4	5	6	END
♣ GERMAN moves first							

**Elements of 2<sup>nd</sup> Royal Norfolks Regiment [ELR: 2]**  
 setup 3 hexes from T5 with 1 MMC per hex {SAN: 4}

 4 <sup>+</sup> 5-7	 8-1	 8-0	 2-7	 7 morale
9			2	6

**Elements of 2<sup>nd</sup> SS Regiment, Totenkopf Division [ELR: 2]**  
 setup on/south of hexrow I {SAN: 2}.

 4 <sup>+</sup> 6-8	 8-1	 8-0	 6-1	 4-10	 2-7	 50 * [2-13]
13		2		2	3	2

 81* [2-80]	 2-2-8
----------------	-----------

*Scenario Design: Philippe Naud '93*

**SSR:**

1. EC are Moderate, with no wind at start. Hex AA7 has a second floor (only this hex, not the whole building). Building AA7 contains an Inherent Stairwell in each of its hexes. Kindling is NA.
2. The Germans are considered SS (A20.4) but the Broken Morale of SS Squads/HS is not increased nor is their Morale considered underlined. The Germans use Axis Minor MG without Captured Use penalty and with B12.
3. The German 81mm mortar has S9 (C8.2).

**AFTERMATH:** The British entrenched in a large farm. They underwent shelling and assault by the men of 2<sup>nd</sup> SS Regiment, who began taking heavy losses. The defenders resisted throughout an hour, then, encircled, exhausted and short of ammunition, they surrendered. One hundred prisoners were then lined up against a wall and shot down by the machineguns of 4<sup>th</sup> Company, commanded by Obersturmfuehrer Knoechlein. Any survivors were finished off. Only two Englishmen, seriously wounded, miraculously escaped and were taken in by villagers. They were then picked up and given medical aid by another German unit, before being sent into captivity. At the end of the war, the testimony of one of the two, Albert Pooley, was enough to condemn Knoechlein to death in 1945. During the trial, the soldiers who had participated in the massacre justified their actions by arguing that the losses suffered by their unit were due to the use of dum-dum bullets by the British. They rejected entirely any responsibility for the massacre on the part of Knoechlein. But with this massacre at Le Paradis, the Totenkopf wrote a new chapter in the sinister reputation of the Waffen-SS.

# LEBANESE DRAMA

SCENARIO ASL TAC 44 Translated by Coastal Fortress Gaming Group



**VICTORY CONDITIONS:** The Vichy French player wins as soon as he has exited 22 Good Order VPoff the southern board edge, if he has accumulated more CVP than the Commonwealth player.

## North of MARYJAYOUN, LEBANON, 15 June 1941:

Foreseen to be a military parade, the invasion of Lebanon by Commonwealth and Free French troops became a persistent battle. Not in the least neutral and passive, the Vichy forces prepared to counter-attack after their initial surprise. On 10 June, the Australians advancing on Beirut seized Marjayoun. This city became one of the Vichy objectives, as they were seeking to cut the communication lines of their adversaries. Some R35s of 6th African Armored Regiment (RCA), the 2nd Battalion of 29th Algerian Infantry Regiment (RTA), and some artillery formed up on the 14th, in preparation for a counter-attack the next morning. The northern approach to the city, Balate Ridge, was held by the English of the First Cavalry Division, who had just swapped their horses for trucks. The French attack began around 1400, when the 7th Company of 2nd Battalion of 19th RTA advanced on the ridge and the 5th Company moved on the left in the valley. The tanks of Captain Bellegarde came under withering artillery and antitank fire and had to withdraw. But the Greys retreated in the face of the Algerian skirmishers despite receiving the reinforcement of the Yeomanry and their machineguns. The portees abandoned the position when the R35s returned in force. The 5th Company then took the foot of the ridge in order to participate directly in its assault, supported by artillery.

### BOARD PLACEMENT:

### BALANCE:

- ⊙ Add another R35 to the 6th RCA
- ⊙ Replace the MMG with a HMG in the allied OB

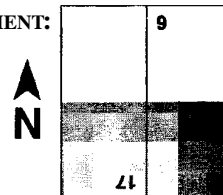

Only hexrows A-Q on board 17 and Q-GG on board 9 are playable

- ⊙ Setup is sequential, see the OB below.

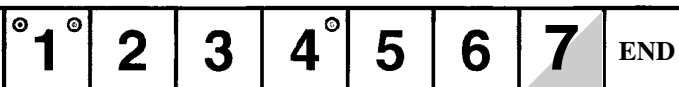

**Elements of the 171st Light Antiaircraft Battery** setup first on board 9 on/south of hexrow V (see SSR3).

**Elements of A Squadron, Royal Scots Greys, and of B Squadron, Staffordshire Yeomanry, and the Machinegun Troop [ELR:2]** (see SSR2) set up third on/south of hexrows V on board 9 and Lon board 17 {SAN: 4}.

**Troop of the 6th Australian Cavalry Regiment** enter on Turn 1 on the south edge (see SSR2).

**Elements of the 2nd Battalion of 5th Australian Infantry Regiment [ELR:3]** enter on turn 4 along the south edge of board 17 (see SSR2).

**Elements of the 5th and 6th Companies of the 2nd Battalion of 29th RTA [ELR:3]** setup second on board 9 on/north of hexrow T {SAN: 3}.

**Elements of the 6th RCA** enter on/after Turn 2 on the north edge of Board 9.

enter on Turn 1 on the north edge:

Scenario Design: Philippe Naud and Jean-Luc Béchenec '93

### SSR:

1. EC are Dry with no wind at start. Kindling is NA. Woods are considered Olive Groves. These Olive Groves are not Inherent Terrain and follow the outlines of the terrain replaced. These hexes are still considered Woods for RtpH and RPh purposes only. Grain is Open Ground. Roads do not exist.
2. Commonwealth 4-5-8/2-4-8 and SMC have an ELR of 3. All other British units have an ELR of 2. The Carriers contain 2-4-8 HS (D6.82).
3. The 40L AA Guns cannot be setup HIP but can be setup Concealed and Emplaced.
4. The Vichy French receives a 70-mm module (HE and Smoke) directed by an off-board observer secretly placed at Level 4 along the north edge of Board 9 before the Commonwealth setup. Its first Battery Access attempt is automatically successful - remove a black chit from its Draw Pile.

**AFTERMATH:** Well led by several energetic officers, the French infantry pushed back the English cavalry, who revealed themselves to be mediocre infantry. The carriers which brought reinforcements into the Debbine Valley clashed with the Algerian Skirmishers. They retreated and regrouped along with a company of Australian infantry under Lieutenant Mayberry, and took position north of the village of Debbine around 1730. Despite the absence of cooperation between the 2nd Battalion and the tanks, the ridge was taken by the French by 1900. The Greys and the Yeomanry withdrew in disorder and abandoned its prisoners. The 7th Company continued its advance and chased the Australians out of Debbine. But it was too late to hope to take Marjayoun before nightfall. For their part, the Anglo-Australian forces finally evacuated the city in favor of a position further south. The Vichy forces occupied their objective the next morning, but despite this first success, the French counter-offensive lacked drive and would not go much further.

# RAKKASAN BUTAI

## SCENARIO ASL TAC 45 Translated by Coastal Fortress Gaming Group



**VICTORY CONDITIONS:** The Japanese win at game end if they control 2 of the board 38 buildings and if they have destroyed/captured 2 of the 4 Guns/HMG

### PALEMBANG, SUMATRA, 14 February 1942:

Since the beginning of the year, the Japanese expansion knew no bounds, and the results were beyond expectations. Under terrible pressure, Malaysia, Borneo, Sulawesi, Ambon and almost all of the Philippines had fallen into their hands. It now remained to seize the Dutch Indies, and Java in particular, extremely rich in raw materials. But it was initially essential to be ensured of the bases for air support, and Sumatra offered for that matter excellent possibilities. The mission of capturing one of the airfields at Palembang was assigned to the Paratrooper Brigade of Colonel Kume. The task would not be easy however. A composite force of Dutch and artillery AARegiments of the RAF (with most of the men converted to simple infantrymen) spread itself around the two airfields and a refinery. After many delays, the Japanese were ready to parachute on February 14<sup>th</sup>. At 1130 hours, the Japanese planes flew over the drop zones. Suddenly, a multitude of small black flakes and tracers framed the transport fleet.

**BOARD PLACEMENT:** 38

**BALANCE:**

- The Japanese only have to destroy/capture 2 of the 4 Guns/HMG in order to win.
- Replace the 10-2 leader with a 10-1 in the Japanese OB.

**N**

	1
38	

<input checked="" type="radio"/> ALLIES set up first	1	2	3	4	5	6	7
<input type="radio"/> JAPANESE moves first							

**Elements of the mixed defense battalion of Palembang: Anti-aircraft RAF Regiment [ELR:3] and Dutch [ELR:2] set up on board 38 on/north of hexrow Q (see SSR 2) {SAN:3}:}**

 5 4-4-7 8-1 7-0 MMG 2 4-12 LMG 1 2-7	3 4-3-7 7-0 LMG 1 2-8 ? 7 morale
 2 AA M8 40L (8) AA M1 94* HMG 50 cal 8-14 2-2-8	4 Trench OUR, OBA: +4 Other: +2 Sangar IS or Gun OBA: +3* Other: +1*
<b>Dutch reinforcements enter on turn 2 on/between 35N10 and 35T10:</b> 4 4-3-7 8-1 LMG 1 2-8	

**Elements of the Raid Group Paratrooper Brigade [ ELR: 5 ]**

Group south enters by Air drop (E9) on turn 1 (see SSR 3) {SAN: 3}:}

7 E 4-4-8	2 2-2-8	10-2	9-0	2 4m MMG 2	2 LMG 1 2-8	3 4m MTR 30m	DC 30-1
-----------------	------------	------	-----	------------------	-------------------	--------------------	------------

Group north enters on turn 3 along the northern edge on/between 35GG5 and 35GG10 (see SSR 3):}

5 E 4-4-8	E 2-3-8	2-2-8	9-1	8-0	2 MMG 2 4-11	2 LMG 1 2-8	2 MTR 50*(1-18)*	DC 30-1
-----------------	------------	-------	-----	-----	--------------------	-------------------	------------------------	------------

Scenario Design: Jean-Paul Gonçalve and Jean-Luc Béchenec '93

### SSR:

- EC are moist, with no wind at start. PTO is in effect with Light Jungle. Place overlay 1 on 35T2-T1.
- Allied crews are British. Bore sighting is NA. The Guns and the .50 cal HMG must be placed in Sangars in open ground hexes [EXC: Runway] within 3 hexes of 38J6. They are fixed and cannot be dismantled/towed or moved/pushed (the HMG crew must abandon it in order to leave it's location). The .50 cal HMG must be manned by a crew to avoid Non-Qualified Use penalties; a British crew incurs no penalty for Captured Use. The trenches cannot be placed on a runway hex. Sangars represent circular sites of sand bags, and are treated exactly as Sangars. The color of Allied "?" counters used is the choice of the Allied player.
- 2 Japanese squads are secretly noted as Assault Engineers. The Japanese sniper is placed on the board at the end of the first Japanese player turn. The Drop Point (E9.12) of the southern group must be placed on/south of hexrow 38T/35N. Japanese squads have Assault Fire and Spraying Fire.

**AFTERMATH:** The several air raids which preceded the operation did not succeed in destroying the Allied anti-aircraft defense. Quickly one, then two planes were shot down in flames. Nevertheless the detachment assigned to capture P1 airfield landed safely in two sections, one of 60 men in a portion of cleared jungle to the north of the objective, and a second section of 80 men to the south. Whereas they got to their objective, the second group came upon a group of Dutch reinforcements which joined the airfield. A short fight with well aimed automatic weapons fire started, with the rakkasan butai (paras) killing several Dutch soldiers and dispersing the others. Finally with access to the airfield, the two groups launched a combined attack. By this time the element of surprise was past. The Bofors guns broke the spirit of the paratroops, and in spite of a violent fight, neither of the two sides gained the upper hand that afternoon. It was only with nightfall that the better trained Japanese managed to join up and drive the Allies out of the airfield and into the jungle.



# ROSES FOR VANDERVOORT

SCENARIO ASL TAC 47 Translated by Coastal Fortress Gaming Group

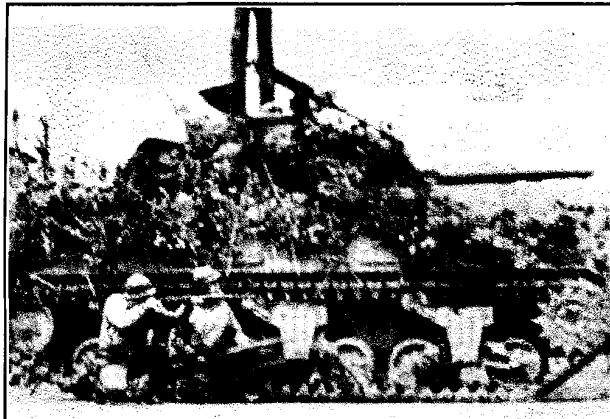

**VICTORY CONDITIONS:** The Americans win at scenario end if they control the 4 buildings W3, U5, S6 and S4.

## LES ROSIERS, FRANCE, 15 June 1944:

The encirclement of the German troops of the Cotentin had just begun the previous day. The 507<sup>th</sup> Parachute Infantry Regiment and the 325<sup>th</sup> Glider Regiment were engaged along the D15 Road who link Pont l'Abbe to St Sauveur le Vicomte. After a good start, a vigorous German counterattack stopped paratroopers cold. On the 15<sup>th</sup>, it was the turn of the 505<sup>th</sup> Parachute Infantry Regiment to attack after crossing the 507<sup>th</sup> positions. The 1<sup>st</sup> and 2<sup>nd</sup> Battalion rushed forward. The 1<sup>st</sup> Battalion attacked north of the D15, and the 2<sup>nd</sup> along the road itself. The 3<sup>rd</sup> Battalion was kept in reserve. The Germans stiffly resisted at first, but once this resistance was broken, the 505<sup>th</sup> advanced quickly. After 700m of progression, they met a fortified strongpoint in the Les Rosiers hamlet.

## BOARD PLACEMENT:

### BALANCE:

- ☆ Replace the 9-1 leader in the German OB with a 8-1 leader
- ⚡ Both 81 MTR in the American OB start the game dismantled

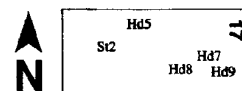

⚡ GERMAN sets up first	1	☆ 2	3	4	5	6	END
☆ AMERICAN moves first							

**Elements of 1<sup>st</sup> Battalion, 1058<sup>th</sup> Infantry Regiment, 91<sup>st</sup> Luftlande Division [ELR:3]**  
set up on/west of hexrow H {SAN:4}:

 4'-6-7 3	 4-4-7 2	 9-1 1	 7-0 1	 MG 7-18 2	 LMG 3-8 2	 MTR 50*(2-13) 10	 ? 7 mortar 10
-----------------	----------------	--------------	--------------	---------------------	---------------------	----------------------------	-------------------------

 AT 75 mm 2	 AA 37L (8) 2	 2-2-8 4
----------------------	------------------------	----------------

**Elements of Companies D,E and HQ, 2<sup>nd</sup> Battalion, 505<sup>th</sup> Parachute Infantry Regiment, 82<sup>nd</sup> Airborne Division [ELR:5]**  
set up on/east of hexrow F {SAN:2}:

 E 7'-4-7 8	 9-1 1	 8-0 1	 MG 4-10 2	 MTR 60*(3-45) 2	 BAZ44 8-4 2	 MTR 81* (3-75) 2	 2-2-7 2
----------------------	--------------	--------------	---------------------	---------------------------	-----------------------	----------------------------	----------------

**Elements of Company D, 505<sup>th</sup> Parachute Infantry Regiment and Company A, 746<sup>th</sup> Tank Battalion**  
enter on Turn 2 on/between O10 and A10 (the units must setup at 2 hex range from each other)

 E 7'-4-7 2	 3-3-7 1	 10-2 1	 BAZ44 8-4 2	 15 2/4/4 2
----------------------	----------------	---------------	-----------------------	----------------------

Scenario Design: Jean-Luc Béchenec '93

### SSR:

1. EC is moist with no wind at start
2. Place the following overlays: **St2** in Y6-X6, **Hd5** in Q9-R8, **Hd7** in F5-G5, **Hd8** in J3-J2 and **Hd9** in D3-E3. If you do not have Overlay **St2** which is in Croix de Guerre, you can remove it without influencing the balance of the scenario.
3. Walls and Edges are Bocage (B9.5), a 2-lane Stone Bridge exists in V7 and links V6 and V8. The openings through the bocage are treated as Breaches (B9.541).
4. Kindling is NA.
5. The American 81 MTRs may not setup emplaced.

**AFTERMATH:** Company D, heading the assault, was pinned down by the fire of two 37mm AAGuns and 2 75mm AT guns. The German position was held by 50 soldiers from the 1<sup>st</sup> Battalion of the 1058 Infantry Regiment, equipped with MGs and mortars. The accurate fire from the paratroopers forced the Germans to go for cover. Company E, supported by the 81mm MTR from the HQ Company succeeded in advancing and outflanked the German position. Nevertheless, the position seemed too tough to break without more support. Colonel Vandervoort then went to the 1<sup>st</sup> Battalion HQ and "loaned" 2 Shermans to Colonel Alexander. With a platoon of company D and the 2 Tanks, he outflanked and overran the German position. Most of the defenders were killed or captured and the others retreated. The progression resumed at such a speed that all German opposition seemed to vanish in front of the airborne troops. The road to St Sauveur le Vicomte was open.

# TRAPPED

## SCENARIO ASL TAC 48 Translated by Coastal Fortress Gaming Group



### LA PINETIÈRE, 4 Km east of RONCEY, FRANCE, 29 July 1944:

Operation Cobra, started 5 days earlier, was very successful. The remnants of two Infantry Divisions (the 91<sup>st</sup> and the 243<sup>rd</sup>), paratrooper elements of Corps Meindl, and particularly the major part of 2<sup>nd</sup> SS Panzer Division "Das Reich" and of the 17<sup>th</sup> SS Panzergrenadier Division "Gotz von Berlichingen" were trapped in the so called Roncey pocket. Their only hope was to break the American lines toward the south and the southwest in order to join the German front line. Several attempts failed in the night from the 28<sup>th</sup> to the 29<sup>th</sup>. On the morning of the 29<sup>th</sup> at 0900, a particularly strong attack started in La Pinetiere, a hamlet around a crossroads. Several hundred paratroopers and SS, supported by 15 Panzers, pushed back a company of the 4<sup>th</sup> Infantry Division, placed there in protection, 1 km in front of the 78<sup>th</sup> Armored Artillery Battalion of the 2<sup>nd</sup> Armored Division. Unable to retreat anymore, the GIs, now supported by 2 M7 batteries, 4 M10 and 2 M16, blocked the German progression.

### BOARD PLACEMENT:

			Hd3
11			Hd9 Hd5 Hd7
	Hd8		Hd10
17		Hd4	Hd2

### BALANCE:

♣ Replace the 8-1 Leader with a 8-0 leader in the American OB

☆ The US reinforcements enter on Game Turn 4.



**VICTORY CONDITIONS:** The Germans win immediately if they exit 25 VPs, among which 10 Infantry VP, along the eastern edge on/between 11GG5 and 17GG6. Prisoners do not count for exit VP purposes.

☆ SIMULTANEOUS set up	1	2	3	4	5	6	7	8	END
♣ GERMAN moves first									

**Elements of 4<sup>th</sup> Infantry Division [ELR:4]**  
set up on/between hexrows M and R {SAN:3}:

2	5	8-1	7-0	2	2
---	---	-----	-----	---	---

**Elements of 41<sup>st</sup> Armored Infantry Regiment**  
enter on Turn 5 along the east edge (see SSR5)

2	3	6 <sup>2</sup> -6-7	6 <sup>2</sup> -6-6	3-4-7	9-1	8-0	7-0	2
---	---	---------------------	---------------------	-------	-----	-----	-----	---

**Elements of 78<sup>th</sup> Armored Artillery Battalion, 195<sup>th</sup> Anti-Aircraft Weapons Battalion and of 702<sup>nd</sup> Tank Destroyer Battalion**  
set up on/east of hexrow S (see SSR4)

6	2	2	2	2
---	---	---	---	---

**Elements of Panzergrenadier Regiment "Deutschland", 2<sup>nd</sup> SS Panzer Division "Das Reich"[ELR:4]**  
set up on/west of hexrow L(see SSR 4) {SAN:2} (see SSR6):

3	10	2-6	5-1	8-1	8-0	2	2	4	2	2
---	----	-----	-----	-----	-----	---	---	---	---	---

**Elements of 6<sup>th</sup> Paratrooper Regiment and of 2<sup>nd</sup> SS Panzer Regiment**  
enter on Turn 1 along the west edge (see SSR6)

8	3	3	2	3	9-1
---	---	---	---	---	-----

**Elements of 78<sup>th</sup> Armored Artillery Battalion, 195<sup>th</sup> Anti-Aircraft Weapons Battalion and of 702<sup>nd</sup> Tank Destroyer Battalion**  
set up on/east of hexrow S (see SSR4)

3	2	3	2
---	---	---	---

Scenario Design: Jean-Luc Béchemec and Pascal Guet '93

### SSR:

- EC are moderate with no wind at start. Kindling is NA.
- Place the following overlays: **Hd3** in 11U1-U2, **Hd5** in 11U10-V9, **Hd9** in 11X7-Y7, **Hd7** in 11Z9-AA10, **Hd8** in 17I1-I2, **Hd6** in 17M5-M4, **Hd4** in 17P7-Q8, **Hd10** in 17Y6-Y5 and **Hd2** in 17CC8-CC9. Hills do not exist, all terrain there have their base Level at Level 0. Hedges and Walls are Bocage (B9.5). The opening in the Bocage hex-sides are Breaches (B9.541).
- Setup is simultaneous. Place a screen between the 2 players.
- The M7 HMC may not setup in Wood hexes. Their CA should be directed toward the west. Use British Priest(a) counters for the missing M7 HMC. The two 2-3-6 HS in the American OB may setup HIP, with all SWs stacked with them, in concealment terrain.
- The M3(MMG) inherent squad is a 6-6-7 (see US vehicle note 30).
- The German 8-3-8/3-3-8 are assault engineers and SS (their broken morale is raised by one). The German AFVs that should be recalled after a MA Disabled (only), stay in play (are not recalled) and count in the German VPs if they successfully exit.

**AFTERMATH:** The fight was incredibly violent. The M16s fired on the German infantry, decimating it. All the M7 105mm guns fired direct hits and the losses quickly increased in the German troops. During 30 minutes, the fight outcome stayed uncertain, but the American resources were not unlimited and the losses also increased among them. The defense begun to bend under the German repeated assaults, that desperately wanted to break the encirclement. When the conclusion seemed near, elements of the 41<sup>st</sup> Armored Infantry Regiment joined the fray and saved the American defense from collapsing. The bulk of the Germans was repelled in the pocket, leaving on the field 126 KIA and 9 tank wrecks. Only a few groups succeeded in escaping. For their part, the Americans did not communicate their losses on this action. But they had to have been at least as high as the Germans.



# BIG CATS AT BAY

SCENARIO ASL TAC 49 Translated by Coastal Fortress Gaming Group

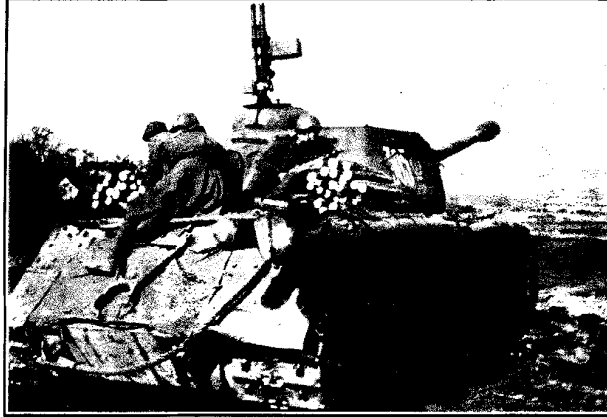

**VICTORY CONDITIONS:** The Russian wins at game end if they control all the multi-hex buildings on board 3. The Germans lose immediately if all their AFVs are destroyed or captured.

## GOLZOW, GERMANY, 22 March 1945:

The Vistula battle lost, the remnants of the German army reorganized behind the Oder-Neisse river, in the vain hope to stop the Red Army. The situation was even worse since the 5<sup>th</sup> Shock Army already secured a bridgehead on the western side of the Oder. The battle was raging inside Kuestrin. The 56<sup>th</sup> Panzer Corps was assigned to stop the Russians without delay. A Kampfgruppe was built and deployed on both sides of the highway that linked Kuestrin to Berlin. No less than 28 Tiger II and 28 Panthers were assigned to the Kampfgruppe. The morning of the March 22<sup>nd</sup>, at 0600, the Russian steamroller started again. The front blazed up and the first German lines were flattened under a shower of shells and rockets during more than 90 minutes. Nevertheless, when the Russians met the defense, the Grenadiers offered a stiff resistance. Only a few tanks were able to make it through. Two armored arrows were repulsed by the Panthers and Tiger II. The Russians suffered heavy losses and did not wait long before withdrawing. At the same time, north of this battle, a third Russian group headed toward Golzow. The village hosted the Battalion HQ and was only very lightly defended by five Panthers from the recon group supported by a thin Grenadier company. Still, the German commandant decided to take up the challenge...

### BOARD PLACEMENT:

### BALANCE:

★ The Russian OBAs given a pre-registered hex, secretly recorded before German setup

♣ Add 8 "???" to the German OB

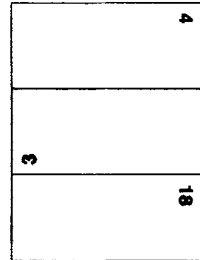

♣ GERMAN sets up first	★ 1	★ 2	★ 3	♣ 4	5	6	7	8	END
★ RUSSIAN moves first									

**Elements of the 1<sup>st</sup> Stabs Company, Panzer Battalion "Brandenburg" and of Panzer Anti-Aircraft Battalion "Kurmark", Panzergrenadier Division "Kurmark" [ELR:2]**  
 set up on board 18 on/west of hexrow H and/or on board 3 on/west of hexrow Z and/or on board 4 on/west of hexrow H in hexes numbered 2 {SAN:4}:

5-4-8	4-6-7	9-2	8-1	8-0	7-0	5-12	3-8	12-4	7 morale
4	6						3	2	8

15	16	16	16	8-1
4		3	4	

**Elements of 102<sup>nd</sup> SS Panzer Battalion**  
 enter on Turn 4 along the south edge OR along the west edge of board 18:

11
2

**Elements of the 5<sup>th</sup> Shock Army**  
 enter on Turn 1 on/between 4G10 and 3GG6:

16	8-1
6	

**Support elements of the 5<sup>th</sup> Shock Army [ELR:4]**  
 enter on Turn 2 on/between 4G10 and 3GG6 {SAN:3}:

13	9-1	6-2-8	8-1	2-8
2		2		

enter on turn 3 on/between 4G10 and 3GG6:

6-2-8	5-2-7	9-1	8-1	8-0	2-8	1-12	13	15
4	10				4	2	2	2

Scenario Design: Jean-Paul Goncalves

### SSR:

1. EC are wet with no wind at start.
2. Level 2 Hill hexes are Level 1 hill hexes.
3. Board 3 undergoes a pre-game bombardment.
4. The Russian player receives a 120mm+ OBA module with plentiful ammo with an offboard observer secretly placed before German setup on a Level 2 edge hex on/between 3GG and 4A10. This module may not use more than 2 missions; at least one of the two must be a smoke mission.
5. Russian squads have a PF capability with an Availability number of 1. These SWare inherent (C13.31) but Captured Use does apply. The other PF rules apply normally.
6. One German squad equivalent and all Leaders/SWs stacked with it may setup HIP. The German AFVs may not setup in buildings. Kindling and Bore Sighting are NA. The SPW 251/21 is a vehicle that came with the KGPI module. If it is not available, you may replace it with a SdKfz 7/1.

**AFTERMATH:** Under the Russian artillery fire, the Panzers had problems regrouping in Golzow. The Russians added to the confusion on the German side by firing a thick smoke screen at the edge of the village. The defenders had barely pulled themselves together when the first T-34 emerged from the smoke. But blinded and without their supporting infantry, the first beasts roaming the streets were easy prey. Supporting each other, Grenadiers and Panzers isolated and destroyed the tanks of the first wave one by one. But after the T-34 came the Stalins and assault guns loaded with infantry riders. The fights were extremely violent and the losses dreadful. When all seemed lost, some Tiger II called on for help joined the fray. Under the shock, the Russians lost their nerve and finally withdrew. The breakthrough attempt ended in a bitter failure. That would nevertheless be only a respite before the unavoidable conclusion.

# TASK FORCE SMITH

SCENARIO ASL TAC 50 Translated by Coastal Fortress Gaming Group



**VICTORY CONDITIONS:** North Korea wins at game end if they control 20 of the 30 hexes Level 3.

## Near OSAN, SOUTH KOREA, 5 July 1950:

On 25 June 1950, Communist North Korea invaded its southern neighbor. Nothing seemed to stop the North Korean advance and to show US determination. Led by numerous veterans of the WWII fights against the Japanese. On the 30<sup>th</sup>, The Americans decided to send some troops and McArthur packed the Japan-based 30<sup>th</sup> Infantry Division to South Korea. A preliminary detachment was assigned to slow the North Korean advance and to show US determination. Led by Lieutenant-Colonel Smith, this task force was composed of two depleted companies supported with some heavy mortars and recoilless guns. Some of the troops and officers had participated in WWII combat. The Task force arrived in Pusan on July 1<sup>st</sup>. The refugee columns and the monsoon's heavy rains hampered his progression to the front line. One artillery battery joined them on the 4<sup>th</sup>. On the morning of the 6<sup>th</sup>, an armored column coming from the north appeared... It was made up of 33 T34s that crossed the Americans positions without damage despite the defenders heavy fire. American losses were light and the situation became quiet again around 0900. One hour later, a new column appeared in the rain; 3 T34s, then trucks and infantrymen in a several kilometer wide column. This was the first fight of the cold war.

## BOARD PLACEMENT:

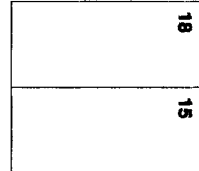

## BALANCE:

- ★ Add a Leader 8-1 to the North Korean group that enters on turn 1.
- ☆ Replace an 8-0 Leader with a 8-1 Leader in the American OB

☆ AMERICAN moves first	★ 1	2	3	★ 4	5	★ 6	7	8	9
★ NORTH KOREAN sets up first									

**B & C Companies, 1<sup>st</sup> Battalion, 21<sup>st</sup> Infantry Regiment [ELR:3]**  
set up on board 15 (see SSR3) {SAN:4}:

6 <sup>2</sup> -6-6	5 <sup>2</sup> -4-6	9-5	8-0	7-0	8-16	4-10	8-4	3-45	75	8
4	16		2		2	3	4	2	2	

107 (14-100)	2-2-7
2	2

**Elements of 16<sup>th</sup> and 18<sup>th</sup> Infantry Regiments, 4<sup>th</sup> Division and of 107<sup>th</sup> Tank Regiment [ELR:4]**  
enter on Turn 1 along the north edge (see SSR 4) {SAN:2/4 (see SSR5)}:

6-2-8	4-5-8	9-1	8-1	8-0	8-12	2-8	10-...	16 85L 2/4
5	10				2	5	2	3

enter on Turn 4 on/between 15GG4 and 15GG7:

6-2-8	4-5-8	8-1	2-8
3	3		

enter on Turn 6 on/between 15A4 and 15A7:

6-2-8	4-5-8	8-1	2-8
3	3		

Scenario Design:Philippe Naud '93

## SSR:

1. EC are wet with no wind at start, the weather is Overcast with Heavy Rain (E3.51). The Rain can never stop: on a Wind Change DR of 3, the rain intensity stays or becomes normal. Kindling is NA. No buildings or Gully or Bridges exist. The only existing road is the 18Q10-18Q6-15R9-15Y1 Road.
2. The Americans receive a 100+mm OBAmodule (HE only) with Scarce Ammunition.
3. The 75\* RCL can be used by Squads/HS without Non-Qualified Use penalties. All American units (EXC: 107 MTRs) may setup in foxholes of appropriate size. The American player must set up 8 squad equivalents on/west of hexrow V and 8 Squad equivalents on/east of hexrow S.
4. The North Koreans are considered Russians only for HOB DRMs (i.e.: Human Wave and deployment are not allowed). The 4-5-8 squads have Assault Fire and Spray Fire capabilities. The 60mm dm MTR is a Chinese MTR. The North Koreans may use all Russian SWs, Chinese SWs and American 60mm MTR (M2) without Captured Use penalties.
5. The North-Korean SAN is increased from 2 to 4 as soon one North Korean MMC enters the playing area on Turn 4.
6. Place 3 T34 Wrecks in the following hexes: 15S7, 15T4 and 15V2. The North Korean player then determines with random selection which one is burning (a tie may result in more than one burning).

**AFTERMATH:** MTRs and Heavy MG fire stopped the column 900 meters before the American positions. The North Koreans then deployed and the T34s opened fire. All frontal assaults were broken by the GI's firepower. But around 1230, a flanking move threatened the left wing of the Task Force, and Smith regrouped his troops east of the road. Then the Americans were also engaged on their right wing. After two hours of fighting, without contact with the artillery and close to being encircled, Smith ordered a withdrawal. The heavy weapons Guns and wounded had to be abandoned. Mass confusion developed and many Americans were killed or captured, but the North Koreans were content with seizing the position and did not pursue the GIs. In a half-day of fighting, Task Force Smith lost a third of its initial effectiveness (540 men at start). The next day, the UN installed Douglas McArthur as the UN troop commander in Korea.

# STRENGTH THROUGH UNITY

## SCENARIO ASL TAC 51

Translated by Coastal Fortress Gaming Group



### OOSTROZEBEKE, BELGIUM, 26 May 1940:

At the end of May 1940, the Belgian army was in dire straits and backed into the western part of the country. However, the German advance was anything but a cakewalk. The Lys river line was stubbornly defended by Belgian troops whose zeal was reminiscent of their fathers' 25 years earlier on the Yser. Near Oostrozebeke, the Germans managed to penetrate the 8<sup>th</sup> division's front. They used civilians as human shields and infiltrated through grain which was already tall enough to provide cover. Infantrymen of the 21<sup>st</sup> Line Regiment fell back and fought side by side with the gunners of the 5<sup>th</sup> Artillery who had to blow up their own guns. Major Leclerq, commanding officer of the 1<sup>st</sup> Battalion of the 21<sup>st</sup>, decided to counter-attack with a combined force of infantrymen, gunners and engineers. At 1830, the bugles signaled the charge.

### BOARD PLACEMENT:



(Only hexrows R to GG are in play)

### BALANCE:

☉ In the Victory Conditions, replace 10 VP with 8 VP.

♣ Add two 1S Foxholes to the German OB.

**VICTORY CONDITIONS:** The Belgians win at game end if they have 10 VPs of GO units on/east of hexrow CC.

♣ GERMAN sets up first	①	2	3	4	5	END
☉ BELGIAN move first						

**Elements of 1<sup>st</sup> Battalion, 455<sup>th</sup> Infantry Regiment [ELR:3]**  
set up on/between hexrows V and X {SAN: 3}

1 4-6-7	1 2-4-7	8-1	7-0	2 5-12	1 3-8	3 50 * [2-13]
------------	------------	-----	-----	-----------	----------	------------------

6

**Elements of 1<sup>st</sup> Battalion, 21<sup>st</sup> Line Regiment, of 4<sup>th</sup> Group,  
5<sup>th</sup> Artillery Regiment and of 10<sup>th</sup> Engineers Regiment. [ELR:3]**  
enter on Turn 1 on the west edge {SAN: 2}

1 4-5-7	G 4-3-7	9-2	8-0	2 4-11	2 50 * [4-14]
------------	------------	-----	-----	-----------	------------------

8      4

*Scenario Design: Philippe Naud '94*

### SSR:

1. EC are Moderate with no wind at start. Bore Sighting and Kindling are NA.
2. Grain is in season

**AFTERMATH:** The officers moved daringly ahead of their men to lead them forward. Captain-commandant Renkin, cane in hand, gave direction to the mixed formation. Despite murderous enemy fire, the Belgians advanced some 700m and pushed back the Germans, forcing them to defend themselves. No fewer than 46 of the advancing men were killed, including Renkin. By nightfall, the overall situation forced the Belgians to relinquish the ground they had just recaptured. Major Leclerq ordered that arms be presented to the fallen: once united in action, they were now united in death.

# THE ARMY AT THE END OF THE WORLD

SCENARIO ASL TAC 52 Translated by Coastal Fortress Gaming Group

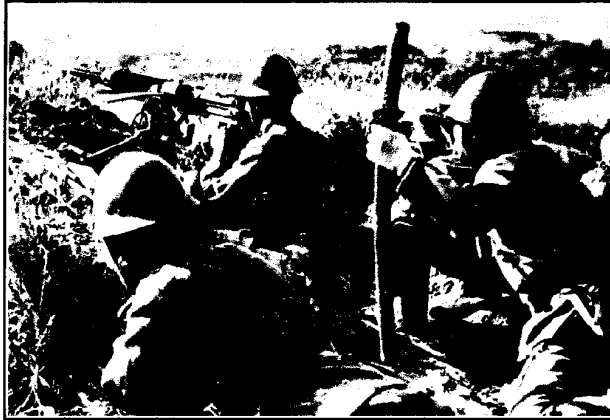

**VICTORY CONDITIONS:** The Japanese win at game end if they have amassed 10 CVP more than the French and if they Control at least one Pillbox. Control or destruction of a Pillbox is worth 5 CVPTo the Japanese.

## NA CHAM Border Post, INDOCHINA, 25 September 1940:

In order to cut the Chinese supplies, the Japanese "Canton" army wanted to control French Indochina, which had been left to fend for itself ever since the defeat of June 1940 and the armistice in France. After weeks of diplomatic pressure and border "incidents", an agreement was signed, allowing Japanese troops to enter the country while maintaining French sovereignty and a French military presence. But on the very day the agreement was signed, Japanese troops attacked border posts from the north and attempted to disarm the French garrisons. On September 23, at Na Cham, a Japanese column tried to force its way onto Colonial Highway 4. With no precise orders from above, the local commander decided not to submit, and refused the Japanese permission to go through. The next day, a stronger Japanese attack was beaten back with heavy losses to the attackers. Overnight, a section, under Lt. Séguin, came out of the fort, crossed the highway and established itself on the Ban-Tich hilltop, in case the Japanese renewed their attack on the following day.

### BOARD PLACEMENT:

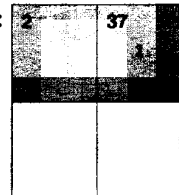

### BALANCE:

- Replace the MMG with a HMG in the Japanese OB.
- ⊙ Add a MMG to the French OB.

*Only hexrows A to P are in play*

⊙ FRENCH sets up first	1	2	3	4	5	6	7	END
● JAPANESE moves first								

**Elements of the 10<sup>th</sup> Company, 9<sup>th</sup> Colonial Infantry Regiment (Cpt. Carli) [ELR: 3]**  
set up on board 2, on/north of hexrow H in hexes numbered 2 and 7 {SAN: 3}

10

4-5-7

9-2

8-0

4-11

2-8

3-42

81\* [3-71]
 2-2-8

**Outside Section (Lt. Séguin)**  
set up 3 hexes from 37G5 (hill 615)

4-5-7

9-1

2-8

**Elements of 5<sup>th</sup> Division [ELR: 3]**  
set up 3 hexes from 37B10 {SAN: 3}

8

4-4-7

2-2-8

10-1

8-0

4-11

2-8

50\*[1-18]\*

30-1

70\* [(3)-70]
 2-2-8

**5<sup>th</sup> Division Reinforcements**  
enter on Turn 3 on the north edge:

4-4-7

9-1

8-0

2-8

30-1

*Scenario Design: Laurent Closier*

### SSR:

1. EC are Moderate, with no wind at start. PTO Terrain is in play but:
  - Woods/Jungle are Brush.
  - Swamps are Marsh.
  - The Stream is Dry
2. Place Overlay 2 on 37D2-D1
3. The French 60mm mortar suffers from Ammunition Shortage. The 81\* mortar is a Stokes; its B# is 11 and it has a ROF of 2.
4. Starting from Turn 5, Good Order French units may exit the west edge. Units exited by the French do not count toward Japanese CVP.
5. The fortifications may not set up HIP, the Pillboxes must have a LOS on 1 hex of the northern edge

**AFTERMATH:** Early in the morning, Séguin's men spotted a pair of guns sporadically firing on the fort as well as soldiers slowly unloading from 30-odd trucks and preparing to launch an attack. Opening up with great accuracy, the MG of this outpost section neutralized the guns. At that point, the Japanese commander then turned his men around and they started assaulting the hilltop. But across the road, the Colonials in the fort reacted to this move and their mortars caught the moving Japanese from the rear. The Japanese soon had had enough and retreated to the north. Taking the advantage of the break, Séguin's section returned to the fort. Despite this success, the situation remained difficult because ammunition was short. Late in the afternoon, the commander decided to fall back, leaving a few volunteers to watch over the wounded. The Japanese would massacre them all when they finally took the fort.

# PYRRHIC VICTORY

## SCENARIO ASL TAC 53 Translated by Coastal Fortress Gaming Group

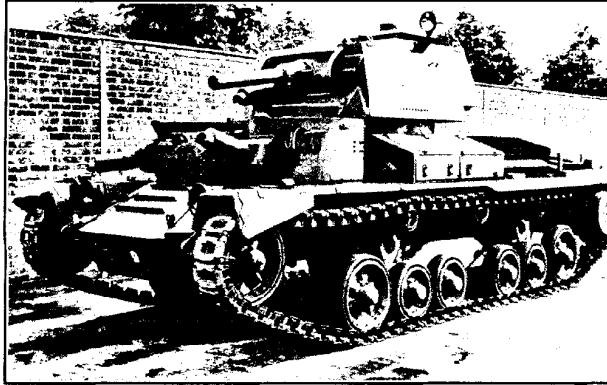

### MAVROPIYE, GREECE, 13 April 1941:

On April 8, just two days after the start of the German offensive, it became obvious to General Wilson, commanding officer of the Imperial Expeditionary Force, that the Greeks would not be able to resist enemy pressure much longer. Consequently, he decided to re-deploy his forces to the south, along a shorter defensive line, anchored on wooded mountains and easier to defend. But he needed time to do so. Several units were detached from the IEF and placed under General Mackay. They started blowing up a series of bridges, managing to greatly slow down the Panzer Divisions. Even this was not enough though, and Mackay fought a first (and successful) blocking action at Vevi. Encouraged by the result, he decided to try again. 35 km to the south, at Ptolemais, a natural anti-tank ditch cut across the South road. This looked like the perfect spot from where to try stopping the onrushing Panzers. The clash was not long in coming. On the morning of the 13<sup>th</sup>, the 4<sup>th</sup> Hussars forward observation posts beyond the ditch came under heavy attack. The Germans quickly realized that it would be impossible to force their way through. A glance at the map indicated a possible solution: a trail bypassed the obstacle, but the ground was swampy and seemed impassable for the Panzers. Nonetheless, it was the only way out and had been attempted. A few hours later the first German tanks showed up on the British flank...

**VICTORY CONDITIONS:** The Germans win at game end if they Control every multihex building on board 3 or they win immediately upon exiting 25 CVP on the east edge.

### BOARD PLACEMENT:

#### BALANCE:

- ♣ The DB is Recalled at the end of Turn 4 (SSR 4).
- ⊙ Add a MMG to the initial British OB

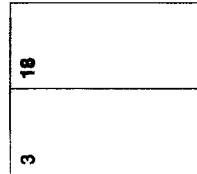

⊙ BRITISH set up	♣	⊙	♣	⊙	1	2	3	4	5	6	7	8	END
♣ GERMAN moves first													

### Elements of 1<sup>st</sup> Armoured Brigade HQ and of 2<sup>nd</sup> RHA L/N Battery [ELR: 4]

set up on/east of hexrow K and, on mapboard 18, in hexes numbered 9 (see SSR 2) {SAN: 3}:

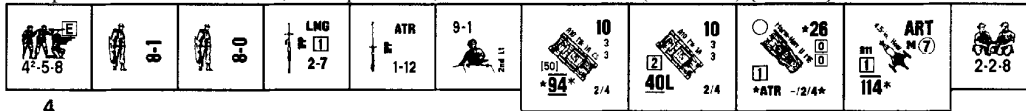

4

2



Elements of A Troop, Northumberland Hussars, 102<sup>nd</sup> Anti-Tank Regiment set up on/east of hexrow K:



Elements of B and C Squadrons, 4<sup>th</sup> Hussars Regiment enter on Turn 1 on/between 18Q1 and 3GG6:

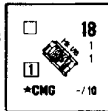

Elements of A Squadrons, 3rd RTR enter on Turn 2 on/between 18Q1 and 3GG6:

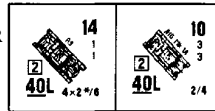

2

3

2

Elements of 2<sup>nd</sup> and 3<sup>rd</sup> Platoon, 27<sup>th</sup> New Zealand MG Battalion enter on Turn 5 along the east edge:

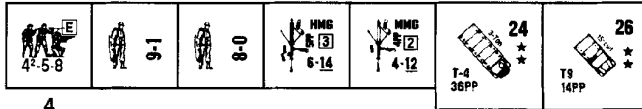

4



Elements of 33<sup>rd</sup> Panzer Regiment, 9<sup>th</sup> Panzer Division enter on Turn 1 along the west edge (see SSR 3):

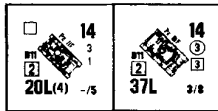

3

2

### 9<sup>th</sup> Panzer-Division reinforcements [ELR: 4]

enter on Turn 2 along the west edge (see SSR 3) {SAN: 2}:

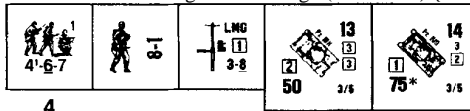

4

2

### 9<sup>th</sup> Panzer-Division reinforcements

enter on Turn 3 along the west edge:

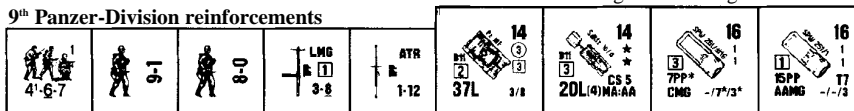

9

2

3

Scenario Design: Jean-Paul Goncalve '94

### SSR:

1. EC are Ground Snow, with a Mild Breeze from the northeast at start. Roads are plowed.
2. The A10 MkiACS Cruiser has HE9 with an FP equivalent of 12FP only and a Basic TK# of 7. It thus has Functioning MA for Overrun purposes.
3. German vehicles entering on Turns 1 and 2 have already spent half their MP allowance (FRD). The German Sniper may not be activated prior to Turn 2.
4. The Germans receive automatic Air Support on Turn 1 in the form of one DB39 with bombs. This DB is Recalled at the end of game Turn 3.
5. Starting from Turn 3, dusk causes a +1 LV Hindrance to all fire.

**AFTERMATH:** The fighting started right away. Two Hussars squadrons threw themselves at the Germans without further ado: the action turned into a slaughter. Despite their bravery, Sir Winston's Hussars were felled one after the other. Nevertheless, the German victory did not last very long. Rushing straight for the 1<sup>st</sup> Armoured Division's HQ, the Panzers stumbled upon the 2-pdrs of the 102<sup>nd</sup> Northumberland Hussars. Eight tanks were quickly knocked out and the German momentum was broken. And that was not the end of it. Two Cruisers squadrons, coming to help, set another five on fire within a few minutes. However, Brigadier General Charrington, the Brigade's commanding officer judged that it would be safer to withdraw without delay. Night was falling and it would be easier to disengage under the cover of darkness. Immediately, gunners and infantrymen started falling back and once again, Mackay Force escaped. But losses had been heavy. Too heavy in fact, for what proved to be the 1<sup>st</sup> Armoured Brigade's first, and last, action.

# IN THE NAME OF ROME

SCENARIO ASL TAC 54 Translated by Coastal Fortress Gaming Group



**JASNAYA POLYANA, USSR, 12 August 1941:**

Mussolini, furious at not having been told of Barbarossa's launch ahead of time, wanted his share of glory in the "anti-bolshevik crusade". He thus sent the 3-division CSIR (Corpo Spedizione Italiano in Russia) Italian Expeditionary Corps in Russia to join the fray. The Italians were sent to Ukraine where they acted as a buffer between the Rumanians and the Hungarians. Early in August, the CSIR was committed to the front. Pasubio Division was ordered to advance toward the Boug river in order to cut off retreating Soviet forces. A vanguard was put together using the Roma Regiment as its core, and various supporting units. On the 11<sup>th</sup>, contact was made with the enemy. The next afternoon, the point battalion met heavy resistance near the village of Jasnaya Polyana. Violent fighting ensued and the Italian Commandant was put out of action. The main elements of the column were still far away and Colonel Chiaramonti, Roma's CO, intervened to take control of the situation.

**BALANCE:**

☛ Exchange two 3-4-6 for two 4-4-7 in the Italian forces that set up on board.

★ Delete the initial Automatic Battery Access (SSR 3).

**BOARD PLACEMENT:**



10
16

**VICTORY CONDITIONS:** The Russians win if at game end the Italians Control 15 buildings on mapboard 10, on/east of hexrow Q. The Russians win immediately upon amassing 25 CVP.

★ SOVIETS set up first	☛ 1	☛ 2	☛ 3	4	☛ 5	6	7	8	END
☛ ITALIAN moves first									

**★ Elements of 469<sup>th</sup> Infantry Regiment [ELR: 2]**  
set up on/east of hexrow Q {SAN: 4}:

12				2	2	2		8

		6

**☛ Elements of 1<sup>st</sup> Bersaglieri Motorcyclist Company, 1<sup>st</sup> Battalion, 80<sup>th</sup> Infantry Regiment [ELR: 3]**  
set up/enter as indicated {SAN : 3}.

Set up on board 10, on/west of hexrow M:

4	7			3	2			

Enter on Turn 1 on the west edge of board 10:

4			2

Enter on Turn 3 on the south edge:

6		

Enter on Turn 5 on the North edge:

2	

*Scenario Design: Philippe Naud '94*

**SSR:**

- EC are Moderate, with no wind at start. Kindling is NA. All buildings are wooden.
- The Russians receive a 70+ mm OBAModule (HE only) with Normal Ammunition.
- Starting on Turn 2, the Italians receive a 70+ mm module (HE and smoke) with Normal Ammunition and an Offboard Observer secretly recorded during the Italian Turn 2 RPh at Level 2 along the west edge. The first Battery Access draw is automatic (withdraw a black chit from the Draw Pile).

**AFTERMATH:** The situation being urgent, the remainder of the supporting company were sent forward and artillery support was requested. Russian guns and mortars broke up the assault attempts. However, Lt. Mori's 3<sup>rd</sup> Company outflanked the defenders, forcing them to fall back. Lt. Carbonari's group, made up of HQ Company personnel, intervened just as the Russians were in full retreat. The village fell by 1930. In his report, Colonel Chiaramonti praised the behavior of his regiment as heroic and worthy of its motto "Nel nome di Roma" ("In the name of Rome"). The truth is that the Russian rearguard had successfully delayed Pasubio's advance.

# DANGEROUS CROSSROADS

SCENARIO ASL TAC 55 Translated by Coastal Fortress Gaming Group



## South of MATEUR, TUNISIA, 25 November 1942:

Operation Torch had brought war to the Maghreb. Anglo-American mechanized columns were racing for Tunis, and had crossed the Algeria-Tunisia border with the goal of capturing the Tunisian capital before the Axis was reinforced. Blade Force, with the 17<sup>th</sup>/21<sup>st</sup> Lancers as its core, was one of the many groups advancing eastward despite the bad weather and enemy roadblocks. Germans and Italians were desperately trying to gain time to concentrate their forces for a counter-attack. A first roadblock, manned by troops of the Italian 92<sup>nd</sup> Infantry Regiment was swept aside during the night of November 24. Major Witzig, CO in the Mateur area, sent the rest of 9<sup>th</sup> Company to block a crossroads on the roads to Mateur and Tebourba. The next morning, British armoured cars found the enemy and by 1000, C Squadron, 17<sup>th</sup>/21<sup>st</sup> Lancers attacked, supported by the only infantry company in Blade Force.

**VICTORY CONDITIONS:** The British win if at game end they control buildings 11Q3 and 11I6, provided they have suffered <30 CVP.

**BOARD PLACEMENT:**

**BALANCE:**

- Add a 7-0 to the reinforcements entering on Turn 2.
- ⊕ Add a DC to the German OB and a LMG to the Italian OB.

↑ N

11
16

⚔️ **SETUP is simultaneous (see SSR4)**

○ **BRITISH moves first**

1	2	3	4	5	6	7	END
---	---	---	---	---	---	---	-----

**Elements of 9<sup>th</sup> Company, 3<sup>rd</sup> Battalion, 92<sup>nd</sup> Infantry Regiment [ELR: 2]**  
set up on board 11 {SAN: 4}:

4-4-7	8-0	8-0	2-10	2-5	2-13
9	2				

**Elements of 557<sup>th</sup> Group of Semoventes**  
set up on board 11:

12-3
3

**Elements of Witzig's paratrooper pioneer Battalion [ELR: 5]**  
set up on board 11:

8-3-8	8-0	3-1	1-12	30-1	12 factors
4					

**B Company, 1 Battalion, the Rifle Brigade [ELR:3] and elements of C Squadron, 17<sup>th</sup>/21<sup>st</sup> Lancers**  
Enter as indicated {SAN: 2}.

Enter Turn 1 on the south edge, between O10 and S10:

4-5-7	2-4-7	8-0	2-7	1-12	5mm	16-0	16-0	16-0	16-0
3									

Enter Turn 1 on the south edge on/between Y10 and CC10:

4-5-7	2-4-7	8-0	1-12	5mm	16-0	16-0	16-0	16-0
3								

Enter Turn 1 on the south edge on/between I10 and Y10:

10-3	15-3	8-1
2	3	

Enter Turn 2 on the south edge:

4-5-7	8-0	2-7	1-12	15-4
6				

Scenario Design: Philippe Naud '94

- SSR:**
- EC are Moderate, with no wind at start. Kindling is NA. Woods are Olive Groves. These Olive Groves are not inherent Terrain and only the Woods depiction is treated as Olive Groves. They are considered Woods during the RtPh.
  - 8<sup>3</sup>-3-8/3-3-8 are Assault Engineers.
  - Each Carrier carries a 2-4-7 HS as per D6.82
  - The defender's on-map set-up and the attacker's offboard set-up are simultaneous. Install a screen between the players.
  - Remember that Surrender cannot be rejected in North Africa.

**AFTERMATH:** A few Valentines bogged down in a wadi, but the majority of the squadron reached the crossroads where it came under fire from the Semoventes concealed near the farms dominating the road. A Valentine and a Crusader were damaged but the Italian AFV were quickly knocked out. The defenders' fire stopped the infantry dead in its tracks and a Carrier was blown up by a mine. Despite armor support, the attack bogged down, and the reserve infantry section and the close support Crusaders had to enter the fray to dislodge the German Pioneers and the Italian infantrymen. The last defenders surrendered at around 1300. Their resistance had bought some time for the Axis.

# THE FOX' OFFSPRING

SCENARIO ASL TAC 56 Translated by Coastal Fortress Gaming Group



**JEBEL EL GUESSA, TUNISIA, 6 December 1942:**

Violent German counter-attacks early in December did not prevent the Allied High Command from preparing a renewed assault on Tunis. But the enemy had the initiative and was trying to break through in the direction of Medjez-el-Bab. The planned advance was to proceed on the south bank of the Medjerda river. Only a few hills stood out on this tank-friendly country. The high point was Jebel El Guessa. This sector was defended by elements of Combat Command B of the 1<sup>st</sup> Armored Division. The defenders were infantrymen and gunners, with tanks held in reserve. On December 5, the Americans observed German preparations. At 0800 the next day, the attack started, after the defenders had been hit hard by two waves of Stukas.

**BOARD PLACEMENT:**

4	18	
		52

**BALANCE:**

♣ Replace a PzIVF2 with a PzIVH in the German OB.

☆ Add a Baz 43 to the US OB



**VICTORY CONDITIONS:** The German wins at game end if he has exited 20 VP along the north edge of board 18, provided he has accumulated 10 Casualty VP more than the American.

☆ AMERICAN sets up first	♣ 1	2	♣ 3	☆ 4	5	6	7	8	END
♣ GERMAN move first									

**Elements of HQ Coy and C Coy, 6<sup>th</sup> Armored Infantry [ELR :2]**  
set up on board 25 on/north of hexrow K and on board 18 on/north of hexrow W (see SSR 3) {SAN: 3}:

6-6-6	3-4-6	8-1	8-0	MTR 60 3-45	BAZ43 8-4	2-2-7	AT M12 37LL	20 9PP *AAMG -/-/8*	20 15PP *AAMG -/-/4*	20 10PP *AAMG -/-/12*	19 75 * -/-/4*
-------	-------	-----	-----	-------------	-----------	-------	-------------	---------------------	----------------------	-----------------------	----------------

8

**Elements of Battery C, 27<sup>th</sup> Armored Field Artillery Battalion**  
set up with 6th Arm. Inf (see SSR 5):

37 9PP *AAMG -/-/4	15 WPS 15-57 105 CS 4 -/-/74*	20 37LL -/-/8*
--------------------	-------------------------------	----------------

3 2

**Elements of Battery B, 27<sup>th</sup> Armored Field Battalion**  
enter on Turn 3 on the west edge:

14 105 -/-/4
--------------

2

**Elements of 1<sup>st</sup> and 2<sup>nd</sup> Battalion of 3<sup>rd</sup> Armored Regiments** enter on Turn 4 on the west edge:

18 37LL 2/4/2	13 875 M 37LL 2/4/2*
---------------	----------------------

4 2

**Elements of Kampfgruppe Koch (7<sup>th</sup> Panzer Regiment and 5<sup>th</sup> Paratrooper Regiment) [ELR: 4]**  
enter on Turn 1 on southeast edge between 25R10 and 18GG6 {SAN: 2}:

4-6-8	10-2	8-1	8-0	MMG 5-12	LMG 3-8	ATR 1-12	Radio 8	9-1	14 75L 3/5	13 75L 3/5	18 9PP AAMG -/-/3
-------	------	-----	-----	----------	---------	----------	---------	-----	------------	------------	-------------------

9 2 3 2

**Elements of 7<sup>th</sup> and 86<sup>th</sup> Panzer-Grenadier Regiment [ELR: 4]** enter on Turn 3 on southeast edge between 25R10 and 18GG6:

4-6-8	9-1	8-0	LMG 3-8	MMG 5-12	16 77PP *AAMG -/-/3*	16 77PP *AAMG -/-/3*	13 50L 3/5	13 75L 3/5	13 50L 3/5	13 50L 3/5
-------	-----	-----	---------	----------	----------------------	----------------------	------------	------------	------------	------------

7 2 2 2 2 2

Scenario Design: Jean-Paul Gonçalve '94

**SSR:**

- EC are Moderate, with a Mild Breeze to the southwest at start. Woods and Orchards are Olive Groves. Olive Groves in hex depicted as Woods are considered Woods during the RHP; they are not Inherent Terrain and only the Woods depiction is treated as Olive Groves. Hedges are Cactus Hedges. All buildings are stone buildings. There are no roads.
- All US 75 and 37LLAmmunitions have their TK# reduced by 2: training ammunition was being used.
- The US player may remove the MG from his M2 (not the M2 GMC 37LL, see SSR 5), M3, M3(MMG) and Jeep and may disembark their Crews, but, at Set-Up, such MG must be possessed by units otherwise allowed to remove them from the vehicles. Furthermore, vehicles so abandoned must set up in the same Location as, or adjacent to, their Crew. The US player may not voluntarily destroy his vehicles (D5.411). US MMCs may set up in foxholes of appropriate size, if otherwise allowed.
- After Set-Up, each US MMC undergoes a PTC, with no other result applied than Pin, if failed.
- The M2 GMC 37LL is a M2 half-track with a 37LLMA. (The 37LL's C7 and its ROF are retained, but the MAIs Turreted: this is not a Portee). The vehicle's MG are retained with all their characteristics, but, if the MAIs fired, only one of the MG may fire during the same fire phase. None of the vehicle's MG may be removed. No Passenger may be carried by this half-track. Place a turret marker to distinguish it from a normal M2.
- The German receives an 80+mm Battalion MTR OBA module. Air support is also available to the Germans as a single DB42 with bombs which enter play as per E7.2. The plane can remain in play for 3 Turns.

**AFTERMATH:** C Company of the 6<sup>th</sup> Armored Infantry Battalion and Battery C of the 27<sup>th</sup> Armored Field Artillery Battalion held the south sector of the jebel. The Germans tried blocking the Americans' retreat to the Bordj Toun bridge. The American infantry was scattered by the attack but Battery C's intervention stopped the panzers. However, enemy fire, especially MG fire, decimated the T19 and M2 GMC crews. Having knocked out 8 tanks, the survivors surrendered. The M7's of Battery B then moved forward but they couldn't contain the German attack. 13<sup>th</sup> Armored Regiments reinforcements, although they outnumbered the enemy, were late in arriving and then went on the attack with no intelligence about the enemy. A light tank battalion reinforced with M3 medium tanks attacked from the east and the west, but the east detachment was delayed. The other detachment came under concentrated anti-tank fire and retreated after losing 5 M3A1. The American defenders fell back toward Jebel bou Aoukaz, 6 kilometers to the rear. The Americans' poor coordination had compounded the limitations of their tactics and of their equipment. The Germans had proven themselves worthy spiritual heirs of Rommel.



# LAST FIGHT

SCENARIO ASL TAC 57 Translated by Coastal Fortress Gaming Group

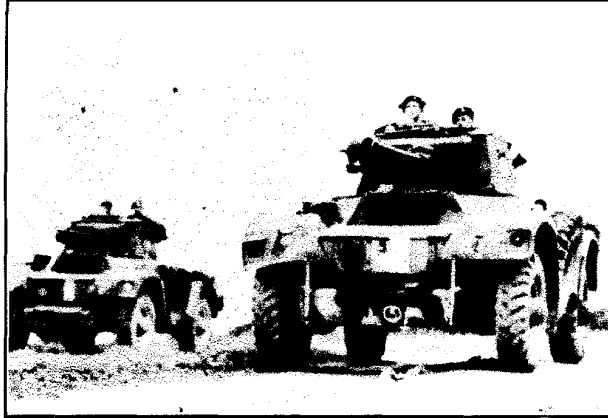

**VICTORY CONDITIONS:** The Allies win if there are no unbroken German MMC 4 hexes from 17R4 at game end.

## Near BOU SAADIA, TUNISIA, 31 January 1943:

Since January 18<sup>th</sup>, French troops in Tunisia had been being roughed up by a violent enemy offensive which aimed at gaining control of the western ridge, thus impairing Allied attacks and giving some breathing room to the Axis. Poorly equipped, the French forces, including the 7<sup>th</sup> Moroccan Skirmisher Regiment, had to give up ground. After the 25<sup>th</sup>, the situation improved, due in part to the terrain which was more hilly and in part to the intervention of Anglo-American reinforcements. Intense fighting took place on the road to Ousseltia. The Germans were worried and they launched yet another attack on the 31<sup>st</sup>. 11<sup>th</sup> Company, 7<sup>th</sup> RTM, installed on Wadi Drijda was forced to withdraw by the Gebirgsjägers fighting along side the panzers. The enemy was infiltrating towards the road the to Bou Saadia crossroads. The Commandant of the 3<sup>rd</sup> Battalion of the 7<sup>th</sup> RTM ordered his 9<sup>th</sup> Coy to counterattack with British armored cars in support.

**BALANCE:** **BOARD PLACEMENT:** 









OG3	17
B5	OG2

- ☉ Replace a 9-1 with a 9-2 in the French OB
- ☙ Add a 2-4-8 HS and a 50mm Mortar to the German forces setting up on/east of hexrow T

☙ GERMAN sets up first	☉ 1	2	3	4	5	6	END
☉ ALLIES moves first							







**Elements of 756<sup>th</sup> Gebirgsjäger Regiment [ELR: 4]**  
set up on/east of hexrow T, in hexes numbered 4 {SAN: 3}:

 4 <sup>2</sup> -6-8	 2-4-8	 5-1	 8-0	 5-12	 3-8	 1-12	 50 * [2-13]
--	--	--	--	---	--	---	---



7









set up on/between hexrows AA and CC:

 4 <sup>2</sup> -6-8	 8-1	 3-8	 7 mortar
--	--	--	---



4
6

**9<sup>th</sup> Company, 7<sup>th</sup> Moroccan Skirmisher Regiment [ELR: 3] and elements of Derbyshire Yeomanry**  
enter on Turn 1 on/between GG4 and GG7 (AFV must enter on road hexes) {SAN: 3}:

 4-5-7	 2-3-7	 8-1	 7-0	 dm MMG	 5-11 2-8	 dm MTR 90mm
--	--	--	--	---	--	---



8

 33 40L -/4	 33 40L -/4/2
--	--

2



**11<sup>th</sup> Company, 7<sup>th</sup> RTM**  
enter on Turn 1 on south edge, on/east of hexrow J:

 4 <sup>1</sup> -5-8	 9-1	 8-0
--	--	--

8

*Scenario Design: Philippe Naud '94*

### SSR:

1. EC are Moderate, with no wind at start. Kindling and Bore Sighting are NA.
2. Place Overlays as follows: **OG2** in P4-Q4; **OG3** in R5-S6; **B5** in W3-W4.
3. Armored Assault is NA. Road Movement Rate is NA for vehicles.
4. A +1 nightfall LV Hindrance is in effect starting on Turn 3.

**AFTERMATH:** Colonial infantrymen and AFV's advanced on the road. A few Germans launched a grenade attack against the vehicles, but they were swept aside. 11<sup>th</sup> Company, having withdrawn to the wadi, came back through the woods. Led by Lt Moha, the Moroccans engaged the Germans in hand to hand fighting, pushing them back with significant losses. The 7<sup>th</sup> RTM remained in control of the battlefield. The last action of the Axis January offensive has just been fought.

# 29 LET'S GO

## SCENARIO ASL TAC 58

Translated by Coastal Fortress Gaming Group



**VICTORY CONDITIONS:** The Americans win if they Control 10 buildings on board 22 at game end.

### GRANDCAMP, FRANCE, 8 June 1944:

Two days after D-Day, the 352<sup>nd</sup> Infantry Division, now decimated, was forced to withdraw in the face of an American push from Omaha Beach. The small port at Grandcamp, because of its importance for Allied supplies, was nevertheless defended against elements of the Rangers and of the 29<sup>th</sup> Division that came out of Pointe du Hoc. The swampy terrain was an asset to the Germans, and so was a small stream protecting the eastern approaches to the village. Around midday, a group of Rangers were fought off. A more powerful American attack was then prepared.

### BOARD PLACEMENT:

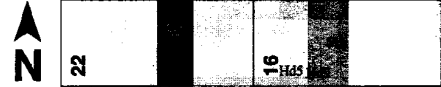

### BALANCE:

- ☆ Add a 8-1 Armor Leader to the US OB
- Add a MMG to the German OB

(Only hexrows A to P on board 16 and R to GG on board 22 are in play)

♣ GERMAN sets up first	☆	1	2	3	4	5	6	7	8	END
☆ AMERICAN moves first										

+

**Elements of 914<sup>th</sup> Grenadier Regiment, 352<sup>nd</sup> Infantry Division [ELR: 3]**  
set up on/west of hexrow 16C {SAN: 4}:

4 <sup>1</sup> -6-7	2-4-7	9-1	8-0	7-0	7-16	5-12	3-8	12-4	?	11
9					2		10		12 factors	

M

**Trench**  
DUR, OEA: +4  
Other: +2

**MTR**  
M11  
81<sup>1</sup> [2-60]

2-2-8

4

☆

**Elements of 5<sup>th</sup> Rangers [ELR: 4]**  
set up on/east of hexrow 16L{SAN: 2}:

6 <sup>1</sup> -6-7	9-1	60 [2-18]
3		

☯

**Elements of K and L Company, 3<sup>rd</sup> Battalion of 116<sup>th</sup> Infantry Regiments "Stonewallers" [ELR: 4] and of 743<sup>rd</sup> Tank Battalion enter on Turn 1 on east edge:**

6 <sup>1</sup> -6-6	5 <sup>2</sup> -4-6	9-1	8-1	7-0	2	2	8-4	13 [1]	15 [1]
6	6				2	2	2	75 2/4/4	75 2/4/4
									3

*Scenario Design: Pascal Guet '94*

### SSR:

1. EC are Moderate, with no wind at start.
2. Place Overlays as follows: **St1** in 16N4-N5; **Hd5** in 16E9-F8; **Hd9** in 16I9-J8. The Stream is Shallow. There is a One-Lane Stone Bridge in 16N4 linking O5 to M5. On board 16 only, half-hexes included, apply the following terrain changes: Hedges are Bocage (B9.5) Grainfields are Mudflats (B16.7), and furthermore, whenever a vehicle enters an Open Ground hex without crossing a road hexside, a Bog Check (+1 DRM, Soft Ground) must be made, as if EC were Mud (D8.23). On board 22 only: all buildings are stone buildings.
3. Board 22 and board 16, west of hexrow C, inclusive, undergo a PreGame Bombardment (C1.8).
4. The first MC successfully passed by a non-Elite US MMC creates a Hero. No other Hero can be created in this fashion.

**AFTERMATH:** After a one-hour naval bombardment, K and L Companies of the 116<sup>th</sup> Infantry Regiment launched an assault with the support of Sherman tanks. The tanks crossed the untouched bridge, but one of them blew up on a mine. The GI's were taken to task by German MG's and mortars and returned the fire. The Americans seemed to be marking time at the edge of the village. At this point, Sgt. Peregory infiltrated the enemy positions and single-handedly neutralized a MG nest with Garand fire and grenades. He pushed his prisoners in front of him, knocked out another MG nest and captured some Germans. This exceptional action allowed the main force of the battalion to mop up Grandcamp. Peregory would be the only man of the 116<sup>th</sup> and one of only two of the 29<sup>th</sup> Division ever to be awarded the Congressional Medal of Honor. He never learned about it: he was killed in action 6 days later.

# THE RAILWAY BATTLE

## SCENARIO ASL TAC 59

Translated by Coastal Fortress Gaming Group



**VICTORY CONDITIONS:** The Germans win as soon they exit 40 VPs of GO units on the western edge on/between 11Y10 and 11I10

### Near ERNAGE, BELGIUM, 15 May, 1940:

After the German attack on May 19, the 1<sup>st</sup> French Army entered Belgium as planned in the "Dyle" plan. As point element, General Prioux's cavalry corps was tasked to delay the Germans enough for the infantry divisions to set up on defensive positions on a line going from Wavre to Namur. The Gembloux-Ernage sector was entrusted to General Mellier's 1<sup>st</sup> Moroccan Division. This elite unit, made up of Moroccans volunteers, was a well-commanded and highly motivated troop, but suffered from the typical deficiency from the French army, and especially from a lack of anti-tank weapons. Its elements, on foot or truck transported, reached their planned positions that leaned on the Brussels-Namur railway. Unfortunately, the panzers of Hoepner's 15<sup>th</sup> Corps rushed Prioux's divisions at Hannut, and the 1st Moroccan Division was engaged in the fights on May 14, and not on the 18<sup>th</sup> as scheduled. The French disposal was near complete when the night came. The 2<sup>nd</sup> RTM, entrenched between Ernage and Gembloux held a reasonable defense line, well supported with 25 ATGuns detached to their profit by the Divisional HQ. A few mines and wires were hastily placed. On the 15<sup>th</sup>, at 0755, The German artillery and Stukas prepared without much success the attack of the tanks and riflemen's of the 4<sup>th</sup> Panzer Division.

**BALANCE:**

- ♣ The German may exit along the whole west edge
- ⊙ To count in the exit VPs, the German AFVs should have a functioning MA

**BOARD PLACEMENT:**









11	RR1	18
	RR2	









⊙ FRENCH sets up first	♣ 1	♣ 2	3	4	5	6	7	8	9	END
♣ GERMAN moves first										

**Elements of 1<sup>st</sup> Battalion, 2<sup>nd</sup> Moroccan Skirmisher Regiment and from 654<sup>th</sup> Divisional Anti-Tank Battery [ELR:3] set up on board 11 {SAN:4}:**



 E 4-5-8	 E 2-4-8	 9-1	 8-1	 8-0	 HMG [3] 8-11 6-12	 MMG [2] 4-11	 LMG [1] 8-11 2-8	 MTR [3] 60° [3-42]
19		2			2	2	2	









 AT M10 [3] *47L [a]	 AT M12 [3] 25LL [45]	 MTR M11 [3] 81* [3-71]	 2-2-8
2		4	







 Minefield MPH/RTPH: dr = MF CC: +1/-1	 AT Mine	
6	12 factors	6 factors



**Elements of 2<sup>nd</sup> Battalion, 35<sup>th</sup> Panzer Regiment and 2<sup>nd</sup> Battalion of 12<sup>th</sup> Assault Regiment [ELR:3] enter on Turn 1 and 2 along the east edge (see SSR 4) {SAN:2}:**



 1 4-6-7	 9-2	 8-1	 8-0	 4m HMG [1] 3-8	 4m LMG [1] 3-8	 ATR 1-12	 4m MTR [1] 3-8
16	2		2	2	3	2	2

 [1] CMG -/8+	 [2] 20L(4) -/5	 [2] 20L(4) -/5	 [2] 37L 3/8	 [1] 75* 3/8	 8-1
3	3	2	2	2	



Scenario Design: Philippe Naud '94

### SSR:

- EC are moderate, without wind at start. Kindling is NA. Level 2 Hills are Level 1 Hills. All hexes numbered 3 on board 11 are Railways. These hexes may be marked with the Tactiques RR overlays (RR1 and RR2), or any convenient counters. These Railway hexes are Sunken (SuRR, B32) on/between 11B3 and 11J3 and on/between 11W3 and 11BB3. Otherwise, they are Ground Level RR.
- The French receive a 100+mm OBAmodule (HE only) with plentiful Ammo, directed by an offboard observer, secretly placed before German setup at level 2 on western edge on/between 11A1 and 11Q1.
- All French units [EXC: 47Land 25LL], may setup in Foxholes of appropriate size if allowed by the Terrain.
- 6 or more Germans AFV must enter on turn 1. The other units may enter on turn 1 or turn 2. All Germans AFV entering the playing area are considered to have expended the half (FRU) of their MPs allotment.
- AP mines can't be exchanged for AT mines. AT minefields must setup as known minefields, as if placed on paved road (B28.53) on any terrain.

**AFTERMATH:** The French artillery raged and the AT and infantry weapons soon joined this terrifying death rain. Both sides engaged around 0930, the Panzers having joined the infantry. The German losses were heavy but several French positions were crushed. At 1000, the 2<sup>nd</sup> Battalion from the 12<sup>th</sup> Assault Regiment crossed the Railway, but the attack stalled under the high volume of defensive fire. At 1100, a 47mm shell damaged the Command Tank from the 5<sup>th</sup> Panzer Brigade, and the Commandant himself was wounded. The armor withdrawn one half-hour later, followed by the infantry. A good half of the engines of the 35<sup>th</sup> Panzer Regiment was disabled. The other German attacks also failed and the French held their positions. But this brilliant tactical success was rendered useless by the German break through the Ardennes that cut the rear of the 1<sup>st</sup> Army in Belgium.

# COUNTRY PARTY

## SCENARIO ASL TAC 60

Translated by Coastal Fortress Gaming Group



**VICTORY CONDITIONS:** The British win at game end if they control Building 10Z6 and 4 other multi-hex buildings (Rowhouses are considered multi-hex buildings for control rules)

### SEPT-VENTS, FRANCE, 30 July 1944:

In order to hold the German armored forces in the British Normandy sector and to avoid them counter-attacking the "Cobra" offensive, Montgomery decided to launch the "Bluecoat" operation. This operation goal was to seize the Caumont area, obliging the Panzers to go for a large bend if tempted to go west and losing critical time in the process. The main objective was Hill 309, pivot of the German defense. The 326<sup>th</sup> Infantry Division, an exhausted unit, held the sector. The 15<sup>th</sup> Scottish Division was tasked with the attack, supported by Churchills from the 6<sup>th</sup> Guard Tank Brigade. Both units were heavily supported by powerful artillery and numerous special engines (Funnies). The attack front was narrow, but countless hedges cutting the terrain favored the defense. On the morning of July 30<sup>th</sup>, the largest attack ever undertaken by infantry tanks started.

### BOARD PLACEMENT: 10

Hd9 Hd5  
Hd4 Hd11  
Hd7 Hd6











### BALANCE:

- ⊙ Replace the 9-1 Leader in the British OB with a 9-2 Leader
- ♣ Replace the MMG in the German OB with a HMG







♣ GERMAN sets up first	⊙ 1	2	⊙ 3	4	5	6	7	END
⊙ BRITISH moves first								

**Elements of 751<sup>st</sup> and 752<sup>nd</sup> Grenadier Regiment, 326<sup>th</sup> Infantry Division [ELR:3]**  
Sets up on/south of hexrow P{SAN:4}:

 4 <sup>+</sup> -6-7 6	 4-4-7 3	 9-1	 8-0	 7-0	 MMG R: [2] 5-12	 LMG R: [1] 3-8	 PSK R: [2] 12-4	 ? 7 morale
---	---	--	--	--	--	---	---	--



9                      24 factors

**Elements of 9<sup>th</sup> Cameronians, 227<sup>th</sup> Highland Brigade [ELR:4]**  
Sets up north-east of a the 10N0-N3-oM4-M10 line {SAN:2}:

 4 <sup>+</sup> -5-7 13	 9-1	 8-0	 7-0	 LMG R: [2] 2-7	 MTR R: [2] [2-11]	 PIAT R: [2] 8-3
--	--	--	--	---	--	--



3                      3                      2

**Elements of 2<sup>nd</sup> Squadron and Regimental AA troop**  
Enter on Turn 3 on 10I1

 75 2/4	 95* 2/4	 9-1
--	---	--

3

**Elements of 1<sup>st</sup> Squadron, Grenadiers Guards (6<sup>th</sup> Grenadier Tank Brigade)**  
Enter on Turn 1 on 10I1

 75 2/4	 15 4/4 (12) *20L -1/4
--	--

Scenario Design: Jean-Luc Béchennec '94

### SSR:

1. EC are moderate, with no wind at start. Kindling is NA
2. Hedges are Bocage (B9.5). Place the following overlays: **Hd4** in M9-L8, **Hd5** in N2-M2, **Hd6** in T4-T3, **Hd7** in U10-T9, **Hd9** in M4-L4 and **Hd11** in P4-P5 (Tactiques Hedges overlays). The openings in some Overlays Hedges are Breaches (B9.541). The Rowhouses are normal multi-hex buildings (The black bars do not exist)
3. One German squad-equivalent may setup HIPwith all Leaders/SWs stacked with.
4. Before German setup, the British player secretly records a Pre-Registered hex, within LOS of a hypothetical offboard observer placed at level 3 on the north edge. The British player also chooses at the same time a game Turn (1 or 2) and a fire phase (PFPh or DFPh). At the start of the chosen fire phase, he chooses an OBAmission (70+mm HE, concentrated or harassing, WPor smoke) and places a FFE:1 on the Pre-Registered hex, rolls for accuracy (C1.732), and resolves the FFE:1. The FFE:2 is resolved at the next fire phase in the same final location (without any correction). No chit draw or extra-draws are required. No other mission is available for this OBAmodule.
5. Hexes sharing a Bocage hexside with a road hex are equivalents to building hexes for Street Fighting purposes in the according road hex.

**AFTERMATH:** Several Churchills where immobilized by mines, but the Cameronians advanced toward Sept-Vents across orchards and Bocages. They where supplemented with several tanks and some others supported them with Gunfire. The Defense stiffened on the village edges. Other Tanks, and between them Anti-Aircraft Crusaders joined then. Their devastating fire suppressed the last resistance attempt. The infantry cleared the seized terrain and Sept-Vent was declared safe around 1030. The attackers then could resume their progression in the surrounding countryside.

# GHOSTS IN THE JUNGLE

SCENARIO ASL TAC 61 Translated by Coastal Fortress Gaming Group



## BARRIGADA, GUAM, 2 AUGUST 1944:

After the successful landings led by the Marines of the 1<sup>st</sup> Provisional Marine Brigade and the 3<sup>rd</sup> Marine Division, the American foothold on Guam was no longer threatened. The 77<sup>th</sup> Infantry Division was entrusted with the task of mopping up the island in the face of a greatly weakened enemy, one still capable of determined resistance. The Barrigada district, in the north-eastern part of the island, was the scene of heavy fighting; the Japanese were desperately resisting access to the village and were clinging to the edge of the jungle that lay to the east. The first attack on the 'Green House' by B Company, 307<sup>th</sup> Regimental Combat Team, had failed by the afternoon of the 2<sup>nd</sup>, with the result that the left flank of the battalion was now exposed. In order to re-establish contact with B Company, now cut-off to the north-west, Company G was dispatched to take and hold the area with the help of some light tanks.

BOARD PLACEMENT: 

BALANCE: 













**VICTORY CONDITIONS:** The American wins at game end if they have exited  $\geq 12$  VP of Good Order Infantry off the north edge of the map-board on/east of hex row Y, **OR** if they have  $\geq 10$  VP of Good order infantry on/east of hex row V.

- ☆ M5A1s are Recalled at the beginning of Turn 5 Only hexrows R to GG are playable.
- M5A1s are Recalled at the beginning of Turn 3





● JAPANESE set up first	☆	1	☆	2	3	4	5	6	7	END
☆ AMERICANS move first										

**Elements of 18<sup>th</sup> Infantry Regiment [ELR:4]**  
Set up West of Alternate hexgrain X0/DD10 AND South of hexgrain R0/GG8 {SAN:6}:



 1 4 <sup>+</sup> 4-7	 2-2-8	 9-1	 8-0	 HMG 3 6-14	 MMG 2 4-11	 LMG 1 2-8	 MTR 5 50*[1-16]*	 ATR 1 1-12	 ? 7 mortar	 Foxhole 5 DVR, OBA: +4 Other: +2
7	3						2		12	6

**G company, 307<sup>th</sup> Infantry Regiment and elements of D Company, 706<sup>th</sup> Tank Battalion [ELR: 4]**  
Enter as indicated {SAN:2}:

**2<sup>nd</sup> Platoon** enter on Turn 1 on/between GG4 and GG7

 6 <sup>+</sup> 6-7	 6 <sup>+</sup> 6-6	 9-1	 4th MMG
2	2		



**3<sup>rd</sup> Platoon** enter on Turn 1 on/between BB0 and GG1

 6 <sup>+</sup> 6-6	 8-0
3	

**Elements of D Company:** enter on Turn 1 on Y1

 17 37LL 2/4/2
4

**1<sup>st</sup> Platoon** enter on Turn 2 on/between GG4 and GG10

 6 <sup>+</sup> 6-6	 8-1
3	

Scenario Design: Jean-Luc Béchenec and Philippe Naud '94

### SSR:

1. EC are moderate with a Mild Breeze blowing from the North. PTO Terrain is in effect with Dense Jungle. Place the following overlays: **Wd5** in W7-W8, **Wd3** in V5-U6, **Wd4** in V4-U4 and **X9** in X6.
2. Two Japanese squad-equivalents may setup HIP in addition to the standard 10% allowance(G1.631).
3. The M5A1s are placed under Recall at the start of Turn 4.
4. The M5A1s may not enter, nor move adjacent to a hex occupied by any non-HIP Japanese unit [EXC: Recall]. (Japanese Dummy Stacks are considered enemy Units, see Index). M5A1 crews may not Voluntarily Abandon their vehicles.

**AFTERMATH:** Contradictory orders caused confusion from the start of the assault. The 2<sup>nd</sup> and 3<sup>rd</sup> Platoons advanced in leap-frog fashion, supported by the fire of 4 M5A1s. But the tanks and infantry were uncoordinated and the American tankers showed even less bravery when the enemy remained totally unseen, except for the fire of light weapons from the jungle. The 1<sup>st</sup> Platoon arrived at the scene of the battle and the "Green House" was taken. At this point the M5A1s withdrew, allowing the Japanese to begin anew their deadly fire. Casualties mounted and the attackers were pinned down, unable to ascertain the enemy positions. Later reinforcement by Company H and several more tanks finally allowed the Americans to withdraw. The isolated 1<sup>st</sup> platoon had lost 26 GIs, most of whom had been killed by an enemy they never saw.

# PANZERS MARSCH!

## SCENARIO ASL TAC 62

Translated by Coastal Fortress Gaming Group

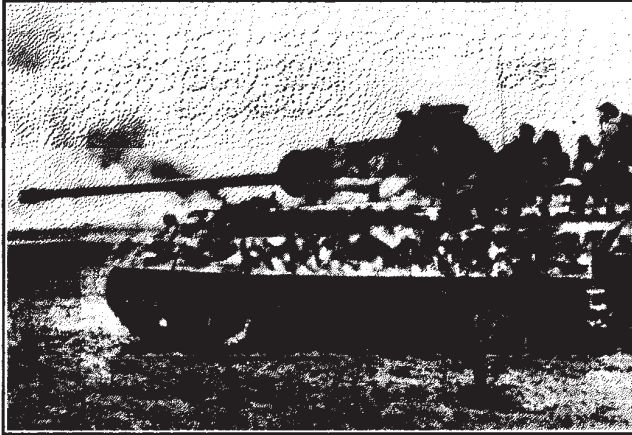

**VICTORY CONDITIONS:** The Germans win at game end if they control  $\geq 9$  stone building hexes.

### East of KIELCE, POLAND, 16 August 1944:

Profiting from the collapse of Army Group Center, armored spearheads from the 3<sup>rd</sup> Guards Army penetrated deep into German lines and captured a town commanding two bridges which were the key to the German lines of communication. A Kampfgruppe from the 3<sup>rd</sup> Panzer Division launched a counterattack to retake the village. The plan formulated by Zobel, the Kampfgruppe commander, involved one company of tanks making a feint to the west while the main attack, detailed to a second tank company and mounted infantry, was to come from the south.

### BOARD PLACEMENT:

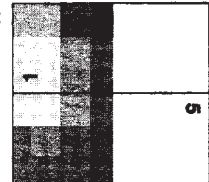

### BALANCE:

☛ Exchange the German 9-1 Armor Leader for a 9-2

★ Add 4 "?" counters to the Russian OB

*only hexrows A-P on board 1 and R-GG on board 5 are playable*

★ RUSSIANS set up first	☛	1	2	3	4	5	6	END
☛ GERMANS move first								

**Spearheads of the 3<sup>rd</sup> Guards Army [ELR: 4]**  
setup on board 1 and on board 5 in hexes numbered 10 {SAN: 4}:

6-2-8	4-5-8	9-1	8-0	7-11-12	2-6	50*[3-20]	1-12	7 morale	Foxhole 5 1S OVR, OBA: +4 Other: +2
2	4							4	2

57LL	2-2-8	16 11 6 85LL 2/4	8-1
		2	

**Elements 6<sup>th</sup> Company, 2<sup>nd</sup> Battalion**  
3<sup>rd</sup> Regiment (3<sup>rd</sup> Panzer Division)  
enter on turn 1 on the west edge,  
on/south of hex 5GG6 :

75LL 3/5/2	9-1
2	

**Elements of 5<sup>th</sup> Company,**  
2<sup>nd</sup> Battalion  
3<sup>rd</sup> Regiment (3<sup>rd</sup> Panzer  
Division) enter on/after turn 1  
on the south edge :

75LL 3/5/2	15 10 6
2	

**Elements of 3<sup>rd</sup> Panzer Division [ELR: 3]**  
enter on/after turn 1 on the south edge {SAN: 2} :

15PP 17 7 AAMG -/-/3	5-4-8	5-1	8-0	8-0	12 7-16	2 5-12	3-3	12-4
3	9			2		2	4	2

Scenario Design: Jean-Luc Béchenec '92

### SSR:

1. EC are moderate, with no wind at start. Kindling is NA.
2. Buildings are all single-story. On board 5, hexes GG7, V8, U9, T8, S8, R8 are stream hexes, the other terrain type (Wood or OG) still exists. The Gully 5FF1-W2 does not exist, the Gully 5FF7-W9 is a Stream, the other terrain type still exists. Bridges Z9 and EE2 do not exist. The Stream are Deep.
3. German Vehicular Crew may not voluntarily abandon their vehicle.

**AFTERMATH:** The Panthers, using their guns and machineguns, cleared out the area south of the village, in the process destroying several anti-tank guns and two tanks. The infantry then entered the village and seized the bridges without encountering major opposition. Several Russian units, including tanks, fled to the north-east. The village was secured with little hindrance from the Russians who for the most part, realizing their numerical inferiority, abandoned their positions. The second bridge to the north-east of the village was rapidly controlled by the Germans.

# A TRAIN FOR ARNHEM

SCENARIO ASL TAC 63 Translated by Coastal Fortress Gaming Group

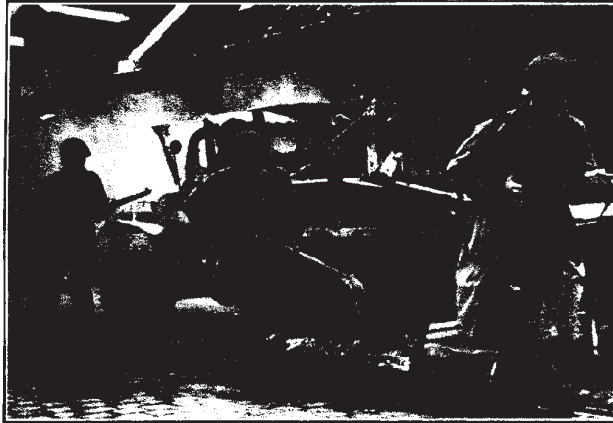

**VICTORY CONDITIONS:** The Allied player wins at game end if there are  $\leq 3$  unbroken German squads (or equivalents) on/between hexrows 20W-8K and 20AA-8G.

**NIJMEGEN, HOLLAND, 19 September 1944:**

Two days after the launch of Operation Market-Garden, the 82<sup>nd</sup> Airborne Division was still trying to gain its objectives. The Germans occupied the heights south of Nijmegen as well as the northern part of the city, in particular the two bridges which spanned the River Waal. The Germans, in the form of Kampfgruppen hurriedly assembled from the remnants of resting units, had proved too strong for the Paratroops on their own. The arrival of the forward detachments of Guards Armoured Division was timely, and a new assault on the Nijmegen bridges was begun. While a strong force attempted to seize the main road bridge, a more modest force consisting of a U.S. Paratroop company, a platoon of British infantry and a troop of tanks were to take the railway bridge. The bridge was defended by elements of KampfGruppe Henke, a temporary battalion formed from regular infantry, Luftwaffe ground personnel and even Nijmegen rail installation guards, supported by an anti-aircraft gun.

**BOARD PLACEMENT:**

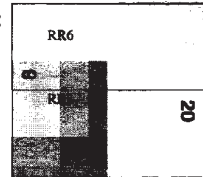

**BALANCE:**

- ☆ ⊕ Add 6 "?" to the German OB
- ⊕ Replace the 9-1 Armor leader with a 9-2 Armor Leader

*Only hexrows R-GG are playable on Board 20. Only hexes numbered  $\geq 7$  on hexrows A-P are playable on Board 8*

⊕ GERMANS set up first	☆ ⊕ 1	2	3	4	5	END
☆ ⊕ AMERICANS move first						

**Elements of KampfGruppe Henke: [ELR:3]**  
set up on Board 8, and/or in hexes numbered  $\leq 3$  on Board 20 {SAN:4}:

 4'-6-7 3	 4-4-7 7	 4-3-6 3	 9-1	 8-1	 7-0	 MMG 7-16	 MMG 5-12	 LMG 3-8	 PSK 12-4	 ? 7 morale 6
-----------------	----------------	----------------	---------	---------	---------	-----------------	-----------------	----------------	-----------------	------------------------

**AA detachment, Kampfgruppe Henke:**  
sets up  $\geq 3$  hexes from 20Y9 except on Railroad hexes:

 AA 88L AS'4'3'	 2-2-8
--------------------------	-----------

**Company D, 505<sup>th</sup> Parachute Infantry, 82<sup>nd</sup> Airborne Division [ELR:5]**  
enter on Turn 1 on the south edge {SAN:2}:

 7'-4-7 9	 9-2	 8-1	 8-0	 MMG 8	 BAZ44 8-4 3
-----------------	---------	---------	---------	--------------	-----------------------

**Elements of 1<sup>st</sup> Motorized Battalion and 2<sup>nd</sup> Grenadier Guards, Guards Armoured Division [ELR:4]:**  
enter on Turn 1 on the south edge:

 4'-5-8 3	 2-4-8	 1-6	 LMG 2-7	 PIAT 8-3	 13 2/4 +75	 13 2/4 76LL	 9-1 2nd Lt
-----------------	-----------	---------	----------------	-----------------	----------------------	-----------------------	-------------------

4

Scenario Design: Jean-Luc Béchenec '94

## SSR:

1. EC are moderate with no wind at start. Place Overlays as follows: **RR11** on 8I9-8I8 and **RR7** on 20Y6-20Y5. The Railway type is all EIRR (B32.1) and is considered a Stone Bridge in 20Y2, 8I9, 8I8 and 8I7 (B32.4 and B32.42 apply). On all other railway hexes no Bridges exist (B32.4 and B32.42 are NA). The Railway Terrain (EIRR) continue to exist offboard (i.e. a board butted lengthwise on the southern edge of the playing area would have its hexrow Y or I all made of Railway (EIRR) Terrain). An alternative is to use Tactiques RR overlays: **RR3** on 20Y10-Y9 and **RR6** on 8I4-I5, **RR6** removing all possible confusion on the Bridge nature of the Railway on 8I9-8I7. At the beginning of Turn 4 until the end of the game, a LV Hindrance of +1 applies (E3.1). Swimming is NA.
2. Buildings 20Z3 and 20U2 are Factories (B23.74). Hills do not exist, but all other terrain on the hill depictions exists, but at level 0.
3. Allied Troop rules apply (A10.7) between American and British troops.

**AFTERMATH:** Although the railroad was seized without much difficulty to within 200 meters of the railroad bridge, the enemy had grown significantly in strength by the time the combined force encountered a strongpoint defended by machine guns and an 88mm gun. After a hurried consultation with his superiors, the British commander came up with a plan to breakthrough the defenses and capture the bridge. The attack began just as the evening twilight started. The first three tanks were quickly put out of action by the Germans. Now the paratroops were subjected to sustained machine gun fire. Faced with a rising casualty count, the advance was stopped and the attacking units withdrew 100 meters to take up positions for the night. In a bitter blow, Lt. Waverley W. Wray of Company D, a veteran of the Normandy campaign, was killed by a sniper just as he withdrew with his men.

# HOLD YOUR GROUND!

SCENARIO ASL TAC 64 Translated by Coastal Fortress Gaming Group

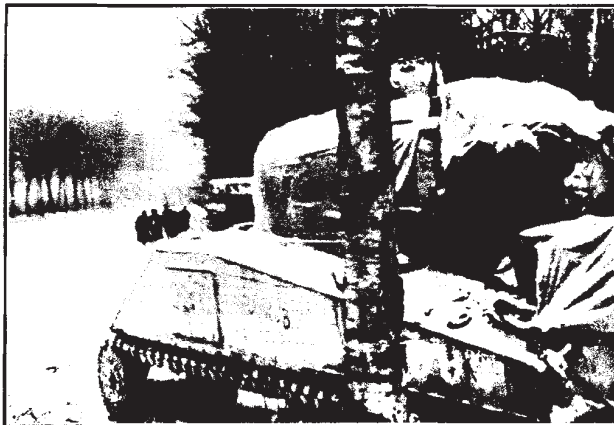

## South of WICKERSCHWIHR, FRANCE, 27 January 1945:

The French First Army had been stymied by the ferocious resistance of the German 19<sup>th</sup> Army in front of Colmar since the beginning of December. Toward the end of January 1945, the French launched a general offensive to eliminate the "Colmar Pocket". Second Corps was ordered to liberate the city with the help of U.S. troops of 21<sup>st</sup> Corps. The first objective: the Colmar Canal to the east. The Americans quickly lost momentum. General Monsabert decided to throw in 4<sup>th</sup> Combat Command in an extra effort to first cross the Canal and then push on to the south. Detachment A were to the fore, their objective; the bridge at Wickerschwihr. Platoon Bethouard, accompanied by a detachment of legionnaires, were the first to arrive at the Canal. A patrol found that the bridge had been partly demolished. It was impassable to vehicular traffic, but could still be crossed on foot. The French took up position, awaiting the arrival of the rest of the detachment. Very soon, a German company approached from the direction of Bischwihr.

### BALANCE:

- ⊙ Replace 9-1 Armor Leader with a 9-2 Armor Leader in the French OB
- ⊕ Replace 11 VP in the Victory Conditions with 9 VP













21	
	40
91	



**VICTORY CONDITIONS:** The German wins at game end if he has  $\geq 11$  VP of units north of the Canal. Units on Board 12 globally count as 1.5 times their VP value (FRU).

⊙ FRENCH set up first	⊕	1	2	3	4	5	6	7	END
⊕ GERMANS move first									

**Elements of Detachment A (5<sup>th</sup> Company, Foreign Legion Regiment and 3<sup>rd</sup> Squadron, 1<sup>st</sup> Armored Regiment), 4<sup>th</sup> Combat Command, 5<sup>th</sup> Armored Division [ELR:4]**  
set up north of the Canal {SAN:3}:













 4-5-8 4	 2-4-8 4	 9-1 4	 8-0 4	 MTR(m) M2 60" (3-45) 3	 BAZ44 E XII 8-4 3	 ? 7 morale 6	 20 15PP *AAMG -/-/4 3	 20 10PP* *AAMG -/-/12*
--	--	--	--	--	--	--	--	--

 13 75 2/4/4 3	 9-1 2 VP LI
--	--

**Elements of the 189<sup>th</sup> Infantry Division: [ELR:2]**  
Set up on Board 16 on hexes numbered  $\geq 3$  {SAN:2}:



 4-4-7 12	 9-1 4	 8-0 4	 7-0 4	 MMG E XII 5-12 2	 LMG E I 3-8 3
---	--	--	--	---	--

 13 88LL 3	 AT M12 37L HG(9) 3	 MTR M11 81* [2-80] 3	 2-2-8 2
---	--	--	--

Scenario Design: Pascal Guet '92

### SSR:

- EC are Ground Snow (E3.72) with no wind at start.
- The river is a Canal (B21.11). Although EC are Ground Snow, the Canal is not Frigid. The Current is Slow. The Canal is Fordable (B21.41-43). A Footbridge (B6.44) exists in 40Q2-Q3. Hills do not exist (the Terrain depicted on is at Level 0 instead).
- German units and French vehicles have Winter Camouflage (E3.712).
- The Germans receive one module of 80+ mm Battalion Mortar OBA with Normal Ammunition directed by an Offboard Observer located at Level 2 along the south edge.
- French units that set up in Concealment Terrain are automatically Concealed (the "?" counters in the OB are designed to be used to form dummy stacks). Infantry may be set up in Foxholes of appropriate capacity if permitted by the other terrain in the hex.
- The inherent squad in the M3(MMG) is a 458. The inherent 458 and the MMGs of the M3(MMG) may be Removed (D6.631) prior to French set up.

**AFTERMATH:** The Germans, clothed in their white camouflage, advanced on the canal with weapons slung. The French opened fire at 400 meters, throwing the enemy ranks into utter confusion and forcing them to take cover. Then mortar barrage from Bischwihr landed on the Cuirassiers and Legionnaires. The Germans attempted to attack again, this time infiltrating onto the northern bank. However, it was all in vain: 40 of them were soon captured in the woods just north of the canal. Even the intervention by a self-propelled gun and a light anti-tank gun was not enough to reverse the course of the battle. The French maintained their control of the position and welcomed the arrival of the first American troops around 1600 hours. The defenders had successfully held their ground with the only casualty being a slightly damaged tank.



# THE LAST BRIDGE

SCENARIO ASL TAC 65 Translated by Coastal Fortress Gaming Group



**VICTORY CONDITIONS:** The Soviet player wins at game end if he Controls Building 23U3 provided he has  $\geq 12$ VP of Good Order infantry south of the Canal and there are no unbroken German units north of the Canal on/west of hexrow V.

## BERLIN, MOLTKE BRIDGE, 28 to 29 April 1945:

After a hard fought advance through Moabit Quarter, Soviet forces of 79 Corps had reached the northern end of the Moltke bridge, spanning the River Spree. This was the only practical crossing within reach of the Administrative Quarter, an area the Germans had turned into a veritable fortress. The only other intact bridge was under constant fire from the Reichstag itself, where the Germans had massed automatic weapons, and opened onto open ground which made a bridgehead difficult to establish. The Moltke bridge was also barricaded at both ends, and itself was swept by the fire of defenders entrenched in the Department of Domestic Affairs and the Diplomatic District. A daylight crossing was deemed impossible, so the Soviets decided on a night assault to seize a foothold in the citadel.

### BOARD PLACEMENT:

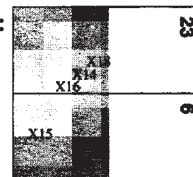

### BALANCE:

- ★ Add a 6-5-8 and LMG to German reinforcements
- ♣ German reinforcements enter on Turn 4

Only hexrows R-GG are playable

♣ GERMANS set up first	★	1	2	3	4	5	6	7	END
★ SOVIETS move first									

+

**Elements of the Waffen SS and Volksturm: [ELR:1]**  
set up south of the canal and/or in hex 23X3 {SAN:4}:

2	3	3			2	2	

+

**Counter attacking Group:**  
enter on Turn 3 on the east edge of Board 23 (see SSR 2):

2	6			2

★

**Elements of the 1<sup>st</sup> Battalion, 756<sup>th</sup> Rifle Regiment: [ELR:4]**  
set up north of the canal on/west of Hexrow X in hexes numbered  $\geq 6$  OR enter on Turn 1 on the north edge {SAN:3}:

3	5	2						2		

**Elements of the 1<sup>st</sup> Battalion, 380<sup>th</sup> Rifle Regiment:**  
set up north of the canal on/west of Hex row X in hexes numbered  $\geq 6$  OR enter on Turn 1 on the north edge:

7	3			2	3

Scenario Design: Jean-Luc Béchenec '94

### SSR:

1. EC are moderate with no wind at start. The Bridge in BB5 does not exist. Woods are shellholes. Buildings are Stone. Single Story Buildings are Stone Rubble. Orchards are not in season. Place Overlays as follows: X15 on 6Z7-Z6, X16 on 23X0-W1, X14 on 23U3-U2, X18 on 23S4-R3. The Rooftops of Building 23Y7 and of the buildings on Overlays X15 and X16 are playable. All Locations of the buildings of Overlays X14, X15 and X16 are Fortified (B23.9) (EXC: eventual rooftop). Place the roadblocks on hexsides 23X3-X4 and 23X2-X3.
2. Night Rules are in effect. Initial NVR is 2 hexes, with a half-Moon. Russians are the Scenario Attacker, and the Germans are the Scenario Defender. However, German forces which enter during the game may use Cloaking. The Russian Majority Squad Type is Stealthy, while the German Majority Squad Type is Normal.
3. The 20L Flak 38s may set up on Rooftops (B23.85 is NA). German Units are considered Fanatic while they are in the Overlay X16 Building.
4. The German player may Boresight the HMG and MMGs (E1.71).

**AFTERMATH:** The assault was undertaken by a battalion from each of the leading divisions. The Bridge defenders were overwhelmed around midnight but the crossing had truly been a close affair. The Germans had positioned several machine-guns to enfilade the southern bank of the Spree and held the bridge under a vicious crossfire. In addition, the Germans mounted a counterattack on both sides of the Spree which put the Soviet assault in danger. The Germans then detonated explosive charges, but the bridge was stronger than foreseen and withstood the explosion, still allowing vehicles to cross. By 0200 the Soviets had finally driven off the counter-attack and had established a foothold in the Diplomatic District. Reinforcements were then directed in overwhelming strength to the south of the canal to shore up the bridgehead and by morning, the Soviets were firmly ensconced in the Diplomatic District. The Battle for the Reichstag was about to begin.

# THE LAST ATTACK

SCENARIO ASL TAC 66

Translated by Coastal Fortress Gaming Group

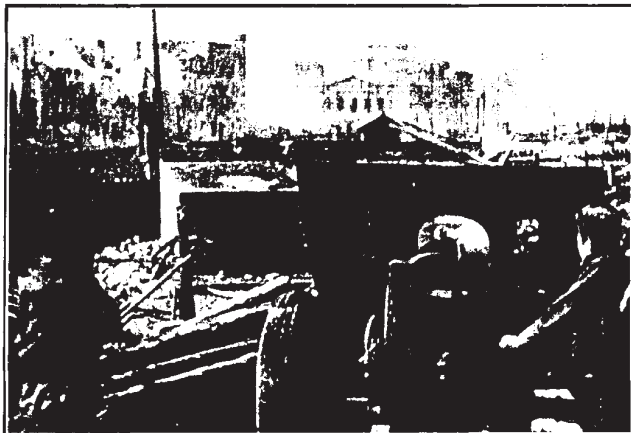

**BERLIN, ALSENSTRASSE, 30 April 1945:**

The battle for the Reichstag was no longer in doubt and the only remaining question was the date the former parliament would fall. The situation was desperate but the defenders still held. A new Soviet attack was launched at 1130 under the shelling of German guns firing from the Kroll Opera and soon the infantry reached the anti-tank ditch and the edge of the Alsenstrasse. In the face of this danger, the Germans quickly gathered a counterattack force: a battalion of marine cadets.

**BOARD PLACEMENT:**

**BALANCE:**

- ☛ Replace the 9-1 leader with a 9-2 leader in the German OB

- ★ Add a 6-2-8 and a LMG to the Russian group that sets up on/adjacent to 23Z2

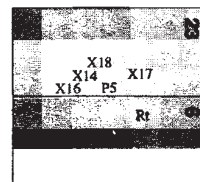

**VICTORY CONDITIONS:** The Germans win at game end if they control  $\geq 5$  more stone building Locations they controlled at setup.

★ RUSSIANS set up first	1	2	3★	4	5	6	7	END
☛ GERMANS move first								

**★ Elements of 525<sup>th</sup> Infantry Regiment [ELR:4]**  
set up south of the Canal on/west of hexrow R {SAN:4}:

4-4-7	8-1	LMG 2 4-10	LMG 2 2-8
-------	-----	------------	-----------

4

**Other elements of 525<sup>th</sup> Infantry Regiment**  
set up on/adjacent to 23Z2:

6-2-8	5-2-7	9-2	8-0	LMG 1 2-8	DC 30-1
-------	-------	-----	-----	-----------	---------

4      4      2

**Elements of 171<sup>st</sup> Division**  
set up north of the Canal on/between hexrows Q and U:

4-4-7	2-2-8	8-0	LMG 3 6-12	ART M9 76L
-------	-------	-----	------------	------------

2

**Armored support from 79<sup>th</sup> Corps**  
enter on Turn 3 on 23Y10:

13 152 -1-74	16 85L 2/4
--------------	------------

**☛ Elements of Kriegsmarine Cadet Battalion [ELR:2]**  
set up south of the Canal on/east of hexrow O {SAN:4}:

5-2-4-8	9-1	8-0	7-0	LMG 2 5-12	LMG 3 3-8	DC 30-1
---------	-----	-----	-----	------------	-----------	---------

12      3      2

**Elements of the SS and the Volksturm**  
set up in building 6L10 (Reichstag overlay):

4-4-7	8-1	LMG 3 7-15	LMG 2 5-12
-------	-----	------------	------------

2

Set up on/east of hexrow N:

AA M 88L AP 4 3	2-2-8
-----------------	-------

Scenario Design: Jean-Luc Béchenec '94

**SSR:**

- EC are moderate with no wind at start. The only bridge is at X3. Woods are Shellholes. All buildings are Stone. Single story buildings are Stone Rubble. Orchards are out of season. Place the following overlays: X15 in 6Z7-Z6, X16 in 23X0-W1, X14 in 23U3-U2, X18 in 23S4-R3, X17 in 23O4-O5, R1 in 6L10-K10, OG3 in 6N5-M6 and P5 in 23Q1-R1. Buildings 23Y7, X15 and X16 have playable rooftop locations. Buildings X14, X15, X16 and L10 (Reichstag) have all their locations (EXC: eventual rooftop) fortified (B23.9).
- Place 4 Shellholes in 23P3, 23P4, 23Q4 and 23Q5. Place 6 AT-Ditches from 6Q5 to 6Q10. These AT-Ditches are flooded and the MF cost to enter/exit is 3MF + COT instead of 2 (see B27.56).
- Because of the dust raised by the incessant shelling of the area, Mist (E3.32) applies.
- The 88L is under Ammo Shortage. Germans have a Level B Booby Trap capability (B28.9) south of the Canal.

**AFTERMATH:** The Alsenstrasse was crossed under enemy fire and the Cadets seized a foothold in the buildings on the western side of the avenue. After a promising start, the counterattack collided with elements of the 525<sup>th</sup> Infantry Regiment. Russian reinforcements quickly arrived to bolster the defense and soon the Germans were thrown back to their starting line with heavy losses. The last attack to delay the end of the Reich, from now on reduced to a few square-kilometers, failed.



# MOUNT AKAYAMA

SCENARIO ASL TAC 68 Translated by Coastal Fortress Gaming Group



**VICTORY CONDITIONS:** Japanese win immediately when the AT 45L Gun and the Russian MMG are both destroyed or captured.

**NOMONHAN area, the night of 18 to 19 August 1939:**

After the failure of the Japanese offensive at the end of July, both the Russians and Japanese stood firm in their positions. The Japanese were entrenched on Hill 754, while the Russian positions spread out on several heights to the south, where they installed several MG nests and some anti-tank Guns. Based on some partial recons, Captain Tsuji, commander of the 6<sup>th</sup> company, asked his chief, Major Kajikawa, for authorization to launch a night attack on the Soviet positions. The first skirmish took the Russians by surprise and the attack progressed quickly. But soon it appeared that the Soviet positions were modified and that the more the attack progressed, the more the defenses got stronger. The first two heights were captured and the Soviet troops regrouped on Mount Akayama.

**BOARD PLACEMENT:**

**BALANCE:**

● Add a 4-4-8 to the Japanese OB

★ Add a 4-4-7 to the Russian 1st Group



*Only hexrows A-P are playable*

★ RUSSIANS set up first	1	2	3	4	5	6	7	END
● JAPANESE move first								

**Elements of 1<sup>st</sup> Independent Battalion, 603<sup>rd</sup> Infantry Regiment, 82<sup>nd</sup> Division [ELR:2]**  
set up as indicated below {SAN:3} (see SSR 4):

**Group 1:** set up on hill hexes on/between hexrows D and H:

 4.4-7	 2-2-8	 8-0	 2-8	 45L	 AT M11	 Trench OVR, OBA: +4 Other: +2	 Foxhole 5 OVR, OBA: +4 Other: -2
3							3

**Group 2:** set up on hill hexes on/between hexrows I and L:

 4.4-7	 2-3-7	 9-1	 MMG OVR, OBA: +4 4-10	 LMG OVR, OBA: +4 2-8	 NTR OVR, OBA: +4 50*[3-20]	 Trench OVR, OBA: +4 Other: +2
5						3

**Group 3:** set up on hill hexes on/between hexrows M and P:

 4.4-7	 8-0	 LMG OVR, OBA: +4 2-8	 Foxhole 5 OVR, OBA: +4 Other: -2
5			5

**1<sup>st</sup> and 2<sup>nd</sup> platoons of 6<sup>th</sup> Company, 2<sup>nd</sup> Battalion, 28<sup>th</sup> Infantry Regiment [ELR:4]**  
enter on Turn 1 along the east edge {SAN:2}:

 4 <sup>E</sup> .4-8	 2 <sup>E</sup> .3-8	 10-0	 9-1	 8-0	 LMG OVR, OBA: +4 2-8	 NTR OVR, OBA: +4 50*[1-10]
9	2				2	3

*Scenario Design: Sylvain Ferreira '95*

**SSR:**

1. EC are wet with no wind at start.
2. Night Rules [E1] are in effect. NVR is 3 with no moon and no clouds. Japanese are Scenario Attackers and Russians Scenario Defenders. The Majority of the Japanese squads are stealthy and the majority of the Russian squads are normal.
3. Place **OG3** overlay on B5-C6. Orchards are Crags.
4. Russians leaders from Groups 2 and 3 can only gain Freedom of Movement with a dr ≤ ELR [E1.21] as long as no Japanese MMCs entered their respective setup areas.
5. The Gun and the MMG can't set up in the Wadis. They must setup on Level 2 or 3 for the Gun and on Level 3 or 4 for the MMG. They can't be moved (carried or pushed) during the scenario.
6. The Japanese are given a recon dr [E1.23].

**AFTERMATH:**

Before assaulting the Hill, Captain Tsuji ordered fire from all company mortars on the Soviet positions. Taking advantage of the confusion resulting from this mortar preparation, Tsuji led a platoon on the Russian flank and swept down on the first Russian positions where the swords and bayonets of the Nippon soldiers achieved a slaughter. The Russian survivors withdrew to the next position, better prepared. There, The Russians defended themselves vigorously and all the Japanese officers were killed, except Tsuji. Finally the Russians withdrew under the cover of the night.

# BATTAM BANG BANG

## SCENARIO ASL TAC 69

Translated by Coastal Fortress Gaming Group



### Road to KHUM KANDAL, BATTAMBANG, CAMBODIA, 16 January 1941:

At the end of 1940, the Thai army, emboldened by the French Indochina occupation by the Japanese, undertook to conquer the territories that were given to Cambodia at the end of the 19<sup>th</sup> century. There followed a long period of border incidents during which both sides mobilized their troops. Beginning in 1941, the Thai army crossed the border in massive numbers. In spite of General Boisboissel's wishes to establish a defense in depth, French high command decided to go for the first large-scale engagement in the area.

### BOARD PLACEMENT:

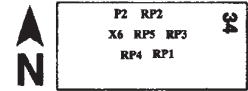

### BALANCE:

- Delete SSR 4
- Replace the 7 Thai 3-3-7 squads with 7 5-3-7 squads.

**VICTORY CONDITIONS:** The side that scored the most VPs wins at scenario end. Each side scores CVPs normally (EXC: Prisoners never count double their normal Victory Points). The French also score Exit VPs by exiting units on/between GG4 and GG7.

● THAI set up first	①	②	3	4	5	6	7	8	9	END
○ FRENCH move first										

**Elements of Yang Dang Khun garrison, Thai Royal Army [ELR:3]**  
set up HIP on/west of hexrow P {SAN:6}:

5-3-7	3-3-7	1-2-7	9-1	8-0	7-0	4-10	2-7	50*(1-16)*
4	7	2					2	

<p><b>Elements of 2<sup>nd</sup> Battalion, 2<sup>nd</sup> Colonial mixed Infantry Regiment [ELR:3]</b> set up in a single column [E11.5] on road hexes on/between H6 and N5 {SAN:2}:</p> <table border="1"> <tr> <td> 4-5-8</td> <td> 4-5-7</td> <td> 4-3-7</td> <td> 9-1</td> <td> 8-1</td> <td> 7-0</td> <td> 6-1</td> <td> 1-1</td> <td> 2-8</td> </tr> <tr> <td>2</td> <td>4</td> <td>18</td> <td></td> <td></td> <td></td> <td></td> <td></td> <td></td> </tr> </table>	4-5-8	4-5-7	4-3-7	9-1	8-1	7-0	6-1	1-1	2-8	2	4	18							<p><b>Elements of 2<sup>nd</sup> Battalion, 5<sup>th</sup> Colonial Artillery Regiment</b> set up in a single column in F6 and G7 (Guns are Towed and Crews passengers):</p> <table border="1"> <tr> <td> 75*</td> <td> 15PP</td> <td> 3-3</td> <td> 1-2-7</td> </tr> <tr> <td>2</td> <td>2</td> <td>2</td> <td></td> </tr> </table>	75*	15PP	3-3	1-2-7	2	2	2	
4-5-8	4-5-7	4-3-7	9-1	8-1	7-0	6-1	1-1	2-8																			
2	4	18																									
75*	15PP	3-3	1-2-7																								
2	2	2																									
<p><b>Elements of 3<sup>rd</sup> Battalion, 5<sup>th</sup> Colonial Infantry Regiment</b> enter on Turn 2 in a single column [E11.5] on A5 road:</p> <table border="1"> <tr> <td> 4-5-8</td> <td> 4-5-7</td> <td> 2-3-7</td> <td> 2-2-8</td> <td> 9-1</td> <td> 8-1</td> <td> 7-0</td> <td> 1-1</td> <td> 2-8</td> <td> 1-1</td> </tr> <tr> <td>4</td> <td>7</td> <td></td> <td></td> <td></td> <td></td> <td></td> <td></td> <td></td> <td>3</td> </tr> </table>	4-5-8	4-5-7	2-3-7	2-2-8	9-1	8-1	7-0	1-1	2-8	1-1	4	7								3							
4-5-8	4-5-7	2-3-7	2-2-8	9-1	8-1	7-0	1-1	2-8	1-1																		
4	7								3																		

Scenario Design: Brent Pollock '95

### SSR:

1. EC are moderate with a Mild Breeze blowing from the northwest at start. Kindling is NA. PTO terrain is in effect with Dense Jungle. Rice Paddies are drained. Road A5-P5-Q6-GG5 does exist.
2. Place the following overlays: 1 in DD8-DD9, P2 in oT7-oU7, X6 in oY7, RP5 in oX6-oX7, RP4 in oW9-oV8, RP2 in oU6-oV5 and RP1 in oT6.
3. Thai units are represented by Chinese units; Chinese troop rules don't apply [EXC: G18.2 does apply]. The 5-3-7 MMCs have Assault Fire.
4. No column may Disband [E11.53] as long as no Thai units are known to any French unit. When a Thai unit is known to a French unit, any column may Disband. The Columns must move toward the western edge at maximum speed without using Double-Time. French Green units have an ELR of 2.

**AFTERMATH:** In the night before the attack, the French artillery observers conducted a quick recon that largely underestimated the Thai forces. No more reconns were attempted, the French Command feeling them unnecessary. For that reason, the French-Cambodian forces left their positions without taking any security precautions and without coordination with the HQ. The Thai opposition was well equipped with semi-automatic and automatic weapons (The Thai army was modernized by the Americans in 1939). Confronted with this problem and with many snipers camouflaged in the trees, the Cambodian troops of the mixed Battalion ran away. The artillery was inefficient in this enclosed terrain and only the arrival of the Colonial troops allowed stabilization of the front. Luckily for the French Command, the Thai High Command didn't realize the situation and didn't exploit its advantage. Finally, at the end of the month, the fights stopped because of the cease-fire imposed by the Japanese.

# BREAKWATER

## SCENARIO ASL TAC 70

Translated by Coastal Fortress Gaming Group

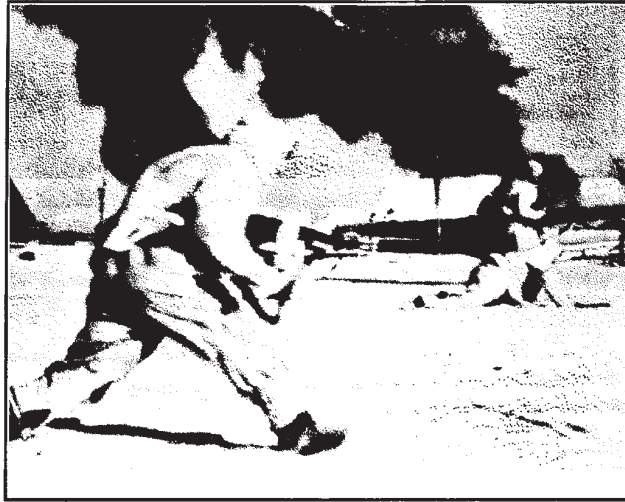

**VICTORY CONDITIONS:** The Russians win at scenario end if they control 4 of the 6 multi-hex buildings.

### VELIZH, 17 February 1942:

As part of the northern disposal of the Soviet winter offensive, the 4<sup>th</sup> Shock Army, commanded by General Eremenko, rushed on January 9 from the heights of Valдай toward the south and quickly advanced. Its objective was to seize Vitebsk, in order to cut off any retreat for the German Army Group Center. After having destroyed the 189<sup>th</sup> Silesian Infantry Regiment, the 4<sup>th</sup> Shock Army on January 21 attacked the important German supply center of Toropets. Temporarily freed in this manner from its supply constraints, The 4<sup>th</sup> Shock Army resumed its advance. Confronted with a 125 km wide breach between Velikie Louki and Rjev, the German Command formed the 59<sup>th</sup> Army Corp in Vitebsk. Its Commander, Von der Chevallerie, knew that his forces were for the moment only made up of the 83<sup>rd</sup> Infantry Division, freshly arrived from France, reinforced with some police battalions. He decided then to split its 3 Regiments in the most important towns, Velikie Louki, Zurazh and Velizh, to act as breakwaters to the advancing Soviet waves. In Velizh, Lieutenant-Colonel Sinzinger saw himself and his 257<sup>th</sup> Infantry Regiment totally encircled on January 29. Constantly attacked and lacking artillery, Sinzinger still received the following radio message: " Hold firm! The relief is closing".

### BALANCE:

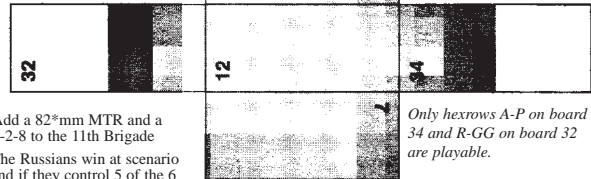

### BOARD PLACEMENT:

- ★ Add a 82\*mm MTR and a 2-2-8 to the 11th Brigade
- The Russians win at scenario end if they control 5 of the 6 multi-hex buildings

Only hexrows A-P on board 34 and R-GG on board 32 are playable.

◆ GERMANS move first	★ 1	2	3	4	5	6	7	8	9	10	END
★ RUSSIANS set up first											

**Elements 257<sup>th</sup> Infantry Regiment, 83<sup>rd</sup> Infantry Division [ELR:3] set up as indicated below {SAN:3}:**

set up ≤8 hexes from 12Q3:

**Reinforced elements of the 205<sup>th</sup> Infantry Division (Kampfgruppe Richter) enter on/after Turn 1 along the board 34 south edge (any/all may enter each turn):**

**Elements of 4<sup>th</sup> Shock Army [ELR:3] set up/enter as indicated below {SAN:2}:**

**Elements of the 11<sup>th</sup> Brigade**  
set up on board 7 in woods and/or building hexes on/between hexrows AA and P, west of the river:

**Elements of the 68<sup>th</sup> Ski Battalion**  
Sets up on board 32 in wood hexes (this unit is ski-equipped):

**Elements of 141<sup>st</sup> Tank Brigade**  
enter on Turn 1 on/between 43A1 and 43I1:

**Elements of 360<sup>th</sup> Brigade**  
enter on Turn 1 on/between 43T0 and 43Z0:

**Soviet Outpost set up on board 34 on/between hexrows J and M (these units are TI during Russian Turn 1):**

Scenario Design: G. Tourmire & Rousse-Lacordaire

### SSR:

- EC are Deep Snow (E3.73) with no wind at scenario start. Russian units have Winter Camouflage (E3.712). Buildings have no upper Levels. Place a Stone Rubble counter in 12R7. The Road 34P5-A5-12GG5-T6 is Plowed. No Road is paved.
- Extreme Winter is in effect (E3.74) [EXC: B#/X# of German AFV mounted SWs/Guns and/or from SWs/Guns in building hexes is reduced by 1 instead of 2]
- Trenches are connected to ADJACENT Building Locations. Infantry units do not expend MFs to enter/exit the Trench and are not subject to Snapshot if they enter/Exit a Building Location without using bypass. VBM is allowed to Vehicles otherwise allowed to enter a Trench Location (according MPs must be spent and Bog must be rolled).
- The first time a German non-crew MMC from KG Richter enters a board 12 multi-hex Building, all the remaining MMCs from the 257<sup>th</sup> Infantry Regiment become Fanatic and all Russian MMCs see their GO ML reduced by 1 for the rest of the scenario (Broken ML stay the same)

**AFTERMATH:** Thanks to Estonian and Lithuanian volunteers infiltrating the Russian positions, the Germans evaluated the enemy forces at near 30,000 men. Sinzinger, lacking ammunition (the Luftwaffe paraded his Iron Cross), knew he couldn't hold much longer. However, facing badly coordinated attacks, the defenders each time concentrated a sufficient volume of fire on the critical spot. On 17 February, hearing the booming of guns to the Northwest, the defenders knew that their 20 day ordeal was about to end. But the Soviets knew that too. For the last time they launched all their forces into the battle to enter Velizh before the arrival of the German reinforcements. Several times, assault elements succeeded in deeply entering the town, but they were defeated and pushed back with the help of the reinforcements. Velizh was finally freed, this showing, like in Velikie Louki, Demiansk or Kholm, the efficiency of the "breakwaters".

# TERMINUS SENED

## SCENARIO ASL TAC 71

Translated by Coastal Fortress Gaming Group

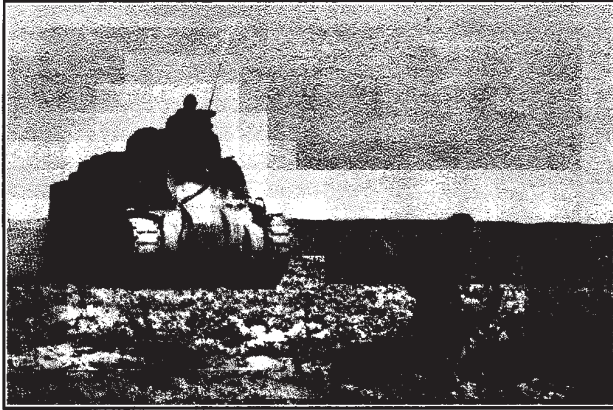

**VICTORY CONDITIONS:** The first side that scores  $\geq 30$ VPs wins the game. Each side scores CVPs normally. In addition the American scores 5VPs for each of both hexes 4O6 and 4P6 controlled (the according VPs are lost as soon the hex control is lost). The Germans start the game with 5VPs. If no side scores  $\geq 30$ VPs during the game, the side which controls building 4O6/4P6 at game end wins.

### SENEA railway station, 24 January 1943:

At the end of January 1943, the Axis forces had the initiative over the Allied forces in Tunisia. The French-American units in the Faïd and Gafsa sector had the mission of protecting the southern flank of the British First Army. General Fredendall, commandant of the American 2<sup>nd</sup> Corp, couldn't make up his mind on the appropriate strategy. He finally decided to launch an attack on the little town of Maknassy. Despite the criticism of several French and American officers that feared to reveal to the enemy the main objective of the attack, Fredendall ordered a preliminary raid on Sened Station, west of Maknassy. With this aim in view, elements of Combat Command C of the First Armored Division left Gafsa on 24 January at dawn. The German-Italian garrison of Sened was taken by surprise by the double flanking attack.

### BOARD PLACEMENT:

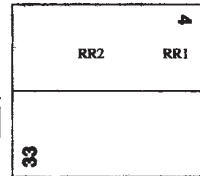

### BALANCE:

☛ ☛ The Axis starts the game with 8VPs

☆ The Axis starts the game with 3VPs

☛ ☛ AXIS sets up first	☆ 1	☆ 2	☆ 3	☆ 4	5 ☛	6	7	8	END
☆ AMERICANS move first									

**Reinforced elements of 1<sup>st</sup> squadron, 8<sup>th</sup> Infantry Division "Aosta" and of 69<sup>th</sup> battery, Bersaglieri Artillery [ELR:3] set up on board 4 on/between hexrows I and Y {SAN:3}:**

6	3	2	2				12	2	10
									factors

**Elements of 334<sup>th</sup> recon battalion enter on Turn 5 along east edge.**

2	3		2		2

**Elements of Company I, 13<sup>th</sup> Armored Regiment enter on Turn 1 along the south edge, having spent 7MPs**

4	10			2	2	2

**Elements of Company I, 6<sup>th</sup> Armored Infantry Regiment enter on Turns 2-4 on the west edge of board 4 (any/all may enter each turn), the HT having spent 10MPs.**

				5	

Scenario Design: Philippe Naud '95

### SSR:

- EC are Moderate, with no wind at start. Woods and Orchards are Olive Groves [F13.5]. They are considered Woods during the RtPh (only). Hedges are Cactus Hedges [F13.3]. All hexes numbered 5 on board 4 are Railways. These hexes may be marked with the Tactiques RR overlays (RR1 and RR2), or any convenient counters. These Railway hexes are all GLRR (B32). Place a Wooden rubble counter in 4N3 and 4P4.
- The Americans receive a 100+mm OBA module (HE and Smoke) with the first access being automatic (take out a black chit from the draw pile). The module is directed by an offboard observer secretly placed before Axis setup on Level 2 on the west edge of board 4.
- At the beginning of each of Turns 2-4, the Americans setup offboard the units that will enter during the Turn. Each unit placed in setup and that does not enter the playing area during the American Turn is eliminated (and count toward CVPs). All American units that have not setup on turns 2 or 3 must do it on Turn 4. The American sniper is placed at beginning of the Turn when the first American infantry unit sets up offboard.
- Before Axis setup, The American player secretly notes 3 Pre-Registered hexes. After his Turn 1 setup, a FFE:1 is placed on each of this 3 hexes, rolled for accuracy [C1.732], resolved as a 70mm+ HE FFE and taken off the playing area.
- The M3 (MMG) inherent squad is a 5-4-6.

**AFTERMATH:** At 1115, the American artillery opened fire. The tanks of the 13<sup>th</sup> Armored Regiment approached the railway station from the south while shelling the enemy positions. The infantry cautiously followed the tanks. Despite the shelling downpour, the Italian artillery crews managed to damage a Lee. The American west group encountered weak resistance. Two German armored cars lured the American tanks into a minefield (two Lees were immobilized) but one armored car was hit and destroyed. Despite these few losses, the attack was successful; the attackers returned to the bivouac with a hundred prisoners and only 2 wounded among them. The GL's, proud of their victory, appeared ready for the future fights.

# COMBAT FOR A TOWER

SCENARIO ASL TAC 72 Translated by Coastal Fortress Gaming Group



**VICTORY CONDITIONS:** Germans win at scenario end if there are no more GO Partisan MMC in/adjacent to AA7.

## ST. NAZAIRE EN ROYANS (DRÔME), FRANCE, 20 July 1944:

German troops prepared their assault on the Vercors: when the 157<sup>th</sup> Mountain Infantry Division got ready to attack on the northern and eastern sides, other troops blocked the access (and the exit) of the mountain to the south and west. On the west side, in the little village of St. Nazaire en Royans, one of the gates to the Vercors mountain, the company of Lieutenant Sabatier took position.

### BOARD PLACEMENT:



*Only hexrows R-GG are playable.*

### BALANCE:

✚ The Partisans that should enter on Turn 2 enter on Turn 3 instead

⊙ The 3-3-7s that enter on Turn 2 are 5-2-7s (underlined ML, partisan rules apply)

⊙ PARTISANS set up first	1	2	3	4	5	6	END
✚ GERMANS move first							

**Company Sabatier (12<sup>th</sup> Company, 2<sup>nd</sup> Battalion, Drôme secret army) [ELR:5]**  
set up as indicated below {SAN:4}:

set up East of the stream:

3-3-7	7-0	LMG 2-7	? 7 marks
5	2	6	

enter on Turn 1 along the east edge:

3-3-7	9-1	LMG 2-7	BAZ44 X11 8-4
2			

enter on Turn 2 on/between X10 and CC10:

3-3-7	7-0	LMG 2-7
2		

**Elements of 200<sup>th</sup> Police Regiment [ELR:3]**  
set up on hexrows R and/or S {SAN:2}:

set up on hexrows R and/or S {SAN:2}:

4-4-7	8-1	8-0	7-0	MMG 5-12	LMG 3-2	37L 18 1 37L -1-13*
12					2	(See SSR 2)

*Scenario Design: Patrick Martin '95*

### SSR:

- EC are Moderate with no wind at start. Kindling is NA. The Stream is a water obstacle that can be entered only by the Bridge. Building AA7 has a Level 2 location (with inherent stairwell and each of its locations (ground, Level 1, Level 2) has a stacking limit of 1 squad equivalent (plus up to four SMC per Location).
- The SPW 250/10 depicts an armored and modified French Unic P107 tractor. The SPW 250/10 counter characteristics are accordingly modified as follow: Normal Size, 10 MPs, Red MPs, ESB use French DRMs. All other characteristics remain unchanged.
- Partisans use US and British SWs without captured penalties. The Baz 44 suffers from Ammo Shortage. The SWs carried by the Partisans are kept offboard (with owners secretly noted) and placed onboard on their first use. Partisan can't from multi-location FGs.
- Germans have no PF capability.

**AFTERMATH:** The Germans attacked St Nazaire from the rear by crossing the Manne Bridge. The Partisans withdrew a hundred meters toward the St .Nazaire tower. Around 1500, the attackers tested the 12<sup>th</sup> company defenses, who resisted and succeeded to hold their positions until 0300. Lieutenant Sabatier then was ordered by the Vercors HQ to withdraw toward the Escalier Straits, this because the 157<sup>th</sup> Mountain Division had started its attack on the northern and southern sides of the mountain. The Vercors drama was beginning.



# HIMMLER'S HOUSE

## SCENARIO ASL TAC 73

Translated by Coastal Fortress Gaming Group



**VICTORY CONDITIONS:** Russians win at game end if they have at least twice more VP of GO Infantry than the Germans in the 23X0 building (X16 overlay building).

### BERLIN, GERMANY, 29 April 1945:

Despite the defenders heavy fire, assault groups from the first battalions of the 756<sup>th</sup> and 380<sup>th</sup> Infantry Regiment of the 150<sup>th</sup> Division succeeded in crossing the Moltke bridge during the night and established a bridgehead in the building on the corner of Kronprinzen Avenue. Before launching the assault of the Reichstag, a number of strongpoints were to be cleared: Kroll Opera, Alsenstrasse buildings and particularly the Department of Domestic Affairs building, otherwise called Himmler's House. This last building had been completely fortified and its defenders still had the Moltke Bridge under fire, preventing reinforcements from crossing it. General Peveretkine ordered the seizing of the position. The attack began around 0700 after a 10 minute artillery preparation.

### BOARD PLACEMENT:

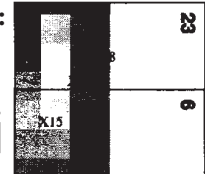

### BALANCE:

★ Add a hero to the Russian OB

✚ Replace the 9-1 leader with a 9-2 leader in the German OB

Only hexrows R-GG are playable.

✚ GERMANS set up	1	2	3	4	END
★ RUSSIANS move first					

**Elements of Waffen SS and of Volksturm [ELR:2/3] (see SSR 3):**  
set up on/south of hexrow 23GG6-6R8 (see SSR 2) {SAN:5}:

6<sup>2</sup>-5-8  
3

4-4-7  
2

4-3-6  
5

9-1  
  
 7-0

7-16  
  
 5-12

3-8  
 ?  
 7 mortar

**Flak 36:** set up concealed and emplaced on X15 overlay building rooftop (B23.85 is NA).

37L (8)

**Elements of 150<sup>th</sup> Division and of 10<sup>th</sup> Motorized Flamethrower Independent Battalion [ELR:4]**  
set up on/north of hexrow 23GG8-6R10 {SAN:3}:

6-2-8  
5

5-2-7  
6

9-2  
  
 8-0  
  
 8-0

24-1  
2

90-1  
2

**Support of the 79<sup>th</sup> Corp:**  
set up north of the Canal

4-4-7  
4

2-2-8  
2

8-1  
  
 8-12  
  
 4-10  
  
 76L  
2

152  
 13  
 11  
 14

Scenario Design: Jean-Luc Béchenne '95

### SSR:

1. EC are Moderate with no wind at start. BB5 bridge does not exist. Woods are shellholes. Buildings are stone. Single story buildings are Stone rubble. Orchards are out of season. Place the following overlays: X15 in 6Z7-Z6, X16 in 23X0-W1, X14 in 23U3-U2 and X18 in 23S4-R3. All locations of buildings from overlays X14, X15 and X16 are fortified [B29.3]
2. German units are considered fanatic for all purposes when in a building of overlay X16.
3. German SMCs and SS MMCs have an ELR of 3 (ML stays underlined), other units have an ELR of 2.
4. Because of the dust raised by the incessant shelling of the area, Mist (E3.32) applies.
5. HtH CC is in effect (J2.31).
6. Vehicular crew cannot voluntarily abandon their vehicles. GO Infantry crews can't drop possession of their Guns (and voluntarily leave the Gun location).

### AFTERMATH:

The Russian assault groups quickly entered the Department of Domestic Affairs building but the clearing of the building was another matter. Fanatical, the German defenders resisted resolutely, giving ground room by room only after bloody close combats. The battle raged the whole day and only the nighttime arrival of Russian reinforcements could break the German resistance. The building was finally controlled by the Russians on 30 April, around 0430. At the same time, small units from the 525<sup>th</sup> Regiment pushed up to the Alsenstrasse. The Final Assault could start.

# RED FLAG

SCENARIO ASL TAC 74 Translated by Coastal Fortress Gaming Group



**VICTORY CONDITIONS:** Russians win at game end if they have at least twice as many VP of GO Infantry than the Germans in the 6L10 building (Reichstag building). Prisoners do not count toward both sides VPs.

**BERLIN, GERMANY, 30 April 1945:**

After the fall of the Kroll Opera, across the road from the Department of Domestic Affairs, the Russians could finally concentrate on the Reichstag attack. The building, whose windows were all walled up since the 1933 fire, impressively overlooked the diplomatic block site. During the entire day of the 30th, the Russians launched attacks that successively failed. Moreover, the anti-aircraft guns of the Tiergarten Flak tower, only 3000 meters away, considerably hampered the troop progression. But the day was not fully wasted since infantry and artillery reinforcements were brought to support the final assault. At 1800, the last act of the Reichstag battle begun.

**BOARD PLACEMENT:**

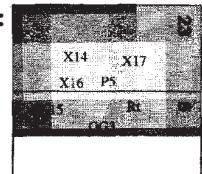

**BALANCE:**

- ★ Germans set up first
- ✳ German non-crew MMCs are fanatic while in the Rt overlay locations.

★ RUSSIANS set up first	1	2	3	4	5	6	7	8	END
★ RUSSIANS move first									

★

**Assault elements of 150<sup>th</sup> Division and of 10<sup>th</sup> Motorized Flamethrower Independent Battalion [ELR:4]**  
set up south of the canal on/west of hexrow P {SAN:2}:

6-2-8	5-2-7	4-5-8	10-2	9-1	8-1	8-0	6-12	4-10	24-1	30-1	6/7/8
8	8	4				2		2	3	3	

**Armored support of the 79<sup>th</sup> Corps:**  
set up south of the canal on/west of hexrow V:

13 11 122L 1/4 1/4	13 11 152 1/4	16 11 85L 2/4	9-2	9-1
2	2	3		

**Artillery elements of the 79<sup>th</sup> Corps:**  
set up north of the canal on/west of hexrow N:

76L	122	2-2-8
2	2	4

✚

**Elements of Waffen SS and of Volksturm [ELR:2/3] (see SSR 4):**  
set up south of the canal on/east of hexrow P {SAN:5}:

6-2-8	4-4-7	4-3-6	9-1	8-1	7-0	7-16	5-12	3-8	30-1	?
5	5	7				2		3	2	10

2-2-8	105	88L 45°/4°/3°	50L [75]
3			

*Scenario Design: Jean-Paul Gonçalves*

**SSR:**

1. EC are moderate with no wind at start. No Bridges exist, except X3. Woods are Shellholes. All buildings are Stone. Single story Houses are Stone Rubble. Orchards are out of season. Place the following overlays: **X15** in 6Z7-Z6, **X16** in 23X0-W1, **X14** in 23U3-U2, **X18** in 23S4-R3, **X17** in 23O4-O5, **Rt** in 6L10-K10, **OG3** in 6N5-M6 and **P5** in 23Q1-R1. Buildings 23Y7, **X15** and **X16** have playable rooftop locations. Buildings **X14**, **X15**, **X16** and **L10** (Reichstag) have all their locations (EXC: eventual rooftop) fortified (B23.9). Each hex of the **Rt** Building overlay has a Level 3 Location and a Level -1 Location (use cellar counters to represent them, even if normal building rules apply to these locations). No LOS exists between Level -1 Location of the **Rt** overlay building and Locations outside the building. Only the stairways (triangular symbols) may be used to enter Level -1 Locations from ground Locations. Overlay **Rt** building is not Burnable Terrain and cannot be rubbled. No AFV may enter any Location of the **Rt** building overlay.
2. Place 4 Shellholes in 23P3, 23P4, 23Q4 and 23Q5. Place 6 AT-Ditches from 6Q5 to 6Q10. These AT-Ditches are flooded and the MF cost to enter/exit is 3MF + COT instead of 2 (see B27.56). The cost to move from an AT-Ditch Location is 2MFs.

3. Because of the dust raised by the incessant shelling of the area, Mist (E3.32) applies.
4. The German 105 ART and 88L AA Guns suffer from Ammunition Shortage. German Guns may use Boreighting. Germans have a Level B Bobby Trap capability [A23.7] south of the canal. German DCs may setup HIP as Set DCs [A23.7]. German SMCs and SS MMCs have an ELR of 3 (ML stays underlined) other units have an ELR of 2.
5. Russian 6-2-8 are Assault Engineers [H1.22]. Russians receives a 120mm+ OBA module with Plentiful Ammo (HE and Smoke). Vehicular crew cannot voluntarily abandon their vehicles. Russian GO Infantry crews can't drop possession of their Guns (and voluntarily leave the Gun location).
6. HtH CC is in effect (J2.31).

**AFTERMATH:** The artillery support from the batteries located north of the Spree and from the tanks and assault guns allowed the Russian assaulting infantry to quickly progress. The defenders were however not disposed to surrender and several close combats developed inside the building. The 150<sup>th</sup> Division followed to clean the building. Although the issue was no longer in doubt, it was not until the 2<sup>nd</sup> of May that the last defenders, hiding in the huge building, finally surrendered.