

**COMPLEX SOLUTIONS
MADE SIMPLE.**



DEEP SEA ELECTRONICS PLC

DSE5520 AUTOMATIC MAINS FAILURE CONTROL MODULE

OPERATING MANUAL



Deep Sea Electronics Plc
Highfield House
Hunmanby
North Yorkshire
YO14 0PH
ENGLAND

Sales Tel: +44 (0) 1723 890099
Sales Fax: +44 (0) 1723 893303

E-mail: sales@Deepseapl.com
Website: www.deepseapl.com

DSE Model 5520 Control and Instrumentation System Operators Manual

© Deep Sea Electronics Plc

All rights reserved. No part of this publication may be reproduced in any material form (including photocopying or storing in any medium by electronic means or other) without the written permission of the copyright holder except in accordance with the provisions of the Copyright, Designs and Patents Act 1988. Applications for the copyright holder's written permission to reproduce any part of this publication should be addressed to Deep Sea Electronics Plc at the address above.

Any reference to trademarked product names used within this publication is owned by their respective companies.

Deep Sea Electronics Plc reserves the right to change the contents of this document without prior notice.

1 BIBLIOGRAPHY

1. IEEE Std C37.2-1996 IEEE Standard Electrical Power System Device Function Numbers and Contact Designations. Institute of Electrical and Electronics Engineers Inc. ISBN 1-55937-879-4
2. Diesel generator handbook. L.L.J.Mahon. ISBN 0-7506-1147-2
3. On-Site Power Generation. EGSA Education Committee. ISBN 0-9625949-3-8

TABLE OF CONTENTS

Section	Page
1 BIBLIOGRAPHY	2
2 INTRODUCTION	6
2.1 CLARIFICATION OF NOTATION USED WITHIN THIS PUBLICATION.	7
2.2 ICON DESCRIPTIONS.....	7
3 OPERATION	8
3.1 CONTROL.....	8
3.2 AUTOMATIC OPERATION	9
3.2.1 MAINS FAILURE.....	9
3.2.2 REMOTE START IN ISLAND MODE.....	11
3.2.3 REMOTE START ON LOAD.....	13
3.3 MANUAL OPERATION.....	15
3.4 TEST OPERATION.....	17
4 PROTECTIONS.....	19
4.1 WARNINGS.....	19
4.2 ANALOGUE PRE-ALARMS.....	23
4.3 SHUTDOWNS.....	26
4.4 ELECTRICAL TRIPS.....	30
4.5 ROCOF / VECTOR SHIFT	32
DESCRIPTION OF CONTROLS	33
4.6 TYPICAL LCD DISPLAY SCREENS.....	33
4.6.1 TYPICAL STATUS DISPLAY.....	33
4.6.2 TYPICAL INSTRUMENT DISPLAY	34
4.6.3 TYPICAL ALARM DISPLAY.....	34
4.6.4 TYPICAL EVENT DISPLAY	35
4.6.5 VIEWING THE INSTRUMENT AND EVENT LOG PAGES	36
4.6.6 SYNCHROSCOPE OPERATION	37
4.7 COMPLETE INSTRUMENTATION LIST.....	38
4.7.1 BASIC INSTRUMENTATION.....	38
4.7.2 ENHANCED ENGINE INSTRUMENTATION	38
4.8 ACCESSING THE FRONT PANEL CONFIGURATION EDITOR.....	39
4.8.1 ENTERING THE CONFIGURATION EDITOR PIN NUMBER.....	39
4.8.2 EDITING VALUES.....	40
4.8.3 LIST OF ADJUSTABLE PARAMETERS (MAIN CONFIGURATION EDITOR).....	41
4.8.4 LIST OF ADJUSTABLE PARAMETERS (APPLICATION EDITOR)	42
4.9 DISPLAY EDITOR	43
4.9.1 EDITING 'DISPLAY EDITOR' CONFIGURATION VALUES	43
5 LED IDENTIFICATION AND FRONT PANEL LAYOUT	45
5.1 CONFIGURABLE LED IDENTIFICATION DIAGRAM.....	45
6 LED INDICATORS AND LOGO INSERT.....	46
7 CONTROL PUSH-BUTTONS	47
8 INSTALLATION INSTRUCTIONS.....	50
8.1 PANEL CUT-OUT	50
8.2 COOLING.....	50
8.3 UNIT DIMENSIONS	50
9 ELECTRICAL CONNECTIONS.....	51
9.1 CONNECTION DETAILS.....	51
9.1.1 PLUG "A" 8 WAY.....	51
9.1.2 PLUG "B" 11 WAY.....	51
9.1.3 PLUG "C" 9 WAY	52
9.1.4 PLUG "D" 3 WAY	52

9.1.5	PLUG "E" 5 WAY	52
9.1.6	PLUG "F" 8 WAY	53
9.1.7	PLUG "G" 4 WAY	53
9.1.8	PLUG "H" 12 WAY	53
9.1.9	PC CONFIGURATION INTERFACE CONNECTOR.....	54
9.1.10	EXPANSION INTERFACE CONNECTOR	54
9.2	CONNECTOR FUNCTION DETAILS.....	55
9.2.1	PLUG "A" 8 WAY	55
9.2.2	PLUG "B" 11 WAY	55
9.2.3	PLUG "C" 9 WAY	56
9.2.4	PLUG "D" 3 WAY	56
9.2.5	PLUG "E" 5 WAY	57
9.2.6	PLUG "F" 8 WAY	57
9.2.7	PLUG "G" 4 WAY	57
9.2.8	PLUG "H" 12 WAY	58
9.3	ENGINE CONTROL UNIT INTERFACE	59
10	SPECIFICATION	60
11	COMMISSIONING	62
11.1.1	PRE-COMMISSIONING	62
11.2	BYPASSING ALARMS AT STARTUP	63
11.3	COMMISSIONING SCREENS	63
11.3.1	SCREEN 1	63
11.3.2	SCREEN 2	63
11.3.3	SCREEN 3	63
11.3.4	SCREEN 4	63
12	FAULT FINDING.....	64
13	TYPICAL WIRING DIAGRAM	65
14	FACTORY DEFAULT CONFIGURATION	66
15	SENDER WIRING RECOMMENDATIONS.....	70
15.1.1	USING EARTH RETURN (SINGLE WIRE) SENDERS.	70
15.1.2	USING INSULATED RETURN (TWO WIRE) SENDERS.	71
16	APPENDIX.....	72
16.1	5520 IDMT TRIPPING CURVES (TYPICAL).....	72
16.2	5510 SHORT CIRCUIT TRIPPING CURVES (TYPICAL).....	72
16.3	ACCESSORIES	73
16.3.1	OUTPUT EXPANSION	73
	RELAY OUTPUT EXPANSION (157).....	73
	LED OUTPUT EXPANSION (548)	73
16.3.2	INPUT EXPANSION (P130/P540/P541)	73
16.4	COMMUNICATIONS OPTION.....	74
16.4.1	DESCRIPTION	74
16.4.2	PC TO CONTROLLER (DIRECT) CONNECTION.....	74
16.4.3	MODEM TO CONTROLLER CONNECTION.....	74
16.4.4	RS485 LINK TO CONTROLLER	75
	TYPICAL BUILDING MANAGEMENT SCHEME USING RS485 MONITORING	76
16.4.5	MODBUS™.....	76
16.5	IEEE C37.2 STANDARD ELECTRICAL POWER SYSTEM DEVICE FUNCTION NUMBERS.....	77
16.6	ENCLOSURE CLASSIFICATIONS	79
	IP CLASSIFICATIONS	79
	NEMA CLASSIFICATIONS	80
12.	SYNCHRONISING NOTES.....	81
16.6.1	CHECK SYNC	81
16.6.2	AUTO SYNC	81
16.6.3	LOAD CONTROL	81
4	057-016 5520 OPERATING MANUAL ISSUE 6.1 18/06/07 AM	

MAINS CT	81
16.6.4 TYPICAL PEAK LOPPING SYSTEM.....	82

2 INTRODUCTION

The **DSE 5520** Module has been designed to allow the OEM to meet demand for increased capability within the industry. It has been primarily designed to allow the user to start and stop the generator and if required, transfer the load to the generator either manually or automatically, or in the event of the module detecting a mains failure. The user also has facility to view all the system operating parameters via the LCD display.

Utilising the inbuilt synchronising, volts matching and paralleling functions, the 5520 can also be used to parallel with the mains supply for no break return, peak lopping or power import / export functionality and load control.

The **DSE 5520** module monitors the incoming AC mains supply for under or over voltage / under or over frequency and instructs the generating set to start and to supply the load.

The **DSE 5520** module also monitors the engine, indicating the operational status and fault conditions; automatically shutting down the engine and giving a true first-up fault condition of an engine failure by a flashing COMMON ALARM LED. Exact failure mode information is indicated by the LCD display on the front panel.

The powerful Micro-processor contained within the module allows for a range of enhanced features to be incorporated as standard;

- *Full Multi-lingual LCD displays (including non-western character fonts).*
- *True RMS voltage monitoring.*
- *Power measurement instrumentation.*
- *Communications capability (RS485 or RS232 including GSM/SMS functions)*
- *Check Sync capability*
- *Automatic Sync capability*
- *Load control capability*
- *Fully configurable inputs for use as alarms or a range of different functions.*
- *Extensive range of output functions using built in relay outputs or relay expansion available.*
- *CAN instrumentation and diagnostics when connected to a compatible CAN (electronically controlled) engine controller.*





Selective operational sequences, timers and alarm trips can be adjusted by the customer via the integral front panel configuration editor.

Comprehensive configuration is made using the 5xxx For Windows™ software and 810 interface module













Access to critical operational sequences and timers for use by qualified engineers, can be barred by a security code. Module access can also be barred by PIN code. Selected parameters can be changed from the module's front panel.

The module is housed in a robust plastic case suitable for panel mounting. Connections to the module are via locking plug and sockets.

2.1 CLARIFICATION OF NOTATION USED WITHIN THIS PUBLICATION.

 NOTE:	Highlights an essential element of a procedure to ensure correctness.
 CAUTION!	Indicates a procedure or practice which, if not strictly observed, could result in damage or destruction of equipment.
 WARNING!	Indicates a procedure or practice which could result in injury to personnel or loss of life if not followed correctly.
 ©	Deep Sea Electronics Plc owns the copyright to this manual, which cannot be copied, reproduced or disclosed to a third party without prior written permission.

2.2 ICON DESCRIPTIONS

Symbol	Meaning	Description
	Stop/Reset	Stop the generator and reset any alarm conditions.
	Start	Start the generator (if in an appropriate mode).
	Auto	The controller will automatically start the generator when given a remote start command.
	Manual	The controller will start the generator under manual control. <i>(Separate Start command may be necessary)</i>
	Mains Failure Simulation (Test)	On AMF modules, this is used to simulate a mains failure event. (On-load test)
	Alarm Mute	Silences the audible warning device.
	Information	Changes the display to another page
	Up	Selects the previous item on the page
	Down	Selects the next item on the page
	Close mains	Close mains load switching device (manual mode only)
	Close generator	Close generator load switching device (manual mode only)
	Accept	Edit or save current selection (configuration mode only)
	Increase	Increase current selection (configuration mode only)
	Decrease	Decrease current selection (configuration mode only)

3 OPERATION

3.1 CONTROL

Control of the **DSE 5520** module is via push buttons mounted on the front of the module with **STOP/RESET, MANUAL, TEST, AUTO, LAMP TEST** and **ALARM MUTE** and **START** functions. For normal operation, these are the only controls which need to be operated. The smaller push buttons are used to access further information such as engine instruments and load switching operations. Detail of their operation is covered later in this document.

The following descriptions detail the sequences followed by a module containing the standard 'factory configuration'. Always refer to your configuration source for the exact sequences and timers observed by any particular module in the field.

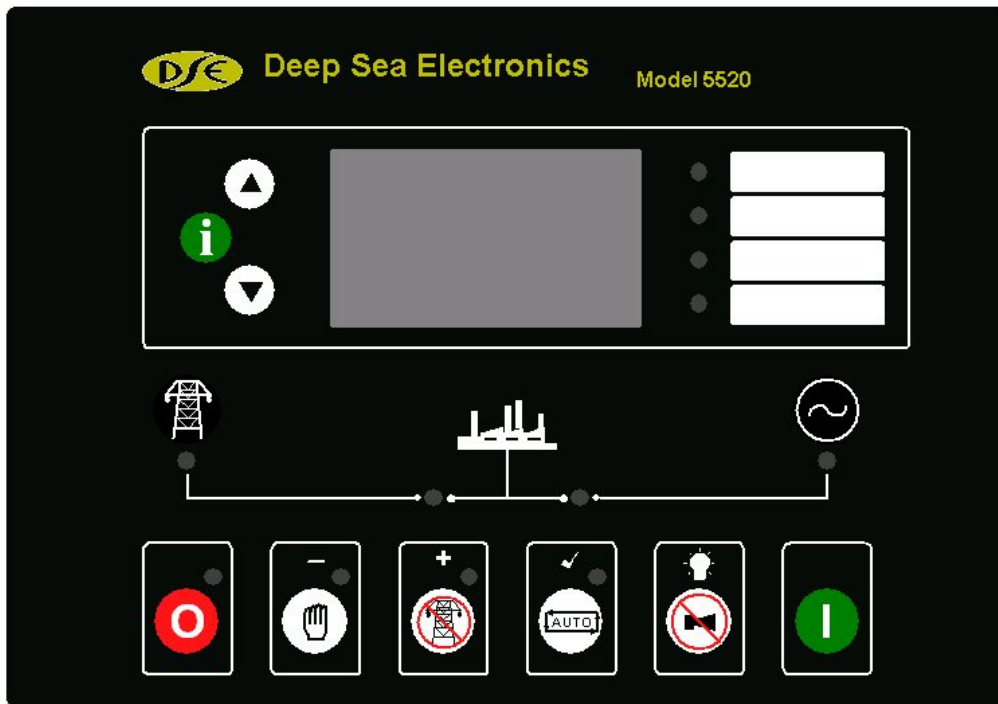

 **CAUTION:** - The module may instruct an engine start event due to external influences. Therefore, it is possible for the engine to start at any time without warning. Prior to performing any maintenance on the system, it is recommended that steps are taken to isolate DC supplies and remove the battery.

3.2 AUTOMATIC OPERATION

3.2.1 MAINS FAILURE

This mode of operation is used to ensure continuity of supply to critical loads during a mains failure condition. This is the normal mode of operation when installed on a standby generator.

NOTE: - If a digital input configured to panel lock is active, changing module modes will not be possible. Viewing the instruments  and  are NOT affected by panel lock. If panel lock is active the Panel lock indicator (if configured) illuminates.

This mode is activated by pressing the  pushbutton. An LED indicator beside the button will illuminate to confirm this operation.

Should the mains (utility) supply fall outside the configurable limits for longer than the period of the mains transient delay timer, the mains (utility) available GREEN indicator LED extinguishes.

To allow for short term mains supply transient conditions, the Start Delay timer is initiated. After this delay, if the pre-heat output option is selected then the pre-heat timer is initiated and the corresponding auxiliary output (if configured) will energise.

NOTE: - If the mains supply returns within limits during the Start Delay timer, the unit will return to a stand-by state.

After the above delays have expired the Fuel Solenoid (or enable ECU output if configured) is energised, then one second later, the Starter Motor is engaged.

NOTE:- If the unit has been configured for CAN Bus, compatible ECU's will receive the start command via CAN Bus. Refer to the Manual CAN and DSE Wiring. Part No. 057-004 for more information on utilising DSE modules with electronically controlled engines.

The engine is cranked for a pre-set time. If the engine fails to fire during this cranking attempt then the starter motor is disengaged for the pre-set rest period. Should this sequence continue beyond the set number of attempts, the start sequence will be terminated and Fail to Start fault will be displayed.

Alarm
Shutdown
Fail to start

When the engine fires, the starter motor is disengaged and locked out at a pre-set frequency measured from the alternator output. Alternatively, a Magnetic Pickup mounted on the flywheel housing can be used for speed detection (This is selected by PC using the 5xxx series configuration software). Rising oil pressure can also be used to disconnect the starter motor; however it cannot be used for underspeed or overspeed detection.

NOTE:- If the unit has been configured for CAN Bus, speed sensing is via CAN Bus.

After the starter motor has disengaged, the **Safety On** timer is activated, allowing Oil Pressure, High Engine Temperature, Under-speed, Charge Fail and any delayed Auxiliary fault inputs to stabilise without triggering the fault.

Once the engine is running, the **Warm Up** timer, if selected is initiated, allowing the engine to stabilise before accepting the load.

After the **Warm-up** timer has expired then the module will transfer the load from the failed mains supply to the generator output. It will observe the following sequence. The **Mains Contactor/Breaker** will be instructed to open and after a short delay (**transfer delay**), the **Generator Contactor/Breaker** will be instructed to close.

The generator will then supply the requirements of the load.

 **NOTE:-A load transfer will not be initiated until the Oil Pressure has risen. This prevents excessive wear on the engine.**

When the mains supply returns, the **Stop** delay timer is initiated. Once it has expired, the set is synchronised and paralleled with the mains supply. The system remains in this condition until expiry of the **Parallel run** timer. Once this has expired, the module will ramp the remaining load from the generator to mains supply. The Generator Contact/Breaker will open and the **Cooling** timer is then initiated, allowing the engine a cooling down period off load before shutting down. Once the **Cooling** timer expires, the **Fuel Solenoid** is de-energised, bringing the generator to a stop.

During the parallel run, the module can be configured to either run at a fixed level output, or to maintain an output in relation to the load level on the mains. For full details of these mode please refer to the manual 'The Guide to sync and load share Pt1'



Should the mains supply fall outside limits once again the set will return on load.

 **NOTE: - When synchronising is enabled, the mains supply is checked before closing any load switching device. If the supply is live, synchronising will take place before any closure takes place.**

 **NOTE: - Synchronising can be disabled if the application does not require this function. Contact your genset supplier in the first instance for further details.**

3.2.2 REMOTE START IN ISLAND MODE

This mode of operation is used to start the set in response to an external start requirement from another device. It may also be used to provide continuity of supply during expected black out events.

NOTE:- If a digital input configured to panel lock is active, changing module modes will not be possible. Viewing the instruments  and  are NOT affected by panel lock. If panel lock is active the Panel lock indicator (if configured) illuminates.

This mode is activated by pressing the  pushbutton. An LED indicator beside the button will illuminate to confirm this operation.

If the *remote start in island mode* input activates, the **Remote Start Active** indicator (if configured) illuminates.

To allow for false remote start signals, the Start Delay timer is initiated. After this delay, if the pre-heat output option is selected then the pre-heat timer is initiated and the corresponding auxiliary output (if configured) will energise.

NOTE:- If the Remote Start signal is removed during the Start Delay timer, the unit will return to a stand-by state.

After the above delays, the **Fuel Solenoid (or enable ECU** output if configured) is energised, and then one second later, the **Starter Motor** is engaged.

NOTE: - If the unit has been configured for CAN Bus, compatible ECU's will receive the start command via CAN Bus. Refer to the Manual CAN and DSE Wiring. Part No. 057-004 for more information on utilising DSE modules with electronically controlled engines.

The engine is cranked for a pre-set time. If the engine fails to fire during this cranking attempt then the starter motor is disengaged for the pre-set rest period. Should this sequence continue beyond the set number of attempts, the start sequence will be terminated and **Fail to Start** fault will be displayed.

Alarm
Shutdown
Fail to start

When the engine fires, the starter motor is disengaged and locked out at a pre-set frequency measured from the alternator output. Alternatively, a Magnetic Pickup mounted on the flywheel housing can be used for speed detection (This is selected by PC using the 5xxx series configuration software). Rising oil pressure can also be used to disconnect the starter motor; however, it cannot be used for underspeed or overspeed detection.

NOTE: - If the unit is configured for CAN Bus, speed sensing is via CAN Bus.

After the starter motor has disengaged, the **Safety On** timer is activated, allowing Oil Pressure, High Engine Temperature, Under-speed, Charge Fail and any delayed Auxiliary fault inputs to stabilise without triggering the fault.

Once the engine is running, the **Warm Up** timer, if selected is initiated, allowing the engine to stabilise before accepting the load.

 **NOTE: - A load transfer will not be initiated until the Oil Pressure has risen. This prevents excessive wear on the engine.**

The Generator will first be instructed to **synchronise** with the mains supply before closing the **Generator Contact/Breaker** and transferring load from mains to generator until the generator is supplying the required amount of power (adjustable using 5xxx configuration software).

When the supplies have been in parallel for the duration of the **parallel run time**, the load will ramp off the mains supply and onto the generator. The **Mains Contactor/Breaker** will be instructed to open.

The generator will then supply the requirements of the load.

When the remote start signal is removed, the **Stop** delay timer is initiated. Once it has expired, the set is synchronised and paralleled with the mains supply.

The system remains in this condition until expiry of the **Parallel run** timer. Once this has expired, the module will ramp the remaining load from the generator to mains supply.

The **Generator Contact/Breaker** will open and the **Cooling** timer is then initiated, allowing the engine a cooling down period off load before shutting down.



Once the **Cooling** timer expires, the **Fuel Solenoid** is de-energised, bringing the generator to a stop.

 **NOTE: - Synchronising can be disabled if the application does not require this function. Contact your generating set supplier in the first instance for further details.**

 **NOTE: - The internal 'Scheduler' can be configured to operate they system in the same manner as described for the Remote start input. Please refer to the 5xxx Configuration Software manuals for full details on the feature.**

3.2.3 REMOTE START ON LOAD

This mode of operation is used to start the set in response to rising load levels on the mains supply (if configured).

NOTE: - If a digital input configured to panel lock is active, changing module modes will not be possible. Viewing the instruments  and  are NOT affected by panel lock. If panel lock is active the Panel lock indicator (if configured) illuminates.

This mode is activated by pressing the  pushbutton. An LED indicator beside the button will illuminate to confirm this operation.

Should the load level on the mains supply exceed a pre-set level the module will initiate a start sequence.

To allow for short duration load surges, the Start Delay timer is initiated. After this delay, if the pre-heat output option is selected then the pre-heat timer is initiated and the corresponding auxiliary output (if configured) will energise.

NOTE: - If the load level returns below the pre-set level during the Start Delay timer, the unit will return to a stand-by state.

After the above delays, the **Fuel Solenoid (or enable ECU** output if configured) is energised, and then one second later, the **Starter Motor** is engaged.

NOTE: - If the unit has been configured for CAN Bus, compatible ECU's will receive the start command via CAN Bus. Refer to the Manual CAN and DSE Wiring. Part No. 057-004 for more information on utilising DSE modules with electronically controlled engines.

The engine is cranked for a pre-set time. If the engine fails to fire during this cranking attempt then the starter motor is disengaged for the pre-set rest period. Should this sequence continue beyond the set number of attempts, the start sequence will be terminated and **Fail to Start** fault will be displayed.

Alarm
Shutdown
Fail to start

When the engine fires, the starter motor is disengaged and locked out at a pre-set frequency measured from the alternator output. Alternatively, a Magnetic Pickup mounted on the flywheel housing can be used for speed detection (This is selected by PC using the 5xxx series configuration software). Rising oil pressure can also be used to disconnect the starter motor; however, it cannot be used for underspeed or overspeed detection.

NOTE: - If the unit is configured for CAN Bus, speed sensing is via CAN Bus.

After the starter motor has disengaged, the **Safety On** timer is activated, allowing Oil Pressure, High Engine Temperature, Under-speed, Charge Fail and any delayed Auxiliary fault inputs to stabilise without triggering the fault.

Once the engine is running, the **Warm Up** timer, if selected is initiated, allowing the engine to stabilise before accepting the load.

After the **Warm-up** timer has expired then the module will transfer the load from the mains supply to the generator output. It will observe the following sequence.

The Generator will first be instructed to **synchronise** with the mains supply. Once these are matched, the **Generator Contact/Breaker** will be instructed to close.

The load will then be **ramped** from the Mains to the appropriate level on the generator. The generator will then supply the requirements of the load.

 **NOTE: - A load transfer will not be initiated until the Oil Pressure has risen. This prevents excessive wear on the engine.**

When the *remote start on load* input is removed, the **Stop** delay timer is initiated. Once this timer has expired, the module will ramp the load from the generator to mains supply. The **Generator Contact/Breaker** will open and the **Cooling** timer is then initiated, allowing the engine a cooling down period off load before shutting down. Once the **Cooling** timer expires, the **Fuel Solenoid** is de-energised, bringing the generator to a stop.

During the parallel run, the module can be configured to either run at a fixed level output, or to maintain an output in relation to the load level on the mains.



 **NOTE: - When synchronising is enabled, the mains supply is checked before closing any load switching device. If the supply is live, synchronising will take place before any closure takes place.**



 **NOTE: - Synchronising can be disabled if the application does not require this function. Contact your genset supplier in the first instance for further details.**

 **NOTE: - The load level mode of operation relies on a Current Transformer (CT) fitted to the mains feed of the system. This is then used for measurement of the mains current used in the load level calculations.**

3.3 MANUAL OPERATION

Manual mode is used to allow the operator to control the operation of the generator, and to provide fault finding and diagnostic testing of the various operations normally performed during Automatic mode operation.

NOTE: - If a digital input configured to panel lock is active, changing module modes will not be possible. Viewing the instruments  and event logs  is NOT affected by panel lock. If panel lock is active the Panel lock indicator (if configured) illuminates.

MANUAL, mode is selected by pressing the  pushbutton. An LED besides the button will illuminate to confirm this operation. When the **START** () button is operated, the module will initiate the start sequence.

NOTE: - There is no Start Delay in this mode of operation.

If the **pre-heat** output option has been selected, this timer will be initiated and the auxiliary output selected energised.

After the above delay, the **Fuel Solenoid** (or **ECU** output if configured) is energised, and then one second later, the **Starter Motor** is engaged.

NOTE: - If the unit is configured for CAN Bus, compatible ECU's will receive the start command via CAN Bus. Refer to the Manual CAN and DSE Wiring. Part No. 057-004 for more information on utilising DSE modules with electronically controlled engines.

The engine is cranked for a pre-set time. If the engine fails to fire during this cranking attempt then the starter motor is disengaged for the pre-set rest period. Should this sequence continue beyond the set number of attempts, the start sequence will be terminated and **Fail to Start** will be displayed.

Alarm
Shutdown
Fail to start

When the engine fires, the starter motor is disengaged and locked out at a pre-set frequency measured from the Alternator output. Alternatively, a Magnetic Pickup mounted on the flywheel housing can be used for speed detection (This is selected by PC using the 5xxx series configuration software). Rising oil pressure can also be used to disconnect the starter motor; however, it cannot be used for underspeed or overspeed detection.

NOTE: - If the unit is configured for CAN Bus, speed sensing is via CAN Bus.

After the starter motor has disengaged, the **Safety On** timer is activated, allowing Oil Pressure, High Engine Temperature, Under-speed, Charge Fail and any delayed Auxiliary fault inputs to stabilise without triggering the fault.

Once the engine is running, the **Warm Up** timer (if selected) is initiated, allowing the engine to stabilise before it can be loaded. Once the warm up timer has expired, the generator is then available to go on load and the **Generator Available LED** will illuminate on the front panel.



The generator will run off load unless:

1. The mains supply fails,
2. A **Remote Start on load** signal is applied, or an on-load run is configured in the scheduler.
3. The  **Close Generator** button is pressed.

If any of the above signals are received, the generator is synchronised and paralleled with the mains supply (if available).

During the parallel run, the module can be configured to either run at a fixed level output, or to maintain an output in relation to the load level on the mains. For full details of these mode please refer to the manual 'The Guide to sync and load share Pt1'

Parallel operation:

- If the  **Close Generator** button is pressed again while in parallel, then the module will transfer the load fully to the generators, removing the load from the mains supply. This will be achieved by ramping the load from the parallel operating level to the generator. The Mains Contactor/Breaker will then be opened. Pressing the  **Close Mains** button will cause the module to re-synchronise the generator with the mains supply and then return to parallel operation.
- If the  **Close Mains** button is pressed while in parallel, the module will open the generator load switching device, transferring the load fully to the mains supply.

If **Auto** mode is selected and the mains supply is healthy, and the remote start on load signal not active, and the scheduler is not calling for a run, then the **Return Delay Timer** will start.

Once this has expired then the module will exit **parallel** operation and will ramp the load back to the mains supply. It will then open the **Generator Contactor/Breaker**. The generator will then run **off** load allowing the engine a **cooling** period.

Selecting **STOP (O)** de-energises the **FUEL SOLENOID**, bringing the generator to a stop.



 **WARNING: - Operation of the STOP button in any mode will stop the generator operation and return the load switching system to a safe state. This operation may lead to loss of supply to the load. It is recommended that the STOP button is only operated once the generator is OFF LOAD and the mains is supplying the load.**



 **NOTE: - Synchronising can be disabled if the application does not require this function. Contact your genset supplier in the first instance for further details. If synchronising is disabled the system will always perform an open transition when switching the load from the mains to the generator or when returning to the mains. The parallel run stages of the sequence are not used when operating in this way.**

 **NOTE: - When synchronising is enabled, the mains supply is checked before closing any load switching device. If the supply is live, synchronising will take place before any closure takes place.**

3.4 TEST OPERATION

Test operation is used to perform a full on load test sequence to allow for diagnosis of faults. Alternatively, it may also be used to provide continuity of supply during expected black out events, peak lopping or peak shaving during high tariff periods.

NOTE: - If a digital input configured to panel lock is active, changing module modes will not be possible. Viewing the instruments  and event logs  is NOT affected by panel lock. If panel lock is active the Panel lock indicator (if configured) illuminates.

TEST mode is initiated by pressing the  pushbutton. An LED besides the button will illuminate to confirm this operation. When the **START**  button is operated, the module will initiate the start sequence.

NOTE: - There is no Start Delay in this mode of operation.

If the **pre-heat** output option has been selected, this timer will initiate and the auxiliary output selected will be energised.

After the above delay, the **Fuel Solenoid (or ECU output if configured)** is energised, and then one second later, the **Starter Motor** is engaged.

NOTE: - If the unit has been configured for CAN Bus, compatible ECU's will receive the start command via CAN Bus. Refer to the Manual CAN and DSE Wiring. Part No. 057-004 for more information on utilising DSE modules with electronically controlled engines.

The engine is cranked for a pre-set time. If the engine fails to fire during this cranking attempt then the starter motor is disengaged for the pre-set rest period. Should this sequence continue beyond the set number of attempts, the start sequence will be terminated and **Fail to Start** will be displayed.

Alarm
Shutdown
Fail to start

When the engine fires, the starter motor is disengaged and locked out at a pre-set frequency from the Alternator output. Alternatively, a Magnetic Pickup mounted on the flywheel housing can be used for speed detection (This is selected by PC using the 5xxx series configuration software). Rising oil pressure can also be used to disconnect the starter motor; however, it cannot be used for underspeed or overspeed detection.

NOTE: - If the unit has been configured for CAN Bus speed sensing is via CAN Bus.

After the starter motor has disengaged, the **Safety On** timer is activated, allowing Oil Pressure, High Engine Temperature, Under-speed, Charge Fail and any delayed Auxiliary fault inputs to stabilise without triggering the fault.

Once the engine is running, the **Warm Up** timer, if selected is initiated, allowing the engine to stabilise before accepting the load.

After the **Warm-up** timer has expired then the module will transfer the load from the mains supply to the generator output. It will observe the following sequence.

The Generator will first be instructed to **synchronise** with the mains supply. Once these are matched the **Generator Contact/Breaker** will be instructed to close.

The load will then be **ramped** from the Mains to the appropriate level on the generator.

It will remain in this state whilst in the TEST mode.

If the module has an active *remote start in island mode input* or the internal scheduler has been configured for *island mode* then the **parallel run time** will activate. When this expires, the load will ramp off the mains supply and onto the generator. The **Mains Contactor/Breaker** will be instructed to open

The generator will then supply the requirements of the load.

 **NOTE:-A load transfer will not be initiated until the Oil Pressure has risen. This prevents excessive wear on the engine.**

The system will then remain in this mode of operation until a different mode is selected. It is

recommended that  mode is used to cancel the TEST mode.

When  mode is selected the **Stop** delay timer is initiated. Once it has expired, the set is synchronised and paralleled with the mains supply. The system remains in this condition until expiry of the **Parallel run** timer. Once this has expired the module will ramp the remaining load from the generator to mains supply. The **Generator Contact/Breaker** will open and the **Cooling** timer is then initiated, allowing the engine a cooling down period off load before shutting down. Once the **Cooling** timer expires the **Fuel Solenoid** is de-energised, bringing the generator to a stop.

During the parallel run the module can be configured to either run at a fixed level output, or to maintain an output in relation to the load level on the mains. For full details of these mode please refer to the manual 'The Guide to sync and load share Pt1'

 **NOTE:- When synchronising is enabled, the mains supply is checked before closing any load switching device. If the supply is live, synchronising will take place before any closure takes place.**

 **NOTE:- Synchronising can be disabled if the application does not require this function. Contact your genset supplier in the first instance for further details.**

4 PROTECTIONS

When an alarm is present the Audible Alarm will sound and the Common alarm LED (if configured) will illuminate.

The audible alarm can be silenced by pressing the 'Mute' button



The LCD display will jump from the 'Information page' to display the Alarm Page

Alarm	
Warning	← The type of alarm. Shutdown or warning
Low oil pressure	← The nature of alarm, e.g. Low oil pressure.

The LCD will display multiple alarms e.g. "High Engine Temperature shutdown", "Emergency Stop" and "Low Coolant Warning" alarms that may have been triggered. These will automatically scroll round in the order that they occurred.

In the event of a warning alarm the LCD will display the appropriate text. If a shutdown then occurs the module will again display the appropriate text.

Example:-

Alarm
Shutdown High coolant temp

Followed by....

Alarm
Shutdown Emergency stop

Followed by....

Alarm
Warning Low coolant level

The unit will scroll through all active alarms in a continuous loop.

Alarm
Shutdown High coolant temp

Generator available
L-N 229v 0A
L-L 400v 50.0Hz
pf 0.00 0KW

If no alarms are present the LCD will display this default page.

4.1 WARNINGS

Warnings are non-critical alarm conditions and do not affect the operation of the generator system. They draw the operators' attention to an undesirable condition.

In the event of an alarm the LCD will jump to the alarms page and scroll through all active warnings and shutdowns.

BATTERY CHARGE FAILURE, will be displayed if the module does not detect a voltage from the warning light terminal on the auxiliary charge alternator.

Alarm
Warning
Charge alt failure

BATTERY LOW VOLTAGE will be displayed if the module detects that the plant DC supply has fallen below the low volts setting level. The Battery Low Voltage alarm is delayed by the Low DC Volts Delay timer.

Alarm
Warning
Low battery voltage

BATTERY HIGH VOLTAGE will be displayed if the module detects that the plant DC supply has risen above the high volts setting level. The Battery High Voltage alarm is delayed by the High DC Volts Delay timer.

Alarm
Warning
High battery voltage

FAIL TO STOP, will be displayed if the module detects the engine is still running when the 'Fail to stop timer' expires.

Alarm
Fail to stop

 **NOTE:- 'Fail to Stop' could indicate a faulty oil pressure sender - If engine is at rest check oil sender wiring and configuration.**

AUXILIARY INPUTS, auxiliary inputs can be user configured and will display the message as configured in the module.

Example

Alarm

Warning
Bearing temp high

LOW FUEL LEVEL, will be displayed if the fuel level detected by the fuel level sender falls below the low fuel level setting.

Alarm

Warning
Low fuel level

LOW ENGINE TEMPERATURE, if the module detects that the engine coolant temperature has fallen below the low engine temperature pre-alarm setting level, a warning will occur. Alarm Warning Low Coolant Temp will be displayed.

Alarm

Warning
Low Coolant Temp

GENERATOR FAILED TO OPEN, if the module requests the generator contact/breaker to open it will monitor the auxiliary contacts for feedback that this has happened. If the feedback does not confirm the action within the Generator breaker open timer, then the following alarm will occur.

Alarm

Warning
Gen failed to open

MAINS FAILED TO CLOSE, if the module requests the mains contact/breaker to close it will monitor the auxiliary contacts for feedback that this has happened. If the feedback does not confirm the action within the Mains breaker close timer, then the following alarm will occur.

Alarm

Warning
Mains failed to close

MAINS FAILED TO OPEN, if the module requests the mains contact/breaker to open it will monitor the auxiliary contacts for feedback that this has happened. If the feedback does not confirm the action within the Mains breaker open timer, then the following alarm will occur.

Alarm

Warning
Mains failed to open

MAINTENANCE DUE, The module can be configured to monitor either engine running hours or absolute time, or both. Should either of these values exceed the pre-set service interval the following alarm will occur..

Alarm

Warning
Maintenance Due

The following alarms are only applicable if synchronising is enabled:

FAILED TO SYNCHRONISE, if the module cannot synchronise within the timer allowed by the Synchronising timer a warning is initiated. The LCD will indicate '**FAILED TO SYNC**' .

Alarm

Warning
Failed to synchronise

GENERATOR PHASE SEQUENCE WRONG, if the module detects a bus phase rotation error a warning is initiated. The LCD will indicate '**GEN PHASE SEQ WRONG**' .

Alarm

Warning
Gen phase Seq Wrong

MAINS PHASE SEQUENCE WRONG, if the module detects a MAINS phase rotation error a warning is initiated. The LCD will indicate '**MAINS PHASE SEQ WRONG**' .

Alarm

Warning
Mains phase Seq Wrong

NEGATIVE PHASE SEQUENCE, if the module detects an imbalance in the load current of each phase above a pre-set level, then the following warning will occur.

Alarm

Warning
Negative phase
Sequence

4.2 ANALOGUE PRE-ALARMS

The following alarms are termed 'pre-alarms' as they pre warn the operator of a potentially more serious alarm condition. For instance, if the engine temperature rises past the pre alarm level, a warning condition will occur to notify the operator. If the temperature falls below this level, then the alarm ceases and the set will continue to run as normal. However if the temperature continues to rise until the coolant temperature trip point is reached, the warning is escalated and a high coolant temperature shutdown is initiated.

LOW OIL PRESSURE, if the module detects that the engine oil pressure has fallen below the low oil pressure pre-alarm setting level after the **Safety On** timer has expired, a warning will occur. Alarm Warning Low Oil Pressure will be displayed.

Alarm

**Warning
Low oil pressure**

HIGH ENGINE TEMPERATURE, if the module detects that the engine coolant temperature has exceeded the high engine temperature pre-alarm setting level after the **Safety On** timer has expired, a warning will occur. Alarm Warning High Coolant Temperature will be displayed.

Alarm

**Warning
High coolant temp**

OVERSPEED, if the engine speed exceeds the pre-alarm trip a warning is initiated. Alarm Warning Overspeed will be displayed. It is an **immediate warning**.

Alarm

**Warning
Overspeed**

UNDERSPEED, if the engine speed falls below the pre-set pre-alarm after the Safety On timer has expired, a warning is initiated. Alarm Warning Underspeed will be displayed.

Alarm

**Warning
Underspeed**

GENERATOR HIGH CURRENT, if the module detects a generator output current in excess of the pre-set trip a warning is initiated. Alarm Warning High Current will be displayed. If this high current condition continues for an excess period of time, then the alarm is escalated to a shutdown condition. For further details of the high current alarm, please see High Current Shutdown Alarm.

Alarm

**Warning
Over current**

GENERATOR HIGH FREQUENCY, if the module detects a generator output frequency in excess of the pre-set pre-alarm, a warning is initiated. Alarm Warning High frequency will be displayed, it is an **immediate warning**.

Alarm
Warning Gen high frequency

GENERATOR LOW FREQUENCY, if the module detects a generator output frequency below the pre-set pre-alarm after the Safety On timer has expired, a warning is initiated. Alarm Warning Low Frequency will be displayed

Alarm
Warning Gen low frequency

GENERATOR HIGH VOLTAGE, if the module detects a generator output voltage in excess of the pre-set pre-alarm, a warning is initiated. Alarm Warning High voltage will be displayed, it is an **immediate warning**.

Alarm
Warning Gen high voltage

GENERATOR LOW VOLTAGE, if the module detects a generator output voltage below the pre-set pre-alarm after the Safety On timer has expired, a warning is initiated. Alarm Warning Low Voltage will be displayed.

Alarm
Warning Gen low voltage



CAN ECU ERROR, If the module is configured for **CAN Bus instruments** and receives an "error" message from the engine control unit, 'Can ECU error' is shown on the module's display and a warning alarm is generated.

Example

Alarm
Can ECU error Exhaust high temperature

The display will alternate between the text display and the manufacturers error codes

Alarm
Can ECU error SPNnnnnnnn FMInnnnnnn

INSUFFICIENT CAPACITY, if the module is configured to limit the import Kw on the mains supply, variations in the load levels will be matched by increasing the Kw on the generator. Should the load level increase to a sufficient demand that the generator is giving 100% of its rating. Further increases in demand will need to be met by increasing the Kw on the mains supply as the generator cannot supply any more. The system will issue the warning alarm to indicate that it can no longer regulate the Kw present on the mains until the total load level is reduced.

Alarm

**Warning
Insufficient Capacity**

LOSS OF EXCITATION, the module will monitor the KVA_r present on the generator. Should this exceed a pre-set amount of negative VA_r this indicates a possible loss of excitation on the alternator. The following alarm will then be generated.

Alarm

**Warning
Loss of Excitation**

4.3 SHUTDOWNS

Shutdowns are latching and stop the Generator. The alarm must be cleared and the fault removed to reset the module.

NOTE:- The alarm condition must be rectified before a reset will take place. If the alarm condition remains it will not be possible to reset the unit (The exception to this is the Low Oil Pressure alarm and similar 'delayed alarms', as the oil pressure will be low with the engine at rest).

FAIL TO START, if the engine does not fire after the pre-set number of attempts has been made a shutdown will be initiated. Alarm Shutdown Fail To Start will be displayed.

Alarm
Shutdown
Fail to start

EMERGENCY STOP, removal of the **positive DC** Supply from the Emergency Stop input will initiate a shutdown of the Generator and prevent any attempt to restart the Generator until the Emergency Stop push-button has been reset. Additionally it removes the **positive DC** supply from both the Fuel Solenoid and Starter Solenoid.

Alarm Shutdown Emergency Stop will be displayed.

Alarm
Shutdown
Emergency stop

NOTE:- The Emergency Stop positive signal must be present otherwise the unit will shutdown.

LOW OIL PRESSURE, if the module detects that the engine oil pressure has fallen below the low oil pressure trip setting level after the **Safety On** timer has expired, a shutdown will occur. Alarm Shutdown Low Oil Pressure will be displayed.

Alarm
Shutdown
Low oil pressure

HIGH ENGINE TEMPERATURE, if the module detects that the engine coolant temperature has exceeded the high engine temperature trip setting level after the **Safety On** timer has expired, a shutdown will occur. Alarm Shutdown High Engine Temperature will be displayed.

Alarm
Shutdown
High coolant temp

OVERSPEED, if the engine speed exceeds the pre-set trip a shutdown is initiated. Alarm Shutdown Overspeed will be displayed. Overspeed is not delayed, it is an **immediate shutdown**.

Alarm
Shutdown
Overspeed

 **NOTE:-During the start-up sequence the overspeed trip logic can be configured to allow an extra trip level margin. This is used to prevent nuisance tripping on start-up - Refer to the 55xx series configuration software manual under heading 'Overspeed Overshoot' for details.**

UNDERSPEED, if the engine speed falls below the pre-set trip after the Safety On timer has expired, a shutdown is initiated. Alarm Shutdown Underspeed will be displayed.

Alarm
Shutdown
Underspeed

GENERATOR HIGH FREQUENCY, if the module detects a generator output frequency in excess of the pre-set trip a shutdown is initiated. Alarm Shutdown High Frequency will be displayed, it is an **immediate shutdown**.

Alarm
Shutdown
Gen high frequency

GENERATOR LOW FREQUENCY, if the module detects a generator output frequency below the pre-set trip after the Safety On timer has expired, a shutdown is initiated. Alarm Shutdown Low Frequency will be displayed.

Alarm
Shutdown
Gen low frequency

GENERATOR HIGH VOLTAGE, if the module detects a generator output voltage in excess of the pre-set trip a shutdown is initiated. Alarm Shutdown High Volts will be displayed, it is an **immediate shutdown**.

Alarm
Shutdown
Gen high voltage

GENERATOR LOW VOLTAGE, if the module detects a generator output voltage below the pre-set trip after the Safety On timer has expired, a shutdown is initiated. Alarm Shutdown Low Volts will be displayed.

Alarm
Shutdown
Gen low voltage

 **NOTE:-Generator voltage and frequency alarms can be delayed by the 'Gen Transient ignore' timer. This is to prevent nuisance tripping when applying or removing load on the generator.**

OIL PRESSURE SENDER OPEN CIRCUIT, if the module detects a loss of signal from the oil pressure sender (open circuit) a shutdown is initiated. Alarm Shutdown Sender Fault will be displayed. Sender failure is not delayed, it is an **immediate shutdown**.

Alarm
Shutdown
Oil press sender fault

MAGNETIC PICKUP OPEN CIRCUIT, if the module detects a problem with the connection to the magnetic pickup (open circuit) a shutdown is initiated. MPU failure is not delayed, it is an **immediate shutdown**.

Alarm
Shutdown
MPU open circuit

AUXILIARY INPUTS, if an auxiliary input has been configured as a shutdown the appropriate message will be displayed as configured by the user.

Alarm
Shutdown
Bearing temp high

LOSS OF SPEED SIGNAL, if the speed sensing signal is lost during cranking, a shutdown is initiated. Alarm Shutdown Loss of Speed Signal will be displayed.

Alarm
Shutdown
Loss of speed signal

NOTE:- This will only occur if the magnetic pickup speed sensing signal is lost during cranking or during the safety on timer. If the signal is lost during normal operation the Generator will shutdown with an Under-speed alarm.



CAN DATA FAIL, If the module is configured for CANbus operation and does not detect data on the engine CANbus datalink, a shutdown will occur and 'Can data fail' is shown on the module's display.

Alarm
Shutdown
Can data fail



CAN ECU FAIL, If the module is configured for **CANbus** operation and receives a “fail” message from the engine control unit, the engine is shutdown and ‘Can ECU fail’ is shown on the module’s display.

Example

Alarm

**Can ECU fail
Fuel pressure low**

The display will alternate between the text display and the manufacturers error codes

Alarm

**Can ECU fail
SPNnnnnnnn
FMIInnnnnn**



NOTE: - If the CAN message is a manufacturers specific code, it may not be displayed as text. If this is the case, the display will show the generic manufacturers code only, which must be cross-referenced with the engine manufacturers literature. Please contact the engine manufacturer for further assistance.

The above displays show a standard J1939 based system. Other manufacturers systems supported by the module work in a similar way though the exact detail may vary from those illustrated.

Example

Alarm

**Can ECU fail
SPNnnnnnn
FMIInnnn**

GENERATOR EARTH FAULT, if the module detects a generator earth fault current in excess of the pre-set trip a shutdown is initiated. The LCD will indicate ‘**EARTH FAULT**’. This alarm is configurable between Warning, Shutdown and Electrical Trip. “Shutdown” is the factory default setting.

Alarm

**Shutdown
Earth Fault**

AIR FLAP CLOSED, if the module detects feedback to indicate that the engine air intake flap is closed a shutdown alarm will be initiated.

Alarm

**Shutdown
Air flap closed**

NEGATIVE PHASE SEQUENCE, if the module detects an imbalance in the load current of each phase above a pre-set level, then the following shutdown will occur.

Alarm

**Shutdown
Negative phase
Sequence**

4.4 ELECTRICAL TRIPS

Electrical trips are latching and stop the Generator but in a controlled manner. On initiation of the electrical trip condition the module will de-energise the '**Close Generator**' Output to remove the load from the generator. Once this has occurred the module will start the Cooling timer and allow the engine to cool off-load before shutting down the engine. The alarm must be accepted and cleared and the fault removed to reset the module.

AUXILIARY INPUTS, if an auxiliary input has been configured as an electrical trip the appropriate message will be displayed as configured by the user.

Example

Alarm

**Electrical trip
Output breaker tripped**

The following alarms are configurable between Warning, Shutdown and Electrical Trip. "Electrical Trip" is the factory default setting.

GENERATOR HIGH CURRENT, if the module detects a generator output current in excess of the pre-set trip a warning is initiated. This warning will continue for a period of time depending upon the level of overload that the generator is subjected to and the configuration setting for Generator High Current in the 5xxx series configuration software.

Alarm

**Shutdown
High current trip**

For instance, the factory default settings for Generator High Current allow for a loading of the generator to 110% for one hour. That is to say if the generator load level exceeds the trip point by 10%, a warning alarm will occur while the overload condition exists. If the load level does not drop to normal levels within one hour, the breaker is opened and set is cooled down and stopped.

NOTE:- Higher overload levels will result in a faster acting shutdown condition. For instance with the factory default configuration, an overload level twice that of the trip level (typically 200%) will result in a Generator High Current shutdown condition after 36 seconds. For details of the relationship between the overload and the shutdown time, please see the Appendix section of this manual.

GENERATOR REVERSE POWER, if the module detects a generator reverse power current in excess of the pre-set trip a shutdown is initiated. The LCD will indicate '**GEN REVERSE POWER**'.

Alarm

**Electrical trip
Gen Reverse Power**

GENERATOR SHORT CIRCUIT, if the module detects a generator fault current in excess of the pre-set trip a shutdown is initiated. The LCD will indicate '**GEN SHORT CIRCUIT**'.

Alarm

**Electrical trip
Gen Short Circuit**

MAINS REVERSE POWER, the module will monitor the amount of power being exported to the mains supply. If this is above the setting for the 'export power level alarm' then the following will be displayed.

Alarm

**Electrical trip
Mains Reverse Power**

LOSS OF EXCITATION, the module will monitor the KVA_r present on the generator. Should this exceed a pre-set amount of negative VA_r this indicates a possible loss of excitation on the alternator. The following alarm will then be generated.

Alarm

**Electrical trip
Loss of Excitation**

NEGATIVE PHASE SEQUENCE, if the module detects an imbalance in the load current of each phase above a pre-set level, then the following trip will occur.

Alarm

**Electrical trip
Negative phase
Sequence**

INSUFFICIENT CAPACITY, if the module is configured to limit the import Kw on the mains supply, variations in the load levels will be matched by increasing the Kw on the generator. Should the load level increase to a sufficient demand that the generator is giving 100% of its rating. Further increases in demand will need to be met by increasing the Kw on the mains supply as the generator cannot supply any more. The system will issue the trip to indicate that it can no longer regulate the Kw present on the mains until the total load level is reduced.

Alarm

**Electrical trip
Insufficient Capacity**

GENERATOR FAILED TO CLOSE, if the module requests the generator contact/breaker to close it will monitor the auxiliary contacts for feedback that this has happened. If the feedback does not confirm the action within the Generator breaker close timer, then the following trip will occur.

Alarm



**Electrical trip
Gen failed to close**

4.5 ROCOF / VECTOR SHIFT

When configured to run in parallel with the mains (utility) supply, the module monitors for ROCOF / Vector shift trips according to the module's configuration settings. This is included within the module and will detect failure of the mains supply during parallel operation with the generator.

NOTE:- This protection operates only when in parallel with the mains supply and is disabled at all other times.

Should either of these alarms operate, the module will perform either a controlled shutdown (electrical trip) of the generator or will instigate the mains failure function. This operation must be manually reset :

- 1) Press  button. The engine will stop if it is still running and the alarm is cleared.
- 2) Activate digital input configured to "Clear ROCOF/Vector shift" if this has been provided.
- 3) Press  and  button together and hold for 5 seconds. The ROCOF/Vector shift instrument is displayed and all 'peak hold' values are reset, clearing the ROCOF/Vector shift alarm.

Alarm

Electrical Trip
Mains ROCOF

Alarm

Electrical Trip
Mains Vector Shift

Alarm

Electrical Trip
Mains Decoupling
Low Frequency

Alarm

Electrical Trip
Mains Decoupling
High Frequency

Alarm

Electrical Trip
Mains Decoupling
Low Voltage

Alarm

Electrical Trip
Mains Decoupling
High Voltage

For details on activating and configuring the ROCOF/Vector shift protection you are referred to the 5xxx for Windows configuration software manual.

DESCRIPTION OF CONTROLS

The following section details the function and meaning of the various controls on the module.

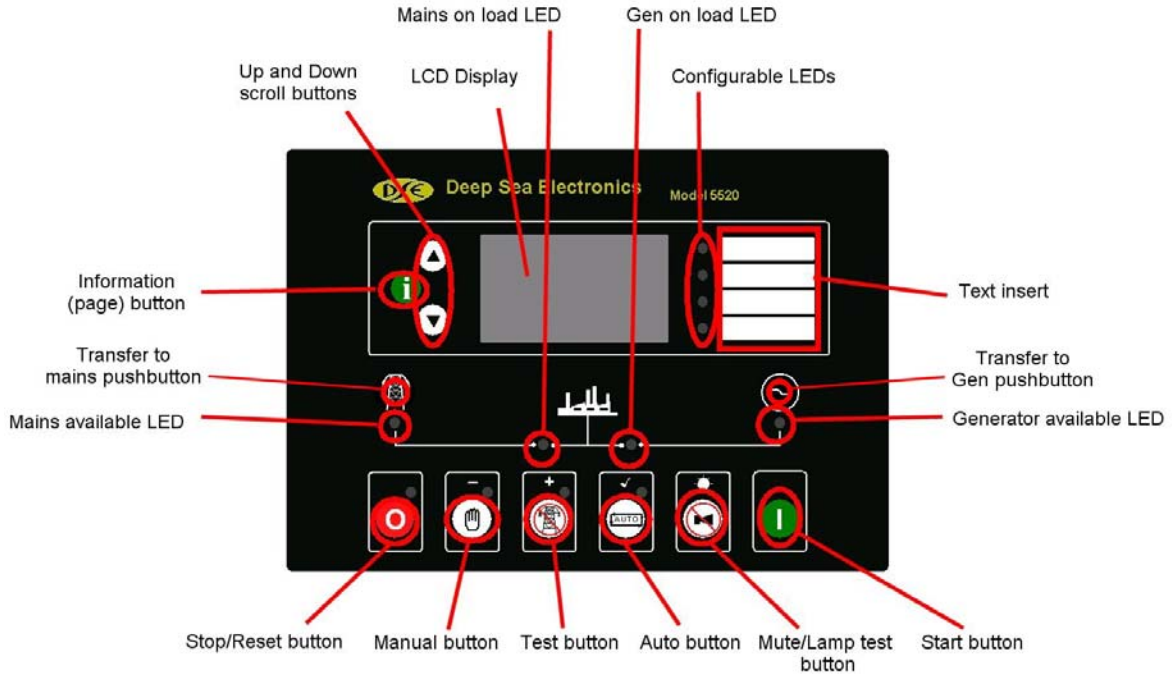

4.6 TYPICAL LCD DISPLAY SCREENS

4.6.1 TYPICAL STATUS DISPLAY

Status	
Mains available	Indicates that the module is in Automatic and that the mains is on load (closed). The unit will respond to either a mains failure or an active remote start.
Auto mode	
Status	
Cranking attempt	Indicates that the module is in automatic and that a start sequence has been initiated, either by a mains failure or remote start input. The module is attempting to crank the generator.
2 00.06	
Auto mode	
Generator available	
L-N 229v 0A	If no alarms are present the LCD will display this default page.
L-L 400 v 50.0hz	
Pf 0.00 0KW	

4.6.2 TYPICAL INSTRUMENT DISPLAY

Engine oil pressure	
6.2 Bar 90 Psi 620 KPa	The display of the engine oil pressure

Coolant temperature	
74 °C 165 °F	The display of the engine coolant temperature

Generator Amps	
L1 50A L2 52A L3 50A	The display of all three generator line currents.

4.6.3 TYPICAL ALARM DISPLAY

Alarm	
Warning Low oil pressure	The module is warning that the engine oil pressure has fallen below a pre set level. The generator is not shutdown.

Alarm	
Shutdown Low oil pressure	The oil pressure has fallen below a second pre set value and has shutdown the generator.

Alarm	
Warning Low battery Volts	The module is warning that the battery voltage is below a pre set value.

4.6.4 TYPICAL EVENT DISPLAY

Event log	1	
17 Jan 2005 16:29:49 Mains failure		On the 17 th January 2005 at 16:29 the unit detected a mains failure condition
Event log	2	
8 Sep 2004 20:10:05 Emergency stop		On the 8 th September 2004 at 20:10. The emergency stop button was pressed and the generator was shutdown.
Event log	3	
7 Sep 2004 08:46:00 Over Volts Shutdown		On the 7 th September 2004 at 08:46, the unit detected that the generator output volts exceeded pre-set trip level and has

4.6.5 VIEWING THE INSTRUMENT AND EVENT LOG PAGES

To view a particular instrument, operate the “Page” button to move to the required page.





The LCD will display the page title and then will automatically commence scrolling down the various instruments. On reaching the last instrument, the LCD display will then jump back to the page title and resume scrolling down the page. This sequence will be repeated until either the user moves off the page or an alarm condition occurs. In the case of the latter the module will jump to the alarm page to show the relevant alarm details.

Engine speed
0 RPM

Engine oil pressure
6.2 Bar
90 Psi
620 KPa

Coolant temperature
74 °C
165 °F

Etc....

It is also possible to scroll to display the different instruments using the  and  buttons. Once selected the instrument will remain on the LCD display until the user selects a different instrument or page, or after a period of inactivity, the module will revert to the ‘Status page’.

 **NOTE:-This description of operation is also true for the other instrument pages and for viewing the records in the event log.**

 **NOTE:- The factory default setting is to show all instruments in a single list. It is possible to change this configuration to a “page” style display using the 5xxx configuration software. When configured to the page style, the instruments are grouped into separate pages – i.e. Engine instruments, Gen instruments, Mains instruments.**

4.6.6 SYNCHROSCOPE OPERATION

(When enabled)

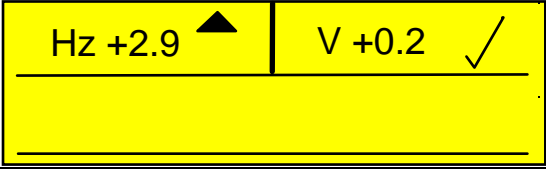
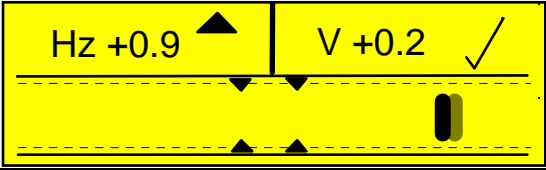
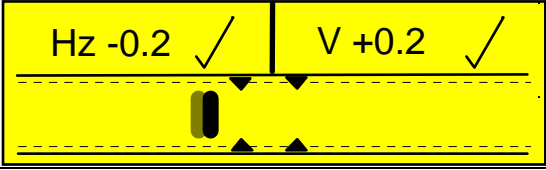
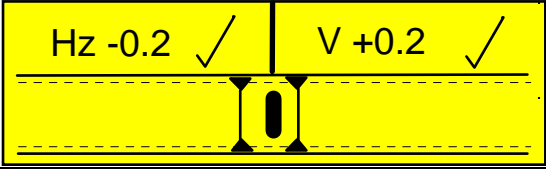
Display	Detail
	<p>Initial stage of Synchronising display will only show the difference between the Mains Supply and the Generator Output. Here the display is showing a frequency mismatch of +2.9Hz - The genset frequency is too high (indicated by the arrow) and should be reduced. The voltage is +0.2 volts high, but is within the limits set for synchronising.</p>
	<p>Once the difference between the Mains and the Generator frequency has been reduced, the 'Synchroscope' display will become active. The moving bar will roll from one side to the other showing the phase of the two supplies. The area in the centre of the scope indicates the set limits for synchronising to occur.</p>
	<p>Synchronising will only occur when both the Frequency and the voltage differences are within acceptable limits - Indicated by 'Tick' marks on the top of the display. Then the moving bar display will show the phase difference. The engine speed will be automatically adjusted, altering the phase, until the moving bar enters the centre of the scope.</p>
	<p>Once the Mains and generator supplies are synchronised, the module will initiate a breaker close signal to load the generator onto the Mains. Should synchronism be broken the moving bar will pass out of the synchronising window.</p>

Note:- On the start of the synchronising process and if the display is still on the status page, the module will automatically switch to the Synchroscope page. Once the system enters one of the ramping states, the ramp progress will also be displayed on the screen.

4.7 COMPLETE INSTRUMENTATION LIST

4.7.1 BASIC INSTRUMENTATION

Engine Speed
Engine Oil pressure
Coolant temperature
Fuel level
Battery voltage/Charge alt volts
Engine run time/Number of starts
Next maintenance (if enabled)
Generator volts (L1-N, L2-N, L3-N)
Generator volts (L1-L2, L2-L3, L3-L1)
Generator Hz
Generator Amps (L1,L2,L3)
Generator earth current
Generator kW (L1,L2,L3)
Generator total kW
Generator kVA (L1,L2,L3)
Generator total kVA
Generator pf (L1,L2,L3)
Generator average pf
Generator kVAr (L1,L2,L3)
Generator total kVAr
Generator kWh/Generator kVAh/Generator kVArh
Generator phase sequence
Synchroscope (when enabled)
Mains volts (L1-N, L2-N, L3-N)
Mains volts (L1-L2, L2-L3, L3-L1)
Mains Hz
Mains Amps
Mains total kW
Mains total kVA
Mains average pf
Mains total kVAr
Mains phase sequence

4.7.2 ENHANCED ENGINE INSTRUMENTATION

(When supported by the electronic engine ECU)

Engine oil temperature
Coolant pressure
Inlet manifold temperature
Exhaust temperature
Turbo pressure
Fuel pressure
Fuel consumption
Total fuel used

4.8 ACCESSING THE FRONT PANEL CONFIGURATION EDITOR

This configuration mode allows the operator limited customising of the way the module operates.

Operation	Detail
To enter the 'configuration mode' press both the INFO and STOP buttons together.	

4.8.1 ENTERING THE CONFIGURATION EDITOR PIN NUMBER

The configuration editor contains two sections.

- Main configuration editor (for 'site adjustable' or 'commissioning' parameters)
- Application editor (to allow installation engineers to make application changes).
The 'Application Editor' is designed to allow the module to be configured for different applications without needing to re-configure the module settings. This makes it particularly suitable for applications where the generator would be used in a number of different roles, specifically in Rental or mobile type applications.

If the module PIN number has been set, the PIN number request is then shown. The configuration cannot be viewed or changed until the PIN number is correctly entered.

Enter either the 'main' PIN or the 'application' PIN.

If no PIN has been set, then skip to the next section.

NOTE: - The 'Application Editor' must be enabled first in order to make it accessible from the module's fascia. This is done by setting a PIN (number) for the module's main front panel editor, using the 5xxx for Windows™ PC configuration software.

Enter pin	The first * is flashing. Press + or – buttons to adjust it to the correct value for the first digit of the PIN number. Press ✓ when the first digit is correctly entered.
* * * *	

Enter pin	The second * is now flashing. Press + or – buttons to adjust it to the correct value for the second digit of the PIN number. Press ✓ when the second digit is correctly entered.
1 * * *	



Enter pin	The third * is now flashing. Press + or – buttons to adjust it to the correct value for the third digit of the PIN number. Press ✓ when the third digit is correctly entered.
12 * *	

Enter pin	The fourth * is now flashing. Press + or – buttons to adjust it to the correct value for the fourth digit of the PIN number. Press ✓ when the fourth digit is correctly entered.
123 *	

NOTE:- When ✓ is pressed after editing the final PIN digit, the PIN is checked for validity. If the number is not correct, the editor is automatically exited. To retry you must re-enter the editor as described above.

4.8.2 EDITING VALUES

If the PIN number has not been set, or has been correctly entered :

Operation	Detail
The LCD will then display:	CONFIGURATION
To view the different configuration functions press the + or - buttons.	
The LCD will then display:	CONFIGURATION Oil Pressure Pre-alarm 1.30 Bar 18 PSI 130 kPa
Pressing the ✓ button will enter edit mode :	
The parameter being changed will flash. Pressing + or - buttons will change the parameter to the desired value.	CONFIGURATION Oil Pressure Pre-alarm 1.30 Bar 18 PSI 130 kPa
Press ✓ to save the change. The parameter will stop flashing as the edit mode is exited.	
To view the different configuration functions press the + or - buttons.	
For date and time editing only: press  to select between day, month, year, hours and minutes.	
To exit the 'Operator configuration mode' save your current value change if you haven't already done so (press ✓ to exit the flashing edit mode), then press Stop/Reset to exit configuration mode.	

The module will then return to the **'Status Page'** display.

4.8.3 LIST OF ADJUSTABLE PARAMETERS (MAIN CONFIGURATION EDITOR)

(Factory default settings are shown in bold italicised text)

Section	Parameter as shown on display	Values
Input settings	Oil Pressure Pre Alarm	0 bar -4bar (1.17bar)
	Oil Pressure Shutdown	0 bar -4bar (1.03bar)
	High Coolant Temp Pre Alarm	80°C -140°C (115°C)
	High Coolant Temp Shutdown	80°C -140°C (120°C)
	Low Coolant Temp Alarm	67°C -137°C (disabled)
Timers	Low Fuel Level Alarm	0%-100% (disabled)
	Mains Transient Delay	0-10s (2s)
	Generator Transient Delay	0 -10s (0s)
	Start Delay	0 -60m (5s)
	Pre Heat Time	0 -60m (0s)
	Crank Time	0 -60s (10s)
	Crank Rest Time	0-60s (10s)
	Safety On Delay	0-30s (10s)
	Overspeed Overshoot Delay	0-10s (0s)
	Warm Up Time	0-60m (0s)
	Transfer Delay	0-10s (0.75s)
	Return Delay	0 -60m (30s)
	Cooling Run Time	0-60m (60s)
	Fail To Stop Delay	0-30s (30s)
	Low Battery Delay	0-10m (1m)
	High Battery Delay	0-10m (1m)
Gen Reverse Power Delay	0-30s (2s)	
Mains	Mains Under Voltage Alarm	50V-360V ph-N (184V)
	Mains Over Voltage Alarm	50V-360V ph-N (277V)
	Mains Under Frequency Alarm	0Hz -75Hz (45Hz)
	Mains Over Frequency Alarm	0Hz -75Hz (55Hz)
Generator	Generator Under Voltage Shutdown	50V-360V ph-N (184V)
	Generator Under Voltage Pre Alarm	50V-360V ph-N (196V)
	Generator Nominal Voltage	52V-330V(230V)
	Generator Over Voltage Pre Alarm	50V-360V ph-N (265V)
	Generator Over Voltage Shutdown	50V-360V ph-N (277V)
	Generator Under Frequency Shutdown	0Hz -75Hz (40Hz)
	Generator Under Frequency Pre Alarm	0Hz -75Hz (42Hz)
	Generator Nominal Frequency	0Hz - 74Hz (50Hz)
	Generator Over Frequency Pre Alarm	0 -75Hz (55Hz)
	Generator Over Frequency Shutdown	0 -75Hz (57Hz)
	Generator Over Current Trip	100-200% full load rating (100%)
	Generator Short Circuit Trip	50%-300% full load rating (200%)
	Generator Reverse Power Trip	0%-200% full load rating (35kW)
	Earth Fault Trip	1%-100% full load rating (10%)
Engine	Engine underspeed shutdown	0-5995RPM (disabled)
	Engine underspeed Pre-alarm	1-5996RPM (disabled)
	Engine Overspeed pre alarm	2-5999RPM (disabled)
	Engine Overspeed shutdown	3-6000RPM (disabled)
	Overspeed Overshoot	0-10 (0%)
	Plant Battery Under Volt Alarm	0-24V (10V)
	Plant Battery Over Volt Alarm	0-24V (30V)
	Charge Alternator Failure Alarm	0-24V (6V)
Languages	Language	ENGLISH OTHERS (see note below)
Application settings	Alternative Frequency	Enable/Disable
	Alternative voltage	Enable/Disable
	AC System	3 phase, 4wire Single phase, 2 wire 3 phase, 3 wire 2 phase, 2wire L1 & L2 3 phase, 4 wire ED 2 phase 2 wire L1 & L3
	Generator Full load rating	300-600A (500A)
	Droop	Enable/Disabled
	Contrast	<input type="checkbox"/> <input checked="" type="checkbox"/>
	Date and Time	dd mmm yyyy hh:mm
	Auto Scroll Time	0-10s (2.0s)
	Generator CT Primary Rating	5-6000A (600A)
	Generator CT Secondary Rating	1A / 5A
	Mains CT Primary Rating	5-6000A (600A)
	Mains CT Secondary Rating	1A/ 5A
	Generator Control Full kW rating	1-5000kW (345kW)
	Generator Control Full kVAr rating	1-5000kVAr (258kW)
	Load ramp rate	0.1-100% (3%)
	Load Parallel Power	0-100% (50% 172Kw)
	Load Power Factor	01-1.00-01 (1.00pf)

NOTE:- More comprehensive module configuration is possible using the 5xxx series PC configuration software in conjunction with the P810 PC interface. Please contact us for further details.

NOTE:- Languages are subject to change as the modules are updated. Please contact us for the list of latest supported languages.

4.8.4 LIST OF ADJUSTABLE PARAMETERS (APPLICATION EDITOR)

(Factory default settings are shown in bold italicised text)

Section	Parameter as shown on display	Values
Display	Language	<i>ENGLISH</i> , OTHERS (see note below)
Application settings	Alternative Frequency	Enable/Disable
	Alternative voltage	Enable/Disable
	AC System	3 phase, 4wire Single phase, 2 wire 3 phase, 3 wire 2 phase, 2wire L1& L2 3 phase, 4 wire ED 2 phase 2 wire L1 & L3
	Generator Full load rating	300-600A (<i>500A</i>)
	Droop	Enable/Disabled
	Contrast	<input type="checkbox"/> <input checked="" type="checkbox"/>
	Date and Time	dd mmm yyyy hh:mm
	Auto Scroll Time	0-10s (<i>2.0s</i>)
	Generator CT Primary Rating	5-6000A (<i>600A</i>)
	Generator CT Secondary Rating	1A / 5A
	Mains CT Primary Rating	1A / 5A
	Generator Control Full kW rating	1-5000kW (<i>345kW</i>)
	Generator Control Full kVAr rating	1-5000kVAr (<i>258kW</i>)
	Load ramp rate	0.1-100% (<i>3%</i>)
	Load Parallel Power	0-100% (<i>50% 172Kw</i>)
	Load Power Factor	01-1.00-01 (<i>1.00pf</i>)

NOTE:- More comprehensive module configuration is possible using the 5xxx series PC configuration software in conjunction with the P810 PC interface. Please contact us for further details.







NOTE:- Languages are subject to change as the modules are updated. Please contact us for the list of latest supported languages.









4.9 DISPLAY EDITOR

The Display Editor is user to make changes to display language, contrast and run priority mode.

Operation	Detail
To enter the Display Editor press both the UP and DOWN buttons together.	

4.9.1 EDITING 'DISPLAY EDITOR' CONFIGURATION VALUES

Operation	Detail
The LCD will then display: Software version is shown for your convenience. This is the version of firmware within the 5510 controller.	CONFIGURATION Contrast  Software version x.xx
To change the value for the displayed parameter press either the  buttons to increase or decrease the value.	
To view the different configuration functions press the  button.	
The LCD will then display:	CONFIGURATION Language English (United Kingdom) Software version x.xx
To change the value for the displayed parameter press either the  buttons to increase or decrease the value.	
To view the different configuration functions press the  button.	
The LCD will then display:	CONFIGURATION Enable commissioning Screens? No Software version x.xx
To change the value for the displayed parameter press either the  buttons to increase or decrease the value. For details on the commissioning screens see the section elsewhere in this manual.	
To view the different configuration functions press the  button.	

<p>The LCD will then display:</p>	<p>CONFIGURATION Override starting alarms? No Software version x.xx</p>
<p>To change the value for the displayed parameter press either the   buttons to increase or decrease the value.</p> <p>When “override starting alarms” is enabled (yes) it allows alarms to be overridden during the start process by holding the start button. This allows (for instance) the AVR / Governor to be adjusted without the engine being shutdown on under volts or overfrequency etc.</p> <p>This operation is a ‘one off’ operation, the function is automatically changed back to “No” and must be manually enabled if it is required once more.</p> <p>To view the different configuration functions press the  button.</p>	
<p>The LCD will then display:</p>	<p>CONFIGURATION Abandon Changes And exit Software version x.xx</p>
<p>To exit the editor without saving changes press either of the   buttons.</p> <p>To save changes press the  button.</p>	
<p>The LCD will then display:</p>	<p>CONFIGURATION Save changes and exit Software version x.xx</p>
<p>To exit the editor and save any changes press either of the   buttons.</p> <p>To return to the beginning of the list press the  button.</p>	

The module will then return to the ‘Status Page’ display.

5 LED IDENTIFICATION AND FRONT PANEL LAYOUT

5.1 CONFIGURABLE LED IDENTIFICATION DIAGRAM

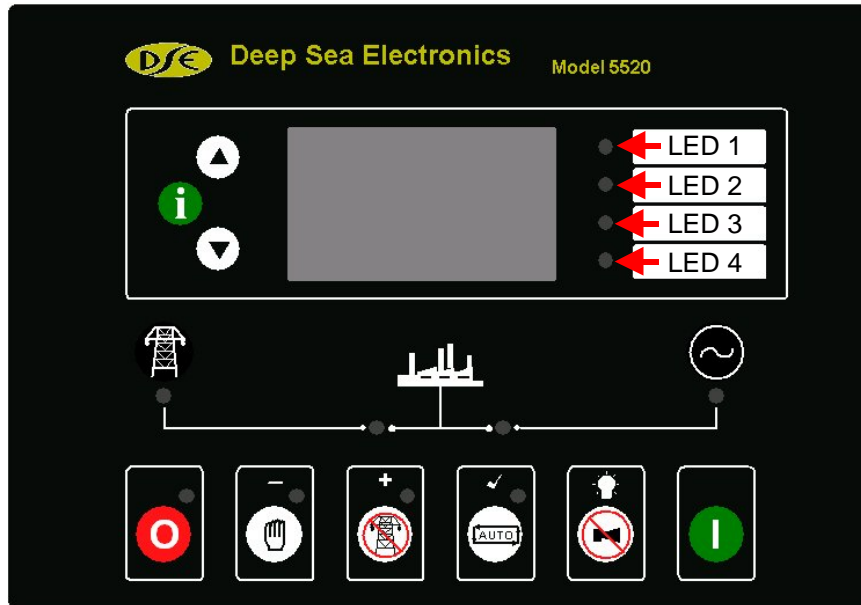

6 LED INDICATORS AND LOGO INSERT

USER CONFIGURABLE LED'S

These LEDs can be configured by the user to indicate any one of **100+ different functions** based around the following:-

- **INDICATIONS** - Monitoring of a digital input and indicating associated functioning user's equipment - *Such as Battery Charger On or Louvre Open, etc.*
- **WARNINGS and SHUTDOWNS** - Specific indication of a particular warning or shutdown condition, backed up by LCD indication - *Such as Low Oil Pressure Shutdown, Low Coolant level, etc.*
- **STATUS INDICATIONS** - Indication of specific functions or sequences derived from the modules operating state - *Such as Safety On, Pre-heating, Panel Locked, Generator Available, etc.*

These LEDs are annunciated using a removable insert card. Additionally the module's logo can be changed to suit generator manufacturer's requirements. This can be used for instance to give custom branding to the module, or even include the service telephone number.

DSE have produced the 'insert card creator' software, shipped with the DSE SoftwareCD to ease the production of text and logo insert cards to suit your application.

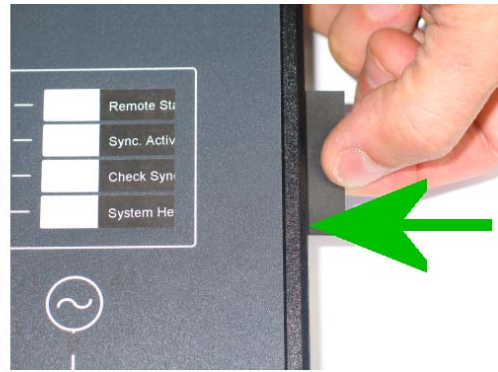



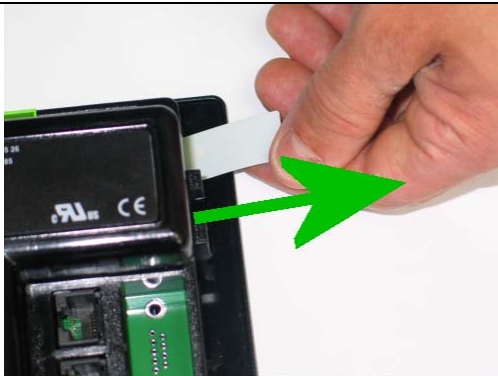





Removal and insertion of the LED text insert card



Removal and insertion of the Logo insert card

7 CONTROL PUSH-BUTTONS

<p>STOP/RESET This push-button places the module into its Stop/reset mode. This will clear any alarm conditions for which the triggering criteria have been removed. If the engine is running and this push-button is operated, the module will automatically instruct the changeover device to unload the generator (<i>'Load transfer' becomes in-active (if used)</i>). The fuel supply will be removed and engine will be brought to a standstill. Should a remote start signal be present while operating in the Stop/reset mode, a remote start will <u>not</u> occur.</p>	
<p>MANUAL This push-button is used to allow manual control of the generator functions. Entering this mode from any other mode will initially not cause any change of operating state, but allows further push-buttons to be used to control the generator operation. For example, once in Manual mode it is possible to manually start the engine by using the 'START' push-button. If the engine is running off-load in the Manual mode and a remote start signal becomes present, the module will automatically instruct the change-over device to place the generator on load (<i>'Load transfer' becomes active (if used)</i>). Should the remote start signal then be removed the generator will remain on load until either the 'STOP/RESET' or 'AUTO' push buttons are operated. This button is also the '-' button when in the configuration editor mode. It is used to move through the different parameters or to decrease the value being edited.</p>	
<p>START This push-button is used to start the engine. The module must first be placed in the 'MANUAL' mode of operation. The 'START' button should then be operated. The engine will then automatically attempt to start. Should it fail on the first attempt either it will re-try until the engine fires or the pre-set number of attempts have been made. To stop the engine the 'STOP/RESET' button should be operated. It is also possible to configure the module such that the start push-button must be held to maintain engine cranking.</p>	
<p>▲NOTE:-Different modes of operation are possible - Please refer to your configuration source for details.</p>	
<p>AUTO This push-button places the module into its 'Automatic' mode. This mode allows the module to control the function of the generator automatically. The module will monitor the remote start input and once a start condition is signalled the set will be automatically started and placed on load (<i>'Load transfer' becomes active (if used)</i>). If the starting signal is removed, the module will automatically transfer the load from the generator and shut the set down observing the stop delay timer and cooling timer as necessary. The module will then await the next start event. <i>For further details, please see the more detailed description of 'Auto Operation' earlier in this manual.</i> This button is also the '✓' button when in the configuration editor mode. It is used to edit the displayed parameter or to save the new value when editing a value.</p>	

<p>TEST This push-button places the module into its 'Test' mode. This mode is used to test the function and timing of the generator start and load sequence. The mode is initiated by pressing the 'Start' Button and the set will be automatically started and placed on load. The set will run on load continuously. To test the off-loading and stopping sequence return the set to the 'Auto' mode, the module will automatically transfer the load from the generator and shut the set down observing the stop delay timer and cooling timer as necessary. The module will then await the next start event. <i>For further details, please see the more detailed description of 'Test Operation' earlier in this manual.</i> This button is also the '+' button when in the configuration editor mode. It is used to move through the different parameters or to increase the value being edited.</p>	
<p>ALARM MUTE This push-button is used to silence the internal alarm sounder and also any external sounder devices fed from the audible alarm output. Any further alarm conditions will reactivate the sounder. Once the alarm has been muted and investigated, it may then be cleared. <i>Refer to the 'Protections' section of this manual for details.</i></p> <p>When the Alarm Mute is operated a Lamp test function will also be implemented and all LED indicators will be illuminated.</p>	
<p>TRANSFER TO GENERATOR This push button is used to control the closure of the generator load switching device and has three modes of operation :</p> <ol style="list-style-type: none"> 1. Synchronising is NOT enabled. Pressing this button when the generator is running off load and in MANUAL mode, the mains load switch is opened. After a delay (load transfer time), the generator load switch is closed. Further presses of this button will have no effect. 2. Synchronising is enabled. Pressing this button when the generator is running and in MANUAL mode, the 5520 controller will volts match and synchronise with the mains supply. The generator load switch is then closed in parallel with the mains supply. 3. Synchronising is enabled. Pressing this button when the generator is running in parallel with the mains supply and in MANUAL mode, will open the mains load switch and after a delay (load transfer time), the mains load switch is opened (transferring the load to the generator supply). 	
<p> NOTE: - This button is only active in MANUAL mode.</p>	

TRANSFER TO MAINS

This push button is used to control the closure of the mains load switching device and has three modes of operation :

1. Synchronising is NOT enabled. Pressing this button when the generator is running on load and in MANUAL mode, the generator load switch is opened. After a delay (load transfer time), the mains load switch is closed. Further presses of this button will have no effect.
2. Synchronising is enabled. Pressing this button when the generator is running on load and in MANUAL mode, the 5520 controller will volts match and synchronise with the mains supply. The generator load switch is then closed in parallel with the mains supply.
3. Synchronising is enabled. Pressing this button when the generator is in MANUAL mode and running in parallel with the mains supply will open the generator load switch, transferring the load back to the mains supply only.



 **NOTE: - This button is only active in MANUAL mode.**

8 INSTALLATION INSTRUCTIONS

The model DSE 5520 Module has been designed for front panel mounting. Fixing is by 4 clips for easy assembly.

8.1 PANEL CUT-OUT

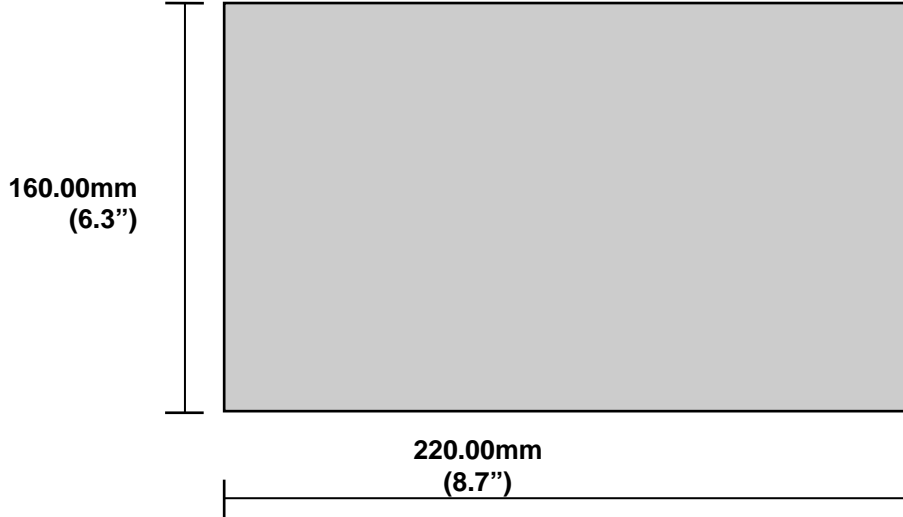

Maximum panel thickness – 8mm (0.3")

In conditions of excessive vibration, the module should be mounted on suitable anti-vibration mountings.

8.2 COOLING

The module has been designed to operate over a wide temperature range **-30 °C to +70°C**.

Allowances should be made for the temperature rise within the control panel enclosure. Care should be taken **NOT** to mount possible heat sources near the module unless adequate ventilation is provided. The relative humidity inside the control panel enclosure should not exceed **95%**.

8.3 UNIT DIMENSIONS

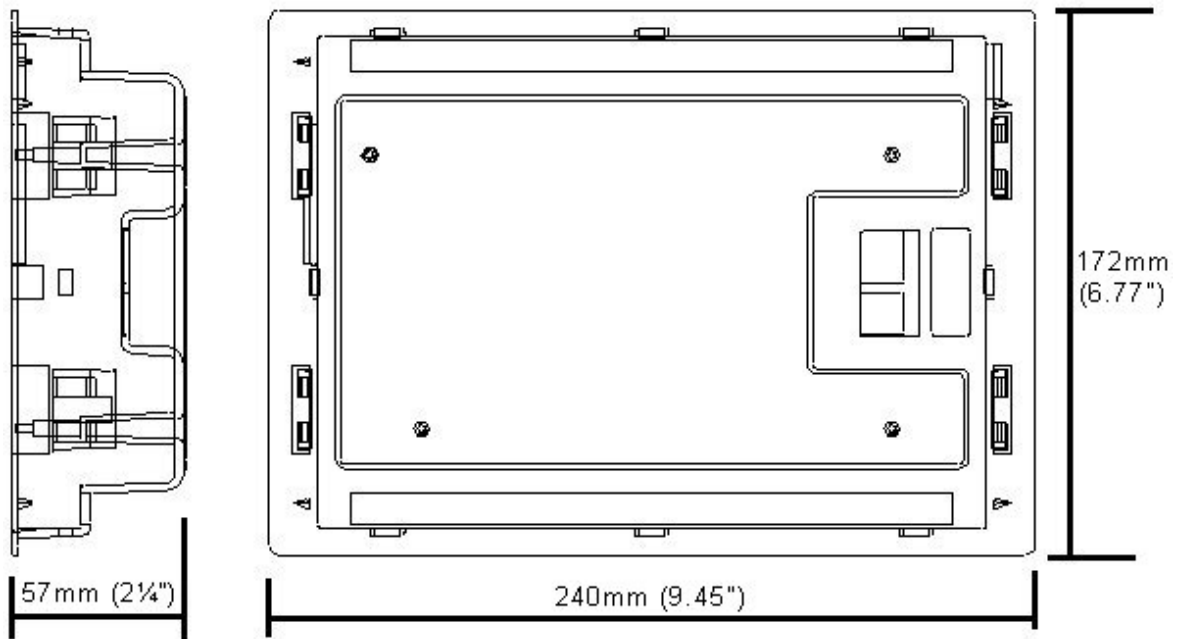

Panel cut-out 220mm x 160mm (8.7" x 6.3")

9 ELECTRICAL CONNECTIONS

Connections to the Module are via plug and sockets.

9.1 CONNECTION DETAILS

The following describes the connections and recommended cable sizes to the 8 plugs and sockets on the rear of the Module.

9.1.1 PLUG "A" 8 WAY

PIN No	DESCRIPTION	CABLE SIZE	NOTES
1	DC Plant Supply Input (Negative)	2.5mm	
2	DC Plant Supply Input (Positive)	2.5mm	(Recommended Fuse 20A Max.)
3	Emergency Stop Input	2.5mm	Plant Supply positive. In addition, supplies fuel & start outputs. (Recommended Fuse 32A Max.)
4	Fuel relay Output	2.5mm	Plant Supply positive from pin 3. 16 Amp rated.
5	Start relay Output	2.5mm	Plant Supply positive from pin 3. 16 Amp rated.
6	Auxiliary Output relay 1	1.0mm	Plant Supply positive 5 Amp rated.
7	Auxiliary Output relay 2	1.0mm	Plant Supply positive 5 Amp rated.
8	Auxiliary Output relay 3	1.0mm	Plant Supply positive 5 Amp rated.

9.1.2 PLUG "B" 11 WAY

PIN No	DESCRIPTION	CABLE SIZE	NOTES
9	Charge Fail Input/ Excitation Output	1.0mm	Must NOT be connected to plant supply negative
10	Auxiliary Input 1	0.5mm	Switch to negative
11	Auxiliary Input 2	0.5mm	Switch to negative
12	Auxiliary Input 3	0.5mm	Switch to negative
13	Auxiliary Input 4	0.5mm	Switch to negative
14	Auxiliary Input 5	0.5mm	Switch to negative
15	Auxiliary Input 6	0.5mm	Switch to negative
16	Auxiliary Input 7	0.5mm	Switch to negative
17	Auxiliary Input 8	0.5mm	Switch to negative
18	Auxiliary Input 9	0.5mm	Switch to negative
19	Functional Earth	2.5mm	Connect to system earth

9.1.3 PLUG “C” 9 WAY

PIN No	DESCRIPTION	CABLE SIZE	NOTES
20	Magnetic pickup screen	0.5mm	Connect at module end only!
21	Magnetic pickup	0.5mm	Connect to magnetic pickup device
22	Magnetic pickup	0.5mm	Connect to magnetic pickup device
23	Electronic Engine ECU Screen	0.5mm	Connect screen at one end only
24	Electronic Engine ECU H	0.5mm	120Ω impedance CAN cable
25	Electronic Engine ECU L	0.5mm	120Ω impedance CAN cable
26	Unused		Do not connect
27	Unused		Do not connect
28	Unused		Do not connect

▲NOTE:- Screened cable must be used for connecting the Magnetic Pickup, ensuring that the screen is earthed at one end ONLY.

▲NOTE:- Screened 120Ω impedance cable specified for use with CAN must be used for the electronic engine link.

9.1.4 PLUG “D” 3 WAY

PIN No	DESCRIPTION	CABLE SIZE	NOTES
29	RS485 SCREEN	0.5mm	Screen for RS485
30	RS485 B	0.5mm	120Ω impedance RS485 cable
31	RS485 A	0.5mm	120Ω impedance RS485 cable

▲NOTE:- Screened 120Ω impedance cable specified for use with RS485 must be used.

9.1.5 PLUG “E” 5 WAY

PIN No	DESCRIPTION	CABLE SIZE	NOTES
32	Governor output B	0.5mm	Connect to governor for speed/load control
33	Governor output A	0.5mm	Connect to governor for speed/load control
34	Unused		Do not connect
35	AVR output B	0.5mm	Connect to governor for volts/VAr control
36	AVR output A	0.5mm	Connect to governor for volts/VAr control

▲NOTE:- It is recommended to use screened cable for the Governor and AVR output connections.

▲NOTE:- For details of connections to governors / AVRs refer to the DSE Guide to Synchronising Part 2.

9.1.6 PLUG “F” 8 WAY

PIN No	DESCRIPTION	CABLE SIZE	NOTES
37	Mains Loading Relay Normally Closed Contact	2.5mm	Connect to mains contactor coil feed supply.
38	Mains Loading Relay Normally Closed Contact	2.5mm	Connect to mains contactor coil.
39	Generator Loading Relay Normally Open Contact	2.5mm	Connect to generator contactor coil feed supply.
40	Generator Loading Relay Normally Open Contact	2.5mm	Connect to generator contactor coil.
41	Mains volts L1	1.0mm	Connect to Mains L1
42	Mains volts L2	1.0mm	Connect to Mains L2
43	Mains volts L3	1.0mm	Connect to Mains L3
44	Mains volts N	1.0mm	Connect to Mains N

9.1.7 PLUG “G” 4 WAY

PIN No	DESCRIPTION	CABLE SIZE	NOTES
45	Generator volts L1	1.0mm	Connect to Generator L1
46	Generator volts L2	1.0mm	Connect to Generator L2
47	Generator volts L3	1.0mm	Connect to Generator L3
48	Generator volts N	1.0mm	Connect to Generator N

9.1.8 PLUG “H” 12 WAY

PIN No	DESCRIPTION	CABLE SIZE	NOTES
49	CT Secondary for generator L1	2.5mm	Connect to secondary of generator L1 monitoring CT
50	CT Secondary for generator L2	2.5mm	Connect to secondary of generator L2 monitoring CT
51	CT Secondary for generator L3	2.5mm	Connect to secondary of generator L3 monitoring CT
52	Generator CT secondary common	2.5mm	Connect to secondary of all monitoring CT’s
53	CT Secondary for generator N	2.5mm	Connect to secondary of generator N (earth fault) monitoring CT
54	CT Secondary for mains L1	2.5mm	Connect to secondary of mains L1 monitoring CT
55	Mains CT secondary common	2.5mm	Connect to secondary of mains monitoring CT
56	Not used		Do not connect
57	Low oil pressure sender	1.0mm	Connect to low oil pressure sender
58	Coolant temperature sender	1.0mm	Connect to Coolant temperature sender
59	Fuel level sender	1.0mm	Connect to Fuel level sender
60	Sender common	1.0mm	Connect to sender common

 **WARNING!:-** Do not disconnect this plug when the gen-set is running. Disconnection will open circuit the secondary of the CT’s and dangerous voltages may then develop. Always ensure the gen-set is at rest before making or breaking connections to the module.

 **NOTE*:-** If using single terminal senders refer the Appendix section entitled “Sender wiring recommendations” elsewhere in this manual.

9.1.9 PC CONFIGURATION INTERFACE CONNECTOR

	 810 ✓	8-way connector allows connection to PC via 810 configuration interface. Module can then be re-configured utilising the 5xxx for Windows™ software.
--	--------------------------------------------------------------------------------------------	-----------------------------------------------------------------------------------------------------------------------------------------------------

9.1.10 EXPANSION INTERFACE CONNECTOR

130 / 157 / 545 / 548 ✓ 808 ✗	4-way connector allows connection to the 130 input expansion, 157 relay expansion module or 545/548 LED expansion modules. A maximum of 2 relay or LED expansion modules may be connected in series to this port.
----------------------------------	----------------------------------------------------------------------------------------------------------------------------------------------------------------------------------------------------------------------

! CAUTION! - Do not connect the 808 configuration interface to this port, as it is not possible to use the 808 software to configure the 5520 module.

9.2 CONNECTOR FUNCTION DETAILS

The following describes the connections and recommended cable sizes to the 8 plugs and sockets on the rear of the Module.

9.2.1 PLUG "A" 8 WAY

PIN No	DESCRIPTION
1	DC Supply negative. System DC negative input. (Battery Negative).
2	DC Supply positive. System DC positive input. (Battery Positive).
3	Emergency Stop input. Internally linked to Starter and Fuel outputs. If this input is not connected to positive the module will be locked out and if the engine is running it will shutdown immediately. The Positive Supply is also removed from Starter and Fuel therefore only a single pole Emergency Shutdown button is required.
4	Fuel Relay output. Plant Supply positive from pin 3. Used to control the fuel solenoid or engine fuel control system.
5	Starter Relay output. Plant Supply positive from pin 3. Used to control the Starter Motor.
6	Auxiliary Relay output 1. Plant Supply positive Configurable output, see Calibration Manual for options available.
7	Auxiliary Relay output 2. Plant Supply positive Configurable output, see Calibration Manual for options available.
8	Auxiliary Relay output 3. Plant Supply positive Configurable output, see Calibration Manual for options available.

9.2.2 PLUG "B" 11 WAY

PIN No	DESCRIPTION
9	Charge Fail input and Excitation output. Supplies excitation to the Plant Battery Charging Alternator, also an input for the Charge Fail detection circuitry.
10	Auxiliary input 1. This is a negative switched configurable input, see Calibration Manual for options available. It is possible to configure the input to be a normally closed signal or a normally open signal.
11	Auxiliary input 2. This is a negative switched configurable input, see Calibration Manual for options available. It is possible to configure the input to be a normally closed signal or a normally open signal.
12	Auxiliary input 3. This is a negative switched configurable input, see Calibration Manual for options available. It is possible to configure the input to be a normally closed signal or a normally open signal.
13	Auxiliary input 4. This is a negative switched configurable input, see Calibration Manual for options available. It is possible to configure the input to be a normally closed signal or a normally open signal.
14	Auxiliary input 5. This is a negative switched configurable input, see Calibration Manual for options available. It is possible to configure the input to be a normally closed signal or a normally open signal.
15	Auxiliary input 6. This is a negative switched configurable input, see Calibration Manual for options available. It is possible to configure the input to be a normally closed signal or a normally open signal.
16	Auxiliary input 7. This is a negative switched configurable input, see Calibration Manual for options available. It is possible to configure the input to be a normally closed signal or a normally open signal.
17	Auxiliary input 8. This is a negative switched configurable input, see Calibration Manual for options available. It is possible to configure the input to be a normally closed signal or a normally open signal.
18	Auxiliary input 9. This is a negative switched configurable input, see Calibration Manual for options available. It is possible to configure the input to be a normally closed signal or a normally open signal.
19	Functional earth

9.2.3 PLUG “C” 9 WAY

PIN No	DESCRIPTION
20	Magnetic pickup screen
21	Magnetic Input positive. An AC signal from the magnetic pickup positive for speed sensing.
22	Magnetic Input negative. An AC signal from the magnetic pickup negative for speed sensing.
23	Electronic Engine ECU Screen
24	Electronic Engine ECU H. For connection to the Engine ECU terminal H
25	Electronic Engine ECU L. For connection to the Engine ECU terminal L
26	Unused
27	Unused
28	Unused

▲ NOTE:- Screened cable must be used for connecting the Magnetic Pickup, ensuring that the screen is earthed at one end ONLY.

▲ NOTE:- Screened 120Ω impedance cable specified for use with CAN must be used for both the Electronic engine link and the Multiset comms link

9.2.4 PLUG “D” 3 WAY

PIN No	DESCRIPTION
29	RS485 SCREEN
30	RS485 B. For connection to other RS485 controllers in a multidrop RS485 communications system.
31	RS485 A. For connection to other RS485 controllers in a multidrop RS485 communications system.

▲ NOTE:- Screened 120Ω impedance cable specified for use with RS485 must be used.

9.2.5 PLUG “E” 5 WAY

PIN No	DESCRIPTION
32	Governor output B. For connection to electronic speed governors for synchronising and load sharing.
33	Governor output A. For connection to electronic speed governors for synchronising and load sharing.
34	Unused
35	AVR output B. For connection to automatic voltage regulators for volts matching and VAR sharing.
36	AVR output A. For connection to automatic voltage regulators for volts matching and VAR sharing.

NOTE:- It is recommended to use screened cable for the Governor and AVR output connections.

NOTE:- For details of connections to governors and AVRs refer to the DSE Guide to Synchronising Part 2.

9.2.6 PLUG “F” 8 WAY

PIN No	DESCRIPTION
37	Mains Loading Relay, Normally closed. Volts free contacts to 38. Used to connect to Mains contactor or circuit breaker.
38	Mains Loading Relay, Normally closed. Volts free contacts to 37. Used to connect to Mains contactor or circuit breaker.
39	Generator Loading Relay, Normally open. Volts free contacts to 40. Used to connect to generator contactor or circuit breaker.
40	Generator Loading Relay, Normally open. Volts free contacts to 39. Used to connect to generator contactor or circuit breaker.
41	Mains volts L1. Used for sensing the voltage and frequency of mains L1.
42	Mains volts L2. Used for sensing the voltage and frequency of mains L2.
43	Mains volts L3. Used for sensing the voltage and frequency of mains L3.
44	Mains volts N. Used for sensing the mains voltage and frequency.

9.2.7 PLUG “G” 4 WAY

PIN No	DESCRIPTION
45	Generator volts L1. Used for sensing the voltage and frequency of generator L1.
46	Generator volts L2. Used for sensing the voltage and frequency of generator L2.
47	Generator volts L3. Used for sensing the voltage and frequency of generator L3.
48	Generator volts N. Used for sensing the voltage and frequency of the generator output.

CAUTION!:- Refer to Typical wiring Diagram for different wiring topologies.

9.2.8 PLUG “H” 12 WAY

PIN No		DESCRIPTION
49	CT Secondary for generator I1 (s2)	Used for sensing generator output Current for metering of Amps, KW, KVA and KVAr. Provides protection for Overcurrent, reverse power, earth fault and also load sharing.
50	CT Secondary for generator I2 (s2)	
51	CT Secondary for generator I3 (s2)	
52	Generator CT secondary common (s1)	
53	CT Secondary for generator IN	
54	CT Secondary for Mains L1 (s2)	Used to provide current sensing on the mains supply for metering and import/export control
55	CT Secondary for Mains L1 (s1)	
56	Not used	If using single terminal senders refer the Appendix section entitled “Sender wiring recommendations” elsewhere in this manual.
57	Low oil pressure sender	
58	Coolant temperature sender	
59	Fuel level sender	
60	Sender common	

 **WARNING!:- Do not disconnect this plug when the genset is running. Disconnection will open circuit the secondary of the CT’s and dangerous voltages may then develop. Always ensure the genset is at rest before making or breaking connections to the module.**

9.3 ENGINE CONTROL UNIT INTERFACE

The module is capable of interfacing with the ECU fitted to electronically injected engines. Different manufacturers engines utilise various different interfaces and protocols. As this is a rapidly developing area we recommend checking with DSE Support as to which engines are currently supported.







The module will monitor the engines operating parameters such as engine speed, oil pressure, engine temperature (among others) in order to closely monitor and control the engine. The data that is gathered by the engine controller is then transmitted on an industry standard communications interface. This allows generator controllers such as the DSE 55xx range to access these engine parameters with no physical connection to the sensor device.

Utilising the technology present on the engine in this way gives less connections to the engine, higher reliability and better diagnosis of engine related problems.

▲ NOTE:- For further details for connections to electronic engines refer to the manual CAN and DSE Wiring. Part No. 057-004

10 SPECIFICATION

DC Supply	Continuous voltage rating : 8V to 35V
	Cranking dip protection : Able to survive 0V for 50mS, providing supply was at least 10V before dropout and supply recovers to 5V. This is achieved without the need for internal batteries
	Charge Fail/ Excitation: 0V to 35V fixed power source 25W
	Max. Standby Current: 375mA at 12V. 200mA at 24V.
	Max. Operating Current: 460mA at 12V. 245mA at 24V
Alternator Input	Range: 5V - 277(ph-N) (+20%) 50Hz - 60Hz (Minimum 15V AC Ph-N)
	Accuracy: 1% of full scale True RMS sensing
	Supported topologies: 3 Phase 4wire Wye 3 phase 3 wire Delta 3 phase 3 wire Edison Delta Single phase 2 wire 2 Phase 3wire L1 & L2 2 Phase 3 wire L1 & L3
Bus and mains Input	Range: 15V - 277(ph-N) (+20%) 50Hz - 60 Hz
	Accuracy: 1% of full scale True RMS sensing
	Supported topologies: 3 Phase 4wire Wye 3 phase 3 wire Delta 3 phase 3 wire Edison Delta Single phase 2 wire 2 Phase 3wire L1 & L2 2 Phase 3 wire L1 & L3
CT's	Burden: 0.5VA
	Primary rating: 1A - 6000A (user selectable)
	Secondary rating: 1A or 5A secondary (user selectable)
	Accuracy of measurement: 1% of full load rating (when using 0.5% or better CTs with 5A secondary winding) Lower class CTs will reduce the overall accuracy of the reading.
	Recommendations: Class 1 required for instrumentation Protection class required if using for protection.
Magnetic Pickup	Voltage range : +/- 0.5V minimum (during cranking) to 70V Peak
	Frequency range: 10,000 Hz (max)
Relay outputs	Fuel: 16 Amp DC at supply voltage
	Start: 16 Amp DC at supply voltage
	Auxiliary outputs 1,2,3: 5 Amp DC at supply voltage
	Output 4 (Generator loading relay) Voltage free, normally open, 8 Amp 250V AC RMS rated
	Output 5 (Mains loading relay) Voltage free, normally closed, 8 Amp 250V AC RMS rated

Dimensions	Overall: 240mm x 172 mm x 57mm (9 ½" x 6 ¾" x 2 ¼")		
	Panel cut-out: 220mm x 160mm (8.7" x 6.3") Max panel thickness 8mm (0.3")		
Electrical Safety /Electromagnetic Compatibility	BS EN 60950 Safety of information technology equipment, including electrical business equipment		
	BS EN 61000-6-2 EMC Generic Emission Standard (Industrial)		
	BS EN 61000-6-4 EMC Generic Emission Standard (Industrial)		
Environmental	BS EN 60068-2-1 Cold Temperature -30°C		
	BS EN 60068-2-2 Hot Temperature +70°C		
	BS2011-2-1 Humidity 93% RH@40°C for 48 Hours		
	BS EN60068-2-6 Vibration 10 sweeps at 1 octave/minute in each of 3 major axes 5Hz to 8Hz @ +/-7.5mm constant displacement 8Hz to 500Hz @ 2gn constant acceleration		
	BS EN 60068-2-27 Shock 3 Half sine shocks in each of 3 major axes 15gn amplitude, 11mS duration		
	BS EN 60529 Degrees of protection provided by enclosures: IP55 (Front of module when module is installed into the control panel with the optional sealing gasket). IP42 (front of module when module is installed into the control panel WITHOUT being sealed to the panel)		
	NEMA Rating (Approximate) 12 (Front of module when module is installed into the control panel with the optional sealing gasket). 2 (front of module when module is installed into the control panel WITHOUT being sealed to the panel)		
Product Certification	 European CE approved.	 UL approved C-UL / CSA approved.	 Russia and other CIS countries approved
	 BS EN 2002/95/EC Restriction of Hazardous Substances (RoHS)	 BS EN 2002/96/EC Waste Electrical and Electronic Equipment (WEEE)	 CAN interface certified by MTU for use with MDEC engines
Relevant Company Certification	 BS EN ISO 9001:2000 Applicable to Design, marketing, assembly, service and repair of electronic control modules		

In line with our policy of continual development, Deep Sea Electronics, reserve the right to change specification without notice.

11 COMMISSIONING

11.1.1 PRE-COMMISSIONING

Before the system is started, it is recommended that the following checks are made:-

- 6.1. The module has adequate cooling and all the wiring to the module is of a standard and rating compatible with the system.
- 6.2. The unit **DC** supply is fused and connected to the battery and that it is of the correct polarity.
- 6.3. The Emergency Stop input is wired to an external normally closed switch connected to **DC** positive.

 **NOTE:- If Emergency Stop feature is not required link this input to the DC Positive. The module will not operate unless either the Emergency Stop is fitted correctly OR Pin 3 is connected to DC positive (positive)**

- 6.1. To check the start cycle operation, take appropriate measures to prevent the engine from starting (disable the operation of the fuel solenoid). After a visual inspection to ensure it is safe to proceed, connect the battery supply. Press the **“MANUAL”** pushbutton, and then press the **‘START’** pushbutton for a short time. The unit start sequence will commence.
- 6.2. The starter will engage and operate for the pre-set crank period. After the starter motor has attempted to start, the engine for the pre-set number of attempts the LCD will display *‘Shutdown Failed to start’*. Press the **STOP/RESET** pushbutton to reset the unit.
- 6.3. Restore the engine to operational status (reconnect the fuel solenoid), again select **“MANUAL”** and operate the **‘START’** pushbutton, this time the engine should start and the starter motor should disengage automatically. If not, then check the engine is operational (fuel available, etc.) and that the fuel solenoid is operating. The engine should now run up to operating speed. If not and an alarm is present, check the alarm condition for validity, then check input wiring. The engine should continue to run for an indefinite period. It will be possible at this time to view the engine and alternator parameters - refer to the ‘Description of Controls’ section of this manual.
- 6.4. Select **“AUTO”** on the front panel, the engine will run for the pre-set cooling down period, then stop. The generator should stay in the standby mode. If not check that there is not a signal present on the **Remote Start** input.
- 6.5. Initiate an automatic start by supplying the remote start signal. The start sequence will commence and the engine will run up to operational speed. Once the generator is available a load transfer will take place, the Generator will accept the load. If not, check the wiring to the Generator Contactor Coil (*if used*). Check the Warming timer has expired.
- 6.6. Remove the remote start signal, the return sequence will start. After the pre-set time period, the load will be removed from the generator. The generator will then run for the pre-set cooling down period, then shutdown into its standby mode.
- 6.7. Further details on synchronising and load sharing can be found in the DSE Guide to Load Share system Design and Commissioning and the DSE Guide to Synchronising and load sharing Part1 and Part2.
- 6.8. If despite repeated checking of the connections between the **5520** and the customer’s system, satisfactory operation cannot be achieved, then the customer is requested to contact the factory for further advice on:-

Should you have any queries arising from this manual please contact our Technical Department:

INTERNATIONAL TEL: +44 (0) 1723 890099

INTERNATIONAL FAX: +44 (0) 1723 893303

E-mail: support@deepseapl.com

Web: <http://www.deepseapl.com>

11.2 BYPASSING ALARMS AT STARTUP

When “override starting alarms” is enabled using the Display Editor, it allows alarms to be overridden during the start process by holding the start **I** button. This allows (for instance) the AVR / Governor to be setup without the engine being shutdown on under volts or underfrequency etc. This operation is a ‘one off’ operation, the function is automatically changed back to “No” and must be manually enabled if it is required once more.

The alarms that are overridden during this time are : Undervolts shutdown, Overvolts shutdown, underfrequency shutdown, underspeed shutdown.

The ‘pre-alarms’ remain active to give attention to the operator that an alarm is active, the set will continue to run to allow the operator to adjust the set to nominal speed / voltage.

NOTE:- Overfrequency and Overspeed are NOT disabled when this function is activated.

11.3 COMMISSIONING SCREENS

Commissioning screens are available to both aid the commissioning process and also to give additional information about the synchronising and load sharing process. These screens can be enabled and disabled in the module’s display editor.

11.3.1 SCREEN 1

L-N	0V	kW	0	Average L-N Voltage and total kW
Amps	0A	KVAr	0	Maximum Amps and total kVAr
Pf	0.00	kW	0.0%	Average power factor and % of full load kW
Gov	0.0%	Avr	0.0%	Levels of analogue governor / AVR outputs.

11.3.2 SCREEN 2

Tgt	0.0%	kW	0.0%	Target and actual % of full load kW
Tgt	0.0%	KVAr	0.0%	Target and actual % of full load kVAr
pf	0.0	Ramp	5.0%	Average power factor and ramp position.
Gov	0.0%	Avr	0.0%	Levels of analogue governor / AVR outputs.

11.3.3 SCREEN 3

G A	0	M A	0	Maximum generator Amps, Mains Amps
G pf	0.0	M pf	0.0	Average generator power factor, Mains power factor
G kW	0	M kW	0	Total generator kW, mains kW
G kVAr	0	M kVAr	0	Total generator kVAr, mains kVAr

11.3.4 SCREEN 4

M Tgt	0	kW	0	Mains target and Mains actual kW
M Tgt	0	kVAr	0	Mains target and Mains actual kVAr
Pf	0.0	Ramp	0.0%	Mains power factor and Mains ramp position
Gov	0.0%	Avr	0.0%	Levels of analogue governor / AVR outputs

NOTE:- Some of the items may be removed from the commissioning screens if they are not applicable to the module configuration.

12 FAULT FINDING

SYMPTOM	POSSIBLE REMEDY
Unit is inoperative	Check the battery and wiring to the unit. Check the DC supply. Check the DC fuse.
Unit shuts down	Check DC supply voltage is not above 35 Volts or below 9 Volts Check the operating temperature is not above 70 °C. Check the DC fuse.
Unit locks out on Emergency Stop	If an Emergency Stop Switch is not fitted, ensure that a positive is connected to the Emergency Stop input. Check emergency stop switch is functioning correctly. Check Wiring is not open circuit.
Intermittent Magnetic Pick-up sensor fault	Ensure that Magnetic pick-up screen is only connected at one end, if connected at both ends this enables the screen to act as an aerial and will pick up random voltages.
Low oil Pressure fault operates after engine has fired	Check engine oil pressure. Check oil pressure switch/sender and wiring. Check configured polarity (if applicable) is correct (i.e. Normally Open or Normally Closed) or that sender is compatible with the 5520 Module.
High engine temperature fault operates after engine has fired.	Check engine temperature. Check switch/sender and wiring. Check configured polarity (if applicable) is correct (i.e. Normally Open or Normally Closed) or that sender is compatible with the 5520 Module.
Shutdown fault operates	Check relevant switch and wiring of fault indicated on LCD display. Check configuration of input.
Warning fault operates	Check relevant switch and wiring of fault indicated on LCD display. Check configuration of input.
Fail to Start is activated after pre-set number of attempts to start	Check wiring of fuel solenoid. Check fuel. Check battery supply. Check battery supply is present on the Fuel output of the module. Check the speed sensing signal is present on the 5520 inputs. Refer to engine manual.
Continuous starting of generator when in AUTO	Check that there is no signal present on the "Remote Start" input. Check configured polarity is correct.
Generator fails to start on receipt of Remote Start signal or under mains failure conditions.	Check Start Delay timer has expired. If remote start fault, check signal is on "Remote Start" input. Confirm input is configured to be used as "Remote Start".
Pre-heat inoperative	Check wiring to engine heater plugs. Check battery supply. Check battery supply is present on the Pre-heat output of module. Check pre-heat has been selected in your configuration.
Starter motor inoperative	Check wiring to starter solenoid. Check battery supply. Check battery supply is present on the Starter output of module. Ensure that the Emergency Stop input is at positive.
Engine runs but generator will not take load	Check Warm up timer has expired. Ensure generator load inhibit signal is not present on the module inputs.

 **NOTE:- The above fault finding is provided as a guide check-list only. As it is possible for the module to be configured to provide a wide range of different features always refer to the source of your module configuration if in doubt.**

13 TYPICAL WIRING DIAGRAM

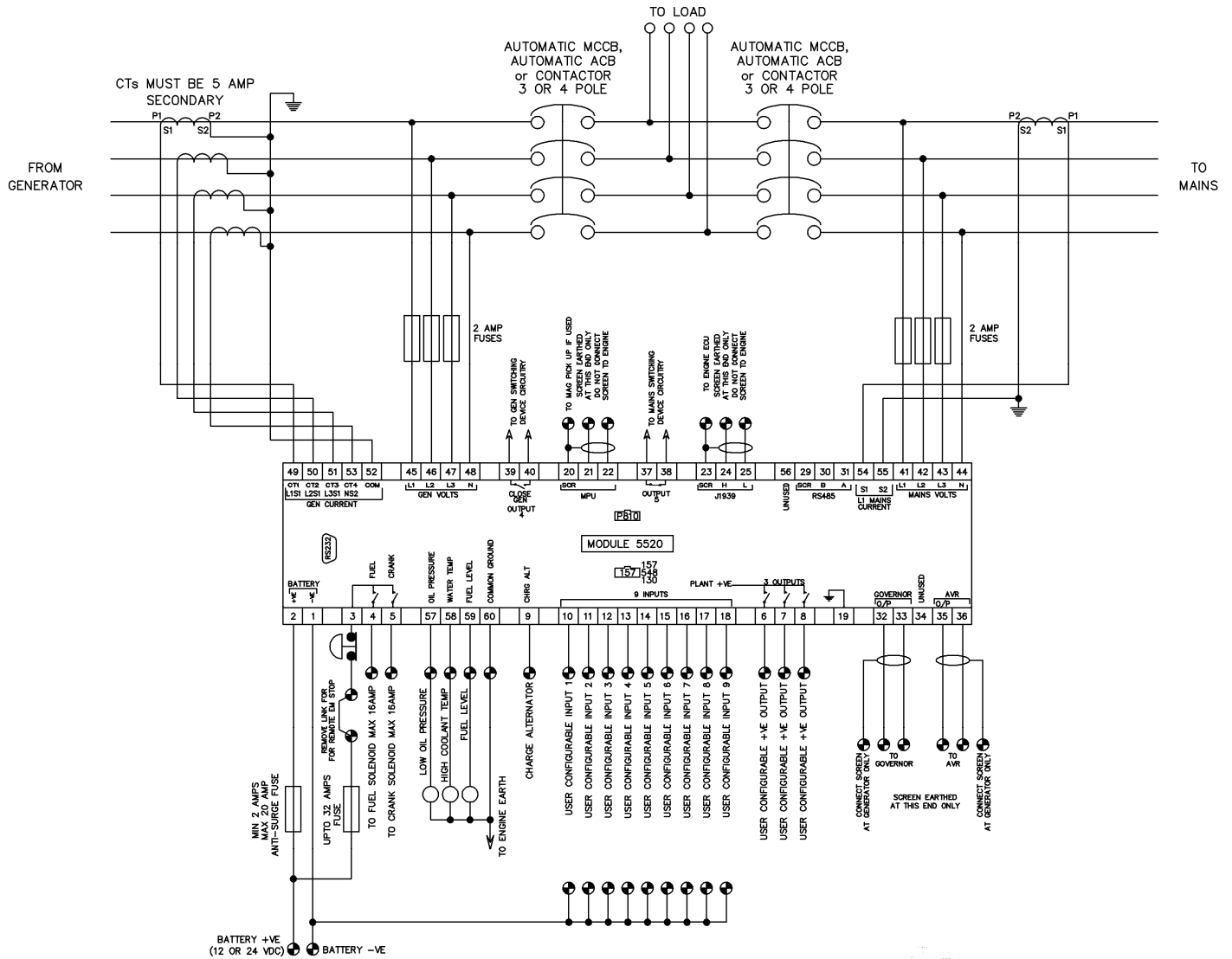

NOTE:- When not fitting the 'neutral CT', terminal 53 is the CT common and earth. Terminal 52 is not used.

14 FACTORY DEFAULT CONFIGURATION

55xx for Windows. Configuration for 5520 module. Page 1 of 4

Configuration description

1
2
3
4

Filename - 5520a.ycf

Printed on 23/10/2006 08:55:18

Module settings

Base module	5520 AMF module
Module version	8.00
Load control option fitted	Yes

Application settings

CANbus Enabled	No
Gas engine enabled	No
AC System	3 phase, 4 wire
Enable generator sequence alarm	Yes
Enable mains phase sequence alarm	Yes
Phase sequence	L1 L2 L3
Generator fitted	Yes Alternator poles 4
Magnetic pickup fitted	No

Miscellaneous settings

Start button must be held down to crank	No
Audible alarm prior to starting	No
Number of start attempts	3
Enable fast loading feature	No
All warnings are latched	No
Enable mains failure detection	Yes
Enable immediate mains dropout	No
Single list instrument display	Yes
Inhibit retransfer to mains	No

Input settings

Low oil pressure input type	VDO 10 bar
High coolant temp input type	VDO 120 degrees C
Fuel level input type	Not used

	Trip	Return	
Low oil pressure pre-alarm	1.17 / 17.0 / 117	1.24 / 18.0 / 124	Bar / PSI / Kpa
Low oil pressure shutdown	1.03 / 14.9 / 103		Bar / PSI / Kpa
High coolant temp pre-alarm	115°C 239°F	110°C 230°F	
High coolant temp shutdown	120°C 248°F		
Low coolant temperature	<Disabled>		

Digital Inputs

1 Remote start on load	Close to activate		
2 User configured	Close to activate	Shutdown	Always active
Activation delay 0.0s	Active text :	Digital input 2	
3 User configured	Close to activate	Warning	Active from safety on
Activation delay 0.0s	Active text :	Digital input 3	
4 Generator closed auxiliary	Close to activate		
5 Mains closed auxiliary	Close to activate	Warning	
6 Auxiliary mains fail	Close to activate		
7 User configured	Close to activate	Electrical trip	Active from safety on
Activation delay 0.0s	Active text :	Digital input 7	
8 User configured	Close to activate	Indication	Always active
Activation delay 0.0s	Active text :	Digital input 8	
9 Panel lock	Close to activate		

Expansion input settings

F130 expansion enabled	No
------------------------	----

55xx for Windows. Configuration for 5520 module. Page 2 of 4

Configuration description

1
2
3
4

Filename - 5520a.ycf

Printed on 23/10/2006 08:55:18

Output settings

Module relays

1 Energise	Preheat (during pre-heat timer)
2 Energise	Common alarm
3 Energise	System in auto mode
4 Energise	Close generator
5 De-energise	Close mains

Expansion Outputs A

1 Energise	Output not used
2 Energise	Output not used
3 Energise	Output not used
4 Energise	Output not used
5 Energise	Output not used
6 Energise	Output not used
7 Energise	Output not used
8 Energise	Output not used

Expansion Outputs B

1 Energise	Output not used
2 Energise	Output not used
3 Energise	Output not used
4 Energise	Output not used
5 Energise	Output not used
6 Energise	Output not used
7 Energise	Output not used
8 Energise	Output not used

LED settings

1 Lit	Remote start on load
2 Lit	Panel locked by digital input
3 Lit	Delayed alarms armed
4 Lit	Digital input 8 active

Timer settings

Starting timers

Mains transient delay	2s
Start delay	5s
Pre-heat	0s
Pre-heat bypass	0m
Sensor fail delay	2.1s
Cranking time	10s
Crank rest time	10s
Smoke limit	0s
Smoke limit off	1s
Safety on delay	10s
Overspeed overshoot	0s

Load timers

Warming up time	0s
Transfer time	0.7s
Breaker close pulse	0.5s
Breaker trip pulse	0.5s

Digital input 4 is assigned to generator auxiliary contact

Gen fail to close	1.0s
Gen fail to open	1.0s

Digital input 5 is assigned to mains auxiliary contact

Mains fail to close	1.0s
Mains fail to open	1.0s

Return delay	30s
Cooling time	1m
ETS solenoid hold	0s
Fail to stop delay	30s

Other timers

Batt low volts delay	1m
Batt high volts delay	1m
LCD auto scroll timer	2s
LCD page timer	5m
Parallel run time	30.0s
Reverse power alarm	2.0s
Generator transient delay	0.0s
Out of sync delay	0.5s

55xx for Windows. Configuration for 5520 module. Page 3 of 4

Configuration description

1
2
3
4

Filename - 5520a.ycf

Printed on 23/10/2006 08:55:18

Mains settings

Under volts trip	Trip 184V Ph-N	Return 207V Ph-N
Over volts trip	277V Ph-N	253V Ph-N
Under frequency trip	45.0 Hz	48.0 Hz
Over frequency trip	55.0 Hz	52.0 Hz
Mains CT Enabled	No	

Mains decoupling

Alarm action	Auxiliary mains fail		
R.O.C.O.F.	Trip 0.20Hz/s	Return	Delay
Vector shift	6.0°		
Mains under voltage	209V Ph-N	219V Ph-N	0.1s
Mains over voltage	253V Ph-N	241V Ph-N	0.1s
Mains under frequency	47.1 Hz	47.2 Hz	0.1s
Mains over frequency	50.5 Hz	50.3 Hz	0.1s

Generator settings

Voltage and frequency settings

Under volts trip	Trip 184V Ph-N	Return
Under volts pre-alarm	196V Ph-N	207V Ph-N
Nominal generator voltage	230V Ph-N	
Over volts pre-alarm	265V Ph-N	254V Ph-N
Over volts trip	277V Ph-N	
Under frequency trip	40.0 Hz	
Under frequency pre-alarm	42.0 Hz	45.0 Hz
Nominal generator frequency	50.0 Hz	
Over frequency pre-alarm	55.0 Hz	52.0 Hz
Over frequency trip	57.0 Hz	

Alternative voltage select	No	230v norm / 115v alt
Alternative frequency select	No	50Hz norm / 60Hz alt
Loading voltage	207V Ph-N	
Loading frequency	45.0 Hz	

Current settings

CT primary	600 A
CT secondary	5 A
Generator full load rating	500 A
Earth fault CT primary rating	600 A

Delayed overcurrent	Trip 100% (500 A)	Curve/Multiplier 36	Action Electrical trip
Short circuit	200% (1000 A)	33	Electrical trip
Earth fault	10% (50.0 A)	1000	Shutdown
Negative phase sequence			<Disabled>

Power settings

Reverse power	Trip 35.0 kW	Action Electrical trip
---------------	------------------------	----------------------------------

Synchronising (auto sync) settings

Governor interface	Internal analogue
Governor output reversed	No
Action when on load	Adjust to nominal frequency
AVR interface	Internal analogue
AVR output reversed	No
Action when on load	Adjust to nominal voltage

Synchronising (check sync) settings

Enable synchronising	Yes	
Dead bus relay	20V Ph-N	
Check sync lower frequency	-0.1 Hz	
Check sync upper frequency	0.2 Hz	
Check sync RMS voltage	2.0V Ph-N	
Check sync phase angle	5°	
Fail to sync time	1m	Warning

Load control

kW Load control mode	kW fixed export
Generator full load rating	345 kW (431 KVA)
Generator full VAR rating	258 kVAr (0.80 pf)
Load ramp rate	3.0 percent per second
Loss of excitation warning	<Disabled>
Loss of excitation trip	<Disabled>

55xx for Windows. Configuration for 5520 module. Page 4 of 4

Configuration description

1
2
3
4

Filename - 5520a.ycf

Printed on 23/10/2006 08:55:19

Engine settings

Crank disconnect	Trip	
Crank disconnect on generator frequency	21.0 Hz	
Crank disconnect on generator voltage	<Disabled>	
Crank disconnect on charge alternator	<Disabled>	
Crank disconnect on oil pressure	<Disabled>	Bar / PSI / Kpa
Check oil pressure prior to starting	Yes	

Speed settings

Overspeed overshoot 0%

Plant battery settings

	Trip	Return
Under volts warning	10.0V DC	10.5V DC
Over volts warning	30.0V DC	29.5V DC
Charge alternator warning	6.0V DC	

Maintenance alarm settings

Enable maintenance alarm No

Exercise scheduler settings

Enable exercise scheduler No

Language settings

Default language	English (UK)
User defined language 1	Chinese (Simplified)
User defined language 2	French (France)
User defined language 3	Spanish (International)
User defined language 4	Not used

15 SENDER WIRING RECOMMENDATIONS

15.1.1 USING EARTH RETURN (SINGLE WIRE) SENDERS.

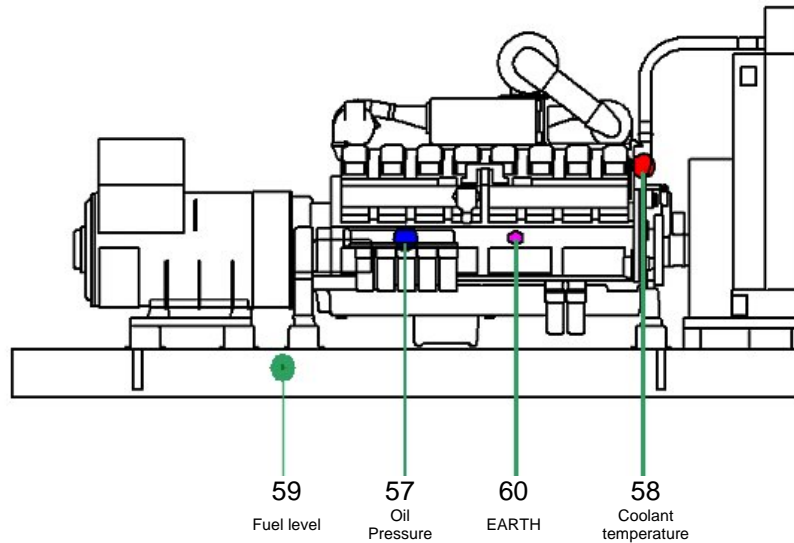

⚠ NOTE:- . It is important that terminal 60 (sender common) is soundly connected to an earth point on the ENGINE BLOCK, not within the control panel and must be a sound electrical connection to the sender bodies.

⚠ NOTE:- . If you use PTFE insulating tape on the sender thread when using earth return senders, ensure you do not insulate the entire thread as this will prevent the sender body from being earthed via the engine block.

15.1.2 USING INSULATED RETURN (TWO WIRE) SENDERS.

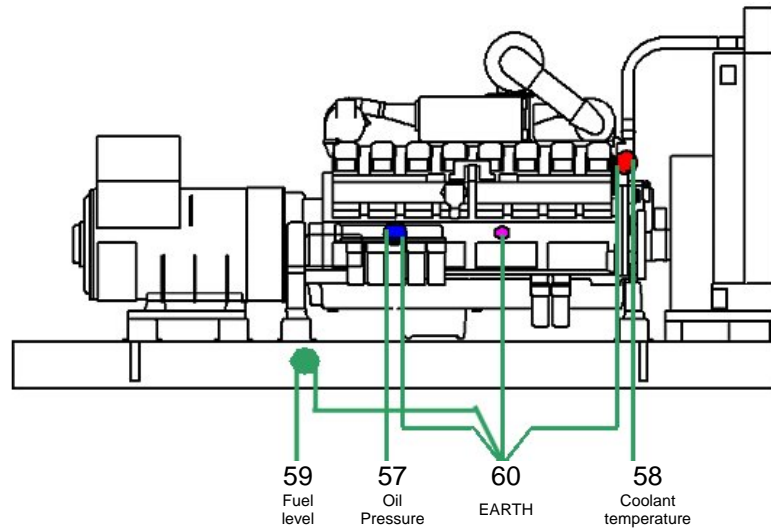

NOTE:- . It is important that terminal 60 (sender common) is soundly connected to an earth point on the ENGINE BLOCK, not within the control panel.

16 APPENDIX

16.1 5520 IDMT TRIPPING CURVES (TYPICAL)

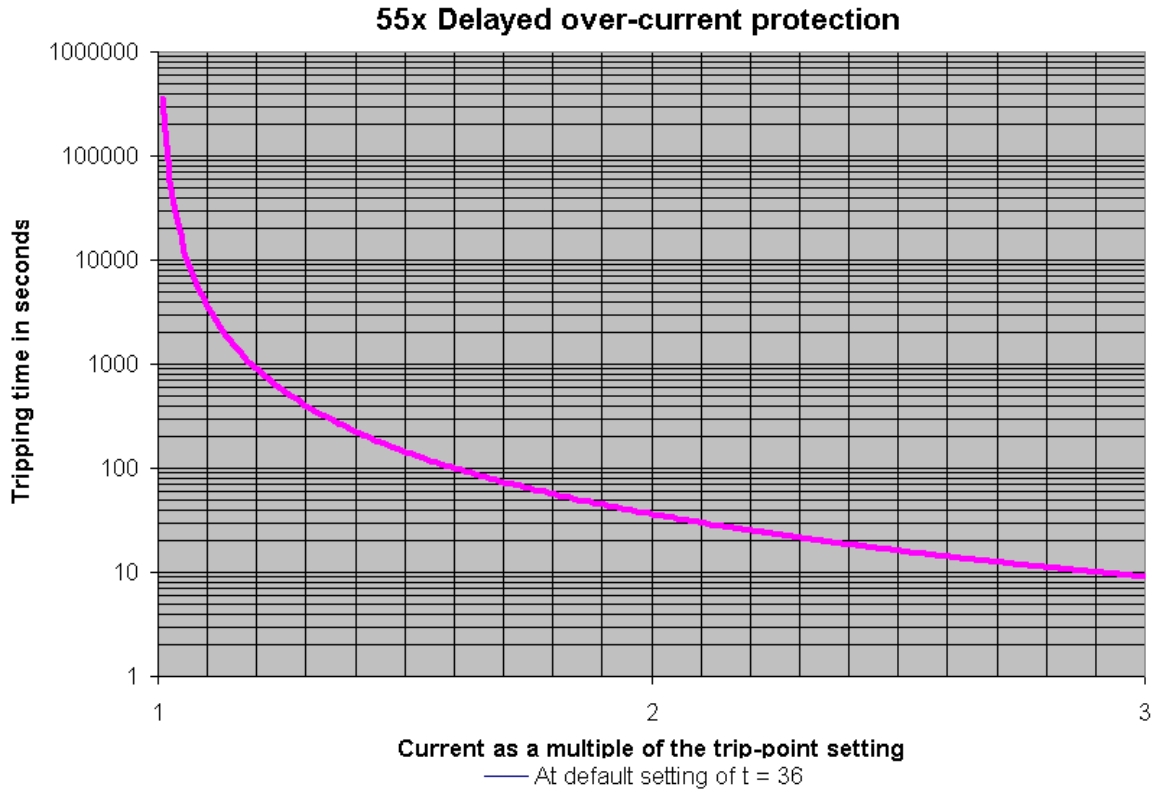

16.2 5510 SHORT CIRCUIT TRIPPING CURVES (TYPICAL)

**Model 55x Short circuit & Earth fault curves for a
Single phase fault @ 50 Hz**

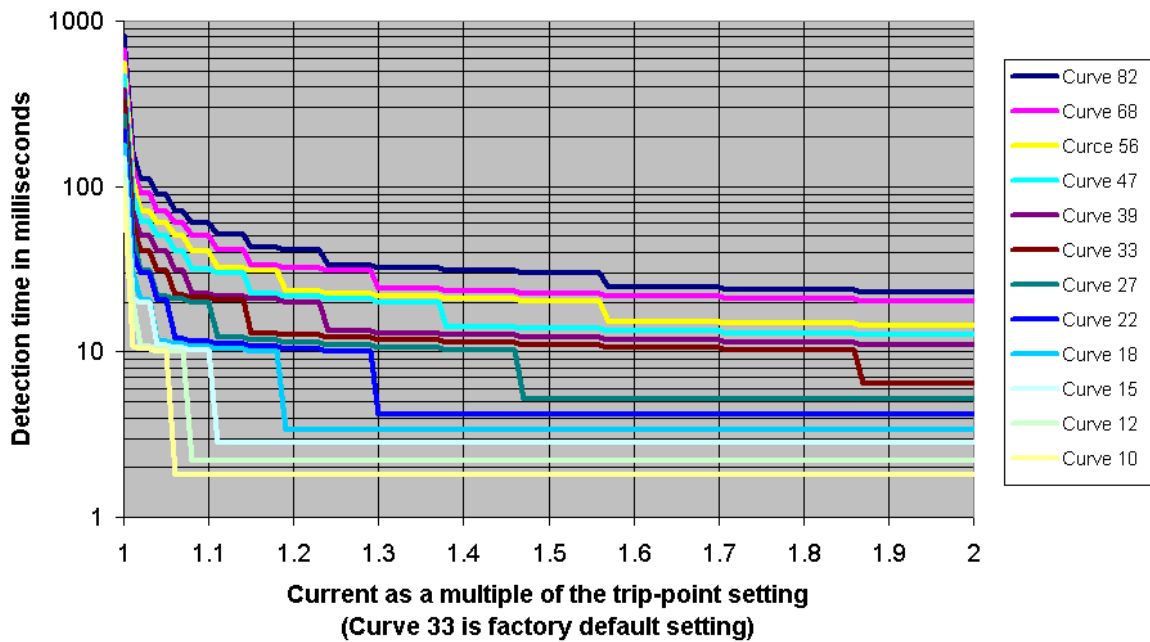

16.3 ACCESSORIES

16.3.1 OUTPUT EXPANSION

There are several methods of output expansion available for the 55xx range of modules: -

RELAY OUTPUT EXPANSION (157)

An expansion module is available, which connects to the configuration socket, and enables the 55xx to use eight additional relays, providing Volt-free contacts for customer connection. A maximum of two of these units can be used give 16 independent volt-free contacts.

The 157's need to be identified as module 'A' and module 'B'

Refer to technical data sheet on the 157 relay module for further details.

LED OUTPUT EXPANSION (548)

An expansion module is available, which connects to the configuration socket, and enables the 55xx to use the eight additional LED's on the 548 module, providing remote LED's indication. A maximum of two of these units can be used give 16 independent remote LED's.

The 548's need to be identified as module 'A' and module 'B'

Refer to technical data sheet on the 548 LED modules for further details.

It is possible to use a mix of 157 and 548 modules to give both relay and LED expansion if required.

16.3.2 INPUT EXPANSION (P130/P540/P541)

It is possible to increase the number of monitored inputs available by utilising either:

- DSE P130 input expansion.
- 540 / 541 Protection Expansion/Annunciator.

Please refer to the relevant product documentation for further details.

16.4 COMMUNICATIONS OPTION

16.4.1 DESCRIPTION

The 5xxx series configuration software allows the 5520 controller to communicate with a PC. The computer can be connected to the module either directly, via a modem (RS232)* or via an RS485 link**.

The operator is then able to remotely control the module, starting or stopping the generator, selecting operating modes, etc. The various operating parameters (such as output volts, oil pressure, etc.) on the remote generator can also be viewed.

The information contained in this manual should be read in conjunction with the appropriate module documentation. This manual only details the operation of the communications software and how it should be used. The operation of the module is detailed in its own relevant manual.

NOTE: - *If modem communications is a requirement, then it is important to order the correct 5520 module with the RS232 communications board fitted. This provides a 9-way D-type connector suitable for connection to the modem. Please refer to the *comms* section of this manual for details of how the system should be configured.

**If RS485 communications is required, then it is important to order the correct 5510 module with the RS485 communications board fitted. This provides a 3-way terminal block for connection of the RS485 link.

16.4.2 PC TO CONTROLLER (DIRECT) CONNECTION

To connect a 5510 to a modem the following items are required: -

- Any 5520 Module (RS232 or RS485)
- 5xxx series configuration software (Supplied on DSE software CD).
- P810 interface (USB or RS232 as required)

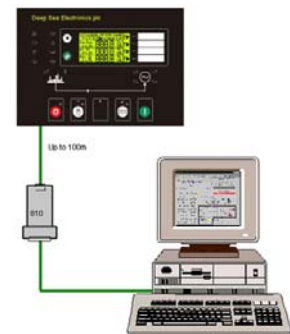

16.4.3 MODEM TO CONTROLLER CONNECTION

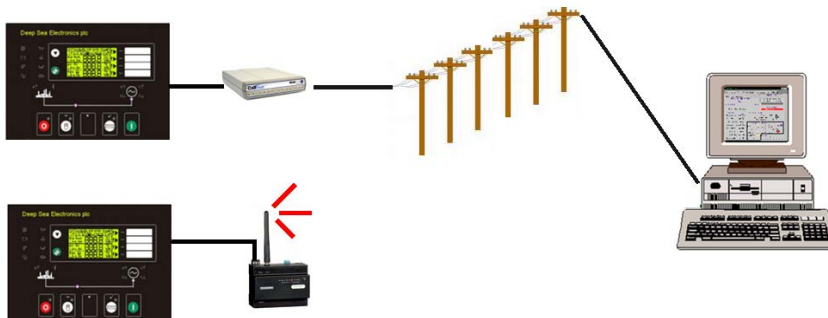

To connect a 5520 to a modem the following items are required: -

- 5520 Module with RS232 Communications Interface
- Compatible RS232 Modem (PSTN or GSM)
- Suitable connection leads
- Power supply for the modem
- 5xxx series configuration software (Supplied on DSE software CD).
- Access to a PSTN Line or GSM network.

CAUTION! - The modem must be powered from a suitably stabilised supply, preferably supplied with the modem (see below). Failure to ensure continuity of supply will result in communication difficulties at such times as Mains failure or during cranking. An uninterruptible power supply arrangement is recommended (AC or DC depending on modem power requirement).

16.4.4 RS485 LINK TO CONTROLLER

The RS485 enabled 5520 modules are able to communicate with a PC or other RS485 enabled device over a standard RS485 connection. Typical uses of RS485 are:

- Direct connection to a remote PC running the Link5000 software. RS485 is capable of communication over a distance of 1.2km where suitable 120Ω RS485 cable is installed.
- Connection to a building management to allow mains, generator and engine parameters/alarm conditions to be displayed along with information from other devices (air conditioning, fire alarm system etc).

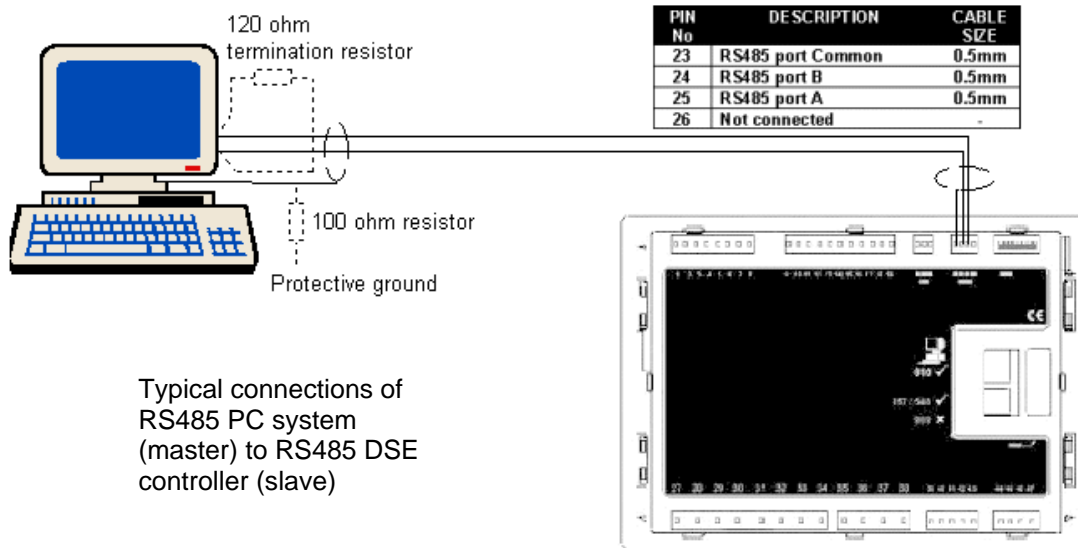

NOTE: - The RS485 system will comprise of one MODBUS master (typically a PC) and up to 31 MODBUS slaves. The 5520 modules are always MODBUS slave devices. To ensure correct operation a suitable 120Ω terminal resistor must be fitted to each end of the RS485 connection bus.

Caution! - The A and B lines of the 485 network should be terminated at each end with a 120Ω resistor.

Some RS485 devices (PC cards in particular) are already fitted with a terminating resistor. However if they are not installed as an 'end of line' device then such terminating resistors must be removed. Other RS485 devices may be fitted with a 'switchable' resistor, again this must be switched out if the device is not installed as an 'end of line' device.

TYPICAL BUILDING MANAGEMENT SCHEME USING RS485 MONITORING

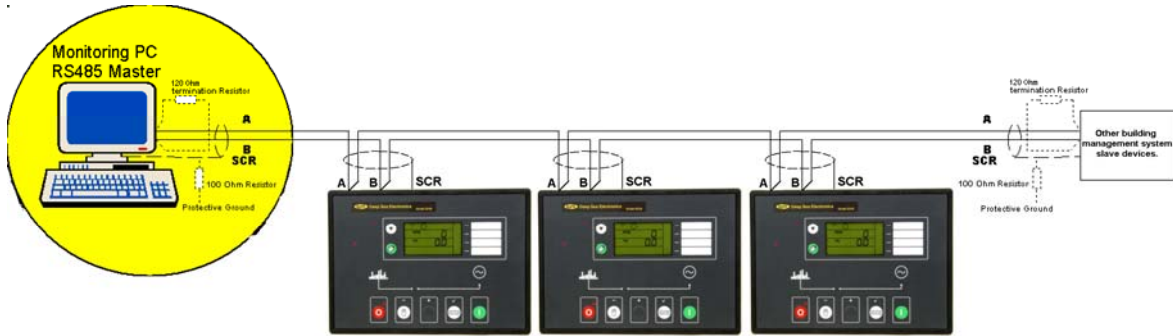

CAUTION! -. RS485 cabling must be 120Ω impedance cable, specified for use with RS485. 120Ω terminating resistors must be fitted to the first and last devices on the bus. Some PC RS485 cards are already fitted with this resistor, and in this case should not be fitted externally. If in doubt, consult the supplier of your PC RS485 card. If the 5520 controller is the 'last' device on the bus, then its RS485 connection must be suitably terminated with a 120Ω resistor as detailed in the specification laid out in the RS485 standard.

Recommended cable BELDEN 9841 120Ω RS485 cable.
DSE part number 016-030.

NOTE: - The RS485 output uses 'MODBUS' protocol. It is possible to use third party software to monitor and control the 5520 module via this protocol. Please refer to Deep Sea Electronics Plc for details.

16.4.5 MODBUS™

The RS485 output uses Modbus™ communications protocol. This uses a master-slave technique to communicate. Only the Master can initiate a packet transaction, called a 'query'. When appropriate the slave (5520 Module) responds to the query and provides the information requested by the master.

All supported data can be read and written as specified in the register table (documentation is available from Deep Sea Electronics Plc.).

When the 5520 Module receives a query it will respond by either supplying the requested register data or performing the requested action. A slave device (the 5520 module) will never initiate communications on the Modbus™ link. The 5520 can only be configured as a slave device. The Master can only query individual slaves. Refer to the Modbus™ protocol document for more details.

Refer to the Link5000plus Manual for further details on communications expansion.

NOTE:- 5560 controller only available with RS485 communications.

16.5 IEEE C37.2 STANDARD ELECTRICAL POWER SYSTEM DEVICE FUNCTION NUMBERS

The DSE 5520 contains many protection devices and functions, which are listed in detail in the following sections.

Functions and protections provided corresponding to IEEE C37.2 (1996) system device numbers are listed below.

Overall, the 5520 is designated as *11 - Multifunction device* and includes the following protections and functions:

Device	Description
2	time delay starting or closing relay
3	checking or interlocking relay
5	stopping device
12	overspeed device
14	underspeed device
15	speed or frequency matching device
18	accelerating or decelerating device
25	synchronizing or synchronism-check relay
27	undervoltage relay
30	annunciator relay
31	separate excitation device
32	directional power relay
46	reverse-phase or phase-balance current relay
48	incomplete sequence relay
50	instantaneous overcurrent relay
51	ac time overcurrent relay

52	ac circuit breaker	A device that is used to close and interrupt an ac power circuit under normal conditions or to interrupt this circuit under fault or emergency conditions.
54	turning gear engaging device	A device either electrically operated, controlled, or monitored that functions to cause the turning gear to engage (or disengage) the machine shaft.
55	power factor relay	A device that operates when the power factor in an ac circuit rises above or falls below a predetermined value.
59	overvoltage relay	A device that operates when its input voltage exceeds a predetermined value.
62	time-delay stopping or opening relay	A device that imposes a time delay in conjunction with the device that initiates the shutdown, stopping, or opening operation in an automatic sequence or protective relay system.
63	pressure switch	A device that operates at a given pressure value or at a given rate of change of pressure.
69	permissive control device	A device with two-positions that in one position permits the closing of a circuit breaker, or the placing of a piece of equipment into operation, and in the other position, prevents the circuit breaker or the equipment from being operated.
71	level switch	A device that operates at a given level value, or on a given rate of change of level.
74	alarm relay	A device other than an annunciator, as covered under device function 30, that is used to operate, or that operates in connection with, a visual or audible alarm.
78	phase-angle measuring relay	A device that functions at a predetermined phase angle between two voltages, between two currents, or between voltage and current.
81	frequency relay	A device that responds to the frequency of an electrical quantity, operating when the frequency or rate of change of frequency exceeds or is less than a predetermined value.
83	automatic selective control or transfer relay	A device that operates to select automatically between certain sources or conditions in equipment or that performs a transfer operation automatically.
86	lockout relay	A device that trips and maintains the associated equipment or devices inoperative until it is reset by an operator, either locally or remotely.
90	regulating device	A device that functions to regulate a quantity or quantities, such as voltage, current, power, speed, frequency, temperature, and load, at a certain value or between certain (generally close) limits for machines, tie lines, or other apparatus.

16.6 ENCLOSURE CLASSIFICATIONS

IP CLASSIFICATIONS

BS EN 60529 Degrees of protection provided by enclosures

First Digit	Second digit
Protection against contact and ingress of solid objects 0 No protection	Protection against ingress of water 0 No protection
1 Protected against ingress solid objects with a diameter of more than 50 mm. No protection against deliberate access, e.g. with a hand, but large surfaces of the body are prevented from approach.	1 Protection against dripping water falling vertically. No harmful effect must be produced (vertically falling drops).
2 Protected against penetration by solid objects with a diameter of more than 12 mm. Fingers or similar objects prevented from approach.	2 Protection against dripping water falling vertically. There must be no harmful effect when the equipment (enclosure) is tilted at an angle up to 15° from its normal position (drops falling at an angle).
3 Protected against ingress of solid objects with a diameter of more than 2.5 mm. Tools, wires etc. with a thickness of more than 2.5 mm are prevented from approach.	3 Protection against water falling at any angle up to 60° from the vertical. There must be no harmful effect (spray water).
4 Protected against ingress of solid objects with a diameter of more than 1 mm. Tools, wires etc. with a thickness of more than 1 mm are prevented from approach.	4 Protection against water splashed against the equipment (enclosure) from any direction. There must be no harmful effect (splashing water).
5 Protected against harmful dust deposits. Ingress of dust is not totally prevented but the dust must not enter in sufficient quantity to interface with satisfactory operation of the equipment. Complete protection against contact.	5 Protection against water projected from a nozzle against the equipment (enclosure) from any direction. There must be no harmful effect (water jet).
6 Protection against ingress of dust (dust tight). Complete protection against contact.	6 Protection against heavy seas or powerful water jets. Water must not enter the equipment (enclosure) in harmful quantities (splashing over).

NEMA CLASSIFICATIONS

▲ NOTE: - There is no direct equivalence between IP / NEMA ratings. IP figures shown are approximate only.

1 IP30	Provides a degree of protection against contact with the enclosure equipment and against a limited amount of falling dirt.
2 IP31	Provides a degree of protection against limited amounts of falling water and dirt.
3 IP64	Provides a degree of protection against windblown dust, rain and sleet; undamaged by the formation of ice on the enclosure.
3R IP32	Provides a degree of protection against rain and sleet;; undamaged by the formation of ice on the enclosure.
4 (X) IP66	Provides a degree of protection against splashing water, windblown dust and rain, hose directed water; undamaged by the formation of ice on the enclosure. (Resist corrosion).
12/12K IP65	Provides a degree of protection against dust, falling dirt and dripping non corrosive liquids.
13 IP65	Provides a degree of protection against dust and spraying of water, oil and non corrosive coolants.

12. SYNCHRONISING NOTES

Optionally, the 5520 controller can be configured to synchronise, volts match and parallel with the mains supply. This facility can be used to supply a fixed amount of power to the load and/or mains supply or provide no-break (closed transition) transfers to and from the generator supply. Additionally, with the addition of the optional Mains CT, the module can be used to automatically start the set upon rising mains load and use the generator set to keep the mains load below an adjustable level.

16.6.1 CHECK SYNC

(If enabled)

The module will control the operation of the load-switching device to allow parallel operation with the mains supply only when the two supplies are in Synchronism. These functions can be used to provide manual Peak lopping/ Peak shaving and short duration no-break or bump-less transfers back to the mains supply following a mains failure.

Refer to the 5xxx software manual for further details.

16.6.2 AUTO SYNC

(If enabled)

The module provides control signals to the Engine Governor and the Alternator AVR to control the speed and voltage output from the generating set.

These functions can be used to provide peak lopping/ peak shaving (without load share control) and true no-break or bump-less transfers back to the mains supply following a mains failure.

The 5xxx module provides the ability to control the generator by adjusting the speed (frequency) and voltage being output. Several methods of providing this control are available. The following pages give a schematic overview of the interface with the engine governor and alternator AVR.

Refer to the 5xxx software manual for further details.

16.6.3 LOAD CONTROL

(If enabled)

The module features all the functions associated with the Check sync and autosync features and in addition it provides control signals to the Engine Governor and the Alternator AVR while in parallel with the mains (utility) supply to provide soft loading (load ramping) and control the amount of load (kW and kVAr) supplied by the generating set.

These functions can be used to provide peak lopping / peak shaving and true no-break or bump-less transfers back to the mains supply following a mains failure.

MAINS CT

Mains current monitoring is included as standard to allow (optional) automatic starting of the set on rising load levels to allow true peak lopping / shaving, ramping of the load from the mains to the set and vice versa and more.

Refer to the 5xxx software manual for further details.

16.6.4 TYPICAL PEAK LOPPING SYSTEM

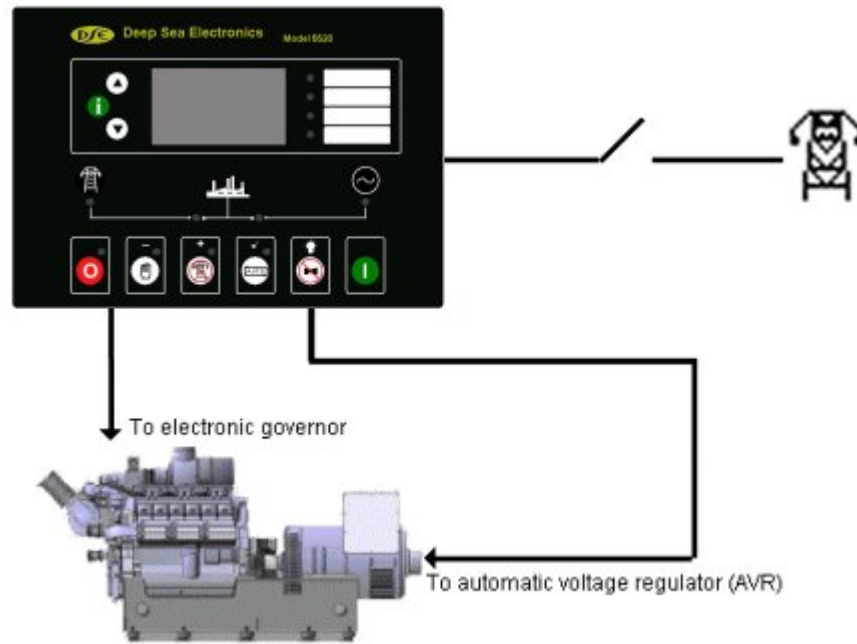

For further details on this subject, you are referred to the Deep Sea Electronics Guide to Synchronising and Load Sharing Parts 1 and 2.