

**TYTON<sup>®</sup>**

# DUCTILE IRON PIPE SYSTEMS

FOR THE AUSTRALASIAN WATER INDUSTRY

---

# TYTON

THE DUCTILE IRON PIPE SYSTEMS

Throughout Australasia, TYTON® is the most recognised and trusted brand of Ductile Iron Pipe Systems for potable water and wastewater applications. The time proven, robust TYTON JOINT® is at the core of our pipe system which provides flexibility, ease of installation and is your guarantee of quality.

Viadux Water Network Solutions is dedicated to exceeding customer expectations. We encourage open communication between staff, customers and related organisations to make positive impacts on the future of the marketplace and assist in improving the quality of life for people nationwide. Sustainable development lies at the heart of Viadux Water Network Solutions' corporate culture. State-of-the art technologies and a focus on research, development and reliable sourcing have enabled us to consistently provide our customers with quality, sustainable, reliable and economic solutions.

Sustainable development depends on 'long lasting' rather than 'disposable' installations and the use of environmentally friendly materials which are readily recyclable. Viadux Water Network Solutions has taken on board these principles and works to provide effective solutions for you our customers and the environment.

# WHY CHOOSE DUCTILE IRON?

Ductile iron is the most versatile pipe material today offering solutions to specific pipeline demands, whether determined by the application, or the installation requirements. Ductile iron can be used above or below ground, is safe to specify even if future demands change from specifications today.

## STRUCTURAL DESIGN: DUCTILE IRON GUARANTEES SAFETY

As a result of the ductility of the material, which gives a high capacity for absorbing work or energy, ductile iron pipes and fittings have a high safety margin, allowing the opportunity to operate at up-rated pressures in the future.

### FACTOR OF SAFETY<sup>1</sup>

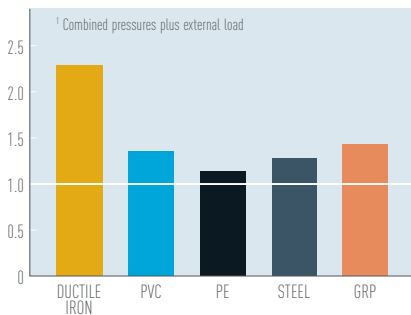

- The inherent structural strength of the pipe guarantees durability and reliability for long term service
- The high factor of safety of ductile iron gives continued performance even if future demands change, for example through increased usage from housing developments
- The inherent material strength of ductile iron compensates for unforeseen environmental changes, for example change of land use or ground settlement
- Easy to design and specify
- Excellent resistance to second comer damage
- No long term reduction in pipe stiffness



- Ductile iron takes the risk out of pipeline design
- Incorporates a 200gsm Zinc coating for active corrosion protection with self healing properties

### BURSTING PRESSURE - PIPES

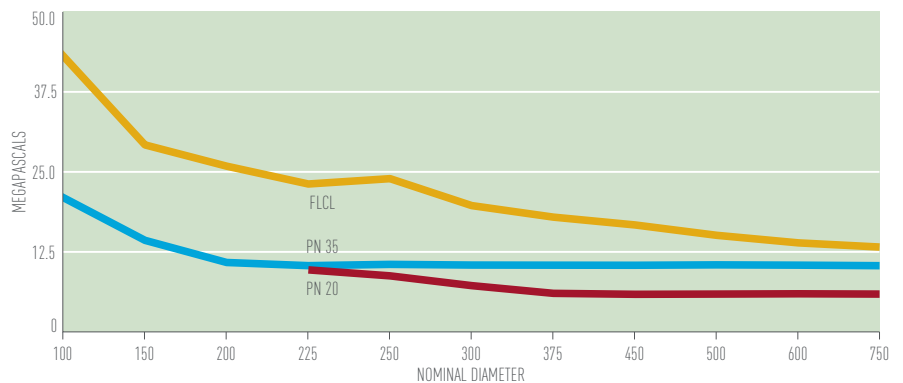

## HIGH STRENGTH AND STIFFNESS

Ductile iron is suitable for installation in open fields or high traffic load areas and can be laid at a variety of depths. The high material strength minimises the need for imported bedding and surround, hence minimising the impact on the environment.

- Can be laid in narrow and/or shallow trenches
- Can be laid at a wide range of depths with no detrimental effect on the performance of the pipe
- Minimises risk due to unforeseen site hazards, such as second-come damage

## REDUCING FAILURE RATES: DUCTILE IRON ASSURED LONG TERM RELIABILITY

Through a continual programme of developments and innovations the failure rates of ductile iron systems consistently reduce compared to alternative materials.

- Reliable long term solution
- Can adapt to future changes in external load

## RING STIFFNESS

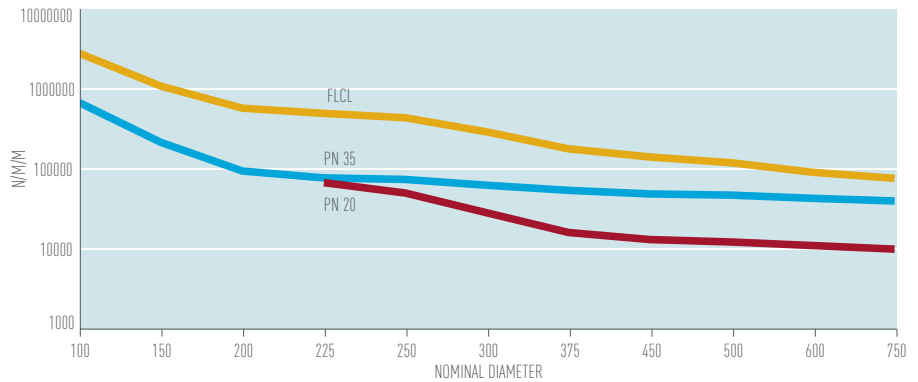

## MAXIMUM DEPTHS OF COVER

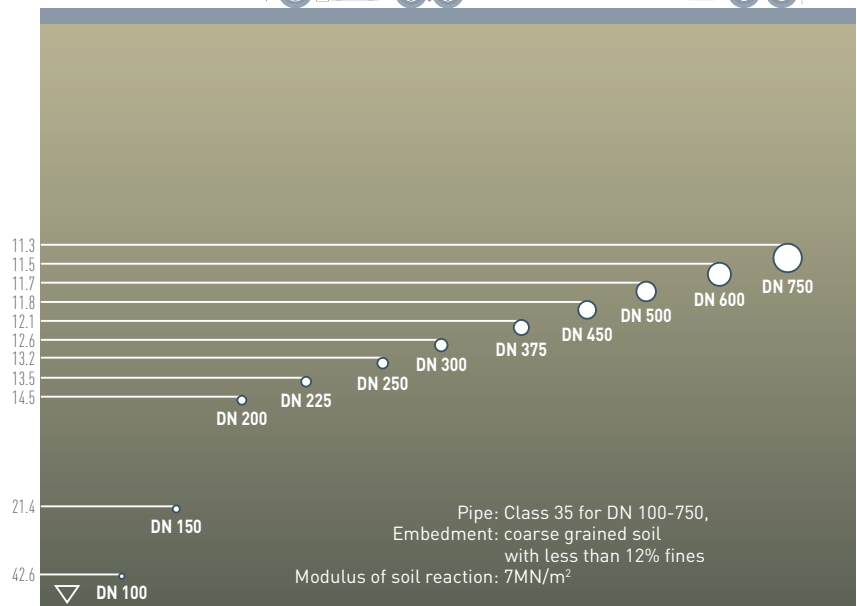

## TRUNK MAINS FAILURE RATE AVERAGES BY MATERIAL TYPE

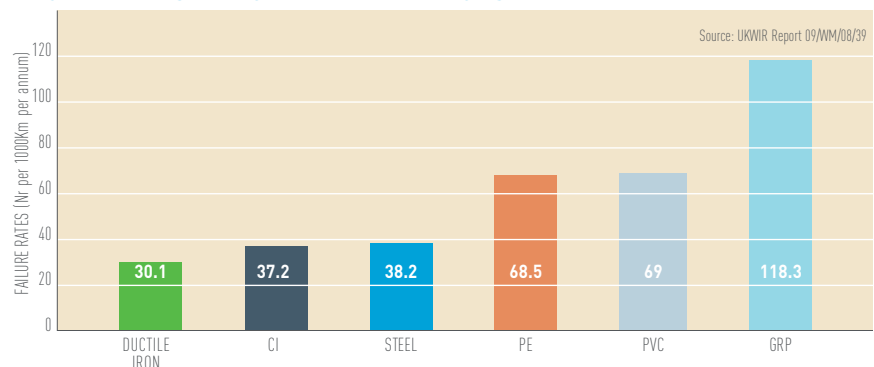



## INSTALLATION AND TESTING: INSTALL, TEST AND FORGET

Viadux Water Network Solutions offers pipe systems which have well proven and highly engineered jointing solutions. These jointing solutions are able to withstand the rigours of installation, testing and provide long term reliability once in service.

- The TYTON® push-fit joint is simple and robust and provides high flexibility in both application and installation
- Simple jointing techniques, for easy installation
- Testing Ductile Iron Pipe Systems is simple, once passed there is no need to repeat test at a later time. Install, test and forget, requires less supervision on-site
- Jointing solutions which allow installation whatever the weather conditions
- No specialist equipment required
- Capable of angular deflection and axial withdrawal, providing opportunity to reduce the number of fittings required
- Caters for unforeseen ground movements

## HYDRAULIC FLOW: DUCTILE IRON GIVES CONSTANT PERFORMANCE

The nominal bore of ductile iron pipe is the minimum bore you can expect for a given size. Ductile iron pipe internal bore is always greater than nominal diameter: for example DN 200 = 212mm internal bore.

- Hydraulic flow characteristics are not altered by pressure increases or decreases
- An increase in working pressure does not mean an increase in diameter requirement



## PRESSURE CAPABILITY: DUCTILE IRON OFFERS THE SOLUTION WHATEVER THE PRESSURE

TYTON Ductile Iron Pipe Water and Wastewater Pipe Systems are designed to give long term performance whatever the pressure requirements.

- Ductile Iron systems cover a wide spectrum of pressure requirements
- Ability to cope with increases in main pressure requirement
- Simple to specify

## SOIL CONDITIONS: DUCTILE IRON OFFERS ADVANCED TECHNICAL SOLUTIONS

TYTON Ductile Iron Pipe Systems are designed to cope with the most aggressive of soil conditions whilst offering cost effective solutions.

- Zinc coating system, available on **TYTONXCEL** and **TYTONXTREME**: can be used in most Australian soils
- For very aggressive ground conditions Viadux Water Network Solutions offer solutions which are optimised for Brownfield or contaminated sites
- Complete range of epoxy coated fittings, suitable for use in all conditions

# TECHNICAL SERVICES

## FULL PROJECT LIFE SUPPORT

To ensure cost effective solutions Viadux Water Network Solutions offers full project life support from early design advice, soil surveys and drawing take-offs to on-site support and installation certification for contractors and engineers.

## PIPE SPEC DESIGN SOFTWARE

DI-Design is design software developed by Viadux Water Network Solutions as a support tool to assist engineers in the design and specification of pipeline schemes. The software features five analytical tools that can be utilised throughout the

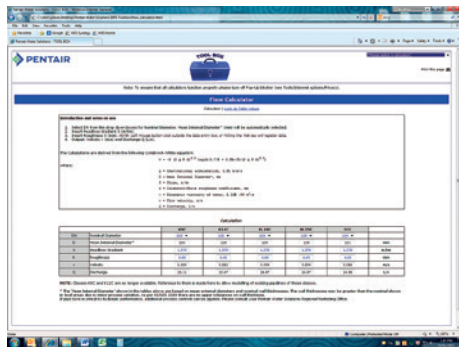

planning and design stages of the project:

- Hydraulics
- Embedment
- Anchorage
- Installed cost
- Beam design

To obtain a copy of DI-Design, free of charge, contact the Viadux Water Network Solutions Project Office.

## DRAWING TAKE-OFF SERVICE

A team of experienced civil estimators is available to carry out drawing take-offs, providing a detailed list of products required. The service includes optimisation of design to ensure that the most cost-effective solution is achieved.

Viadux Water Network Solutions has the facility to accept drawings in electronic format. Please consider the following instructions for use of this facility:

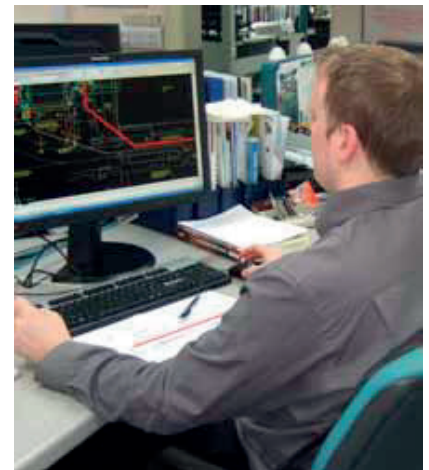

- All drawings to be compatible with AutoCAD2002/2004

- All drawings sent to relate only to pipework for off-take

- All drawings to be 'clean', i.e., drawings to fill the whole screen in a reasonable and printable size

To avoid delays in dealing with requests, please ensure that the relevant sections of the specification are sent at the same time as the drawings, either by mail or e-mail.

## TYTONCAD FILES

To assist our clients in drafting high performance TYTON® Series ductile iron pipeline systems, Viadux Water Network Solutions has developed a family of '.dwg' files which can be used by a range of Computer Aided Drafting software packages. These files comprise fittings dimensioned to the requirements of AS/NZS 2280

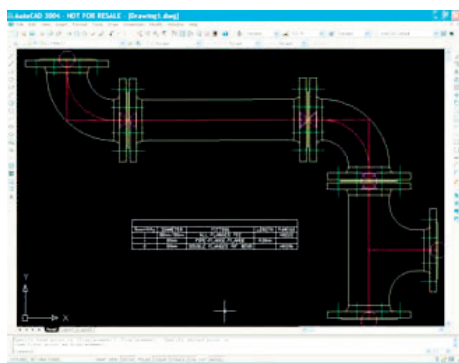

ductile iron pipes and fittings. CAD files increase quality, turnaround, security and reliability and have proven themselves invaluable over the years. A family of 3D fittings is in development together with a suite of valve files dimensioned to AS/NZS 2638 Gate valves for waterworks purposes.

To obtain a copy of TYTONCAD files, free of charge, contact the Viadux Water Network Solutions Project Office.

---

## TECHNICAL SUPPORT

Technical support is available to all existing and potential customers, staffed by an experienced team of engineers offering a broad range of expertise and advice on:

- Product and material compatibility
- Installation and testing
- Embedment and hydraulic flow calculations
- Regulatory requirements

Please contact the Viadux Water Network Solutions Project Office for technical support.

## SOIL SURVEYS

Viadux Water Network Solutions can arrange a detailed soil assessment along the route of a proposed pipeline. The results of the assessment provide a detailed analysis of ground conditions, allowing the most appropriate external protection system to be specified.

Please contact the Viadux Water Network Solutions Project Office for technical support.



## CENTURY PLUS

This program aims to give confidence to water utilities and contractors that pipes and fittings will be installed effectively and in optimum condition. The program offers contractors hands-on training in handling, storing, installing and commissioning TYTON® Series Ductile Iron Pipes and Fittings. A process of on-site valuation and assessment of actual installation is used to support the certification of contractors successfully completing the program.

For more information on the installation of ductile iron pipes, fittings and valves, please refer to the TYTON Ductile Iron Pipelines Handling and Installation Manual. This set of instructions is based on best practices which are acknowledged within the industry.

This manual provides clear and concise guidance for the installation of ductile iron pipelines from delivery through to on-site commissioning and is designed to ensure that the performance of ductile iron pipes and fittings is not adversely affected during installation.

Please contact the Viadux Water Network Solutions Project Office for more information.

# QUALITY ASSURANCE

Viadux Water Network Solutions regards quality as essential to the success of its business. From detailed metallurgical analysis of the molten metal to tight control of coating and lining applications, procedures have been developed to ensure consistent high quality of each individual pipe and fitting. Additionally, every pipe and fitting is pressure tested in accordance with AS/NZS 2280.

The “quality-is-key” principle applies to every stage of the manufacturing process and includes:

- Validation of suppliers and/or their materials
- Continuous assessment of quality systems
- On-going monitoring of product quality
- Technical support prior to and after sales
- On-time delivery of products and supporting information



## COMPLIANCE WITH STANDARDS

Viadux Water Network Solutions products comply with and are tested according to relevant Australian, British, European and International Standards. All pipes and fittings are manufactured under the quality management system ISO 9001, 2000.

All Viadux Water Network Solutions TYTON ductile iron pipes and fittings for water and waste-water applications conform to the latest version of AS/NZS 2280. Development of pipes and fittings can take place across Viadux Water Network Solutions and our suppliers. As such, third party accreditation is always achieved with the relevant auditing body e.g., BSI in the UK, Bureau Veritas (BV) in France, MPA-NRW in Germany and SAI Global in Australia. All of these certification bodies are also independently accredited, for example BSI is accredited by UKAS.

In addition, all materials in contact with potable water used by Viadux Water Network Solutions comply with AS/NZS 4020.



## POSITIVELY APPRAISED: WSAA RECOMMENDED

The Water Services Association of Australia National Product Appraisals program is a voluntary scheme introduced by the WSAA to provide a single coordinated appraisal of a product’s conformity to the needs of the urban water businesses.

The program is designed for manufacturers, suppliers, importers, distributors or agents who have a product that may be suitable for use by the water industry and is a process of assessment and

review of the design, performance and suitability of a product for use in water and wastewater infrastructure at a nominated performance level.

Included is a review of the quality management system under which the product is manufactured and supplied. Applicants are provided with a report and recommendations resulting from the assessment and review. Final authorisation, approval or acceptance for use of the product lies with the individual water businesses.

Ductile iron pipes are covered by WSAA PA 13/14.

Ductile iron fittings are covered by WSAA PA 10/16 Part 2.









# TYTONXCEL DUCTILE IRON PIPE SYSTEM

## SPECIFICATIONS

### DRIVEN BY PRESSURE CLASSIFICATION

**TYTONXCEL** Ductile Iron Pipe design, now with 200gsm active zinc protection, reflects state-of-the-art manufacture in evolving water industry demands.

With the introduction of pressure classes, PN 20 and PN 35, **TYTONXCEL** becomes the first class choice for efficiency gains and cost savings without sacrificing the time proven superior performance capabilities associated with DI pipeline systems.

**TYTONXCEL** delivers with:

- ✓ **Increased bores**  
– increased flows – reduced head loss – lower pumping costs
- ✓ **Decreased mass**  
– faster laying
- ✓ **Increased efficiency**  
– reduced cost – more savings
- ✓ **Active corrosion protection**  
– 200gsm Zinc – Longer lasting



### TYTONXCEL PN 35 CEMENT LINED PIPE DETAIL

Nominal size	DN	100	150	200	225	250	300	375	450	500	600	750
Diameter – mean external	mm	122	177	232	259	286	345	426	507	560	667	826
	– mean internal	102	157	212	239	265	322	401	480	532	636	790
Effective laying length	m	5.75	5.75	5.75	5.75	5.75	5.75	5.75	5.75	5.75	6.00	6.00
Mass – lined	kg	102	150	200	232	270	356	501	661	779	1080	1596
Nominal barrel ring stiffness	kN/m/m	695	220	96	79	75	63	55	49	48	44	40
Ring deflection – max. allowable	%	1.7	2.5	3.3	3.5	3.5	3.7	3.8	4.0	4.0	4.0	4.0
Joint deflection	deg	3.5	3.5	3.5	3.5	3.5	2.5	2.5	2.5	2.5	2.5	1

All PN 35 sizes: Allowable Operating Pressure is 3.5MPa; Maximum Allowable Operating Pressure is 4.2MPa; Allowable Site Test Pressure is 4.38MPa

### TYTONXCEL PN 20 CEMENT LINED PIPE DETAIL

Nominal size	DN	–	–	–	225	250	300	375	450	500	600	750
Diameter – mean external	mm	–	–	–	259	286	345	426	507	560	667	826
	– mean internal	–	–	–	239	266	325	406	486	538	643	798
Effective laying length	mm	–	–	–	5.75	5.75	5.75	5.75	5.75	5.75	6.00	6.00
Mass – lined	kg	–	–	–	225	249	301	386	492	572	779	1138
Nominal barrel ring stiffness	kN/m/m	–	–	–	69	51	29	16	13	12	11	10
Ring deflection – max. allowable	%	–	–	–	3.7	4.0	4.0	4.0	4.0	4.0	4.0	4.0
Joint deflection	deg	–	–	–	3.5	3.5	2.5	2.5	2.5	2.5	2.5	1

All PN 20 sizes: Allowable Operating Pressure is 2.0MPa; Maximum Allowable Operating Pressure is 2.4MPa; Allowable Site Test Pressure is 2.50MPa

- Pipe masses are based on mean dimensions, for lifting masses consult the Viadux Water Network Solutions Ductile Iron Pipe Systems Design Manual and Handling & Installation Manual.
- For derivation of barrel ring stiffness see 'Guidelines for the ring bending stiffness and allowable deflection of ductile iron pipe', Water Services Association of Australia, Information and Guidance Note TN3.
- Ring deflection is the ovalisation of the pipe barrel under vertical load.
- Joint deflection is the maximum allowable rotation of the TYTON JOINT®.



# TYTONXTREME DUCTILE IRON PIPE SYSTEM

## SPECIFICATIONS

---

### BEATING ATTACK

Sewers are one of the toughest environments in the water game with  $H_2SO_4$  their dark master.

Other industries foster similar nasties, all handled by **TYTONXTREME**, including the extremes of sulfates, pH and  $H_2S$ . It also carries extremes of pressure, from positive to negative, sealing in the nasties and keeping out infiltration. Peerless!

**TYTONXTREME** combines the best features of TYTON proven Ductile Iron Pipe Systems with materials that provide high resistance to chemical attack and abrasion.

This is achieved by using calcium aluminate cement (CAC) in lieu of sulfate resisting (SR) cement in the barrel lining. This is complemented by the application of an epoxy coating in the pipe jointing region. CAC is an effective lining for aggressive fluids with extreme pH values and/or abrasive solids.

Cement mortar linings have been successfully used in ductile iron pipes to convey sewage for many years, especially in pumped pressure conditions.

Typical sewerage environments are alkaline and non-aggressive to cement mortar linings. In these non-septic/non-acidic situations, commonly used cements such as AS 3972 Type SR provide satisfactory long term service.

In septic/acidic aggressive sewer environments calcium aluminate cement provides a high level of resistance and is the most appropriate material for most of these applications.





# TYTONXTREME DUCTILE IRON PIPE SYSTEM

## SPECIFICATIONS



AS 3972 Type SR cement is recommended for:

- sulfate levels up to 6,000mg/L
- continuous pH levels down to 5.5
- hydrogen sulfide levels up to 0.5mg/L

Calcium Aluminate Cement (CAC) (as specified in AS/NZS 2280 is recommended for:

- sulfate levels up to saturation
- continuous pH levels down to 4.0
- hydrogen sulfide levels up to 10mg/L

Designers, installers and operators can now have confidence, not only in the proven mechanical strength of ductile iron, but in its enhanced ability to resist internal attack from aggressive fluids such as sewage and industrial waste.

**TYTONXTREME** also features Active corrosion protection.

- 200gsm Zinc - longer lasting

### TYTONXTREME PN 35 CEMENT LINED PIPE DETAIL

Nominal size	DN	100	150	200	225	250	300	375	450	500	600	750
Diameter – mean external – mean internal	mm	122	177	232	259	286	345	426	507	560	667	826
		102	157	212	239	265	322	401	480	532	636	790
Effective laying length	m	5.75	5.75	5.75	5.75	5.75	5.75	5.75	5.75	5.75	6.00	6.00
Mass – lined	kg	102	150	200	232	270	356	501	661	779	1080	1596
Nominal barrel ring stiffness	kN/m/m	695	220	96	79	75	63	55	49	48	44	40
Ring deflection – max. allowable	%	1.7	2.5	3.3	3.5	3.5	3.7	3.8	4.0	4.0	4.0	4.0
Joint deflection	deg	3.5	3.5	3.5	3.5	3.5	2.5	2.5	2.5	2.5	2.5	1

All PN 35 sizes: Allowable Operating Pressure is 3.5MPa; Maximum Allowable Operating Pressure is 4.2MPa; Allowable Site Test Pressure is 4.38MPa

### TYTONXTREME PN 20 CEMENT LINED PIPE DETAIL

Nominal size	DN	–	–	–	225	250	300	375	450	500	600	750
Diameter – mean external – mean internal	mm	–	–	–	259	286	345	426	507	560	667	826
		–	–	–	239	266	325	406	486	538	643	798
Effective laying length	m	–	–	–	5.75	5.75	5.75	5.75	5.75	5.75	6.00	6.00
Mass – lined	kg	–	–	–	225	249	301	386	492	572	779	1138
Nominal barrel ring stiffness	kN/m/m	–	–	–	69	51	29	16	13	12	11	10
Ring deflection – max. allowable	%	–	–	–	3.7	4.0	4.0	4.0	4.0	4.0	4.0	4.0
Joint deflection	deg	–	–	–	3.5	3.5	2.5	2.5	2.5	2.5	2.5	1

All PN 20 sizes: Allowable Operating Pressure is 2.0MPa; Maximum Allowable Operating Pressure is 2.4MPa; Allowable Site Test Pressure is 2.50MPa

- Pipe masses are based on mean dimensions, for lifting masses consult the TYTON Ductile Iron Pipe Systems Design Manual and Handling & Installation Manual.
- For derivation of barrel ring stiffness see 'Guidelines for the ring bending stiffness and allowable deflection of ductile iron pipe', Water Services Association of Australia, Information and Guidance Note TN3.
- Ring deflection is the ovalisation of the pipe barrel under vertical load.
- Joint deflection is the maximum allowable rotation of the TYTON JOINT®.







# TYTONXTEND DUCTILE IRON PIPE SYSTEM

## SPECIFICATIONS



### GROUND MOVEMENT

When it comes to mine subsidence, embankment slippage, soil settlement or ground movements, **TYTONXTEND** is without comparison.

Based on the quintessential TYTON pipe joint, **TYTONXTEND** incorporates an extended socket throat which accommodates erratic and unpredictable ground strain in both axial and rotational movement. A pipeline's integrity is preserved and that vital water or sewer line remains uncompromised.

**TYTONXTEND** also offers the most flexible solution for your high ground strain application. By matching geotechnical input and service performance requirements, **TYTONXTEND** can be designed to meet your specific requirements. **TYTONXTEND** will accommodate various combinations of joint rotation and relative axial movement. Standard profiles exist and can accommodate ground strains up to  $\pm 3\text{mm/m}$  versus  $1\text{mm/m}$  for the standard TYTON pipe joint. Strains in excess of  $\pm 3\text{mm/m}$  can also be catered for. This ability to accommodate higher ground strains is achieved by extending the socket throat depth of the standard TYTON pipe joint.

**TYTONXTEND** also features Active corrosion protection.  
- 200gsm Zinc - Longer lasting

### TYTONXTEND PN 35 CEMENT LINED PIPE DETAIL

Nominal size	DN	100	150	200	225	250	300	375	450	500	600	750
Diameter – mean external	mm	122	177	232	259	286	345	426	507	560	667	826
	– mean internal	102	157	212	239	265	322	401	480	532	636	790
Effective laying length	m	5.75	5.75	5.75	5.75	5.75	5.75	5.75	5.75	5.75	6.00	6.00
Mass – lined	kg	102	150	200	232	270	356	501	661	779	1080	1596
Nominal barrel ring stiffness	kN/m/m	695	220	96	79	75	63	55	49	48	44	40
Ring deflection – max. allowable	deg	1.7	2.5	3.3	3.5	3.5	3.7	3.8	4.0	4.0	4.0	4.0
Joint deflection	deg	3.5	3.5	3.5	3.5	3.5	2.5	2.5	2.5	2.5	2.5	1

All PN 35 sizes: Allowable Operating Pressure is 3.5MPa; Maximum Allowable Operating Pressure is 4.2MPa; Allowable Site Test Pressure is 4.38MPa

### TYTONXTEND PN 20 CEMENT LINED PIPE DETAIL

Nominal size	DN	–	–	–	225	250	300	375	450	500	600	750
Diameter – mean external	mm	–	–	–	259	286	345	426	507	560	667	826
	– mean internal	–	–	–	239	266	325	406	486	538	643	798
Effective laying length	m	5.75	5.75	5.75	5.75	5.75	5.75	5.75	5.75	5.75	6.00	6.00
Mass – lined	kg	–	–	–	225	249	301	386	492	572	779	1138
Nominal barrel ring stiffness	kN/m/m	–	–	–	69	51	29	16	13	12	11	10
Ring deflection – max. allowable	deg	–	–	–	3.7	4.0	4.0	4.0	4.0	4.0	4.0	4.0
Joint deflection	deg	–	–	–	3.5	3.5	2.5	2.5	2.5	2.5	2.5	1

All PN 20 sizes: Allowable Operating Pressure is 2.0MPa; Maximum Allowable Operating Pressure is 2.4MPa; Allowable Site Test Pressure is 2.50MPa

- Pipe masses are based on mean dimensions, for lifting masses consult the Viadux Water Network Solutions Ductile Iron Pipe Systems Design Manual and Handling & Installation Manual.
- For derivation of barrel ring stiffness see 'Guidelines for the ring bending stiffness and allowable deflection of ductile iron pipe', Water Services Association of Australia, Information and Guidance Note TN3.
- Ring deflection is the ovalisation of the pipe barrel under vertical load.
- Joint deflection is the maximum allowable rotation of the TYTON JOINT®.

# TYTON-LOK

## RUBBER RING JOINT PIPELINE THRUST RESTRAINT SYSTEM

### PRESSURE RATINGS TO 20 BAR A RANGE OF SIZES TO DN 375

Negotiate crowded service trenches.  
Meet impossible hydrotest deadlines.  
Succeed with on time commissioning.  
Avoid the nightmare of weak soils that cannot bear any pressure.  
TYTON-LOK is the key to fast tracking design and construction of Ductile Iron Pipe Systems with these unique advantages –

- ✓ Available in a range of sizes DN 100 to DN 375
- ✓ Utilises standard TYTON JOINT® rubber ring fittings
- ✓ Allows simplicity of rubber ring joint assembly with all joints fully restrained
- ✓ Eliminates any need for concrete thrust blocks
- ✓ Accelerates commissioning with no wait time for concrete curing
- ✓ Streamlines materials sourcing and administration
- ✓ Ideal in weak soils where concrete blocks just won't work
- ✓ Provides for up to 3.5 degrees of joint deflection
- ✓ Provides for maximum security with strategic mains (fully locked joints)
- ✓ Provides an allowable operating pressure (AOP) of 1.6MPa

### SIMPLE INSTALLATION

The TYTON-LOK system provides thrust restraint for TYTON JOINT Ductile Iron Pipe Systems.

The nucleus of the system is the TYTON-LOK gasket, similar to a standard TYTON® gasket but with the addition of a circumferential series of stainless steel toothed inserts.



The gasket is inserted into a pipe or fitting in the normal manner. With axes aligned, the joint is made and subsequently deflected if required.

To engage the restraining teeth, the pipe can be either backed off with a sling or simply pressurised in commissioning. The latter method should only be employed by experienced constructors.

### HOW TYTON-LOK JOINTS WORK

The resultant forces of normal operating pressures act upon unrestrained joints, driving them apart. A TYTON-LOK joint immediately reacts to this relative movement.

The teeth rotate, grip and bite into the withdrawing spigot, thus restraining it from being blown out of the socket.

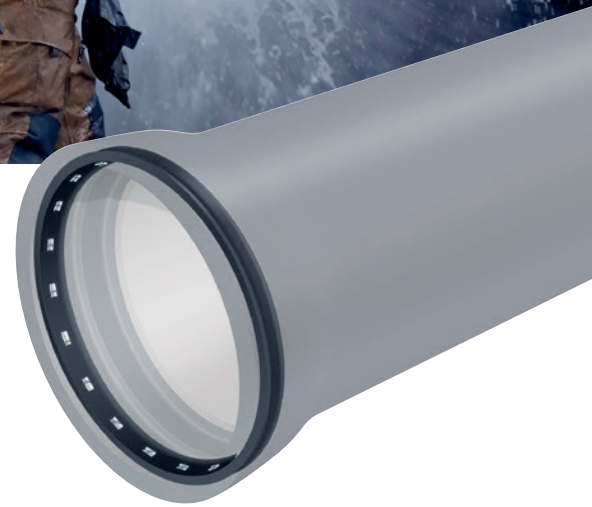

The reaction of a TYTON-LOK joint effectively acts like the barbs of an arrowhead, the more the spigot is pushed out, the more the teeth bite.

The result is a fully restrained joint system that eliminates the need for thrust blocks.

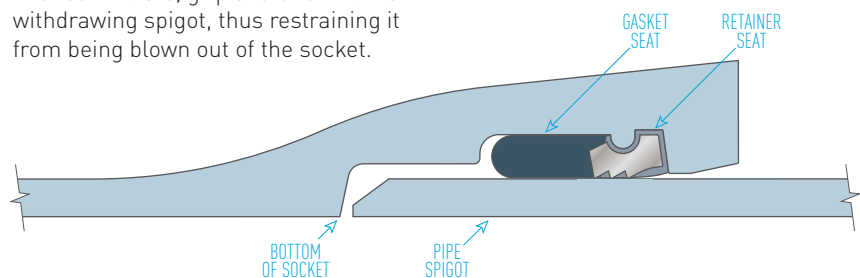

## DESIGNING A TYTON-LOK® RESTRAINED JOINT SYSTEM

Viadux Water Network Solutions has interactive design software available from its Project Office. The program covers all configurations and results can be printed for offline reference.

TYTON-LOK joints function in a manner similar to thrust blocks.

Effectively, forces in a working pipeline need to be dissipated into the surrounding soil.

If we look at the case of a thrust block in simplistic terms, the 'point' forces in the pipeline are transferred through the concrete block into the soil through the surface contact area of the block.

In the case of TYTON-LOK joints the forces are dissipated into the soil over 'a length' of pipeline via friction and bearing over the pipeline length. The objective is to determine the length of pipe that must be restrained adjacent to a thrust force. This will be a function of the pipe size, the internal pressure, depth of cover, and the characteristics of the soil surrounding the pipe.

The TYTON-LOK Restrained Joint System can be simply designed using the available software, or assistance and advice can be obtained from your local Viadux Water Network Solutions Project Office.

In this diagram of a horizontal bend, the source of the restraining forces is seen to be two fold. First, the static friction between the pipe unit and the soil, and second, the restraint provided by the pipe as it bears against the sidefill.

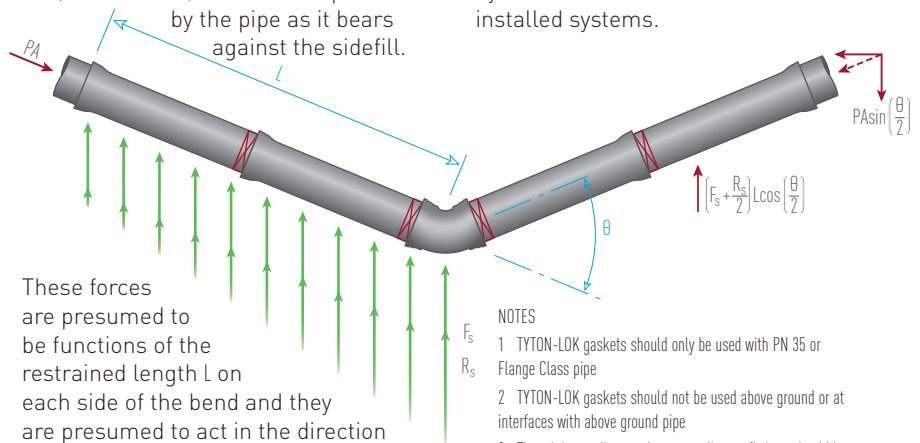

These forces are presumed to be functions of the restrained length L on each side of the bend and they are presumed to act in the direction opposing the thrust force (i.e., directly opposing impending movement of the bend). The same principle applies to tees, reducers, etc.

The total frictional resistance on each side of the bend is

$$F_s L \cos(\theta/2) \text{ kN}$$

The total assumed bearing resistance on each side of the bend is

$$R_s/2 L \cos(\theta/2) \text{ kN}$$

The equilibrium for the free body is then

$$P A \sin(\theta/2) = F_s L \cos(\theta/2) + R_s/2 L \cos(\theta/2) \text{ kN}$$

Solving for L

$$L = P A \tan(\theta/2) / (F_s + R_s/2) \text{ m}$$

The approach presented, which includes safety factors, is a practical and conservative general thrust restraint design that has been verified by available test data and numerous installed systems.

### NOTES

- 1 TYTON-LOK gaskets should only be used with PN 35 or Flange Class pipe
- 2 TYTON-LOK gaskets should not be used above ground or at interfaces with above ground pipe
- 3 The minimum distance between adjacent fittings should be 20 times the pipe nominal diameter

## MORE APPLICATIONS FOR TYTON-LOK RESTRAINED JOINTS

TYTON-LOK restrained joints can also be used in thrust boring applications. The gaskets are used to lock joints together so that an assembled string of pipes can be drawn through a bored casing. Pinsulators should be strapped to the pipe to protect the pipe and reduce casing friction.

The maximum length of assembled TYTON-LOK pipe can then be estimated using

$$F = \mu R$$

where

$$F = 1.6nD^2/4 \text{ N}$$

$\mu$  = coefficient of friction

R = normal reaction

$$= nw$$

where

D = outside diameter of pipe mm

n = the number of pipes in the string,

w = the unit weight of a pipe N

Thus

$$n = F/\mu w$$

$$= 1.6nD^2/4/(\mu w)$$





# TYTON® FLANGE CLASS DUCTILE IRON PIPE

## SPECIFICATIONS

---

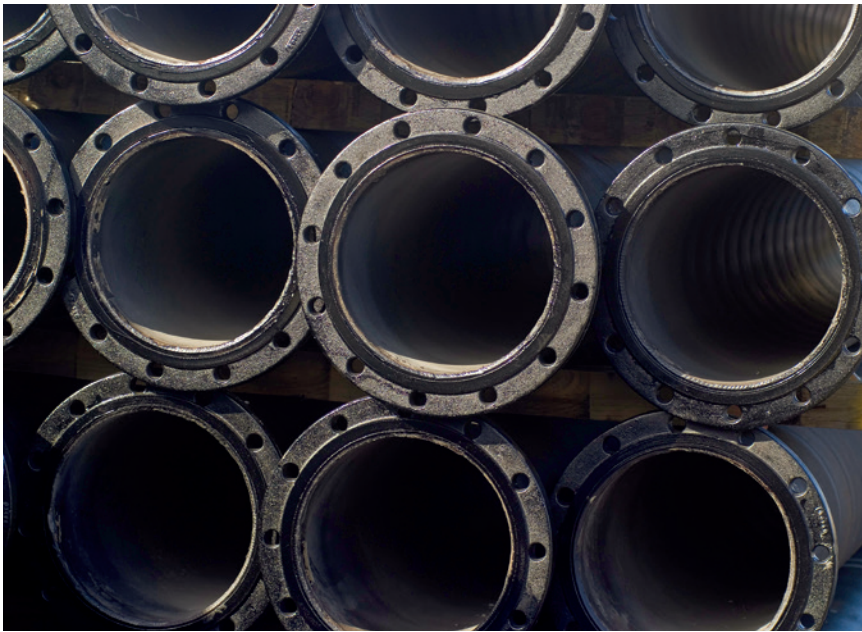

'Flange Class' TYTON pipe is specially manufactured with thick walls to allow machining and screw threading attachment of flanges.

Flanges are generally to AS 4087 Fig B5 (PN16) and Fig B6 (PN35) and are sealed using 3mm EPDM and 1.5mm fibre gaskets respectively. Pipes are cast with a TYTON socket profile allowing them to be easily incorporated as an RRJ interface.

Wall thicknesses are equivalent to the superseded pipe class K12 and allow much higher pressure ratings than PN 35.

Flanged pipe is used extensively in treatment plants, pump stations and above ground applications where ease of component removal is essential for maintenance or structural integrity is required. TYTON FLANGE CLASS pipe provides this capability most effectively.

# POLYBOSS™ LOOSE POLYETHYLENE SLEEVING

## SPECIFICATIONS

---



### EFFECTIVE PROTECTION

For Ductile Iron Pipelines, loose polyethylene sleeving is the most cost effective means of corrosion control.

Continuing developments include the move to Linear Low Density Polyethylene. The CENTURY PLUS® program and PIQS have contributed significantly to its reputation. POLYBOSS, for example, is now formulated with metallocenes making it tougher, with higher tensile and impact strength combined with a higher resistance to ultra violet radiation. POLYBOSS comes in three colours to provide identification of a pipeline.

This system offers even more security for ductile iron pipelines in creating a protective environment. Effective protection for a lifetime.

# TYTON JOINT®

## VALVES, FITTINGS & APPURTENANCES

### SPECIFICATIONS

#### QUALITY & AVAILABILITY.

CRITICAL TO THE DESIGN, CONSTRUCTION, OPERATION AND MAINTENANCE OF YOUR PIPELINE SYSTEM.

Viadux Water Network Solutions prides itself on being able to manufacture and source these critical components, providing the ultimate assurance of service performance and life.

#### TYTON JOINT VALVES

TYTON JOINT Valves include resilient seated gate valves (RSGVs), metal seated gate valves (MSGVs) and reflux or check valves. They feature the TYTON JOINT rubber ring jointing system which permits rapid assembly and leak tight performance. The RSGVs range in size from DN 80 to DN 600 and are available in PN 16 while DN 80 to DN 150 are available in PN 25. The MSGVs range in size from DN 80 to DN 1000. They are normally finished with fusion coated nylon, epoxy or Plascoat.

By-pass valves are also available in larger sizes (DN 375-DN 900) to provide ease of opening and closure of valves in service. Large bore by-passes facilitate draining and filling the line.



#### TYTON JOINT FITTINGS AND APPURTENANCES

TYTON JOINT Fittings and Appurtenances include bends, tees, tapers, connectors, tapping barrels and puddle flanges. Ranging in size from DN 80 to DN 750, they are normally finished with fusion coated nylon, epoxy or Plascoat. Other finishes are available including cement mortar lining and bituminous coating applied over the cement and external surfaces.

#### ALTERNATE END TYPES FOR VALVES, FITTINGS AND APPURTENANCES

Valves, fittings and appurtenances are also available in end types other than TYTON® RRJ, including SC-FL, SC-SP, SP-SP, SP-FL and FL-FL. Flanges are commonly specified as AS4087 Fig B5.

#### HYDRANTS AND HYDRANT AIR VALVE ISOLATORS

Hydrants and Hydrant Air Valve Isolators are also available. The SUREFLOW® spring hydrant is available in sizes DN 80 & DN 100 and features a removable dome support that allows easy ingress and egress of swabs for cleaning the pipeline.



# TYTON DUCTILE IRON PIPE SYSTEMS

## PERFORMANCE DRIVEN WITH PROVEN SUPPLY, PROVEN SERVICE



### SHORTEST LEAD TIME

Having the shortest lead time means having the best stocks and having them local. Managing stocks is both art and science. Good stock levels reflect good planning and judgement in anticipating demand and that can mean the difference between a late project and one finished in full, on time. The art in stocking comes through years of experience in choosing safety levels and replenishment orders...check your requirements with us first!

It boils down to simple logistics. We've got the product and supply chains that will deliver with pure performance.

### BEST DELIVERY

That means getting every pipe on site...when you want it...where you want it.

We have the people with the experience to manage the logistics and ensure your pipes and fittings come together as you intend. From outsourcing to delivery we're there all the way, from procurement through loading, transit, unloading, shipment, transit and final unloading to where it's needed...on site.

We're there for handling advice too. From pipes per truck to dunnage, bolsters, packing, chains...you name it. If its anything to do with delivery of ductile iron pipes, we've got it covered. Of course we satisfy the relevant codes and legislation in handling our pipes and make sure that's the way it is throughout the process. Safety comes first with pure performance.

### BEST PRICE

Viadux Water Network Solutions is determined to offer Ductile Iron Pipe Systems at the best price.

That means our offer is the best value for money. We make sure we cover all your requirements...specific needs for specific jobs. That way you don't pay for unnecessary baggage. The back-up services we provide are covered by our practised efficiencies in our base services.

Putting it simply we're good at what we do. We can anticipate problems in product installation, application, service and maintenance, its all part of the service but at the best price.

### HYDRO SUCCESS

#### ALL THE WAY

You're in the business of proving your workmanship every day. So are we. We know what it means to be "under the pump", demonstrating fitness for purpose.

The hydro test is the ultimate test of pipeline construction, so you want it right first time, every time. That's why the performance of all our ductile iron pipeline components is assured against manufacturing flaws and defects.

You can't beat that.

So when you're under the pump, you can be sure that TYTON components will perform for you, all the way.



And if you want some tips on successful hydrostatic testing, call a Viadux Water Network Solutions Project Office today and make sure you're on a winner.



## DUCTILE IRON PIPE SYSTEMS

### PROJECT OFFICE

#### SYDNEY

P: 02 9794 3440  
F: 02 9794 3499  
E: [projects@viadux.com.au](mailto:projects@viadux.com.au)

### CUSTOMER CENTRES

#### ADELAIDE

P: 08 8340 3411  
F: 08 8340 3422  
E: [cca.sales@viadux.com.au](mailto:cca.sales@viadux.com.au)

#### BRISBANE

P: 07 5589 4400  
F: 07 5534 7079  
E: [ccb.sales@viadux.com.au](mailto:ccb.sales@viadux.com.au)

#### DARWIN

P: 08 8935 3300  
F: 08 8947 3981  
E: [ccd.sales@viadux.com.au](mailto:ccd.sales@viadux.com.au)

#### GOLD COAST

P: 07 5589 4400  
F: 07 5534 7079  
E: [ccg.sales@viadux.com.au](mailto:ccg.sales@viadux.com.au)

#### MELBOURNE

P: 03 9309 9133  
F: 03 9309 6237  
E: [ccm.sales@viadux.com.au](mailto:ccm.sales@viadux.com.au)

#### NEWCASTLE

P: 02 4914 0700  
F: 02 4966 8776  
E: [ccn.sales@viadux.com.au](mailto:ccn.sales@viadux.com.au)

#### PERTH

P: 08 9346 8500  
F: 08 9346 8501  
E: [ccp.sales@viadux.com.au](mailto:ccp.sales@viadux.com.au)

#### SYDNEY

P: 02 9794 3440  
F: 02 9794 3499  
E: [ccs.sales@viadux.com.au](mailto:ccs.sales@viadux.com.au)

#### TOWNSVILLE

P: 07 4725 5940  
F: 07 4725 4995  
E: [cct.sales@viadux.com.au](mailto:cct.sales@viadux.com.au)

### VIADUX WATER NETWORK SYSTEMS

PO BOX 141 FAIRFIELD, NEW SOUTH WALES 1860 / [VIADUX.COM.AU](http://VIADUX.COM.AU)  
PHONE 02 9794 3400 AUSTRALIA

All Viadux trademarks and logos are owned by Viadux Pty. Ltd. All other brand or product names are trademarks or registered marks of their respective owners. Because we are continuously improving our products and services, Viadux reserves the right to change specifications without prior notice.