

3•2•1 GS Series II

3•2•1 Series II

DVD HOME ENTERTAINMENT SYSTEMS

Owner's Guide



SAFETY INFORMATION

Please read this owner's guide

Please take the time to follow this owner's guide carefully. It will help you set up and operate your system properly, and enjoy all of its advanced features. Save your owner's guide for future reference.

- WARNING:** To reduce the risk of fire or electric shock, do not expose the system to rain or moisture.
- WARNING:** This apparatus shall not be exposed to dripping or splashing, and objects filled with liquids, such as vases, shall not be placed on the apparatus. As with any electronic products, use care not to spill liquids in any part of the system. Liquids can cause a failure and/or a fire hazard.

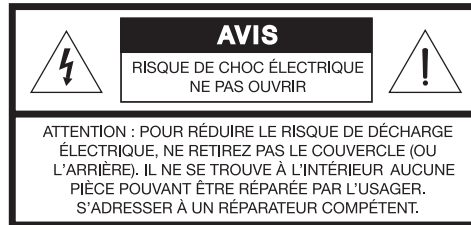
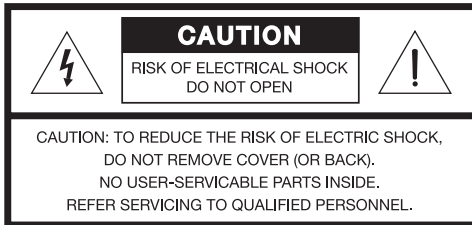

The CAUTION marks shown here are located on the bottom of your 3•2•1 Series II home entertainment system media center and the rear panel of the Acoustimass module:



The lightning flash with arrowhead symbol, within an equilateral triangle, alerts the user to the presence of uninsulated dangerous voltage within the system enclosure that may be of sufficient magnitude to constitute a risk of electric shock.



The exclamation point within an equilateral triangle alerts the user to the presence of important operating and maintenance instructions in this owner's guide.

- CAUTION:** To prevent electric shock, match wide blade of plug to wide slot, insert fully.
- CAUTION:** No naked flame sources, such as lighted candles, should be placed on the apparatus.

Class 1 laser product

This CD player is classified as a CLASS 1 LASER PRODUCT according to EN 60825-1:1994+A1+A2, IEC60825-1:1993+A1+A2.

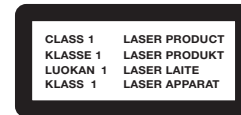

- CAUTION:** Use of controls or adjustments or performance of procedures other than those specified herein may result in hazardous radiation exposure. The DVD player should not be adjusted or repaired by anyone except properly qualified service personnel.

Class B emissions limits

This Class B digital apparatus meets all requirements of the Canadian Interference-Causing Equipment Regulations.



Batteries

Please dispose of used batteries properly, following any local regulations. Do not incinerate.



This product conforms to the EMC Directive 89/336/EEC and to the Low Voltage Directive 73/23/EEC. The complete Declaration of Conformity can be found on www.bose.com.

Additional safety information

See the additional instructions on the *Important Safety Information* sheet enclosed in the shipping carton.

CONTENTS

INTRODUCTION	5
SYSTEM SETUP	8
SYSTEM CONTROLS AND INDICATORS	26
OPERATION	35
CHANGING SOURCE SETTINGS	40
CHANGING SYSTEM OPTIONS	45
MAINTAINING YOUR SYSTEM	53
TROUBLESHOOTING	55

INTRODUCTION 5

Before you begin	5
System features	5
Selecting compatible discs	5
Checking for region code compatibility	6
Glossary of terms	6
Limited warranty	7
For your records	7

SYSTEM SETUP 8

Unpacking	8
Selecting locations for your 3•2•1 Series II system components	9
Placing the media center	9
Placing the speakers	10
Placing the Acoustimass® module	11
Making system connections	12
Connecting the Acoustimass module to the media center	12
Connecting the speakers to the Acoustimass module	12
Connecting the supplied antennas	14
Connecting cable FM radio	14
Connecting your TV to the media center	15
Making audio connections	15
Making composite video connections	15
Connecting your TV and VCR to the media center	16
If your TV has audio output jacks	16
If your TV does not have audio output jacks	17
VCR considerations	18
Advanced setup options	18
Making S-video connections (higher quality video)	18
Making component video connections (highest quality video)	19
Connecting digital audio devices	20
Connecting your cable/satellite box, TV, and VCR to the media center	20
Connecting a game console	22
Installing the remote control batteries	23
Connecting the power cord	24
Checking your system setup	25

SYSTEM CONTROLS AND INDICATORS 26

Remote control	26
Setting up your remote to control other audio/video devices	30
Direct entry of a device code	30
Searching for a device code	31
Verifying an entered device code	33
Changing the default channel tuner assignment	33
The media center	34

OPERATION **35**

Turning your system on and off	35
Playing video DVDs	35
Basic DVD operations	36
Restricting access to video DVDs	36
Playing audio CDs	37
Listening to FM/AM radio	38
Tuning to a station	38
Storing stations as presets	38
Erasing a preset	39
Playing other sources	39
Using the sleep timer	39

CHANGING SOURCE SETTINGS **40**

Using the settings menus	40
FM/AM settings menu	42
CD settings menu	42
DVD settings menu	43
TV, CBL•SAT, and AUX settings menu	44

CHANGING SYSTEM OPTIONS **45**

Using the System menu	45
Audio options	47
Video options	48
Media center options	49
Remote control options	50
DVD Lock options	51

MAINTAINING YOUR SYSTEM **53**

Cleaning	53
Replacing the remote control batteries	54
Accessories	54

TROUBLESHOOTING **55**

Troubleshooting table	55
Customer service	56

TECHNICAL INFORMATION **57**

DEVICE CODES **A-1**

Before you begin

Thank you for purchasing the Bose® 3•2•1 Series II or 3•2•1 GS Series II DVD home entertainment system, which offers superb sound, elegance, and simplicity in an advanced home audio setup. Using Bose proprietary signal processing technology, the 3•2•1 Series II systems provide improved spaciousness from stereo recordings, and bold movie effects from surround-encoded materials. Yet its few parts require little effort to set up, so you can enjoy your new system's performance right away.

The following items are included to help you set up your system:



- Quick Setup Guide
- Detailed setup instructions in the Setup section of this guide
- Setup DVD

System features

- Integrated AM/FM tuner and DVD/CD player in a small console
- Small, easy-to-place shelf speakers and an attractive hideaway Acoustimass® module
- Easy-to-use infrared remote control
- Media center input jacks for a TV, cable/satellite box or other component such as a DVR

Selecting compatible discs

The DVD/CD player built into the 3•2•1 series II media center can play the following types of discs identified by their corresponding logos:

- Video DVD 
- Audio CD 
- Video CD 
- CD-R and CD-R/W
- DVD-R and DVD-RW
- MP3 CDs, where
 - All tracks were burned in a single closed session
 - The disc format is ISO9660
 - Each file has a ".mp3" extension and the filename contains no other periods
- SACDs (CD-compatible content only)

Checking for region code compatibility

For a DVD player and DVD disc to be compatible, their region code numbers must match. These numbers are allocated according to where the player and disc are sold. The 3•2•1 Series II DVD home entertainment systems have a region code which must also match the DVD discs.

Check the region code number on the carton of the 3•2•1 Series II DVD home entertainment system or on the bottom of the media center that comes in the carton. Then be sure to choose only DVD discs that show the same region number on the disc label or front cover. For example, a Region 1 DVD disc should display the following mark:



Glossary of terms

Aspect Ratio – The shape of the rectangular picture in a TV set. It is the width of the picture relative to the height. Our standard TV picture, in terminology used by that industry, is 4 units wide by 3 units high, or 4:3 (read as 4 by 3) in aspect ratio. There are currently two standard TV aspect ratios, 4:3 and 16:9.

Chapter – In DVD-Video, a division of a title. Technically called a part of title (PTT).

Component Video – A video signal split into three parts: luminance and two color signals (marked as YPbPr). It provides the highest resolution video, but cannot be processed by all television sets.

Composite Video – A single video signal that contains luminance, color, and synchronization information. NTSC and PAL are examples of composite video systems.

Dolby Laboratories  – Developer of a perceptual coding system for audio.

Dolby Digital – a type of multi-channel surround sound format used on discs.



– the logo representing Dolby® Digital.

DTS – a type of multi-channel surround sound format used on discs.



– the logo representing DTS.

DVD – An acronym that is most commonly known to mean Digital Video Disc or Digital Versatile Disc. The audio/video/data storage system based on 12- and 8-cm optical discs.

DVD Video – A standard for storing and reproducing audio and video on DVD-ROM discs, based on MPEG video, Dolby Digital and MPEG audio, and other proprietary data formats.

IR – An acronym for infrared. Pertains to the type of remote that sends/receives commands on an infrared light beam.

Letterbox – The projected aspect ratio of feature films is often 16:9 rather than the 4:3 aspect ratio of most TVs. Therefore, it is becoming common practice to transfer films to video with black borders at the top and bottom of the picture. The film picture becomes a “letterbox” within the video.

MPEG – a type of data compression used for audio or video storage on disc.

MP3 – MPEG-1 Layer III audio. This is a compressed audio format that allows you to record many hours of music on a single CD.

NTSC – An acronym for National Television System Committee. The organization that developed both the American Black & White and Color television systems.

PAL – An acronym for Phase Alternate Line. A television format used extensively in Western Europe.

S-video – A video interface standard that carries separate luminance and chrominance signals, usually on a four-pin mini-DIN connector. Also called Y/C. The quality of S-video is significantly better than composite video since it does not require a comb filter to separate the signals. Most high-end televisions have S-video inputs.

Title – numbered elements of the DVD contents, which may include more than the movie alone.

Track – Individual selections recorded on an audio tape or disc.

Limited warranty

The 3•2•1 Series II and 3•2•1 GS Series II home entertainment systems are covered by a limited transferable warranty. Details of the limited warranty are provided on the product registration card that came with your system. Please fill out the information section on the card and mail it to Bose. Failure to do so will not affect your limited warranty rights.

For your records

Serial numbers are located on the bottom of the media center and the rear of the Acoustimass® module. Please have your serial number ready before contacting Bose® Customer Service.

Model: 3•2•1 Series II 3•2•1 GS Series II Check one

Media center serial number: _____

Acoustimass module serial number: _____

Dealer name: _____

Dealer phone: _____ Purchase date: _____

We suggest you keep your sales receipt and product registration together with this owner's guide.

©2005 Bose Corporation. No part of this work may be reproduced, modified, distributed or otherwise used without prior written permission.

Dolby and the double-D symbol are trademarks of Dolby Laboratories. Manufactured under license from Dolby Laboratories. Confidential unpublished works. 1992-1997 Dolby Laboratories. All rights reserved.

This product incorporates copyright protection technology that is protected by method claims of certain U.S. patents and other intellectual property rights owned by Macrovision Corporation and other rights owners. Use of this copyright protection technology must be authorized by Macrovision Corporation, and is intended for home and other limited viewing uses only unless otherwise authorized by Macrovision Corporation. Reverse engineering or disassembly is prohibited.

"DTS" and "DTS Digital Surround" are registered trademarks of Digital Theater Systems, Inc.

MPEG Layer-3 audio compression technology licensed by Fraunhofer IIS and THOMSON multimedia.

This product incorporates copyright protected technology and other intellectual property rights owned by Cirrus Logic, Inc. and subject to the copyright protection of the U.S. as well as other licensing restrictions and protections. Use of this copyright protected technology is limited solely to use with the Cirrus Logic integrated circuits incorporated in this product. Reverse engineering or disassembly is prohibited.

SYSTEM SETUP

Unpacking

SYSTEM SETUP

Carefully unpack your system. Save all packing materials, which provide the safest way to transport your system. Check to be sure your system includes the parts shown in Figure 1.

If any part of the system appears damaged, do not attempt to use it. Notify Bose or your authorized Bose® dealer immediately. For Bose contact information, refer to the address sheet included in the carton.

WARNING: To avoid danger of suffocation, keep the plastic bags out of the reach of children.

Figure 1

Contents of the shipping carton

Your system includes one of the following cords:

- 120 VAC power cord (U.S./Canada)
- 115/230 VAC power cord with adapter (U.S./Europe)
- 230 VAC power cord (Europe)
- 230 VAC power cord (U.K./Singapore)
- 240 VAC power cord (Australia)

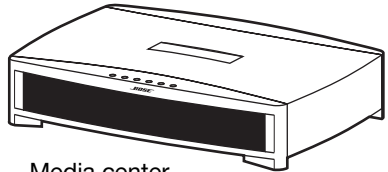

Media center

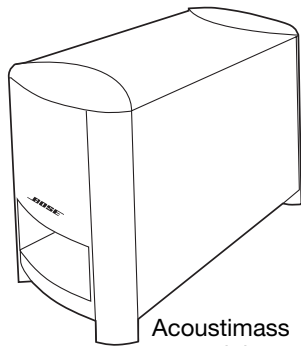

Acoustimass module

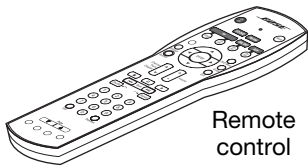

Remote control

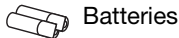

Batteries



FM antenna



Acoustimass® module cable

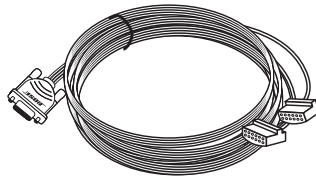

Speaker cable

Note: If you purchased a 3•2•1 GS Series II system, the left and right speaker cable connectors will be marked with a "GS".



Rubber feet for Acoustimass module

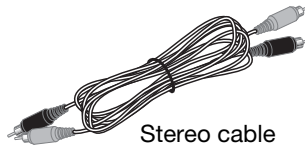

Stereo cable

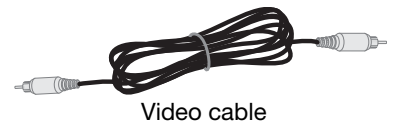

Video cable

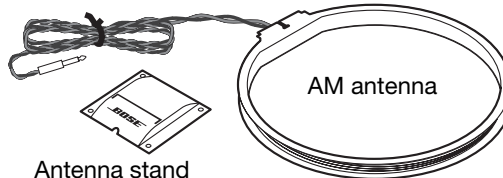

AM antenna

Antenna stand

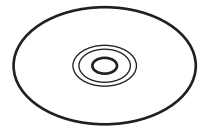

Setup and demo disc

Your system includes one of the following speaker types:

- 3•2•1 speakers
- or
- 3•2•1 GS speakers
- Rubber feet for speakers

Note: Now is a good time to find the serial numbers on the bottom of the media center and Acoustimass module. Copy these numbers onto your product registration card and in the space provided on page 7.

Selecting locations for your 3•2•1 Series II system components

Use the following guidelines and Figure 2 to choose locations and positions for the components of your 3•2•1 home entertainment system.

♪ **Note:** While these guidelines are offered to help provide great system performance, you may find other placement choices that are more convenient and provide the sound you enjoy.

Placing the media center

⚠ **CAUTION:** Do not block any ventilation openings. For reliable operation of the product and to protect it from overheating, put the product in a position and location that will not interfere with its proper ventilation. For example, do not place the product on a bed, sofa, or similar surface that may block the ventilation openings. Do not put it in a built-in system, such as a bookcase or cabinet that may keep air from flowing through its ventilation openings.

- Place the media center where nothing obstructs opening the disc tray on its front panel.
- Make sure the media center will be placed close enough to the Acoustimass® module and the speakers so that all the cables will reach.
- Make sure the media center will be placed close enough to additional source devices (TV, VCR or cable box) so that all the cables will reach.

♪ **Note:** Make sure that the front of the media center is unobstructed so that it may receive IR (infrared) commands from the remote control.

Figure 2

Sample media center and speaker placement

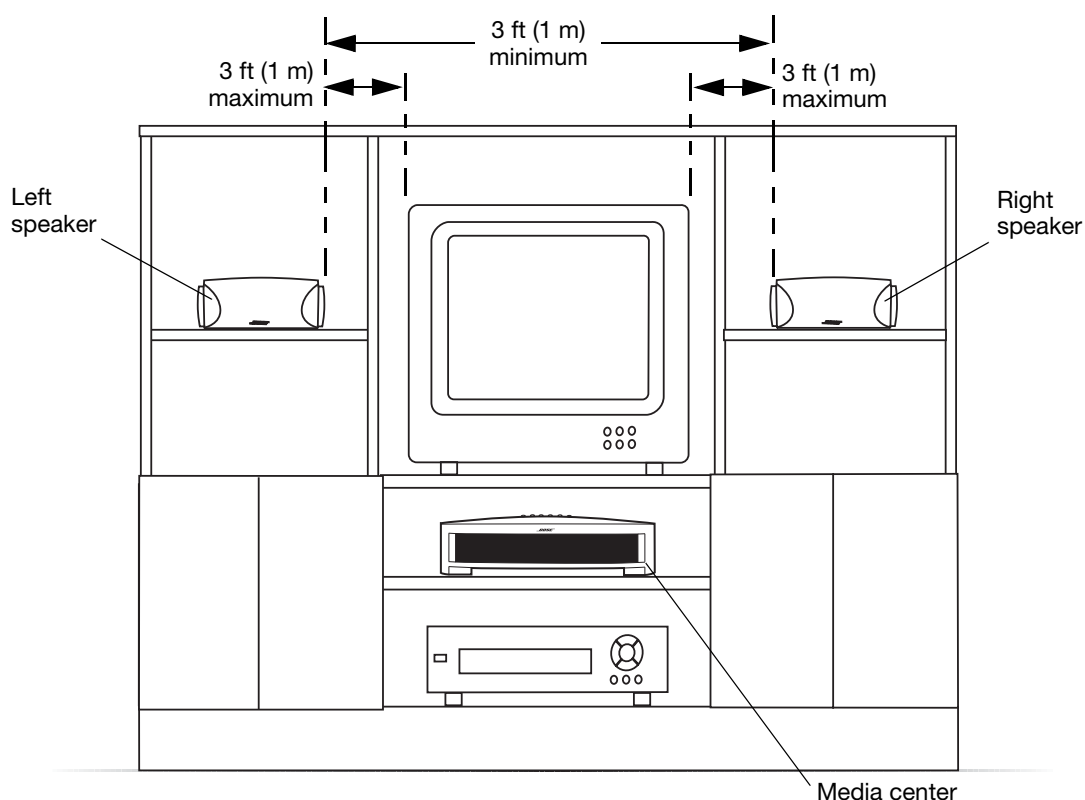

♪ **Note:** The speakers are magnetically shielded to prevent interference with the TV screen.

Placing the speakers

Choosing a good location for the speakers will allow you to experience the audio surround effects that your 3•2•1 home entertainment system is designed to deliver.

- Place the two speakers either on top of the TV or at equal distance from the left and right of the TV screen (Figure 2). Keep both speakers at approximately the same height.
- Place each speaker **within 3 feet (1 meter) of the edge of the TV screen**. Placing the speakers more than 3 feet away from the TV can cause the sound to become separated from the picture.
- If you are using a bookshelf or a home entertainment unit, place each speaker at the **front edge** of its shelf. Positioning the speakers too far back in an enclosed space can change the overall quality of sound and alter the movie sound effects.
- Place the speakers at least **3 feet (1 meter) apart from each other** to optimize the surround sound experience.

⚠ CAUTION: Choose a stable and level surface for both speakers. Vibration can cause the speakers to move, particularly on smooth surfaces like marble, glass, or highly polished wood. If you are placing the speakers on a flat surface, be sure to attach the smaller of the two sets of supplied rubber feet to the bottom surface. You may obtain additional rubber feet (part number 178321) from Bose® Customer Service. To contact Bose, refer to the list of offices included in the product carton.

🎵 Note: The speakers can be mounted on Bose brackets, table stands, or floor stands. For ordering information, refer to “Accessories” on page 54. Additional or longer cables may also be ordered.

Figure 3

Recommended speaker placement

- Place the speakers only on their bottom surfaces, with the Bose logo right-side up.

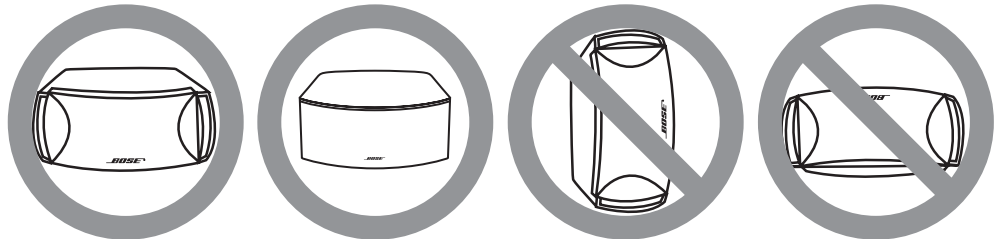

- Aim the speakers straight ahead toward the listening area. Do not place the speakers at an angle. **Angling one or both speakers into or away from the listening area significantly alters system performance.**

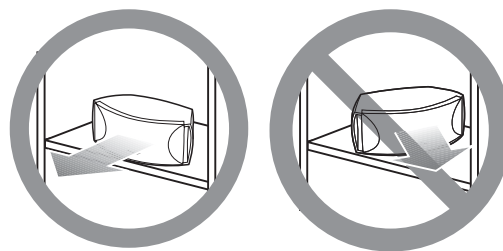

Placing the Acoustimass® module

- Place the Acoustimass® module within reach of the cable from the music center and an AC (mains) power outlet.
- Place the module at the same end of the room as the TV and the speakers (Figure 4).
- Keep the module at least **3 feet (1 meter) away** from the TV to prevent the module from interfering with the TV screen.

Figure 4

Recommended
Acoustimass module
placement

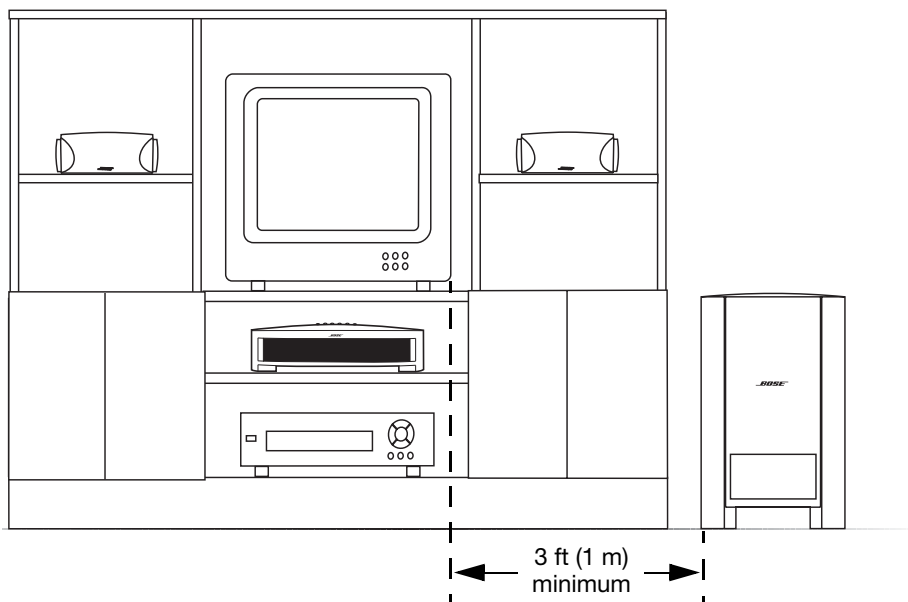

- Attach the medium-sized rubber feet to the bottom of each foot on the module. The rubber feet provide increased stability and protection from scratches.
- Choose a convenient location such as under a table, behind a sofa or chair, or behind drapes, but do not block the port opening.
- Aim the port of the module into the room or along the wall. This prevents a blocked port or over-powering bass.
- Stand the Acoustimass module on its feet. Do not lay it on its side or stand it on either end (Figure 5).

Figure 5

Recommended orientation
of the module

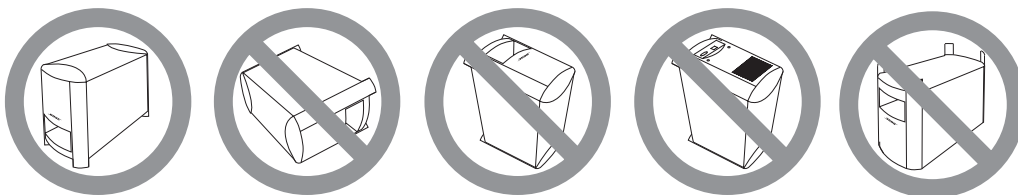

CAUTION: Do not block the openings on the back of the module, which provide ventilation for the built-in circuitry.

CAUTION: The Acoustimass module generates a magnetic field. Although this is not an immediate risk to your video tapes, audio tapes, and other magnetic media, you should not store any of these items directly on or near the module.

Making system connections

CAUTION: Do not plug the Acoustimass® module into an AC power (mains) outlet until all the components are connected.

Note: If additional audio cables or longer cables are needed to make these connections, contact Bose Customer Service. Refer to the list of offices included in the product carton.

Connecting the Acoustimass module to the media center

Plug one end of the Acoustimass module cable into the **Acoustimass Module** jack on the rear of the media center (Figure 6). Plug the other end of the cable into the input (⊖) jack on the rear of the Acoustimass module.

Note: The jacks for the Acoustimass module cable are keyed so that the cable connectors only plug in one way. Make sure that the arrow on the connector body faces up when plugging in the cable.

Figure 6

Acoustimass module-to-media center connection

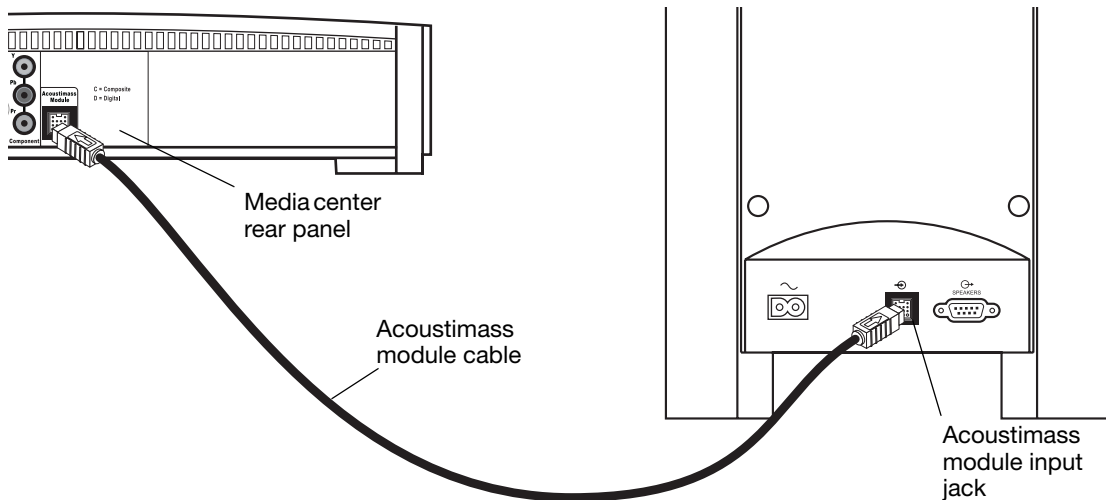

Connecting the speakers to the Acoustimass module

1. Insert the single-plug end of the speaker cable into the **SPEAKERS** jack on the rear panel of the Acoustimass module (Figure 7). Tighten both screws on the plug.

Figure 7

Speaker cable-to-Acoustimass module connection

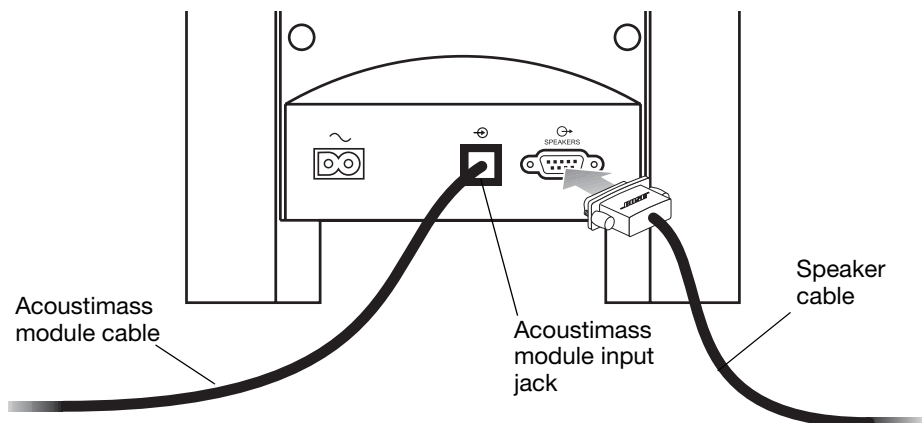

2. At the other end of the speaker cable, separate the left and right speaker cords as much as necessary to reach each speaker (Figure 8).

Figure 8

Separating left and right speaker cords

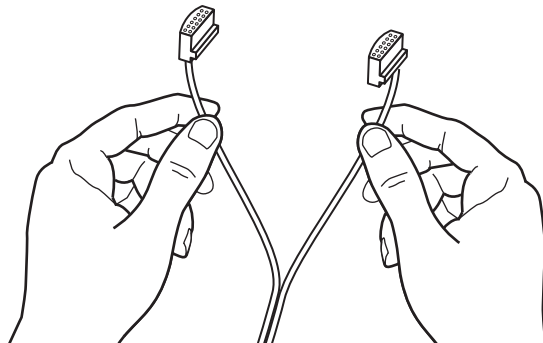

Note: If you purchased a 3•2•1 GS Series II system, the left and right speaker cable connectors will be marked with a "GS".

3. Plug the **LEFT** speaker cable into the rear jack of the left speaker (Figure 9). Plug the **RIGHT** speaker cable into the rear jack on the right speaker.

Figure 9

Left and right speaker connections

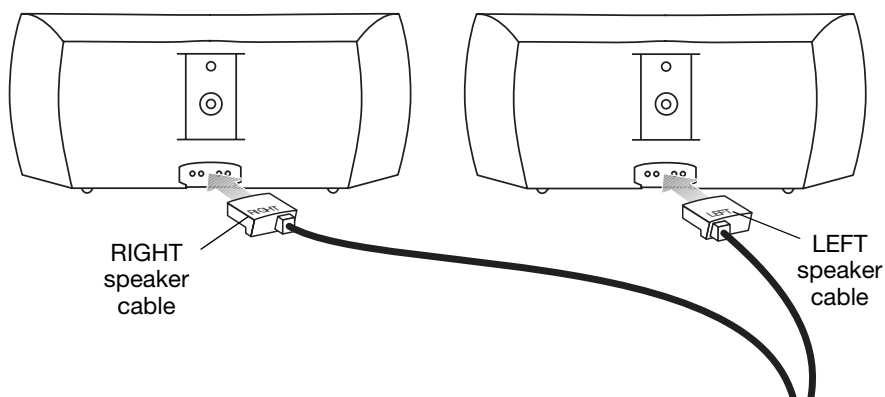

🎵 **Note:** Make sure cable connectors are fully inserted and seated firmly in the speaker jacks.

Connecting the supplied antennas

The rear panel of the media center provides jacks for the AM and FM antennas included with your system (Figure 10). Unwind the wires for each antenna to provide the best reception.

Figure 10

Antenna connections

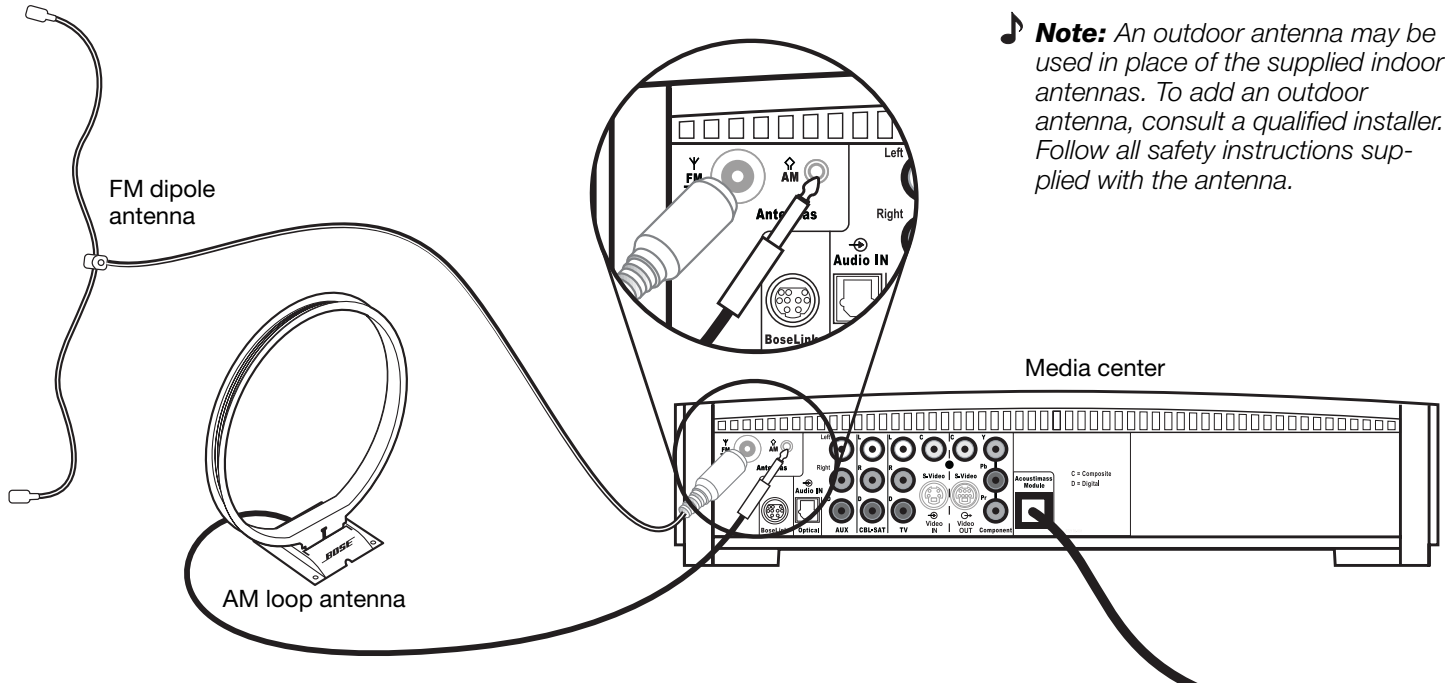

FM antenna

Plug the FM antenna into the **FM** jack on the media center rear panel. Spread out the antenna arms and move them around to establish optimum FM reception. Extend the antenna as far from the media center and other equipment as possible.

AM antenna

Plug the AM loop antenna into the **AM** jack on the media center rear panel. Place the antenna loop at least 20 inches (50 centimeters) away from the media center and at least 4 feet (1.2 meters) away from the Acoustimass® module. Experiment with positioning the loop for optimum AM reception. Follow the instructions enclosed with the AM loop antenna to stand it on the supplied base, or mount it to a wall.

Connecting cable FM radio

Some cable TV providers make FM radio signals available through the cable service to your home. This connection is made to the external FM jack on the back panel of the media center. To connect to this service, contact your cable TV provider for assistance.

🎵 **Note:** Make sure that the cable radio installation includes a TV/FM splitter so that only the FM radio band, not the cable TV band, is received by the media center. If necessary, contact your cable company.

Connecting your TV to the media center

Note: If you will be using the 3•2•1 system with both a TV and a VCR, skip this section and go to “Connecting your TV and VCR to the media center” on page 16.

Making audio connections

Note: If your TV does not have audio output jacks, see “If your TV does not have audio output jacks” on page 17. Otherwise, continue.

1. Connect one end of the supplied stereo cable to the **TV Audio IN** jacks on the rear panel of the media center (Figure 11). Insert the white RCA plug into the **TV white L** jack. Insert the red RCA plug into the **TV red R** jack.
2. Connect the other end of the stereo cable to the audio output jacks on your TV. Insert the white RCA plug into the white **AUDIO OUT L** jack. Insert the red RCA plug into the red **AUDIO OUT R** jack.

Making composite video connections

Note: Some older TVs with standard TV cable connectors do not have a composite video or an S-video input. Such TVs are not compatible with any DVD players and require use of an RF modulator for this connection. RF modulators are available at your local electronics store.

1. Insert one end of the supplied video cable (yellow) to the **Video OUT C** (composite) jack on the back of the media center (Figure 11).
2. Insert the other end of the video cable into one of the video input jacks on your TV.

Figure 11

TV (composite video)-to-media center connections

Write the name of the video input jack used on your TV in the box on page 25. After you turn on the system, you will need to select this video input on your TV in order to view the 3•2•1 system video output.

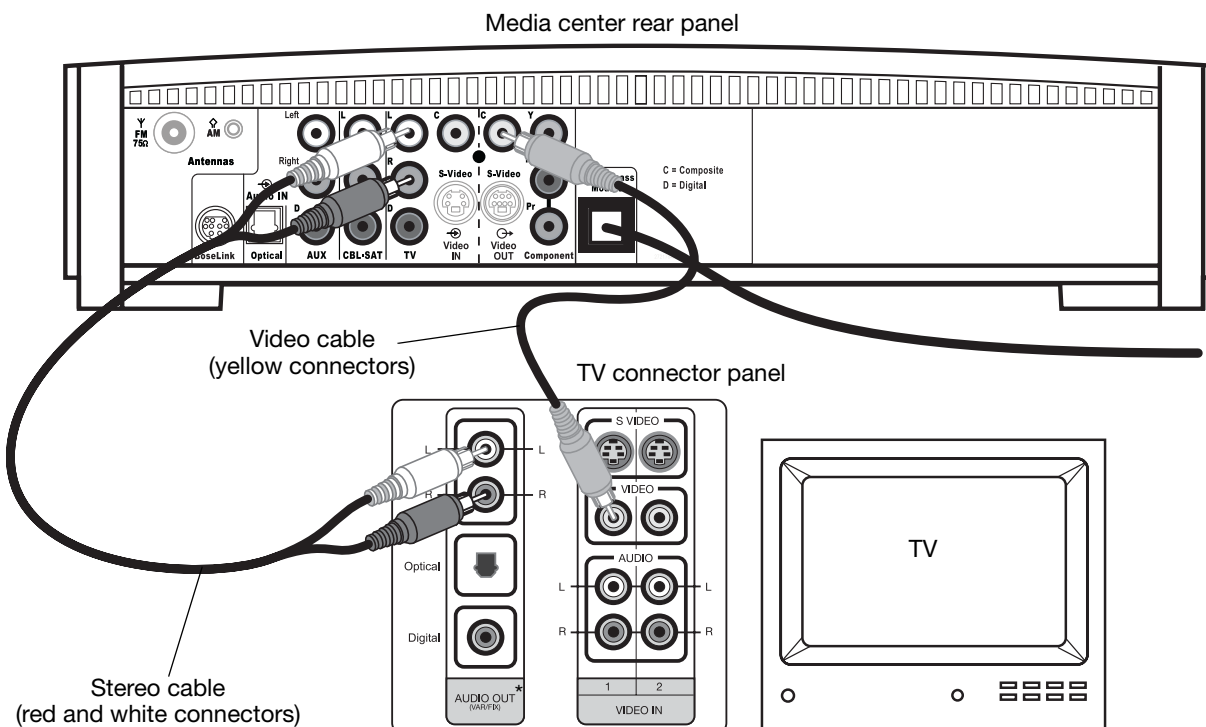

*Could be labelled “FIXED”, “MONITOR”, or “HiFi”.

Connecting your TV and VCR to the media center

Note: There are two options for connecting your TV and VCR to the media center. Before you proceed, you must determine if your TV has audio output jacks. Consult your TV owner's guide if you need assistance.

If your TV has audio output jacks

If your TV has audio output jacks, you can directly route the TV audio to the 3•2•1 home entertainment system (Figure 12).

1. Connect one end of the supplied stereo cable to the **TV Audio IN** jacks on the rear panel of the media center. Insert the white RCA plug into the **TV white L** jack. Insert the red RCA plug into the **TV red R** jack.
2. Connect the other end of the stereo cable to the audio output jacks on your TV. Insert the white RCA plug into the white **AUDIO OUT L** jack. Insert the red RCA plug into the red **AUDIO OUT R** jack.
3. Insert one end of the supplied video cable (yellow) to the **Video OUT C** (composite) jack on the back of the media center. Insert the other end of the video cable into one of the video input jacks on your TV.

Figure 12

TV and VCR connections with media center

Write the name of the video input jack used on your TV in the box on page 25. After you turn on the system, you will need to select this video input on your TV in order to view the 3•2•1 system video output.

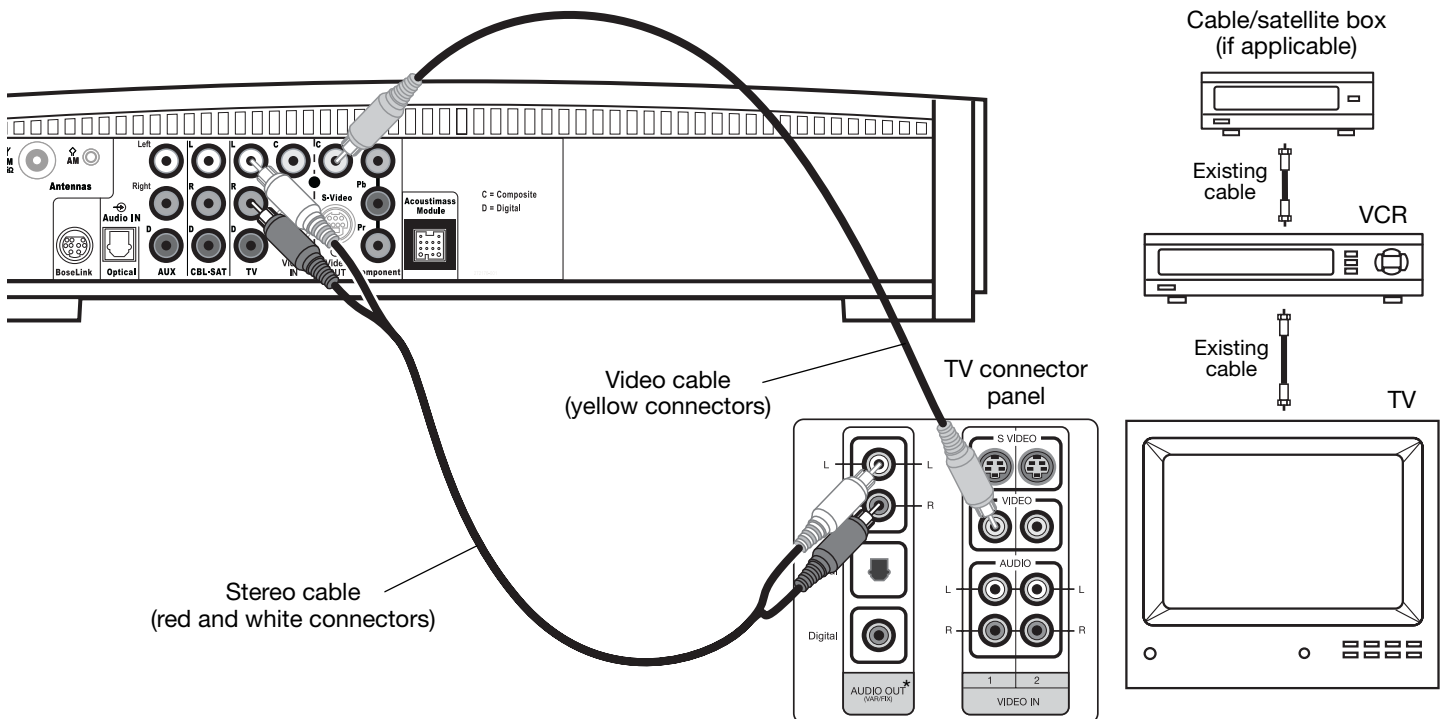

*Could be labelled "FIXED", "MONITOR", or "HiFi".

If your TV does not have audio output jacks

If your TV does not have audio output jacks, you will need to feed audio to the 3•2•1 home entertainment system through a secondary source, such as a VCR. To do this, you will need one additional video cable, which can be purchased at your local electronics store.

1. Connect one end of the supplied stereo cable to the **AUX Audio IN** jacks on the rear panel of the media center (Figure 13). Insert the white RCA plug into the **AUX white L** jack. Insert the red RCA plug into the **AUX red R** jack.
2. Connect the other end of the stereo cable to the **AUDIO OUT** jacks on your VCR. Insert the white RCA plug into the white **AUDIO OUT L** jack. Insert the red RCA plug into the red **AUDIO OUT R** jack.
3. Insert one end of the supplied video cable (yellow) into the **VIDEO OUT** jack on the back of your VCR. Insert the other end of the supplied video cable into the **Video IN C** (composite) jack on the back of the media center.
4. Insert one end of the second video cable (yellow) into the **Video OUT C** (composite) jack on the back of the media center. Insert the other end of the second video cable into one of the video input jacks on your TV.

Figure 13

System setup when TV has no audio output jacks

Write the name of the video input jack used on your TV in the box on page 25. After you turn on the system, you will need to select this video input on your TV in order to view the 3•2•1 system video output.

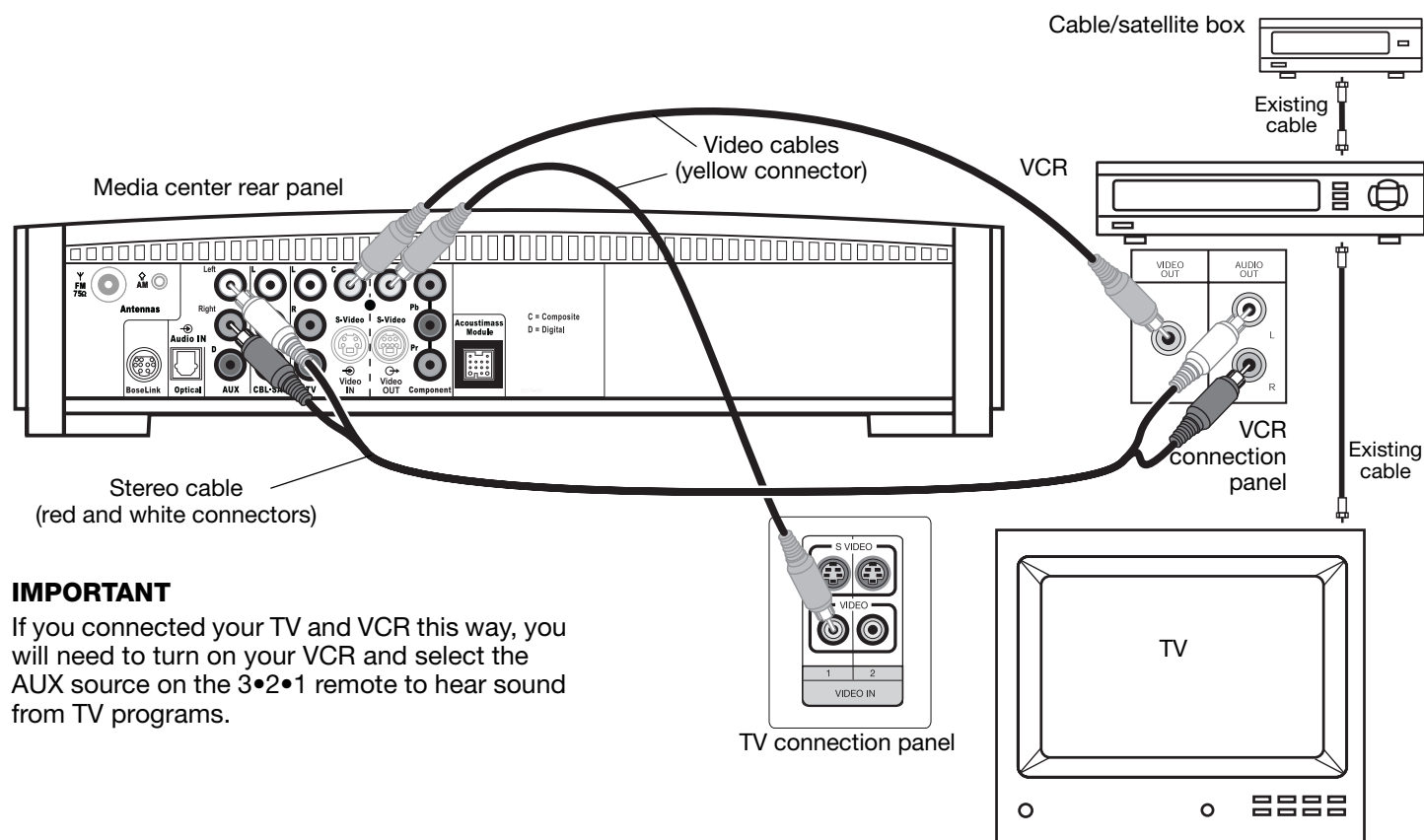

IMPORTANT

If you connected your TV and VCR this way, you will need to turn on your VCR and select the AUX source on the 3•2•1 remote to hear sound from TV programs.

VCR considerations

- Some combination TV/VCR units may not work with 3•2•1 Series II home entertainment systems. Please refer to your TV/VCR owner’s manual for information.
- A stereo VCR is required for optimal sound performance. If your VCR has only one audio output and is not labeled **Stereo** or **Hi-fi**, you have a mono VCR. You will need a Y-adaptor cable (available at electronics stores) to connect audio to the media center. For this setup, you will need to select “Mono decoding” (see “TV, CBL•SAT, and AUX settings menu” on page 44) so your 3•2•1 system will simulate surround sound effects from a mono source. Otherwise, you will hear mono sound from both speakers.

Advanced setup options

Making S-video connections (higher quality video)

An S-video input jack, provided on many TVs, delivers a higher quality TV picture than the composite video output connection shown in Figure 11. For this connection you will need an S-video cable which can be purchased from your Bose dealer or a local electronics retailer.

- Insert one end of the S-video cable into the **S-Video OUT** jack on the media center (Figure 14).
- Insert the other end of the S-video cable into the **S-VIDEO IN** jack on your TV.

Figure 14

TV (S-video)-to-media center connections

IMPORTANT
If you use S-video to connect your TV to the media center, you must also use S-video to connect all other devices (such as a cable box and VCR) to the media center.

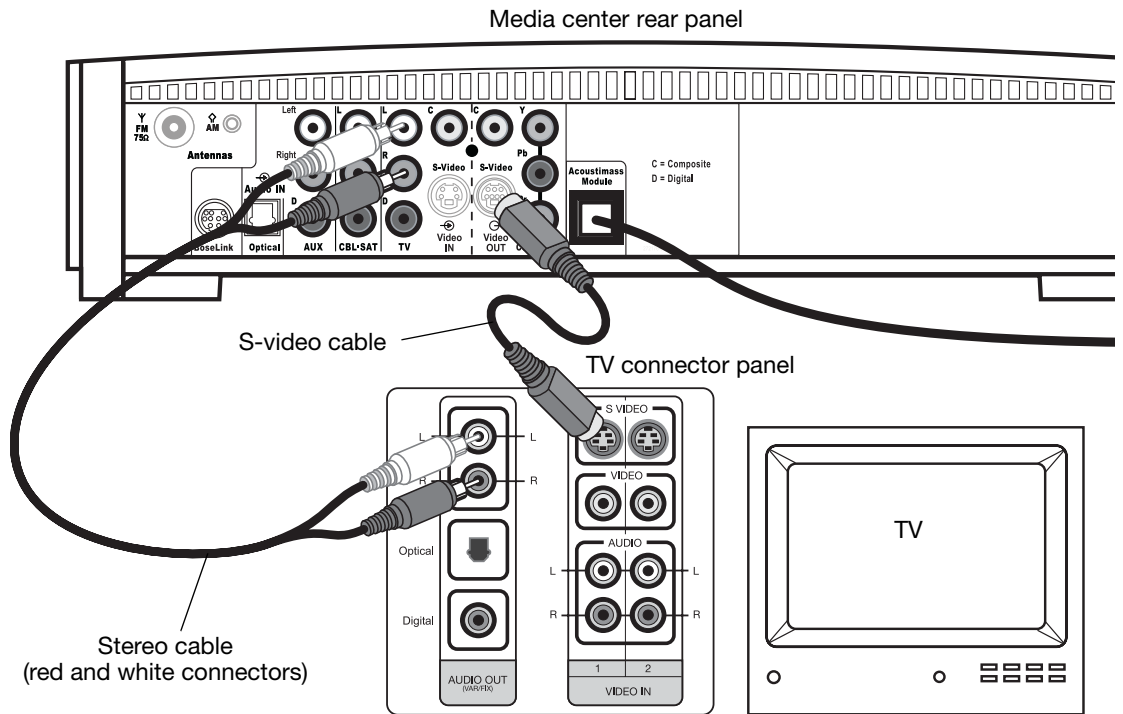

Making component video connections (highest quality video)

Note: Component video connections are required in order to use the progressive scan feature of your 3•2•1 system. Your TV must also support this feature. To turn on the progressive scan feature, see “Video options” on page 48.

For the highest quality video from DVDs, you may want to use a component video connection between the media center and the TV. To do so, your TV must provide component video jacks (typically labelled Y, Pb, and Pr). Refer to your TV owner’s guide for more information.

To make component video connections you will need three video grade cables that are long enough to reach from the rear of the media center to your TV (Figure 15). If the cables are not supplied with your TV, you can purchase them separately.

1. On the media center rear panel, plug one video cable into the **Component Y, Pb, and Pr** video output jacks (Figure 15).
2. Plug the other end of each video cable into the corresponding (color or letter code) component video jack on the back of your TV.

Figure 15

TV (component video)-to-media center connections

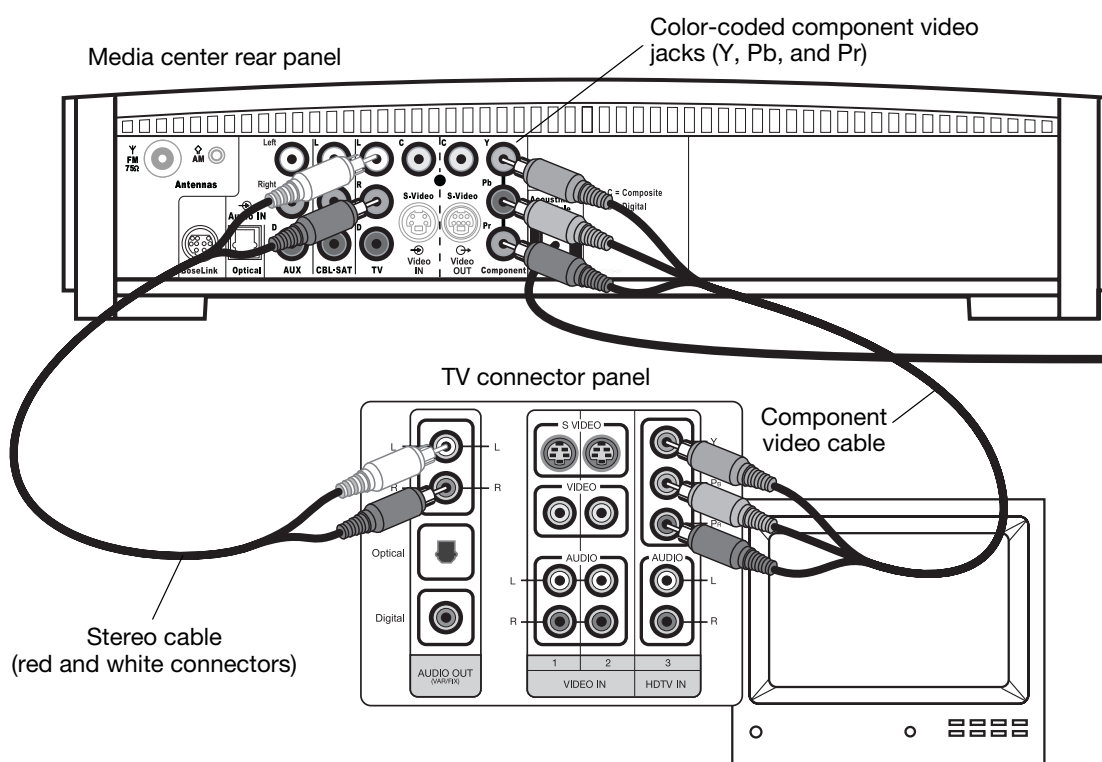

IMPORTANT FOR COMPONENT VIDEO USERS

Input signals received by the **C** (Composite) or **S-Video IN** jacks are not passed through to the **Component video OUT** jacks. If you connect an external video device to the **C** or **S-Video IN** jack, you must also connect the **C** or **S-Video OUT** jack on the media center to the respective video input jack on your TV. To view the external video input on your TV, you will need to select the TV video input used for that device. To view the onscreen menus of the 3•2•1 system, you will need to switch back to the TV’s component video input.

Note: For more information, or to purchase the video cables, contact your local electronics store or authorized Bose dealer.

Connecting digital audio devices

Some audio devices may feature a digital audio output for optimum sound performance. Use an optical digital cable or a coaxial digital cable, as appropriate, to connect this output to the digital input on the media center. You can purchase the required cables at a local electronics store.

On the media center rear panel, an optical digital cable connects to the OPTICAL jack. A coaxial cable connects to the audio input jacks labeled **D**.

🎵 **Note:** Before you can benefit from the optical connection, you will need to assign the optical connector to the audio source in the system settings menu. See “Media center options” on page 49.

Figure 16

Media center digital audio input jacks

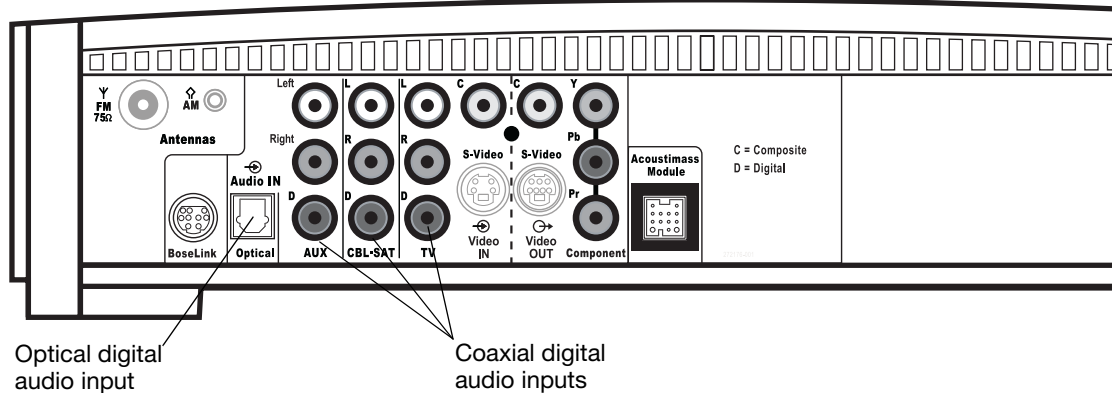

Connecting your cable/satellite box, TV, and VCR to the media center

The 3•2•1 home entertainment system provides flexibility for you to add up to three external audio devices, including your TV, directly to the media center.

Figure 17 shows you an advanced setup using a TV, VCR and cable/satellite box. In this setup, please notice the following:

- S-video connections are used to deliver the cable/satellite signal to the media center. Therefore, the media center output video is sent to the TV also through an S-video connection.
- Analog and digital coax audio connections are shown for the cable/satellite box. As an option, you may use an optical digital connection. However, before you can benefit from the optical connection, you will need to assign the optical connector to the cable/satellite box audio source in the system settings menu. See “Media center options” on page 49.
- When connecting an audio device to the media center jacks, remember to match the red jack to the right channel (R) and the white (or black) jack to the left channel (L).
- For further details on making the video connections between your VCR and TV, refer to the manuals for these video devices.

🎵 **Note:** The recommendations contained in this owner’s guide are basic suggestions for connecting external devices to the 3•2•1 Series II system. Instructions and terminology pertinent to these external devices may vary, depending on the manufacturer. Consult the owner’s guide that came with the device for clarification on setup and usage before making any connections.

Figure 17

Advanced setup: TV, VCR and cable/satellite box

Media center

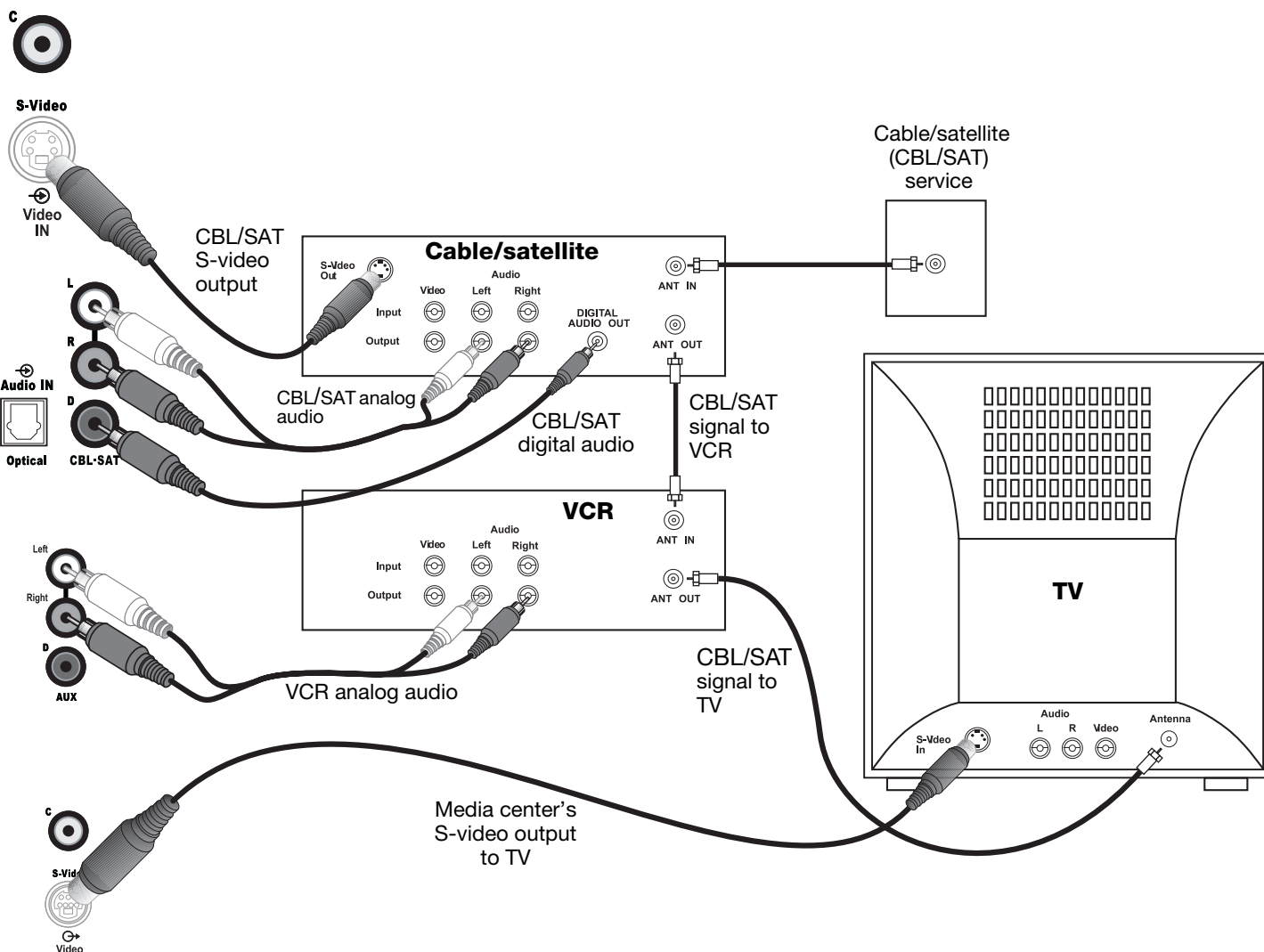
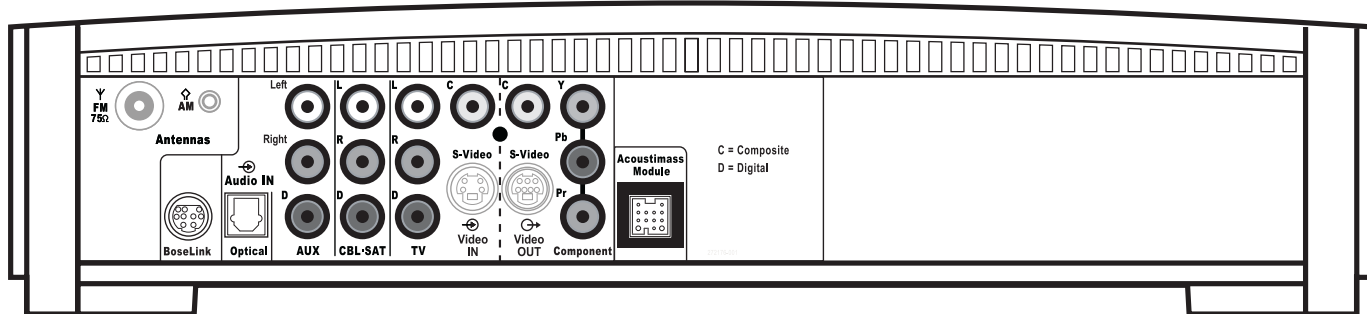

Note: For more information on advanced connections, refer to the DVD setup disc that came with your 3•2•1 Series II home entertainment system.

Connecting a game console

Connect the audio output of a game console to the **AUX Left** and **Right** input jacks. Connect the video output of the game console to the **C (composite) Video IN** jack.

Figure 18

Game console connections

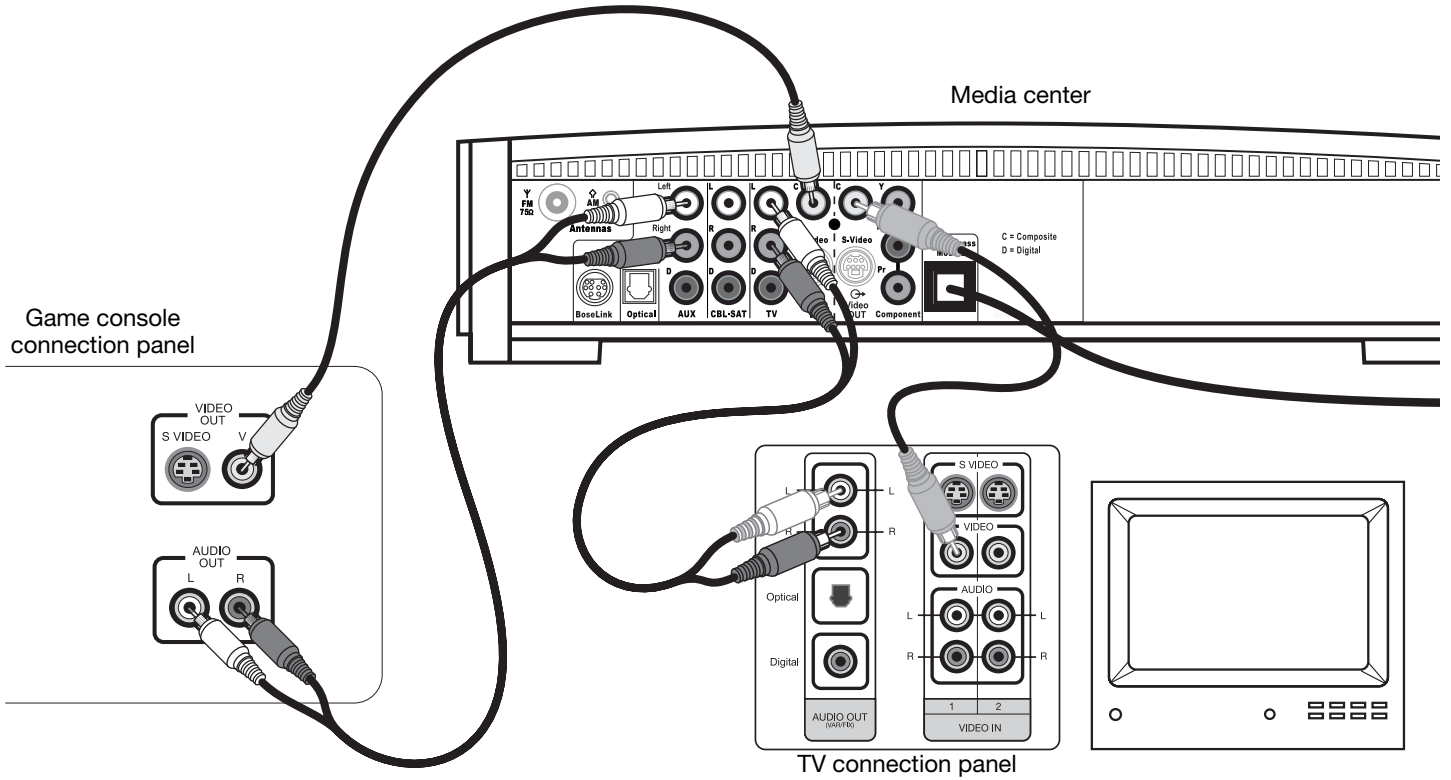

IMPORTANT

If you connected your game console this way, you will need to select the AUX source on the 3•2•1 remote in order to hear sound from the game console.

Installing the remote control batteries

1. On the back of the remote, slide open the battery compartment (Figure 19).
 2. Insert the two supplied AA (IEC-R6) 1.5V batteries, or their equivalent, as shown. Match the plus (+) and minus (-) marked on the batteries with the plus (+) and minus (-) inside the battery compartment.
 3. Slide the battery compartment cover back into place.
- Note:** *Replace the batteries when the remote control stops operating or its range seems reduced.*

Figure 19

Installing the batteries

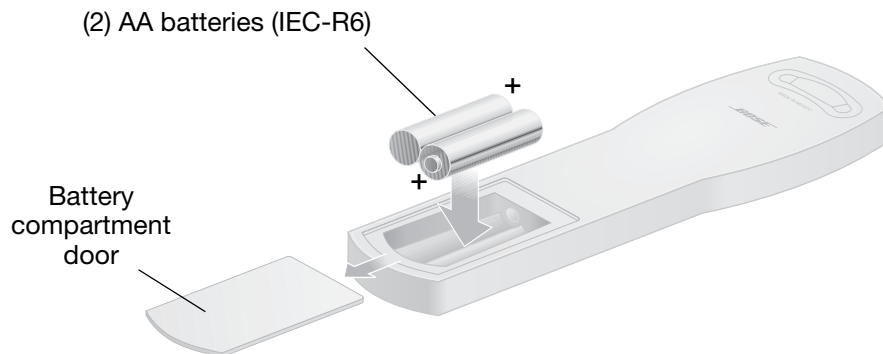

Connecting the power cord

⚠ CAUTION: For dual voltage models only, be sure to set the dual voltage switch on the back of the Acoustimass® module to the appropriate voltage for your area (115V or 230V) before connecting to power. If you are not sure about the proper voltage for your area, consult your local electrical authorities.

1. Insert the small connector end of the power cord into the AC INPUT connector on the Acoustimass module (Figure 20).
2. Insert the large end of the cord into an AC power (mains) outlet.

🎵 Note: On 220-240V models only, turn the Acoustimass module POWER switch to on (I).

Figure 20

Connecting to power

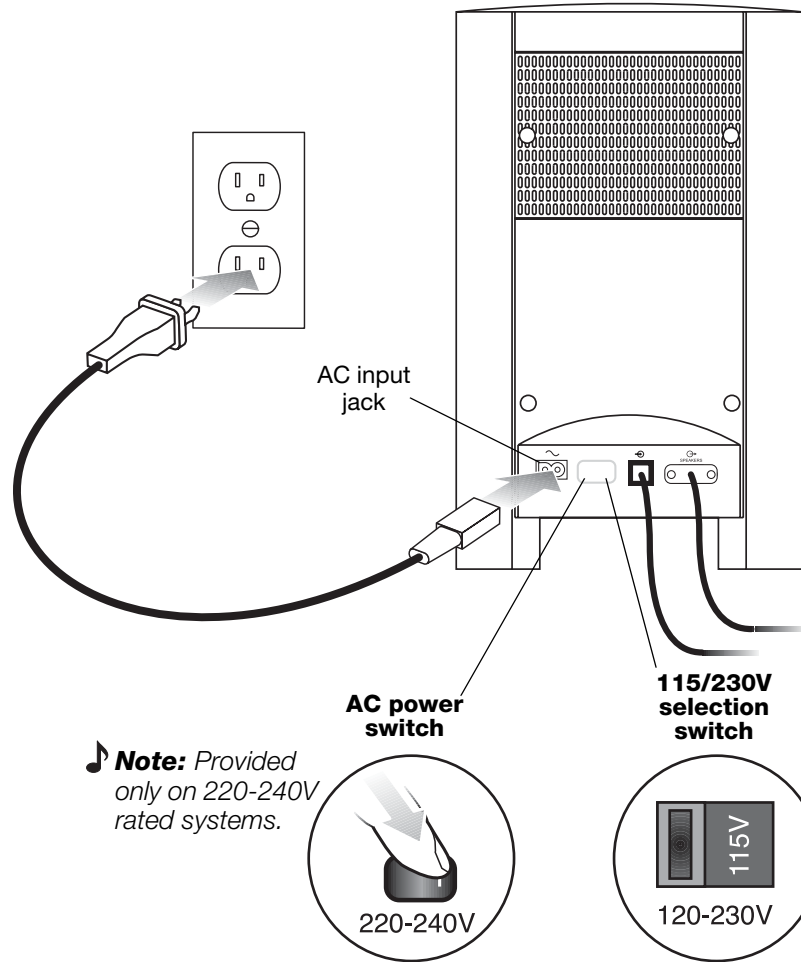

🎵 Note: Bose recommends using a safety agency-approved surge protector on all electronic equipment. Voltage variations and spikes can damage electronic components in any system. A quality suppressor can eliminate the vast majority of failures attributed to surges and may be purchased at electronics stores.

Checking your system setup

Follow these steps when turning on your system for the first time. Be sure to perform step 4 and play the setup DVD. The setup DVD can help you verify that you set up your system correctly for proper sound performance.

1. Check the following before you continue:

- All cables are connected for the setup you chose.
- The batteries were installed in the remote control.
- The power cord was installed and plugged into a live AC receptacle.

2. Turn on your TV.

Use the remote control that came with your TV.

3. Using your TV remote, select the video input on your TV that connects to the video output of the media center.

Name TV video input used:

- The method of selecting the right video input depends on your TV. Refer to your TV owner's guide for help.

4. Play the 3•2•1 setup DVD.

- A. Turn on your 3•2•1 system. Point the 3•2•1 remote control at the media center and press **On-Off**.
- B. Press **Eject** on the media center control panel.
- C. Insert the DVD setup disc into the disc tray.
- D. Press **Eject** again to close the tray. The DVD will automatically begin to play. If it does not, press the play button (.

5. Turn off the TV speakers.









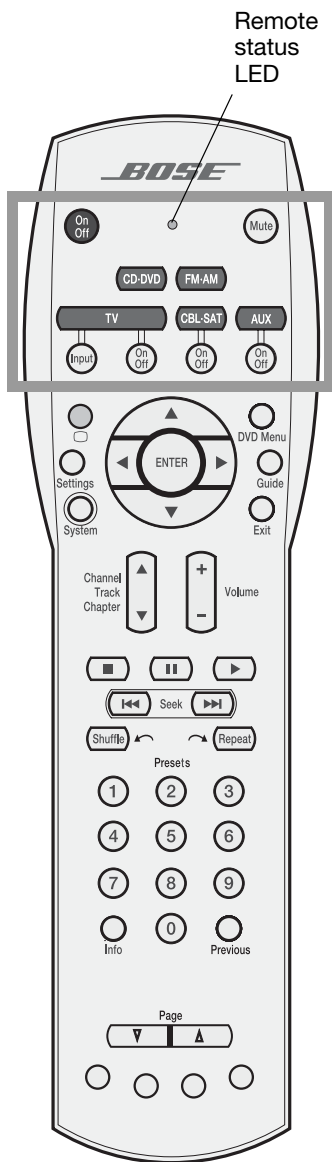

- Refer to your TV owner's guide for help.
- If your TV does not have an option to turn off the internal speakers, you may need to adjust both the 3•2•1 system volume and your TV volume until you find a level that produces the desired sound.
- In some TVs, when the internal speakers are turned off, you may need to raise the TV's volume level by 75% to 100% in order to hear audio from the 3•2•1 home entertainment system. See your TV owner's guide for help.

 **Note:** Be sure to play the setup DVD, included in the carton with your system, as soon as all the connections are completed. This will help you verify the connections you have made and confirm proper sound performance.

SYSTEM CONTROLS AND INDICATORS

Remote control







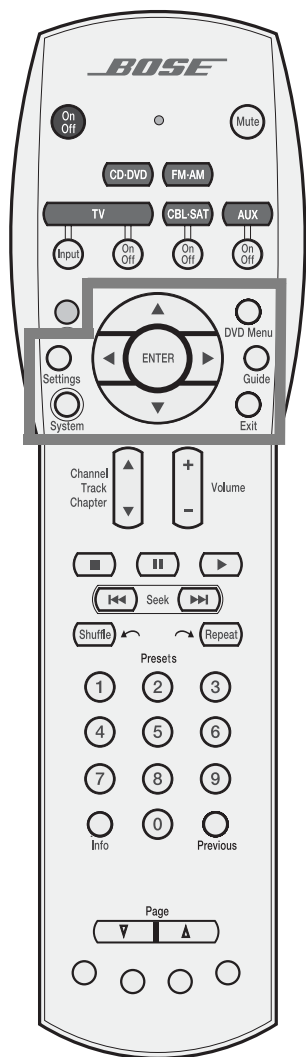

- 
 - Turns the system on or off.
- 
 - Status LED:
 - Remains off (unlit) during normal operation.
 - Remains on during setup mode. Turns off briefly with each key press.
 - Blinks rapidly eight times if the wrong key is pressed during setup or if an unavailable device code is entered.
 - After ten seconds of no key presses, blinks rapidly eight times and the remote exits the setup mode.
- 
 - Silences or restores the sound from the current source.
- 
 - Selects the built-in CD/DVD player and turns the system on.
- 
 - Selects the built-in tuner and turns the system on to the previously selected FM/AM station.
 - Switches between FM and AM when the tuner is selected.
- 
 - **TV:** Turns your system on and selects the TV input as the sound source.
 - 
 - **Input:** Changes the external input to your TV. For example, your TV might have two external inputs where one is connected to your cable box and the other to your VCR. Pressing this button alternates between the cable box and the VCR.*
 - **On/Off:** Turns your TV on and off.*
- 
 - **CBL-SAT:** Turns your system on and selects the CBL-SAT input as the sound source.
 - 
 - **On/Off:** Turns your cable/satellite box on or off.*
- 
 - **AUX:** Turns your system on and selects the AUX input as the sound source.
 - 
 - **On/Off:** Turns a VCR or DVR that is connected to the AUX jack on or off.*

* Requires special remote settings. See "Setting up your remote to control other audio/video devices" on page 30.

Remote control – cont.

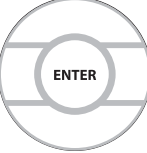
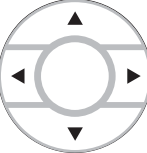

- 
 - Puts the Settings menu for the current source on your TV screen or media center display.
- 
 - Puts the System menu on your TV screen.
- 
 - Puts the DVD menu of the currently loaded DVD disc on your TV screen.
 - Puts the main menu of a cable/satellite box, VCR, or DVR on your TV screen (if supported).*
- 
 - Puts the TV, cable, satellite, or DVR program guide (if supported) on your TV screen.
- 
 - Removes the Settings and System menus from your TV screen.
 - Removes on-screen menus for TV, cable/satellite box, or VCR/DVR from your TV screen.*
- 
 - Tunes the FM or AM radio to the next higher or lower frequency.
 - Selects the next item, up or down, in menus.
- 
 - Confirms a menu selection or introduces the next level of menu options.
- 
 - Moves up, down, left, or right in onscreen menus and media center displays.

* Requires special remote settings. See "Setting up your remote to control other audio/video devices" on page 30.

Remote control – cont.

SYSTEM CONTROLS AND INDICATORS

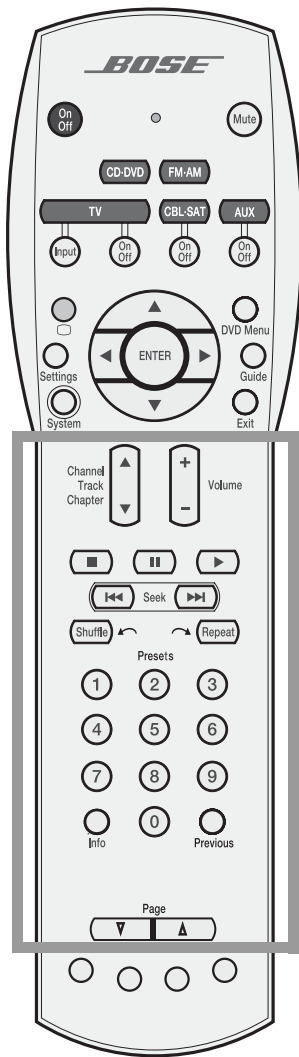

- Raises or lowers the volume of the current source.
- Pressing + restores muted sound from the current source.
- Pressing – lowers the volume of the current source, but does not restore muted sound.



- Skips to the next or previous TV channel,* CD track, or DVD chapter.



- Stops the disc player.
- For DVDs only, the disc stops and the system saves the DVD play position. Pressing [Play/Pause] continues the DVD from the saved play position. Pressing [Stop] twice for a disc in play returns to the beginning of the disc.



- Pauses a currently playing disc.
- Pressing [Play/Pause] again (or pressing [Play/Pause]) resumes play of a paused disc.
- After 20 minutes of no user interaction, the disc player stops and returns to the beginning of the disc to wait for the next command.



- Starts the disc player.



- Skips backward or forward through CD tracks.
- Skips backward or forward through DVD chapters.
- Seeks backward or forward to the next strongest radio station.



- Plays audio CD tracks in random order. Press again to cancel this mode.
- Starts instant replay (↶) for DVR (if supported).



- Repeats a CD, CD track, DVD chapter, or DVD title. Press again to change the repeat mode.
- Initiates Quick Skip and/or Return to Live (↶) for DVR (if supported).

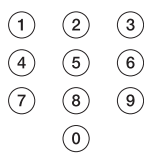

- Provides a means for selecting a CD track, DVD chapter, radio station preset, or TV channel.
- Allows you to change numerical values for some menu options.



- Displays or exits the TV, cable, satellite box, or VCR/DVR information on your TV screen.*
- During MP3 play, removes or restores track information on the media center display.



- Skips to the previous TV channel (if supported by your TV).

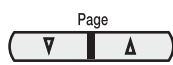

- Skips ahead (Page up) or back (Page down) one page in the Electronic Program Guide (if supported).

* Requires special remote settings. See "Setting up your remote to control other audio/video devices" on page 30.

Remote control – cont.

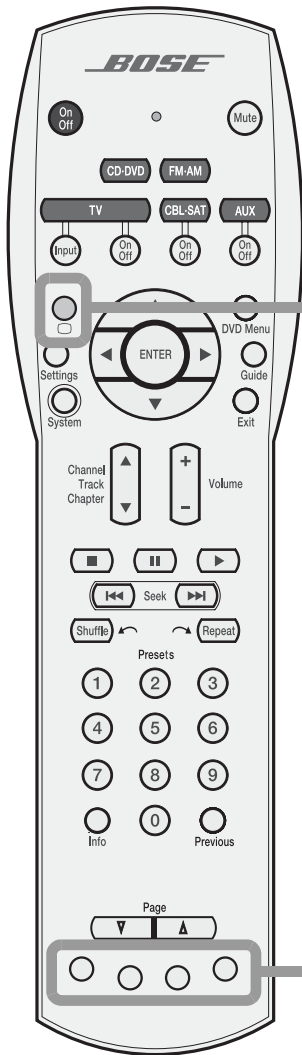

Aspect ratio or Teletext On/Off control

You will see one of two symbols below this button on your remote control. The symbol defines the function.

Symbol	Function
	When a video source is selected, changes the video aspect ratio between Normal (4:3) and Widescreen (16:9).
	For Europe, only When the TV source is selected, turns the Teletext mode on or off.

Recording/Cable or Teletext controls

These four buttons will be marked in one of two ways on your remote. The markings define how the buttons are used.

Button markings	Functions
Red (Record) A B C	<ul style="list-style-type: none"> When a VCR, DVR or other video recording device is selected, the Red button activates the record function.* When a cable source is selected, A, B, and C are used for cable-related functions.*
Red Green Yellow Blue	<p>For Europe, only In the Teletext mode, the colored buttons are used for Teletext-related functions.</p>

*Requires special remote settings. See "Setting up your remote to control other audio/video devices" on page 30.

Setting up your remote to control other audio/video devices

Your remote can be set up to control other audio devices such as a TV, VCR, DVR or cable/satellite box by entering a device code while in the setup mode.

- **If you know the device code, follow the instructions under the heading, “Direct entry of a device code”** below. Device codes are listed in the back section of this owner’s guide and in the System menus under Remote Control options.
- **If you can’t find the device code and want to search the system for it, see “Searching for a device code”** on page 31.
- **If you want to verify the device code you have entered for an audio device, see “Verifying an entered device code”** on page 33.
- **If you want to return to a previous device assignment, press and hold the TV button** until the remote LED is lit (about 5 seconds). On the remote keypad, enter 977.
- **If you want to wipe out all assigned codes, press and hold the TV button** until the remote LED is lit (about 5 seconds). On the remote keypad, enter 981.

♪ **Note:** More than one code may work with your particular brand of product. If you notice a lack of response or limited functionality after setting up the remote, try a different code.

♪ **Note:** The remote status LED flashes rapidly eight times if you press an invalid key, or enter an unavailable device code. Wait seven seconds for the error to clear and start again.

Direct entry of a device code

Device codes can be found at the back of this owner’s guide or in the System menu under Remote Control options. If you know the device code, you can do the following:

To set up the remote to control your TV

1. Turn on both the 3•2•1 system and your TV.
2. Press and hold the **TV** button until the remote LED is lit (about five seconds).
3. On the remote keypad, enter the four-digit device code for your TV. The LED will turn off temporarily as you press each key.
4. Check that the LED turns off after the code is entered. If the LED blinks, the code is invalid. Try again.
5. Point the remote at your TV and press the **TV On-Off** button. If your TV does not respond, go back to step 2 and try other codes. If you are still unsuccessful, see “Searching for a device code” on page 31.

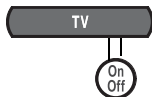

♪ **Note:** After programming your remote to control external audio/video devices from the System menu, press the System button once to continue navigating the System menu.

To set up the remote to control your cable/satellite box

1. Turn on both the 3•2•1 system and your cable/satellite box.
2. Press and hold the **CBL•SAT** button until the remote LED is lit (about five seconds).
3. On the remote keypad, enter the four-digit device code for your cable/satellite box. The LED will turn off temporarily as you press each key.
4. Check that the LED turns off after the code is entered. If the LED blinks, the code is invalid. Try again.
5. Point the remote at your cable/satellite box and press the **CBL•SAT On-Off** button. If your cable/satellite box does not respond, go back to step 2 and try other codes. If you are still unsuccessful, see “Searching for a device code” on page 31.

**To set up the remote to control your VCR or DVR (such as Tivo or Replay TV brands)**

1. Turn on both the 3•2•1 system and your VCR or DVR.
2. Press and hold the **AUX** button until the remote LED is lit (about five seconds).
3. On the remote keypad, enter the four-digit device code for your VCR/DVR. The LED will turn off temporarily as you press each key.
4. Check that the LED turns off after the code is entered. If the LED blinks, the code is invalid. Try again.
5. Point the remote at your VCR or DVR and press the **AUX On-Off** button. If your VCR or DVR does not respond, go back to step 2 and try other codes. If you are still unsuccessful, see “Searching for a device code” on page 31.

**Searching for a device code**

Use this method if you do not know the device code for a device.

Note: *This is a very time-consuming process. Use it as a last resort.*

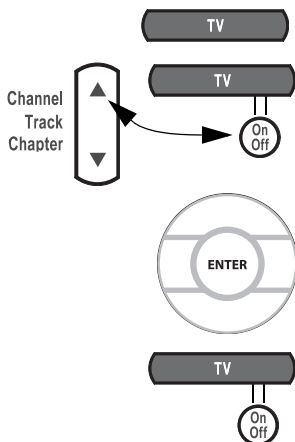
To set up the remote to control your TV

1. Turn on both the 3•2•1 system and your TV.
2. Press and hold **TV** until the remote LED is lit (about five seconds).
3. Alternately press **Channel ▲** and **TV On-Off** until your TV turns off.
4. Press **Enter**. Check that the remote LED turns off.
5. Point the remote at your TV and press **TV On-Off**. If your TV does not respond, go back to step 2 and try again.

To set up the remote to control your cable/satellite box

1. Turn on both the 3•2•1 system and your cable/satellite box.
2. Press and hold **CBL•SAT** until the remote LED is lit (about five seconds).
3. Alternately press **Channel ▲** and **CBL•SAT On-Off** until your cable/satellite box turns off.

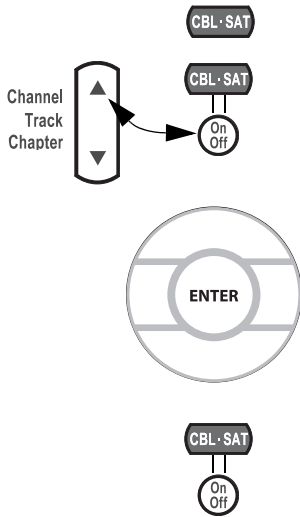

4. Press **Enter**. Check that the remote LED turns off.

5. Point the remote at your cable/satellite box and press **CBL•SAT On-Off**. If your cable/satellite box does not respond, go back to step 2 and try again.

To set up the remote to control your VCR or DVR (for example, TiVo or Replay TV)

1. Turn on both the 3•2•1 system and your VCR/DVR.
2. Press and hold **AUX** until the remote LED is lit (about five seconds).
3. Alternately press **Channel ▲** and **AUX On-Off** until your VCR/DVR turns off.

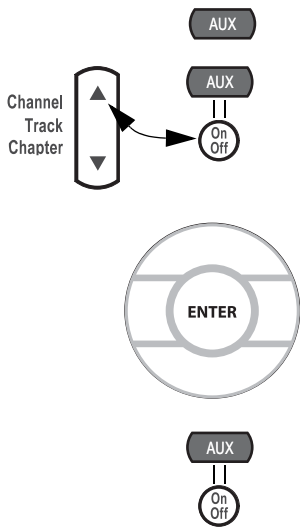

4. Press **Enter**. Check that the remote LED turns off.

5. Point the remote at your VCR/DVR and press **AUX On-Off**. If your VCR/DVR does not respond, go back to step 2 and try again.

Verifying an entered device code

In case you need to check to see what code the remote is using for a particular audio device, do the following:



1. Press and hold a source key (**TV**, **CBL•SAT**, or **AUX**) until the remote LED lights (about five seconds)
2. Press the **Info** button.
3. Press **1** on the remote and count the number of times the LED blinks (zero is indicated by a long blink). This is the first digit.
4. Press **2** on the remote and count the number of times the LED blinks (zero is indicated by a long blink). This is the second digit.
5. Press **3** on the remote and count the number of times the LED blinks (zero is indicated by a long blink). This is the third digit.
6. Press **4** on the remote and count the number of times the LED blinks (zero is indicated by a long blink). This is the fourth digit.



7. Press **Exit**.

Changing the default TV channel control

With the TV source selected, your remote is set at the factory to select TV channels using your TV. If you wish to use your VCR or cable/satellite box to select TV channels, you can change the default setting in your remote.

To change the default TV channel control:



1. Press and hold **Previous** on the 3•2•1 remote. The remote status LED will illuminate and blink once for TV (factory setting), twice for CBL•SAT, or three times for AUX to identify the default TV channel control.

2. After the blinking stops, press the source button (**TV**, **CBL•SAT**, or **AUX**) that corresponds to the device you want to use for selecting TV channels.



3. Press **Exit** on the 3•2•1 remote.

To confirm, press and hold **Previous** on the 3•2•1 remote and count the number of blinks. If the change was made, press **Exit**. If not, repeat steps 2 and 3.

The media center

The media center has a control panel on the top, a display area to show the current status of the system, and a disc tray that opens on the front of the console.

Control panel

The media center has six buttons located on the top control panel. Their functions are also available through use of the remote control.

Figure 21

Media center controls

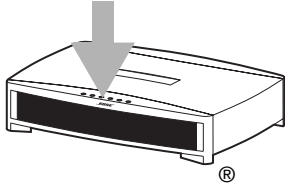

On-Off



Turns system power on or off.

Source



Steps through the available source selections.

- Volume +



Lowers or raises the volume level.

Enter



- Used to navigate through menus.
- Sets next available AM/FM preset

Eject



Opens or closes the disc tray.

Note: If you selected another source by pressing the **Source** button, you cannot control the new source with the remote until you press the button for that new source on the remote.

Display indicators

With the system turned on, the music center display lights up to show the state of the system. Not all possible choices, shown below, light up at once (Figure 22). The display changes with each adjustment or selection you make.

Figure 22

Sample media center display



Lights to indicate disc is in play.

Lights briefly when a remote control command is received.

Lights to indicate shuffle mode is selected for the current disc.

Lights to indicate repeat mode is selected for current track or disc.

Lights to indicate "Repeat Disc" or "Shuffle Repeat Disc" mode is selected.

Lights to indicate "Repeat Track" mode is selected.

Turning your system on and off

To turn power on or off:

- Point the 3•2•1 remote at the media center and press **On/Off**.

OR

- Press **On-Off** on top of the media center.

To turn the system on to a source:

- Press **CD-DVD**, **FM-AM**, **TV**, **CBL•SAT**, or **AUX** on the 3•2•1 remote.

♪ **Note:** Your 3•2•1 remote control can be set up to control other audio devices such as your TV, VCR, or cable/satellite receiver. For instructions, see “Setting up your remote to control other audio/video devices” on page 30.

Playing video DVDs

Before you play your first DVD:

- Familiarize yourself with the 3•2•1 remote control. See “Remote control” on page 26.
- Be sure you understand how to switch between the available video inputs on your TV. To view a video DVD, you will need to select the video input on your TV that is connected to video output of the 3•2•1 media center (see “Connecting your TV to the media center” on page 15).
- If you are unable to select the correct video input on your TV, please consult your TV’s owner’s guide.
- Be sure that you play the 3•2•1 system setup DVD first. This will help you verify the connections you have made and confirm proper sound performance.

1. Turn on your TV.
2. On the 3•2•1 remote, press **CD/DVD** to turn the 3•2•1 system on to the CD/DVD source.
3. On the media center control panel, press **Eject** to open the disc tray.
4. Place the DVD disc in the disc tray.
5. Press **Eject** again to close the tray.

The DVD should begin to play automatically. If not, press **Play** on the 3•2•1 remote.

♪ **Note:** Not all DVDs offer the same features. For example, you can choose to display subtitles while watching a movie only if that particular disc provides subtitle information.

While a DVD video is playing, elapsed play time and chapter number are displayed on the media center front panel.

Figure 23

Sample display for a DVD video

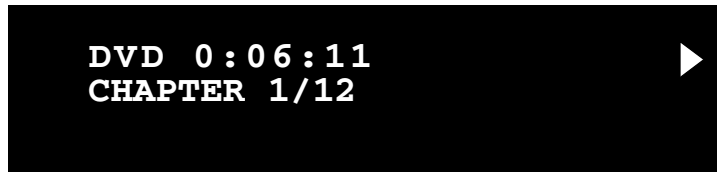

Basic DVD operations



- Press **Pause** to pause a movie.

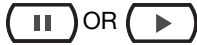

- Press **Pause** again, or press **Play** to resume playing a paused DVD.



- Use the stop button (■) to interrupt a movie in play.
 - Press ■ once to interrupt a playing movie. The system holds the movie at the point of interruption. Press **Play** to resume play from the point of interruption.
 - OR
 - Press ■ twice. Play is interrupted and the system returns to the beginning of the disc. Press **Play** to restart the video.



- Press **Chapter** ▲ to skip to the next chapter on the current DVD. Press **Chapter** ▼ to skip to the previous chapter.



- Press **Repeat** once for REPEAT CHAPTER mode.
- Press **Repeat** again for REPEAT TITLE mode.
- Press **Repeat** again to turn the repeat function off (REPEAT OFF).



- Press ◀◀ to scan backward through the current DVD. Press ▶▶ to scan forward.

Eject



- Press **Eject** on the media center to stop a disc and open the disc tray.

🎵 **Note:** For information on changing DVD-related source settings, see “DVD settings menu” on page 43.

Restricting access to video DVDs

The DVD Lock menu allows you to restrict access to video DVDs which may contain inappropriate material for certain members of your family. You can get to the DVD Lock menu by pressing the **System** button on the remote control. This feature allows you to set up password access for movies which have a certain rating. For instructions on using the DVD Lock menu, see “DVD Lock options” on page 51.

Playing audio CDs



1. On the 3•2•1 remote, press **CD/DVD** to turn the 3•2•1 system on to the CD/DVD source.

Eject



2. On the media center control panel, press **Eject** to open the disc tray.

3. Place the **CD** disc in the disc tray.

Eject



4. Press **Eject** again to close the tray.



5. The audio CD should begin to play automatically. If not, press **Play** on the 3•2•1 remote.

Basic CD operations

- Press **Pause** to pause an audio CD.



- Press **Pause** again, or press **Play** to resume playing a paused CD.



- Press **■** to stop an audio CD.



- Press **Track ▲** to skip to the next track on the current CD. Press **Track ▼** to skip to the previous track.



- Press **Seek ►►** once to skip to the next track.
- Within the first 2 seconds of play, press **Seek ◀◀** to skip to the previous track. After 2 seconds of play, press **Seek ◀◀** to skip to the beginning of the current track.
- Press and hold **Seek ◀◀** or **Seek ►►** to scan backward or forward through a track.



- Press **Repeat** once for REPEAT TRACK mode. Press **Repeat** again for REPEAT DISC mode. Press **Repeat** again to turn the repeat functions off (REPEAT OFF).



- Press **Shuffle** once for SHUFFLE DISC mode. Press **Shuffle** again to turn off the shuffle mode (SHUFFLE OFF).

🎵 **Note:** For information on changing CD-related source settings, see “CD settings menu” on page 42.

🎵 **Note:** If playing an MP3 CD, the **Info** button displays or clears artist and title information on the media center display panel.

Listening to FM/AM radio



On the 3•2•1 remote, press **FM-AM**. If the system is off, the radio will turn on to the most recently selected station.

Tuning to a station

You can tune to a radio station in any of the following ways:

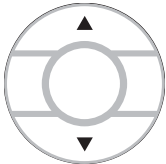

- Press **FM-AM** to switch between the FM and AM bands.
- Press **Tune ▲** to tune up the band. Press **Tune ▼** to tune down the band.
- Press **Seek ◀◀** to go to the previous station. Press **Seek ▶▶** to go to the next available station. Press and hold for rapid tuning. Release to stop at the next available station. To stop anytime, briefly press **Seek ◀◀** or **Seek ▶▶**. To begin seeking again without holding down the **Seek** button, briefly press **Seek ◀◀** or **Seek ▶▶** as soon as the first seek operation stops.

OR

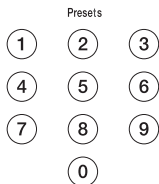

- Press the number of a preset station on the keypad.

🎵 **Note:** For information on changing FM/AM-related source settings, see “FM/AM settings menu” on page 42.

Storing stations as presets

Using your 3•2•1 remote control you can store up to 20 AM and 20 FM station presets. This enables you to tune to a favorite station quickly.

1. Tune to the preferred station.
2. Store the station with an assigned preset number.
 - For numbers 1-9, press the single number button and hold it. For numbers 10-20, press the first number. Immediately after, press the second number and hold it.
 - OR, press **Enter** on the media center to store the selected station at the next available preset number.

The newly assigned preset number appears briefly on the media center display.

🎵 **Note:** Assigning a preset number to a station will replace any previous assignment of that preset.

Erasing a preset

1. Tune to the preset station.
2. Press and hold the **0** button on the remote until the media center display tells you that the preset is erased.

Playing other sources

Turn on any component connected to the media center by using the remote for that component or controls on the component front panel. Use the 3•2•1 Series II or 3•2•1 GS Series II system remote to get started:

- Pressing **TV**, **CBL•SAT**, or **AUX** on the 3•2•1 or 3•2•1 GS system remote turns on the system and selects the audio for that component. Be sure a tape or disc is loaded, as needed.
- Use the **Volume** up or down arrows on the system remote or on the media center to raise or lower the volume of the system.

Using the sleep timer

Your system includes a sleep timer which can be set to turn your system off automatically after 10 to 90 minutes of listening to any source. This timer can be accessed through the Settings menu for any source. See “Changing Source Settings” on page 40.

 **Note:** *The sleep timer will not turn off the TV or other audio device.*

CHANGING SOURCE SETTINGS

Using the settings menus

While watching a video or listening to music on your system, you can make quick adjustments that will increase your enjoyment of the program. For that purpose, each source you use with this system has its own Settings menu with features appropriate to that source.

To view the settings menus

You can see the Settings menu for each source on your TV screen (Figure 24) and on the display panel of your media center (Figure 25).

1. Turn on your TV and select the correct TV input to view your 3•2•1 system.
2. Press a source button on your 3•2•1 remote control.
3. Press **Settings** to display the Settings menu for the selected source.

If the list of menu items is too long for the screen, a small down or up arrow indicates that you need to scroll down or up to see other items.

4. Press **Exit** to dismiss the Settings menu.



Settings



Exit

Figure 24

Sample Settings menu on your TV screen

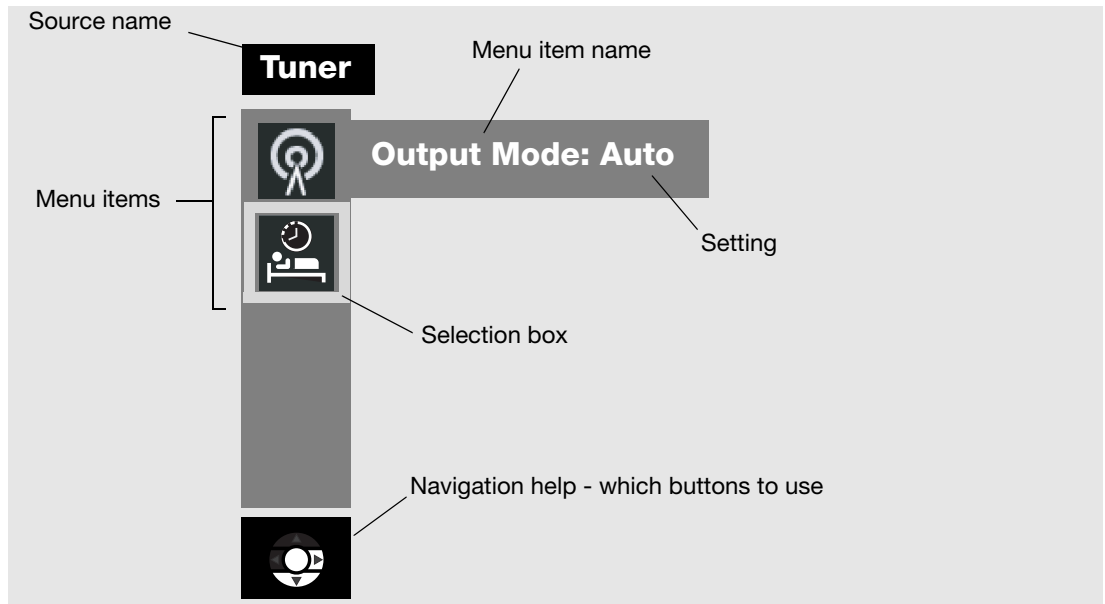

Note: Any changes made in the settings menu on your TV screen will also appear in the media center display panel.

On the media center display panel, menu items will scroll in and out of view as you press the up (▲) and down (▼) arrow buttons on the remote.

Figure 25

Sample Settings menu on the media center display

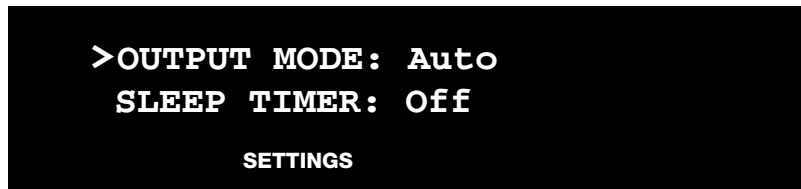

To make changes in the settings menus

Whether you use your TV screen or the media center display to change settings, the same instructions apply.

You can use the actions above to change back to the original (default) settings, too. Do that if you do not like the effect of a change you have made, or accidentally made a change you did not intend. The default settings for each source are shown in the menu tables on the following pages.

1. Turn on your TV and select the correct TV input to view your 3•2•1 system.
2. Press a source button on your 3•2•1 remote control.
3. Press **Settings** to display the Settings menu for the selected source.
4. Using the down (▼) and up (▲) arrow buttons, select the menu item you want to change.
5. Press the right arrow (▶) button to select the menu item setting.
6. Press the up (▲) or down (▼) arrow button to change the setting.
7. Press **Enter** or the left arrow (◀) button to save the setting.
8. Press **Exit** to dismiss the Settings menu.



The progression in Figure 26 shows Output Mode for the FM tuner being changed from Auto to Stereo.

Figure 26

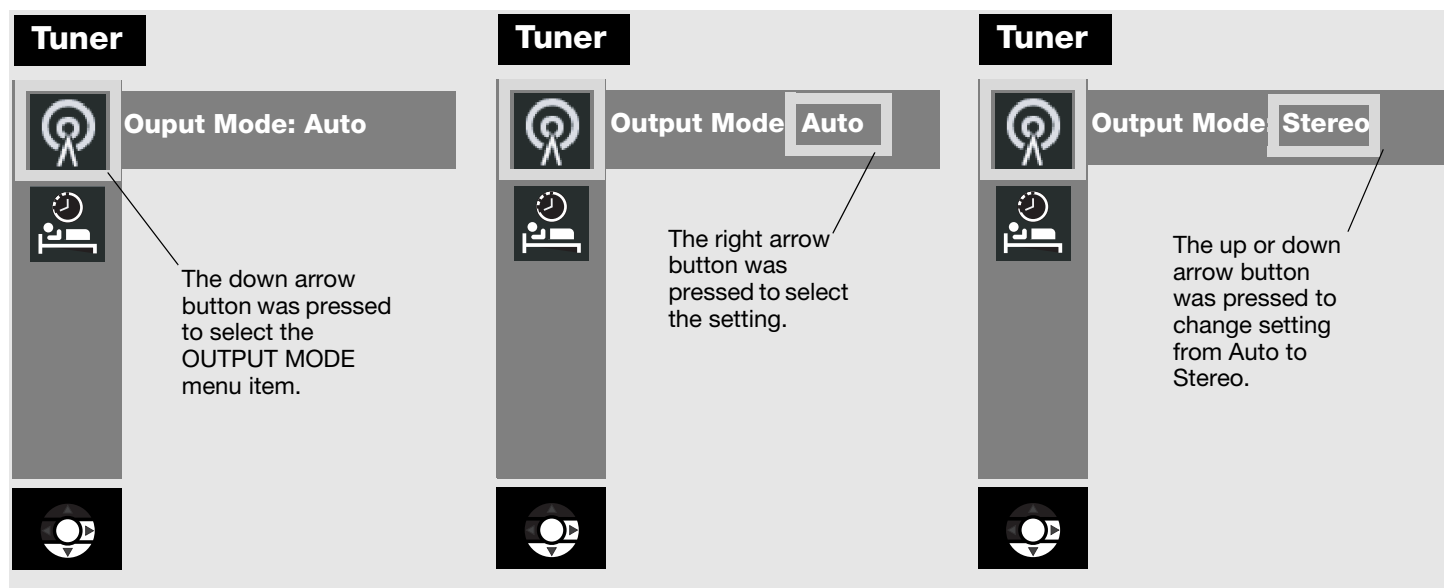

Changing the FM Output Mode setting



Note: You can restore all default settings by choosing **Restore Settings** in the Systems menu, under **Media Center** options. This reverts all source settings back to the factory default settings. It also changes the **Audio Processing** setting back to **Automatic** (found in the Systems menu under Audio options).



FM/AM settings menu

To see the FM/AM Settings menu, press **FM-AM** on the remote. Then press **Settings**. Press **Exit** to remove the menu from the screen.

	<i>Name</i>	<i>Settings</i>	<i>Default</i>	<i>Description</i>
	Output Mode (FM only)	Auto, Stereo, Mono	Auto	Allows you to listen to stereo broadcasts in either stereo or mono output.
	RDS Info (FM only, and only on some systems)	Off, On	Off	Displays station and program information (as available from Radio Data System).
	Sleep Timer	Off, 10-90 minutes	Off	Turns the system off after the set time expires. Choose off to deactivate the timer.











CD settings menu

To see the CD Settings menu, press **CD-DVD** on the remote while playing an audio CD. Then press **Settings**. Press **Exit** to remove the menu from the screen.

	<i>Name</i>	<i>Settings</i>	<i>Default</i>	<i>Description</i>
	Track	__ of __		Allows you to select a track on the current disc.
	Sleep Timer	Off, 10-90 minutes	Off	Turns the system off after the set time expires. Choose off to deactivate the timer.

DVD settings menu

To see the DVD Settings menu, press **CD-DVD** on the remote while playing a DVD video disc. Then press **Settings**. Press **Exit** to remove the menu from the screen.





	Name	Settings	Default	Description
	Movie EQ*	On, Off	On	Optimizes the tonal balance for movies.
	Range Compression*	On, Off	On	Adjusts volume to maintain dialogue intelligibility. Keeps some sounds from overwhelming others.
	Mono Decoding*	On, Off	On	Engages Videostage® 5 mono decoding circuitry to process mono sound (one-channel audio) for your system.
	Time	_: _	0:00	Displays the elapsed time of the current DVD. Also, allows you to move to a new location in the movie by entering a new time.
	Title	__ of __		Selects a DVD title from the current disc, according to the number set. Some DVDs do not allow direct access to titles.
	Chapter	_____		Selects a DVD chapter from the current DVD movie, according to the number entered. Some DVDs do not allow direct access to chapters.
	Audio Track	Dependent on disc		Allows you to choose one of the available audio tracks on the current disc.
	Subtitle language	Dependent on disc		Allows you to choose one of the available subtitle languages (only if included on disc).
	Camera Angle	1 of _____		Allows you to select one of the available camera angles (only if included on disc).
	A-B Repeat	A, B		Repeats a segment of the DVD after the start and end points are defined. To begin: <ol style="list-style-type: none"> 1. Move backward or forward to the point in the DVD where you want the segment to start. 2. Press Enter. 3. Move to the point where you want it to end. 4. Press Enter. Repeats until you press the Settings button.
	Sleep Timer	Off, 10-90 minutes	Off	Turns the system off after the set time expires. Choose off to deactivate the timer.

*Available only when Audio Processing is set to User Adjustable. See “Audio options” on page 47 for more information.

TV, CBL·SAT, and AUX settings menu

The settings below affect programs on the TV, even when the source of the program is VCR, CBL·SAT or AUX. There are no separate setting menus for these sources.

Movie EQ, Range Compression and Mono Decoding appear in the menu only if **Audio Processing** is set to **User Adjustable**. Audio Processing can be found in the System menu under Audio options.

	Name	Settings	Default	Description
	Movie EQ*	On, Off	On	Optimizes the tonal balance for movies.
	Range Compression*	On, Off	On	Adjusts volume to maintain dialogue intelligibility. Keeps some sounds from overwhelming others.
	Mono Decoding*	On, Off	On	Engages Videostage® 5 mono decoding circuitry to process mono sound (one-channel audio) for your system.
	Dolby Digital 1+1**	1, 2, Both	1	Plays audio content of selected soundtrack(s). The content of the second soundtrack may be a second language, for example.
	Sleep Timer	Off, 10-90 minutes	Off	Turns the system off after the set time expires. Choose off to deactivate the timer.

*Available only when Audio Processing is set to User Adjustable. See “Audio options” on page 47 for more information.

** Available only when a Dolby Digital 1+1 signal is detected.

Using the System menu

Changes to system options are typically made only once. If your system operates as you want it to, there may be no need for any changes. In some cases, however, changes are required to make the system fully compatible with the installation options you have chosen.

To view the System menu

Unlike the source settings menus, the System menu only appears on your TV screen.

1. Turn on your TV and select the correct TV input to view your 3•2•1 system.
2. Press the **System** button on your 3•2•1 remote control. The System menu appears with Audio options selected, showing a list of the Audio options that can be changed.



3. Press **Exit** to dismiss the System menu.

 **Note:** Entering the System menu causes any DVD or VCD that is playing to pause.

Figure 27

Sample system menu showing audio options

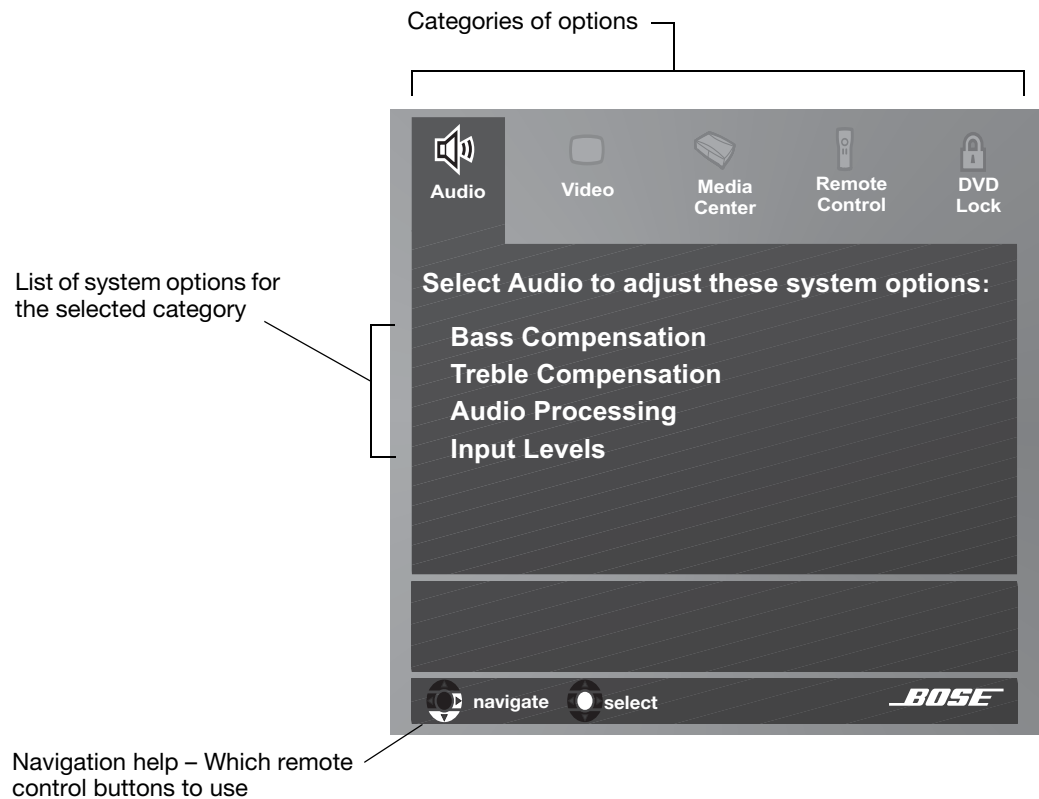

To change system options

Changing system options in this menu is similar to changing the settings for a source.

1. Turn on your TV and select the correct TV input to view your 3•2•1 system.
2. Press the **System** button on your 3•2•1 remote control.
3. Using the right (▶) and left (◀) arrow buttons, highlight one of the option categories (Audio, Video, Media Center, Remote Control, or DVD Lock).
4. Press **Enter** or the down (▼) arrow to select the option category.
5. Using the down (▼) and up (▲) arrow buttons, select the system option to change.
6. Press the right arrow (▶) button to see the system option settings.
7. Press the up (▲) or down (▼) arrow button to change the setting.
8. Press **Enter** or the left arrow (◀) button to save the setting.
9. Press **Exit** to dismiss the System menu.



Audio options

The audio options affect the way the system sounds in your home.

🎵 **Note:** Listening to an audio source while you change audio options can be helpful. Some changes will be immediately noticeable and therefore useful in fine tuning your selections.

Figure 28

Audio system options

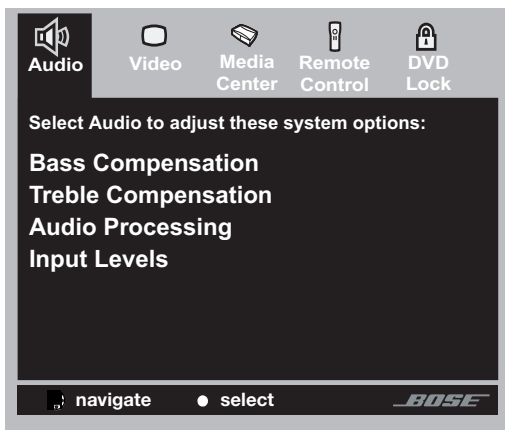

	Settings	Description
Bass Compensation	0 [default] -14 to +14	Normal low-frequency reproduction. Decreased (-) or increased (+) low-frequency reproduction.
Treble Compensation	0 [default] -14 to +14	Normal high-frequency reproduction. Decreased (-) or increased (+) high-frequency reproduction.
Audio Processing	Automatic [default] User Adjustable	Standard Bose® processing applied. Processing options (Movie EQ, Range Compression, Mono Decoding) available in Source Settings menus.
Input Levels: TV Analog Input Level TV Digital Input Level CBL·SAT Analog Input Level CBL·SAT Digital Input Level AUX Analog Input Level AUX Digital Input Level	Normal [default] -6, -3, +3, +6	Standard signal level (loudness). Decreases or increases signal level (adjustable to match the levels of other audio devices). Note: You may want to adjust the input levels of external audio devices so they match the system's internal FM and CD levels.

Video options

The video options affect the way the picture looks on your TV.

Figure 29

Video system options

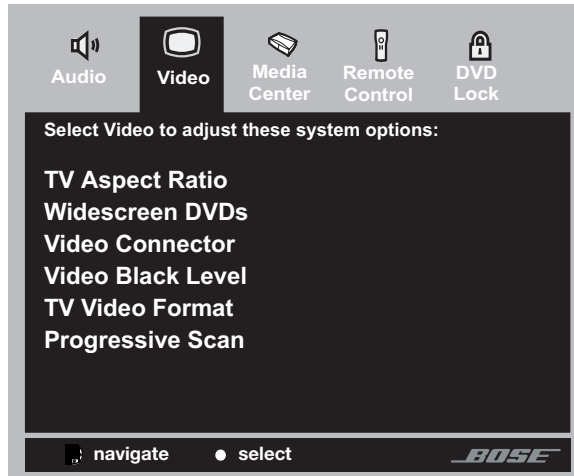

	Settings	Description
TV Aspect Ratio	Normal [default] Widescreen	4:3 ratio screen display. 16:9 ratio widescreen display.
Widescreen DVDs	Modified [default] Unmodified	Modified [default]. Unmodified.
Video Connector	Composite + S-Video [default] Component	A <i>read-only</i> line that identifies the type of video connection made on the back panel of the media center.
Video Black Level	Normal [default] Extended	Screen black level generally appropriate for TVs. Increases screen black level, appropriate for certain TVs.
TV Video Format	NTSC (US) [default] PAL (EUROPE) (MULTISTANDARD)	Correct for NTSC (US standard) monitors. Correct for PAL (European standard) monitors. Only for a TV that supports multiple formats (NTSC and PAL).
Progressive Scan*	Off [default] On	Screen image repaints in standard style. Screen image repaints in advanced style (if available on the TV).

*Appears only when your TV is connected to the media center using a component video connection.

Media center options

The media center options affect the general operation of the system.

Figure 30

Media Center system options

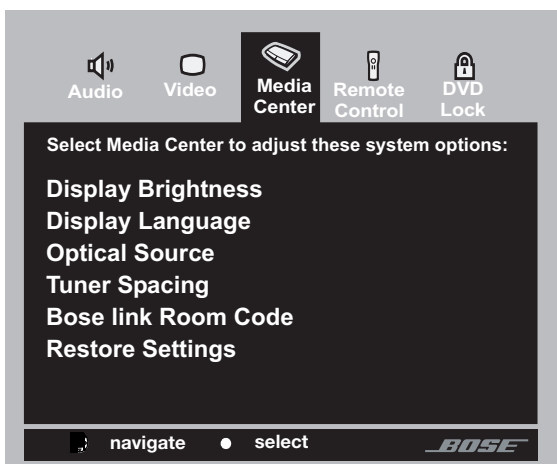

	Settings	Description
Display Brightness	4 [default] 1 (darkest) to 4 (brightest)	Media center display lights with a mid-range brightness. Darkens or lightens the media center display.
Display Language	English [default] Dansk, Deutsch, Espanol, Francais, Italiano, Nederlands, Svenska	On-screen display menus appear in the selected language.
Optical Source	None [default] TV, CBL•SAT, AUX	No digital signal received via optical cable. Digital signal received via optical cable for selected source.
Tuner Spacing	US [default] European	Channel spacing for AM/FM radio stations set to selected region standard.
Bose® link Room Code*	B [default], C, D, E, F, G, H, I, J, K, L, M, N, or O	Assigns a room code to your 3•2•1 Series II system when it is connected to a Bose link source.
Restore Settings	No Yes	Maintains current system settings. Reverts system settings back to factory defaults.

*Appears only when a Bose link source is connected.

Remote control options

The Remote Control options help you set up your remote to control other audio devices that are connected to your system.

Figure 31

Remote Control system options

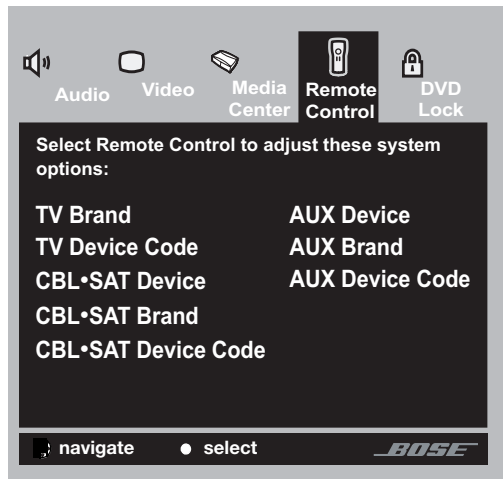

	Settings	Description
TV Brand	Brand name	Provides a list of TV brands for the 3•2•1 remote control to operate.
TV Device Code	Code number	Provides a list of available device codes for the selected TV brand.
CBL•SAT Device	Cable, Cable/DVR, Satellite, Satellite/DVR, HDTV tuner	Identifies the device connected to the CBL•SAT input.
CBL•SAT Brand	Brand name	Provides a list of cable/satellite box brands for the 3•2•1 remote control to operate.
CBL•SAT Device Code	Code number	Provides a list of available device codes for the selected cable/satellite box brand.
AUX Device	TV/DVD, DVD/DVR, DVD/DVD recorder, Satellite/DVR, Cable/DVR, DVR, VCR	Identifies the device connected to the AUX input.
AUX Brand	Brand name	Provides a list of video recorder brands for the 3•2•1 remote control to operate.
AUX Device Code	Code number	Provides a list of available device codes for the selected AUX device or (or video recorder) brand.

- ♪ **Note:** To find the brand and device codes for each component that can be connected to, and controlled by the 3•2•1 system, see “Device Codes on page A-1.”
- ♪ **Note:** After programming your remote to control external audio/video devices from the System menu, press the System button once to continue navigating the System menu.

DVD Lock options

The DVD Lock options allow you to restrict viewing of DVD videos with certain ratings. To activate this feature, you need to set a level of restriction and establish a password in the DVD Lock section of the System menu.

Figure 32

DVD Lock system options

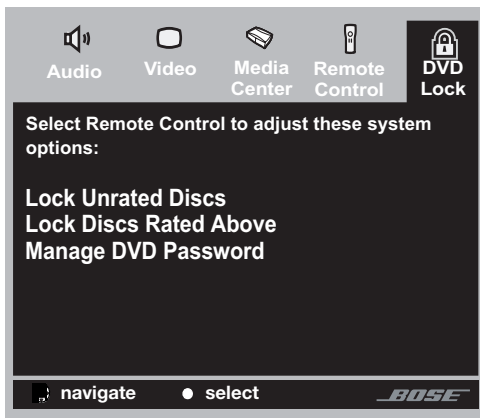

	Settings	Description
Lock Unrated Discs	Off On	No restriction applies to unrated DVD movies. Restricts viewing access to unrated titles when password is set.
Lock Discs Rated Above	1 to 8	Helps prevent viewing discs above the selected number when a password is created.
Manage DVD Password	----	Establishes a new four-number code to restrict access to movies with certain ratings.

Setting a password and restriction level

Your password will help prevent unauthorized viewing of DVD videos that have a higher rating than your restriction level. There are 8 levels to choose from, matched to movie ratings set by the Motion Picture Association of America (MPAA). See “Motion Picture Association of America (MPAA) rating system” on page 52.

1. Turn on your TV and select the correct TV input to view your 3•2•1 system.
2. Press the **System** button on your 3•2•1 remote control.
3. Using the right (▶) and left (◀) arrow buttons, highlight the DVD Lock option.
4. Press **Enter** or the down (▼) arrow key.



Note: If you are using the DVD Lock option for the first time, enter a four-digit password. Then enter it again to confirm.



5. Enter your four-digit password.
6. Using the down (▼) button, scroll down to Lock Discs Rated Above.
7. Press the right arrow (▶) button to see the available settings.
8. Press the up (▲) or down (▼) arrow button to find the rating you want.
9. Press **Enter** or the left arrow (◀) button to save the setting.
10. Press **Exit** to dismiss the Settings menu.

Motion Picture Association of America (MPAA) rating system

	<i>MPAA Rating</i>	<i>Audience Restriction</i>
8		None
7	NC-17	Adult audiences
6	R	Mature audiences
5		Mature teenage audiences
4	PG-13	Teenage audiences
3	PG	Mature young audiences
2		Most audiences
1	G	General

Example: Choosing a Parental Control Setting of 4, restricts access to videos rated above PG-13. Videos with ratings above that may be viewed only after entering the password.

Your password also helps prevent others from changing the restriction level setting without permission.

Cleaning

Cleaning the media center

- Use only a soft, dry cloth to clean the outside surfaces of the media center.
- Do not use any sprays near the system. Do not use any solvents, chemicals, or cleaning solutions containing alcohol, ammonia, or abrasives.
- Do not allow liquids to spill into any openings.

Cleaning the speakers

- Clean the surface of your speakers with a soft, damp cloth. You can use an ammonia-free window cleaner on a soft cloth to maintain the finish.
- Do not use any sprays near the speakers. Do not use any solvents, chemicals, or cleaning solutions containing alcohol, ammonia, or abrasives.
- Do not allow liquids to spill into any openings.
- The speaker grilles require no special care, although you may vacuum them carefully if necessary.

Cleaning discs

- Handle discs by their edges to prevent fingerprints and scratches (Figure 33a).
- To remove stains or fingerprints from the surface of a disc, use a soft and dry lint-free, cloth. Wipe in straight movements from the center of the disc to the outside (Figure 33b). Do not use any chemical products; they can damage the disc.
- Do not use a circular motion to clean (Figure 33c).
- Do not write on or attach labels to the surface of a disc.
- To minimize exposure to dust and dirt, return discs to their cases after use. Store each disc in its case, away from direct sunlight, high temperatures, and humidity.

Figure 33

Disc care

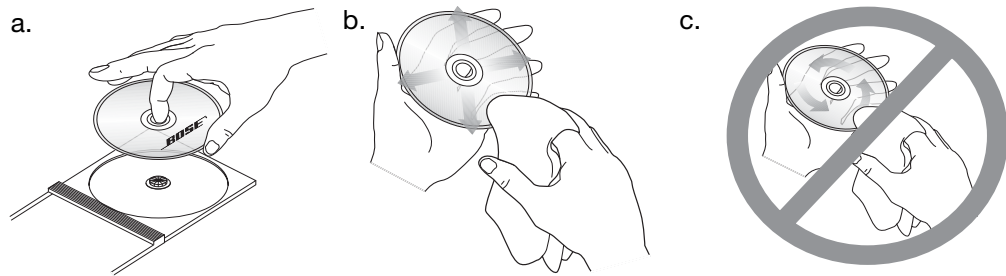

Replacing the remote control batteries



CAUTION: Please dispose of used batteries properly, following any local regulations. Do not incinerate.

- Slide open the battery compartment (Figure 34).
- Notice the polarity markings (+ and -) inside the compartment and install the batteries accordingly. Be sure to replace both batteries.
- Slide the battery compartment cover back into place.

Figure 34

Putting in the batteries

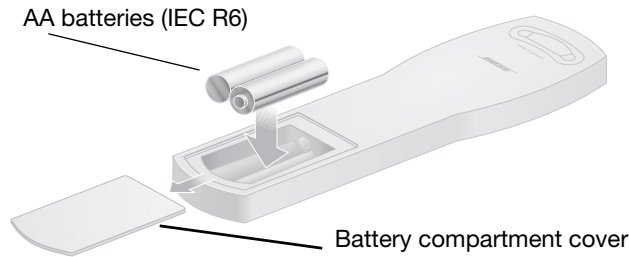

Accessories

The Bose® 3•2•1 Series II and 3•2•1 GS Series II system shelf speakers are compatible with Bose mounting accessories, including the UB-20 wall brackets, UFS-20 floor stands and UTS-20 table stands (Figure 35). Bose also offers cable adapters for use in running speaker cable through walls.

For further information or to order the mounting brackets, stands, or cable adapters, contact your Bose dealer or Bose Corporation directly. Refer to the address sheet included in the shipping carton.

Figure 35

Speaker accessories

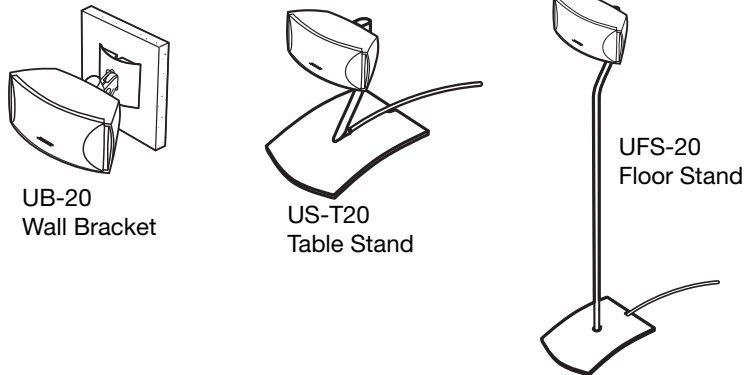

Troubleshooting table

Problem	What to do
System doesn't do anything	<ul style="list-style-type: none"> • Make sure the unit is turned on. Try pressing the remote On-Off button and the media center On-Off button. • Make sure the power cord is inserted securely into the Acoustimass® module and plugged firmly into an operating AC wall outlet. • Be sure to select a source (CD/DVD, AM/FM, etc.). • Unplug the Acoustimass module power cord from the outlet for one minute, then reconnect it. This allows the unit to reset itself. After reconnecting the power cord, wait for the message, "BOSE 3•2•1" to appear on the media center display.
Disc won't eject	<ul style="list-style-type: none"> • Turn off the unit. • Unplug the Acoustimass module power cord from the outlet for one minute, then reconnect it. This allows the unit to reset itself. • Before powering on, press and hold Eject on the media center.
No sound	<ul style="list-style-type: none"> • Increase the volume. • Check to see if MUTE is lit on the display. If it is, press the Mute button on the remote control to unmute the sound. • Be sure to select the correct source for the desired input. • Make sure the Acoustimass module cable and speaker cable are firmly seated in their respective jacks and the multi-pin connector on the other end is firmly seated in the Acoustimass module jack. • Check speaker connections. • Turn the media center off for 10 seconds, then on again, to restore communication between the media center and the speakers. • Check the connections for any external audio devices. • Be sure the disc is placed correctly, label-side up, in the CD tray. • Connect the FM and AM antennas. • Unplug the Acoustimass module power cord from the outlet for a minute, then reconnect it. This allows the unit to reset itself. • If you are using an optical digital audio connection, make sure that the optical jack is correctly assigned in the System menu. • Make sure the volume is turned up on the TV. • Check input level settings for each connected device in the System menu.

Problem	What to do
Sound, but no picture	<ul style="list-style-type: none"> • Make sure the TV is on. • When playing a DVD or other video source, make sure the TV is set to the correct video input.
Remote control is inconsistent or does not work	<ul style="list-style-type: none"> • Check batteries and their polarity (+ and –). See “Replacing the remote control batteries” on page 54. • Point the remote control at the media center.
Radio does not work or has poor reception	<ul style="list-style-type: none"> • Make sure antennas are connected properly. • Move AM antenna at least 20 inches (50 cm) from the media center. • Adjust antenna position to improve reception. • AM antenna must be upright. • Move antennas farther from TV or other electronic equipment. • You may be in an area of weak signal coverage.
DVD or CD does not play	<ul style="list-style-type: none"> • Check to see if the Play symbol in the display is lit. • After pressing the CD/DVD button, wait a few seconds before pressing Play. • Make sure the disc is properly inserted (label-side up). • Eject the disc and try loading it again. • There may be dirt or dust on the disc. Clean the disc. See “Cleaning discs” on page 53. • The disc may be defective. Try another disc. • Make sure region codes for both the DVD and player match. See “Check for region code compatibility” page 6.
FM sound is distorted	<ul style="list-style-type: none"> • Adjust antenna position to reduce interference.
Sound is distorted	<ul style="list-style-type: none"> • Make sure speaker cables are not damaged and the connections are secure. • Reduce the output level from any external audio devices connected to the music center. • Reduce the input level setting for the connected device in the system menu.
Picture is black and white or rolling	<ul style="list-style-type: none"> • Check the video cable connections. • Check the Video Format setting and change to appropriate setting (NTSC or PAL). See “Video options” on page 47.
You forgot your password	<ul style="list-style-type: none"> • Enter the password 2673 to access the parental controls and create a new password.

Customer service

For additional help in solving problems, contact Bose® Customer Service. Refer to the address list included in the carton.

Power rating

USA/Canada: 120V ~ 60Hz 300W

International: 220-240V ~ 50/60Hz 300W

Dual voltage: 115/230V ~ 50/60Hz 300W

Audio inputs

AUX – Left, Right (analog); **D** (digital)

CBL•SAT – L, R (analog); **D** (digital)

TV – L, R (analog); **D** (digital)

Optical – SPDIF digital, mapped to input

Audio outputs

Acoustimass® Module – SPDIF

Video inputs

C (composite) – NTSC or PAL format

S-Video

Video outputs

C (composite) – NTSC or PAL format

S-Video

Component Y, Pb, Pr

Antennas

FM 75Ω – external FM antenna

AM – external AM antenna

Maximum ambient temperature

104°F (45°C)

Dimensions

Media center: 3¹/₄"H x 13³/₄"W x 10"D
(8.3 cm x 34.9 cm x 25.4 cm)

Remote control: 1¹/₈"H x 2¹/₂"W x 9"D
(3.0 cm x 6.5 cm x 22.9 cm)

3•2•1 speakers: 3¹/₂"H x 7⁷/₈"W x 5¹/₄"D
(8.7 cm x 19.9 cm x 13.6 cm)

3•2•1 GS speakers: 2¹/₂"H x 5¹/₂"W x 4"D
(6.4 cm x 14 cm x 10.5 cm)

Acoustimass module: 14¹/₂"H x 8³/₄"W x 19¹/₈"D
(36.7 cm x 22.2 cm x 48.5 cm)

Weights

Media center: 6.7 lb (3.0 kg)

3•2•1 speakers: 2.7 lb (1.2 kg) each

GS speakers: 1 lb (.45 kg) each

Acoustimass module: 23.3 lb (10.6 kg)

Finish

Media center: polymer

Speakers: polymer

Acoustimass module: polymer

DEVICE CODES

Finding the right device codes

Using the right device codes, you can set up your new universal remote to control the video devices you want to use with your speaker system. For the remote setup procedure, see your owner's guide.

To find available codes for a device, search the listing under the appropriate device type heading.

If you have a combination device, such as a TV with a built-in DVD or VCR device, first search the "COMBINATION" listings starting on page 20. If you cannot find a valid code there, then search the listings for individual device types. Keep in mind that combination devices may use the same code for each device in the unit.

TV	A-2
Television	
CBL	A-8
Cable box	
SAT	A-9
Satellite receiver	
DVD	A-11
VCR	A-15
VCR	
DVR	A-18
Digital Video Recorder	
HDTV	A-19
HDTV Decoder	
Combination	A-20
TV/VCR	A-20
TV/VCR combination	
TV/DVD	A-20
TV/DVD combination	
TV/VCR/DVD	A-20
TV/VCR/DVD combination	
VCR/DVD	A-20
VCR/DVD combination	
CBL/DVR	A-21
Cable/DVR combination	
SAT/DVR	A-21
Satellite/DVR combination	
DVD/DVR	A-21
DVD/DVR combination	

TV

Television

A-Mark 0003
 Abex 0032
 Addison 0092, 0108, 0653, 1150
 Admiral 0093, 0463
 Advent 0761, 0783, 0815, 0817, 0842
 Adventura 0046
 Adyson 0032, 0217
 AEA 0037
 AEG 0606
 Agashi 0217
 Aiko 0037, 0092, 0217
 Aim 0208, 0606, 0706
 Aiwa 0701, 1180
 Akai 1537, 0812, 0745, 0714, 0708, 0706, 0702, 0698, 0672, 0631, 0606, 0602, 0556, 0548, 0480, 0217, 0208, 0178, 0060, 0037, 0030
 Akiba 0037, 0282
 Akira 0037, 0556
 Akito 0037
 Akura 0037, 0282, 0714, 1037
 Alaron 0179
 Alba 0037, 0443, 0714, 1037
 Albatron 0700, 0843
 Alfide 0672
 Allorgan 0217
 Allstar 0037
 Ambassador 0177
 America Action 0180
 Amplivision 0217, 0370
 Ampro 0751
 Amstrad 0037, 0171, 0177, 1037
 Anam 0003, 0180, 0250, 0628, 0700
 Anam National 0055, 0250, 0650
 Andersson 1163
 Anex 0037
 Anhua 0051
 Anitech 0037, 0282
 Ansonic 0370, 0556
 AOC 0003, 0018, 0019, 0030, 0052, 0060, 0092, 0093, 0108, 0178, 0179, 0180, 0185, 0451, 0628, 1150
 Apex 0156, 0765
 Apex Digital 0748, 0765, 0767, 0879, 0890
 Arcam 0217
 Archer 0003

Ardem 0037, 0486, 0556, 0633, 0714
 Aristona 0037, 0556
 ART 1037
 Astra 0037
 Asuka 0217
 ATD 0698
 Atlantic 0001
 Audinac 0180
 Audiosonic 0037, 0217, 0370, 0486, 0714
 Audioton 0217, 0486
 Audiovox 0003, 0092, 0180, 0451, 0623, 0802, 0875
 Autovox 0217
 Aventura 0171
 Awa 0037, 0108, 0157, 0217, 0512, 0606, 0698
 Axxon 0714
 Baile 0001, 0661
 Baird 0208, 0217
 Bang & Olufsen 0565
 Baosheng 0817
 Basic Line 0037, 0217, 0282, 0556, 1037, 1163
 Baur 0037, 0146, 0512
 Baysonic 0180
 Bazin 0217
 Beaumark 0178
 Beijing 0001, 0208, 0226, 0661, 0812, 0817
 Beko 0037, 0370, 0486, 0606, 0714, 1037
 Belcor 0019
 Bell & Howell 0016, 0154
 BenQ 1032, 1756
 Beon 0032, 0037
 Best 0370
 Bestar 0037, 0370
 Binatone 0217
 Black Diamond 0556, 0587, 1037
 Blaupunkt 0170, 0195
 Blue Sky 0037, 0282, 0556, 0606, 0714, 1037, 1254
 Blue Star 0282
 Boots 0217
 Boxlight 0893
 BPL 0037, 0208, 0282
 Bradford 0180
 Brandt 0335, 0560, 0625, 0714
 Brandt Electronique 0335
 Brinkmann 0037, 0486
 Britannia 0217
 Brockwood 0019

Broksonic 0003, 0180, 0236, 0463
 Bush 0037, 0208, 0217, 0282, 0486, 0556, 0661, 0698, 0714, 1037
 Caihong 0817
 Cailing 0748
 Candle 0030, 0046, 0056, 0186
 Carad 0037, 1037
 Carena 0037
 Carnivale 0030
 Carver 0054, 0170
 Cascade 0037
 Casio 0037
 Cathay 0037
 CCE 0037, 0217
 Celebrity 0000
 Celera 0765
 Celestial 0767
 Centrex 0698, 0780
 Centrum 1037
 Centurion 0037
 CGE 0370
 CGM 1037
 Changcheng 0001, 0051, 0661, 0817
 Changfei 0817
 Changfeng 0817
 Changhai 0817
 Changhong 0156, 0508, 0765, 0767, 0783, 0817, 1156
 Chengdu 0817
 Ching Tai 0003, 0092, 0179
 Chun Yun 0000, 0003, 0092, 0179, 0180, 0700, 0843, 1150
 Chung Hsin 0053, 0108, 0180, 1150
 Chunsun 0817
 Cinema 0672
 Cinal 0092, 0451
 Citizen 0030, 0039, 0046, 0056, 0060, 0092, 0186, 0280
 Clairtone 0185
 Clarion 0180
 Clarivox 0037
 Clatronic 0037, 0217, 0370, 0556, 0606, 0714
 Clayton 1037
 CMS Hightec 0217
 Commercial Solutions 0047, 1447
 Concerto 0056
 Condor 0037, 0282, 0370
 Conia 0754
 Conic 0032
 Conrac 0808

Conrowa.....	0145, 0156, 0698, 1156	Durabrand	0003, 0171, 0178, 0180, 0463, 1034, 1463	Fujitsu	0037, 0179, 0186, 0217, 0683, 0809, 0853, 1181
Contec.....	0037, 0157, 0180, 0185, 0698	Dwin	0093, 0720, 0774	Fujitsu General	0217, 0683
Cosmel	0037	Dynatron.....	0037	Funai.....	0171, 0179, 0180, 0556, 1271
Craig.....	0180	Ecco	0706	Furi.....	0145, 0817
Crosley	0054	ECE	0037	Future	0037
Crown	0037, 0039, 0053, 0180, 0208, 0370, 0486, 0606, 0672, 0714	Elbe	0217	Futurtech	0180
Crown Mustang.....	0672	Electroband	0000, 0185	Galaxi.....	0037
Curtis Mathes	1347, 1147, 0702, 0466, 0451, 0166, 0154, 0145, 0093, 0060, 0056, 0054, 0051, 0047, 0039, 0030, 0016	Electrograph.....	1755	Galaxis.....	0037, 0370
CXC.....	0180	Electrohome	0381	Ganxin	0817
D-Vision.....	0037, 0556	Elekta.....	0037, 0282	Gateway	1755, 1756
D.Boss.....	0037	Elektra.....	0017, 1661	GE.....	1454, 1447, 1347, 1147, 0625, 0560, 0451, 0335, 0282, 0180, 0178, 0135, 0093, 0092, 0055, 0051, 0047, 0030, 0027, 0021
Daewoo	1661, 1150, 0880, 0865, 0706, 0700, 0672, 0661, 0634, 0628, 0623, 0556, 0451, 0217, 0180, 0178, 0170, 0154, 0108, 0092, 0056, 0039, 0037, 0032, 0030, 0019, 0003	Elin.....	0037, 0548	GEC	0037, 0217
Dansai	0032, 0037, 0208	Emerson	0714, 0623, 0486, 0463, 0451, 0370, 0282, 0280, 0236, 0185, 0180, 0179, 0178, 0177, 0171, 0154, 0039, 0038, 0037, 0019	General.....	0186
Dantax.....	0606, 0714	Emperor.....	0282	Genesis.....	0037
Datsura.....	0208	Envision.....	0030, 0813	Gericom.....	0808, 0865
Daytek	0037, 0706	Epson	0833, 0840, 1122, 1322	Giant.....	0217
Daytron.....	0019	Erres	0037	Gibraltar.....	0017, 0019, 0030
Dayu	0661	ESA.....	0171, 0812	Gintai	1150
De Graaf.....	0208, 0548	ESC	0037, 0217	Go Video.....	0886
DEC	0556, 0698	Ether	0003, 0030	GoldStar	0001, 0019, 0030, 0032, 0037, 0039, 0056, 0154, 0178, 0217, 0556, 0606, 0714, 1150
Decca	0037, 0217	Etron	0001	Goodmans.....	0032, 0037, 0179, 0217, 0335, 0360, 0451, 0480, 0556, 0560, 0634, 0661, 0714, 0808, 1037, 1163
Deitron.....	0037	Eurofeel	0217	Gorenje.....	0037, 0370
Dell	1080, 1178, 1264, 1454	EuroLine	0556	Gradiente.....	0053, 0056, 0170
Denon.....	0145, 0511	Euroman	0037, 0217	Graetz.....	0037, 0714
Denstar.....	0628	Europa	0037	Granada.....	0037, 0108, 0146, 0208, 0217, 0226, 0548, 0560
Denver.....	0037, 0587, 0606, 1189	Europhon.....	0217	Grandin.....	0037, 0282, 0714, 1037
Desmet.....	0037	Evolution.....	1756	Grundig.....	0037, 0195, 0370, 0443, 0556, 0587, 0672, 0683, 0706
Diamant.....	0037	Exquisit.....	0037	Grunpy.....	0179, 0180
Diamond.....	0037, 0672, 0698, 0706	Fagor	0037	H&B	0808
Dick Smith Electronics	0698	Feilu.....	0817	Haaz	0706
Digatron.....	0037	Feiyue.....	0817	Haier	0037, 0508, 0587, 0698, 0768, 1034
Digital Life	0780, 0872	Ferguson	0037, 0053, 0335, 0443, 0548, 0560, 0625	Haiyan.....	0817
Digitor.....	0037, 0698	Fidelity	0037, 0171, 0512	Halifax.....	0217
Digix	0880	Filsai	0217	Hallmark	0178
DiK.....	0037	Finlandia	0208, 0548	Hammerstein	0060
Dixi	0037	Finlux.....	0037, 0179, 0217, 0480, 0556, 0606, 0629, 0631, 0714, 0808	Hampton.....	0217
DL.....	0037, 0780, 0872	Firstar	0236	Hankook	0019, 0030, 0056, 0178, 0180, 0628
Domeos.....	0037, 1037	Firstline.....	0037, 0208, 0217, 0556, 0587, 0714, 0808, 1037	Hanseatic.....	0037, 0195, 0217, 0282, 0556, 0634, 0661, 0714, 0808
Dream Vision	1704	Fisher.....	0047, 0154, 0157, 0159, 0208, 0217, 0370	Hantarex	0037, 0865
DSE	0698	Flint.....	0037	Hantor.....	0037
Dual	0037, 0217	Formenti	0037		
Dual Tec.....	0217	Fortress	0093		
Dumont	0017, 0019	Fraba	0037, 0370		
		Friac.....	0037, 0370		
		Frontech	0217		

Harley Davidson.....	0179	Interbuy	0037, 0512	Kongque.....	0817
Harman/Kardon.....	0054	Interfunk	0037, 0512	Konka	0037, 0282, 0587, 0628, 0632, 0638, 0703, 0707, 0714, 0754, 0817
Harsper.....	0865	Internal	0037	Korpel	0037
Harvard.....	0180	Intervision.....	0037, 0217, 0282, 0370, 0486	KTV.....	0030, 0039, 0180, 0185, 0217, 0280
Harwood.....	0032, 0037	IR.....	0032, 0037, 0093, 0108, 0146, 0157, 0195, 0217, 0226, 0370, 0512, 0556	Kunlun	0051, 0208, 0226, 0661, 0817
Havermy.....	0093	IRT.....	0451, 0628, 0698, 1661	Kyoshu.....	0032
HCM.....	0037, 0217, 0282, 0606	Isukai.....	0037, 0282	Kyoto	0032, 0217
Helios	0865	ITC.....	0217	L&S Electronic.....	0714, 0808
Hello Kitty.....	0451	ITT	0179, 0208, 0480, 0548	LaSAT	0486
Hema.....	0217	ITT Nokia.....	0179, 0208, 0480, 0548, 0606	Lecson.....	0037
Hher.....	0714	ITV	0037	Lemair.....	0032
Himitsu	0180, 0628	Janeil.....	0046	Lenco.....	0037, 1037
Hinari.....	0037, 0179	JBL	0054	Levis Austria.....	0037
Hisawa.....	0282, 0714	JCB.....	0000	Leyco.....	0037
Hisense	0037, 0145, 0156, 0208, 0508, 0512, 0556, 0706, 0748, 0780, 1156	Jean.....	0003, 0051, 0092, 0156, 0179, 0236	LG.....	1265, 1178, 0856, 0714, 0700, 0698, 0644, 0606, 0556, 0442, 0178, 0108, 0060, 0056, 0039, 0038, 0037, 0032, 0030, 0019, 0003, 0001
Hitachi	0217, 0381, 0480, 0481, 0508, 0512, 0548, 0578, 0629, 0634, 0719, 1037, 1045, 1145, 1150, 1156, 1225, 1245, 1256, 0016, 0019, 0027, 0030, 0032, 0037, 0038, 0039, 0056, 0092, 0108, 0145, 0151, 0156, 0157, 0165, 0178, 0179, 0186	Jensen.....	0698, 0706, 0761, 0815, 0817	Liesenk & Tter.....	0037
Hitachi Fujian.....	0037, 0108, 0145, 0150	Jiahua.....	0051	Liesenkotter.....	0037
Home Electronics.....	0606	Jinfeng.....	0051, 0208, 0226, 0817	Lifotec.....	0037, 0714, 1037
Hongmei.....	0093, 0817	Jinque.....	0817	Lihua.....	0817
Hongyan.....	0817	Jinxing.....	0037, 0054, 0145, 0156, 0556, 0698, 0817	Lloyd's	0001
Hornophon	0037	JMB	0443, 0556, 0634	Lloytron.....	0032
Hoshai	0282	JNL.....	0698	Loewe.....	0037, 0136, 0512, 0633, 0790
Hua Tun	1150	Jubilee	0556	Logik.....	0001, 0016, 0060, 0698, 0706, 0880
Huafa.....	0145	Juhua.....	0817	Longjiang.....	0817
Huanghe.....	0817	JVC.....	0053, 0093, 0463, 0508, 0606, 0653, 0683, 0731, 1172, 1253	Luma.....	1037
Huangshan	0817	Kaige	0817	Lumatron	0217
Huanyu.....	0817	Kaisui.....	0037, 0217, 0282	Lux May.....	0037, 0556
Huari.....	0145	Kambrook.....	0217, 0556	Luxman.....	0056
Hugoson.....	0890	Kangli	0001, 0661, 0817	Luxor	0179, 0208, 0217, 0480, 0548, 0631, 1037, 1163
Huodateji.....	0051	Karcher.....	0037, 0282, 0606, 0714	LXI	0047, 0054, 0154, 0156, 0178
Hyper.....	0217	Kathrein.....	0556	M & S.....	0054
Hypson	0037, 0282, 0714, 1037	Kaypani	0052	M Electronic.....	0037, 0217, 0480
Hyundai	0037, 0698, 0706, 0849, 0865	KEC	0180	Madison.....	0037
Iberia	0037	Kendo.....	0037, 0512	Magnavox.....	0020, 0024, 0030, 0037, 0054, 0096, 0179, 0186, 0187, 0386, 0706, 0780, 0802, 1198, 1254, 1454
ICE.....	0217, 0556	Kennex	1037	Magnum	0037, 0606, 0714
Imperial.....	0037, 0370	Kenwood	0019, 0030	Majestic	0016
Imperial Crown	0001, 0661	KIC.....	0217	Manesth.....	0037, 0217
Indiana.....	0037	Kiota	0001	Manhattan	0037, 1037
Infinity.....	0054	Kioto	0054, 0556, 0706	Marantz.....	0030, 0037, 0054, 0556, 0704, 0854, 0855, 1154, 1454
Ingelen.....	0714	Kiton	0037	Mark	0037, 0217, 0486, 0714
Inno Hit.....	0037, 0217, 0282	KLH	0765, 0767	Masuda.....	0037, 0217
Innova.....	0037	KLL	0037		
Innowert	0865	Kloss.....	0024, 0046		
Inteq.....	0017	Kneissel.....	0037, 0556		
		Kolin	0053, 0108, 0150, 0180, 1150		

Materin	0208	Nansheng	0817	Palsonic.....	0001, 0037, 0217, 0698
Matsui.....	0037, 0177, 0195, 0208, 0217, 0335, 0443, 0556, 0629, 0714, 1037	NAT	0226	Panama	0037, 0217
Matsushita.....	0051, 0250, 0650	National	0051, 0055, 0208, 0226, 0508	Panashiba.....	0001
Matsuyama.....	0587	NEC	1704, 1182, 1150, 0882, 0817, 0704, 0661, 0603, 0508, 0497, 0381, 0217, 0186, 0178, 0170, 0165, 0156, 0154, 0056, 0053, 0051, 0046, 0030, 0019	Panasonic.....	1650, 1410, 1177, 1175, 1168, 0853, 0650, 0548, 0508, 0250, 0226, 0208, 0108, 0055, 0054, 0051, 0037
Maxent	1755	Neckermann	0037, 0370, 0512, 0556	Panavision	0037
Mediator	0037	NEI.....	0037	Panda	0051, 0208, 0226, 0508, 0698, 0706, 0780, 0817
Medion	0037, 0512, 0556, 0698, 0714, 0808, 0880, 1037, 1248	Neovia	0865	Pathe Cinema.....	0370
Megapower	0700	Nesco	0179	Penney.....	0003, 0018, 0019, 0021, 0027, 0030, 0032, 0039, 0047, 0051, 0056, 0060, 0135, 0156, 0178, 1347
Megatron.....	0003, 0145, 0178	Netsat.....	0037	Perdio	0037, 0282
MEI.....	0185, 1037	NetTV.....	1755	Phase.....	0032
Meile.....	0817	Network.....	0032	Philco.....	1661, 0774, 0628, 0463, 0451, 0370, 0186, 0180, 0178, 0145, 0096, 0092, 0056, 0054, 0037, 0032, 0030, 0020, 0019
Melectronic.....	0037, 0195, 0217, 0480, 0512, 0634, 0661, 0714	Neufunk.....	0037, 0556, 0714	Philex	0548
Memorex	0016, 0056, 0060, 0150, 0154, 0178, 0179, 0250, 0463, 1037	New Tech.....	0217	Philips	1756, 1454, 1154, 0774, 0690, 0556, 0512, 0187, 0186, 0178, 0108, 0092, 0080, 0056, 0054, 0051, 0037, 0032, 0030, 0027, 0024, 0020, 0019, 0017, 0000
Mercury	0001, 0060, 0556, 0706	Newave.....	0092, 0093, 0178, 1150	Phoenix.....	0037, 0486
Mermaid	0037	Nikkai.....	0032, 0037, 0217	Phonola	0037, 0080
Metronic	0625	Nikko	0030, 0092, 0178	Pilot	0019, 0030, 0037, 0039, 0706
Metz	0037, 0388, 0447, 0587, 0746	Noblex	0154, 0180	Pioneer	0037, 0038, 0166, 0170, 0486, 0512, 0679, 0760, 0866, 1260
MGA	0019, 0030, 0037, 0150, 0178	Nokia	0179, 0208, 0480, 0548, 0606, 0631	Pionier	0486
Micromaxx.....	0037, 0808, 1037	Norcent.....	0748, 0824	Playsonic	0037, 0217, 0714
Microstar	0808	Nordic.....	0217	Polaroid	0765, 0865, 1276
MicroTEK.....	0706	Nordmende	0037, 0195, 0335, 0560, 0714	Polytron	0282
Midland	0017, 0032, 0039, 0047, 0051, 0135	Normerel.....	0037	Portland.....	0019, 0039, 0092
Minato	0037	Noshi	0018	Powerpoint	0037
Minerva.....	0108	Novak	0037	Premier	0037
Minutz.....	0021	Novatronic	0037	Prima	0761, 0783, 0815, 0817
Mitsubishi.....	1250, 1182, 1171, 1150, 1037, 0868, 0836, 0817, 0556, 0512, 0381, 0250, 0236, 0208, 0180, 0179, 0178, 0154, 0150, 0108, 0093, 0056, 0037, 0030, 0019	NTC	0092	Princess.....	0698
Mivar	0217, 0370, 0609	Nu-Tec.....	0037, 0698, 0706	Princeton	0700, 0717
Monivision	0700, 0843	Oceanic	0208, 0548	Prinston	1037
Morgan's	0037	Okano.....	0037, 0370	Prism	0051
Motorola.....	0055, 0093	Omni.....	0698, 0706, 0780, 0872	Profex	0370
MTC.....	0019, 0030, 0056, 0060, 0185, 0370, 0512	Onimax	0714	Profitronic.....	0037
MTEC	0032	Onking	0280	Proline.....	0037, 0556, 0625, 0634
MTLogic	0714	Onwa	0180, 0602	Proscan	0047, 1347, 1447
Mudan	0051, 0208, 0226, 0817	Optimus.....	0154, 0166, 0250, 0650	Prosonic	0037, 0217, 0451, 0714
Multitec	0037, 0486, 1037	Optoma	0887	Protech	0037, 0180, 0217, 0486, 1037
Multitech	0037, 0180, 0217, 0486, 0556	Optonica.....	0093, 0165	Proton.....	0001, 0003, 0030, 0039, 0052, 0056, 0178, 0466, 0644
Murphy.....	0039	Orion.....	0037, 0177, 0179, 0236, 0443, 0463, 0556, 0606, 0714, 0880, 1463	ProVision	0037, 0556, 0714
Musikland.....	0037	Online.....	0037	Pulsar.....	0017, 0019
Myryad	0556	Ormond	1037		
NAD.....	0156, 0178, 0866	Osaki	0032, 0037, 0217, 0556		
Naiko	0037, 0606	Osume.....	0032, 0037, 0157		
		Otto Versand	0037, 0093, 0217, 0226, 0512, 0556		
		Pacific.....	0037, 0556, 0714, 1037		
		Palladium.....	0037, 0370, 0714		

Pye	0037, 0556	Samsux	0039	Simpson	0186, 0187
Qingdao.....	0051, 0208, 0226, 0817	Sandra.....	0217	Singer	0335, 0548, 0698, 0706, 1537
Qualcraft.....	0039	Sansei.....	0451	Sinotec	0706
Quasar.....	0051, 0055, 0165, 0250, 0650, 0865	Sansui.....	0037, 0463, 0587, 0602, 0698, 0706, 0714, 1537	Sinudyne.....	0177
Quelle	0037, 0512, 1037	Sanyo	1154, 1150, 1142, 0893, 0799, 0798, 0556, 0508, 0486, 0381, 0370, 0280, 0217, 0208, 0180, 0159, 0157, 0156, 0154, 0146, 0145, 0108, 0088	SKY.....	0037, 0282
Questa.....	0032	Sanyuan	0093, 0817	Skygiant.....	0180
R-Line.....	0037	SBR	0037, 0556	Skyworth	0037, 0698, 0748, 0817
Radiola	0037, 0217, 0556	Schaub Lorenz	0037, 0486, 0548, 0606, 0714	Sliding.....	0865
Radiomarelli	0037	Schneider	0037, 0217, 0556, 0714, 1037	SLX.....	0512
RadioShack.....	0019, 0030, 0032, 0037, 0039, 0047, 0056, 0154, 0165, 0178, 0180	Scimitsu.....	0019	Soemtron.....	0865
Radiotone.....	0037, 1037	Scotch	0178	Solavox.....	0032, 0037, 0548
Rank Arena.....	0157, 0602	Scott.....	0019, 0178, 0179, 0180, 0236	Sole	0813
RCA	1547, 1454, 1447, 1347, 1247, 1147, 1047, 0679, 0625, 0618, 0560, 0178, 0135, 0093, 0092, 0090, 0060, 0051, 0047, 0038, 0030, 0019, 0018, 0000	Sears	0047, 0054, 0056, 0146, 0154, 0156, 0159, 0171, 0178, 0179	Soniko	0037
Realistic.....	0019, 0030, 0032, 0039, 0056, 0154, 0165, 0178, 0180	Seaway.....	0556, 0634	Sonitron	0208, 0217, 0370
Recor.....	0037	Seelver.....	1037	Sonoko	0037, 0282
Rediffusion	0548	SEG	0037, 0217, 0634, 1037, 1163	Sonolor	0208, 0282, 0548
Reflex	0037, 1037	SEI.....	0177	Sontec	0037, 0370
Relisys.....	0865	Sei-Sinudyne.....	0037	Sony	1651, 1505, 1300, 1167, 1100, 1010, 0834, 0650, 0250, 0170, 0157, 0156, 0150, 0145, 0111, 0093, 0080, 0053, 0037, 0000
Reoc.....	0714	Semivox.....	0180	Soundesign	0178, 0179, 0180, 0186
Revox	0037	Semp	0156, 1356	Soundwave.....	0032, 0037
RFT	0037, 0370	Serino	0093	Sowa.....	0051, 0060, 0092, 0156, 0178, 0226, 1150
Rhapsody.....	0185	Shancho	0817	Spectricon	0003
Ricoh	0037	Shanghai	0208, 0226, 0817	Squareview.....	0171
Rinex	0698	Shaofeng.....	0145, 0817	Ssangyong.....	0032
Roadstar.....	0037, 0282, 0714, 1037, 1189	Sharp.....	1193, 1165, 0851, 0818, 0787, 0720, 0689, 0688, 0650, 0491, 0386, 0165, 0157, 0093, 0053, 0039, 0032, 0030	SSS.....	0019, 0180
Rowa	0037, 0217, 0556, 0587, 0698, 0748, 0817	Shen Ying.....	0003, 0092, 0179	Stag	0032
Royal Lux	0335	Shencai.....	0145	Standard.....	0037, 0217, 1037
Runco.....	0017, 0030, 0497, 0603	Sheng Chia.....	0093, 0179, 0236, 1150	Starlite	0037, 0180
Ruyi	0817	Shenyang	0817	Stenway.....	0282
Saba	0250, 0335, 0548, 0560, 0625, 0714	Shintoshi.....	0037	Strato.....	0037
Sagem	0830	Shivaki.....	0037, 0178, 0443, 0451	Studio Experience	0843
Saige	0817	Shogun.....	0019	Sunic Line.....	0037
Saisho	0177, 0217, 0556	Shorai	0179	Sunkai.....	0037
Saivod	0037, 1037	Show	0706	Sunstar	0037
Salora	0208, 0480, 0548, 0606, 0631	Siemens.....	0032, 0037, 0146, 0157, 0195	Sunwood	0037
Salsa.....	0335	Siesta.....	0370	Superscan	0864
Sampo.....	0030, 0032, 0039, 0052, 0092, 0093, 0154, 0171, 0178, 0650, 0700, 1755	Signature	0016	Supersonic	0037, 0208, 0698, 1189
Samsung	1150, 1060, 0817, 0814, 0812, 0774, 0766, 0718, 0702, 0682, 0644, 0618, 0587, 0556, 0370, 0226, 0019, 0030, 0032, 0037, 0039, 0056, 0060, 0090, 0092, 0093, 0154, 0156, 0178, 0179, 0195, 0208, 0217	Silva.....	0037	SuperTech	0037
		Silva Schneider.....	0037	Supra.....	0039, 0056, 0178
		Silver.....	0037, 0179	Supre-Macy.....	0046
		SilverCrest.....	1037	Supreme	0000
				Susumu	0335
				SVA.....	0587, 0698, 0748, 0768, 0865, 0870, 0871, 0872
				Sylvania	0020, 0030, 0054, 0096, 0171, 0381
				Symphonic	0171, 0180

DEVICE CODES

TV

Synco	0000, 0060, 0092, 0093, 0178, 0451	Texet	0217	Videotechnic.....	0217
Sysline.....	0037	ThemeScene	0887	Vidikron.....	0054
T+A.....	0447	Thompson	0625	Vidtech.....	0019, 0178
Tacico	0092, 0178, 0179, 1150	Thomson	0037, 0335, 0560, 0625, 1447	Viewsonic	0857, 0864, 0885, 1755
Tai Yi.....	1150	Thorn	0037, 0335, 0512	Viking.....	0046
Taishan	0817	Tiane.....	0093, 0817	VInc.....	1756
Tandy.....	0039, 0093, 0217	TMK.....	0056, 0177, 0178	Vision	0032, 0037, 0217
Targa.....	0702	TML	1756	Vistar.....	0548
Tashiko	0032, 0092, 0146, 0217, 0650, 1150	TNCi	0017	Vizio	0864, 0885, 1756
Tatung.....	0003, 0037, 0051, 0054, 0055, 0060, 0154, 0156, 0217, 0556, 0629, 1150, 1156, 1254, 1756	Tobo.....	0748	Voxson.....	0178
TCL.....	0698, 0706, 1537	Tokai	0037, 1037	Waltham.....	0037, 0217, 0443, 1037
TCM.....	0714, 0808	Tokaido.....	1037	Wards	1347, 1156, 1147, 0866, 0187, 0186, 0180, 0179, 0178, 0166, 0165, 0156, 0154, 0135, 0111, 0096, 0000, 0016, 0017, 0018, 0019, 0020, 0021, 0024, 0027, 0030, 0047, 0051, 0054, 0055, 0056, 0060, 0080
Teac	0037, 0170, 0171, 0178, 0217, 0282, 0512, 0556, 0698, 0706, 0714, 1037, 1755	Tomashi	0282	Warumaia.....	0661
Tec.....	0037, 0217	Tongtel.....	0587, 0780	Watson	0037, 1037
Tech Line	0037	Tophouse.....	0180	Waycon.....	0156
Technics	0051, 0250, 0556, 0650	Toshiba	1704, 1656, 1508, 1356, 1265, 1256, 1169, 1156, 1150, 0845, 0832, 0718, 0714, 0650, 0644, 0618, 0556, 0508, 0381, 0217, 0195, 0156, 0154, 0145, 0093, 0060	Wega.....	0037
TechniSat.....	0037, 0556	Tosonic	0185	Wegavox.....	0037
Technisson	0714	Totevision	0039	Welltech.....	0714
Technol Ace.....	0179	Towada	0217	Weltblick.....	0217
Technosonic	0556	Toyoda.....	0037	Westinghouse.....	0003, 0451, 0889, 0890
Techview.....	0847	Trakton.....	0217	Weston.....	0037
Techwood.....	0003, 0051, 0056, 1163	Trans Continens	0037, 0217, 1037	Wharfedale	0037, 0556, 0706
Tecnimagen	0556	Transonic.....	0037, 0512, 0587, 0698, 0780	White Westinghouse.....	0037, 0186, 0463, 0623
Teco.....	0051, 0092, 0093, 0178, 0280, 0653	Triad.....	0037, 0556	Windsor	1037
Tedalex	0037, 0208, 0217, 0556, 0606, 0706, 1537	Trical	0157	Windstar	0282
Tek.....	0706	Triumph.....	0177, 0556	Windy Sam	0556
Teknika	0016, 0019, 0039, 0054, 0056, 0060, 0092, 0150, 0179, 0180, 0186	Tsoschi	0282	Wintel.....	0714
Telecor.....	0037	Tuntex.....	0030, 0092	World-of-Vision.....	0880, 0890
Telefunken	0037, 0056, 0335, 0486, 0560, 0587, 0625, 0698, 0702, 0706, 0714	TVS.....	0463	Xenius.....	0634, 0661
Telefusion	0037	TVTEXT 95.....	0556	Xiahua.....	0698, 0817
Telegazi	0037, 0556	Uher.....	0037, 0480, 0486	Xihu.....	0817
Telesonic	0037	Ultravox	0037	XLogic.....	0698
Telestar.....	0037, 0556	Unic Line	0037	XMS.....	0698
Teletech	0037, 1037	United	0037, 0606, 0714, 1037	Xrypton	0037
Teleton.....	0186, 0217	Universal.....	0027, 0037	Yamaha.....	0019, 0030, 0650, 0769, 0833, 0839
Televue.....	0037	Universum	0032, 0037, 0146, 0157, 0170, 0177, 0217, 0370, 0480, 0512, 0556, 0618, 0631, 1037	Yamishi	0217, 0282
Tempest.....	0037, 0556	Univox	0037	Yapshe.....	0250
Tennessee	0037	V2max	0865	Yokan.....	0037
Tensai	0037, 0217, 0556, 1037	V7 Videoseven.....	1755	Yoko.....	0037, 0217
Tera.....	0030, 0092, 0466	V7Videoseven.....	0880	Yoshita.....	0706
Tesla	0037	Vector Research	0030	Youlanasi	0817
Tevion	0556, 0714, 0767, 1037, 1248	Vestel.....	0037, 0217, 0556, 1037, 1163	Zenith.....	0016, 0017, 0092, 0178, 0463, 1145
		Victor	0053, 0250, 0650, 0653	Zenor	0208
		Videocon	0508	Zonda	0003, 0698

CBL

Cable box

ABC.....	0001, 0003, 0007, 0008, 0011, 0013, 0014, 0017, 0237
ADB.....	1063, 1230, 1269
Aichi Denshi.....	1512
Alcatel.....	0896
Allegro.....	0153, 0315
Americast.....	0899
Amstrad.....	1222
Antronix.....	0022, 0207
Archer.....	0022, 0153, 0207, 0797
Auna.....	1230, 1269
Austar.....	0012, 0276
Belcor.....	0056
Bell & Howell.....	0014
Bell South.....	0899
Birmingham Cable Communications.....	0276
British Telecom.....	0003
Cable & Wireless.....	1068
Cable Star.....	0056
Cabletenna.....	0022
Cableview.....	0022
Century.....	0153
Citizen.....	0153, 0315
Clearmaster.....	0883
ClearMax.....	0883
Colour Voice.....	0025, 0031
Comcast.....	1376
Comtronics.....	0040
Contec.....	0019
Coolmax.....	0883
Daeryung.....	0008, 0477, 0877, 1877
Digeo.....	1187
Digi.....	0637
Director.....	0476
Dumont.....	0637
DX Antenna.....	1500
Eastern.....	0002
Emerson.....	0797
Everquest.....	0015, 0040
Focus.....	0400
Foxtel.....	1222
France Telecom.....	0817, 0896
Freebox.....	1482
Fujitsu.....	1497
Funai.....	0019
Galaxi.....	0008

Garrard.....	0153
GC Electronics.....	0056, 0207
GE.....	0237
Gehua.....	0476
Gemini.....	0015, 0797
General Instrument.....	0003, 0011, 0014, 0015, 0276, 0476, 0810
GMI.....	0015, 0797
Golden Channel.....	1063, 1110
GoldStar.....	0040, 0144
Goodmind.....	0797
Hamlin.....	0009, 0020, 0034, 0259, 0273
Hitachi.....	0011, 0014
Hytex.....	0007
i3 Micro.....	1602
Jasco.....	0015, 0153, 0315
Jebsee.....	0400
Jerrold.....	0003, 0011, 0012, 0014, 0015, 0276, 0476, 0810
KNC.....	0008
Leon.....	0015
LG.....	0040, 0144
Linsay.....	0440
Macab.....	0817
Madritel.....	1230
Magnavox.....	0014, 0027
Maspro.....	1510
Memorex.....	0000
MNET.....	0019
Motorola.....	0014, 0276, 0476, 0810, 1106, 1187, 1254, 1376, 1483
Movie Time.....	0063, 0156
Mr Zap.....	1112
Mr. Zap.....	1112
MS.....	0015
Multichoice.....	0019
Multitech.....	0883
MultiVision.....	0012
Myrio.....	1602
NEC.....	1496
Nokia.....	1569
Noos.....	0817, 1624
Novaplex.....	0618
NSC.....	0063, 0156
NTL.....	0003, 1060, 1068
Oak.....	0007, 0019
Ono.....	1068
Optimus.....	0021
Optus.....	0276, 1060
Pace.....	0008, 0237, 1060, 1068, 1577, 1877

Panasonic.....	0000, 0008, 0021, 0040, 0107, 0375, 1488
Panther.....	0637
Paragon.....	0000
Philips.....	0013, 0025, 0027, 0031, 0153, 0317, 0817, 1305
Pioneer.....	0144, 0533, 0877, 1021, 1500, 1877
Popular Mechanics.....	0400
Pulsar.....	0000
PVP Stereo Visual Matrix.....	0003
Quasar.....	0000
Quiero.....	0817
RadioShack.....	0015, 0315, 0797, 0883
RCA.....	0021, 1256
Realistic.....	0207
Recoton.....	0400
Regal.....	0020, 0259, 0273, 0279
Regency.....	0002
Rembrandt.....	0011
Runco.....	0000
Sagem.....	0817, 1089, 1112
Salora.....	0000
Samsung.....	0000, 0040, 0144, 1060, 1666
Satbox.....	0375
Scientific Atlanta.....	0008, 0017, 0237, 0477, 0877, 1510, 1877
Seam.....	0510
Sejin.....	1602
Signal.....	0015, 0040
Signature.....	0011
SL Marx.....	0040
Sony.....	1006, 1460
Sprucer.....	0021
Starcom.....	0003, 0014, 0015
Stargate.....	0015, 0040, 0797
Starquest.....	0015
STS.....	0156
Suena Madritel.....	1230
Sumitomo.....	1500
Supercable.....	0276
Supermax.....	0883
Sylvania.....	0001
Tadiran.....	0040
Tandy.....	0258
Teleview.....	0040
Telewest.....	1068
Texscan.....	0001
TFC.....	0310
Thomson.....	1110, 1256
Time Warner.....	1877

Timeless	0040
Tocom.....	0012, 0013
Torx.....	0003
Toshiba.....	0000, 1509
Trans PX.....	0153, 0276, 0315
TransACT.....	1106
Tri-Vision.....	1257
Tristar.....	0883
TS.....	0003
Tusa.....	0015
TV86.....	0063
Unika.....	0022, 0153, 0207
United Artists.....	0007
United Cable	0003
Universal	0022, 0056, 0153, 0191, 0207
US Electronics.....	0276
V2.....	0883
Viewmaster.....	0883
Viewstar.....	0027, 0063, 0258
Vision.....	0883
Vortex View.....	0883
Zenith	0000, 0008, 0525, 0899
Zentek	0400

SAT

Satellite receiver

@sat.....	1300
@Sky	1334
ABsat.....	0713
ADB.....	1259, 1367, 1473, 1491
Aiwa.....	1514
Akai	0200
Alba	0713
Allsat.....	0200, 1017, 1043
Alltech	0713
Allvision	1232, 1334, 1412
AlphaStar.....	0772
Amino	1615
Amitronica	0713
Amstrad.....	0713, 0795, 0847, 1175
Anglo	0713
Ankaro	0713, 1279
AntSat	1017
Arcon.....	1043, 1075, 1279
Arcus.....	1143
Arnion.....	1300
Asat	0200
ASCI.....	1334

ASLF.....	0713
AssCom.....	0853
Aston	1129, 1261
Astra	0713
Astro	0133, 0173, 0658, 1099, 1100
Atsat	1300
AtSky	1334
Audioline.....	1429
Austar	1259
Axis.....	1111
Bentley Walker	1017
Black Diamond.....	1284
Blaupunkt	0173
Blue Sky	0713
Boca	0713, 1232, 1366
Brainwave.....	1294
British Sky	0847, 1175, 1847 Broadcasting
Broco.....	0713
BskyB	0847, 1175
Bubu Sat	0713
Bush	1284, 1471
Canal Digital	0853
Canal Satellite	0853, 1339, 1853
Canal+	0853
CanalSatellite	0853, 1339
Centrex.....	1457
Century.....	0856
Chaparral.....	0216
Chess	0713, 1334
CityCom	0299, 1075, 1176, 1232
CNS.....	1367
Comag.....	1169, 1232, 1366, 1412
Coship	1457
Crossdigital	1109
Cyfra+.....	1076
Cyrus	0200
D-box	0723, 0873
Daewoo	0713, 1111, 1296
Deltasat	1075
Dgtec.....	1242
Digatron.....	1294
Digena	1100
Digenius.....	0299, 1161
Digipro	1105
Digiturk	1076
DirectV	1856, 1749, 1640, 1639, 1609, 1444, 1443, 1442, 1414, 1392, 1377, 1142, 1109, 1108, 1076, 0819, 0749, 0724, 0639, 0566, 0392, 0247, 0099

Dish Network	0775, 1005, 1170, 1505, 1775
Dishpro	0775, 1005, 1505, 1775
Distratel	1283
Distrisat	0200
DMT.....	1075
DNT	0200
Dream Multimedia	1237, 1437, 1637
DX Antenna.....	1530
Echostar	0167, 0280, 0610, 0713, 0775, 0853, 1005, 1169, 1170, 1200, 1323, 1409, 1467, 1477, 1505, 1775
Einhell	0713
Elap.....	0713, 1129
Elsat.....	0713
Elta.....	0200
eMTech.....	1214
Engel.....	0713, 1017
EuroLine	1251
Europhon	0299
Eurosky.....	0299
Eutelsat.....	0713
Expressvu	0775, 1775
Fenner	0713
Ferguson.....	1291
Flair Mate.....	0713
Fortec Star.....	1017, 1293, 1550
Foxtel.....	1176, 1356
Freecom	0173
FTEmaximal	0713, 1449, 1556
Fuba	0173, 0299, 1161, 1214
Fugionkyo.....	1105
Galaxis.....	0853, 1111, 1557
Garnet.....	1075
GbSAT	1214
GE.....	0392, 0566
Gecco	1273, 1412
General Instrument.....	0869
GF.....	1043
GF Star	1043
Globo.....	1251
GOD Digital.....	0200
GOI	0775, 1775
Goldbox.....	0853
Golden Interstar.....	1283
Goldvision.....	1017
Goodmans.....	1246, 1284
Gradiente.....	0099, 0856
Grundig.....	0173, 0750, 0847, 0853, 1150, 1291, 1330, 1335
Hanseatic.....	1099, 1100

Hauppauge.....	1294	Marantz	0200	Panasonic.....	0247, 0701, 0847, 1104, 1304, 1320, 1404, 1508, 1526
HB	1214	Maspro	0173, 0713, 0750, 1520, 1530	Panda	0173
HDT	1159	Mastec.....	1334	Pansat	1159, 1551
Hirschmann	0173, 0299, 1111	Matsui.....	0173, 1284	Paysat.....	0724
Hisense	1535	Maximum.....	1075, 1334	Philips	1749, 1442, 1142, 1118, 1114, 1076, 0856, 0853, 0819, 0750, 0749, 0724, 0722, 0200, 0173, 0133, 0099
Hitachi	0819, 1250, 1284, 1518, 1523, 1525	Mediacom	1206	Phoenix.....	1273
Homecast.....	1214	MediaSat	0853	Phonotrend.....	1017, 1200
HTS	0775, 1775	Medion	0299, 0713, 1043, 1075, 1161, 1232, 1334, 1412	Pilotime.....	1339
Hughes	0749, 0819, 1442, 1749	Medison.....	0713	Pino	1334
Hughes Network Systems	0749, 1142, 1442, 1443, 1444, 1749	Mega	0200	Pioneer	0329, 0352, 0853, 1308, 1442
Humax.....	1176, 1427, 1568, 1648, 1670, 1675	Memorex	0724	Preisner	1366
Huth.....	1017, 1075	Metronic	0713, 1279, 1283, 1334	Premiere	0723, 0873, 1429
Hyundai	1075, 1159	Metz.....	0173	Prima	0795
iCan	1367	Micro	0713, 1294	Primacom	1111
ID Digital.....	1176	Micro electronic.....	0713	Prod.....	0639, 0723, 0873
ILLUSION sat	1557	Micromaxx.....	0299	Proscan	0392, 0566
iLo	1535	Microstar	1075	Protek	1567
Imperial.....	1429	Microtec	0713	Proton.....	1535
Innova.....	0099	Mitsubishi	0749, 0819	QNS.....	1367, 1404
Interstar	1017, 1105, 1214	Morgan's.....	0200, 0713, 1232	Quelle	0299
IR.....	0173, 0282	Motorola	0856, 0869	Radiola	0200
Jaeger	1334	Myryad	0200	RadioShack	0869
Jerrold	0869	Mysat.....	0713	RCA	0143, 0392, 0566, 0855, 1291, 1392
JVC.....	0775, 1170, 1507, 1531, 1532, 1775	NEC	1270, 1519	Realistic	0052
K-SAT	0713	NEOTION.....	1334	Rebox	1214
Kamm.....	0713	Netgem.....	1322	Regal	1251
Kaon.....	1300	Netsat	0099	RFT	0200
KaTelco.....	1111	Neuhaus	0713	Roadstar	0713, 0853
Kathrein	0173, 0200, 0249, 0658, 0713, 1057, 1221, 1416, 1561, 1567	Neuling	1232	Rover	0713
Kenwood.....	0853	Neusat	0713, 1279, 1334, 1409	S-ZWO.....	1207
Koscom	1043, 1334, 1409	Neveling.....	1161	SAB	1251
Kreiling	0249, 0658	Next Level	0869	Sagem	0820, 1114, 1253, 1307, 1690
Kreiselmeier.....	0173	NextWave.....	1017, 1143, 1551	Samsung	0853, 1017, 1108, 1109, 1206, 1243, 1244, 1276, 1293, 1343, 1377, 1442, 1458, 1570, 1609
L&S Electronic.....	1043, 1334	Nikko	0200, 0713	Sanyo	1219
Labgear	1296	Nokia	0723, 0751, 0853, 0873, 1023, 1223, 1311, 1312, 1723	Sat Control	1300
LaSAT	0173, 0299	Nordmende	1611	Sat Cruiser.....	1143
Lenco	0713	OctalTV.....	1294, 1505	Sat Team.....	0713
Lenoxx.....	1611	Opentel.....	1232, 1412	Satec	0713
LG.....	1075, 1226, 1414	Optex.....	1043, 1283	Satelco	1232
Lifesat.....	0299, 0713, 1043	Optus.....	1143	Satplus	1100
Lodos	1284	Orbis.....	1334	Schaub Lorenz	1214
Logix.....	1017, 1075	Orbitech.....	1099, 1100	Schneider	1206, 1251
Lorenzen.....	0299, 1161, 1294	Pace	0200, 0241, 0329, 0795, 0847, 0853, 1175, 1323, 1356, 1423, 1623	Schwaiger.....	1075, 1111, 1334, 1457
M vision	1557	Packard Bell	1111	SCS	0299
Magnavox.....	0722, 0724	Palcom	0299, 1161		
Manata	0713	Panarex	1159		
Manhattan	1017				

SAT

Sedeae Electronique..... 1105, 1206, 1283
 SEG..... 1075, 1251
 Serino..... 0610
 Servi Sat..... 0713
 ServiSat..... 1251
 Sharp..... 1489, 1517
 Siemens..... 0173, 1657
 Silva..... 0299
 Skantin..... 0713
 SKR..... 0713
 SKT..... 1449
 SKY..... 0099, 0847, 0856, 1175, 1847, 1848, 1856
 SKY Italia..... 1847, 1848
 Sky XL..... 1251, 1412
 Sky+..... 1175
 Skymaster..... 0713, 1075, 1200, 1409, 1611
 Skymax..... 0200
 Skyplus..... 1232, 1334, 1409, 1412
 SkySat..... 0713
 Skyvision..... 1334
 SL..... 0299, 1294
 SM Electronic..... 0713, 1200, 1409
 Smart..... 0299, 0713, 1232, 1273
 Sony..... 0282, 0639, 0847, 0853, 1524, 1558, 1639, 1640
 Star Choice..... 0869
 Starlite..... 0200
 Stream..... 1847, 1848
 Strong..... 0853, 1105, 1159, 1258, 1300, 1409, 1430
 Sunny..... 1300
 Sunsat..... 0713
 Supermax..... 1143, 1283
 TCL..... 1143
 Teac..... 1251, 1322
 TechniSat..... 0200, 1099, 1100, 1195, 1322
 Technomate..... 1283
 Technosat..... 1143, 1206
 Technotrend..... 1429
 Techsan..... 1017
 Techwood..... 1284
 tekComm..... 1017
 Teleciel..... 1043
 Teleka..... 0750
 Telestar..... 1099, 1100, 1251, 1334
 Telesystem..... 1251
 Televes..... 1214, 1300
 Tempo..... 1143
 Tevion..... 0713, 1334, 1409

Thomson..... 0392, 0713, 0820, 0847, 0853, 1046, 1175, 1291, 1498, 1900
 Tivo..... 1142, 1442, 1443, 1444
 Tokai..... 0200
 Tonna..... 0713
 Topfield..... 1206, 1207, 1545
 Toshiba..... 0749, 0790, 0819, 1285, 1446, 1501, 1516, 1530, 1749
 TPS..... 0820, 1253, 1307
 Triax..... 0200, 0713, 0853, 1099, 1251, 1291, 1296
 Trio..... 1075
 TT-micro..... 1429
 Turnsat..... 0713
 Twinner..... 0713
 UltimateTV..... 1392, 1640
 Uniden..... 0052, 0722, 0724, 1521
 Unimax..... 1457
 Unisat..... 0200
 United..... 1251
 Universum..... 0173, 0299, 1099, 1251
 US Digital..... 1535
 USDTV..... 1535
 Van Hunen..... 1161
 Variosat..... 0173
 Ventana..... 0200
 Vestel..... 1251
 Visionic..... 1105, 1206, 1279, 1283
 Visiosat..... 0713, 1129, 1457
 Voom..... 0869
 Wintel..... 0299, 1161
 Wisi..... 0173, 0299
 Wisplus..... 1258
 Worldsat..... 1251, 1323
 XMS..... 1075
 Xsat..... 0713, 0847, 1214, 1323
 Xtreme..... 1300
 Zehnder..... 1075, 1232, 1251, 1334, 1412, 1413
 Zenith..... 0856, 1856

Afreey..... 0698
 Aim..... 0699, 0778, 0818, 0833, 1165
 Airis..... 1005, 1224
 Aiwa..... 0533, 0641, 1633
 Akai..... 0690, 0705, 0766, 0770, 0779, 0788, 0790, 0884, 0898, 0899, 1089, 1115
 AKI..... 1005
 Akira..... 0699
 Akura..... 0898, 1051, 1367
 Alba..... 0539, 0672, 0695, 0699, 0713, 0717, 0730, 0783, 1051
 Albatros..... 1001
 Alco..... 0790
 Allegro..... 0869
 Altacom..... 1224
 Amitech..... 0770, 0784, 0850
 Amphion..... 0872, 1176
 Media Works
 Amstrad..... 0713
 AMW..... 0872, 1176
 Ansonic..... 0831
 Apex..... 0672, 1061
 Apex Digital..... 0672, 0717, 0755, 0794, 0796, 0797, 0830, 1004, 1020, 1056, 1061, 1100
 Arianet..... 0770, 0818
 Asono..... 1224
 Aspire Digital..... 1168, 1407
 Atacom..... 1224
 ATD..... 0718
 Audiologic..... 0736
 Audiosonic..... 0690, 1265
 Audiovox..... 0717, 0790, 1041, 1071, 1072, 1121, 1122
 Auvio..... 0843
 Awa..... 0730, 0872
 Axion..... 0730, 1071, 1072
 B & K..... 0655, 0662
 Basic Line..... 0713
 Baze..... 0898, 1165
 BBK..... 1224
 Bel Canto Design..... 1571
 Bellagio..... 1004
 Black Diamond..... 0698, 0713, 0766, 0833, 0884
 Blaupunkt..... 0717
 Blue Parade..... 0571
 Blue Sky..... 0651, 0672, 0695, 0713, 0769, 0778, 0804, 0843
 Boghe..... 1004
 Boman..... 0783
 Brainwave..... 0770, 1115

DVD

DVD

3D Lab..... 0539
 A-Trend..... 0714
 Acoustic Solutions..... 0713, 0730, 1242
 Adcom..... 1094
 Advent..... 1016
 AEG..... 0770, 0788, 0790
 AFK..... 1051

Brandt	0503, 0551, 0651	Dantax	0539, 0713, 0790, 1089, 1358	Fintec.....	0784, 1169
Broksonic	0695, 0868	Daytek	0872, 1005	Firstline	0651, 0713, 0799, 0843, 0869
Bush	1695, 1165, 1128, 1051, 1021, 0884, 0879, 0833, 0831, 0778, 0758, 0730, 0717, 0713, 0699, 0695, 0690, 0676, 0672, 0516	Dayton	0872	Fisher.....	0670
C-Tech.....	0798	DCE	0831	Funai.....	0675, 0695, 1268, 1334
California Audio Labs	0490	DEC	0778, 0818	Gateway	1073, 1077, 1158
Cambridge Audio	1109	Decca	0770, 1115	GE.....	0522, 0717, 0815
Cambridge Soundworks	0690	Denon	0490, 0634, 1282, 1634	General Electric	0717
Cat.....	0699, 1087	Denver	0699, 0778, 0788, 0818, 0898, 1107, 1165, 1353, 1359	Global Solutions	0768
CAVS	1057	Desav	0770	Go Video.....	0715, 0741, 0744, 0783, 0833, 0869, 1044, 1075, 1099, 1144, 1158, 1304, 1483, 1730
CCE.....	0730	Desay	0800, 0843, 1407	Go Vision	1071, 1072
Celestial.....	1020	Diamond.....	0651, 0768, 0790	GoldStar	0591, 0741
Centrex.....	0672, 1004	Dick Smith Electronics	0833, 1483, 1730	Goodmans.....	0651, 0690, 0713, 0730, 0783, 0790, 0833, 0879, 1004, 1730
Centrum	0713, 0779, 1005	Digihome	0713	GPX	0699, 0769
CGV.....	1115	digiRED	0717	Gradiente.....	0490, 0651
Changhong.....	0627, 1061	Digitor.....	0651, 0690, 1005	Graetz.....	0665
Cinea	0831	Digitrex	0672, 1056, 1100	Gran Prix.....	0831, 0898
Cinego.....	1399	DIGIXmedia	0826	Grandin.....	0672, 0713, 1233
Cineral	0730	DiK.....	0831	Greenhill	0717
Cinetec	0713	Dinamic	0788	Grundig.....	0539, 0551, 0651, 0670, 0695, 0705, 0713, 0775, 0790, 1004, 1036, 1128, 1695, 1730
cineULTRA.....	0699	Disney	0675, 1270	Grunkel.....	0770
CineVision	0833, 0869, 0876, 1483	DiViDo.....	0705	GVG	1169
Citizen	1277	DK Digital	0831	H & B	0818, 0841, 0850, 1233
Classic.....	0730, 1385, 1730	DMTech	0783, 1271	H&B	0713, 0818, 0841, 0850, 1233
Clatronic.....	0672, 0788, 0818, 1165	Dragon.....	0831	Haier	0843
Clayton.....	0713	DSE	0833, 1483, 1730	Hanseatic.....	0741, 0783
Coby.....	0730, 0770, 0778, 0852, 1086, 1107, 1115, 1165, 1177, 1351	DTS.....	0799	Harman/Kardon.....	0582, 0702
Codex.....	1233	Dual	0651, 0665, 0713, 0730, 0779, 0783, 0790, 0831, 1068, 1085	HCM	0788
Compacts.....	0826, 1265	Durabrand	0713, 0831, 1003, 1127	HDT	0705
Conia.....	0516, 0672, 0798, 0852, 1004	DVD2000	0521	Hen	0713
Continental Edison	0768, 0831	DVX.....	0768	Hher.....	0651, 0713, 0826, 0831, 1224
Craig.....	0831	ECC	0730	HiMAX.....	0843
Crown.....	0690, 0769, 0770, 1115	Electrohome	0770, 0784	Hisense.....	0718
Curtis Mathes.....	1087	Elfunk.....	0850	Hitachi	0573, 0664, 0695, 0713, 1247, 1664
Cybercom.....	0831	Elin.....	0770	Hiteker	0672, 0872
CyberHome	0714, 0816, 0874, 1023, 1024, 1117, 1129	Ellion.....	0850	Home Electronics	0730
Cydectin	1074	Elta	0672, 0690, 0770, 0788, 0850, 1051, 1115	Home Tech	1107, 1224
Cytron.....	0651	Eltax.....	0766	Hoyo	0665
D-Vision.....	1115	Emerson	0591, 0675, 0705, 0816, 0821, 1268	Humax	0646
Daenyx	0872	Encore	0698	Hyundai	0766, 0768, 0783, 0850
Daewoo	0705, 0714, 0770, 0784, 0832, 0833, 0869, 0870, 0872, 1169, 1172, 1234, 1242	Enterprise	0591	iLo.....	1348
Daewoo International	0872	Enzer	0665, 0766, 0770, 0784	Ingelen.....	0788
Dalton.....	1036	EuroLine	0788, 1115	Initial	0717, 0839
Dansai	0770, 0783, 1115	Fenner	0651, 0769	Integra	0571, 0627, 1634
		Ferguson	0651	IRT	0783
		Finlux.....	0591, 0672, 0676, 0741, 0770, 0783, 1165		

ISP.....	0695	Malata.....	0782, 1159	NextBase.....	0826
Jaton.....	0665, 1078	Manhattan.....	0705, 0713	NexxTech.....	1402
JBL.....	0702	Marantz.....	0539	Nintaus.....	1051
JDV.....	1367	Mark.....	0713	Norcent.....	0872, 1003, 1107, 1265
Jeken.....	0699	Marquant.....	0770	Nordmende.....	0831
Jensen.....	1016	Matsui.....	0651, 0672, 0695, 0713, 0884, 1004, 1695, 1730	Noriko.....	0752
Jindian.....	0799	Maxdorf.....	0788	Nowa.....	0843
JMB.....	0695	Maxim.....	0713, 0872	Nu-Tec.....	0516
JNC.....	0672	MBO.....	0690, 0730, 1730	Okano.....	0752
JSI.....	1423	McIntosh.....	1273, 1533	Olidata.....	0672
JVC.....	0503, 0539, 0558, 0623, 0867, 1164, 1241, 1275	MDS.....	0778	Omni.....	0690, 0698, 0778, 0833
jWin.....	1049, 1051	Mecotek.....	0770	Onix.....	0672, 0852
Karcher.....	0783	Medion.....	0630, 0651, 0758, 0770, 0783, 0820, 0831, 0879	Onkyo.....	0503, 0627, 0792, 1417, 1418, 1612
Kawasaki.....	0790	MEI.....	0790	Oopla.....	1158
Kendo.....	0699, 0713, 0831	Memorex.....	0690, 0695, 0831, 1270	Oppo.....	1224
Kenex.....	0713, 0770, 0898	Metronic.....	0690	Optim.....	0843
Kenwood.....	0490, 0534, 0682, 0737	Metz.....	0525, 0571, 0713	Optimus.....	0525
Kihiro.....	0770	Microboss.....	0718	OptoMedia Electronics.....	0896
King DHome.....	0799	Micromaxx.....	1695	Orava.....	0818
Kingavon.....	0818	Micromedia.....	0503, 0539	Orion.....	0695, 1128, 1695
Kiss.....	0665, 0841	Micromega.....	0539	Oritron.....	0651
KLH.....	0717, 0790, 1020, 1149, 1261	Microsoft.....	0522	Ormond.....	0713
KLH Digital.....	0717	Microstar.....	0831	Otic.....	0826
Koda.....	0818	Minato.....	0752	P&B.....	0770, 0818
Konka.....	0711, 0719, 0720, 0721	Minax.....	0713	Pacific.....	0695, 0713, 0768, 0790, 0804, 0831
Koss.....	0651, 0896, 1423	Minerva.....	0705	Packard Bell.....	0770
Landel.....	0826	Minoka.....	0770	Palladium.....	0695, 0779
Lasonic.....	0798, 1173	Minowa.....	1165	Palsonic.....	0672, 0852
Lawson.....	0768	Mintek.....	0717, 0839	Panasonic.....	0490, 0503, 0632, 0703, 1010, 1011, 1282, 1362, 1462, 1490, 1762
Lecson.....	1533	Mirror.....	0752, 0879	Panda.....	0717
Lenco.....	0651, 0699, 0713, 0770, 0778, 0818, 1165	Mitsubishi.....	0521, 0713, 1403, 1521	Paramount Pictures.....	0779
Lenoxx.....	0690, 1127	Mizuda.....	0770, 0818	peeKTon.....	1224
Lexia.....	0699, 0768	Momitsu.....	1082	Philco.....	0690, 0788, 0790
LG.....	0591, 0741, 0790, 0801, 0869	Monyka.....	0665	Philips.....	0503, 0539, 0646, 0675, 0854, 0885, 1158, 1260, 1267, 1354, 1818
Lifetec.....	0651, 0831	MPX.....	0843	Phonotrend.....	0672, 0699, 0818, 1165
Limit.....	0768	MTlogic.....	1265	PianoDisc.....	1024
LiteOn.....	1058, 1158, 1416, 1440	Mustek.....	0730, 1730	Pioneer.....	0490, 0525, 0571, 0631, 0632, 1571, 1816
Loewe.....	0511, 0539, 0741, 0885	Mx Onda.....	0651	Plu2.....	0850
Logix.....	0705, 0783	Myryad.....	0894	Pointer.....	0784
Luker.....	1367	NAD.....	0591, 0692, 0741	Polaroid.....	1020, 1061, 1086, 1200
Lumatron.....	0705, 0741, 0833, 1115	Naiko.....	0770, 1004, 1367	Polk Audio.....	0539
Lunatron.....	0741	Nakamichi.....	1222	Portland.....	0770
Luxman.....	0573	Narita.....	1115	Powerpoint.....	0872
Luxor.....	0713, 1004, 1695, 1730	NEC.....	0591, 0692, 0785, 0869, 1404	Powtek.....	0852
Magnasonic.....	0651, 0769	Neovia.....	1271	Prima.....	0766, 1016
Magnavox.....	0503, 0539, 0646, 0675, 0713, 0818, 0821	Nesa.....	0717	Prima Electronic.....	0766
Magnex.....	1165	Neufunk.....	0665		
		Nevir.....	0770, 0831		

Princeton.....	0674	SEG.....	0665, 0713, 0768, 0798, 0872, 0884	Synn.....	0768
Prinz.....	0831	Semp.....	0503	TAG McLaren.....	0894
Prism.....	0705	Sensory Science.....	1158	Tandberg.....	0713
Proceed.....	0672	Shanghai.....	0672	Tatung.....	0770
Proline.....	0651, 0672, 0833, 1004	Sharp.....	0630, 0675, 0713, 0752, 1256	Teac.....	0516, 0571, 0692, 0695, 0717, 0741, 0758, 0768, 0790, 0809, 0833, 1021, 1051, 1483
Proscan.....	0522	Sharper Image.....	1112, 1117	Tec.....	0898
Proson.....	0713	Sherwood.....	0633, 0717, 0741, 0770, 1043, 1077	Technics.....	0490, 0703
Prosonic.....	0752	Shinco.....	0717	Technika.....	0768, 0770, 0831, 1115, 1165
ProVision.....	0699, 0778	Shinsonic.....	0533, 0839	Technisson.....	1115
Qwestar.....	0651	Sigma Designs.....	0674	Technosonic.....	0730, 1051, 1115
Radionette.....	0741, 0869	Sigmatek.....	1005	Techwood.....	0692, 0713
Raite.....	0665	Siltex.....	1224	Tedelex.....	0690, 0768, 1004
RCA.....	0522, 0571, 0717, 0769, 0790, 0822, 1022, 1132, 1193	Silva.....	0788, 0831, 0898	Telefunken.....	0758, 0770, 0788, 0790, 0833
REALmagic.....	0674	Silva Schneider.....	0831, 0898	Teletech.....	0713, 0768
REC.....	0490, 0766	Simaudio.....	0885	Telra.....	0676
Recco.....	0698	Singer.....	0690, 0768	Tensai.....	0651, 0690, 0770
Red Star.....	0770, 0788, 0898, 1003	Skantic.....	0539, 0713, 1003	Terapin.....	1031
Redstar.....	0898	Skymaster.....	0730, 0768	Tevion.....	0651, 0768, 0798, 0833, 0898, 1036, 1382
Reoc.....	0752, 0768	Skysonic.....	0766	Theta Digital.....	0571
Resonance.....	0651	Skyworth.....	0766, 0898	Thomson.....	0522, 0551
Revoy.....	0699, 0841	Slim Art.....	0784	Tivo.....	1816
Rio.....	0869	Slim Devices.....	0533	Tokai.....	0665, 0698, 0784, 0788, 0790, 0898
RJTech.....	1360	SM Electronic.....	0690, 0730, 0768	Tokaido.....	0698
Roadstar.....	0690, 0699, 0713, 0730, 0818, 0833, 0879, 0898, 1051, 1339	Smart.....	0705, 0713, 0718	Toshiba.....	0503, 0695, 1045, 1154
Ronin.....	0872	Sonai.....	0755	TRANS-continent.....	0799, 0826, 0831, 0843, 0872
Rotel.....	0558, 0623, 1178	Sonashi.....	0831	Transonic.....	0672, 0730, 1165
Rowa.....	0516, 0717, 0823, 0872, 1004	Sonic Blue.....	0783, 0869, 1099	Tredex.....	0799, 0800, 0803, 0804, 0843
Saba.....	0551, 0651, 0769	Sony.....	0533, 0573, 0772, 0864, 1017, 1033, 1069, 1070, 1133, 1389, 1431, 1533, 1633	Trio.....	0770, 0784
Sabaki.....	0798	Soundmaster.....	0768	TSM.....	1224
Saivod.....	0831, 1367	Soundmax.....	0768	TYT.....	0705
Sakyno.....	0768	Soundwave.....	0783	Umax.....	0690
Salora.....	0741	Sova.....	1122	United.....	0672, 0695, 0768, 0788, 0826, 0852, 1115, 1165
Sampo.....	0698, 0752	Spectra.....	0872	Universal Multimedia.....	0768
Samsung.....	0490, 0573, 0744, 0820, 0899, 1044, 1075, 1118	Standard.....	0651, 0768, 0788, 0831	Universum.....	0591, 0713, 0741, 0779, 0869
Sansui.....	0695, 0768, 0784, 1695	Star Cluster.....	0768	Urban Concepts.....	0503
Sanyo.....	0670, 0695, 0873	Starlogic.....	1005	US Logic.....	0839
Scan.....	0705, 0850	Starmedia.....	0818, 1005, 1224	V.....	1064
ScanMagic.....	0730	Strong.....	0713	Venturer.....	0790
ScanSonic.....	1695	Sungale.....	1074	Vestel.....	0713
Schaub Lorenz.....	0770, 0788, 1115	Sunkai.....	0770, 0850	Vieta.....	0705
Schneider.....	0539, 0651, 0705, 0713, 0779, 0783, 0788, 0790, 0804, 0831	Sunstech.....	0831	Viewmaster.....	1224
Schwaiger.....	0752	Sunwood.....	0788, 0898	VInc.....	1064, 1226
Scientific Labs.....	0768, 0798	Superscan.....	0821	Vizio.....	1064, 1226
Scott.....	0651, 0672, 0718, 0797, 1005, 1036	Supervision.....	0768	Vocopro.....	1027
Seeltech.....	1224	SVA.....	0672, 0717, 0860, 1105		
		Sylvania.....	0630, 0675, 0821, 1268		
		Symphonic.....	0675, 1268		

Voxson.....	0690, 0730, 0831
Walkvision	0717
Welkin	0831
Wellington.....	0713
Wesder	0699
Wharfedale	0698, 0752, 0768, 0790
Wilson.....	0831
Windsor	0713
Windy Sam.....	0573
WIZE.....	1115
Woxter.....	1005, 1224
Xbox	0522
Xenius.....	0651, 0790
XLogic	0768, 0798
XMS.....	0770, 0788
Xoro.....	1173
Xwave.....	1001
Yakumo	1004, 1056
Yamada	0872, 1004, 1056, 1158
Yamaha	0490, 0539, 0545, 0646, 0817, 1282
Yamakawa	0665, 0872
Yukai.....	0730, 1730
Zenith	0503, 0591, 0741, 0869
Zeus	0784
Zoece	1265

VCR

VCR

ABS	1972
Accent.....	0072
Admiral.....	0048, 0209, 0479
Adventura.....	0000
Adyson	0072
Aiko	0278
Aim	0020, 0209, 0278, 0642
Aiwa.....	1468, 1336, 1284, 0742, 0687, 0680, 0479, 0468, 0352, 0348, 0315, 0307, 0209, 0124, 0037, 0032, 0000
Akai	0020, 0037, 0041, 0061, 0081, 0106, 0175, 0240, 0315, 0348, 0352, 0642
Akashi.....	0072
Akiba	0072
Akura.....	0072, 0271
Alba	0000, 0020, 0072, 0081, 0209, 0278, 0315, 0348, 0352
Alienware.....	1972
Allstar	0081
Ambassador.....	0020

America Action.....	0278
American High.....	0035
Amoisonic.....	0479
Amstrad.....	0000, 0072, 0278
Anam	0037, 0162, 0226, 0240, 0278, 0480, 0579, 1037
Anam National.....	0162, 0226, 1162, 1562
Anitech	0072
Ansonic.....	0000
Apelsound	0209
Aristona.....	0081
ASA	0037, 0081
Asha	0240
Asuka.....	0037, 0038
Audiosonic.....	0072, 0278
Audioton	0020
Audiovox	0037, 0278, 0781
AVP.....	0352
Awa.....	0037, 0043, 0278, 0642, 0687
Baird.....	0000, 0041, 0104, 0106
Basic Line.....	0020, 0046, 0072, 0104, 0278
Beaumarck.....	0240
Beko	0104
Bell & Howell	0104
Bestar.....	0278
Black Diamond.....	0081, 0642
Black Panther	0278
Blaupunkt	0034, 0081, 0162, 0226
Blue Sky	0037, 0072, 0209, 0278, 0348, 0352, 0480, 0642
Bondstec.....	0020, 0072
Brandt.....	0041, 0320
Brandt Electronic.....	0041
Brinkmann	0209, 0348
Broksonic	0002, 0121, 0184, 0209, 0348, 0352, 0479, 1479
Bush	0000, 0072, 0081, 0209, 0278, 0315, 0348, 0352, 0642, 0742
Calix	0037
Canon.....	0035
Capehart.....	0020
Carena	0209
Carrefour	0045
Carver.....	0081
Casio	0000
Cathay	0278
Catron.....	0020
CCE	0072, 0278
CGE.....	0000
Changhong.....	0048, 0081

Cimline.....	0072
Cineral	0278
Citizen.....	0037, 0278, 1278
Clatronic	0000, 0020, 0072
Colt.....	0072
Combitech.....	0352
Condor.....	0020, 0278
Craig	0037, 0047, 0072, 0240, 0271
Crown	0020, 0037, 0072, 0271, 0278, 0480
Curtis Mathes	0035, 0041, 0060, 0162, 0760, 1035
Cybernex	0240
CyberPower.....	1972
Cyrus	0081
Daewoo	0020, 0045, 0046, 0104, 0209, 0278, 0352, 0561, 0637, 0642, 0844, 0877, 1278
Dansai.....	0072, 0278
Dantax	0352
Daytron	0020, 0278
De Graaf	0042, 0046, 0048, 0081, 0104
Decca	0000, 0008, 0067, 0081, 0209, 0348, 0352
Deitron.....	0278
Dell.....	1972
Denko	0072
Denon	0042
Diamant	0037
Diamond	0209, 0348
Dick Smith	0579, 0642
Electronics	
Digitor	0579, 0642
DirecTV.....	0739
Domland	0209
DSE.....	0579, 0642
Dual	0000, 0041, 0081, 0278, 0348
Dumont.....	0000, 0081, 0104, 0105
Durabrand.....	0038, 0039
Dynatech	0000
Elbe.....	0038, 0278
Elcatech.....	0072
Electrohome	0037, 0043
Electroponic	0037
Elin.....	0240
Elsay	0072
Elta.....	0072, 0278
Emerex	0032

DVD
VCR

Emerson.....	1593, 1479, 1278, 0637, 0593, 0561, 0479, 0348, 0343, 0278, 0240, 0209, 0208, 0184, 0121, 0072, 0061, 0045, 0043, 0037, 0035, 0002, 0000	Hanseatic.....	0037, 0038, 0081, 0209	Kambrook.....	0037
ESC.....	0020, 0240, 0278	Hantor.....	0020	Karcher.....	0081, 0278
Europhon.....	0020	Haojie.....	0240	KEC.....	0037, 0278
Fenner.....	0020	Harley Davidson.....	0000	Kendo.....	0072, 0106, 0209, 0278, 0315, 0348, 0642
Ferguson.....	0000, 0041, 0278, 0320	Harman/Kardon.....	0038, 0081	Kenwood.....	0038, 0041, 0067
Fidelity.....	0000, 0072, 0240, 0278, 0352, 0432	Harwood.....	0072	KIC.....	0000
Finlandia.....	0000, 0037, 0042, 0043, 0046, 0048, 0081, 0104, 0106, 0226	HCM.....	0072	Kimari.....	0047
Finlux.....	0000, 0042, 0081, 0104, 0105, 0315	Headquarter.....	0046	Kioto.....	0348
Firstline.....	0037, 0043, 0045, 0072, 0209, 0278, 0348, 0480	Hewlett Packard.....	1972	KLH.....	0072
Fisher.....	0020, 0046, 0047, 0104	Hher.....	0278, 0642	Kneissel.....	0037, 0209, 0278, 0348, 0352
Flint.....	0209, 0348	HI-Q.....	0047	Kodak.....	0035, 0037
Frontech.....	0020, 0072	Hinari.....	0041, 0072, 0208, 0240, 0278, 0343, 0352	Kolin.....	0041, 0043
Fuji.....	0033, 0035	Hisawa.....	0352	Kolster.....	0209
Fujitsu.....	0000, 0045	Hischito.....	0045	Korpel.....	0072
Fujitsu General.....	0037	Hitachi.....	0000, 0037, 0041, 0042, 0046, 0081, 0089, 0105, 0240, 0593, 1037, 1326	Kuba Electronic.....	0047
Funai.....	0000, 0593, 1333, 1593	Hornlyphon.....	0081	Kyoto.....	0072
Galaxis.....	0278	Howard Computers.....	1972	Lenco.....	0278
Garrard.....	0000	HP.....	1972	Leyco.....	0072
Gateway.....	1972	Hughes Network.....	0042, 0739	LG.....	0037, 0038, 0042, 0045, 0209, 0480, 1037, 1237, 2010
GE.....	0035, 0048, 0060, 0202, 0209, 0226, 0240, 0320, 0760, 0761, 0807, 1035, 1060	Systems		Lifetec.....	0209, 0348
GEC.....	0081	Humax.....	0739	Linksys.....	1972
General.....	0020, 0045	Hush.....	1972	Lloyd's.....	0000, 0208
General Technic.....	0348	Hypson.....	0000, 0037, 0072, 0209, 0278, 0480	Loewe.....	0037, 0081, 0105, 0162, 1562
Genexxa.....	0104	iBUYPOWER.....	1972	Logik.....	0072, 0106, 0209, 0240
Gessen.....	0278	Imperial.....	0000	Luker.....	0579
Go Video.....	0240, 0432, 0526	Ingersoll.....	0209, 0240	Lumatron.....	0593
GoldHand.....	0072	Inno Hit.....	0072, 0432	Lux May.....	0072
GoldStar.....	0037, 0038, 0209, 0225, 0226, 0348, 0480, 1237	inotech.....	0278	Luxor.....	0043, 0046, 0047, 0048, 0062, 0104, 0106, 0315
Goodmans.....	0000, 0020, 0037, 0062, 0072, 0081, 0209, 0278, 0343, 0348, 0352, 0637, 0642	Interbuy.....	0072	LXI.....	0037
GPX.....	0037	Interfunk.....	0081, 0104	M Electronic.....	0000, 0038
Gradiente.....	0000, 0008	Internal.....	0278, 0637	Magnasonic.....	0278, 0593, 1278
Graetz.....	0041, 0104, 0106, 0240	International.....	0037, 0278, 0642	Magnavox.....	0000, 0035, 0039, 0081, 0149, 0563, 0593, 0642, 1781
Granada.....	0000, 0037, 0042, 0046, 0048, 0081, 0104, 0226, 0240	Intervision.....	0000, 0209, 0278	Magnin.....	0240
Grandin.....	0000, 0037, 0072, 0209, 0278, 0742, 0844	IR.....	0020, 0041, 0042, 0045, 0047, 0072, 0081, 0104, 0106, 0208, 0209, 0226, 0240, 0343, 0348	Magnum.....	0642
Gronic.....	0104	Irradio.....	0072, 0081	Manesth.....	0045, 0072, 0081, 0209
Grundig.....	0034, 0072, 0081, 0226, 0320, 0347, 0348, 0352, 0742	ITT.....	0041, 0046, 0104, 0106, 0240	Marantz.....	0035, 0038, 0062, 0081, 0209, 1381
Haaz.....	0348	ITT Nokia.....	0552	Mark.....	0000, 0278
Hanimex.....	0352	ITV.....	0020, 0037, 0278	Marta.....	0037
		ITV Videomaster.....	0020	Mastec.....	0642
		JBL.....	0278	Master's.....	0278
		Jensen.....	0041	Matsui.....	0208, 0209, 0240, 0278, 0348, 0352, 0687, 0742
		JMB.....	0209, 0348, 0352, 0742	Matsushita.....	0035, 0162, 0226, 1162
		Joyce.....	0000	Media Center PC.....	1972
		JVC.....	0008, 0041, 0045, 0067, 0081, 1008, 1162, 1279, 1329	Medion.....	0209, 0348, 0352, 0642
		Kaisui.....	0072	MEI.....	0035

DEVICE CODES

Melectronic.....	0000, 0037, 0038	Onimax.....	0642	Quasar.....	0035, 0162, 0278, 1035, 1162
Memorex.....	1262, 1237, 1162, 1048, 1037, 0579, 0479, 0348, 0307, 0240, 0209, 0162, 0104, 0048, 0047, 0046, 0039, 0037, 0035, 0000	Onkyo.....	0222	Quelle.....	0081
Memphis.....	0072	Optimus.....	0037, 0048, 0104, 0162, 0432, 0593, 1048, 1062, 1162, 1262	Radialva.....	0037, 0048
Mercury.....	0020	Optonica.....	0062	Radiola.....	0081
Metronic.....	0081	Orbit.....	0072	Radionette.....	0037
Metz.....	0037, 0081, 0162, 0226, 0347, 0836, 1162, 1562	Orion.....	0002, 0121, 0184, 0208, 0209, 0343, 0348, 0352, 0479, 0687, 0742, 1479	RadioShack.....	0000, 0037, 1037
MGA.....	0043, 0061, 0240	Osaki.....	0000, 0037, 0072	Radix.....	0037
MGN Technology.....	0240	Osume.....	0072	Randex.....	0037
Micormay.....	0348	Otake.....	0209	Rank.....	0041
Micromaxx.....	0209, 0348	Otto Versand.....	0081	Rank Arena.....	0041
Microsoft.....	1972	Pace.....	0352	RCA.....	1060, 1035, 0880, 0807, 0761, 0760, 0432, 0320, 0240, 0226, 0202, 0149, 0106, 0105, 0060, 0048, 0042, 0035, 0000
Mind.....	1972	Pacific.....	0000, 0348, 0642, 0742	Realistic.....	0000, 0035, 0037, 0046, 0047, 0048, 0062, 0104
Minolta.....	0042, 0105	Packard Bell.....	1972	Reoc.....	0348, 0877
Mitsubishi.....	0000, 0041, 0043, 0048, 0061, 0067, 0081, 0480, 0642, 0807, 1343	Palladium.....	0037, 0041, 0072, 0209, 0315, 0348	Replay Networks.....	0614
Motorola.....	0035, 0048	Palsonic.....	0000, 0037, 0072, 0642	ReplayTV.....	0614, 0616
MTC.....	0000, 0240	Panasonic.....	1807, 1662, 1562, 1393, 1317, 1308, 1292, 1262, 1244, 1162, 1062, 1035, 0836, 0616, 0614, 0226, 0225, 0162, 0035	Rex.....	0041
Multitec.....	0037	Pathe Cinema.....	0043	RFT.....	0072
Multitech.....	0000, 0020, 0072, 0278	Pathe Marconi.....	0041	Ricavision.....	1972
Murphy.....	0000	Penney.....	0035, 0037, 0038, 0042, 0240, 1035, 1237	Ricoh.....	0034
Myryad.....	0081	Pentax.....	0042, 0105	Roadstar.....	0037, 0072, 0081, 0240, 0278, 0742
NAD.....	0104	Perdio.....	0000, 0209	Royal.....	0072
Naiko.....	0642	Philco.....	0000, 0035, 0038, 0072, 0209, 0226, 0479, 0561	Runco.....	0039
National.....	0162, 0226, 0240	Philips.....	0000, 0035, 0062, 0081, 0226, 0563, 0593, 0616, 0618, 0739, 1081, 1181, 1340, 1381	Saba.....	0041, 0062, 0067, 0278, 0320
Nebula Electronics.....	0033	Phoenix.....	0278	Saisho.....	0208, 0209, 0348
NEC.....	0008, 0035, 0037, 0038, 0041, 0048, 0067, 0104, 0209, 0278, 1287	Phonola.....	0081	Salora.....	0043, 0046, 0104, 0106
Neckermann.....	0081	Pilot.....	0037	Sampo.....	0037, 0048
Nesco.....	0072	Pioneer.....	0042, 0067, 0081, 0162, 1337, 1562	Samsung.....	0045, 0240, 0432, 0739, 0760, 1014
Neufunk.....	0209	Polk Audio.....	0081	Samurai.....	0020
Newave.....	0037	Portland.....	0020, 0278, 0637	Sanky.....	0039, 0048
Nikkai.....	0020, 0072, 0278	Prinz.....	0000	Sansui.....	0000, 0041, 0067, 0072, 0106, 0209, 0271, 0348, 0479, 1479
Nikko.....	0037	Profitronic.....	0081, 0240	Sanyo.....	0046, 0047, 0048, 0067, 0104, 0159, 0209, 0240, 0348, 1330, 1331
Nikon.....	0034	Proline.....	0000, 0278, 0320, 0642	Saville.....	0240, 0278, 0352
Niveus Media.....	1972	Proscan.....	0060, 0202, 0760, 0761, 1060	SBR.....	0081
Noblex.....	0240	Prosonic.....	0278	Schaub Lorenz.....	0000, 0041, 0104, 0106, 0315, 0348
Nokia.....	0041, 0042, 0046, 0048, 0081, 0104, 0106, 0240, 0278, 0315, 0552	Protec.....	0072	Schneider.....	0000, 0037, 0042, 0072, 0081, 0240, 0278, 0348, 0352, 0637, 0642
Nordmende.....	0041, 0067, 0320	Protech.....	0081, 0278	Scott.....	0043, 0045, 0121, 0184
Northgate.....	1972	ProVision.....	0278	Sears.....	0000, 0035, 0037, 0042, 0046, 0047, 0104, 0105, 1237
Novatronic.....	0209	Pulsar.....	0039	Seaway.....	0278
Nu-Tec.....	0209	Pye.....	0000, 0081	SEG.....	0072, 0081, 0240, 0278, 0561, 0637, 0642
Oceanic.....	0000, 0041, 0046, 0048, 0081, 0104, 0106	Qisheng.....	0060	SEI.....	0081
Okano.....	0072, 0209, 0278, 0315, 0348	Quarter.....	0046		
Olympus.....	0035, 0226	Quartz.....	0046		
Onida.....	0162				

Seleco	0020, 0037, 0041	Tatung.....	0000, 0008, 0041, 0043, 0045, 0048, 0067, 0081, 0209, 0348, 0352	Vector Research	0038
Semp.....	0045	Tchibo.....	0348	Victor	0008, 0041, 0067
Senra.....	0020, 0072	TCM.....	0348	Video Concepts.....	0045, 0061
Serie Dorada	0037	Teac.....	0000, 0037, 0041, 0072, 0278, 0307, 0526, 0593, 0637, 0642, 0781, 0844	Video Pro	0020
Sharp.....	0037, 0048, 0062, 0209, 0807, 0848, 1048, 1285, 1400	Tec.....	0020, 0072	Video Technic	0000
Shinco	0000	Tech Line	0072	Videomagic.....	0037
Shintom.....	0072, 0104	Technics	0035, 0081, 0162, 0226, 1162	VideoPro	0020
Shivaki.....	0037	TechniSat.....	0209	Videosonic.....	0240
Shogun.....	0240	Teco.....	0035, 0037, 0038, 0041, 0048	Viewsonic	1972
Siemens	0037, 0046, 0081, 0104, 0320, 0347	Tedex.....	0037, 0209, 0348, 0642	Villain	0000
Siera.....	0081	Teknika	0000, 0035, 0037	Voodoo	1972
Silva.....	0037	Teleavia.....	0041	Wards	0760, 0240, 0149, 0081, 0072, 0062, 0060, 0048, 0047, 0046, 0045, 0042, 0039, 0038, 0035, 0033, 0000
Silver	0278	Telefunken	0041, 0067, 0209, 0240, 0278, 0320, 0642	Watson	0081, 0352, 0642
Singer.....	0045, 0072, 0271, 0348	Telestar	0037	Wharfedale	0593, 0642
Sinudyne	0081, 0209, 0352	Teletech.....	0000, 0072, 0278	White Westinghouse.....	0072, 0209, 0278, 0637
Smaragd.....	0348	Tempest.....	0020	World	0348
Solavox	0020	Tenosal	0072	XR-1000.....	0000, 0035, 0072
Sonic Blue.....	0614, 0616	Tensai	0000, 0072, 0278	Yamaha.....	0038, 0041
Soniko	0072	Tevion	0209, 0348, 0642	Yamishi	0072, 0278
Sonitron.....	0104	Texet.....	0020, 0278	Yokan.....	0072
Sonneclair	0072	Thomas.....	0000	Yoko.....	0020, 0037, 0240
Sonolor.....	0046, 0062	Thomson	0041, 0060, 0067, 0202, 0278, 0320, 0722	Yoshita.....	0072
Sontec.....	0037	Thorn	0037, 0041, 0104	Zenith.....	0000, 0033, 0034, 0039, 0209, 0479, 0637, 1139, 1479
Sonwa	0642	Tivo.....	0618, 0636, 0722, 0739, 1337, 1503	ZT Group	1972
Sony	0000, 0032, 0033, 0034, 0035, 0106, 0636, 1032, 1232, 1295, 1296, 1297, 1447, 1972	TMK.....	0208, 0240	ZX	0209, 0348, 0352
Soundwave	0037, 0209, 0348	Tokai	0037, 0072		
Ssanyong	0072	Topline	0348		
Stack 9	1972	Toshiba	1972, 1503, 1325, 1323, 1290, 1145, 1008, 0845, 0742, 0432, 0352, 0209, 0081, 0067, 0045, 0043, 0042, 0041, 0008		
Starlite.....	0037	Totevision	0037, 0240		
Stern.....	0278	Touch.....	1972		
Strong.....	0271	Towada	0072		
STS.....	0042	Tradex.....	0081		
Sunkai	0209, 0278, 0348	Trakton.....	0020		
Sunstar.....	0000	Triad.....	0278		
Suntronic.....	0000	Triumph.....	0208		
Sunwood.....	0072	Uher.....	0240		
Supra.....	0037, 0240, 0278, 0348	Ultravox.....	0278		
Sylvania	0000, 0035, 0043, 0081, 0593, 1593, 1781	Unitech	0240		
Symphonic	0000, 0593, 1593	United.....	0348		
Systemax	1972	Universal.....	0209		
T+A.....	0162	Universum	0000, 0037, 0081, 0104, 0106, 0209, 0240, 0315, 0348		
Tagar Systems.....	1972	Vector	0045		
Taisho	0209				
Tandberg	0278				
Tandy.....	0000, 0104				
Tashiko	0000, 0037, 0048, 0081, 0240				

DVR

Digital Video Recorder (DVR)

ABS	1972
Alienware	1972
CyberPower.....	1972
Dell.....	1972
DirecTV.....	0739
Gateway	1972
Howard Computers	1972
HP.....	1972
Hughes Network.....	0739
Systems	
Humax	0739
Hush	1972
iBUYPOWER	1972
JVC.....	1279
LG.....	2010
Linksys.....	1972
Media Center PC.....	1972
Microsoft	1972

Mind	1972
Niveus Media	1972
Northgate	1972
Panasonic.....	0616, 1244, 1807
Philips.....	0618, 0739, 1340
RCA.....	0880
ReplayTV	0614, 0616
Sonic Blue.....	0614, 0616
Sony	0636, 1447, 1972
Stack 9	1972
Systemax	1972
Tagar Systems.....	1972
Thomson	0722
Tivo.....	0618, 0636, 0722, 0739
Toshiba.....	1008, 1972
Touch.....	1972
Viewsonic	1972
Voodoo.....	1972
ZT Group.....	1972

HDTV

HDTV Decoder

Accurian	1653
DirectTV.....	0392
Epson	1563, 1650
Hisense.....	1535
iLo.....	1535
LG.....	1414, 1415
Macro Image Technology	1383
Motorola	1363
MyHD	1383
Panasonic.....	1120
Pioneer	1010
Princeton.....	0113, 0295
Proton.....	1535
Samsung	1276, 1190, 1490
Sasem	1641
Sensory Science	1126
Sharp.....	1010
Sylvania.....	1563
Telemann	1604
Toshiba.....	1446
US Digital	1535
USDTV.....	1535
Zenith	1856
Viewsonic	1329
Vizio	1126

Combination

TV/VCR
TV/VCR combination

Aiwa.....	0000, 0468, 0479, 0680, 0687, 0742, 1336, 1468
America Action.....	0278
Audiovox	0278
Broksonic	0002, 0479, 1479
Citizen	1278
Colt.....	0072
Curtis Mathes.....	1035
Daewoo	0637, 0844, 1278
Dick Smith Electronics.....	0579
Digitor.....	0579
DSE	0579
Emerson.....	0002, 0479, 0593, 0637, 1278, 1479
Funai.....	0000, 1333
GE	0240, 0807, 1035, 1060
GoldStar	1237
Goodmans.....	0343, 0637
Harley Davidson.....	0000
Hitachi	0000, 1326
JVC.....	1329
LG.....	0480, 1037
Lloyd's.....	0000
Magnasonic.....	0593, 1278
Magnavox.....	0000, 0593, 1781
Magnin	0240
Memorex	0162, 1037, 1162, 1237, 1262
MGA	0240
Mitsubishi.....	0043, 0807
Nokia	0552
Optimus.....	0162, 0593, 1162, 1262
Orion.....	0002, 0479, 1479
Panasonic.....	0162, 1035, 1162, 1262, 1308, 1317, 1662
Penney	0240, 1035, 1237
Philco	0479
Quasar.....	0162, 1035, 1162
RadioShack.....	0000, 1037
RCA.....	0240, 0807, 1035, 1060
Reoc	0877
Samsung	0432, 1014
Sansui	0000, 0479, 1479
Sanyo	0240, 1330, 1331
Sears.....	0000, 1237

Sharp.....	0807
Sony	0000, 1232, 1295, 1296, 1297
Sylvaniav	1781
Symphonic	0000, 0593
Teac.....	0000, 0593, 0637, 0781
Thomas.....	0000
Toshiba.....	0845, 1145, 1323, 1325
White Westinghouse.....	0637
Zenith	0000, 0479, 0637, 1479

TV/DVD
TV/DVD combination

Advent	1016
Apex Digital	0830
Audiovox	1071, 1121, 1122
Axion	1071
Broksonic	0695
Bush	0516, 0676, 0713, 0879, 0884
Cinego	1399
Classic.....	1385
Daewoo	0870
Dantax	1358
Denver	1353, 1359
DMTech	1271
Emerson	1268
Go Vision	1071
Goodmans.....	0879
Grundig.....	0695
Hitachi	1247
Jensen	1016
KLH	1261
Konka	0719, 0720
Mirror.....	0879
Neovia	1271
Panasonic.....	1490
Philips.....	0854, 1260
Prima	1016
RCA	1022, 1193
Roadstar.....	1339
Saivod	1367
Samsung	0899
Sansui.....	0695
Sova	1122
Sylvania.....	0675, 1268
Teac.....	0758, 1021
Toshiba.....	0695

TV/VCR/DVD
TV/VCR/DVD combination

Akai.....	0899
Broksonic	0868
Emerson	0821
Funai.....	1334
Magnavox.....	0821
Orion.....	1128
Panasonic.....	1362, 1462
RCA	1132
Sharp	0630, 0807
Superscan	0821
Sylvania	0821
Toshiba	1045

VCR/DVD
VCR/DVD combination

Allegro	0869
Apex Digital	1061
Broksonic	0695
CineVision.....	0833, 0869, 1483
Daewoo	0833, 0869
Dick Smith Electronics.....	0833, 1483
DSE.....	0833, 1483
Emerson	0675, 1593
Funai.....	0675, 1593
Go Video.....	0715, 0741, 0744, 0833, 0869, 1044, 1075, 1483
GoldStar	0741
Hitachi	0664, 0000
JVC.....	0867, 1164, 1241
LG.....	0741, 0869
Lunatron	0741
Memorex	0695
Orion.....	1695
Panasonic.....	0490, 1762, 1562
Philips.....	0675, 1267, 0593
Polaroid	1061
RCA	0522, 0822, 0060
Samsung	0744, 0820, 1044, 1075
Sansui.....	0695, 1695
Sanyo	0873, 0104
Sharp	0630, 0848
Sony	0864, 1431
Sylvania	0675, 0000, 0593, 1593
Symphonic	0675, 0000, 1593

Teac 0833, 1483
 Toshiba 0503
 Zenith 0741, 0869

CBL/DVR
 Cable/DVR combination

Americast 0899
 Digeo 1187
 Freebox 1482
 General Instrument 0476, 0810
 Jerrold 0476, 0810
 Motorola 0476, 0810, 1106, 1187,
 1376
 Nokia 1569
 Noos 1624
 Pace 0237, 1877
 Pioneer 0877, 1877
 RCA 1256
 Scientific Atlanta 0877, 1877
 Sony 1006
 Supercable 0276
 Thomson 1256
 Zenith 0899

SAT/DVR
 Satellite/DVR combination

@sat 1300
 Amino 1615
 Atsat 1300
 British Sky 1175
 Broadcasting
 Canal Satellite 1339
 Comag 1412
 Digiturk 1076
 DirecTV 0099, 0392, 0639, 1076,
 1142, 1377, 1392, 1442,
 1443, 1444, 1640
 Dish Network System 0775, 1505
 Dishpro 0775, 1505
 Dream Multimedia 1237
 Echostar 0610, 0775, 1170, 1505
 Expressvu 0775
 Foxtel 1356
 GbSAT 1214
 Grundig 1150
 Hughes Network 1142, 1442, 1443, 1444
 Systems
 Humax 1176, 1427, 1568, 1670,
 1675

Hyundai 1159
 JVC 1170
 Kathrein 1221, 1561
 Maximum 1334
 Motorola 0869
 Nokia 1311
 Opentel 1412
 Pace 1423, 1623
 Panasonic 1320
 Philips 0099, 1142, 1442
 Proscan 0392
 RCA 1392
 Rebox 1214
 Sagem 1253, 1307
 Samsung 1442
 Sharp 1489
 Siemens 1657
 SKY 1175, 1848
 Skyplus 1412
 Sony 0639, 1640
 Star Choice 0869
 Strong 1300
 Thomson 1900
 Topfield 1206, 1545
 TPS 1253, 1307
 Zehnder 1075, 1412

DVD/DVR
 DVD/DVR combination

Go Video 1730
 Mustek 1730
 Panasonic 1807, 0490, 1010, 1011
 Philips 1340, 0539, 1158, 1818
 Pioneer 1337, 0631, 1816
 RCA 0880, 0522
 Sharp 1256
 Tivo 1337, 1816
 Toshiba 1008, 1503





289769-001

BOSE[®]
Better sound through research[®]

©2007 Bose Corporation, The Mountain,
Framingham, MA 01701-9168 USA
289769 AM Rev.01 CCM-001770