



GUIDE FOR

DYNAMIC POSITIONING SYSTEMS

NOVEMBER 2013 (Updated May 2018 – see next page)

**American Bureau of Shipping
Incorporated by Act of Legislature of
the State of New York 1862**

**© 2013-2018 American Bureau of Shipping. All rights reserved.
ABS Plaza
16855 Northchase Drive
Houston, TX 77060 USA**

Updates

May 2018 consolidation includes:

- February 2016 version plus Notice No. 2 and Corrigenda/Editorials

February 2016 consolidation includes:

- September 2015 version plus Corrigenda/Editorials

September 2015 consolidation includes:

- July 2014 version plus Notice No. 1

July 2014 consolidation includes:

- November 2013 version plus Corrigenda/Editorials

Foreword

The application of dynamic positioning (DP) systems has been expanded significantly not only in the number of DP vessels, but also in the range of applications and the advancement of DP technologies. In order to address this variety and the needs of industry, ABS undertook to develop an *ABS Guide for Dynamic Positioning Systems*. The Guide replaces ABS DP system requirements currently included in the *ABS Rules for Building and Classing Steel Vessels (Steel Vessel Rules)* and the *ABS Rules for Building and Classing Offshore Support Vessels (OSV Rules)*.

In addition to the current requirements, the Guide provides new optional notations and technical specifics that reflect current industry practice and DP technologies. The Guide covers ABS requirements for the design and testing of DP systems with the following new features:

- Enhanced system (EHS) notations to recognize design features beyond current DPS-series notations and to provide flexibility to owners and operators.
- Station keeping performance (SKP) notations to recognize DP capability and to encourage robust design of the DP system.
- Increased level of detail on the technical requirements to help less experienced users
- Details of vessel type specifics to reflect industry need
- Requirements for testing comparable with current industry practice.

The Guide is applicable to systems that are installed onboard vessels, offshore installations and facilities. It is applicable to new constructions.

This Guide becomes effective on **the first day of the month of publication**.

Users are advised to check periodically on the ABS website www.eagle.org to verify that this version of this Guide is the most current.

We welcome your feedback. Comments or suggestions can be sent electronically by email to rsd@eagle.org.



GUIDE FOR DYNAMIC POSITIONING SYSTEMS

CONTENTS

SECTION 1	General	1
1	Introduction	1
3	Classification Notation	1
5	Definitions	2
5.1	General	2
5.3	Equipment and Dynamic Positioning System	3
5.5	Redundancy Design	4
5.7	Performance and Operation	5
7	Documentation	5
7.1	Dynamic Positioning System	6
7.3	Power System	6
7.5	Thruster System	6
7.7	DP Control System	7
9	Certification	7
9.1	Control and Monitoring System Equipment	7
9.3	Components and Subsystems	7
SECTION 2	Dynamic Positioning System Design	8
1	General	8
3	DP System Technical Requirements	8
3.1	Basic Requirements	8
3.3	Redundancy Design	8
3.5	Physical Separation	10
3.7	DP System Equipment Requirements	10
3.9	Station Keeping Performance	10
5	Essential Non-DP Systems	13
5.1	General	13
5.3	Emergency Shutdown System and DP Redundancy	13
5.5	Fire Protection	13
5.7	Fuel Quick Closing Valves	13
7	Alarms, Monitoring and Instrumentation	13
9	Communications and DP Alert System	14
9.1	Communications	14
9.3	DP Alert System	15

11	Failure Mode and Effects Analysis	15
11.1	General.....	15
11.3	Failure Mode Analysis	15
11.5	FMEA Report.....	17
13	DP Operations Manual.....	18
TABLE 1	Summary of DP System Requirements for ABS DPS Notations	12
TABLE 2	Summary of Minimum Instrumentation at DP Control Station	14
SECTION 3	Power Systems.....	19
1	General	19
3	Power Generation System.....	19
3.1	Vessels with DPS-1 Notation.....	19
3.3	Vessels with DPS-2 Notation.....	19
3.5	Vessels with DPS-3 Notation.....	20
5	Power Distribution.....	20
5.1	General.....	20
5.3	Vessels with DPS-2 or DPS-3 Notations	20
7	Power Management System.....	21
9	Uninterruptible Power Supply Systems (UPS).....	22
SECTION 4	Thruster System	23
1	General	23
3	Thruster Capacity.....	23
5	Thruster Configuration	23
7	Thruster Auxiliary System.....	23
9	Thruster Control.....	24
9.1	General.....	24
9.3	Control Parameter	24
9.5	Manual Thruster Control.....	24
9.7	Emergency Stop.....	24
11	Thruster Monitoring and Alarm	25
SECTION 5	Control System.....	26
1	General	26
3	DP Control Station	26
3.1	General.....	26
3.3	Arrangement of DP Control Station	26
3.5	Arrangement of DP Control Systems	27
3.7	Arrangement of Control Panels	27
3.9	Arrangement of Data Communication Networks	27

5	DP Control System	27
5.1	General	27
5.3	External Force	28
5.5	Vessels with DPS-2 Notation	28
5.7	Vessels with DPS-3 Notation	28
7	Manual Position Control System	28
9	Control Mode Selection	28
9.1	Manual/DP Control Modes	28
9.3	Main/Backup Control Station	29
11	Position Reference System and Environment Sensor	29
11.1	General	29
11.3	Vessels with DPS-0 or DPS-1 Notation	30
11.5	Vessels with DPS-2 Notation	30
11.7	Vessels with DPS-3 Notation	30
11.9	Signal Processing	30
13	Consequence Analysis (For DPS-2 and DPS-3)	31
15	Display and Monitoring	31
SECTION 6	Auxiliary Systems (applies to DPS-2 and DPS-3)	32
1	General	32
3	Fuel Oil	32
5	Cooling Water	32
7	Compressed Air	33
9	Lubrication Oil Systems	33
11	HVAC and Ventilation	33
13	Piping	33
15	Pneumatic Systems	33
17	Power Supply to Auxiliary Systems	33
SECTION 7	DP System Initial Test	34
1	General	34
3	DP System Performance Test	34
3.1	Uninterruptible Power Supply Systems (UPS)	34
3.3	Position Reference Systems and Sensors	34
3.5	Manual Position Control System	34
3.7	Manual Thruster Control System	34
3.9	Thruster Emergency Stop	34
3.11	DP Control System	35
3.13	Control and Alarms	35
3.15	Standby Changeover	35
3.17	Protection Function	35
3.19	Communication	35
3.21	DP Endurance Test	35
5	FMEA Proving Trial for DPS-2 or DPS-3	36

SECTION 8	Enhanced System (EHS)	37
1	Introduction	37
3	Enhanced System for DPS-2 and DPS-3	37
3.1	Enhanced Power and Thruster System (EHS-P).....	38
3.3	Control System (EHS-C)	41
3.5	Fire and Flood Protection (EHS-F)	42
5	Summary of System Requirements for Enhanced System Notations.....	43
7	Closed Bus and Standby Start.....	44
7.1	General.....	44
7.3	Closed Bus Operation	44
7.5	Standby Start.....	44
7.7	FMEA and Testing.....	44
9	Documentation.....	45

TABLE 1	Summary of DP System Requirements for EHS Notations	43
----------------	---	-----------

SECTION 9	Station Keeping Performance	46
1	General	46
1.1	Definition	46
3	Environmental Conditions.....	47
3.1	Wind.....	47
3.3	Wave and Wave Spectrum.....	47
3.5	Current	48
3.7	Environments for SKP(a,b,c,d,e,f) Notation.....	48
3.9	Environments for SKP Notation.....	49
5	Analysis Conditions.....	49
5.1	DP System Configurations	49
5.3	Operating Conditions.....	49
7	Environmental Load Calculation	49
7.1	Wind and Current Force	50
7.3	Wave Force.....	50
9	Other External Loads	50
11	Available Thrust	50
11.1	Available Thrust for Thrusters	50
11.3	Thruster-Thruster Interaction.....	50
11.5	Thruster-Hull Interaction.....	51
11.7	Thruster-Current Interaction	51
11.9	Tunnel Thruster	51
13	Rudder Forces	51
15	SKP Calculations	52
15.1	SKP Notation.....	52
15.3	SKP(a,b,c,d,e,f) Notation.....	52
17	Documentation.....	52

TABLE 1	Relationship between Wind and Wave (North Sea)	49
----------------	---	-----------

SECTION 10	Specific Vessel Types	53
1	Introduction	53
3	Mobile Offshore Drilling Units	53
3.1	Basic Design Criteria for DP System	53
3.3	Position Reference Systems and Sensors	53
3.5	Effect of Drilling Loads	53
3.7	Vessel Operating Condition	53
3.9	Emergency Shutdown System	54
3.11	Emergency Disconnect System	54
3.13	Maintenance Plan	54
3.15	FMEA	55
3.16	DP Alert System	55
3.17	DP Operations Manual	55
3.19	Documentation	55
5	Project or Construction Vessels	55
5.1	Basic Design Criteria for DP System	55
5.3	Operation Configuration	56
5.5	Position Reference Systems and Sensors	56
5.7	Maintenance Plan	56
5.9	FMEA	56
5.10	DP Alert System	56
5.11	DP Operations Manual	56
7	Logistics Vessels	57
7.1	Operation Mode	57
7.3	Position Reference Systems and Sensors	57
7.5	DP Operations Manual	57
SECTION 11	Other Optional Notations	58
1	Introduction	58
3	Integrated Software Quality Management for DP System	58
5	System Verification for DP System	58
APPENDIX 1	Available Thrust Assessment	59
1	General	59
3	Thrust at Bollard Pull	59
5	Thruster-Thruster Interaction	60
5.1	In Line Tandem Condition	61
5.3	Upstream Thruster Turned Tandem Configuration	62
5.5	Forbidden Zones	63
7	Thruster-Hull Interaction	64
7.1	Friction	64
7.3	Coanda Effect	64
7.5	Pontoon Blockage	64
7.7	Tilted Thruster/Nozzle	64
9	Thruster-Current Interaction	65

11	Tunnel Thrusters.....	66
11.1	Simplified Method.....	67
11.3	Detailed Method.....	68
TABLE 1	Range of Forbidden Zone for Different x/D	63
FIGURE 1	Open Propellers.....	59
FIGURE 2	Ducted Propellers.....	60
FIGURE 3	Thrusters Configuration in Tandem Condition.....	61
FIGURE 4	Thrust Reduction of the Downstream Thruster in Open Water.....	61
FIGURE 5	Thrusters Configuration in Tandem Condition Turning the Upstream Thruster.....	62
FIGURE 6	Thrust Reduction of the Downstream Thruster Considering Steering Angles of the Upstream Thruster.....	62
FIGURE 7	Range of Forbidden Zone.....	63
FIGURE 8	Thrust Reduction Ratio due to Hull Friction.....	64
FIGURE 9	Correction Factor, C , as the Function of the Tilt Angle of the Propeller Shaft.....	65
FIGURE 10	Thrust Ratio for Ducted Propellers.....	65
FIGURE 11	Thrust Ratio for Open Propellers.....	66
FIGURE 12	Dimensions of Transverse Tunnel Thrusters.....	67
FIGURE 13	Tunnel Configuration.....	68
FIGURE 14	Protective Bars Cross Section.....	69
APPENDIX 2	Rudder Forces.....	70
FIGURE 1	High-performance Rudder.....	70
FIGURE 2	Steerable Nozzle with Flap.....	70
FIGURE 3	Steerable Nozzle with Fixed Fin.....	71
FIGURE 4	Conventional Rudder.....	71
APPENDIX 3	Abbreviations and References.....	72
1	Abbreviations.....	72
3	References.....	73
3.1	ABS Publications.....	73
3.3	Other Publications.....	73

This Page Intentionally Left Blank



SECTION 1 General

1 Introduction

The requirements contained in this Guide are for dynamic positioning systems for ships, mobile offshore drilling units, mobile offshore units and offshore support vessels. These requirements are to be used in conjunction with Part 4 of the *ABS Rules for Building and Classing Steel Vessels (Steel Vessel Rules)*, Parts 4, 6, and 7 of the *ABS Rules for Building and Classing Mobile Offshore Drilling Units (MODU Rules)* and the *ABS Rules for Survey After Construction (Part 7)*. The requirements in the following sections are particularly relevant.

ABS Rules for Building and Classing Steel Vessels

- i) Diesel Engines – Section 4-2-1
- ii) Gas Turbines – Section 4-2-3
- iii) Electric Motors and Motor Controllers – Section 4-8-3
- iv) Gears – Section 4-3-1
- v) Shafting – Section 4-3-2
- vi) Propellers – Section 4-3-3
- vii) Piping System – Chapter 4-6
- viii) Thrusters – 4-3-5/3 and 4-3-5/5
- ix) Control Equipment and Systems – Section 4-9-8

ABS Rules for Building and Classing Mobile Offshore Drilling Units

- i) Pumps and Piping Systems – Chapter 4-2
- ii) Electrical Installation – Chapter 4-3
- iii) Rules for Equipment and Machinery Certification – Part 6
- iv) Survey After Construction – Chapter 7-2

ABS Rules for Survey After Construction

- i) Machinery Surveys – Chapter 7-6
- ii) Shipboard Automatic and Remote-control Systems – Chapter 7-8
- iii) Survey Requirements for Additional Systems and Services – Chapter 7-9

3 Classification Notation

The dynamic positioning systems built and tested in compliance with the requirements in this Guide and relevant Rules may be assigned with different classification notations depending on the degree of redundancy built into the system as defined below. These notations are not a requirement for classification of the vessel and are to be assigned only on the specific request of the Owner.

DPS-0 For vessels, which are fitted with centralized manual position control and automatic heading control system to maintain the position and heading under the specified maximum environmental conditions.

DPS-1 For vessels, which are fitted with a dynamic positioning system which is capable of automatically maintaining the position and heading of the vessel under specified maximum environmental conditions having a manual position control system.

DPS-2 For vessels, which are fitted with a dynamic positioning system which is capable of automatically maintaining the position and heading of the vessel within a specified operating envelope under specified maximum environmental conditions during and following any single fault, excluding a loss of compartment or compartments.

DPS-3 For vessels, which are fitted with a dynamic positioning system which is capable of automatically maintaining the position and heading of the vessel within a specified operating envelope under specified maximum environmental conditions during and following any single fault, including complete loss of a compartment due to fire or flood.

DPS-1, DPS-2 and DPS-3 classification notations are structured in line with the IMO MSC/Cir.645 “*Guidelines for Vessels with Dynamic Positioning Systems*”. **DPS-1, DPS-2 and DPS-3** are in line with IMO equipment class of **1, 2 and 3**, respectively.

At the Owner’s request, an enhanced system notation (**EHS**), as a supplement for DPS-series notations, may be assigned. The notation provides the basis for the measurement of the enhancement of critical components of the DP system, including power system, thruster system and control system. The main objective of the enhanced system notation is to improve reliability, operability and maintainability. Section 8 of this Guide provides details for the enhanced system notations.

Also, at the Owner’s request, a station keeping performance notation (**SKP**), as a supplement to the **DPS**-series notations may also be assigned to the vessel. The objective of the station keeping performance notation is to recognize the DP capability and to encourage robust design of DP systems. Section 9 of this Guide provides details for station keeping performance requirements.

Section 11 of this Guide provides information about other optional notations that may apply to DP systems such as those for Integrated Software Quality Management (**ISQM**) and Software System Verification (**SSV**).

5 Definitions

The following definitions of symbols and terms are to be understood (in the absence of other specifications) where they appear in the Guide.

5.1 General

Dynamically Positioned Vessel (DP Vessel): A unit or a vessel which automatically maintains its position (fixed location or predetermined track) by means of thruster force.

Industrial Mission: The industrial mission is the primary operational role of the vessel, typically applicable to MODUs and Project and Construction vessels (e.g., Pipe-lay/Heavy-lift). (Note: by definition the industrial mission for a Logistic Vessel is to support logistics).

Specified Maximum Environmental Conditions: The specified maximum environmental conditions are the specified wind speed, current and wave height under which the vessel is designed to carry out intended operations.

Specified Operating Envelope: The specified operating envelope is the area within which the vessel is required to stay in order to satisfactorily perform the intended operations under the specified maximum environmental conditions.

Worst Case Failure (WCF): The identified single fault in the DP system resulting in maximum effect on DP capability as determined through the FMEA study. This worst case failure is to be used in the consequence analysis.

Worst Case Failure Design Intent (WCFDI): The worst case failure design intent describes the minimum amount of propulsion and control equipment remaining operational following the worst case failure. The worst case failure design intent is used as the basis of design. This usually relates to the number of thrusters and generators that can simultaneously fail.

5.3 Equipment and Dynamic Positioning System (1 November 2013)

Active Component: Active components or systems are in particular: generators, thrusters, switchboards, DP control computers, sensors, remote controlled valves, compensators, etc.

Static Component: Static components are in particular: cables, pipes, manual valves, etc.

Dynamic Positioning System (DP System): The complete installation necessary for dynamically positioning a vessel comprises the following subsystems.

- i) Power system,
- ii) Thruster system, and
- iii) DP control system.

Power System: All components and systems necessary to supply the DP system with power, the power system includes:

- i) Prime movers with necessary auxiliary systems including piping,
- ii) Generators,
- iii) Switchboards,
- iv) Electrical distribution system (cabling and cable routing) and
- v) Power management if applicable.

Thruster System: All components and systems necessary to supply the DP system with thrust force and direction. The thruster system includes:

- i) Thrusters with drive units and necessary auxiliary systems including piping,
- ii) Main propellers and rudders if these are under the control of the DP system,
- iii) Thruster control electronics,
- iv) Manual thruster controls, and
- v) Associated cabling and cable routing.

DP Control System: All control components and systems, hardware and software necessary to dynamically position the vessel. The DP control system consists of the following:

- i) Computer system/joystick system,
- ii) Position reference systems,
- iii) **DP sensor system**
- iv) Display system (operator panels), and
- v) Associated cabling and cable routing.

Computer System: A system of one or more programmable electronic devices, associated software, peripherals and interfaces. Microprocessors, Programmable Logic Controller (PLC), Distributed Control Systems (DCS), PC or server-based computation systems are examples of computer-based systems."

Interface: A transfer point at which information is exchanged. Examples of interfaces include: input/output interface (for interconnection with sensors and actuators); communications interface (to enable serial communications/networking with other computers or peripherals).

Peripheral: A device performing an auxiliary function in the system (e.g., printer, data storage device).

Joystick System: A system for manual position control and with automatic heading control.

Position Reference System: All hardware, software and sensors that supply information necessary to give position references.

DP Sensor System: A system comprising devices that measure vessel heading (such as gyro compasses), vessel motions (such as motion reference units), and wind speed and direction.

Consequence Analyzer: A software function that issues an alarm if the vessel would not be able to keep position and heading after predefined worst case failure has occurred at current operation mode and weather conditions. Additionally, the consequence analyzer is to be able to perform calculations to verify that in the event of a single fault there will be sufficient thrust available to maintain position and heading.

Control Mode: Method used for station keeping. Control mode for a DP system may be:

- i) DP **control** mode (automatic position and heading control),
- ii) Manual position control mode (centralized manual position control with selectable automatic or manual heading control),
- iii) Auto track mode (considered as a variant of DP position control, with programmed movement of reference point),
- iv) Manual thruster control mode (individual control of thrust (pitch or speed), azimuth, start and stop of each thruster).

Manual Position Control System: A system with centralized manual position control and automatic heading control, referred to as a joystick system.

Manual Thruster Control System: A system provides an individual control **lever** for each thruster.

Phase back: A method utilized to temporarily reduce power consumption following an event, to stabilize the power plant and avoid a black-out.

5.5 Redundancy Design

Autonomous System: An autonomous system is a system that can control and operate itself, independently of any control system or auxiliary systems not directly connected to it.

Closed Bus: Closed bus often describes an operational configuration where all or most sections and all or most switchboards are connected together, that is, the bus-tie breakers between switchboards are closed. The alternative to closed bus is open bus, sometimes called split bus or split ring. Closed bus is also called joined bus, tied bus or closed-ring.

Common Mode Failure: A common mode failure occurs when events are not statistically independent, when one event causes multiple systems to fail.

Critical Redundancy: Equipment provided to support the worst case failure design intent.

Differentiation: Differentiation is a method to avoid common mode failures by introducing a change of producer of redundant systems based on the same principle.

Fail Safe Condition: The system is to return to a safe state in the case of a failure or malfunction.

Hidden Failure: a failure that is not immediately evident to operations and maintenance personnel, such as protective functions on which redundancy depends.

Independence: An independent system is a system that can operate without the assistance of central control or other systems or subsystems. In this Guide it is mainly in reference to main machinery such as generators and thrusters. Auxiliary and control functions are to be provided in a manner that makes the machinery as independent as practical to minimize the number of failures that can lead to the loss of more than one main item of machinery.

Non-critical Redundancy: Equipment provided over and above that required to support the worst case failure design intent. Its purpose is to improve the reliability and availability of systems.

Physical Separation: With reference to DPS-3 vessels, fire and watertight subdivisions required to support the worst case failure design intent in respect of DPS-3 failure criteria.

Redundancy: Ability of a component or system to maintain or restore its function, when a single fault has occurred. Redundancy can be achieved for instance by installation of multiple components, systems or alternative means of performing a function.

Redundancy Concept: The means by which the worst case failure design intent is achieved. It is to be documented as part of the preliminary design process.

Redundant Groups (Subsystems): Two or more component groups each of which is capable of individually and independently performing a specific function.

Separation: (Redundant systems) Separation is to reduce the number of connections between systems to reduce the risk that failure effects may propagate from one redundant system to another.

Single Fault: The single fault is an occurrence of the termination of the ability to perform a required function of a component or a subsystem in the DP system. For vessels with **DPS-3** notation, the loss of any single compartment is also to be considered a single fault.

Single Fault Tolerance: The ability of a system to continue its function, following a single fault, without unacceptable interruption.

5.7 Performance and Operation (1 November 2013)

Availability: (IEC 191-02-05) Availability is the ability of an item to be in a state to perform a required function under given conditions at a given instant of time or over a given time interval, assuming that the required external resources are provided. This ability depends on the combined aspects of the reliability performance, the maintainability performance and the maintenance support performance.

Loss of Position: The vessel's position is outside the limits set for carrying out the industrial activity in progress.

DP Capability/Station Keeping Analysis: A theoretical calculation of the vessel's capability to maintain position under particular conditions of wind, waves and current from different directions. It is to be determined for different thruster combinations, (e.g., all thrusters, loss of most effective thrusters, WCF).

Maintainability: (IEC 191-02-07): The ability of an item under given conditions of use, to be retained in, or restored to, a state in which it can perform a required function, when maintenance is performed under given conditions and using stated procedures and resources within a stated time.

Operability: Service operability performance (IEC 191-19-06): The ability of a service to be successfully and easily operated by a user.

Spinning Reserve: The difference between the total capacity of the running generators and the consumed power.

Station Keeping: Maintaining a desired position within the normal excursions of the control system and under the defined environmental conditions.

System Flexibility: The ability of a system to adapt to internal or external changes to allow its primary mission to be satisfied.

Time to Terminate: This time is calculated as the amount of time required in an emergency to physically free the DP vessel from its operational activity following a DP abort status and allowing it to be maneuvered clear and to proceed to safety.

7 Documentation

Where one of the classification notations described in Subsection 1/3 is requested, the following plans, data and documentations are to be submitted for review as applicable. These documentation requirements are in addition to the requirements for the vessel's mandatory classification notations. The requirements on the extent of the documents are given in the related Sections of this Guide. The following symbols are used in this Section for the type of review of the documents

R: Documents to be reviewed

I: Documentation for information and verification for consistency with related review.

OB: Documentation which needs to be kept onboard

7.1 Dynamic Positioning System

Documents listed in this section are mainly related to the global functionality, performance and characteristics of an integrated DP system.

- i)* DP Operations Manual (**R, OB**)
- ii)* System description including a block diagram showing how the various components are functionally related (**R**)
- iii)* Details of the DP alarm system and any interconnection with the main alarm system (**R**)
- iv)* General Arrangement drawing for DP Control Station including control console, control panel, layout of Navigation bridge deck, list of equipment, etc. (**R**)
- v)* Failure modes and effects analysis (FMEA) (**DPS-2, DPS-3**) (**R, OB**)
- vi)* DP station keeping capability analysis including environmental force calculation, thruster force calculation and capability polar plots for normal operational case and for post Worst Case Failure operational case (**R**)
- vii)* DP system testing plan (**R, OB**)
- viii)* Cable routing layout (**DPS-3**) (**R**)
- ix)* Details of the emergency stop system for thrusters (**R**)
- x)* Specification of safe operating envelope of environmental conditions for DP operation (**I**)
- xi)* Basic design of DP system redundancy (**DPS-2, DPS-3**) (**R**)
- xii)* Description of vessel emergency shutdown (ESD) system if applicable (**I**)
- xiii)* Description of emergency disconnecting system (EDS) if applicable (**I**)
- xiv)* Planned inspection and maintenance (**I, OB**)

7.3 Power System

Documents listed in this section are mainly related to the power system including all components and subsystems necessary to supply the DP system with power.

- i)* Electrical power generation system (**R**)
- ii)* Power distribution system (**R**)
- iii)* Load analysis (**R**)
- iv)* Auxiliary system distribution (**R**)
- v)* Uninterruptable power supply system (**R**)
- vi)* Description of bus-tie breaker protective functions where applicable (**R**)

7.5 Thruster System

- i)* Thruster system arrangement (**R**)
- ii)* Thruster control system (**R**)
- iii)* Thrust output and power input curves (**I**)
- iv)* Thruster auxiliary system (**R**)
- v)* Thruster monitoring system (**R**)
- vi)* Description of emergency stop system for thrusters (**R**)
- vii)* Thrust response time for thrust and direction changes (**I**)
- viii)* Thrust reductions due to interaction effects (**I**)
- ix)* Manufacturer test procedure (**R**)

- x)* DP trial test procedure (**R, OB**)
- xi)* Manual for operation and maintenance (**I, OB**)

7.7 DP Control System

- i)* DP Control system, scope and arrangement (**R**)
- ii)* Details of the position reference system and environmental monitoring systems (**R**)
- iii)* Details of the consequence analyzer (**DPS-2, DPS-3**) (**R**)
- iv)* Certification of suitability of control equipment for the marine atmosphere (**I, OB**)
- v)* Control system functional description (**I**)
- vi)* Manufacturers' equipment operation documents (**R**)
- vii)* Software quality plan (**I**)
- viii)* FMEA of DP control system (**DPS-2, DPS-3**) (**R, OB**)
- ix)* Manufacturer test procedure (**R, OB**)
- x)* DP trial test procedure (**R, OB**)
- xi)* Manual for operation and maintenance (**I, OB**)

9 Certification

9.1 Control and Monitoring System Equipment

Control and monitoring (alarms and instrumentation) system equipment used in a DP control system to be assigned a **DPS** notation is to be certified for suitability in the marine environment.

Hydraulic and pneumatic piping systems associated with the thruster system are to be subjected to pressure tests at 1.5 times the relief-device setting using the service fluid in the hydraulic system and dry air or dry inert gas for pneumatic systems as testing media. The tests are to be carried out in the presence of a Surveyor.

9.3 Components and Subsystems

The components and subsystems associated with the dynamic positioning system are to be certified or type approved according to the vessel's mandatory classification notation.



SECTION 2 Dynamic Positioning System Design

1 General

The dynamic positioning (DP) system includes subsystems of power supply system, thruster system and DP control system. Those subsystems and related components are to meet the requirements for the vessel's mandatory classification notations.

This Section provides general requirements for a DP system with a **DPS**-series notation. More detailed requirements for each subsystem are given in Sections 3, 4, 5 and 6 respectively.

Section 8 of this Guide provides the requirements for enhanced system notations (**EHS**) and Section 9 provides the requirements for station keeping performance notation (**SKP**).

3 DP System Technical Requirements

3.1 Basic Requirements

A DP system is to be designed to have a certain level of station keeping capability, reliability and redundancy. The class notation of DP System addresses the reliability based on the redundancy and fault tolerance of the DP system.

- i) For a vessel with the notation **DPS-0**, or **DPS-1**, a loss of position may occur in the event of a single fault.
- ii) For a vessel with the notation **DPS-2**, a loss of position may not occur in the event of a single fault in any active component or system, excluding a loss of compartment or compartments.
- iii) For a vessel with the notation **DPS-3**, a loss of position may not occur in the event of a single fault in any active or static component or system, including complete loss of a compartment due to fire or flood.
- iv) The redundant components and systems are to be immediately available and with such capacity that the DP operation can continue for such a period that the work in progress can be terminated safely.
- v) The period for safely terminating a work in progress is to be specified by the Owner.

The selection of the level of DP class notation of the vessel for a particular operation is outside the scope of this Guide. Some Coastal States impose minimum DP Equipment Class requirements for activities carried out within their jurisdiction.

The station keeping capability is normally presented by the limiting environmental conditions under which the vessel can maintain the position and heading. The limiting environmental conditions and operational modes for a DP vessel are to be defined by the Owner.

3.3 Redundancy Design

3.3.1 DPS-Series Notations

For the notation **DPS-0** and **DPS-1**, there is no requirement for redundant systems.

For the **DPS-0** notation, the dynamic positioning system is to have a manual position control system.

For the **DPS-1** notation, the dynamic positioning system is to include an automatic dynamic positioning system and a manual position control system.

A vessel with **DPS-2** or **DPS-3** notation is required to have an automatic dynamic positioning system, manual position control system and to be single fault tolerant.

The single fault tolerance is to be achieved by the design of redundant systems. The station keeping capability after a single fault is to be achieved by providing control, electric power and thrust.

For the **DPS-2** notation, static components will normally not be considered to fail.

For the **DPS-2** notation, a single fault includes:

- i)* Any active component or system (generators, thrusters, switchboards, DP control computers, sensors, remote controlled valves, etc.)

For the **DPS-3** notation, a single fault includes:

- i)* Items listed above for **DPS-2**, and any normally static component is assumed to fail
- ii)* Any components in any one watertight compartment from flooding
- iii)* Any components in any one fire subdivision from fire

3.3.2 Consideration of Redundancy

- i)* The redundancy is to have two or more items of equipment or system required to perform a function so that the redundant unit can take over from the failed unit without unacceptable interruption of the function.
- ii)* Redundancy is to be based on systems which are immediately available for use, namely on running machinery. In general, full stop and restart of the system do not comply.
- iii)* Automatic start of equipment may be accepted as contributing to redundancy only if they can be tested to prove that they can be brought into operation before position and heading keeping performance is degraded.
- iv)* The redundancy depends on systems being available in both number and capacity to produce the required DP capability after worst case failure. Independence of redundancy groups is to take into account all technical functions.
- v)* The redundancy design can consist of two fully redundant power and thruster systems each capable of maintaining position and heading if the other fails. The design can also make use of multiple systems each providing partial redundancy such that the vessel can maintain position with all combinations of independent systems that survive any defined fault. The redundancy design is to provide suitable combinations of available systems following any defined fault.
- vi)* The transfer of failures between redundant subsystems is to be prevented by separation of the redundant systems.
- vii)* The failure of redundant components or systems is to be revealed by alarms. The possibility of hidden failures is to be minimized through periodic testing.

3.3.3 Basic Design of Redundancy and Redundancy Concept

Basic design of redundancy and the redundancy concept of the DP system are to be developed at the early design stage and are to be submitted to ABS for review.

The documentation is to include at least the following:

- i)* General arrangement of DP system
- ii)* Worst case failure design intent (WCFDI)
- iii)* Limiting environmental conditions for DP operation
- iv)* Power plant configurations for DP operation
- v)* Allowable loss of power sources after one failure
- vi)* Allowable number of failed thrusters
- vii)* Time period for safely terminating a DP operation after each considered single fault

The documentation is to be reviewed during the design process is to confirm if the worst case failure design intent is met.

The worst case failure design intent is to describe the minimum amount of propulsion and control equipment remaining operational following the worst case failure. The worst case failure design intent is to be used as the basis of the design development.

3.5 Physical Separation

For a vessel with a **DPS-3** notation, the redundancy groups are to be separated by bulkheads and decks that are fire-insulated by A-60 class divisions. The separation is to be watertight if below the damage waterline.

Cables for redundant equipment or systems are not to be routed together through the same compartments.

If not avoidable, cables for redundant systems are to be separated by at least one A-60 barrier. Thus cables associated with one system could be run in an A-60 class duct with the other system running through the compartment or both sets of cables routed through separate ducts.

Redundant piping system (i.e., piping for fuel, cooling water, lubrication oil, hydraulic oil, etc.) is not to be routed together through the same compartments.

If not avoidable, such pipes are to be separated by at least one A-60 barrier. Thus pipe-work associated with one system could be run in an A-60 class duct with the other system running through the compartment or both sets of pipe-work routed through separate ducts.

3.7 DP System Equipment Requirements

To meet the requirements for a DPS-series notation, the minimum number of subsystems and components and the redundancy for: power system, thruster system and DP control system are provided in Section 2, Table 1. The detailed requirements for each subsystem and the arrangement of the equipment are given in Sections 3, 4, 5 and 6, respectively.

3.9 Station Keeping Performance

A DP system is to be designed to be able to maintain the position and heading under the specified limiting environmental conditions. The design environment is to be specified by the owner.

- i)* A vessel with a **DPS-0** or **DPS-1** notation is to be able to maintain position and heading under specified environmental conditions with all thrusters intact.
- ii)* A vessel with a **DPS-2** or **DPS-3** notation is to be able to maintain position and heading under specified environmental conditions during and after any single fault of the DP system.
- iii)* The station keeping performance assessment is to be carried out for:
 - a)* Design environmental conditions
 - b)* Normal operational condition
 - c)* Standby condition (where applicable)
 - d)* All thruster intact condition
 - e)* Worst case failure condition (according to basic design of the redundancy system)
 - f)* Other conditions, such as the failure of the most effective thruster or least effective thruster, may be included in the assessment as well.
- iv)* The environmental load calculations, including those for wind, current and wave drift forces, are to follow suitable procedures. API RP 2SK, *ABS Rules for Mobile Offshore Drilling Units* can be used for environmental load calculation.
- v)* Thruster degradation due to interactions is to be considered in the station keeping capability assessment.
- vi)* Other effects due to industrial activities, such as pipe tension, heavy lift, hawser tension, riser load, etc., are to be taken into account in the station keeping capability analysis.

- vii)* The effect of the vessel's industrial activities on available power for the DP system is also to be considered in the assessment.
- viii)* Station keeping capability can be presented using traditional DP capability plots or using thrust utilization plots.
- ix)* The station keeping capability analysis report is to be submitted for review. The following information is to be included in the report:
 - a)* Vessel general arrangement and main particulars
 - b)* Projected areas for wind and current
 - c)* Available power for DP system
 - d)* Thruster arrangement, maximum thrust
 - e)* Thruster degradation
 - f)* Wind, current and wave force coefficients
 - g)* Wind and wave relationship used where applicable
 - h)* Description of analysis method
 - i)* DP capability plots
 - j)* Thrust utilization under the specified limiting environmental conditions where applicable

TABLE 1
Summary of DP System Requirements for ABS DPS Notations⁽⁴⁾ (1 November 2013)

Subsystem or Component	Equipment	Minimum Requirements for each Classification Notation				Remarks	
		DPS-0 ⁽¹⁾	DPS-1	DPS-2	DPS-3 ⁽⁵⁾		
Power System	Generators and Prime Movers	Non-redundant	Non-redundant	Redundant	Redundant, in separate compartments ⁽⁵⁾	See Subsection 3/3	
	Main Switchboard	1	1	1 with bus-tie	2 with bus-ties, in separate compartments	See Subsection 3/5	
	Bus-tie Breaker	0	0	1	2		
	Distribution System	Non-redundant	Non-redundant	Redundant	Redundant, in separate compartments		
	Power Management ⁽²⁾	No	No	Yes	Yes		
Thrusters	Arrangement of Thrusters	Non-redundant	Non-redundant	Redundant	Redundant, in separate compartments	See Subsection 4/3	
Control System	DP Control: Number of Control Computers	0	1	2	2 + 1 in backup control station	See 5/3.5	
	Manual Position Control: Joystick with Auto Heading	Yes	Yes	Yes	Yes		
	Manual Thruster Control	Yes	Yes	Yes	Yes	See 4/9.5	
	Position Reference Systems	1	2	3	2 + 1 in backup control station	See Subsection 5/11, 10/3.3, 10/5.5, 10/7.3	
	Sensors:	Wind	1	2	3		2 + 1 in backup control station
		MRU ⁽³⁾	0	1	3		2 + 1 in backup control station
		Gyro	1	2	3	2 + 1 in backup control station	
	UPS	0	1	2	2 + 1 in separate compartment	See Subsection 3/9	
	Backup Control Station for Backup Unit	N/A	N/A	N/A	Yes	See 5/9.3	
	Consequence Analyzer	No	No	Yes	Yes	See Subsection 5/13	
	FMEA	No	No	Yes	Yes	See Subsection 2/11	

Notes:

- 1 **DPS-0** is an ABS system class. It is a manual position control system fitted with automatic heading control and with a free-standing position reference system. **DPS-1**, **DPS-2** and **DPS-3** are in line with IMO equipment class 1, class 2 and class 3, respectively.
- 2 If all thrusters are direct diesel drive, a power management system is not required.
- 3 (1 November 2013) If position reference systems are dependent on correction of the measurements for roll and pitch noise, their associated MRUs are required.
- 4 (1 November 2013) For enhanced system (**EHS-P**, **EHS-F** and **EHS-C**), additional information is provided in Section 8, Table 1.
- 5 (1 November 2013) Where “separate compartments” is indicated, the equipment is to be located in separate compartments arranged to support the worst case failure design intent in respect of **DPS-3** failure criteria.

5 Essential Non-DP Systems

5.1 General

The essential non-DP systems, such as common fire suppression systems, engine ventilation systems, emergency shutdown systems, etc., may interfere with the DP system.

The redundancy concept for the DP system is to be followed through to these systems so that actions or failures initiated by these systems do not cause consequences that exceed the worst case failure design intent. The actions initiated by these systems are to be scaled to the detected threat level and are to be addressed in the FMEA of the DP system.

5.3 Emergency Shutdown System and DP Redundancy

The DP system is not to be affected by failures of the emergency shutdown systems. For DPS-2 that will include any failure in the shutdown systems and for DPS-3 it will include the effect of fire on associated cabling and piping in any compartment.

The effect on the DP system due to any reasonable act of mal-operation is to be considered. This means that the shutdown systems is treated in the same way as any other part of the vessel's DP system that meet the same redundancy requirements and have their failure modes analyzed in the FMEA of the DP system.

In spaces such as thruster rooms and auxiliary machinery spaces, an immediate effect on DP systems due to a spurious shutdown of ventilation is to be prevented and to be confirmed during FMEA proving trials.

5.5 Fire Protection

Fixed firefighting systems may include CO₂ or other fire suppressant agents such as water mist. These systems are to be arranged in a manner that supports the overall divisions in the DP redundancy concept.

Where possible, the release of the fire suppressant is to only affect one redundant machinery group.

5.7 Fuel Quick Closing Valves

These valves are provided to allow rapid isolation of fuel supplies in emergency situations. The valves are to be provided in line with the requirement of the vessel's mandatory classification notations. They are to be arranged in a manner that allows fuel to be isolated to only one redundant machinery group without affecting the operation of any others.

7 Alarms, Monitoring and Instrumentation

The main purpose of the alarm and monitoring system is to give the DP operators the abnormal condition and status information they require to maintain safe and efficient operation of the system. Information relating to power management, propulsion, ballast control, HVAC, etc., are to be available.

The displays and alarms as specified in Section 2, Table 2 are to be provided at DP control stations, as applicable.

Section 2, Table 2 provides the summary of minimum basic instrumentation at the main DP control station. Additional instrumentation may be necessary. The detailed information for displays and alarms for the DP system's components and subsystems are given in Sections 3, 4, 5, and 6 respectively.

TABLE 2
Summary of Minimum Instrumentation at DP Control Station (1 November 2013)

<i>System</i>	<i>Monitored Parameters</i>	<i>Alarm</i>	<i>Display</i>
Thruster Power System (See Subsections 4/9 & 4/11)	Engine lubricating oil pressure – low	x	
	Engine coolant temperature – high	x	
	CPP hydraulic oil pressure – low and high	x	
	CPP hydraulic oil temperature – high	x	
	CPP pitch		x
	Thruster RPM		x
	Thruster direction		x
	Thruster motor/semiconductor converter coolant leakage	x	
	Thruster motor semiconductor converter temperature		x
	Thruster motor short circuit	x	
	Thruster motor exciter power available		x
	Thruster motor supply power available		x
	Thruster motor overload	x	
	Thruster motor high temperature	x	
Thruster operation (on-line/off-line)			x
Power Distribution System (See Subsection 3/5)	Status of automatically controlled circuit breakers		x
	Bus bar current and power levels		x
	High power consumers – current levels		x
	Status of power management system	x	x
	Spinning reserve		
System Performance (See Section 5)	Excursion outside operating envelope	x	
	Control system fault	x	
	Position sensor fault	x	
	Vessels target and present position and heading		x
	Wind speed and direction		x
	Selected reference system		x
Specific Requirements for DPS-2 & DPS-3 (See Section 5)	Thruster location (pictorial)		x
	Available thrust used and thrust vector		x
	Available thrusters on stand-by		x
	Consequence analyzer alert	x	
	Position information of individual position reference systems connected		

9 Communications and DP Alert System

9.1 Communications

Communication is a key management tool during execution. This is to be incorporated in the design phase.

- i) At least, one means of voice communication is to be provided between each DP control station and the navigation bridge, the engine control position, any other relevant industrial function control centers associated with DP and any location required by the vessel’s mandatory classification notation.
- ii) The voice communication system is to be powered by a battery or an uninterruptible power supply system sufficient to operate the system for at least 30 minutes.
- iii) The Communication systems are to be located within easy reach of the DP operator at the DP control stations.

9.3 DP Alert System (1 May 2018)

DP alert statuses in operation are to be clearly defined and are, at least, to have the following three levels

- i) Normal operational status
- ii) Degraded DP status
- iii) DP emergency status

A system of visual and audible alarms are to be provided at each DP control station, on the navigation bridge and at the propulsion engine control position or centralized control station, if fitted. The alarms are to be capable of being manually activated from the DP control stations (including DP back-up control station, if fitted) to indicate DP operational status. Where such an alert system is not easily included the means of clear communication of the statuses are to be agreed before commencement of operations. Section 10 of this Guide provides more detailed information for specific vessel types.

The guidance provided by IMCA M 103 “Guidelines for Design and Operation of Dynamically Positioned Vessel” and by MTS “DP Vessel Design Philosophy Guideline” can be used for the design of DP alert system.

11 Failure Mode and Effects Analysis

11.1 General

FMEA is only applicable to **DPS-2** and **DPS-3** notations. In general, two FMEAs are to be considered, one covering the main DP control systems and the other for all other systems onboard related to DP operations.

The purpose of the FMEA is to indicate whether or not the DP system meets the requirements of the relevant DP notation and complies with the vessel’s WCFDI.

The DP FMEA is to be performed based on this Guide, IMCA M 166, IMCA M 178, IEC 60812, “DP Vessel Design Philosophy Guideline” by MTS, Annex 4 of IMO *High Speed Craft Code* or equivalents.

The objective of the DP FMEA is to, at least, include the following:

- i) Identify and provide recommendations to eliminate or mitigate the effects of all single faults and common mode failures in the vessel DP equipment which, if any occurs, would cause total or partial loss of station keeping capability.
- ii) Demonstrate effective redundancy.
- iii) Identify potential “hidden” failures and determine the effects of a second failure.

Results of the DP FMEA are to be verified during FMEA proving trials. The DP FMEA test program is to be developed based on the analysis results, analysis method and assumptions. The relevant test program is to be provided to ABS for review and approval.

DP FMEA and DP FMEA test programs are to be kept onboard and they are to be updated to cover subsequent alterations to the DP system hardware or software.

11.3 Failure Mode Analysis

For a **DPS-2** or a **DPS-3** notation, loss of position is not allowed to occur in the event of a single fault. Single fault includes, but is not limited to following:

- i) All redundant components, systems or subsystems
- ii) A single inadvertent act of operation (ventilation, fire suppression, ESD) where applicable and if such an act is reasonably probable
- iii) Hidden failures (such as protective functions on which redundancy depends) where applicable
- iv) Common failure modes
- v) Governor and AVR failure modes where applicable
- vi) Main switchboard control power failure modes

- vii)* Bus-tie protection where applicable
- viii)* Power management system
- ix)* DP control system input and output arrangement
- x)* Position reference processing
- xi)* Networks
- xii)* Communication failure
- xiii)* Automatic interventions caused by external events, when found relevant (e.g., automatic action upon detection of gas)

The failure mode analysis is also to include

- i)* The most predictable cause associated with each failure mode
- ii)* The method of detecting that the failure has occurred
- iii)* The effect of the failure upon the rest of the system's ability to maintain position
- iv)* An analysis of possible common failure modes

Where parts of the system are identified as non-redundant and where redundancy is not possible, these parts are to be further studied with consideration given to their reliability and mechanical protection. The results of this further study are to be submitted for review.

When there are more configurations for the diesel electric plant design to cope with equipment unavailability (e.g., failures or equipment taken down for maintenance), it is important that all configurations that are possible to be included in DP operations are to be analyzed in the vessel's DP system FMEA to prove that the DP system remains redundant. Fault tolerance of the configurations is to be made visible and understood by the crew.

An FMEA worksheet is to be compiled for each equipment failure assessment. Some pertinent aspects to be included in the worksheets are:

- i)* System name (including main system, system, and subsystem)
- ii)* Reference drawings
- iii)* Equipment name or number
- iv)* Function description
- v)* Operational mode
- vi)* Failure modes
- vii)* Failure causes
- viii)* Failure effects (including local effect and end effect)
- ix)* Failure detection
- x)* Corrective action
- xi)* Severity of failure effect (providing definitions of categories of severity)
- xii)* Remarks

FMEA worksheet examples given in Appendix 2 of IMCA M 166 or Appendix 2 of Annex 4 of HSC can be used.

11.5 FMEA Report

11.5.1 FMEA Analysis Report

The DP FMEA analysis report is to be sufficiently detailed to cover all the systems associated with the dynamic positioning of the vessel.

The DP FMEA analysis report is to be a self-contained document including, but not limited to the following:

- i)* A brief description of the vessel, vessel's worst-case failure design intent and whether the analysis has confirmed or disproved it
- ii)* Definitions of the terms, symbols and abbreviations
- iii)* Analysis method and assumptions
- iv)* A description of all the systems associated with the dynamic positioning of the vessel and a functional block diagram showing their interaction with each other. Such systems would include the DP electrical or computer control systems, electrical power distribution system, power generation, fuel systems, lubricating oil systems, cooling systems, backup control systems, etc.
- v)* System block diagrams are to be included where appropriate
- vi)* A description of each physically and functionally independent item and the associated failure modes
- vii)* A description of the effects of each failure mode alone on other items within the system and on the overall dynamic positioning system
- viii)* Analysis findings and recommendations
- ix)* Conclusions including worst case failure and recommended changes
- x)* Recommended FMEA tests

The FMEA analysis report is to be updated after major modifications and is to be kept onboard the vessel.

11.5.2 FMEA Proving Trial Report

A FMEA proving trial procedure is to be developed as part of the FMEA study. The objective of the FMEA proving trial is to confirm the FMEA analysis findings and also to confirm that essential functions and features upon which the fault tolerance of the DP system depends are functional in so far as it is practical to do so (protections, power management, etc.). The proving trial report is to establish the FMEA test list and the corresponding test procedures including but not limited to the following:

- i)* Purpose of test or failure mode
- ii)* Vessel and equipment setup
- iii)* Test method
- iv)* Expected results
- v)* Observed results
- vi)* Failure detection
- vii)* Failure effects
- viii)* Outstanding or resolved action items
- ix)* Comments
- x)* Witness name, signature and date for each test

After completion of DP proving trials, the final version of DP FMEA analysis and DP proving trial report, including final analysis/conclusions based on actual results from DP testing, are to be submitted.

13 DP Operations Manual

For each vessel, a vessel specific DP system *Operations Manual* is to be prepared and submitted solely for verification that the information in the manual, relative to the dynamic positioning system, is consistent with the design and information considered in the review of the system. One copy of the *Operations Manual* is to be kept onboard. It is to be readily accessible at the DP control location and used by the DP operators as a reference for conducting DP operations.

The DP system *Operations Manual* is intended to provide guidance for the DP operator about the specific DP installations and arrangements of the specific vessel. The DP *Operations Manual* is to include but not be limited to the following information.

- i) Organization and responsibility during DP operations
- ii) DP system operator's and ECR operator's responsibility and manning
- iii) Definitions of the terms, symbols and abbreviations
- iv) A description of all the systems associated with the dynamic positioning of the vessel, including backup systems and communication systems
- v) The block diagram showing how the components are functionally related
- vi) The restriction of maximum environmental condition for DP operation (e.g., wind speed, wave, current, tide, etc.)
- vii) A description of the different operational modes and transition between modes
- viii) A functional description of each system, including backup systems and communication systems
- ix) Operating instructions for the normal operational mode (and the operational modes after a failure) of the DP electrical or computer control systems, manual position control system, manual thruster control system, DP equipment (thrusters, electric motors, electric drives or converters, electric generators, etc.)
- x) Description of fault symptoms with explanation and recommended corrective actions. This could be the reference to specific documents, such as Well Specific Operational Guidelines (WSOG) or Activity Specific Operational Guidelines (ASOG), and the locations of the documents.
- xi) Instructions for tracing faults back to functional blocks or systems. This could be the reference to specific documents, such as functional descriptions of the systems, DP FMEA documents, and the locations of the documents.
- xii) Location check list (e.g., field arrival)
- xiii) Watch keeping check lists (during DP operation)
- xiv) Field arrival trials procedures
- xv) Training and drill (DP related)
- xvi) References to where more specific information can be found onboard the vessel, such as the detailed specific operation instructions provided by the manufacturer of the DP electrical or computer control systems, manufacturer's troubleshooting procedures for vendor-supplied equipment, etc.
- xvii) DP capability plot
- xviii) Incident report instruction and format



SECTION 3 Power Systems

1 General

The power systems are to be in compliance with the relevant Rules for vessel's mandatory classification notations. This Guide provides additional requirements for **DPS-2** and **DPS-3** notations in regard to redundancy and with respect to maximum single failure, as specified for each notation.

IMO MSC/Circ. 645 states:

“For equipment class 2, the power system is to be divisible into two or more systems such that in the event of failure of one system at least one other system will remain in operation. The power system may be run as one system during operation, but is to be arranged by bus-tie breakers to separate automatically upon failures which could be transferred from one system to another, including overloading and short-circuits.”

For equipment class 3, the power system is to be divisible into two or more systems such that in the event of failure of one system, at least one other system will remain in operation. The divided power system is to be located in different spaces separated by A-60 class division. Where the power systems are located below the operational waterline, the separation is to also be watertight. Bus-tie breakers are to be open during operations unless equivalent integrity of power operation can be accepted.”

The above criteria from IMO MSC/Circ. 645 are to be followed in the design of the power system for **DPS-2** and **DPS-3** systems.

3 Power Generation System

3.1 Vessels with DPS-1 Notation

Generators and their distribution systems are, as a minimum, to have the capacity to supply sufficient power to the thrusters to maintain vessel's position within the specified operating envelope in addition to supplying industrial activities and essential ship service loads.

When power is shared, power supply to industrial activities and essential ship service loads is not to affect DP operations.

3.3 Vessels with DPS-2 Notation

In addition to the criteria above for **DPS-1**, generators and their distribution systems are to be sized and arranged for Worst Case Failure of any bus section. Sufficient power is to remain available to supply essential ship service loads, critical operational loads and maintain the vessel's position within the specified post failure operating envelope.

The post failure remaining power plant is to be able to start any non-running load without the associated voltage dip causing any running motor to stall or its control equipment to drop out.

Essential services for generators and their prime movers, such as cooling water and fuel oil systems, are to be arranged such that, with any single fault, sufficient power remains available to supply the essential loads and to maintain position within the specified post failure operating envelope.

3.5 Vessels with DPS-3 Notation

In addition to the criteria above for **DPS-2**, generators and their distribution systems are to be sized and arranged in at least two compartments with A-60 and watertight boundaries so that, if any compartment is lost due to fire or flood, sufficient power is available to maintain position within the specified post failure operating envelope, and to start any non-running load without the associated voltage dip causing any running motor to stall or control equipment to drop out.

Essential services for generators and their prime movers, such as cooling water and fuel oil systems, are to be arranged so that, with any single fault in the systems or the loss of any single compartment, sufficient power remains available to supply the essential loads, the critical operational loads and to maintain position within the specified post failure operating envelope.

5 Power Distribution (1 November 2013)

5.1 General

The switchboard is to be arranged for manual and automatic remote controls and be provided with all necessary alarms, controls and indications to allow local manual control of the power plant.

The distribution system at the main power generation level is to be arranged to reflect the split in the redundancy concept.

The split in the auxiliary power system is to follow the split in the main power generation system to match the worst case failure design intent.

Every UPS and battery system is to have a main power supply from an auxiliary system switchboard appropriate to the split in the redundancy concept and if a backup supply from the emergency switchboard is provided, loss of the emergency switchboard is not to prevent starting of main generators after a blackout.

The status of automatically-controlled circuit breakers is to be monitored as described in Section 2, Table 2.

The bus bar current and power levels are to be monitored as described in Section 2, Table 2. An alarm is to be initiated upon failure of any of the required power supplies.

Spinning reserve, the difference between online generator capacity and consumed power, is to be displayed in the DP control station. The display is to be continuously available and is to be provided for individual bus sections for split bus power arrangements.

5.3 Vessels with DPS-2 or DPS-3 Notations

For **DPS-2** or **DPS-3**, the switchboard is to be designed such that no single fault will result in a total black-out, including failure of all equipment in any fire and/or watertight subdivision for **DPS-3**.

For **DPS-2**, a main bus bar system consisting of at least two sections, with at least one bus-tie breaker between any two bus sections, is to be arranged.

For **DPS-3**, each switchboard room is to be separated by watertight A-60 partitions. A bus-tie breaker on each side of the partition is to be arranged.

Bus-ties are to be designed to prevent a fault from propagating from one bus section to another.

When the DP system is designed including the configuration of closed bus-tie breaker, this breaker is to be:

- i) A circuit breaker capable of breaking the maximum short circuit current in the connected system
- ii) Coordinated in relation to generator breakers to avoid total loss of main power (black-out)

Minimum of two bus-tie breakers are to be provided and to be arranged such that a failure of one bus-tie breaker is not to result in a total blackout. Details of the bus-tie breakers and generator breakers, such as protection settings, coordination study between bus-tie breakers and generator breakers and other related information are to be submitted for review.

Consideration is to be given to effective intelligent detecting and executing methods featuring ultra-fast acting actions by the devices, including rapid communication to other protective systems under the coordination scheme, to prevent and/or mitigate the detected fault being migrating to other parts of the switchboard.

Bus bar control and protection systems are to be designed to work with both open and closed bus-tie breakers.

For **DPS-3**, in addition to the above requirements, the closed bus design is to include following

- i) Power system protection as in 8/3.1.2(c) of this Guide
- ii) Fault ride through capability. All equipment essential for dynamically positioning system are to have fault ride through capability, allowing for a short circuit condition to clear before under voltage protection is actuated. Low voltage transients during a short circuit condition are not to cause the motor starter to drop out, or other drives to fail.

7 Power Management System (1 November 2013)

The power management system is to be capable of operating with both open and closed bus-tie breakers where applicable. For a **DPS-2** or a **DPS-3** notation, where DP operations are configured with diesel electric driven thrusters, power management systems are to be provided. Power management systems may be of an individual designed type or integrated with other switchboard/generator control systems.

- i) Power management system is to be capable of providing sufficient power for essential operations, and to prevent loads from starting while there is insufficient generator capacity. Facilities to disable the automatic functions: stop running generators, or to disconnect generator breakers, bus-tie breakers, or thruster breakers are to be provided to allow manual operation by the DP operator when necessary.
- ii) Consideration is to be given to techniques such as power limiting of heavy consumers, shedding of non-essential loads and temporary thrust reduction to maintain the availability of power. Total failure of the power management system is not to produce failure effects exceeding the worst case failure design intent and to be demonstrated through FMEA.
- iii) Power management system is to be supplied with an uninterruptible power supply system (UPS).
- iv) A failure in the power management system is to initiate an alarm in the DP control station. When the power management is disconnected, manual operation of the switchboard, as described in 4-8-3/5.5.4 of the *Steel Vessel Rules*, is to be provided.
- v) Loss of an online generator is not to result in the sustained overloading of the generators remaining on line. If sufficient power is not available, the power management system in conjunction with “controls” of consumers is to reduce system load in a coordinated fashion to restore power balance. The restoration of power balance may be accomplished by load reduction of specific consumers, load shedding and sectionalization of the electrical network.
- vi) The power management control system is not allowed to remove the last online generator. The remove of the last online generator is to be determined by the DP operator.
- vii) When the DP system is designed with a closed bus-tie configuration for **DPS-2** or **DPS-3**, the power management system is to have protective measures implemented in order to provide the required integrity between the redundancy groups. The power management system is also to be able to communicate with other alternate protection systems if applicable. Analysis of relevant failure modes are to be addressed in the FMEA.
- viii) For **DPS-3** notation, the power management system is to be arranged such that no single fault, including fire or flood in one compartment, will render the power management system inoperable.

If all thrusters are direct diesel engine driven, a power management system is not required.

Where the electrical distribution systems are provided by a mixture of shaft generators from the main propulsion shafts and axillary generators, a power management system may be exempt provided other means of limiting and securing the power to thrusters for DP operations are in place and the main switchboard is arranged with split bus bar configurations.

9 Uninterruptible Power Supply Systems (UPS) *(1 November 2013)*

For the **DPS-1**, **DPS-2** or **DPS-3** notation, uninterruptible power supply system (UPS) is to be provided for automatic DP control system and its associated monitoring and reference system. The arrangement and number of UPSs are to be in accordance with Section 2, Table 1.

Where a group of UPSs shares a common power source from a switchboard, loss of that switchboard is not to exceed the worst case failure design intent when all UPS batteries in that group are depleted.

Each uninterruptible power supply system is to be capable of supplying power for a minimum of 30 minutes after failure of the main power supply. A fault in any UPS is to initiate an alarm in the DP control station.

For the **DPS-2** or **DPS-3** notation, the power supplies of the UPSs for the main DP control system are to be provided from different sides of the main switchboard.

For the **DPS-3** notation, the back-up DP control system and its associated reference systems are to be provided with at least a dedicated UPS. The UPSs are to be located and arranged such that no single fault, including fire or flood, in one compartment will interrupt the power supplied to the remaining control system and associated reference sensors.



SECTION 4 Thruster System

1 General

The thrusters are to comply with the requirements of Part 4, Chapter 3 of the *Steel Vessel Rules*, as applicable.

The thruster system is to be designed for continuous operation.

When the main propulsion propellers are included under DP control, they are considered as thrusters and all relevant functional requirements of this Guide are to be applied.

When the main steering system is included under DP control, the steering gear is to be designed for continuous operation.

3 Thruster Capacity

The thruster system is to provide adequate thrust in longitudinal and lateral directions and yawing moment for heading control.

- *Vessel with **DPS-0** or **DPS-1** notation.* The vessel is to have thrusters in number and of capacity sufficient to maintain position and heading under the specified maximum environmental conditions.
- *Vessel with **DPS-2** or **DPS-3** notation.* The vessel is to have thrusters in number and of capacity sufficient to maintain position and heading, in the event of any single fault, under the specified maximum environmental conditions. This includes the failure of any one or more thrusters.

Thruster installations are to be designed to minimize interference with other thrusters, hull and other surfaces.

In the calculation of available thrust in the consequence analysis and station keeping capability analysis, the interference effect between thrusters and other effects that could reduce the available thrust is to be considered.

A single fault in the thruster system, including pitch, azimuth or speed control, is not to result in unintended operation of pitch, speed and direction.

5 Thruster Configuration

The thruster arrangement is to provide adequate maneuverability under all operating conditions. The layout of the multiple thrusters is to take into account the need for continued operation with the loss of the most effective or critical thruster(s) (i.e., Worst Case Failure).

A single fault in the thruster system is to be such that the thruster fails to a safe mode so that the vessel's position and heading are not affected. Fail to a safe mode could be a failure to zero thrust or motor stop.

7 Thruster Auxiliary System

Auxiliary systems whose functions have a direct effect on the thruster system, for example, lubrication oil, cooling water, control air and uninterrupted power supply systems, are to be provided for each thruster system in a manner that supports the worst case failure design intent.

9 Thruster Control

9.1 General (1 November 2013)

Built-in features are to be provided to prevent overloading of the drive system. Manual override of control is required so that pitch, rpm, azimuth or other parameters of individual thrusters can be controlled and the thruster can be stopped if necessary.

Thrusters in DP operation are to provide controllable thrust from zero load to full load in step-less increments. This can be achieved through control of the propeller pitch or the speed of the propeller, or other parameters.

For DPS-1, DPS-2, and DPS-3, DP control system and manual position control systems (Section 5) are to be provided for the thruster system. In addition, a manual thruster control system is required. For DPS-0 manual position control system is to be provided.

9.3 Control Parameter

Command of thruster pitch, azimuth and rpm is to be provided by a closed-loop control system where feedback signals are compared with the sent commands. Sensors connected to the system are to provide independent signals representing each of the above three parameters. For fixed pitch propeller thrusters, two parameters of azimuth and rpm are to be represented through sensors. If the dynamic positioning system uses other parameters, such as thrust, amperage, and power, in the closed-loop control system, those parameters are to be monitored.

9.5 Manual Thruster Control (1 November 2013)

The manual thruster control system is to be independent of the DP control systems so that it will be operational if the automatic control systems fail. The system is to provide an effective means of individually controlling each thruster from main DP control station. The system is to provide an individual lever for each thruster and to be located at the main DP control station.

If not practical to provide an individual lever for each thruster, sharing a lever between thrusters may be acceptable provided that following conditions are satisfied:

- i) For DPS-0 and DPS-1, thruster control levers can provide controls of thrust in transverse and longitudinal directions and resulted yaw moment at same time.
- ii) For DPS-2 and DPS-3, thruster control levers can provide controls of thrust in transverse and longitudinal directions and resulted yaw moment at same time after any single fault. For DPS-3, single fault also includes a loss of a compartment due to fire or flood.

Any failure in the manual position control system is not to affect the capabilities of the manual thruster control system to individually control each thruster or related group of thrusters.

Manual thruster control is to be available at all times, also during all failure conditions in the main DP control system.

A single fault in the manual thruster control system is neither to cause significant increase in thrust output nor make the thruster rotate.

9.7 Emergency Stop (1 November 2013)

An emergency stop facility for each thruster is to be provided at the main DP control station. The emergency stop facility is to be independent of the DP control systems, manual position control system and manual thruster control system. The emergency stop facility is to be arranged to shut down each thruster individually.

This emergency stop is to be arranged with separate cables for each thruster.

Electrical cables potentially exposed to hydrocarbon fires in engine rooms and spaces where fuel oil is contained these cables are to be fire-resistant coated.

An alarm is to be initiated upon loop failure (i.e., broken connections or short-circuit) in the emergency stop system.

The emergency stop activation buttons are to be placed in a dedicated mimic representing the thruster location and which is consistent with the vessel's axis and layout, or they may be arranged together with the corresponding thruster levers if these are arranged in accordance with the physical thruster layout. **Where an accidental operation of the emergency stop buttons can occur, a protective cover is to be mounted.**

Emergency stops for thrusters are to be located within easy reach of the DP operator (DPO) at the main DP control station.

Emergency stops for thrusters are to be laid out in a logical manner which reflects the position of the thruster in the vessel's hull.

11 Thruster Monitoring and Alarm *(1 November 2013)*

Thruster monitoring is to be provided at the DP control station. This monitoring is to be continuously available by indicators/screens. The following parameters are to be monitored:

- i)* RPM, pitch, azimuth
- ii)* CPP hydraulic oil pressure and temperature
- iii)* Thruster load **and motor temperature**
- iv)* Thruster motor/semiconductor converter coolant leakage
- v)* Thruster motor/semiconductor converter temperature
- vi)* Thruster motor power availability
- vii)* Thruster motor short circuit
- viii)* Lube oil pressure and temperature
- ix)* Thruster operation (on-line/off-line)

Alarm systems for the leakage, motor overload and high temperature, abnormal pressure are to be audible and visual and are to be installed on the DP control station. Their occurrence and reset status is to be recorded. Section 2, Table 2 summarizes the parameters for monitoring, display and warning.



SECTION 5 Control System

1 General

In general, control and monitoring system components (alarms and instrumentation) for dynamic positioning systems of a vessel intended to be assigned a **DPS** notation are to comply with the requirements of the vessel's mandatory classification notations.

3 DP Control Station

3.1 General (1 November 2013)

The general requirements for system arrangement for the different notations of **DPS-0**, **DPS-1**, **DPS-2**, and **DPS-3** are listed in Section 2, Table 1.

In general, the following items are to be located at the DP control station:

- i) Operator stations for DP control and manual position control
- ii) User interface displays for required position reference systems
- iii) Manual thruster control levers
- iv) Thruster control mode change systems
- v) Thruster emergency stops
- vi) Equipment for internal and external communication

System components that do not require frequent or immediate operator attention may be installed in alternative locations.

3.3 Arrangement of DP Control Station (1 November 2013)

The DP control station is to display information from the power system, thruster system and DP control system so that correct functioning of these systems can be maintained.

For **DPS-3** notation, a backup DP control station is to be provided in a separate compartment located and arranged such that no single fault, including a fire or flood in one compartment, will render both the main and backup control system inoperable. This room is to be separated by an A-60 class division from the main DP control station, and located with access from the main DP control station.

The main and backup DP control stations are to be arranged so that the operator does not need to change position during operation and the operator has a view of the external surrounding area and all activities relevant to the DP operations. For the backup DP control station, alternatively, closed-circuit TV (CCTV) system is acceptable for viewing the external surrounding area.

If a view of the vessel's exterior limits and the surrounding area is not considered important for the intended operations, for example, for MODUs, the main activity after damage of the main DP control station is to cease the drilling operation, the arrangement for viewing the vessel's exterior may not be necessary for the DP backup control station.

3.5 Arrangement of DP Control Systems

DP control mode is to include control of position and heading. Set-points for control of position and heading are to be independently selectable.

For the **DPS-0** notation, a manual position control system is to be fitted

For the **DPS-1** notation, a DP control system and a manual position control system are to be fitted. Transfer of control between the two systems is to be initiated manually.

For the **DPS-2** notation, a DP control system with two DP control computers and a manual position control system are to be fitted. Transfer between two DP control computers is to be automatic and bump less.

For **DPS-3** notation, a main DP control system with two DP control computers, a backup DP control system, and a manual position control system are to be fitted. The backup DP control system is to be located at the backup DP control station. The backup DP control system is to have an automatic position control mode, and is to be interfaced with a position reference system, motion reference unit (MRU or equivalent) and a gyro compass which are able to operate independently of the main DP control system. The transfer between the main DP control system and the backup DP control system is to be smooth. See 5/9.3 for modes of transfer.

3.7 Arrangement of Control Panels (1 November 2013)

The operator is to have easy access to information on displays or by visual indication. The effect of any action is to be immediately displayed, preferably with graphics. In addition to the DP system command signals, the feedback signals are to be displayed where applicable.

The selection between operational modes (DP mode/manual position control mode/manual thruster control) is to be provided and easily operated. Indications of active mode and the operational status of different systems are to be displayed on the control panels. Indicators and controls are to be arranged in logical groups, and be coordinated with the geometry of the vessel where applicable.

Indication of the system in charge is to be clearly provided to the DP operator.

Manual operating **levers** and other controls are to be placed in close proximity to the DP operator and intuitive in nature. **Means for preventing inadvertent operation of vital or critical controls are to be considered such as recessed or covered switches and others.**

If an erroneous sequence of operations may lead to a critical situation or damage of equipment, appropriate interlocks are to be arranged.

Controls and indicators placed in the DP control stations are to be lighted properly to permit use day and night. Lights for such purposes are to be easily adjustable.

3.9 Arrangement of Data Communication Networks

When the DP control system utilizes a data communication network to distributed thruster control units, this network is to be separated from the communication network(s) for manual thruster controls and manual position control.

The communication network for the DP control system is to be duplicated and each is to be routed as far apart from each other as practical for **DPS-2**, see also 4-9-3/13.1.2 of the *Steel Vessel Rules*. The network is to be duplicated and physically separated for **DPS-3**. The manual position control system is not to share the same communication network with the DP control system.

5 DP Control System

5.1 General (1 November 2013)

In general, the DP control system is to be arranged in a DP control station. This system is to be located so that the operator can easily maintain an overview of both the vessel and the surrounding area.

Design is to be robust enough to reject erroneous signals that could affect control of position and/or heading. If all position reference systems fail the DP control system is to use the internal model to send control signals.

The transition between the DP control modes is not to lead to a significant change in thrust output.

5.3 External Force

If there are external forces from other equipment that can affect the vessel positioning such as from pipe tensioners, hawser tension, or fire monitors; then a careful system engineering approach is to be implemented for automatic or manual *feed forward* compensation. This is to consider the external sensor redundancy and failure modes. In addition to error checking functions provided by redundancy, the acceptable signal ranges are to be carefully bounded to be within a realistic range.

5.5 Vessels with DPS-2 Notation (1 November 2013)

DP-control system is to consist of at least two independent computers. Failure of common facilities, such as self-checking routines, data transfer arrangements, and plant interfaces, is not to cause the failure of both computers.

The DP control system is to perform self-monitoring and to automatically transfer DP control after a detected failure in one control computer. The automatic control transfer from one control computer to another is to be bump-less.

The cabling for the DP control computers and the thrusters is to be arranged such that under single fault conditions it will be possible to control sufficient thrusters to keep the vessel within the specified operating envelope.

An alarm is to be initiated for any failure of the DP control system or a sensor and also for the cases where the sensor or control system is not activated or on standby. Self-monitoring and comparison between systems are to be provided and warnings are to be generated upon detection of an unexpected difference in thruster command, position or heading.

5.7 Vessels with DPS-3 Notation

In addition to the requirements for the **DPS-2** notation, an additional DP control system is to be located in the backup DP control station and transfer of control to it is to be initiated manually from the backup DP control station.

The backup DP control station is to perform self-monitoring and continuously communicate its status to the main DP control station. An alarm is to be initiated if the backup DP control station fails or is not ready to take control.

The backup DP control station is to be ready to operate and maintain the position once it assumes command. The switch-over of the control to the backup DP control system is to be operated from the backup DP control station and is to occur via manual transfer when the main DP control station is affected by failure, fire or explosion.

The cabling for the DP control systems and the thrusters is to be arranged such that under single fault conditions, including loss of a compartment due to fire or flood, it will remain possible to control sufficient thrusters to keep the vessel within the specified operating envelope.

7 Manual Position Control System

The manual position control system is to be independent of the DP control systems and is not to rely on common cabling. The system is to be arranged such that it will be operational if the DP control systems fail. The system is to provide one joystick for manual control of the vessel position and is to be provided with the arrangements for automatic heading control.

9 Control Mode Selection

9.1 Manual/DP Control Modes (1 November 2013)

A simple device is to be provided in the DP control station for the selection of the thruster control modes (i.e., manual thruster control, Manual Position Control and DP control). The device is to be designed so that it is always possible to select manual **thruster** controls after any single fault in the DP control mode. Thrusters within the DP control system may also be individually de-selected from DP control to manual **thruster** control for service and vessel specific operations.

9.3 Main/Backup Control Station

For **DPS-3** notation, the mode selector between main DP control station and backup DP control station is to comply with redundancy requirements. The transfer to the backup DP control station is to be fail-safe, so that if the main DP control station is damaged in any way, transfer of control can still be initiated and assumed at the backup DP control station. Transfer of control to the backup DP control station is to be performed manually, such that inadvertent control transfer to an unattended station is avoided.

11 Position Reference System and Environment Sensor

11.1 General

The Position reference systems are to be in compliance with the relevant requirements for the mandatory classification notations of the vessel for electrical, mechanical, and hydraulic components and subsystems. Accuracy and limitations of the position references used are to be adequate for the specific task in which the vessel is engaged.

(1 November 2013) The design of position reference systems and environment sensors with respect to power, signal transmission, and interfaces is to follow the system redundancy requirements. Sensors and/or position reference systems may be shared with other systems provided failure in any of the other systems cannot cause failure or loss of performance of the DP control system.

11.1.1 Motion Reference Unit (MRU)

Where position reference systems are dependent on correction of the measurements for roll and pitch noise, motion reference unit (MRU) or equivalent is to be provided.

11.1.2 Diversity *(1 November 2013)*

Where more than **two** positioning reference systems **are** required, at least two are to be based on different measurement techniques and each of the two are to be independent with respect to signal transmission and interfaces. **Special consideration may be given where the use of different measuring principles is not practicable.**

11.1.3 Loss of Inputs of Position Reference Systems

Loss of one or multiple position reference system inputs or sensor inputs is not to lead to significant change in thrust output. Upon recovery of the inputs, the last position or heading set point before the loss is not to be automatically applied. The DP operator may choose any other set point if the set point suggested by the control system is significantly different from the actual vessel position and/or heading.

11.1.4 Alarms

Alarms for sensor malfunctions are to be included in monitoring of positioning reference systems and environment sensors. An alarm is to be initiated on detection of a sensor failure, even if the sensor is in a standby or offline use at the time of failure.

11.1.5 Power Source

For the **DPS-1**, **DPS-2** or **DPS-3** notation, the power source to the position reference systems and environmental sensors are to be supplied from UPSs. Following components of the position reference systems, where applicable, may not need to be powered by UPS.

- i)* Transducer hoist systems
- ii)* Taut wire derrick control system
- iii)* Heave/tension compensation (taut wire)
- iv)* Part of gangway system

11.3 Vessels with DPS-0 or DPS-1 Notation (1 November 2013)

For the **DPS-0** notation, a position reference system, a wind sensor and a gyro-compass are to be fitted. For the **DPS-1** notation, they are to be provided in duplicate.

Where user interface computers and displays are required for position reference systems they are to be independent of the DP control system. The user interface display is to be placed at the DP control station and easily readable by the DP operator. Power supply to the position reference systems is to be from the corresponding UPS connected to **its associated sensors** (except for notation **DPS-0**).

11.5 Vessels with DPS-2 Notation (1 November 2013)

In addition to the requirements for the **DPS-1** notation, a third independent position reference system, a third wind sensor and a third gyro-compass are to be provided. A single fault is not to affect simultaneously more than one position reference system (i.e., no common mode failures).

Where user interface computers and displays are required for position reference systems at least two of them are to be independent of the DP control system. The user interface displays are to be placed at the main DP control station, and they are to be easily readable by the DP operator. UPSs are to be provided for the power supply of the position reference systems and associated sensors, and they are to be in accordance with the overall redundancy requirements.

11.7 Vessels with DPS-3 Notation

In addition to the requirements for **DPS-2** notation, the third wind sensor, third gyro-compass and the third independent position reference system are to be directly connected to the backup DP control station and with their signals repeated to the main DP control station with appropriate signal isolation.

The sensor receivers connected directly to the backup DP control system are in general to be installed in the same compartment as the backup DP control system. For sensors that cannot be located in the same compartment as the backup DP control station room (e.g., wind sensor, GPS antenna, taut-wire or hydro acoustic transducer), redundancy is to be provided as far as possible by separation and physical distance.

The independence between main and backup DP control systems is to be provided. Signal isolation of position reference system and sensors is to be provided, such that failures cannot propagate from one system to the other system.

11.9 Signal Processing

Position reference systems are to be capable of providing new position data with an update rate and accuracy suitable for the intended automatic DP operations. The individual position reference system is to be self-operational, and not dependent on the DP control system for operation.

For satellite based systems, interface and necessary equipment for receiving differential correction is to be installed. Where several position reference systems are required, the DP control computers are to use signal processing techniques to validate the data received. The reference position of each system is to be available at the operator's request. Position reference systems that rely on motion reference compensation are to be provided with a means of selecting available motion reference units for use.

When several systems are combined, the resulting value used in further processing is not to change suddenly or significantly if one or more systems are selected or deselected. Failures in a positioning reference system that might affect positioning or redundancy adversely are to initiate an alarm. If a positioning reference system can stall or in other ways produce corrupt or out of range data, a method is to be provided to enable rejection of the data and an alarm is to be initiated.

13 Consequence Analysis (For DPS-2 and DPS-3) *(1 November 2013)*

For a vessel with **DPS-2** or **DPS-3** notation, the DP control system is to incorporate a consequence analyzer that monitors the composite thrust vector necessary to maintain position and heading under the prevailing environmental conditions in the event of predefined worst case failure. Additionally, the consequence analyzer is to be able to perform calculations to verify that in the event of a single fault there will be sufficient thrust available to maintain position and heading. Failure conditions may also be simulated under hypothetical conditions (e.g., loss of thruster, generator, auxiliary systems, etc.). This simulation is to be clearly identified and is not to affect the actual control system in any fashion.

The consequence analysis is to be automatically running at pre-set intervals. The calculation ongoing is to be displayed. The analyzer is not to be de-selectable while in **DPS-2 or DPS-3** DP operations.

15 Display and Monitoring *(1 September 2015)*

The DP control station is to receive alarms and warnings reflecting the status of the DP system. If the vessel exceeds preset position and heading limits an alarm is to be initiated. If the alarms in the DP control station are slave signals of other alarm systems, there are to be a local acknowledgement and silencing device. The silencing device is not to inhibit new alarms.

The display unit is to present a position plot including the location of the vessel relative to the reference sources. The plot may be vessel relative, or a true motion presentation. For DP control systems designed with redundancy, there is to be at least two independent position displays. If the display is used for presentation of warnings or alarms, they are to have priority over other information and they are not to be inhibited by other data currently being displayed.

The **critical** DP alarms and displays are to be available in **DPS-3** backup DP control station. **Non-critical DP alarms (e.g., grouping of alarms, logging on by authorized crew only to the alarm monitoring system, etc.) are to be of non-intrusive type announcements for the DP operator**, since in a fire or loss of compartment situations, many failed electrical systems, thrusters and other alarms may be initiated simultaneously.



SECTION 6 Auxiliary Systems (applies to DPS-2 and DPS-3)

1 General

The design of the components of auxiliary systems is to be in compliance with the requirements of the vessel's mandatory classification notations. For **DPS-2** and **DPS-3** notations, the auxiliary systems that are part of the DP system are to be arranged in accordance with the redundancy requirements.

For **DPS-2**, a static component is not considered to fail.

A single failure effect analysis for auxiliary systems is to be included in the DP system FMEA. The following items are to be considered where applicable:

- i) Fuel oil system
- ii) Lubricating oil system
- iii) Cooling water system
- iv) Compressed air system
- v) Hydraulic system
- vi) Pneumatic system, etc.
- vii) Ventilation/HVAC system
- viii) Piping system equipment (e.g., purifier, heat exchanger, transfer pump, etc.)

3 Fuel Oil *(1 September 2015)*

The fuel system is to be arranged to follow the redundancy concept. The duty pump is to be powered from within the same redundancy group as the component or system it serves. The effect of pump failure is not to exceed the WCFDI. If the fuel system requires heating, then the heating system is to be designed with the appropriate level of redundancy.

The design of the fuel system is to facilitate isolation of services between DP operation and industrial functions if applicable.

Actuators for quick closing valves are to be installed on a per engine basis and hence, any remote control system is to fail safe with respect to station keeping.

Fuel strainers and filters are to be arranged to facilitate changes without taking equipment out of service.

For **DPS-3**, a minimum of one service tank is to be provided for each redundant group. The service tanks are to be in separate compartments with A-60 partitions following overall split redundancy concept. The valves in the crossover facilities, if arranged, are to be located as close as possible to the bulkhead and operable from both sides.

5 Cooling Water *(1 November 2013)*

The cooling system is to be arranged to follow the redundancy concept. The duty pump is to be powered from within the same redundancy group as the component or system it serves. The effect of pump failure is not to exceed the WCFDI.

For twin screw vessels where cooling pumps are engine driven, a duplicate spare pump carried onboard, in lieu of the standby pump, is acceptable, as long as loss of pump would not exceed the WCFDI.

Engine room sea water cooling systems could be incorporated into the thruster seawater systems provided the redundancy concept is not violated.

In consideration of the severe consequences arising from the loss of water or gas accumulation, fresh water cooling systems are to be arranged with full separation between systems providing required redundancy. For a **DPS-2** notation, the pipe can be considered not to fail.

The fail safe condition for valves in the fresh water system is to fail as is. The fail safe condition for temperature regulating valves is to be fail open.

The display of running pumps is to be provided and an alarm is to be initiated for abnormal stop and/or change over to a standby pump.

7 Compressed Air

Compressed air systems for DP related functions are to follow the redundancy concept. Compressed air for starting engines is to be independent to the maximum extent feasible. Control air and starting air may be taken from the same source provided any pressure drops associated with starting air do not affect the control function. Loss of air supply to the thrusters is to be alarmed and is to have no effect on thruster operation.

9 Lubrication Oil Systems *(1 November 2013)*

Lube oil systems for engines are to be associated with one engine only. **Where common facilities are provided, such as, facilities for storage, changing and disposing of oil, means** are to be provided to prevent inadvertent cross connections between engines which could lead to one engine sump being emptied and the other overfilled.

11 HVAC and Ventilation

Ventilation and HVAC for spaces containing equipment essential to DP are to be arranged to comply with redundancy so that acceptable temperature can be maintained after any single fault in active components and ventilation damper actuation energy source. This requirement also applies to switchboard rooms and instrument rooms containing components that are parts of the DP system.

13 Piping

Crossover pipes are acceptable, except in ventilation ducts, provided the cross over pipes can be closed at both sides of separating bulkheads. Crossover valves, where fitted between independent systems to facilitate maintenance, are to be provided with local and remote monitoring to indicate open/closed status.

15 Pneumatic Systems

Pneumatic systems are to be designed according to required redundancy in view of the risk of leakage.

17 Power Supply to Auxiliary Systems *(1 November 2013)*

Power for auxiliary systems associated with DP systems is to be taken from within the redundancy group. Auxiliaries for thruster systems such as cooling water pumps and fans are to be powered from the **same redundancy group** as that providing the drives.



SECTION 7 DP System Initial Test

1 General

The components and subsystems associated with the dynamic positioning system are to be tested according to the vessel's mandatory classification notations, where applicable, prior to testing of the dynamic positioning system.

Once completed, the dynamic positioning system is to be subjected to final tests. These tests are to prove essential features of the DP system and its design redundancy.

A DP test program is to be developed to contain test procedures and acceptance criteria, and identify the configurations for all DP related systems for test. The DP test program is to include procedures for DP system performance testing and procedures for FMEA proving trials for DPS-2 and DPS-3, as applicable.

When deemed necessary by the attending Surveyor, additional tests to those specified by the DP test program may be required.

The DP test program is to be kept onboard the vessel. Any changes to the DP system other than *like-for-like* replacement of equipment are to be notified to ABS and included in a revision of the DP test program.

3 DP System Performance Test

The performance testing of the DP system is to be carried out to the satisfaction of the attending surveyor in accordance with a DP system performance testing procedure which includes but is not limited to the following:

3.1 Uninterruptible Power Supply Systems (UPS)

The UPSs are to be operated and confirmed to be functioning satisfactorily. The UPSs are to be operated without the normal main power input for 30 minutes to confirm that the batteries are capable of supplying the output power with full functioning of the DP control system. The alarms for the UPSs are to be tested.

3.3 Position Reference Systems and Sensors

All position reference systems, sensors, MRUs, and gyro-compass(s) for the DP systems are to be tested and confirmed to be functioning satisfactorily. The alarm systems are to be checked by simulating failures of the sensors and the references systems.

3.5 Manual Position Control System (1 November 2013)

For a **DPS-1**, **DPS-2** or **DPS-3** system, the operation of the manual position control system using one joystick at DP control station and supplemented by an automatic heading control, is to be confirmed to be functioning satisfactorily.

3.7 Manual Thruster Control System (1 November 2013)

The operation of the manual thruster control system using individual **levers**, at the DP control station in accordance with Section 4 of this Guide is to be confirmed to be functioning satisfactorily.

3.9 Thruster Emergency Stop

The operation of thruster emergency stop and monitoring alarms is to be tested.

3.11 DP Control System (1 November 2013)

For a **DPS-1** system, the operation of the automatic control system and a manual position control system including manual transfer of control between the two systems is to be confirmed to be functioning satisfactorily.

For a **DPS-2** system, the operation of the DP control system and a manual position control system including automatic transfer of one DP control computer to another upon failure is to be confirmed to be functioning satisfactorily. Upon failure of the DP control system, it is to be verified that the manual position control is possible.

For a **DPS-3** system, the operation of three DP control computers and a manual position control system including **main DP control system** automatic transfer of one DP control computer to another upon failure is to be confirmed to be functioning satisfactorily. Manual transfer of control is to be verified possible at the backup DP control system located in the back-up control station. Upon failure of the **main** DP control system, it is to be verified that the manual position control is possible.

Performance of the position reference systems in DP mode is to be tested for all possible combinations of position reference systems (PRS), and on each PRS as a single system.

The **main** DP control system in a **DPS-2** or **DPS-3** system is to perform self-check routines which are to automatically changeover to a standby system when critical failure conditions are detected. An alarm is to be initiated in case of failure.

3.13 Control and Alarms (1 November 2013)

Functions of thruster controls and related alarms are to be tested and to be confirmed functioning satisfactorily.

Change of thruster controls between DP control system, manual position control system and manual thruster control system is to be tested and to be confirmed functioning satisfactorily.

3.15 Standby Changeover

Changeover to standby pumps (e.g., sea water, fresh water, hydraulic) is to be tested if these pumps provide essential redundancy, (e.g., standby seawater cooling pump which is required to start on failure of the running pump).

Any other standby changeovers that are included in the *Operations Manual* are to be tested.

3.17 Protection Function

The functions of protection equipment are to be tested if they are designed to provide essential redundancy of the DP system.

3.19 Communication

A means of voice communication between the main DP control station, and the thruster room(s) is to be tested and confirmed to be functioning satisfactorily.

A means of voice communication between the main DP control station, the engine control position and any operational control centers associated with DP is to be tested and confirmed to be functioning satisfactorily.

3.21 DP Endurance Test (1 November 2013)

A DP endurance test is to be carried out for at least 6 hours with the complete DP system in operation. It can be combined with the **test of DP control systems**. The failures **related to DP system performance** are to be recorded and analyzed. Where possible the test environment is to reflect the limiting design operating conditions.

5 FMEA Proving Trial for DPS-2 or DPS-3

For a **DPS-2** or **DPS-3** system, FMEA proving tests are to be carried out to the satisfaction of the attending Surveyor. The tests are to confirm the findings from FMEA analysis that the vessel is able to maintain position and heading after the loss of redundant groups identified by the FMEA.

The FMEA test procedures are to be developed in the FMEA analysis covered in Subsection 2/11 of this Guide.

A vessel is to operate in configurations which have been analyzed in its DP system FMEA. The test procedures are to be based on the simulation of failures and is to be carried out under as realistic conditions as practicable.

The schedule of these tests is to be designed to demonstrate the level of redundancy established in the FMEA. Where practicable, the test environment is to reflect the limiting design operating conditions.

Closing out of action items from the FMEA, and proving trials are to be well documented and auditable.

After completion of the DP proving trials, the final version of the DP FMEA and DP proving trial report, including final analysis/conclusions based on actual results from DP testing, are to be submitted.



SECTION 8 Enhanced System (EHS)

1 Introduction

At the Owner's request, an Enhanced System notation (**EHS**), as a supplement to a DPS-series notation, may be assigned to a **DPS-2** or **DPS-3** vessel. The main objective of the enhanced system notation is to improve reliability, operability and maintainability of the DP vessel.

The enhanced system notations mainly emphasize the following properties of the DP system:

- i) Robust design of power plant and thruster system;
- ii) Enhanced protection systems for generators and thrusters: Failure detection and discrimination of failed components before a full or partial black-out situation occurs;
- iii) Quick automatic blackout recovery;
- iv) Enhanced position reference system and sensor system for increased availability and reliability;
- v) Fire and flood protection for higher risk areas.

The notation includes provisions for standby start, closed bus operation and transferable generators. These are beneficial to the overall environment, operational flexibility and system maintainability

Three separate enhanced notations are provided as follows:

- *Enhanced Power and Thruster System (EHS-P)*: This notation covers the requirements for the power system and thrusters that are beyond those for the **DPS**-series notations.
- *Enhanced Control System: (EHS-C)*: This notation covers the requirements on the DP control systems including control computers, position reference systems and sensors, which are beyond the minimum requirements for DPS-series notations.
- *Fire and Flood Protection System (EHS-F)*: This notation covers the requirements for fire and flood protection considering the risk level of the areas. This is a supplement for a **DPS-2** system. It is not necessary for a **DPS-3** system, since a **DPS-3** system has higher requirement in this regard.

The separate enhanced system notations provide the Owner with the flexibility of selecting an individual **EHS** notation or combined **EHS** notations that best fit the design intent.

To be granted an **EHS**-series notation, the requirements given in this Section are to be met in addition to the requirements for **DPS**-series notations.

3 Enhanced System for DPS-2 and DPS-3

A vessel with **DPS-2** or **DPS-3** notation may be assigned enhanced system notations if the system meets the additional requirements given in this section.

For a vessel with a **DPS-2** notation, the Enhanced Power and Thruster System Notation (**EHS-P**), the Enhanced Control System Notation (**EHS-C**), Fire and Flood Protection (**EHS-F**) Notation or any combination, such as **EHS-PC**, **EHS-PF**, **EHS-PCF**, may be assigned.

For a **DPS-3** vessel, **EHS-F** is not necessary since **DPS-3** has a higher fire protection requirement.

3.1 Enhanced Power and Thruster System (EHS-P)

3.1.1 System Design (1 November 2013)

The design of power plant and thruster systems are to adhere to clearly defined worst case failure design intent.

Additionally, the generator sets and thruster sets are to be autonomous **in the provision of auxiliary support services and control functions.**

The design is to include fault ride through capabilities and functions for **automatic** quick blackout recovery.

The design for transferable thrusters and generators is to be fault tolerant and fault resistant, which means that a single fault is not to cause failure of more than one redundancy group and is not to cause total black-out.

Care is to be taken to avoid hidden faults, such as failures of protection **systems**. Such **systems are** to be designed so that they can be tested on Surveyor's request.

Redundancy groups are to be clearly defined and well separated. Divisions are to be appropriately maintained throughout the design.

3.1.2 Power System (1 November 2013)

3.1.2(a) Power Generation. Each generator set is to be autonomous **in terms of critical auxiliary systems (see 8/3.1.5), control and automation functions. Common cause failures associated with load sharing, interlocks, permissive and others are to be avoided by distributing control and monitoring functions to local systems responsible for each item of main machinery.**

3.1.2(b) Power Distribution. With Enhanced Generator Protection (EGP), described below, information about bus load sharing conditions is to be directly derived from the bus bar.

Generators are to be capable of droop mode operation, with any central communication infrastructure minimized.

i) *Load Sharing.* The load sharing system is to be designed so that the system can be tested, both for correct sharing and consequences of failure. The design is to incorporate the possibility for testing that critical failures are detected by the control system. **The failure of the power management system is not to result in the failure of the load sharing system in any load sharing control modes.**

- *Active (KW) Load Sharing.* If a scheme for isochronous load sharing is implemented the generator speed controllers are to automatically switch to load sharing in droop mode upon failure of isochronous load sharing.
- *Reactive (KVAR) Load Sharing.* The generators are to be able to operate in droop voltage, without the need for reactive load sharing communication between the AVRs. If differential compensation between voltage regulators is implemented, the system is to automatically switch to operation in droop voltage if a failure in the reactive load sharing lines occurs.

ii) *Switchboards.* Switchboards are to be protected against potential arc damage **either by arc detection, by insulated bus bars, or by any other means.**

iii) *Breakers.* A minimum of two bus-tie breakers, one on each side, between switchboards is to be provided, with monitoring and control contacts from each.

The Power Management System and breaker cubicle are to provide a visible indication of generator breaker status (open/closed). The Power Management System is to alarm if the status of the breaker feedback differs from the issued command.

3.1.2(c) *Power System Protection.*

System Design. Controls and protection systems are to be designed to facilitate local monitoring, controllability, fault detection, and acting in a timely manner to prevent fault propagating to other sections.

A zone or segmented concept is to be implemented with error checking such as bus bar differential protection or equivalent. The generator protection system is to be designed so that it is possible to verify protection settings and test black-out recovery. Additionally, alarms and detection systems are to be capable of being tested after system delivery, and be available for demonstration at the request of the Surveyor.

- i) *Enhanced Generator Protection.* In addition to the generator protection requirements for a vessel's mandatory notations, the following functions, as a minimum, are to be provided.
 - a) Identification of faults based on continuous monitoring of generator voltage and speed characteristics.
 - b) Monitor generator behavior over time and reveal anomalous behavior, and take action before system performance is affected, or critical failures occur.
 - c) Trigger alarms if anomalies have continued beyond the pre-set intervals set by failure analysis, indicating that maintenance is required.
 - d) Identification of a faulty generator without relying on information from other generators.

EGP is to detect and alarm at least the following anomalies included but not limited to:

- a) Excess and insufficient fuel
- b) Over and under-excitation
- c) Generator instability or hunting
- d) Loss of exciter current
- e) Active and reactive power sharing imbalance

All failures identified are to initiate an alarm or trip of the faulty generator as appropriate. The system is to be designed so that these features can be tested on the request of the Surveyor.

If a generator is faulty its breaker is to automatically open and the generator is to trip. In the event the breaker does not open, this is to be detected and the bus-tie breakers closest to the generator are to open automatically.

- ii) *Closed Bus Operation.* If a failure is detected and an action is taken without removing the failure, the protection system is to further isolate the fault by automatically isolating the affected switchboard.

Bus frequency and voltage is to be analyzed for operation within normal limits. If deviation occurs outside these limits for a pre-determined time interval, then tie breakers are to automatically open, converting to a split bus system. An alarm is to be initiated.

- iii) *Blackout Prevention System.* Power consumers are to include intelligent blackout prevention that is not dependent on the Power Management System, including:
 - a) Dynamic limiting of power of the propulsion (and drilling services if applicable) according to available power
 - b) Response time quick enough to avoid damage to the generators

3.1.3 Thruster System

3.1.3(a) General. Thruster drives are to have short circuit, earth fault, thermal, over current and overvoltage protection. Motor starting and stopping controls are also to be provided near the drive.

Each thruster drive control system is to have all the intelligence necessary to start the thruster and make it ready for DP control. Interlocks are to be provided to prevent a drive resetting itself under a short circuit condition.

Thruster drives are to be able to start the thruster even when the propeller is turning due to inflow.

3.1.3(b) Interfaces. Where power management functions are integrated in electrical drives, the interface between the different power management functions is to be analyzed in the FMEA. Where both the Power Management System and the local electrical drives can limit and control power to the thrusters, care is to be taken so they do not interfere with each other and cause a control oscillation between the two systems.

3.1.3(c) Autonomy (1 November 2013). Each thruster set configuration is to be autonomous and operate independently from equipment that is not directly connected to it.

Thruster seawater cooling system can follow the group redundancy concept with one duty and one standby pump. Engine room sea water cooling systems can be incorporated into the thruster seawater systems provided the redundancy concept (within the same redundancy group) is not violated. Fresh water cooling system is per thruster. **Cooling water for the thruster can also be used for auxiliary systems for that thruster.**

3.1.3(d) Fast Phase Back. To prevent power plant instability, variable frequency drives for the thrusters are to facilitate fast phase back; and in the case of drilling operations, phase back of the drilling system is also to be implemented. Care is to be taken so these two systems do not interfere with each other and cause a control oscillation.

The criteria and order that equipment is phased back in (drilling equipment or thrusters) is to be described and added to the *Operation Manual* and be known to the DP operator and ABS.

Individual thruster drives are to directly sense under frequency in the system and cut back thrust.

3.1.3(e) Fault Ride Through Capability. All equipment essential for dynamically positioning system are to have fault ride through capability, allowing for a short circuit condition to clear before under voltage protection is actuated. Low voltage transients during a short circuit condition are not to cause the motor starter to drop out, or other drives to fail.

3.1.4 Blackout Recovery (1 November 2013)

3.1.4(a) General. The power management system is to be able to re-establish **the functioning of the power plant** automatically, without any human intervention, within 60 seconds after blackout, **generators and thrusters for DP are also to be available within 60 seconds.** The system is to be able to re-establish the needed power for maintaining position and heading control within the specified envelope.

The power management system is to be able to start all available generators after a blackout and to connect them to the electrical network.

3.1.4(b) Inrush Currents. High inrush currents that may damage equipment and trip feeder breakers are to be avoided. This could be done by a pre-magnetizing function for high voltage transformers or other equally effective means. If a pre-magnetizing function is utilized and faults are detected during the pre-magnetizing sequence, the pre-magnetizing sequence for the specific piece of equipment experiencing a fault is to be aborted and an alarm is to be sent to the Power Management System.

3.1.4(c) Power Distribution and Management. To avoid problems with synchronization, detection of a dead bus, defined here as a situation where the bus is de-energized, is to be secure, and in the form of a redundant detection system (e.g., dead bus relay and bus voltage transducer).

A dead bus closing facility is to be implemented for overriding the synchronizing function if the bus is dead.

Two generators are not to be able to connect to the dead bus at the same time.

3.1.4(d) *Thruster System.* All thrusters are to be ready for operation without manual intervention. The thruster drives are to have their own local control system monitoring the condition of the main power system and reconnect as soon as the main power system is ready for the operation of the thrusters.

3.1.5 Auxiliaries (1 November 2013)

Each thruster and generator set is to be autonomous in terms of auxiliary systems that are directly connected to it so that a single fault in the auxiliary systems is not to result in failure of more than one thruster/generator set.

Separate fuel oil service tank for each generator are to be provided. These are to be located within their compartmental redundancy group.

Fuel water content monitoring with remote alarms is to be installed either at the input to the service tanks or at the output of a purifier, whichever is more practical.

Purification and transfer to the service tanks are to be arranged such that a single fault in the purification and transfer systems is not to result in failure exceeding the WCFDI. Fixed piping can be shared between generator/thruster sets.

Separate fresh water cooling system for direct cooling of each engine is to be provided. External sea water or fresh water cooling systems can be on a per engine room basis, but in all cases, are to be arranged such that a single fault in external water cooling systems is not to result in failure exceeding the WCFDI. External water cooling systems for engine rooms could be incorporated into thruster external water cooling systems provided the redundancy concept is not violated.

Compressed air for starting engines is to be arranged such that a failure of one air compressor or air receiver is not to result in failure of more than one generator set.

For standby units, on which the redundancy depends, the readiness of auxiliary systems is to be maintained and communicated to the DP-control systems.

3.1.6 Uninterruptable Power Supply Systems (UPS)

If a system has independent subsystems for automation, control and supervisory systems, these are to be supplied by UPS.

The unit is to be of the online type as defined in 4-8-3/5.9.1 of the *Steel Vessel Rules*, that is, there is to be no transfer time if a power failure occurs. The UPS are to have sufficient capacity to allow operations to be brought to a safe stop or discontinued with a minimum capacity of 30 minutes as required in Section 3.

3.3 Control System (EHS-C)

3.3.1 DP Control Computers

3.3.1(a) *DP Control Station and DP Controller.* Three DP control computers (redundant main DP control system and a backup DP control system) each with their own independent power supplies are required.

For **DPS-2** vessels, the manual position control system can be replaced with an additional DP control system (independent of the two DP control computers required by the basic **DPS-2** notation). The additional DP control system is to meet all of the requirements for the independent joystick control system while also providing DP control capabilities. Independence of the controller, workstation and network is to be maintained.

3.3.1(b) *DP Data Logger (1 November 2013).* A data logger with easy playback facilities is to be implemented. The data logger is to stamp all data with time and date. Data logged are to include manual and automatic input to the DP control system and operational data of all DP relevant systems. Data recorded are to include status data and behavior data of generators and thrusters. The data are to remain stored for at least 7 days, be easily accessible to the operator and be available for upload to offline storage media. Time and date are to be synchronized to a common reference.

The data logger is to be able to log the main DP control system and the backup DP control system or additional DP control system (for **DPS-2**). The failure of the data logger is not to cause the failure of the two systems.

3.3.1(c) *Capability Plot (1 November 2013)*. Online capability plots are to be updated using the tuned models on sea trials and include the simulation of the most relevant failure modes. Online capability plots are to be verified for accuracy during DP trials as possible.

3.3.1(d) *Uninterruptable Power Supplies System (UPS)*. The power source of all control system components are to be supplied from UPS.

The UPSs distribution panel and fuse protection for the DP control systems are to be designed to isolate and clear faults individually.

3.3.2 Position Reference Systems

3.3.2(a) *General (1 November 2013)*. Four sets of position reference systems are to be implemented. The systems are to be designed so that three of the position reference systems are available at any given time and location considering blocking, noise, etc.

One set of position reference system is to be directly connected to the backup DP control system or additional DP control system (for DPS-2). The main DP control system is to be able to read the information from that system and the failure of that position reference system is not to cause the failure of both DP control systems.

The position reference systems chosen are to reflect the planned operating conditions such as deep water (normally deeper than 500 m), open water or close proximity to other units. In deep water (deeper than 500 m) at least one of the position reference systems is to be an acoustic reference system.

UPS supplies to position reference systems are to be sourced to prevent multiple sensor loss of the same sensor types.

3.3.2(b) *Position Reference System Differentiation*. No less than two of the position reference systems are to be a Global Navigation Satellite System (GNSS). At least one of these is to use GPS, GLONASS, or equivalent. At least one of the GNSS systems is to be a dual frequency receiver. The DP control system is to alarm any unrealistic GPS jumps in the signal or rapid drift.

3.3.2(c) *Error Checking*. A system for error checking and weighting of the position references is to be provided.

3.3.3 DP Sensors

Four Motion Reference Units (MRUs) and four gyros are to be implemented, with at least one based on different operating principles to the others a different manufacturer and working on different principles.

A minimum of four wind sensors is to be operating with at least one based on a different operating principle to the others (ultrasonic vs. mechanical).

3.5 Fire and Flood Protection (EHS-F)

3.5.1 General

The EHS-F notation is supplement for DPS-2 vessels with fire and flood protection implemented based on the fire risk level. This information is not necessary for DPS-3 vessel, since DPS-3 notation has higher requirements for fire protection.

3.5.2 Physical Separation

3.5.2(a) *General*. Physical separation is to be provided between redundancy groups, A-60 separation for machinery spaces of high fire risk and A-0 for other locations along the boundary of redundancy groups.

The high fire risk area is the area defined by 4-8-4/1.11 of the *Steel Vessel Rules* including:

- i) Machinery spaces as defined by 4-7-1/11.15 and 4-7-1/11.17
- ii) Spaces containing fuel treatment equipment and other highly flammable substances

Watertight bulkhead separation is to be in place below the damage waterline for machinery spaces.

3.5.2(b) *Power System.* Each redundancy group is to have its own service tanks and it is to be located in individual compartments separated by A-60 partitions and be watertight if below the damage waterline.

Each switchboard serving a different redundancy group is to be located in individual compartments separated by at least A-0 partitions and be watertight if below the damage waterline.

3.5.2(c) *DP Control Station (1 November 2013).* Main and back-up (or additional) DP control stations are to have separate spaces, but A-0 partition is not required.

The controllers, not located in DP control station, for the main DP control system and backup (or additional) DP control system are to be located in separate spaces with at least A-0 partitions.

The redundant communication networks for the main DP control system is to be physically separated with A-0 partitions in general, A-60 in high risk fire space and watertight if below the damage waterline.

3.5.2(d) *Thrusters.* Thrusters are to be located in separate watertight compartments with at least A-0 separation, provided fire risk escalation is low and active fire protection fitted in each compartment.

5 Summary of System Requirements for Enhanced System Notations

Enhanced system notations (**EHS**-series) are complementary to the corresponding **DPS**-series notations. The requirements for the **DPS**-series notations given in Section 2, Table 1 are to be complied with. In addition, the listed requirements in Section 8, Table 1 are also to be complied with for the Enhanced System notations (**EHS**-series).

TABLE 1
Summary of DP System Requirements for EHS Notations (1 November 2013)

EHS-P	EHS-C	EHS-F
Autonomous Generator Set ⁽¹⁾	2+1 backup DP control computers and controllers ⁽⁴⁾	Generators and Prime Movers Separate compartments, A60 for high fire risk area. Watertight below damage waterline
Bus-tie Breaker Redundantly configured between each bus segment	Wind Sensors 3 + 1 in back up control station	
Enhanced Generator Protection ^(1,2)	Gyros 3 + 1 in backup control station	Power Distribution System A0 between redundant groups. Watertight below damage waterline
Enhanced Power Management ^(1,3)	MRU 3 + 1 in backup control station	Thruster System A0 between redundant groups. Watertight below damage waterline
Autonomous Thruster Set ⁽¹⁾	Position reference systems 3 + 1 in backup control station ⁽⁵⁾	Controller Space A0 between redundant groups

Notes:

- 1 Controls and supervision of those functions are to be integrated in the control center with the centralized control system and are to be communicated with DP controls.
- 2 Enhanced generator protection functions to be provide per Subsection 8/3.
- 3 Enhanced Power Management capability to be provided per Subsection 8/3.
- 4 *(1 November 2013)* For **DPS-2** vessels, manual position control system can be replaced with an additional DP control system as per 8/3.3.1(a). **DP Data Logger** is to be included as per 8/3.31(b).
- 5 Position reference systems are to be based on at least two different design principles. For deep-water conditions, GPS and Hydro Acoustics may be used.

7 Closed Bus and Standby Start

7.1 General

The DP system with enhanced power and thruster notation (**EHS-P**) could have flexibility of closed bus operation and redundancy depending on standby start of the systems.

The closed bus configuration is to be included in FMEA. The MTS publication, “*DP Operations Guidance*”, can be used in the development of *Operations Manual* regarding closed bus operation.

7.3 Closed Bus Operation (1 May 2018)

The closed bus-tie configuration is to be capable of preventing a black-out under relevant fault conditions.

The closed bus-tie configuration is to be such that the minimum number of required running generators (i.e., two or more) are connected to two or more sections of the main bus. The minimum number of running generators are to be determined from the unit’s DP capability. The worst case failure of the configuration is not to result in a blackout.

The total number of running generators is to be determined based on the power requirements, needed spinning reserve and the ability to phase back other loads.

If bus frequency or voltage is outside of predefined limits the tie breakers are to open and the system is to run as a split system.

7.5 Standby Start (1 November 2013)

The standby start of the components or sub-systems of the DP system may be acceptable. The changeover operation is to be automatic and reliable provided that the position and heading of the vessel are within the specified limits and DP performance is not degrading. If no specific limit is specified, the maximum allowed changeover time is 45 seconds.

The availability of standby start functions is to be monitored at the DP control station and communicated with the DP control system.

In addition, the following factors are to be considered when using standby start as redundancy:

- i) Single fault does not cause total blackout including loss of entire compartment for **DPS-3**.
- ii) A failure in one redundancy group is not to cause failure of any other redundancy groups.
- iii) A failure in the system being changed over to is not to cause failure of any other redundancy groups.
- iv) Changeover is not to cause failure of the redundancy group that is being connected to.
- v) At least, one standby generator is to be considered not available when needed.

For a situation where thrust is to be immediately available (e.g., pipe laying) the redundancy is not to be based on standby start and changeover.

7.7 FMEA and Testing

Subsection 2/11 of this Guide provides the requirements for FMEA analysis and FMEA proving trial for **DPS-2** and **DPS-3** notations. In addition to the requirements in Subsection 2/11, the enhanced features included in **EHS**-series notations are to be analyzed in FMEA and verified through testing.

In addition to the failure modes provided in Subsection 2/11, for **EHS**-series notations, following failure modes, where applicable, are also to be considered in FMEA analysis.

- i) Operation of protection systems (breakers, bus-ties, etc.) related to short circuit
- ii) Severe voltage dips associated with short circuit faults in power plant configured as a common power system
- iii) Failure to excess and insufficient fuel
- iv) Over and under-excitation
- v) Governor and AVR failure modes

- vi) Failure modes related to standby start and changeover
- vii) Power management failure on load sharing, malfunction, etc.
- viii) Phase back thrust and large load
- ix) Blackout recovery

The above required analyses are to be supported with extensive verification by testing. The test procedures are to be based on the simulation of failures and is to be carried out under as realistic conditions as practicable.

9 Documentation

The documentation required in Subsection 1/7 are to be expended to include the enhanced features where applicable, such as, but not limit to, following documents,

- i) *DP Operations Manual* (**I, OB**)
- ii) System description including a block diagram showing how the various components are functionally related (**R**)
- iii) Power generation and distribution (**R**)
- iv) Power analysis (**R**)
- v) Description of Power management (**R**)
- vi) Thruster control system (**R**)
- vii) Auxiliary system for power generation and thrusters (**R**)
- viii) DP control system (**R**)
- ix) Failure modes and effects analysis (FMEA) (**R, OB**)
- x) Test procedure for FMEA (**R**)

In addition, the following additional documents are to be provided where applicable:

- i) Description of protection design philosophy and protection systems the redundancy concept of DP system depends on. (**R**)
- ii) Analysis of effects of severe voltage transients on power system stability (**R**)
- iii) Short circuit analysis (**R**)
- iv) Simulation of severe over/under voltage and over/under frequency faults to prove the robustness of the power plant and its protection scheme for closed bus operation (**R**)
- v) Protection coordination analysis (**R**)
- vi) Documentation of protection settings (**R**)
- vii) Description of automatic blackout recovery (**R**)



SECTION 9 Station Keeping Performance

1 General

At the Owner's request, a station keeping performance notation (**SKP**), which is supplemental to the **DPS**-series notations may be assigned. The main objective of the station keeping performance notation is to provide for the consistent assessment of the station keeping performance reflecting the latest technology and to encourage robust redundancy design of DP systems.

The station keeping performance (**SKP**) notation can be granted if the analysis has been carried out according to this Section and the results satisfy the requirements.

Station keeping performance (**SKP**) may be assigned to each of the **DPS**-series notations as supplemental information about the DP system.

There are two levels of station keeping performance notations: **SKP** and **SKP(a,b,c,d,e,f)** (refer to the definitions in 9/1.1 of this Guide).

Notation **SKP** is for the station keeping assessment for given limiting environmental conditions and the assessment results meet the requirement of this Guide.

Notation **SKP(a,b,c,d,e,f)** provides more information other than limiting environmental conditions in terms of probability that the vessel can remain on station for a given site environment.

1.1 Definition

1.1.1 **SKP**

SKP is an optional notation as supplemental information about the station keeping performance for specified limiting environmental conditions, such as wind speed and direction, wave height and frequency, current speed and direction. In general, the limiting environments are to be applied to intact (all thrusters running) and damaged (worst case failure) conditions unless the limiting environmental conditions for post failure cases are also specified. The directions for wind, wave and current can be different and are to be specified by the Owner.

For example, a 1-year return environment is often used for MODUs as the limiting environment for DP operations. In that case **SKP** indicates that the station keeping performance of the vessel under the 1-year return environmental conditions has been verified through analysis, following procedures given in this Section.

1.1.2 **SKP(a,b,c,d,e,f)** (1 November 2013)

SKP(a,b,c,d,e,f) is an optional notation as supplemental information about the station keeping performance for a given environmental location. The analysis is to be carried out for many combinations of wind speeds, wave height and current speeds. The wind speed and wave height relationship is to be provided for the specified location. A co-linear condition for wind, wave and current is assumed.

- a** The probability that the vessel can remain on station at the selected site **f** and current speed of **e** with all thrusters/**rudders** in normal operation conditions
- b** The probability that the vessel can remain on station with the failure of minimum effect single thruster/**rudder** at the selected site **f** and current speed of **e**
- c** The probability that the vessel can remain on station with the failure of maximum effect single thruster/**rudder** at the selected site **f** and current speed of **e**

- d** The probability that the vessel can remain on station at the selected site **f** and current speed of **e** with the worst case failure condition
- e** Current speed in knot (Owner-specified or typically 1.5 kt)
- f** Environment location (Owner-specified or a representative typically North Sea location)

For example **SKP(95, 95, 85, 75, 2, North Sea)** stands for

- i)* 95% of time the vessel can remain on station with a current speed of 2-kt, North Sea wind and wave conditions, all thrusters operating,
- ii)* 95% of time the vessel can remain on station with a current speed of 2-kt, North Sea wind and wave conditions, with failure of minimum effect single thruster,
- iii)* 85% of time the vessel can remain on station with a current speed of 2-kt, North Sea wind and wave conditions, with failure of maximum effect single thruster, and
- iv)* 75% of time the vessel can remain on station with a current speed of 2-kt, North Sea wind and wave conditions, with worst case failure condition.

1.1.3 Normal Operation Condition

This is a designed condition for normal operation of a floating unit. The operating condition may be designed for one specific draft, or more than one operating drafts. If there are more operational conditions, minimum and maximum operational drafts need to be considered in the DP capability assessment.

1.1.4 Standby Condition

The standby condition is a condition when the intended operation is stopped voluntarily or involuntarily due to weather or other conditions. For an offshore drilling unit, the standby condition is a condition when risers are disconnected.

1.1.5 Traditional DP Capability Plot

In the traditional DP capability plot, the limiting environmental conditions are determined by varying wind speed for a given thruster configuration. Current speed is given and wave height is related to the wind speed.

1.1.6 Thrust Utilization Plot

In the thrust utilization plot, the thrust demand is calculated for a given limiting operating environmental condition. The wave height, wind speed and current are predefined. These types of plots allow the individual input of wind, current and wave data (in magnitude and direction) and display the power required for the thrusters over a 360 degree heading angle of the vessel.

3 Environmental Conditions

The environmental conditions are to be specified by the Owner of the DP vessel. The maximum design environments should generally be determined by annual statistics.

3.1 Wind

Wind is treated as a constant in direction and speed. The wind speed should be specified using one minute mean at height of 10 meters above water surface. A value of 1.18 could be used to convert hourly mean wind speed to one minute mean speed.

3.3 Wave and Wave Spectrum

For **SKP** notation, significant wave heights and characteristic periods (frequencies) are to be provided. For notation **SKP(a,b,c,d,e,f)**, the relationship of wind speed and wave height and the probability of non-exceedance of each given wind speed are to be provided.

The wave drift force is to be calculated for irregular sea states which can be described by a wave spectrum. A wave spectrum depends on geographical areas. The Owner of the DP vessel may specify the most appropriate wave spectrum determined from metocean data for the intended operating locations.

If a site specific wave spectrum is not available, the JONSWAP wave spectrum can be used for the North Sea and operating locations with limited fetch area. The JONSWAP wave spectrum can be expressed as:

$$S(\omega) = \frac{\alpha g^2}{\omega^5} \exp\left[-\beta(\omega_p / \omega)^4\right] \gamma^a$$

where

- S = wave energy density, in $m^2/(\text{rad}/\text{sec})$ ($\text{ft}^2/(\text{rad}/\text{sec})$)
- α = 0.0081
- g = standard gravity, in m/sec^2 (ft/sec^2)
- ω = angular frequency of wave component, in rad/sec
- β = 5/4
- ω_p = peak frequency, in rad/sec
- γ = peak enhancement factor
- a = $\exp\left[-(\omega - \omega_p)^2 / 2 \omega_p^2 \sigma^2\right]$
- σ = $\begin{cases} 0.07 & \text{if } \omega \leq \omega_p \\ 0.09 & \text{if } \omega > \omega_p \end{cases}$

For open seas, Bretschneider spectrum can be used and the spectrum is given by:

$$S_\zeta(\omega) = \frac{5\omega_p^4 H_s^2}{16\omega^5} \exp\left[-1.25(\omega_p / \omega)^4\right]$$

where

- S_ζ = wave energy density, in $m^2/(\text{rad}/\text{sec})$ ($\text{ft}^2/(\text{rad}/\text{sec})$)
- H_s = significant wave height, in m (ft)
- ω = angular frequency of wave component, in rad/sec
- ω_p = peak frequency, in rad/sec

3.5 Current

The current velocity is to include components due to tidal current, storm surge current, and wind driven current. The Owner of the DP vessel may specify the current speed determined from metocean data for the intended operating locations.

For a MODU, the current profile needs to be provided for the calculation of current load on risers if deemed important, especially for those geographic areas where current force can be the governing design load.

3.7 Environments for SKP(a,b,c,d,e,f) Notation

A typical **SKP(a,b,c,d,e,f)** notation normally refers to the use of a set of representative North Sea wind and wave conditions (see Section 9, Table 1) and 1.5-knot current.

For a **SKP(a,b,c,d,e,f)** notation for particular locations, for example the Gulf of Mexico, the site specific information for current speed, non-exceedance probability of wind speed (wave height) and relationship between wind speed and wave height are to be provided. The site specific environmental conditions are to be submitted for review.

TABLE 1
Relationship between Wind and Wave (North Sea)

Hs (m)	Tp (s)	Vw (m/s)	P non exc
0	0	0	0.0
1.28	5.3	2.5	14.3
1.78	6.26	5	35.7
2.44	7.32	7.5	56.9
3.21	8.41	10	73.3
4.09	9.49	12.5	85.2
5.07	10.56	15	92.5
6.12	11.61	17.5	96.6
7.26	12.64	20	98.4
8.47	13.65	22.5	99.3
9.75	14.65	25	99.7
11.09	15.62	27.5	99.9
12.5	16.58	30	99.9
13.97	17.53	32.5	100.0
15.49	18.46	35	100.0

Note: Significant wave height, peak period and wind speed are based on Table 3 of "Specification for DP Capability Plot" by IMCA. The probabilities of non exceedance are based on BMT Global wave statistics.

3.9 Environments for SKP Notation

For the **SKP** notation, the limiting environmental conditions including wave height and period, wind speed and current speed, and their corresponding directions are to be provided by the Owner. The co-linear condition of wind, wave and current is to be assumed if direction information is not provided.

For a MODU, the conditions for operation and standby need to be provided. In general, the 1-year environmental condition may be used for the operational condition.

5 Analysis Conditions

5.1 DP System Configurations

As a minimum, two conditions need to be considered:

- i) All thrusters in normal operating condition
- ii) The worst case failure condition

The worst case failure condition is to be determined from the basic design of redundancy concept.

5.3 Operating Conditions

Two operating conditions are to be considered as applicable.

- i) Normal operating condition. If a vessel is designed for operating at different loading conditions, namely different drafts, these are to be included in the station keeping analysis.
- ii) Standby condition where applicable.

7 Environmental Load Calculation

Model test data on wind, wave and current load are to be used whenever possible. If however no model test results are available, the loads can be calculated according to this Guide.

7.1 Wind and Current Force

7.1.1 Non-ship Shape Unit

For non-ship shape unit, wind and current force can be calculated according to *ABS Rules for Building and Classing Mobile Offshore Drilling Units* or *ABS Rules for Building and Classing Floating Production Installations*, where applicable, or API RP 2SK.

7.1.2 Ship Shape Unit

For a ship shape unit, wind and current force can be calculated according to API RP 2SK or the OCIMF publication, “*Prediction of Wind and Current Load on VLCCs*”.

7.1.3 Current on Drilling Risers

For a MODU, current force on drilling risers is to be included where deemed important.

7.3 Wave Force

Second order wave drift forces and yaw moment are to be considered in the station keeping capability analysis. They are to be calculated by using an appropriate hydrodynamic analysis computer program or extrapolated from model test results of a similar vessel.

9 Other External Loads

Where applicable, other external loads, such as pipeline tension, mooring line tension, heavy lift, may be considered for the DP capability assessment.

11 Available Thrust

11.1 Available Thrust for Thrusters

Manufacturer’s test data of full scale or suitable model test for the thrust output of thrusters are to be used as the basis of **SKP** notation in general. The assessment of available thrust is typically indicated as thrust at full rated power. The availability of full power is a function of the prime mover characteristic. The power/torque/rpm characteristic for diesel driven thrusters is to be evaluated to determine the level of power available during DP operations (i.e., during zero inflow velocity).

For thrusters with controllable pitch propellers as well as with hydraulically driven prime movers, full power is available at any inflow velocity.

Electric drives typically have a certain RPM range in which full power is available. The thruster propeller is to be selected so that DP operations fall within this range. The selection of the propeller pitch should consider this range for optimum system efficiency.

If no test results are available for the thrust output of thrusters, Appendix 1 of this Guide provides the guidelines for determining available thrust, which deals with typical thrusters and installation scenarios for DP vessels. Those guidelines may be used for preliminary studies.

11.3 Thruster-Thruster Interaction

When one thruster operates downstream of another, the available thrust of the thruster is reduced due to thrusters interaction. The effect of the interaction depends on the following

- i) Distance between the thrusters
- ii) Azimuth of the thrusters
- iii) Diameter of the thruster propeller
- iv) Thruster load
- v) Thruster design/configuration (i.e., degree of tilt of the propeller and/or nozzle axis)

This interaction effect is to be included in the station keeping performance assessment. The results from full scale or suitable model test for the thrust-thrust interaction effect are to be used whenever possible. If no such results are available, Appendix 1 of this Guide can be used as guidelines for the assessment of the interaction effect on the available thrust.

11.5 Thruster-Hull Interaction

The interaction between thrusters and the hull also reduces available thrust of the thrusters. The interaction includes following factors and they are to be included in the station keeping performance analysis.

- i) *Friction.* The flow of the slipstream along the hull will result in the thrust degradation due the friction of the hull. The degradation is related to the length and breadth of the flow along the hull.
- ii) *Coanda Effect.* When a thruster is oriented in a transverse direction, the output thrust of the thruster is affected by a so called Coanda effect. The reduction of the thrust is related to the bilge radius and the length of the flow underneath the hull.
- iii) *Pontoon Blockage.* The blockage of the slipstream due to presence of the pontoon, such as when a slipstream is orientated toward the pontoon, will affect the thrust output of the thruster. The effect is related to the distance between the pontoons and the azimuth of the thruster.
- iv) *Tilted Thruster/Nozzle.* A tilted thruster/nozzle can reduce above mentioned thruster-hull interactions and hence to improve the output of the thrust of the thrusters. This improvement can be considered in the station keeping performance analysis.

The full scale or model test results for the effects of thruster-hull interactions mentioned above and the tilted thruster/nozzle are to be used whenever possible. If such results are not available, Appendix 1 of this Guide can be used as guidelines for the assessment of the interaction effect on the available thrust.

11.7 Thruster-Current Interaction

Current inflow could reduce the thrust output of the thrusters and the thrust reduction is to be included in the station keeping performance analysis. Manufacturer's test data of full scale or suitable model test for the current effect is to be used whenever possible. If such data is not available, Appendix 1 of this Guide can be used as guidelines for the assessment of the current effect.

11.9 Tunnel Thruster

The available thrust generated by a transverse tunnel thruster is highly affected by the tunnel installation, location, and the geometry and configuration of the hull. The assessment of the tunnel thruster performance is to be based on axial flow pump hydrodynamics, not on marine propeller theories. Manufacturer's test data of full scale or suitable model test for the efficiency of the tunnel thruster is to be used whenever possible. If such data is not available, Appendix 1 of this Guide can be used as guidelines for the assessment of the efficiency of the tunnel thrusters.

13 Rudder Forces

For vessels with conventional propulsion arrangements, the propeller jet and its interaction with the rudder can be used to develop transverse forces in the stern of the vessel in lieu of thrusters during dynamic positioning operations. When this approach is used, the following considerations are to be addressed:

- i) Control over propeller thrust from zero to full power is required. This requires the installation of a controllable pitch propeller for diesel engine driven systems.
- ii) Only twin-screw propulsion systems should be considered for generating transverse rudder forces. With most rudders (exception: some steerable nozzle designs), the generation of transverse force simultaneously generates an unwanted force in the ahead direction. This parasitic thrust is to be compensated by thrust delivered in the astern direction by operating the second propeller (or by other azimuth thrusters, if available).
- iii) The use of conventional rudders for DP yields to very limited side forces. High-performance rudders or steerable nozzles are preferred for DP applications.

Manufacturer's test data of full scale or suitable model test for the rudder forces are to be used whenever possible. If such data is not available, Appendix 2 of this Guide can be used as guidelines for the assessment of the rudder forces.

15 SKP Calculations

The calculations for SKP are based on the balance of horizontal forces and yaw moment while the vessel is maintaining both position and heading. Those forces and moment include all forces and yaw moment resulted from thrusters, wind, waves, current and other external forces where applicable.

Where the vessel has been subject to alteration or addition, which may affect the station keeping characteristics of the DP system, the SKP is to be recalculated.

15.1 SKP Notation

For the **SKP** notation, the station keeping performance can be carried out by using quasi-static analysis approach or time-domain simulation approach that includes the dynamic component of wave load, controller and thruster response time.

The station keeping performance assessment is to include the following:

- i)* Limiting environmental conditions specified by Owner
- ii)* Co-linear condition of wind, wave and current
- iii)* Different directions for wind, wave and current specified by Owner
- v)* Analysis for 10-degree interval of headings between 0 to 360 degrees if not specified by the Owner
- vi)* Analysis for the heading ranges specified by the Owner

15.3 SKP(a,b,c,d,e,f) Notation

For the **SKP(a,b,c,d,e,f)** notation, the requirements for **SKP** is to be met if applicable. In addition, following conditions need to be considered.

- i)* Relationship of wave height, period and wind speed to be provided
- ii)* SKP numbers of (a, b, c, d) are calculated considering all heading station keeping capabilities.
- iii)* Capability calculation for 10-degree interval of headings between 0 to 360 degrees
- iv)* The SKP numbers are the weighted sum of all heading results.
- v)* If no heading probabilities are specified, equal probability for all headings can be used.

17 Documentation

Where the DP system is to be supplemented with a station keeping capability notation, the following information is to be submitted for assignment of a SKP.

- i)* General arrangement and lines plan
- ii)* Thruster arrangement
- iii)* Thruster power and thrust
- iv)* Thruster interactions
- v)* Capability plots
- vi)* Documentation on the environmental conditions long term distribution (any area for intended service)
- vii)* Relationship between wind speed and wave height if applicable
- viii)* Owner specified limiting environmental conditions



SECTION 10 Specific Vessel Types

1 Introduction

While station keeping using DP is a common function of all DP vessels, other functions driven by specific activities that a vessel will undertake are also to be considered. Additional criteria, specific to several vessel types, are given below. Mobile Offshore Drilling Units, Project or Construction Vessels, and Logistics Vessels are addressed, respectively, in Subsections 10/3, 10/5, and 10/7 as follows.

3 Mobile Offshore Drilling Units

3.1 Basic Design Criteria for DP System

3.1.1 Fault Tolerance

For DP MODUs, **DPS-2** equipment class and above are to be considered excluding self-elevating units that may use the DP system and **its** thrusters to maintain position only when installing the unit on-site (e.g. setting jack-up legs).

3.1.2 Limiting Environmental Conditions

Although the environmental conditions are specified by the Owner of the DP MODU, in general, one-year environmental condition for the area of operation is to be considered for DP MODU operating conditions. For position standby conditions, the design environmental condition is normally higher than that for operating conditions.

3.1.3 Station Keeping Performance

Station keeping performance is to be assessed for the limiting environmental conditions for operating and for position standby conditions.

Station keeping performance assessment is also to be performed for intact and post worst case failure conditions.

The current load on risers is to be considered, if deemed important.

3.3 Position Reference Systems and Sensors

The selection and installation of position reference systems and sensors are to take into account the suitability and reliability of the systems.

Satellite and acoustics are two types of position reference systems that are suitable for deep water operation. The update rate of acoustics and the impact of possible obstructions for the satellite systems are to be considered when deciding the suitability of the position reference system.

Enhanced DP control system (**EHS-C**), see Section 8, includes **additional** requirements for position reference systems with enhanced availability and reliability.

3.5 Effect of Drilling Loads

Power consumption of drilling operations and power sharing between the DP system and drilling operations are to be analyzed and submitted for review.

3.7 Vessel Operating Condition

In addition to the normal drilling operational condition, positioning standby condition is also to be considered in the DP system design in terms of available power to the DP system and the station keeping capability.

3.9 Emergency Shutdown System (1 September 2015)

The general emergency shutdown philosophy for the vessel and the effect of the emergency shutdown system on the redundancy of the DP system is to be carefully considered.

Risks associated with technical faults and inadvertent operations of the emergency shutdown system are to be considered. Each vessel is to develop a detailed plan for recovery and restoration of operation after operation of each level of ESD.

ESD Stations that can enable a total unit shutdown should not be located in locations which are unmanned under normal operations except in the backup DP Control Station, if provided. Where ESD stations are provided at the lifeboat stations or other unmanned locations, the total unit ESD (complete shutdown) is to be protected from unauthorized personnel or not available at these unmanned locations.

3.9.1 ESD Operation Manual

- i) The ESD Operation Manual describes the ESD system and unit specific operational guidelines.
- ii) ESD Operations are to consider the potential risks and risk areas as well as the appropriate responses for each risk.
- iii) The ESD Operation Manual is to define the ESD levels and provide a list of equipment or areas that are affected by the different ESD levels. Also, the manual is to indicate which ESD levels are available at each ESD station. Further, the manual is to provide instructions on to reset the affected systems after each ESD.
- iv) The descriptions and instructions in the ESD Operation Manual are not to conflict with the WCFDI identified in the DP FMEA.
- v) The ESD Operation Manual is to provide guidance describing the typical scenarios that the ESD levels should be used and who has access to use them.
- vi) The ESD Operation Manual is to be included or referenced in the unit's operating manual.

3.9.2 Gas Detection/ESD System Cause and Effect Chart

Where shutdown groups are initiated automatically upon gas detection, a Gas Detection/ESD System Cause and Effect Chart shall relate gas detection sensors to ESD shutdown groups of equipment and areas on the unit.

3.11 Emergency Disconnect System (1 November 2013)

Time for safe disconnection of risers is to be considered in the DP system design for the post failure station keeping capability.

The operational impact of working in suitable water depth is to be considered in terms of required safe disconnecting time and the feasibility of the equipment and procedures is to be studied.

3.13 Maintenance Plan

DP MODUs are to have a structured planned maintenance system that specifically addresses maintenance of the DP system, equipment and support systems.

Planned maintenance is to address all equipment that has an impact on the vessel's station keeping capabilities. This is to include indirect components such as generator circuit breakers, bus-tie breakers, etc. Maintenance is to include regular cleaning, calibration, and testing of equipment as outlined in manufacturers' recommendations and industry guidelines.

Records of planned and unplanned maintenance are to be kept in an auditable format, either hard copy or appropriate electronic format. These records are to include vendor service records as well as maintenance performed by vessel personnel. These records are to be kept onboard for the period specified by the Owner, and they are to be available for review by the Surveyor during periodic surveys of the vessel to maintain the DPS related notation.

3.15 FMEA

In addition to the DP system, the DP FMEA for a DP MODU is to take account of non DP systems that have interfaces with and potential impact on DP and station keeping, such as:

- i) Drilling system
- ii) Emergency shutdown system
- iii) Safe Disconnection of risers

3.16 DP Alert System (1 November 2013)

A system of visual and audible alarms, supplied by a UPS and with an indication of power being available, is to be provided in each DP control station, on the navigation bridge, at the engine control position, at drill floor, and at drilling supervisor's office. The status of the DP system in operation is to be indicated.

3.17 DP Operations Manual

In addition to the requirements of Subsection 2/13, the DP *Operations Manual* for a MODU is to address operating issues relating to equipment and systems that are interfaced to the DP system. This includes ESD systems installed on DP MODUs and emergency disconnect system.

Detailed procedures are to be developed for operating ESD and EDS. Procedures are to highlight criteria for initiation and consequences. The MODU's DP operating manual is to clearly identify where this information can be found if not included in the manual.

The MTS publication "DP Operations Guidance, Part 2, Appendix 1 (DP MODU)" can be followed for the development of the DP *Operations Manual*.

3.19 Documentation (1 September 2015)

In addition to the documentation requirements of Subsection 1/7 of this Guide, the following documents are to be submitted for review:

- i) ESD Operation Manual
- ii) Gas Detection/ESD System Cause and Effect Chart

5 Project or Construction Vessels

5.1 Basic Design Criteria for DP System

5.1.1 Feasible DP Control System

The DP control system is to be equipped with suitable DP modes for the activities carried out by the project/construction vessels.

When carrying out industrial missions, the availability of the suitable DP mode is to be verified.

The following selected DP control modes are relevant to specific DP activities.

- i) *Target Follow*: Enables the DP vessel to follow a moving target.
- ii) *Heavy Lift*: Takes account of the effects of the load transfer on the mass of the vessel and the additional lateral force.
- iii) *External Force Compensation*: Where the measured external force acting on the vessel, which is separate from the environment, is included in the DP calculation and treated as a force feed forward. This mode is used to account for pipe tensions in a pipe laying vessel and hawser tension in a shuttle tanker.
- iv) *Fire Monitor Compensation*: Used to compensate for the varying forces exerted on a vessel from discharge of a fire monitor.

- v) *Weathervane*: Enables the DP vessel to rotate with the wind, current and waves around a fixed or moving point called the terminal point. Neither the heading nor the position of the DP vessel is fixed. The heading of the vessel is controlled to point towards the terminal point. The position of the vessel is controlled to follow a circle, called the setpoint circle, around the terminal point. This mode is appropriate for connected shuttle tanker/FPSO operations.

5.1.2 Station Keeping Performance

External forces and weathervane are to be included in the station keeping performance assessment where applicable.

5.3 Operation Configuration

In general, the DP project/construction vessels are to operate in open bus. If a closed bus-tie is one of the operation configurations, risk assessment is to be performed.

5.5 Position Reference Systems and Sensors (1 November 2013)

The selection and installation of position reference systems and sensors are to take into account the activities carried out by the DP vessels and the obstructions from other units.

For project/construction DP vessels, redundancy of the relative reference systems is to be considered when carrying out activities close to other structures and **the loss of the relative reference system is to be included in the FMEA.**

Satellite and acoustics are two types of position reference systems that are suitable for deep water operation. The update rate of acoustics and the impact of possible obstructions on the satellite systems are to be considered when deciding the suitability of the position reference system.

5.7 Maintenance Plan

For Project/Construction vessels where preventive maintenance is to be carried out while undertaking project activities, due consideration is to be given to methods that will permit the vessel to continue the operation in the identified operation mode. The details are to be included in the *Operations Manual*.

5.9 FMEA

In addition to the DP system, the Overall Vessel FMEA for a DP project/construction vessel is to take account of non DP and auxiliary systems, if applicable, that have interfaces with and potential impact on DP and station keeping.

5.10 DP Alert System (1 November 2013)

For diving support vessels, a system of visual and audible alarms, supplied by a UPS and with an indication of power being available, is to be provided in each DP control station, on the navigation bridge, at the engine control position, in the dive control, saturation control and air diving control areas, in the working area, and, where applicable, the ROV or submersible control position. The status of the DP system in operation is to be indicated.

5.11 DP Operations Manual

In addition to the DP system, the *DP Operations Manual* for a project/construction vessel is to address operating issues relating to equipment and systems that are interfaced to the DP system, if applicable.

An Activity Specific Operation Guideline (ASOG) may be developed for each activity undertaken by the vessel and be referenced in the *DP Operations Manual*.

The MTS publication, “*DP Operations Guidance, Part 2, Appendix 2 (Project and Construction Vessels)*”, can be followed for the development of the *DP Operations Manual*.

7 Logistics Vessels

7.1 Operation Mode

The DP logistics vessel mainly provides logistics support for the project. The vessel, in general, works in DP mode in a 500 m proximity operation zone. Generally, closed bus-tie operation is to be avoided for logistics vessels. If closed bus-tie is one of the operation configurations, risk assessment is to be performed.

7.3 Position Reference Systems and Sensors *(1 November 2013)*

The selection and installation of position reference systems and sensors are to take into account obstructions from other units. For DP logistics vessels, **loss of the relative reference system is to be included in the FMEA for the activities to be carried out. The redundancy of the relative reference systems is to be considered where necessary and is** to be consistent with the redundant design of the DP system.

7.5 DP Operations Manual

The MTS publication, “DP Operations Guidance, Part 2, Appendix 3 (Logistic vessels)”, can be followed for the development of the DP *Operations Manual*.



SECTION 11 Other Optional Notations (1 November 2013)

1 Introduction

Software is one of the essential components in a computer-based DP system that DP vessels heavily rely on. For **DPS-2** and **DPS-3** notations, although FMEA and proving sea trial are required for the verification of the DP control system and DP power management system, the scope of the testing and verification of the software for the systems are very limited.

The *ABS Guide for Integrated Software Quality Management (ISQM)* provides criteria for higher level requirements on the verification of the software.

The *ABS Guide for Software Systems Verification – ABS CyberSafety™ Volume 4 (SSV Guide)* provides criteria on the verification of Systems. The criteria provided covers verification of the hardware and logic, including software.

Compliance with the procedures and criteria given in these Guides may result in the granting of the optional notations that signify the software functionality for the system.

An Owner interested in seeking these notations can refer to the mentioned two Guides for detailed requirements. This Section provides a brief introduction about the application of the mentioned Guides for DP systems.

3 Integrated Software Quality Management for DP System

The *Integrated Software Quality Management Guide's* ISQM process monitors the development and then verifies the software installation on the facility. ISQM provides a process covering the software development life cycle from development to retirement of the control system.

The ISQM process is applicable to any system that relies on software. The scope of the ISQM varies with the complexity of the system. It is most beneficial for an integrated system since difficulties arise in the interfaces and during the integrations.

The scope of the ISQM for the DP system includes the DP control system, power system, thruster control system and necessary auxiliaries if operated through software.

Upon verification of compliance with the requirements indicated in the Guide, the classification notation **ISQM** may be assigned to selected systems.

5 System Verification for DP System

The *SSV Guide* provides a process for Hardware-In-the-Loop verification of the system(s) software. SSV is a subset of ISQM with a focus on software verification and may be requested with ABS' ISQM or alone. The optional System Verification Notation may be assigned to a vessel or facility. For a DP system, the *Guide for Software Systems Verification – ABS CyberSafety™ Volume 4* provides specifics for DP control systems.



APPENDIX 1 Available Thrust Assessment

1 General

This Appendix provides guidelines for the determination of the thrust generated by various types of thrusters (Subsections A1/3 and A1/11). It also addresses the interactions of thrusters (thruster-thruster, thruster-hull, thruster-current, Subsections A1/5, A1/7 and A1/9) which often result in a reduction of the available thrust.

The available thrust from this Appendix may be used for preliminary studies for the design of the DP system. Manufacturer's test data of full scale or suitable model test for the thrust output of thrusters are to be used whenever possible for further verification.

3 Thrust at Bollard Pull

The achievable bollard pull for a thruster is basic data for the DP system performance assessment. The graphs below indicate the available bollard pull for typical thruster configurations (including conventional main propulsion arrangements), for propellers with nozzles and open propellers. The propeller disk area load is the ratio of the thrust per motor input power in kN/kW and the motor power per propeller disk area $A = D^2 \pi/4$, in m².

For open propellers, the following equation can be used to calculate the available bollard pull thrust (the units of measure are in SI (MKS and US) systems, respectively):

$$T_0 = K \cdot (P \cdot D)^{2/3}$$

where

T_0	=	bollard pull, in N (kgf, lbf)
P	=	propeller power, in kW (PS, hp)
D	=	propeller diameter, in m (m, ft)
K	=	848 (70.4, 70.3)

**FIGURE 1
Open Propellers**

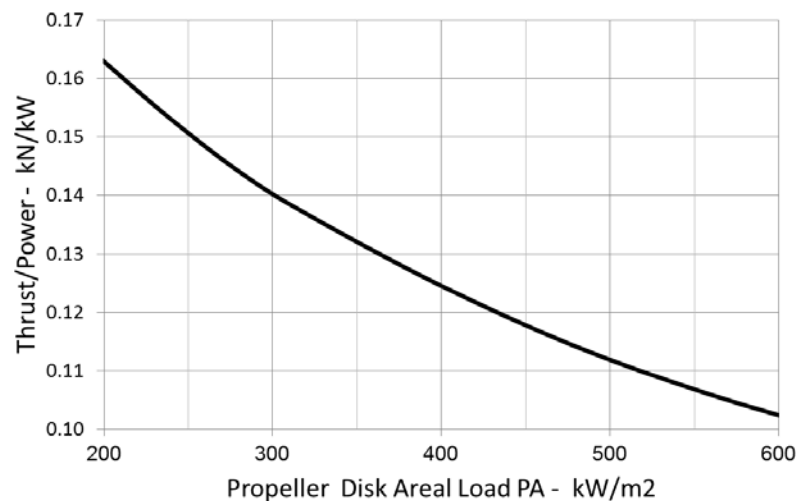

For ducted propellers, the following equation can be used to calculate the available bollard pull thrust:

$$T_0 = K \cdot (P \cdot D)^{2/3}$$

where

- T_0 = bollard pull, in N (kgf, lbf)
- P = propeller power, in kW (PS, hp)
- D = propeller diameter, in m (m, ft)
- K = 1250 (103.8, 103.7)

FIGURE 2
Ducted Propellers

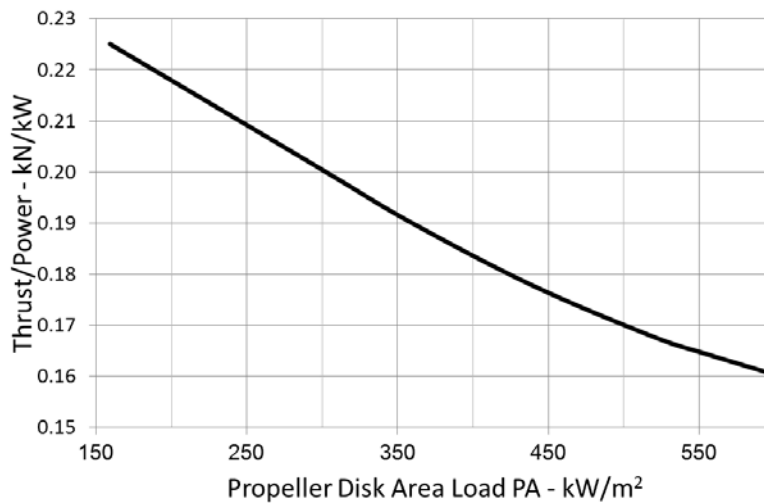

5 Thruster-Thruster Interaction

The reduction of the thrust output due to thruster-thruster interaction may depend on the following

- i)* Distance between the thrusters,
- ii)* Azimuth of the thrusters,
- iii)* Diameter of the thruster propeller,
- iv)* Thruster load,
- v)* Thruster design/configuration (i.e., degree of tilt of the propeller and/or nozzle axis).

The following paragraphs describe the thrust reductions for two principal identical thruster configurations.

5.1 In Line Tandem Condition

Appendix 1, Figure 3 depicts thrusters in line tandem configuration. The rear thruster operates directly downstream of the other thruster in open water.

FIGURE 3
Thrusters Configuration in Tandem Condition

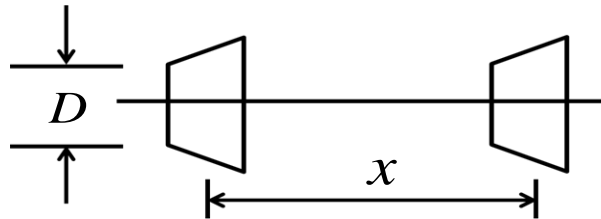

The thrust reduction ratio t defined below for the downstream thruster can be calculated as follows:

$$t = T/T_0 = 1 - 0.75(x/D)^{\frac{2}{3}}$$

where

- x = distance between the two thrusters, in m (m, ft)
- D = thruster diameter, in m (m, ft)
- T_0 = bollard pull thrust in open water, in N (kgf, lbf)
- T = thrust of the downstream thruster, in N (kgf, lbf)
- t = thrust reduction ratio

FIGURE 4
Thrust Reduction of the Downstream Thruster in Open Water

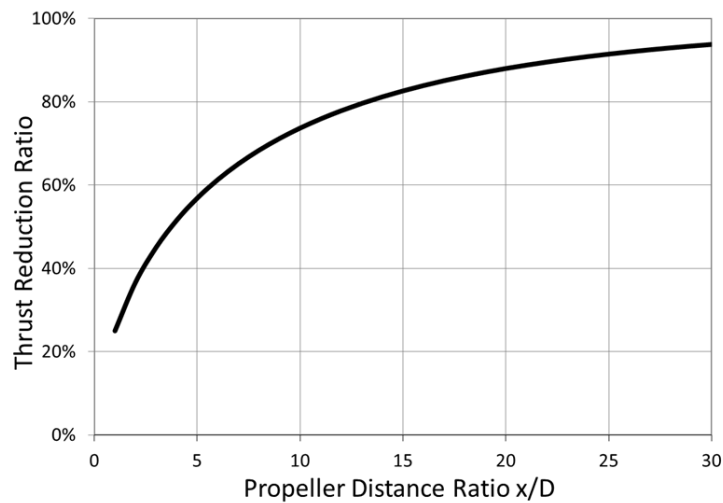

5.3 Upstream Thruster Turned Tandem Configuration

Appendix 1, Figure 5 depicts the thruster in upstream turned tandem configuration.

FIGURE 5
Thrusters Configuration in Tandem Condition Turning the Upstream Thruster

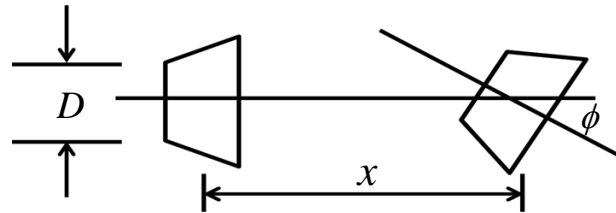

The thrust reduction ratio t defined below for the downstream thruster considering steering angles of the upstream thruster can be calculated as follows:

$$t_{\phi} = t + (1 - t) \frac{\phi^3}{130/t^3 + \phi^3}$$

where

- ϕ = steering angle, in degrees
- t = thrust reduction ratio at zero steering angle
- t_{ϕ} = thrust reduction ratio at steering angle, ϕ

FIGURE 6
Thrust Reduction of the Downstream Thruster Considering Steering Angles of the Upstream Thruster

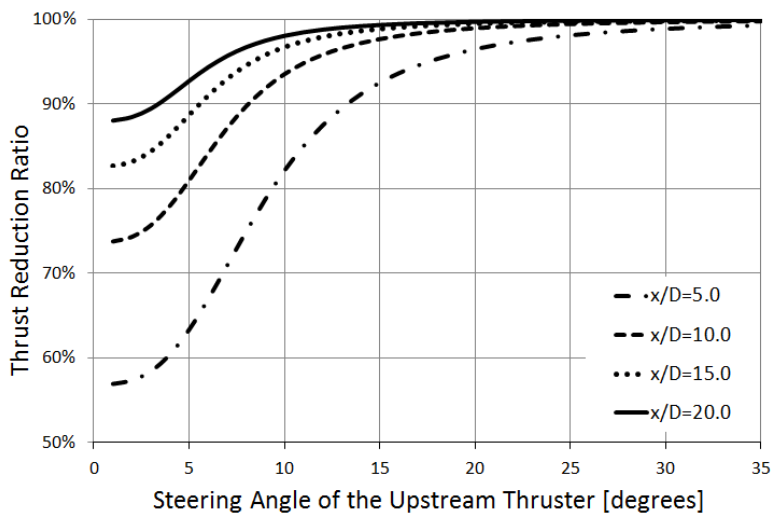

5.5 Forbidden Zones

Forbidden zones, sometimes called barred sectors, may be utilized in thruster control to avoid excessive loss due to thruster-thruster interactions. That can be achieved by limiting certain orientations of azimuth thrusters.

The forbidden zones can be calculated using a simple algorithm based on the thruster-thruster interaction effect presented above. The range of the zones shown in Appendix 1, Table 1 depends on the distance between the thrusters and their diameters, and it could be determined by the following method:

$$\phi_f \text{ is the angle which minimizes the value of } \frac{T_d}{t_\phi \cdot \cos \phi} \quad (0^\circ < \phi < 45^\circ)$$

where

- ϕ_f = range of forbidden zone, in degrees
- T_d = demanded thrust, in N (kgf, lbf)
- t_ϕ = thruster reduction ratio at steering angle ϕ

FIGURE 7
Range of Forbidden Zone

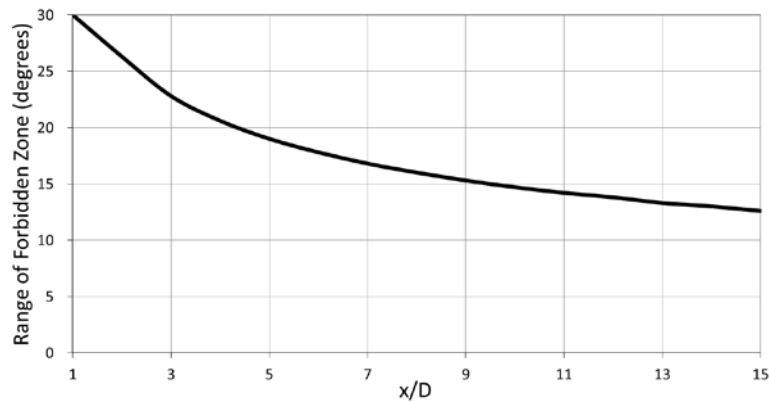

TABLE 1
Range of Forbidden Zone for Different x/D

x/D	Angle (degrees)	x/D	Angle (degrees)	x/D	Angle (degrees)
1	30	6	17.8	11	14.2
2	26.3	7	16.8	12	13.8
3	22.8	8	16	13	13.3
4	20.6	9	15.3	14	13
5	19	10	14.7	15	12.6

In Appendix 1, Figure 7 and Appendix 1, Table 1, x is the distance between the two thrusters and D is thruster diameter.

7 Thruster-Hull Interaction

This Subsection provides the methods for the calculation of thrust degradation due to thruster-hull interaction. Consideration of thruster tilt is also provided.

7.1 Friction

The thrust degradation due to hull friction is related to the length and breadth of the downstream flow along the hull. The graph below can be used for the assessment of the thrust reduction ratio t_f due to the hull friction.

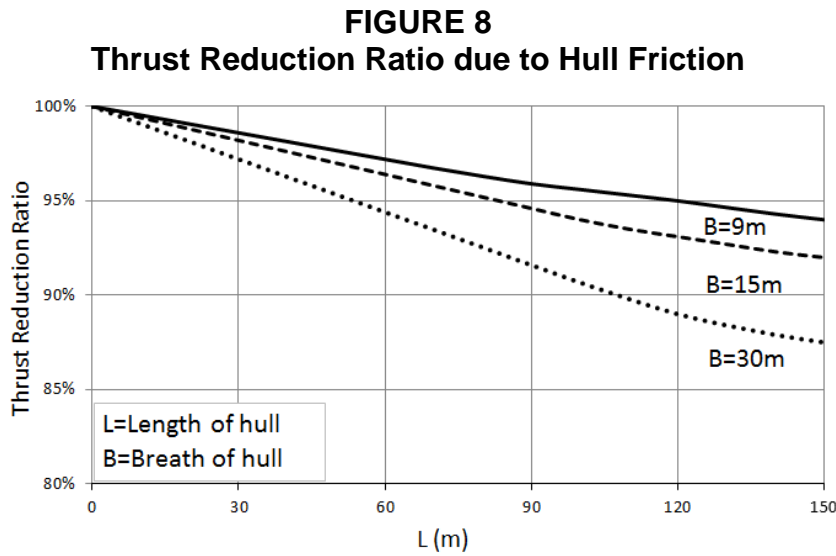

7.3 Coanda Effect

The Coanda effect is related to the bilge radius and the length of the flow underneath the hull. If no detailed data available, the thrust reduction ratio t_c due to Coanda effect can be taken as 97%.

7.5 Pontoon Blockage (1 November 2013)

The blockage of the downstream flow due to presence of the pontoon occurs when a downstream is orientated towards the pontoon, such as the downstream of a thruster on one pontoon is directed towards the opposite pontoon. The reduction of the thrust output due to the pontoon blockage can be calculated using the formula below.

$$t_p = 0.8K \cdot \frac{L_p}{55}$$

where

- t_p = thrust reduction ratio due to pontoon blockage, **not greater than 1**
- L_p = length of the downstream centerline between two pontoons, in m (ft)
- K = 1 (0.305)

7.7 Tilted Thruster/Nozzle

A tilted thruster can improve the thrust output.

For the tilt angle range from 0 to 8 degrees, the following equation can be applied to determine the improvement of thrust reduction ratio:

$$t_h = t_f \cdot t_c \cdot t_p + (1 - t_f \cdot t_c \cdot t_p) \cdot C$$

where

- t_h = total thrust reduction ratio of thruster-hull interaction
- t_f = thrust reduction ratio due to friction
- t_c = thrust reduction ratio due to Coanda effect
- t_p = thrust reduction ratio due to pontoon blockage
- C = tilt thruster correction factor

FIGURE 9
Correction Factor, C, as the Function of the Tilt Angle of the Propeller Shaft

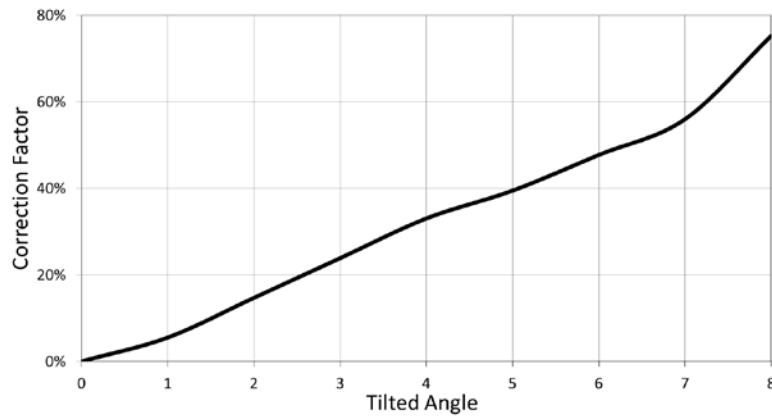

9 Thruster-Current Interaction

Current inflow may reduce thrust output of the thrusters and the reduction of the thrust can be calculated using the graphs or equations given below for ducted or open propellers at current speeds between 0 - 2 m/s.

FIGURE 10
Thrust Ratio for Ducted Propellers

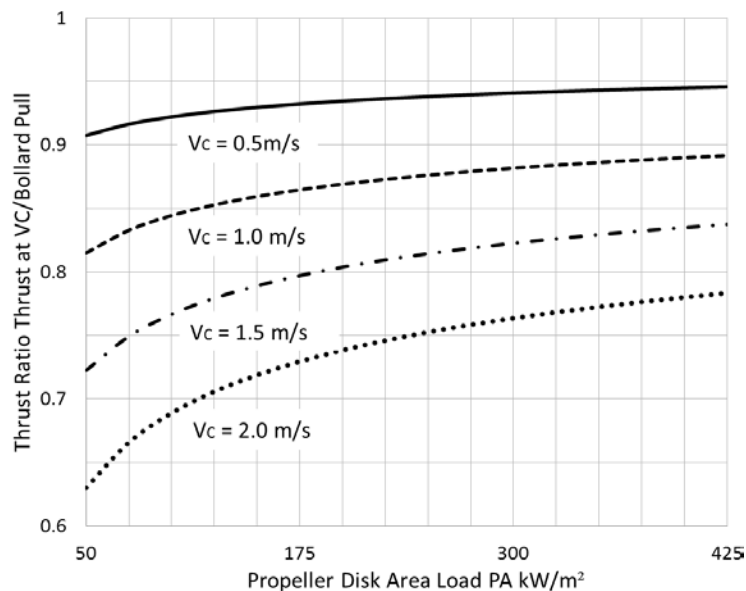

For ducted propellers with current speed ranges from 0 to 2 m/s, the following equation can be applied:

$$EFC = 1 - (K_1/PA)^{0.25} \cdot K_2 \cdot V_C$$

where

- EFC = thrust reduction ratio due to current
- V_C = current speed, in m/s (m/s, ft/s)
- PA = propeller disk area load, in kW/m² (PS/m², hp/ft²)
- K_1 = 400 (544, 50)
- K_2 = 0.11 (0.11, 0.034)

FIGURE 11
Thrust Ratio for Open Propellers

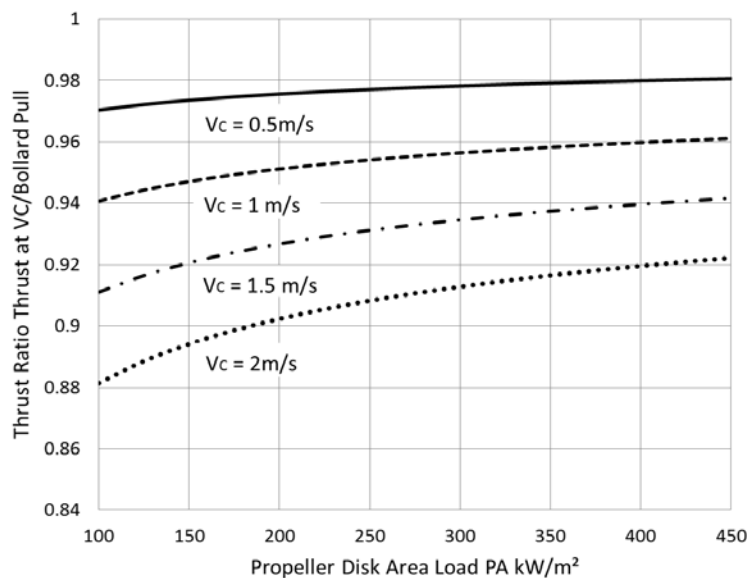

For open propellers with current speed in the range from 0 to 2 m/s, the following equation can be applied:

$$EFC = 1 - (K_1/PA)^{0.28} \cdot K_2 \cdot V_C$$

where

- EFC = thrust reduction ratio due to current
- V_C = current speed, in m/s (m/s, ft/s)
- PA = propeller disk area load, in kW/m² (PS/m², hp/ft²)
- K_1 = 10 (136, 1.25)
- K_2 = 0.11 (0.11, 0.034)

11 Tunnel Thrusters

The available thrust generated by a tunnel thruster is highly affected by the tunnel installation, location, and the geometry and configuration of the hull. The assessment of the tunnel thruster performance is to be based on axial flow pump hydrodynamics, not on marine propeller theories. If no data are available, the available thrust of a tunnel thruster can be estimated according to the following procedure which is based on axial flow pump theory adapted to the specific conditions of tunnel thrusters.

FIGURE 12
Dimensions of Transverse Tunnel Thrusters (1 November 2013)

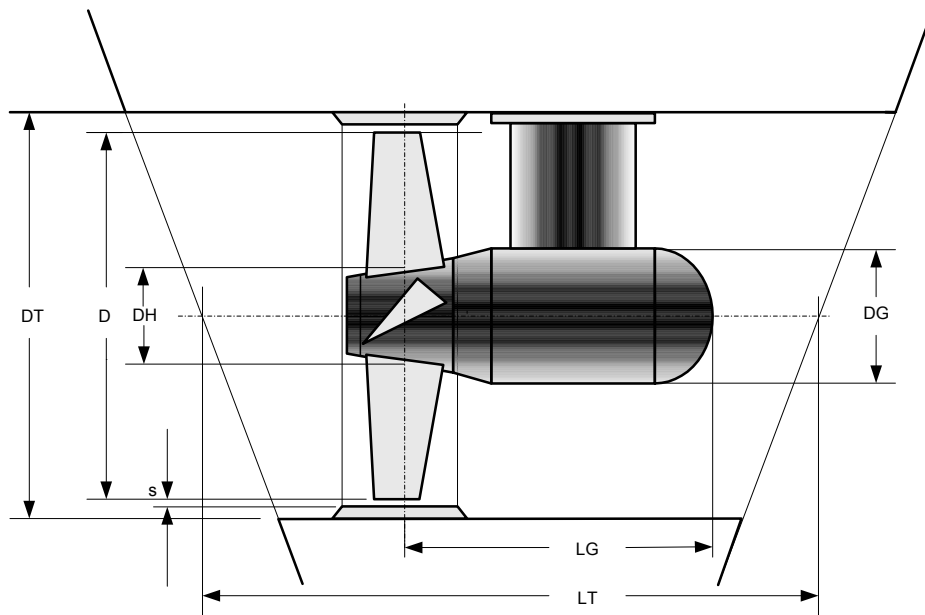

11.1 Simplified Method (1 November 2013)

At the preliminary design phase of a project, a simplified equation, provided below, for the calculation of available thrust can be used, which is based on typical average tunnel thruster configurations.

$$T = \sqrt[3]{\rho \cdot \pi \cdot \left(K \cdot P \cdot \eta_p \cdot \frac{DT}{TL} \right)^2}$$

where

- T = thrust, in N (kgf, lbf)
- ρ = mass density of seawater
 - = 1025 kg/m³ SI and MKS units
 - = 63.9 lb/ft³ US units
- K = 1000 (24, 97.2)
- P = power at the tunnel thruster propeller, in kW (PS, hp)
 - = $P_{mot} \cdot \eta_{TG}$
- P_{mot} = motor output power, in kW (PS, hp)
- η_{TG} = efficiency of the thruster gear
 - = 0.95
- η_p = efficiency of the propeller (impeller)
 - = 0.8
- DT = tunnel diameter, in m (m, ft)
- TL = 1.65 for tunnels of average length, no grids, hull angle $\delta = 70$ degrees, and conical tunnel entries

11.3 Detailed Method

When more information is available at the later design stage for tunnel thrusters, the detailed method described below can be used.

11.3.1 Thrust Loss Factor (1 November 2013)

- i) Hydrodynamic loss caused by the tunnel entry/exit geometry

$$E = 0.1 \quad \text{for rounded entry/exit shape}$$

$$E = 0.25 \quad \text{for conical entry shape}$$

$$E = 0.5 \quad \text{for sharp entry}$$

FIGURE 13
Tunnel Configuration

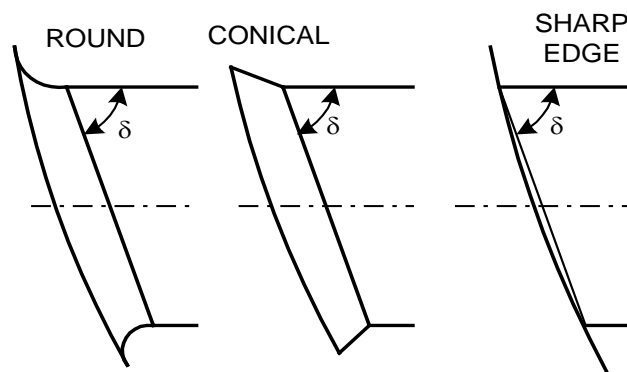

- ii) Venturi effect loss factor

$$V = 0.15 \quad (\text{Typical value for tunnel thruster})$$

- iii) Friction loss factor

$$R = CF \cdot A \cdot LT/DT$$

where

CF = coefficient of friction assuming exposed weld seams and minor marine growth on surfaces

$$= 0.05$$

A = factor for the increased velocity inside the tunnel due to the thruster gear housing

$$= 1 + LG/LT \{ 1/[1 - (DG/DT)^2] (1 - DG/DT) - 1 \}$$

LG , LT , DG , and DT are as given in Appendix 1, Figure 12.

- iv) Loss due to protective bars

This applies to tunnels equipped with protective bars (grids) at the openings.

$$G = SF \cdot [AG/(DT^2 \cdot \pi/4 - AG)]^{4/3}$$

where

SF = grid shape factor (see Appendix 1, Figure 14)

AG = projected grid area in m^2 (m^2 , ft^2)

DT = tunnel diameter in m (m , ft)

FIGURE 14
Protective Bars Cross Section

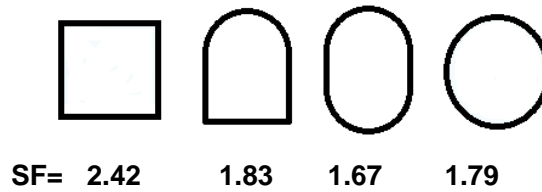

v) Loss due to hull inclination

$$H = 0.3 \cdot \cos(\delta) + 0.2 \cdot \cos^2(\delta)$$

where

H = influence of the hull angle

δ = in degrees (shown in Appendix 1, Figure 13)

vi) Total loss factor

$$TL = 1 + E + V + R + G + H$$

11.3.2 Available Thrust (1 November 2013)

For tunnel thrusters, the following equations can be used to calculate the available thrust:

$$T = \sqrt[3]{\rho \cdot \pi \cdot \left(K \cdot P \cdot \eta_p \cdot \frac{DT}{TL} \right)^2}$$

where

T = thrust in N (kgf, lbf)

ρ = mass density of seawater

= 1025 kg/m³ [SI and MKS units]

= 63.9 lb/ft³ [US units]

P = power at the tunnel thruster propeller, in kW (PS, hp)

= $P_{mot} \cdot \eta_{TG}$

P_{mot} = motor output power, in kW (PS, hp)

η_{TG} = efficiency of the thruster gear

= 0.95

η_p = efficiency of the propeller (impeller)

= 0.8

DT = tunnel diameter, in m (m, ft)

TL = total loss factor

K = 1000 (24, 97.2)

APPENDIX 2 Rudder Forces

For vessels with conventional propulsion arrangements, the propeller jet and its interaction with the rudder can be used to develop transverse forces in the stern of the vessel in lieu of thrusters during dynamic positioning operations.

The following graphs can be used for the estimate of achievable rudder forces in transverse and longitudinal (ahead) direction for rudder with different nozzle configurations. Manufacturer’s test data of full scale or suitable model test for the rudder forces are to be used whenever possible for further verification.

**FIGURE 1
High-performance Rudder**

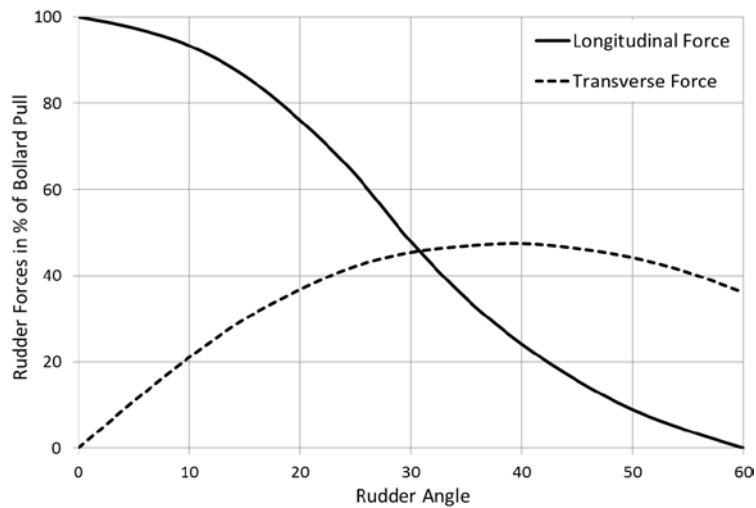

**FIGURE 2
Steerable Nozzle with Flap**

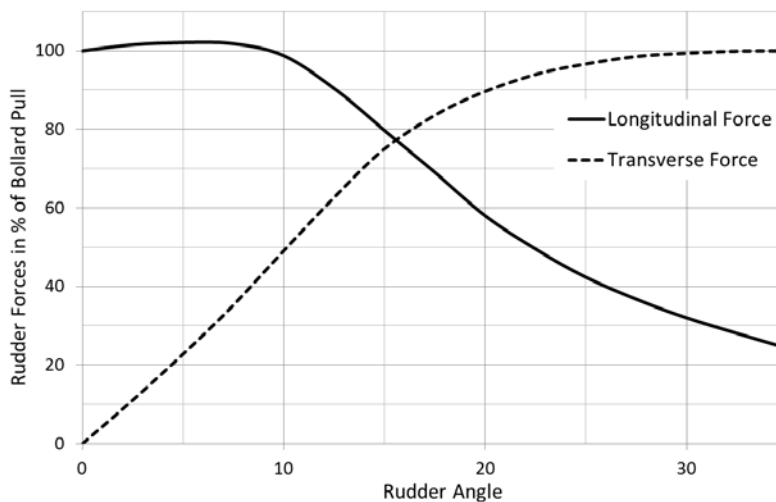

FIGURE 3
Steerable Nozzle with Fixed Fin

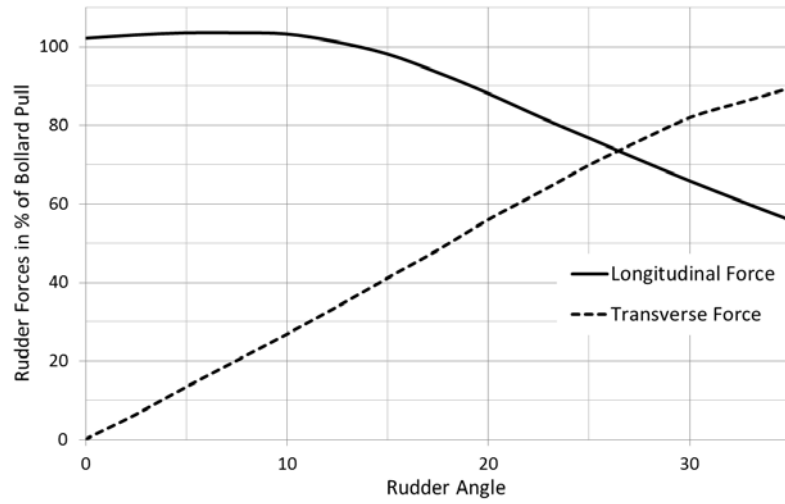
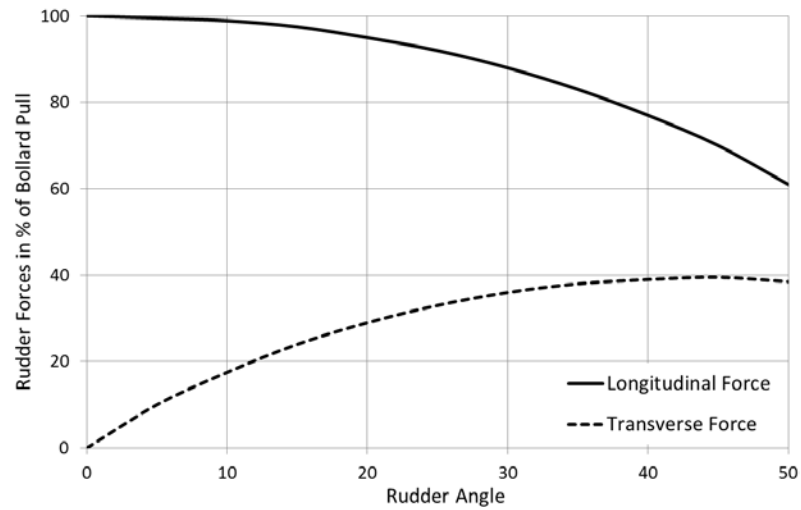

FIGURE 4
Conventional Rudder





APPENDIX 3 Abbreviations and References

1 Abbreviations *(1 November 2013)*

ABS:	American Bureau of Shipping
API:	American Petroleum Institute
AVR:	Automatic Voltage Regulator
CPP:	Controllable Pitch Propeller
DP:	Dynamic Positioning
DPO:	DP Operator
ECR:	Engine Control Room
EDS:	Emergency Disconnect System
EGP:	Enhanced Generator Protection
EHS:	Enhanced System
ESD:	Emergency Shut Down
FMEA:	Failure Mode and Effect Analysis
GNSS:	Global Navigation Satellite System
GLONASS:	Global Navigation Satellite Systems
GPS:	Global Positioning System
HVAC:	Heating, Ventilating and Air Conditioning
IMCA:	International Marine Contractors Association
IMO:	International Maritime Organization
ISQM:	Integrated Quality Management Guide
KVAR:	Kilovolt -Amperes, Reactive
KW:	Kilowatt
MODU:	Mobile Offshore Drilling Unit
MTS	Marine Technology Society
MRU:	Motion Reference Unit
OB:	Onboard
OCIMF:	Oil Companies International Marine Forum
PMS:	Power Management System
PRS:	Position Reference System
RPM:	Revolution Per Minute
SKP:	Station Keeping Performance

SSV:	Software System Verification
SVR:	Steel Vessel Rules
UPS:	Uninterruptable Power Supply
WCFDI:	Worst Case Failure Design Intent
WCF:	Worst Case Failure

3 References

3.1 ABS Publications

ABS *Rules for Building and Classing Steel Vessels (Steel Vessel Rules)*

ABS *Rules for Building and Classing Mobile Offshore Drilling Units (MODU Rules)*

ABS *Rules for Survey After Construction (Part 7)*

ABS *Guide for Integrated Software Quality Management (ISQM)*

ABS *Guide for Software Systems Verification – ABS CyberSafety™ Volume 4*

3.3 Other Publications

IMO MSC Circular 645, *Guidelines for Vessels with Dynamic Positioning Systems*, 1994

IMO 2000 HSC Code, *International Code of Safety for High-Speed Craft*, 2000

IMO 2009 MODU Code, *Code for the Construction and Equipment of Mobile Offshore Drilling Units*, 2009

IMCA M 103 Rev I, *Guidelines for Design and Operation of Dynamically Positioned Vessels*, 2007

IMCA M 206, *A Guide to Electrical Power and Control System*, 2010

IMCA M 04/04, *Methods of Establishing Safety and Reliability of Dynamic Positioning Systems*, 2004

IMCA M 166, *Guidance on Failure Mode and Effects Analyses (FMEAs)*, 2002

IMCA M 178, *FMEA Management Guide*, 2005

IMCA, *Specification for DP Capability Plots*, 2000

IEC 60812, *Analysis techniques for system reliability - Procedure for Failure Mode and Effects Analysis (FMEA)*, 2006

MTS, *DP Operation Guidance*, 2012

MTS, *DP Vessel Design Philosophy Guidelines*, 2012

API RP 2SK, *Recommended Practice for Design and Analysis of Stationkeeping Systems for Floating Structures*, 2008

OCIMF, *Prediction of Wind and Current Load on VLCCs*