

DYNATORQUE®

Gear Operators and Automated Valve Accessory Products

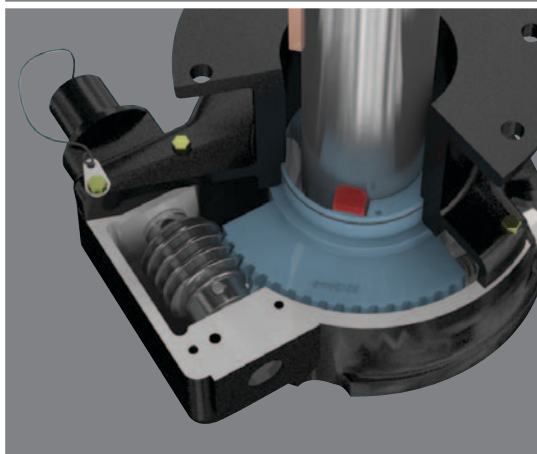

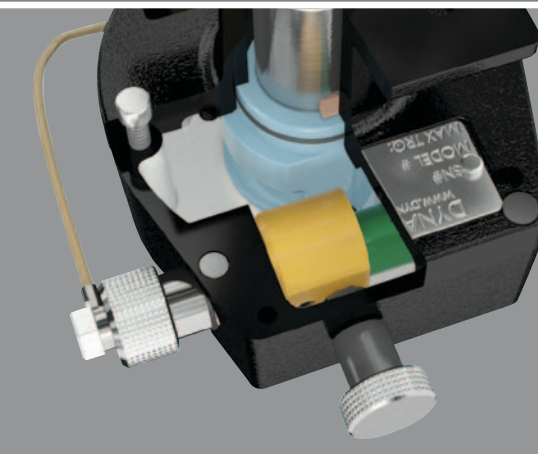
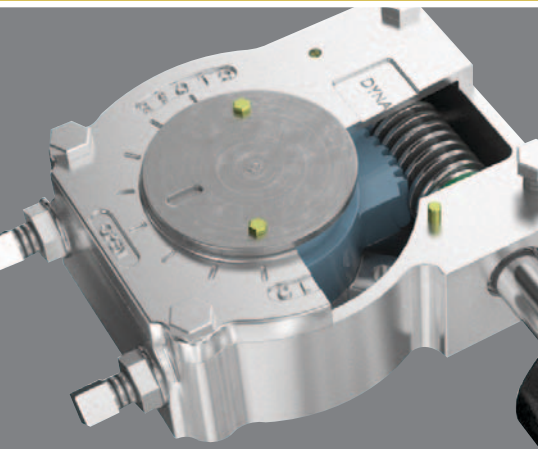
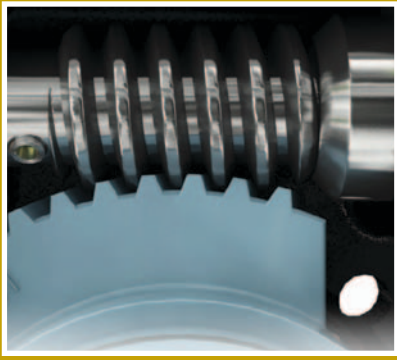

In 2008 Cameron broadened its product line of operators and automated valve accessory products with DYNATORQUE, and today we continue to bring consistent and highly relied upon products to the actuation market. Since 1974, DYNATORQUE® has been one of America's leading manufacturers of gear operators, automated valve manual overrides, accessories and handwheels serving the valve, actuator and damper industries with a product line certified to ISO 9001-2000.

Worm Gear Operators

The DT Series worm gear operators are designed for use with valves and dampers as well as most other applications requiring a self-locking mechanism. Our flexible manufacturing process allows us to offer both standard construction and custom configurations for unique customer applications.

Standard operators are available with various mounting interface dimensions. Custom-machined operators come with bores and bolt holes for direct mounting to the valve. Cameron also offers a varied selection of alternate materials to meet customer application requirements.

For extremely corrosive applications, operators with external components constructed of cast CF-8M stainless steel are available. These operators are completely sealed and are ideal for applications such as brewing, food processing, leaching operations, offshore platforms, and pulp and paper plants. Gear operators with stainless steel internal parts are also available.

Standard Features

- 16 different frame and spur combinations provide output torque from 4500 to 300,000 in-lbs (500 to 33,900 Nm)
- Standard mounting dimensions or configured to customer requirements
- Standard iron housing (DT2 and DT5 are aluminum construction)
- Chainwheel operation available on select frame sizes
- Variable handwheel shaft lengths
- Applications include marine, submerged and high and low temperature
- Available built to AWWA C-504 material and design criteria
- Alternative construction materials for various environments
- Optional models with 180- and 360-degree multi-turn capabilities

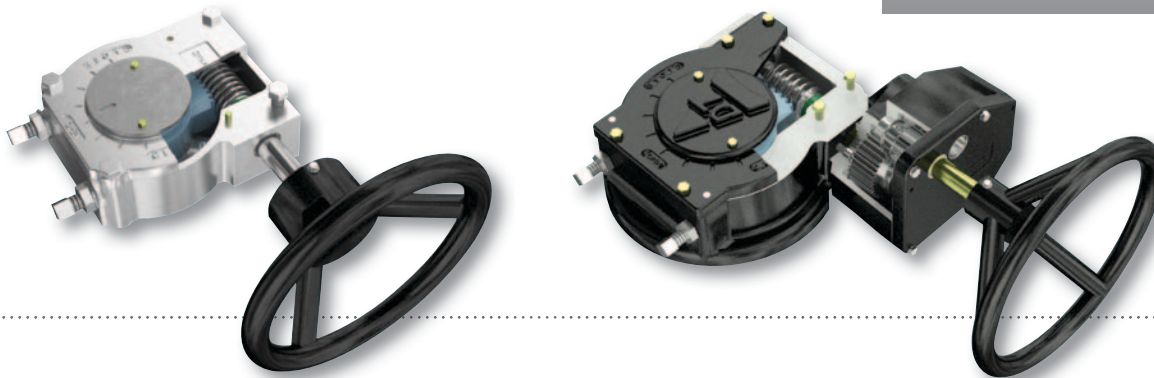

Standard Features

- 20 different frame and spur combinations provide output thrust of 22,000 to 150,000 lbs (98 to 667 kN) and torque output up to 3500 ft-lbs (4745 Nm)
- BG3 and BG6 have standard ISO 5211 mounting patterns (optional patterns on request)
- Gearbox housing of ductile iron
- Investment-cast ductile iron bevel and pinion gears for smooth, continuous transmission of torque
- Optional bronze stem nuts for direct threaded interfacing and lug drivers for existing valve yoke nuts
- Motor mounts available for electric motor operation

Bevel Gear Operators

The BG Series bevel gear operators provide smooth, even torque transmission for thrust and non-thrust applications such as gate, knife gate, pinch, sluice gate or globe valves. This line of operators can also be used in almost any multi-turn, right-angle application requiring mechanical advantage.

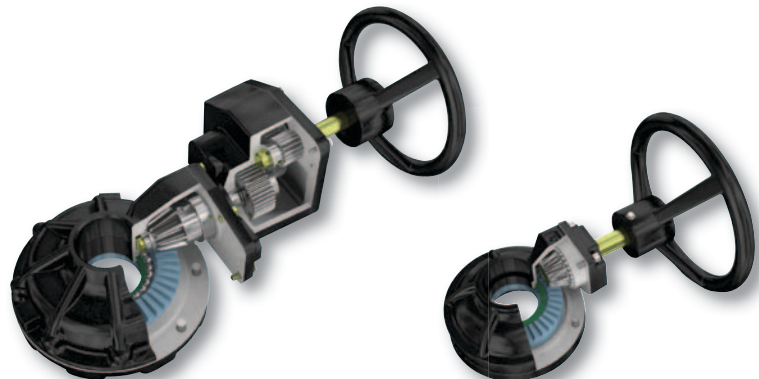

Automated Valve Accessory Products

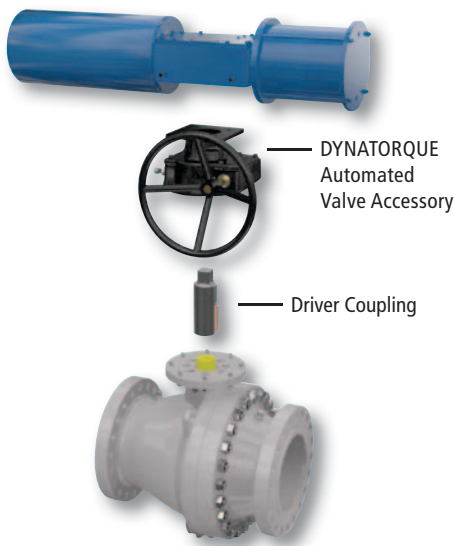

Cameron offers a complete line of unique DYNATORQUE automated valve accessory products – manual overrides, partial stroke test devices and valve locking devices – suitable for use with all styles of quarter-turn automated valve and damper packages. Actuators may be powered by air or hydraulic oil, or be electric operated.

Common to all of these products is the sandwich mounting concept; that is, the device fits between the actuator and the valve. The actuator drives the valve open and closed by means of a driver that connects the actuator to the valve. The device may be provided with ISO 5211 top and bottom-mounting dimensions, standard dimensions, or custom machined to fit customer specified valve and actuator combinations.

Manual Overrides

Manual overrides are used with pneumatic, hydraulic and back-driveable electric actuators. These products are sandwich mounted as part of an automated valve package to provide manual operation of the automated valve in the event of loss of plant air supply, power gas, hydraulic fluid power or electricity.

Standard Features

- Standard ISO 5211 mounting dimensions on top and bottom flanges or custom machined for mounting to actuator and valve
- Device is transparent to valve operation when disengaged

SD Series Standard Features

- Suitable for either double acting or spring return actuators
- 9 different frame and spur combinations provide output torque from 3000 to 140,000 in-lbs (340 to 15,815 Nm)
- Dec clutchable override sandwich mounted between valve and actuator
- One-handed declutch mechanism

SRD Series Standard Features

- Alternative to SD Series for spring return applications only
- 11 different frame and spur combinations provide output torque from 3000 to 260,000 in-lbs (340 to 29,375 Nm)
- Non-declutchable override sandwich mounted between valve and actuator
- Select frame sizes available with chainwheel option for spring return actuators in overhead locations

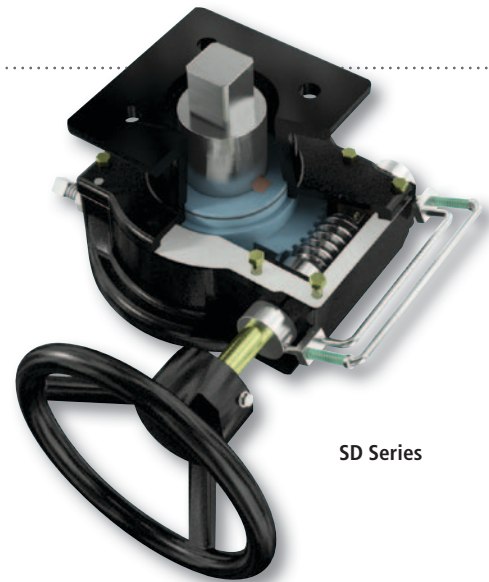

Partial Stroke Test Devices

The D-Stop™ allows for functional safety system testing of critical service valves, such as emergency shutdown valves, while the valves are online and flowing process fluids. The test device detects valve inoperability that may result from control system anomalies such as valve blockage, misalignment of components or mechanical failure of the valve or actuator. Actual ESD control elements (solenoids, positioners, relays, limit switches, etc.) are tested in real time. The device is intended to help users comply with industry standards such as ISA S84 and IEC 61508/61511.

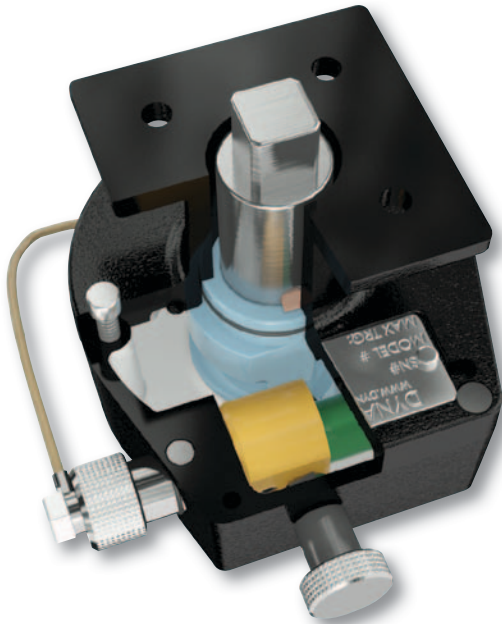

Standard Features

- 10 sizes for automated valves with actuator torque output up to 1,300,000 in-lbs (150,604 Nm)
- Normal operation of the automated valve not affected when disengaged
- Failure rates and PFD_{AVG} determined by Failure Modes, Effects and Diagnostic Analysis (FMEDA), available on request
- SIL capable
- Metal-to-metal safety assures valve cannot travel past set point
- Reduces spurious alarms
- Sandwich mounted between actuator and valve
- Optional limit switch mount for engaged / disengaged indication to control room
- No calibration, software, wiring or commissioning
- Cost effective

Valve Locking Devices

The D-Lock™ is used with automated valves (pneumatic, hydraulic or electric) that require “lock out” capability to prevent valve rotation. This feature is ideal for applications, such as maintenance shutdowns, when the user must be assured the valve remains in a locked position even if an actuator is unintentionally engaged.

Standard Features

- Holds valve in either open or closed position while compensating for hysteresis and machining tolerances (select models provide both open and closed locking)
- Ideal for torque-seated valves such as triple offset butterfly valves
- Applicable for almost any rotating device

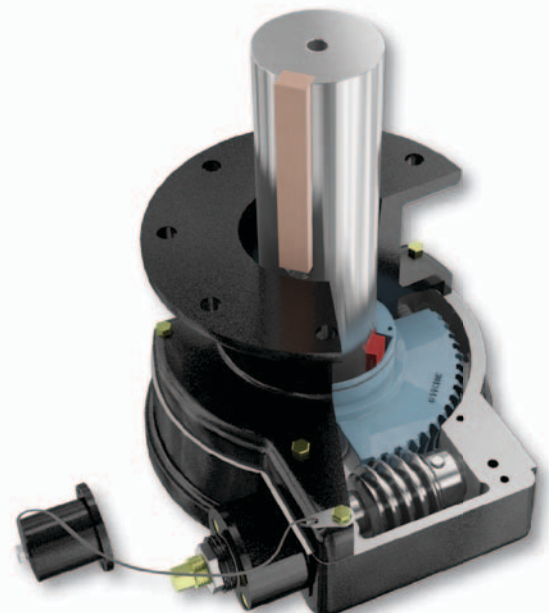

Spur and Miter Gears

Spur and miter gears are used in applications requiring a non-self-locking mechanical advantage or where a change in input drive orientation is required. Both devices can be used as add-on features to our worm and bevel gears or can be purchased as stand-alone products.

Spur Gear Standard Features	Miter Gear Standard Features
<ul style="list-style-type: none"> • Heavy duty, iron and steel components • Used with worm gear and bevel gear operators to allow for reduction in handwheel sizing and handwheel rim pull effort • May be used independent of worm and bevel gears with small non-rising stem gate and globe valves and other non-self-locking applications that require torque multiplication. When used with small electric motor operators, provides a low ratio, non-self-locking torque multiplier 	<ul style="list-style-type: none"> • Heavy duty, iron and steel components • For use as a close-coupled gearbox that changes handwheel input shaft direction on worm and bevel gears • May be used to change shaft direction (90 degrees) on any rotating device with compatible torque values and interface dimensions

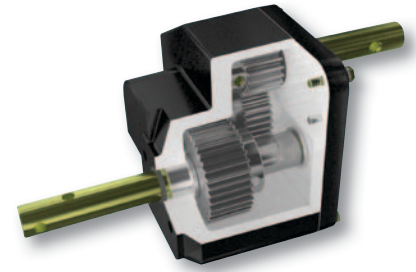

Spur Gear

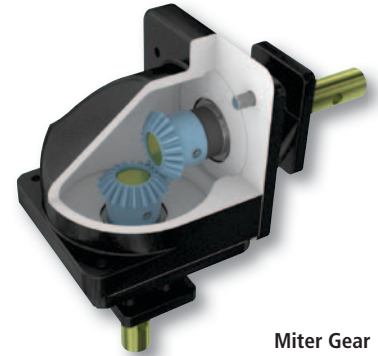

Miter Gear

Handwheels

A complete line of handwheels is offered in diameters of 6" through 48". Standard handwheels are designed for use with our gear operators, and many are available in either recessed or flat versions.



Standard Features

- 6"-10" handwheels are recessed, cast ductile iron
- 12"-48" handwheels are manufactured from tubing and available in standard recessed and optional flat configurations as well as in wvstainless steel
- Tubular handwheels are epoxy powder coated
- Cast handwheels are e-coated
- Optional diameters and interface machining available



Standard Features

- Capable of exceeding 30,000 turns
- Ground-level window indicates valve open or closed in bold red lettering
- Optional limit switches indicate valve position to operator in a remote location
- GPIS offers sealed version
- Optional 2" square operating nuts, extension stems and couplings

Ground Position Indicators

The remote ground position indicators are mechanical devices used to visually indicate the position of a buried or otherwise hidden valve. For example, when a valve and gear are installed in a buried service application, it may be difficult (or impossible) to know if the valve is open or closed.

COMMITMENT TO QUALITY AND DESIGN



For years DYNATORQUE has been recognized as an innovator. Now a part of Cameron, the combined technologies and commitments to quality and design are sure to bring about an even more solid line of products.

Meeting customer needs for customized products is no problem. Our on-site static and dynamic load test benches assure that DYNATORQUE gears will perform in real-world applications, exceeding customer specifications and expectations. The manufacturing process demands attention to quality at every level in order to continually meet customer requirements. Material sourcing is performed to a rigorous set of approval standards, and several pre-production and production process inspections serve to further assure the quality and reliability of our operators. Operators that have been assembled are randomly selected, measured and tested so that the customer's requirements are met. Just saying "ISO Certified" may not assure quality, but our total quality commitment does.

Cameron products have been known for their reliability and durability, and now, with DYNATORQUE, the strength of these technologies will provide customers with an extended level of quality for which there is no substitute.

FLOW CONTROL

2076 Northwoods Drive
Muskegon, Michigan 49442
USA
Tel 231.788.7020
Fax 231.788.7030
sales@dynatorque.com

4903-B W Sam Houston Pkwy N
Houston, Texas 77041
USA
Tel 281.809.1900
Toll Free 1.866.447.2096
24/7 Aftermarket 281.382.2407

Via Gandini 4
27058 Voghera, PV
Italy
Tel 39.0383.343311
Fax 39.0383.62289

DRILLING & PRODUCTION SYSTEMS

PO Box 1212
Houston, Texas 77251-1212
USA

Learn more about
DYNATORQUE at:
www.c-a-m.com

Visit www.dynatorque.com for a
representative or distributor near you.

**HSE Policy Statement**

At Cameron, we are committed ethically, financially and personally
to a working environment where no one gets hurt, nothing gets harmed.