



PDHonline Course E341 (3 PDH)

Design to the Fire Alarm Code, NFPA 72-2010

Instructor: Thomas Mason, P.E.

2012

PDH Online | PDH Center

5272 Meadow Estates Drive
Fairfax, VA 22030-6658
Phone & Fax: 703-988-0088
www.PDHonline.org
www.PDHcenter.com

An Approved Continuing Education Provider

COURSE CONTENT

A fire alarm system has a number of essential components, whether protecting a historic jail in a park, a high-rise apartment building, a school, an office building, a retail business or a factory. Some essential components and fire alarm nomenclature are illustrated below:

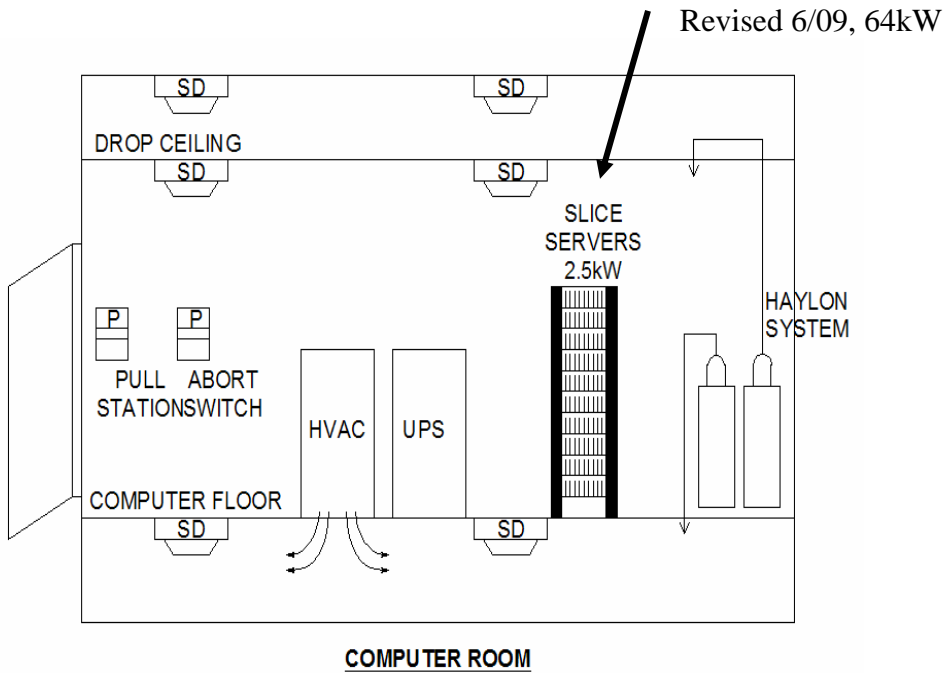
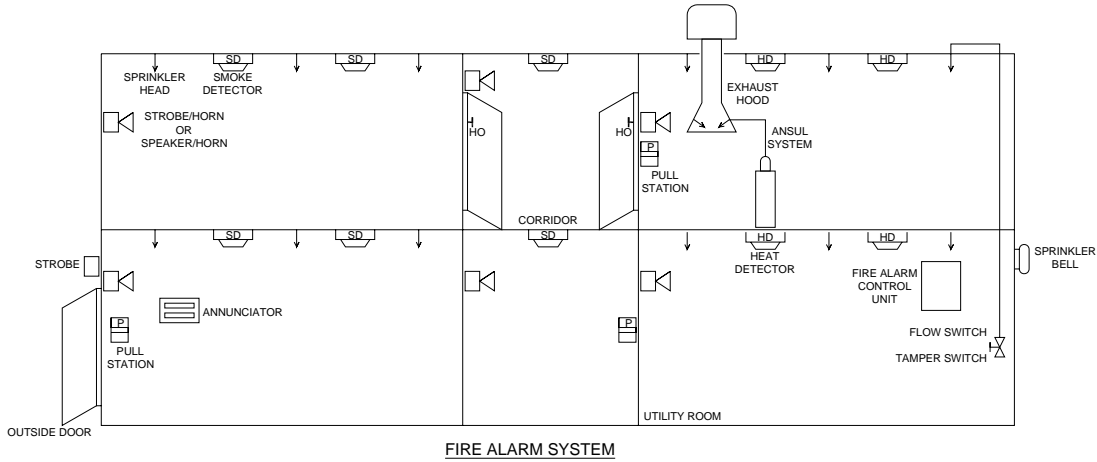

Where:

- Sprinkler head = mechanical device to release a spray of water into the space
- Smoke detector = electrical device to signal the presence of smoke, part of the general group, "initiation devices"

ho = magnetic door hold = electrical device to hold door open; releases upon alarm, usually connected to the group, “supervisory devices”
heat detector = electrical device to signal a high temperature or a rapid rise in temperature, part of the general group, “initiation devices”
pull station = electrical device to permit manual initiation of alarm
abort switch = electrical device to delay discharge of local suppressant
flow switch = electrical device to signal operation of the sprinkler system, part of the group, “initiation devices”
tamper switch = electrical device to signal that the valve is not “full open”, part of the group, “supervisory devices”
strobe/horn = electrical device providing visual and audible indication of alarm, part of the group, “notification devices”
strobe/speaker = electrical device providing visual and audible indication of alarm, part of the group, “notification devices”
fire alarm control unit (formerly, fire alarm control panel) central device and logic for the fire alarm system, usually contains 24-V batteries
annunciator = electrical device for visual report of location of alarm initiation
sprinkler bell = electrical device for audible report of sprinkler operation
outdoor strobe = electrical device for visual report of which building is in alarm
Ansul = brand name (Tyco) of a powder local fire suppression system, usually connected to the group, “supervisory devices”, used mostly for kitchen hoods
Halon = brand name (Tyco) of a gaseous local fire suppression system, usually connected to the group, “supervisory devices”, used mostly for computer rooms
HVAC = mechanical heating, ventilation and air conditioning equipment that must be stopped by the fire alarm in a computer room or other occupancy
UPS = electric power distribution unit for computer equipment which must be stopped by the fire alarm in a computer room
slice server = very high density computer equipment; 19 cards per rack shelf, 4 or more processors per card
mag lock = electric device in the security system, connected to the group, “notification devices”, may be fail-safe or fail-secure
elevator = normal path of egress, usually safely shutdown during alarm by auxiliary relay in the group, “notification devices”
fire pump, city shut-off valve = not shown, sometimes present as part of the sprinkler design, have supervisory connections to the fire alarm system

Building classification and Architect design responsibilities. The illustration above introduces the first consideration in fire alarm design - “Is a fire alarm required?” closely followed by “What type of fire alarm is required?”

The answers come from interpretation of the controlling Building Codes against the present facility and project scope. An Architect is specially trained to make this interpretation. The underlying questions are building construction type, building use and









special circumstances. The fire alarm designer must understand enough to ask the right questions, but the Architect should provide the answers and sign and date the document . In a construction document set there is a lead sheet on the drawing set which summarizes the construction type and use group, but it is often not in the set provided to the electrical designer. A PDHonline course, G10, “National CAD Standard 3.1-07” presents Architect responsibilities in the construction drawing package.









Another key question is occupancy. That is, “How many persons are expected to be in a room?” If the answer is 50 or more, it is a place of assembly and normally requires more devices than an office or work room. The Architect decides.

CAUTION: If a fire alarm is not required by the Building Code, but the Owner chooses to install one anyway, it **MUST COMPLY** with the Fire Alarm Code.

Standard terms, abbreviations and symbols. Terms, abbreviations and symbols are not rigidly defined by NFPA 72, but there are a number which are commonly used and it is essential to include a legend of the abbreviations and symbols used in a design.

The following is a legend sheet from a recent fire alarm project:

SYMBOL	DESCRIPTION
	DISCONNECT SWITCH - HEAVY DUTY - SIZE AND TYPE AS INDICATED ON DRAWINGS. NEMA 3R ENCLOSURE.
	INCANDESCENT WEATHER-PROOF LIGHT FIXTURE DAY BRITE VIS 150-1-12WG
 GFIC	DUPLEX RECEPTACLE - GROUND FAULT CIRCUIT INTERRUPTER HUBBELL GF5262I IN WEATHER-PROOF ENCLOSURE
	SINGLE POLE TOGGLE SWITCH HUBBELL #1221I - 20A. 120-277V. -IN WEATHER-PROOF ENCLOSURE
	FRACTIONAL HORSEPOWER MANUAL STARTER - NEMA TYPE 1 SQUARE D CAT. NO. FG1
	THREE-WAY TOGGLE SWITCH HUBBELL #9643-I 20A. 120V -WITH IVORY COVER PLATE
	PANELBOARD - 225A 240/120V 1 ϕ , 3W, WITH 225A. MAIN CIRCUIT BREAKER SQUARE D NQ0D442L225CU, 22,000 AIC MAIN AND BRANCH BRANCH CIRCUIT BREAKERS
	FIRE ALARM PANEL SIMPLEX 4010 OR APPROVED EQUAL
	IONIZATION SMOKE DETECTOR

	IONIZATION SMOKE DETECTOR SIMPLEX 4098-9717 IN 4098-9789 BASE OR APPROVED EQUAL
	PHOTOELECTRIC DETECTOR SIMPLEX 4098-9714 IN 4098-9789 BASE WITH OR APPROVED EQUAL
	HEAT DETECTOR SIMPLEX 4098-9733 IN 4098-9789 BASE OR APPROVED EQUAL
	MANUAL PULL STATION - ADDRESSABLE TYPE MOUNTED 45" A.F.F. SIMPLEX 4099-9003 IN 2975-9178 SURFACE BOX OR APPROVED EQUAL
	SIMPLEX 4098-9756, 2098-9806 REMOTE LED AND TEST 2098-9806, PAM-SD REMOTE RELAY OR APP. EQUAL DUCT SMOKE DETECTOR - FURNISHED AND INSTALLED BY ELECTRICAL CONTRACTOR
	AUDIBLE VISUAL APPLIANCE MOUNTED 78" A.F.F. SIMPLEX 4903-9424 HORN/STROBE, SYNCHRONIZED, 110 CANDELA, OR APPROVED EQUAL
	VISUAL APPLIANCE MOUNTED 78" A.F.F. SIMPLEX 4904-9310, SYNCHRONIZED, 110 CANDELA, OR APPROVED EQUAL
	#12 CONDUCTORS IN 1/2" CONDUIT WITH GREEN WIRE GROUND. CONCEALED IN WALL OR CEILING
NP-X	NAMEPLATE DESIGNATION SEE DRAWING E-7.
	TELEPHONE OUTLET FLUSH IN WALL WITH IVORY COVER PLATE - 18" A.F.F. 3/4" CONDUIT STUBBED INTO CEILING WITH INSULATED BUSHING

CAVEAT: This sample legend sheet is offered as an example only

This boxed text is a "sidebar." It contains information not directly in line with the content presentation, but important in its own right.

The example symbol legend is a good piece of work from a job which was bid and constructed with no real problems. On the other hand, your author would do it differently.

For instance, the legend contains electric power, lighting and fire alarm equipment and wiring. I like to have a separate fire alarm legend on a fire alarm sheet. Often only the fire alarm sheets are given to the fire alarm subcontractor. If essential information is on a sheet he doesn't get, he will make assumptions or start a string of phone calls which may delay the job.

Second, I don't like to specify manufacturer part numbers on the legend sheet. Simplex makes good fire alarm equipment, but putting Simplex part numbers tends to inhibit competitive vendors. Also, the part numbers must be regularly checked and updated, as some of those shown here are no longer available.

Third, I am very careful NOT to specify fire alarm wiring. It is critical that the wires installed match the equipment installed and be UL approved for the application. The details of the wiring evolve with general evolution of the control unit and field devices. I do emphasize that the fire alarm wiring be in conduit.

The key concepts in choice of fire alarm symbols are uniqueness and recognition. If “V” in a box means fire alarm visual notification device, it must not be used for ceiling speaker volume control. “S” in a box usually means ceiling speaker, so this designer chose “S” in a hex box for ionization smoke detector.

The example is usable, except for the lack of a remote annunciator. The most common reason for rejected fire alarm designs is lack of an annunciator panel at the firefighters’ entrance. A box with the text “ANNC” is sufficient for the plan. Some description (and a Simplex part number for this example) are required for the legend.

This might be a good point to discuss the break in responsibility between the electrical designer and the fire alarm contractor. In almost all cases, the designer is preparing a package for competitive bids. He probably should not be brand-specific. Also, different manufacturers and different models from the line of a single manufacturer use different devices to connect to the remote devices. An addressable system will require an interfacing relay with a multiplexer to connect to an Ansul system. A hardwired system can connect directly to the terminals of the local panel. Your author recommends AGAINST providing detail to the level of wiring, interfacing relays and multiplexers. A general note on the drawing and in the specification should indicate that the provider is responsible for a “complete, operating system, satisfactory to the authority Having Jurisdiction.”

Hard-wired vs addressable digital fire alarm?

One of the objectives of this course is to use standard fire alarm terminology, even when it is at first confusing.

“Hard-wired” means that copper conductors connect the Fire Alarm Control Unit to the initiating devices and other wires connect it to the notification devices. Initiating devices are switches which close and cause signal current to follow. A voltage is applied to the notification device circuit to make the strobes and horns work. This method has been used for 100 years.

“Addressable digital” also uses copper conductors, but uses computer data packets instead of simply the presence of DC voltage to transmit signals. The biggest difference with addressable digital communication is that you can convey much more information than simply IN-ALARM or NOT-IN-ALARM. For instance, remote devices regularly report their operating condition and can report changes in temperature and visual obscuration (smoke) below the alarm threshold. When an initiating device goes into alarm it transmits the location, not just which wiring loop it is connected to.

Riser diagrams. Riser diagrams are a schematic representation of the fire alarm system, identifying the central panel and remote devices. Thirty years ago, each room of the facility was identified along with the devices in that room. Today, the riser is much less detailed, as the example below, used on over 50 schools in different districts:

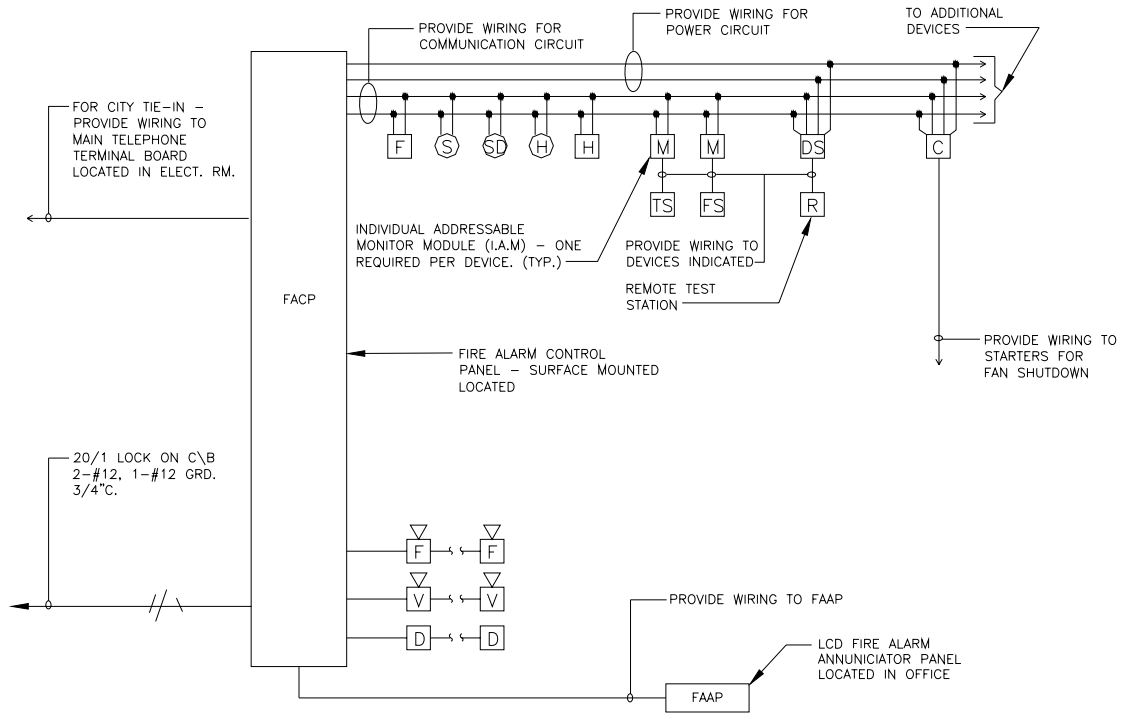

ADDRESSABLE FIRE ALARM SYSTEM TYPICAL RISER

Critics of a good riser diagram.

As indicated, this diagram has been widely used, with few field questions. On the other hand, you author would do things differently.

The initiation device circuit at the top is shown in 4-wire notation. This is correct for fire alarms of a certain period in recent history. It is not correct for current shielded circuits or current NEC wire types.

This representation shows a clear violation of Fire Alarm Code requirements. All initiating devices are shown with “Tee-taps”. In fact, the wire must go down to a device terminal and come up from a different terminal.

Note that only one of each type of device is shown.

The notification circuits at the bottom are shown in 1-line notation. This communicates in a schematic manner rather than a wiring detail. It indicates that audible devices, visual devices and smoke dampers are on individual circuits. I suspect this is not correct and am sure it is within the installer’s scope rather than the designer’s scope.

A fire alarm system for a large facility will usually have remote power supplies that permit extending sensors and notification devices without grossly oversized power

conductors. This is a detail design addition, after the voltage drops have been calculated; it is a responsibility of the installing supplier and contractor.

The riser diagram answers many field questions if done carefully. Show duct detectors if there are duct detectors. Show specialized sensors if they exist. Definitely show connection to independent suppression systems, as kitchen hoods or computer rooms. This avoids claims for a Change Order if the contractor overlooks the device in his bid calculations.

The following is a much more sophisticated fire alarm riser diagram:

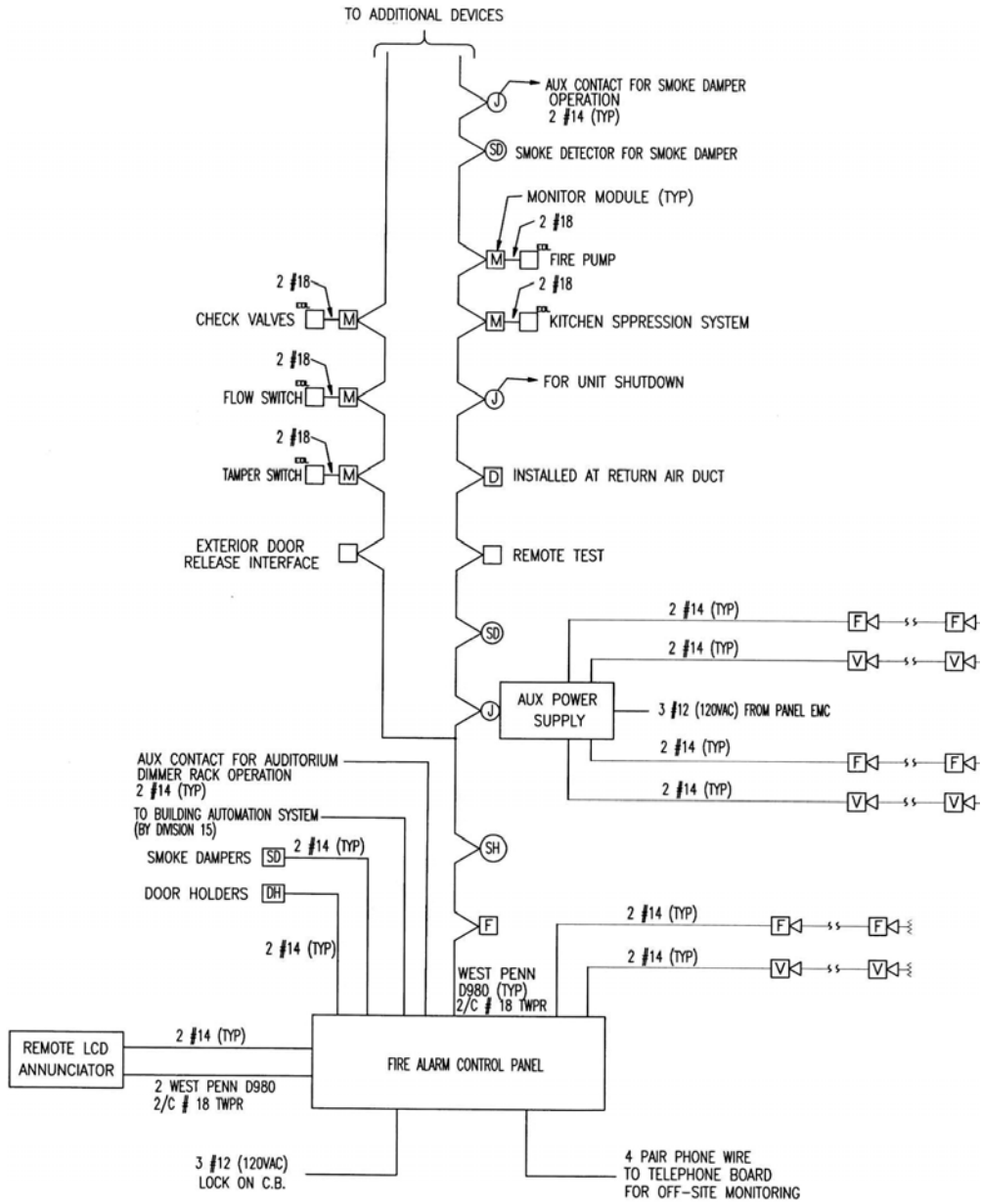

ADDRESSABLE FIRE ALARM SYSTEM DIAGRAM
SCALE: NONE

Your author advises AGAINST this level of detail. Unless the designer is very sophisticated and exactly the system envisioned is installed, there will be discrepancies - which result in field change orders, paperwork costs and bad feelings. Let the contractor do shop drawing for review.

For example, 2#14 conductors are specified to the smoke dampers (square SD). It is totally acceptable to provide a supervised relay from the digital loop and pick up power from the air handling unit. By specifying power from the fire alarm control unit, the dampers will not close when the air handler shuts down. This is usually NOT the desired sequence of operation. In order to close the damper on unit shutdown, a signal will have to be picked up from the air handler and the control sequence programmed in the fire alarm panel.

A better design would be to vaguely indicate the connection between the fire alarm and the smoke damper and task the fire alarm installer with coordination with the HVAC installer. Such coordination is essential to accommodate late design changes and discovered field conditions.

The LCD annunciator is another problem. This was a State funded school job. The State funding agency forbids LCD annunciators (see the discussion on specifications). If the riser just said "remote annunciator" the problem would go away.

Fire Alarm Notes. It is almost mandated that a set of fire alarm notes accompany the construction drawings. Very often, the field people never see the specifications. The notes act as a communication channel to permit the designer to warn the installer of expected problems and good solutions. The notes from the sophisticated job follow:

ADDRESSABLE FIRE ALARM SYSTEM DIAGRAM

SCALE: NONE

- 1.) THE RISER REPRESENTS A TYPICAL SYSTEM AND IS NOT INTENDED FOR INSTALLATION, SYSTEM SUPPLIER SHALL PROVIDE INSTALLATION DRAWINGS AND WIRING DIAGRAMS. EXACT SYSTEM REQUIREMENTS SHALL BE COORDINATED WITH THE SYSTEM SUPPLIER.
- 2.) EACH DUCT TYPE SMOKE DETECTOR REQUIRES A REMOTE TEST STATION, CLEARLY MARKED AND CONVENIENTLY LOCATED WITHIN REACH ABOVE FLOOR. SEE MECHANICAL DRAWINGS FOR LOCATIONS OF DUCT SMOKE DETECTORS PRIOR TO INSTALLATION.
- 3.) THIS DIAGRAM IS NOT INTENDED TO SHOW EXACT QUANTITIES OF DEVICES. REFER TO DRAWINGS FOR DEVICES QUANTITIES AND LOCATIONS.
- 4.) PROVIDE ADDITIONAL ADDRESSABLE MONITOR AND CONTROL MODULES AS RECOMMENDED BY THE SYSTEM SUPPLIER.
- 5.) SEE FIRE PROTECTION SHEETS FOR LOCATIONS OF FLOW SWITCHES AND TAMPER SWITCHES.
- 6.) CONTRACTOR SHALL GET APPROVAL FROM LOCAL AUTHORITY HAVING JURISDICTION AND INCORPORATE ALL REQUIREMENTS OF AUTHORITY HAVING JURISDICTION. ANY REVISIONS REQUIRED SHALL BE DONE BY THE CONTRACTOR WITHOUT ADDITIONAL COST TO OWNER.
- 7.) THE CONTRACTOR SHALL TEMPORARILY KEEP EXISTING HIGH SCHOOL FIRE ALARM SYSTEM RUNNING UNTIL NEW FIRE ALARM IS INSTALLED.
- 8.) THE FIRE ALARM SHALL AUTOMATICALLY BRING THE AUDITORIUM HOUSE LIGHTS TO FULL-ON

The notes for this project are not identified as notes, however, they introduce three important details not found in the later notes examples - duct detector test station, continued operation of the existing fire alarm system and auditorium egress lighting.

The Fire Alarm Code requires remote test stations for duct smoke detectors that are not readily accessible. They are available in many forms, but most contain a test switch and a reset switch. They are part of the duct detector, not part of the fire alarm system. The note calls them out correctly but the riser shows them incorrectly.

Continued operation of the existing fire alarm system is required for occupied spaces and construction spaces. The requirement is usually ignored because wiring is ripped out during demolition and new temporary wiring must be run to provide detectors and pull stations. The temporary wiring must be ripped out when the building is turned over to the Owner. Expensive and expensive again.

The second reason for ignoring the requirement for an operable fire alarm during construction is construction dust. It trips smoke detectors. For small construction jobs, the smoke detectors are “bagged” and taken out of service, though still connected. They are supposed to be replaced by heat detectors.

Auditorium egress lighting triggered by the fire alarm is a relative new requirement. Inspectors are beginning to require it and verify that it is installed. Unfortunately, there are complications which cause it to be disabled shortly after the test.

The concept behind the requirement is that the audience should be able to exit the auditorium when the alarm sounds. During a performance, the auditorium is dark. The emergency lights will not come on because they only respond to power failure. The Fire Alarm Code writers responded by requiring that the house lights come up to full brightness upon receipt of a fire alarm. Unfortunately, most fire alarms occur when there is not a show in progress. The fire alarm doesn't know - all it know is that the house lights must come up to full brightness. After several mis-operations of this type, the fire alarm control is disabled.

All of the auditorium lights? Really?

Well, maybe.

A student in one of my live sessions of this course questioned the requirement. We researched it on the internet, together.

The State of South Carolina interprets that the requirement is met by **SOME** of the house lights coming up and all of the emergency egress lights.

I tried to find the specification for house dimmers on the Strand Lighting site (www.strandlighting.com) without success. Their high-density theatrical dimmers have integral microprocessors, so it is little more than a software addition, but there is no explicit statement and no detailed specification of the features offered. The requirement is stated in the Life Safety Code, NFPA-101 and the national Electric Code, NFPA-70 Section 700-23. It is enforced by the Plans Examiner and Electrical Inspector.

Another sample set of notes follows:

ADDRESSABLE FIRE ALARM SYSTEM TYPICAL RISER

NOTES:

1. THIS RISER REPRESENTS A TYPICAL SYSTEM AND IS NOT INTENDED FOR INSTALLATION. SYSTEM SUPPLIER SHALL PROVIDE INSTALLATION DRAWINGS AND SCHEMATIC WIRING DIAGRAMS. EXACT SYSTEM REQUIREMENTS SHALL BE COORDINATED WITH THE SYSTEM SUPPLIER.
2. SYSTEM SUPPLIER SHALL SUPERVISE INSTALLATION, PROGRAM AND TEST SYSTEM, AND INSTRUCT OWNER ON SYSTEM OPERATION.
3. ALL FIRE ALARM WIRING SHALL BE IN 1/2" CONDUIT. ALL WIRING SHALL BE VERIFIED WITH THE SYSTEM SUPPLIER PRIOR TO BID.
4. PROVIDE ADDITIONAL MONITOR AND CONTROL MODULES AS RECOMMENDED BY THE SYSTEM SUPPLIER.
5. ALL CONTROL CABINETS SHALL BE GROUNDED PER N.E.C. REQUIREMENTS AND SPECIFICATIONS.
6. COORDINATE CITY TIE-IN REQUIREMENTS WITH LOCAL AUTHORITY.
7. REFER TO SPECIFICATIONS SECTION 16721 FOR ADDITIONAL REQUIREMENTS. REFER TO DRAWINGS FOR DEVICE QUANTITY AND LOCATIONS.

There are always questions of style and preference in design. These show up in the notes as well. Note 3 of this example specifies 1/2-in conduit. Many designers feel that concealed conduits should be minimum 3/4-in diameter EMT or RGS. The increased materials cost is not associated with increased labor cost and does provide capacity for

future expansion or accommodation of future technology. The importance of the note is the requirement for conduit; forbidding open wiring (which is much less expensive).

Another preference and style question is the term “conduit”. Contractors and inspectors are beginning to accept flexible non-metallic conduit (Smurf-tube). It has almost no structural strength and the corrugations fight future cable pulls. EMT (thinwall steel tubing) and RGS (heavy wall steel pipe) increase the survivability of the fire alarm installation.

Note 6 references “tie-in”. Your author doesn’t know what is meant. There is a requirement, usually ignored, of providing heat detectors and pull stations during construction. There is another requirement, often ignored, of hiring a 24/7 monitoring facility for every fire alarm system. There is a requirement for approval by the Fire Department or Building Inspector for the system. I don’t know what “tie-in” means.

Keyed notes are usually associated with numbers and a special symbol, as a hex box. Usually, the number in the hex box is on the drawing near something that needs explaining. A list of keyed notes is on the right margin, with each of the explanations.

Keyed notes work very well for busy drawings. However, they add a layer of complication which is avoided by text on the drawing and a leader to the item in question. A problem which arises with notes on the margin is when a job has many sheets or a second sheet is added to a simple job. Do you repeat all keyed notes on the additional pages? If you do not, it makes it hard for the installer who is working in the area not containing the notes on his sheet.

A sample set of kitchen notes is shown below:

NOTES:

1. THE CONTRACTOR SHALL FURNISH, INSTALL, AND WIRE KITCHEN HOOD LIGHT SWITCH, FAN SWITCH, AND WIRING AMONG PANEL, SWITCHES, AND J-BOX ON THE KITCHEN HOOD. COORDINATE WITH KEC.
2. PROVIDE 120V, 20A CIRCUIT FOR FIRE SUPPRESSION PANEL. ALSO, PROVIDE ANNUNCIATION WIRING BETWEEN BUILDING FIRE ALARM PANEL AND THE KITCHEN HOOD FIRE SUPPRESSION PANEL. PROVIDE OCTAGONAL BACK BOX (54" AFF.) WITH 3/4" CONDUIT RUN 6" INSIDE CEILING. FOR EXACT LOCATION & SIZE COORDINATE WITH KEC.
3. PROVIDE BACK BOXES FOR SOLENOID VALVE AND SWITCH. PROVIDE POWER WIRING/CONDUIT FOR DISPOSER FROM PANEL TO THE J-BOX. COORDINATE WITH KITCHEN CONTRACTOR.
4. FURNISH, INSTALL AND CONNECT DISCONNECT SWITCHES FOR ROLL-IN CONVECTION OVEN WITH ASSOCIATED WIRING CONDUIT BETWEEN PANEL AND THE DISCONNECT SWITCHES.
5. ELECTRICAL CONTRACTOR SHALL PROVIDE SHUNT TRIP BREAKERS FOR COOKING EQUIPMENT UNDER THE HOODS AND FOR HOOD LIGHTS.
6. REPLACE EXISTING PANEL "K" AND WITH NEW PANES KP1. RECONNECT EXISTING CIRCUITS FOR EXISTING EQUIPMENT BEING REPLACED OR REMAINED. EXTEND EXISTING BRANCH CIRCUITS AS REQUIRED IN FIELD.
7. * - INDICATES EXISTING ROUGH INS TO REMAIN. ELECTRICAL CONTRACTOR SHALL PROTECT EXISTING DEVICES AND ASSOCIATE CONDUITS, WIRING, DISCONNECTS BACK TO FEEDING PANELS. IF FEEDING PANELS ARE BEING DEMOLISHED, THEN ELECTRICAL CONTRACTOR SHALL EXTEND EXISTING BRANCH CIRCUIT TO NEAREST ELECTRICAL PANEL AS REQUIRED IN FIELD. PROVIDE DISCONNECT SWITCH FOR NEW DISHWASHER

Commercial kitchens require special fire suppression and fire alarm equipment. This is an expectation that a fire will occur under the exhaust hood and possibly ignite condensed grease in the exhaust duct. The general form of suppression is a mechanical system with a fusible link releases a valve and a suppressant powder or gas is released. The normal installation includes a mechanical pull station to be available to release the valve.

The local Fire Marshall has preferences on automatically turning off the lights under the hood, stopping the fan and cutting off gas and electric appliances under the hood.

The fire alarm system does NOT trip the suppression system. The fire alarm system DOES receive the alarm information from the suppression system. It can be programmed for logging and annunciation, a local evacuation or building-wide evacuation, at the preference of the Fire Marshall.

Note 2 in the Kitchen Notes refers to the suppression system telling the fire alarm what is going on. The fire alarm installer must provide a supervised input relay for this purpose. The fire alarm riser should show this connection. It is desirable to have a note directing the fire alarm installer to coordinate with the suppression system installer, and, of course, "any changes or additions required shall be performed with no additional cost to the Owner."

Note 3 refers to a solenoid valve on the fuel gas. This note does not tell the contractor to provide a circuit from the suppression system to the valve and does not identify the power source for the valve.

Note 5 refers to the cut-off of the cooking equipment under the hoods and the hood lights. It would be good to identify the power source and the suppression system as the control.

Sometimes shunt-trip circuit breakers will not fit in a standard power panel. It is the contractor's duty to provide the specified function, but it would be good for the designer to see if an external shunt-trip circuit breaker is required.

Specifications. Specifications for fire alarm systems are more fluid than one might suspect. The first variable is which contractor provides and installs the system. The riser notes, above, refer to Specification 16721. This is in Section 16000, Electrical. However, Specification 13851 contains the same title, headings and contents. It is in Section 13000, Special Construction. [It is important to include only one specification for the fire alarm.] Another PDHonline course, E191, "Electrical Construction Specifications", discusses specifying and the new CSI Division 26 for electrical.

The conventional form for a large construction project is for the electrical contractor to run the conduit and wires and install the bases for the sensors and notification devices. The electrical contractor hires a fire alarm installer to do detailed design, get the permits and provide and install the fire alarm control unit and devices. The fire alarm installer is responsible for witnessed tests and documentation (which is substantial).

On a fire alarm renovation project, it is common to bid the jobs to the fire alarm installers and let them sub out the pipe and wire installation.

The next level of fluidity in fire alarm specifications is the level of detail. It is completely workable and appropriate to specify a fire alarm system in a one-paragraph note on a plan drawing. A sample follows:

CONTRACTOR TO PROVIDE AND INSTALL ADDRESSABLE ANALOG FIRE ALARM SYSTEM, INCLUDING PULL STATIONS, SMOKE DETECTORS, HEAT DETECTORS NOTIFICATION DEVICES, ANNUNCIATOR AT ENTRANCE AND OUTSIDE STROBE AND ALARM BELL. CONTRACTOR TO ARRANGE PERMITS AND INSPECTIONS AND MAKE ANY CHANGES REQUIRED BY AUTHORITY HAVING JURISDICTION - WITHOUT ADDITIONAL COST TO THE OWNER.

Heat detectors are not usually required, so this spec tells the contractor that more than minimal protection is envisioned. If there is no heat detector in the utility room when the designer reviews the submittal drawings, he can justifiably complain that the contractor was informed that heat detectors were required.

The wording “addressable analog” forces the contractor to buy a modern, digital system. The outside strobe and horn are required in some localities and cannot be an extra cost item if this wording is used.

The specific listing of permits, inspections and changes avoids change orders which too often result from a very detailed specification which lacks general language.

For fire alarms, the Authority Having Jurisdiction makes the final decision. The wording above helps get the design through Plans Review at the local Building Standards Department and helps get a good system installed.

A more detailed, but still clear and fairly short specification is included below:

SECTION 16620
FIRE ALARM / DETECTION SYSTEM
PART 1 GENERAL
1.01 **SECTION INCLUDES**
A. Fire alarm system and components
1.02 **QUALITY ASSURANCE**
A. NFPA 70 – National Electrical Code
B. Underwriter’s Laboratory
PART 2 PRODUCTS
2.01 **MATERIALS**
A. Addressable fully electronic.
B. Main fire alarm control panel with remote LED display annunciator.
C. Synchronized strobes.
D. Non-electronic framed plexiglass annunciator with floor plan and room numbers.
PART 3 EXECUTION
3.01 **INSTALLATION**
A. Design and install per NFPA requirements.
B. Wiring to be installed in conduit.
END OF SECTION

This specification comes from the school design guide published by a state funding commission in the Midwest. The elements thought important enough to be included in this short document are interesting. Section 2 references the National Electric Code without mentioning an edition. Different states and communities have adopted different years of issue. I have been told that some townships of some western states do not follow any version of the NEC. It is not clear what this wording contributes. Requiring compliance to the 2005, 2008 or 2011 NEC would be enforceable.

The Section 2 reference to Underwriter’s (sic) Laboratory reference is similarly vague. It is important to have a system of components certified to work together. The wording selected permits sensors and notification devices from one vendor to be connected to a control unit from another vendor. The steady-state characteristics of the remote devices are well defined, but the transient characteristics - switching on and off - are not published. Compatibility can only be determined by test. Notable exceptions are duct smoke detectors and outside weatherproof bells. These components are not made by fire alarm vendors and have a proven record of compatibility.

The Section 2 requirement for an LED graphic annunciator is a repudiation of current technology. Twenty years ago, detectors were connected in a group for several rooms or

one floor. This was electrically a “zone”. Any activated sensor was reported as residing in a particular zone. No further information was available. An alarm for the zone was issued. This matches the idea of an LED being associated with a physical area.

Today, each sensor has a digital address. The fire alarm control panel knows exactly which detector is activated. An alpha display tells, in English, the location of the detector. This is forbidden by the state specification. “Forbidden” is not the correct word. An LED graphic annunciator must be provided and the State will not pay for the alpha display.

The requirement for conduit was discussed earlier with reference to notes for the riser diagram.

Why LED and does the Fire Alarm Code agree?

Your author has a hard time reading LCD graphic alpha displays. It is possible that one or more members of the State commission share this problem. It is not clear what level of acuity is demonstrated by firefighters at an alarm site. It may be that they crane their heads at odd angles to get a clear view with pleasure.

An engraved plexiglass map with LED bulbs to indicate the area where the detector has tripped is unambiguous and very easy to understand. Programmers sometimes use arcane abbreviations and include information not important to the firefighters.

The 2010 Fire Alarm Code is clear on the subject. The fire alarm control unit is supposed to consider initiation devices in terms of zones based upon smoke control zones and evacuation zones. You have seen evacuation maps on the back of motel room doors, next to check-out times. They tell you which way to go to the primary exit and where the secondary exit is located. Schools post these in each classroom and many commercial buildings post similar evacuation maps.

When we discuss voice notification, it will become apparent that initiation zones aid in selective evacuation.

The third level of detail for a fire alarm specification is a call-out of details of construction for each of the components and wiring methods. This 30-page specification is usually provided by a vendor. It specifies proprietary technology and excludes competitors, even if follows by the words, “or equal”.

Perhaps not surprisingly, long, detailed specifications are used on most major construction projects. The bidders ignore the proprietary detail. The designer ignores the proprietary detail in reviewing submissions. The construction manager ignores the proprietary detail. The inspector ignores the proprietary detail. A good system is installed, accepted by the inspector and works reliably for 20-years.

Battery Sizing and Voltage Drop Calculations. The Code requires that battery selection, wire size selection and count of devices per circuit be documented with the permit application. The engineering consultant can do this if a single supplier has been selected and the consultant is intimately familiar with the components. Usually, a generic specification is issued and the successful bidder does the calculations and submits them with the permit application.

Vendors have validated spreadsheets and custom software for the calculations.

How are we sure the spreadsheet does not contain bad formulas and constants?

This question comes up right after you read an article on how bad many spreadsheets are. There is no provision in the Code to validate the computations, but an experienced plans reviewer will perform a reasonableness test, just as he would on manual calculations

In the same vein, we might ask, “Has the software driving this new Fire alarm Control Unit been validated?” Again, the Code does not directly address this question, but it does distinguish between operating system software and site software. System software is considered to be the responsibility of the manufacturer. Site software is considered the responsibility of the installer. A copy of the site software must be provided to the Owner, but phone calls to installers suggest that this is honored in breach more than in compliance.

Authority Having Jurisdiction. A fire alarm system is purchased by the building Owner so that he can get an occupancy permit and move in. The enforcement comes from the Building Standards Department and the Building Inspector. The approval may come from a city official, county official, state official or base commanding officer. Until recently, factories interpreted the plant manager to be the person in charge. Gas electric and communication utilities thought that they had independent authority also.

Today, there is almost always a Building Official (with a license and appointment for this title) who issues the occupancy permit. This person and his staff are the Authority Having Jurisdiction (AHJ). In a locality, there is only one AHJ for fire alarms. There are exceptions, but they are disappearing. Find your local AHJ by asking a fire alarm vendor or electrical contractor.

The significance of the AHJ is that, traditionally, this person can demand changes to meet his preferences. Interpretation of the published Code, adopted by the locality, can be appealed, but construction is delayed and move-in date is delayed and an import agency is alienated.

Pull stations, enclosures and key-operated pull stations. Required pull station locations. The concept behind pull stations is for residents who are fleeing a fire to

notify other residents of the need for evacuation. The first requirement is for pull stations at each exit, with very, very few exceptions.

Owners and Architects often try to avoid extra pull stations. For instance, the Commissioner has a private outside entrance to his office. The Owner will claim that it is not a public exit and does not require a pull station. The designer may note that secretaries in the outer office may be blocked by fire from any exit except through the Commissioner's office. The private entrance has become the main path of egress and certainly should have a pull station to notify the rest of the staff.

A very important topic associated with pull stations is false alarms. Schools now almost universally use clear plastic covers over pull stations. These covers have local battery-operated sounders. Someone who pulls the alarm will set off the sounder and anyone nearby will know exactly where it came from and notice who is running away.

Is it a good idea to require additional effort to operate a pull station?

I posed this question to the Lieutenant in charge of the Fire Prevention Bureau for a large Midwest city. His answer was, "False alarms create an environment where people ignore the alarms. Reducing false alarms increases safety."

Please take this as a recommendation to consult with the local Authority Having Jurisdiction when you have questions.

Another variation of pull station is double-action. A double-action pull requires two conscious efforts to initiate the alarm - as pull down, then out. It was thought earlier that false alarms resulted from inadvertent operation of the pull station. Double-action pulls are still installed, but not emphasized much.

Another solution to false alarms is to remove the pull stations. In very difficult situations, such as public housing, the Authority Having Jurisdiction may authorize removing pull stations if the exit is continuously monitored by security personnel and the rest of the fire alarm system is in full working order. The reasoning is that the guard is paid to watch for people running out the door and will be in a position to request investigation. The guard must have ability to initiate evacuation.

Key-operated pull stations are almost the same thing. The pull station remains, but can be operated only by personnel who have the key.

Your author strongly recommends a pull station at each exit of high fire hazard location, such as kitchens, paint or paper storage and boiler room.

You might ask the question, "How does the kitchen Ansul system interact with the building fire alarm.?" Actually this comes up more often in large computer rooms, with the under-floor and people-space discharge of Halon.

The answer is, “Only slightly.” The building fire alarm system must install detectors and notification devices in the kitchen and computer room, exactly the same as the rest of the building. A local suppression system does not replace the building system. The local suppression system must be installed according to a different set of NFPA documents, but in precise compliance. The suppression system must tell the building system that it has an alarm or has a trouble condition. The building system doesn’t have to tell the local suppression system anything.

A more troublesome aspect is the computer HVAC. NFPA 72 says that we have to shut down the fan and close any fire or smoke dampers. The suppression standards require the same thing. The IT people don’t want to shut down the fans and later restart the computers. What to do?

In fact, the building fire alarm gets built according to plans, with wire for shutting down the fans left near the fan starter. The local suppression system gets built according to plans, with wire for shutting down the fans left near the fan starter. Only a diligent Electrical Inspector or Fire Marshall will get any of the wires hooked up.

In addition to pull stations within 5-ft of each personnel exit, additional pull stations are required so that no location is more than 200-ft from one. This is usually interpreted as meaning that extremely long hallways require a pull station every 200-ft. Doorways over 40-ft wide, as malls or concert halls, require a pull station on each side.

Sensors and supervision of sensors. Required sensor locations. The correct name is initiation devices, which include pull stations, interface relays and smoke and heat detectors.

Smoke detectors are inexpensive and reliable. They work anywhere within their temperature and humidity limits where free of dust and vapors. The temperature limits are (usually) 32-100F and humidity less than 93%. Not for attics or unheated storage spaces. Not for kitchens or locker rooms.

If a design decision or external Code requires smoke detectors, there is a choice of many, many types. On the other hand, one vendor seminar reported that that vendor was ceasing to make anything except photoelectric smoke detectors. They couldn’t find any application where the basic photoelectric wasn’t the best choice. Other sales persons recommend other types of detectors. The Code leaves the decision to the designer and approval by the Authority Having Jurisdiction.

The rule-of-thumb is to space smoke or heat detectors on 30-ft centers. Stay away from walls. Try to get close to high spots. Do NOT place the detector at the peak, which tend to be a dead-space for air flow. There are a number of detailed rules in the later paraphrasing of the Code sections. A detector must be installed over the fire alarm control unit.

Heat detectors are slower than smoke detectors but faster than sprinklers (when selected properly). They are not the first choice except in location with extreme temperatures, dust or vapors.

Heat detectors are available in fixed-temperature, rate-of-rise, combination, and analog forms. The combination fixed-temperature / rate-of-rise heat sensor, is, arguably, the best you can buy. The analog sensors report a numeric heat value to the fire alarm control unit and let the computer decide if fixed-temperature, rate-of-rise, or fire signature rules have been met for an alarm.

All initiation device circuits (smoke, heat, pull, interface relay) must be supervised. Normally, this means that a small amount of electric current flows to the end-of-line resistor at all times. If the line is broken (open) the current is reduced and the trouble light comes on. If the line is shorted (crossed) more current flows and the trouble light comes on. For computerized (smart) digital devices, supervision is handled by similar circuitry, but the result is reported to the fire alarm control unit via an “OK” or “Not-OK” message when polled. (Polling means that the control unit queries one field device, then the next, and so on. The Code has specifications for the required minimum frequency of polling.)

Smoke Control. NFPA 72 requires smoke detectors be installed on medium to large air handlers. The smoke detector must shut down the fan. Until the 2002 revision of the Code, that was all. In 2002, NFPA introduced the Firefighters Smoke Control Panel. It was a fabricated panel, next to the Fire Alarm Control Unit, used to selectively turn fans on and off and swing dampers from open to closed and back. The Firefighters Smoke Control Panel disappeared from the 2007 revision of the Code, but the concept remains. In the 2010 revision, it is “danced around” in section 17.7.5. The wording references other design requirements that may force the HVAC designer to implement advanced smoke control and how additional smoke detectors may be installed to monitor effectiveness of smoke control.

I queried the best HVAC designer I know while writing this. He said that it is totally the prerogative of the Fire Marshal who will be approving the plans. Smoke control is more than a duct detector shutting down the affected system. Exactly what “more” is defined by the local Authority Having Jurisdiction.

More details on things I don't know.

The confusion on smoke control is only a small aspect of a larger problem on what Codes apply. There is a trend for Building Standards Departments, at the State and local levels, to switch from NFPA standards to the International Codes family. When this started, about a decade ago, it didn't mean much. The International Codes were almost word-for-word the same as NFPA.

Recently, however, NFPA has become “activist”. In the 2010 Fire Alarm Code (renamed **National Fire Alarm and Signaling Code**) there are extensive, unenforceable sections

on maintenance and testing. Large, bureaucratic government agencies may take this as an opportunity to expand power, but most of the world is going to ignore it.

Similarly, the 2011 National Electric Code has new sections that replacement of receptacles in homes, offices and factories must include new \$90 AFCI receptacles in locations listed in the 2011 Code. This is *replacement*, not new construction. The AFCI devices are being fought on the State level by the Home Builders' Association.

Similarly, and even further from my personal knowledge, the speaker at the International Association of Electrical Inspectors course on the 2011 NEC revisions stated that the newest NFPA Sprinkler Code requires sprinklers in residences. He said NEC consideration (much less adoption) will be delayed while the Building Standards Department argues residential sprinklers.

In spite of the confusion, there is a clear conclusion. Ask the HVAC designer what he wants for smoke control and put a confirmation memo in the project file.

Duct Smoke Detectors. The goal of fire alarms is to save lives. Most deaths result from smoke inhalation, often toxic fumes released by the heat of the fire. It is critical to NOT distribute smoke and toxic fumes from the fire throughout the building. For this reason, smoke detectors are installed on the return air duct of an HVAC system. The reasoning is that this is the point where smoke from the occupied space will be present. The overriding goal is to shut down the fan. A secondary goal is to announce to the occupants that a problem exists and evacuation is called for.

The HVAC Codes require smoke detectors on the supply side of large air handlers. The reasoning is that the fan motor or belts may burn up and the system will distribute the fumes to the occupied space. Some HVAC designers require smoke detectors on the ductwork leading to exhaust fans. The fire alarm designer must provide an alarm initiation circuit and make sure the test / reset control is provided. The reasoning behind smoke detectors on exhaust is unfathomable.

Indication, test, reset stations

“Are indication, test, reset stations required for concealed duct detectors?”

Yes and no - mostly yes. NFPA 72 is clear that they are required. Careful HVAC designers include them in the specification for factory-supplied air handling units. Field-fabricated air handling units usually ignore them and the Plans Review and Inspection people don't know the difference.

It is recommended that the fire alarm construction documents include a detail on the installation of the duct detector, indication, test reset station and initiating circuit to the fire alarm.

Specialized detectors, such as beam detectors and UV sensors. It takes a lot of photoelectric smoke detectors to protect a warehouse. It may take ten or fewer beam detectors. There is no drawback to the beam-type smoke detectors, except cost and care required for installation.

UV sensors, also, are very good detectors. Almost all commercial boilers use “purple peepers” to verify the flame. For boilers, the alarm takes place when the flickering is not detected. The same principle works well for well defined fire hazards. Ultraviolet radiation is present in the early stages of some fires. UV is not present in other fires and the smoke obscures the UV, as it does visible light. With care, the temperature and humidity limitations of photoelectric detectors can be avoided.

An awkward topic will now be identified, but not addressed: new technology. NFPA 72 specifically accepts new, unproven technology, called, “Performance Based Systems.” There is a discussion of detectors sensitive to chemical vapors produced by specific fires and smoldering heaps. Your author has high confidence in primitive hard-wired systems and addressable systems with smoke detectors, heat detectors, pull stations and strobe / horns. He is very slowly accommodating voice-notification systems. New technology is reserved for persons with high risk-tolerance.

What is the reservation on voice notification systems?

Many don't work well. The design procedure is flawed. The acceptance testing is largely non-existent.

NFPA is just learning the physics and biology of sound. The 2010 edition of NFPA 72 introduces 520-Hz audible alarms for handicap sleeping rooms. This is a good thing a major advance to life-safety systems. Unfortunately, voice-notification does not have the accompanying research and field testing to support the technology.

Intelligibility under panic situations is different than paging or performance sound reinforcement. Paging and performance sound reinforcement frequently don't work and voice notification works even less well. There should be citation here for published reports, but, unfortunately, published reports tend to tout commercial products while ignoring or concealing defects. The conclusion of poor functionality is from personal experience - sitting next to a voice notification speaker during monthly tests. I couldn't understand what they were saying and there was a lot of chatter among workers trying to figure out if this was the monthly “walking down the steps” or the frequent “ignore alarms – the system is being maintained.”

There is hope, however. The 2007 NFPA 72 included an Appendix citing a European intelligibility test and the 2010 NFPA 72 has incorporated intelligibility requirements, 18.4.10 and a voice intelligibility meter is illustrated in the same section in the 2010 NFPA 72 Handbook.

CCTV / Software Smoke and Flame Detection. The 2007 NFPA 72 introduced video smoke detection and showed an example from AxonX, Sparks, MD (axonX.com). The 2010 NFPA 72 shows a different illustration from AxonX but adds requirements that any alarm initiation system must comply with all parts of the Code, including power supply redundancy and cable integrity monitoring and trouble alarms.

The Code emphasizes that CCTV / Software detection is a performance-based system, not a pre-qualified system, like smoke detectors. Full documentation of fire alarm effectiveness must accompany the equipment, for review by the Authority Having Jurisdiction.

Notification devices and supervision Required notification device locations. For many years, it was the “fire bell.” Typically, a pull station closed a switch and electricity was fed to bells in all of the hallways. This worked; it still works, but it is not compliant with current Codes, represented by NFPA 72.

The Fire Alarm Code does not specify what type of notification device must be used. Bells, horns, speakers, strobes and beacons all work well. The strobe / horn combination is exceedingly economic and was the notification device of choice until recently. Some jurisdictions and State funding commissions are requiring voice notification. It is also required in high-rise apartments, condominiums and some commercial buildings. The strobe / speaker combination is now replacing the strobe / horn. An advantage is that the speaker requires less current for the same alarm loudness, so smaller wire can be used. There is no cost penalty for the new technology.

Notification devices circuits must be supervised the same as initiation device circuits. That is, a tiny supervision current and end-of-line resistor may be used for hardware circuits or polling communications may be used for addressable circuits.

Notification devices, strobe / horns, etc, must be located within 15-ft of the end of each corridor and not more than 100-ft apart within a corridor. When two or more strobes are visible from a location, they must be synchronized so that they flash exactly together.

The current rule-of-thumb for strobe / horn locations is at least one in every public space, as lobbies, meeting rooms, work rooms, classrooms, laboratories, storeroom factory area or large restroom. For large spaces, one standard strobe / horn(7-dBA / 15cd) is needed for each 400 sq-ft of floor space, for 27 sq-ft per cd.

Hidden Notification Devices. At least one vendor is offering strobe / horns and strobe / speakers which fit in a box in the ceiling space and drop down when activated. One Fire Marshall stated that he likes them a lot - they are protected from incidental damage and have an excellent operational record in correctional institutions. Your course author is

not recommending these because of 30-years observation of equipment failures and maintenance practices. A mechanical linkage will be painted shut, become inoperable and never be fixed.

Magnetic Door Hold Opens. When the Architect is trying to create a building that meets the needs of the Owner and complies with Building Codes, he is encouraged to break the space into closed, individual compartments. Many construction requirements are relaxed or eliminated if compartments are used. Unfortunately, people move around. Large corridors violate the compartmentalization. A solution is fire doors which are normally open, but close in the event of a fire to create compartments. The device which normally holds the door open is a magnetic door hold open.

Some magnetic door hold opens operate directly off the fire alarm power supply and alarm circuit. Some require a supervised relay and external power. All fail in the door-close condition.

Is it obvious how to apply alarm power to release a magnetic door hold open?
The hold open has a permanent magnet. The fire alarm control unit provides 10 mA at 24VDC to create a magnetic field to cancel the permanent magnet. The spring door-closer operates.

There is a requirement for magnetic door hold opens to be connected to the area smoke detectors on both sides or a dedicated smoke detector on each side. Some jurisdictions require the dedicated detectors. Recently, there was a small controversy about wall-mounted detectors for magnetic door hold opens. The requirement is that they be on both sides of the corridor because smoke flow sometimes stays on one side only. A single ceiling-mounted detector is adequate, again, because of smoke flow dynamics.

Fire Shutters. A fire shutter is the same idea as the magnetic door hold open, except that a motor (or heavy spring) drives the shutter into the closed position and there more to go wrong with the fire shutter.

Magnetic door locks. NFPA 72 reads that magnetic door locks must release with the fire alarm operates. There is considerable controversy in the Owner and Architect community regarding this requirement. A fire alarm system that does not directly go into evacuation alarm is one solution. The special Code sections and interpretations for prisons, hospitals, public housing and museums provide exceptions.

Sprinkler system interface. The supervised flow control valve for a sprinkler system was discussed briefly in the section on zones. There are three parts of the valve monitor for a sprinkler valve - flow, tamper, and trouble. Flow is usually a sail switch in the

sprinkler line. It must operate when a single sprinkler head draws rated flow. It must survive the entire zone of sprinkler heads operating. The output is alarm initiation and normally programmed for building evacuation.

The tamper switch is another life-safety monitor. When the sprinkler system is worked on, the flow valve is shut off. (It is usually locked in the open position, so that it cannot be shut off accidentally.) When the valve is off, the sprinklers are inoperative and the building and occupants are at risk. The tamper switch sends a signal to the fire alarm control unit any time the valve is not at the full-open position. It is usually annunciated as a “trouble”. The reason for the reduced priority is that the valve may be shut off for hours or days. A fire alarm control panel is not permitted to have a continuing initiation condition without going into alarm.

True trouble refers to a malfunction of the circuitry of the remote supervised relay. If the relay is disconnected, it is not know that the sprinkler is out of service, but there is some problem and it must be investigated.

Elevator interface. The elevator interface to the fire alarm system is not really complicated for a single installation. The problem is that there are so many different ways the elevator and associated HVAC system may be designed. Coordination of the fire alarm with the elevator vendor and HVAC designer are essential. And, it is common for the HVAC design to change just before issue of the construction set, so a review is mandatory.

Some general principles are discussed here. Some, but probably not all, will apply to a particular project - elevator lobby smoke detectors, machine room smoke detectors, machine room heat detectors, pit smoke detectors, shaft smoke detectors, safe floor recall, alternate floor recall, fire alarm connection to elevator controls, elevator power shunt-trip circuit breaker, shutdown supervision, powered smoke damper operation, damper position monitoring, car alarm and firefighter service indicator (“Red Hat”).

Before the present level of sophistication, the Elevator Code (ASME A17.1) required dedicated fire alarm systems for the elevator lobbies. In the event of fire, the elevator was forced to return to a safe floor and taken out of public service, but available for firefighters.

At some point in recent history, dual-contact smoke detectors were used for elevator lobbies, so that the building fire alarm system also knew there was a tripped sensor. Evacuation could be selected or some other action. Today, the preferred method is to provide building fire alarm system smoke detectors in the elevator lobbies and have the fire alarm system tell the elevator controls that there is a problem.

Machine room, pit and elevator shaft smoke detectors are required in some installations and forbidden in other installations. Both the Fire Inspector and the Elevator Inspector

must approve the installation, so questions should be directed to them. The safe approach is to specify the sensors and disable them in software if not needed.

Again, the recommendation of this course is to consult with the Architect and Mechanical Engineer about the requirements and show a generic interface between the fire alarm and elevator controls on the fire alarm riser diagram. Direct the fire alarm installer to coordinate with the elevator installer. If confusion remains regarding smoke detectors, heat detectors and a powered shaft louver, include them and find out at final design coordination.

Voice notification and public address interface. Requirements for details of a voice notification system are included in NFPA 72. Requirement for voice notification comes from the local Building Code. Note that different localities (and different inspectors) have different interpretations and may or may not require voice notification.

For new installations, voice notification simply means replacing a horn driver card in the panel with a digital voice card. In addition to strobe power supplies, speaker amplifiers must be included. The speaker / strobes cost about the same as horn / strobes. The fire alarm control unit modules cost about the same, but there are more of them. In a large system, providing a speaker amplifier for each zone may require an additional wall cabinet, further increasing the cost and increasing the space required.

Using the fire alarm speakers for public address is always permitted. The Authority Having Jurisdiction (AHJ) views this connection as improving the reliability of the system, since failures will be noted and repaired. The limitation is that the connection must be in a form that will not diminish the fire alarm function. A fire alarm interface module from the fire alarm vendor is the only correct method.

The 2007 revision of NFPA 72 added biohazard, terrorist, weather and natural disaster notification to permitted use of the fire alarm speakers and placed their priority ABOVE fire alarm notification. The 2010 revision extends this shift with editorial changes removing “fire” from “fire alarm” all through the book. “Mass notification” is a key word in the 2010 Code.

Using the public address speakers for fire alarm notification requires more attention. Fire alarm equipment uses supervised circuitry and primary and secondary power supplies. Local AHJ’s have approved the use of stadium public address as fire alarm notification. Only the AHJ can authorize this.

Stand-alone residential smoke alarms and building evacuation fire alarm interface. Both requirements and interpretation for residential smoke alarms are changing rapidly. You must check with the local Building Standards Department to determine the current needs. A very good system uses 120 VAC power and provides linked detectors /

sounders outside each sleeping room, inside each sleeping room, near the kitchen, in the utility room and in any storage room that might provide fuel for a fire.

Battery powered stand-alone smoke detectors are still adequate for many jurisdictions, but have battery problems and may not rouse a sleeper on the other side of a door. Obviously, they do not notify of a fire in a different part of the dwelling.

Note that NFPA 72 requires that each residential smoke alarm be replaced 10-years after date of manufacture.

Modern high-rise apartments are different from individual homes. The high-rise has a huge amount of concrete separating the floors and the apartments. A fire in one kitchen may do damage there and the smoke may be deadly, but damage and hazard, even to next door neighbors is unlikely.

Kitchen fires are very common and usually controlled without major damage. With this in mind, NFPA 72 permits connection from the main building to the residential fire alarm but forbids connection from the residential to the building.

A single-apartment kitchen fire should not cause evacuation of the building.

The fire alarm control unit and annunciator. There are a few, simple rules for installation of the fire alarm control unit and annunciator. First, put the panel where it will be noticed and available for reset or maintenance. The panel has a yellow light and sounder for trouble. It is important to notice the trouble light and get repairs. The Code requires a dedicated 120V circuit, a lock on the panel breaker, red color on the breaker and a tag, "Fire Alarm Circuit". The panel must have a dedicated ground wire, in addition to the circuit equipment ground. There must be a smoke detector immediately above the fire alarm control unit.

When an evacuation alarm occurs, genuine or false, the system must be silenced and reset. The panel is the correct place survey the operational displays and operate the unit. It is legal for a serviceman to lock out a zone or detector which is delivering false alarm. Any time the control unit itself is out of service, the fire department must be notified and a "fire watch" must be instituted whenever the building is occupied.

Fire watch ?

It is a long-standing requirement that the fire alarm control unit and system must be operational for it to be legal to use a public building. In my hometown, the Fire Department had the municipal school superintendent arrested, along with five high school principals for not notifying the Fire Department of problems and not instituting a fire watch. All were fined. They did not challenge the arrests.

A fire watch means that someone with keys walks around the building every hour and looks for fire or smoke. The required phone call to the fire department helps get this

started properly.

Language of the Code differentiates between intentional “false alarms” and malfunctions, or “nuisance alarms.”

NFPA 72 requires an annunciator at a central location, readily available for firefighters. It is permitted to place the main panel near the door and avoid an annunciator entirely. This is not recommended, for reasons of security, maintenance and aesthetics. Rather, a remote annunciator should be placed at the door used by fire fighters. (Most communities have their fire fighters visit large or important buildings annually to plan where to park their trucks if needed and to be aware of the locations of ordinary and special hazards.) Your course author recommends a second annunciator in the building maintenance or custodial area, where repair persons enter the building or where the staff person is dispatched from to determine if the alarm is genuine or false.

Central Monitoring and Underground Facilities. This course is not addressing central monitoring except to provide a single anecdote. A large Midwestern city undertook a \$15 million security project which included a central monitoring facility. An incidental plan was to eliminate all existing monitoring contracts for fire and security alarm. New CCTV cameras at each location were to be used to permit remote reset of alarms. The facility was built, but the contracts and local reset actions were continued. The city was told that Homeland Security regulations required that central monitoring facilities be underground with access control and magnetic locks on all entrances. Remote reset of fire alarms is explicitly prohibited.

Installation requirements. NFPA 72 has extensive installation requirements. They are not the responsibility of the system designer (see sidebar below). For reasons of liability, the designer must not provide detailed instructions or detailed drawings. Please see the PDH Online courses on professional liability to understand the distinction between design and “means and methods”.

The designer must reference the Fire Alarm Code, the National Electric Code and manufacturer’s instructions for installation requirements. These Codes give detailed information and drawings, Note that the edition of each Code must match that adopted by the locality. They get very testy if you reference a newer Code which has deleted a favorite requirement or interpretation.

The murky field of minimum requirements.

This course advised the fire alarm designer to clearly express design intent. That is the place where you reference the Fire Alarm Code, the National Electric Code, manufacturer’s instructions and the goal of a fully-operational system satisfactory to the local Authority Having jurisdiction.

Beyond these minimum requirements, the designer can require interpretations more strict than the minimums, as detectors in unoccupied spaces and additional pull-stations and additional remote annunciators. It is common for the specification to call for fire-proof cables be run in conduit.

The enforcement of requirements above minimums may not be assumed. In today's tight economy many cost reduction efforts are applauded without regard to life-safety. The installer may suggest revisions down to minimum Code requirements, the construction manager may demand the reduction and a cost credit. Sometime even the Plans Review office returns drawings with markings that features may be eliminated.

The recommendation of this course is to design a system which lets you sleep comfortably at night - including extra protections. Changes after the sealed construction document set will be remembered by history as the responsibility others. [The Kansas City Hyatt hotel collapse is a clear example.

http://en.wikipedia.org/wiki/Hyatt_Regency_walkway_collapse]

Testing requirements. Again, testing is critical to a reliable fire alarm system. This is especially true when the control element is a computer, configured locally to meet the requirements of the Authority Having Jurisdiction. This state, too, comes under the installing contractor's responsibility, not the designer's. The local AHJ must certify the results, not the designer. Make the reference in the specifications and drawing notes.

Knox Box. It is good for the fire fighters to be able to enter the building to determine if a fire exists or simply a false alarm. The almost universal solution is a very substantial small box at the door. The box contains a door key. The box can be opened by a key carried by the fire fighters. The box can have a tamper switch connected to the security or fire alarm, but this is rare. The brand name and common designation is "Knox Box."

Common Errors in Fire Alarm Design. The following is a list of comments by Plans Reviewers. Many jurisdictions use a checklist (which they jealously guard).

- Dedicated panel breaker, red, locked, labeled, "Fire Alarm Circuit".
- Panel ground.
- Smoke detector above panel.
- Missing pull stations within 5-ft of each personnel exit door.
- Missing pull station at each stair entry.

- Missing strobe / horn or strobe / speaker at each exit.
- Missing duct smoke detectors on large air handlers.
- Missing status-test-reset stations on hidden duct smoke detectors.
- No strobe / horn or strobe / speaker in each bathroom.
- No flow switch on sprinkler zones or outside sprinkler bell.

Initiating Devices. A sketch similar to that below is valuable for conceptual understanding of the smoke detector placement rules. The sketch illustrates the expected behavior of an undisturbed fire at the early stages.

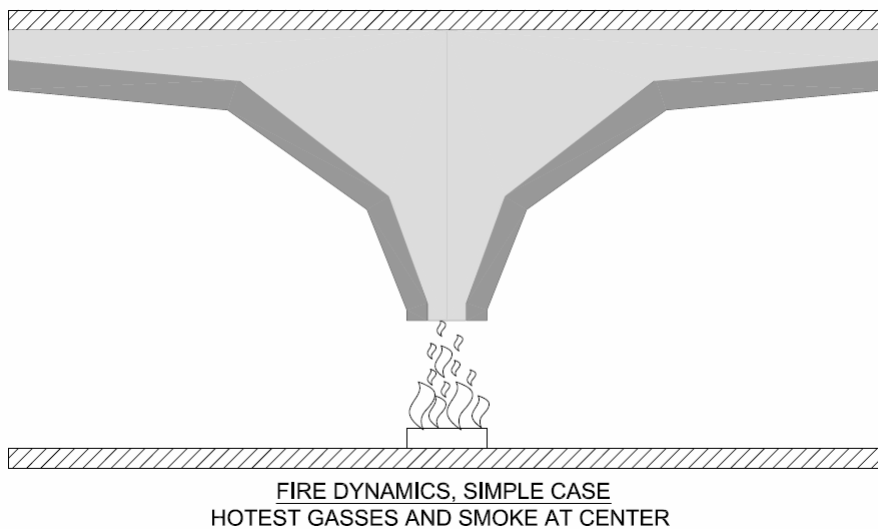

The field of fire science is now sufficiently mature that details of fire mechanics under a wide range of environments and influences can be accurately predicted. This sketch is the most simple representation. It is good for conceptual purposes, but lacks the detail available for analysis of real fires under real conditions.

The narration of the NFPA 72 Handbook makes clear that the Code does not require a fire alarm or particular form of installation. Local law or interpretation require the fire alarm. The Code tries to force a functional, reliable installation after the decision has been made. For years, the Code body has been trying to remove opportunities for local authorities to gut the Code. However, the requirements and enforcement are still local.

Must support initiating devices separately of their connection wires. You won't believe how many smoke detectors are temporarily hanging by their connection wire for years and years. This happens above drop ceilings, where the drop ceiling tiles have been

removed and under raised computer floors. This is not legal, but typically, no enforcement exists after acceptance of the original installation. This is also a violation of the National Electric Code.

Total coverage. All rooms, halls, storage areas, basements, attics, lofts, spaces above suspended ceiling spaces and all accessible spaces, including closets, elevator shafts, enclosed stairways dumbwaiter shafts and chutes must have smoke or heat detectors.

Inaccessible spaces without combustible materials do not require coverage.

Smoke detectors are not required in above-ceiling plenum spaces if duct detectors are used and no flammable materials exist in the above ceiling spaces.

Selective Coverage. If only a portion of the building is protected, then that portion must meet all requirements of the Code. Owners are always asking for “just a little” fire protection. If this is acceptable to the Authority Having Jurisdiction, the area protected must comply with all details of the Code.

Heat-Sensing Fire Detectors. The NFPA 72 Handbook lists different technologies and that the Code accepts new technologies that meet the detailed requirements. It is essential that all devices installed carry UL labels and are installed according to their UL listings - especially regarding environment and any other limitations.

Heat Detector Rated Linear Spacing not greater than 50-ft. A later section says to use 30-ft c-c as normal spacing. This takes care of the natural round pattern of sensitivity and provides a moderate overlap of adjacent detectors.

Ceiling Heat Detectors not within 4-in of wall. Also, wall heat detectors must not be within 4-in of the ceiling.

Solid Joist Construction. Space heat detectors at 50% of the smooth ceiling spacing, that is, 15-ft c-c.

Peaked Ceiling. Do not place detectors within 3-ft of the peak, but not at the peak.

Very High Ceilings. At 20-ft, detector spacing should be reduced from 30-ft to 18-ft. At 30-ft height, detector spacing should be reduced to 10-ft. There is research that the

smoke plume cool so much as it rises that reliable detector operation is not possible above 30-ft. There is considerable attention being paid to open atriums, now popular in commercial buildings and homes.

Smoke Detector Environmental Limits. Most detectors carry limits of temperature 32-100F and humidity below 93% and altitude limits (beware, Denver, CO). Note that you cannot put smoke detectors where exposed to freezing, high temperature, high humidity or substantial air flow.

Smooth Ceiling. Use 30-ft c-c nominal smoke detector spacing.

Air Sampling Smoke Detector. These are complicated, high-cost, high-maintenance systems. They may be the only choice for inaccessible, high-hazard locations. They are well-liked by safety professionals but considered suspicious by persons with field and maintenance experience.

Projected Beam Smoke Detectors. They must be located and installed per manufacturer's instructions, like all other initiation devices. They are very appropriate for large spaces, as warehouses, big-box stores, auditoriums and non-dust factories. They will not false trip easily, but are sensitive to a genuine smoke plume.

Raised Floors and Suspended Ceilings. There are to be treated as separate rooms. In theory, sensors are required only where flammables are present. In fact, there are often requirements for the sensors, even when plenum-rated cables are used.

Keep Smoke Detectors away from HVAC supply or return grills. The air speed will exceed the manufacturer's installation instructions and they won't work.

Detection of Other Suppression Systems. The fire alarm must know about trouble or activation of water, foam, gaseous discharge and other suppressants.

Pull Stations. Pull stations must be installed throughout the protected area so that they are conspicuous, unobstructed and accessible. Often Owners and Architects are offended by the aesthetics of pull stations and notification devices. Concealed (until use) notification devices are acceptable, but pull stations must be visible and prominent. Additional pull stations are required in long hallways, in kitchens and in places where a reasonable likelihood of fire exits.

The NFPA 72 Handbook contains discussion of plastic covers and covers with sounders to reduce false alarms. The general consensus is that these devices materially increase the safety of the installation in vandalism-prone locations.

Sprinkler Flow Switches. These are normally termed, “flow switches” and match this description. In addition, however, pressure switches can be used, alarming on reduced pressure associated with flow. Also pressure switches are required on sprinkler systems with a jockey or booster pump. One pressure switch initiates the pump and another alarms if pressure is not maintained. Fire pumps are closely regulated by a separate NFPA publication and are not addressed here.

Duct Smoke Detectors. Other Codes require duct smoke detectors and specify their locations. NFPA 72 specifies details of construction and installation details. In general the electrical designer conveys the location to the fire alarm detail designer / vendor. Occasionally, retrofit installations or extremely small construction jobs require that the electrical designer take responsibility for choosing the part number of the device and identifying the location on the duct for installation. This is non-trivial. Duct detectors come with different sampling tubes for different duct sizes and there are rules on the distance from the fan to the detector. The detector and status / test / reset station are fairly straight-forward. It is sometimes difficult to get detailed product information, so a call to the local salesman or national customer support office is required. As with other design steps, make a formal call report, identifying the contact number and person, and information obtained and put the report in the project file.

Evacuation is not a required result of alarm operation. Note that this is not an exception to the installation requirements, just an exception to the notification requirements. As always, such an exception requires explicit approval from the Authority Having Jurisdiction.

For instance, evacuation of a prison is often not the first choice, even to the enclosed exercise yard. It is preferable to move residents to an “area of safe refuge.”

Area of Safe Refuge.
This is an extremely important concept in life safety for fire alarms and the newly recognized hazards of toxic spills, terrorism and natural disasters. It has been in the Life Safety Code (NFPA 101) for a long time, but is coming into prominence with the acceptance of Americans with Disabilities Guidelines (ADA and ADAAG).
If Cellblock A reports a fire, the guards can acknowledge the alarm and can move the residents to the Library and Cafeteria. The danger to be recognized is the smoke and toxic fumes released by a fire. The prison design I worked on also included the option of activating the notification devices and releasing the magnetic locks on outside doors. All

prison doors are normally operated electrically, using well protected circuit conductors.

For instance, in hospital intensive care units and convalescent wards, it may be more dangerous to move patients (and their intra venous feeding units and monitoring equipment) than to shut off the fans and keep them in their beds. This is clearly a question for the Authority Having Jurisdiction and the HVAC designer.

For instance, in high-rise apartments, especially senior citizen public housing, evacuation may be impossible. This scenario was examined in the previous section on voice notification. It is common to evacuate the adjacent units; sometimes the floor with the fire and the floor above and the floor below are evacuated. These decisions are made before submission for plans review and request for a Building Permit.

Fire Alarm System Requirements. The following functions can make up a fire alarm system:

1. Pull stations
2. Automatic alarm signal initiation
3. Trouble notification from fire suppression systems
4. Activation of suppression systems (monitor action of stand-alone system)
5. Activation of fire safety functions (initiate elevator recall, fan shutdown)
6. Activation of alarm notification appliances
7. Emergency voice / alarm communications
8. Guard tour supervisory service (logging of key station use)
9. Process monitoring (refrigeration failure)
10. Activation of off-premises signals (beyond central monitoring, as pager)
11. Combination systems (Fire alarm and HVAC control)
12. Integrated systems (Security, building automation, central monitoring and fire alarm)

Notification shall occur within 10-seconds. There are a very few exceptions to this rule, as two-detector confirmation and personnel inhibit. These require written permission from the Authority Having Jurisdiction.

Connecting Two Fire Alarm Systems Together. This is a common need, at times of expansion of the first building or construction of a second building. The preferred method is a new fire alarm control unit with capacity for all initiation, notification and multiplexed relays. This is often possible, due to the expansion capabilities built into the original unit. The physical configuration is an auxiliary cabinet, with additional power supplies, input modules and output modules. The original cabinet handles all controls and annunciation.

A second method is a stand-alone new fire alarm system for the expansion or new building. It can be brought back as a single point on the existing fire alarm control unit. A second annunciator requires only a digital communications cable and can be mounted near the original fire alarm control unit. This new system contains all power supplies, logic, controls, input and output modules. At one time a separate class of expansion fire alarms, containing all components, but intended for use as an extension, was marketed under the name, "Data Gathering Unit." This nomenclature has disappeared from the current edition of NFPA 72.

Active Sensors Required During Construction. An almost universal problem is fire protection during construction. It is commonly ignored, with after-hours fires causing substantial damage. Beyond the cost of installing and maintaining a temporary system, the main reason for avoidance is the presence of dust and vapors. Dust and vapors set off ionization and photoelectric smoke detectors. Any such detectors present in a construction area must be "bagged". Simply disabling them, beyond being illegal, still permits contamination, which will affect operation when re-enabled. Temporary heat detectors are appropriate during construction and are installed by several large, national construction engineering firms.

Drift Compensation of Smoke Detectors. There are two key concepts to be aware of - drift compensation and fire signature recognition. An analog-addressable fire alarm system communicates a numeric value of instantaneous smoke obscuration or temperature to the computer which is the fire alarm control unit. This computer can do more than simply compare the current value with an alarm threshold. First, it can note "drift". Analog sensors do not maintain their accuracy over years of operation. They are recognized to "drift". That is, the normal, safe value changes with no external change. The Code recognizes this characteristic and permits automatic compensation, within a limited range. The second capability is that to recognize sudden changes, though less than the alarm threshold. This is called "fire signature recognition." It was first offered as a proprietary capability from one manufacturer, but is now available from many. It is accepted by NFPA to permit early alarm.

Elevator Recall for Fire Fighter's Service. This concept was introduced earlier but it can be more complex than is immediately apparent. When first introduced by the Elevator Code, the requirement was that the cab return to the ground floor and wait for fire fighters. A few years later, they figured out that the ground floor lobby may be on fire and this simple response would not be good. So, the Elevator Code added a requirement that the elevator controls check for a fire at the primary discharge floor and bypass that for a secondary discharge floor if the primary was involved in the fire. This is, essentially, the present status.

However, the problems of evacuating hospitals and high-rise apartments, along with really huge office buildings, make simple disabling of the elevators less than desirable.

There is work within NFPA to change the Code requirements and fire operation of elevators.

A further problem should be recognized. Large cities tend to have their own fire alarm and elevator codes. They do not closely follow the existing national codes or directions of thinking.

The clear conclusion, as stated earlier, is to consult with the local Fire Marshall and Elevator Inspector and get an agree-upon Sequence of Operation for fire service of the elevators. The electrical and mechanical specifications must direct the installing contractors to coordinate among themselves and with the inspectors - early in the job.

Door Unlocking Devices. The “base case” is exit doors with a panic bar. This is the almost universal non-electronic method used to comply with the Life Safety Code, NFPA 101, requirement for safe egress - while maintaining security. The “modern case” is a magnetic lock with a card-reader and “Push to Exit” button, or, rarely, motion detector for the exit function. Main exits are unlocked during business hours. Secondary and personnel doors are locked during business hours.

NFPA 72 requires that magnetic locks be disabled when a fire alarm evacuation signal is given. This is usually done by an output multiplexer module at the lock. (A signal to the security system would have the same effect, but the security system is not rated life-safety, so this is NOT acceptable.) The connection at each door is commonly done.

Note that NFPA 72 places life safety above property protection. This is contrary to many corporate, executive and managerial priorities. It is not uncommon for a heated discussion to occur between the Fire Marshal and the Architect representing the Owner. I worked a job at an art museum where the Fire Marshal signed off on keeping the personnel doors locked during a fire alarm. He agreed that no one except employees with key cards would be at the exit when an alarm was sounded.

“No one except employees with key cards would be at the exit when an alarm was sounded.”

I worked another job where a research hospital wanted to upgrade their HVAC and electrical system in the labs. They were studying anthrax on rats. My job was to wander among the labs, pop ceiling tiles, and try to trace conduits to and from panels. The supervisor used his key card to let me in, then went back to his work. Many, but not all, of the exit doors had push-to-exit buttons. It was common for me to spend 10-15 minutes trying to find a way to get out.

Audible Notification Loudness. The NFPA 72 requirement is for 15dB above ambient noise level, but not exceeding 120dBA. The standard horn is rated 75dBA. (dB is an incremental measure of sound, as, “This horn is 15dB louder than that one.” dBA is an

absolute measure of sound, as, “A bedroom is about 30dBA; speech is considered 60dBA and a nearby diesel truck is 90dBA.” The Code emphasizes the use of visual notification in loud environments.

Horns in restrooms and hospitals may be rated 45dBA.

Innovations in Audible Notification Devices. The 2007 revision of NFPA 72 introduced a requirement for intelligibility for voice notification. This is a very complex field of research and ancient engineering. In 1940, the US Army knew how to make a radio that communicated voice successfully. In 2010 the fire alarm industry is discovering ways to communicate voice successfully.

Unfair comparison.

The Army radio task involved a fairly well-defined origin and a very well-defined listener (trained operator with earphones). The public voice notification task involves the general public, in a panic state, moving through strange surroundings as they exit, cost constraints on the speakers and placement and a wide range of acoustic interferences.

The good news is that both academic and commercial advances are being made. More are needed.

The 2010 revision of NFPA 72 introduced the use of 520 Hz square wave sounders for ADA sleeping rooms. This is the result of research on sound and human characteristics. The notification devices are commercially available and can be incorporated in a fire alarm design by a single line in the specification or drawing notes, “520Hz notification devices shall be installed in ADA sleeping rooms.”

Location of Visual Notification Devices. A standard strobe is 35cd, but they are available 15-100cd. Normal mounting location is on the wall 80-96 inches above finished floor, but ceiling mount is common in conference rooms, ballrooms, etc. The requirement is 40-ft c-c for 15cd strobes. A strobe must be within 15-ft of the end of a corridor and not more than 100-ft between strobes in a long corridor.

Confusion in NFPA 72. The organization of the Fire Alarm Code scares away engineers. It appears to be written by academic researchers for other researchers. 90% has no relevance to designers or installers and the valuable 10% is hidden. Non-standard language is used and the Table of Contents and Index are really bad. The good news is that the electronic version can be used with key word search to discover the peculiar words used then find the paragraphs where the requirements are concealed.

More good news is that the underlying requirements do not change from revision to revision and the innovations are offered as optional alternatives. Further good news is that major vendors provide materials of extremely high quality and have project and

service departments of great skill. The present incumbents of the Building Standards Department, Inspection and Fire Marshalls are skilled and dedicated to the principles of life-safety.

This concludes the content portion of the course; Close this window to return to the Internet reference links.