



Mercedes-Benz



E-class
Operator's Manual

E 300
E 320
E 420

Product information

Kindly observe the following in your own best interests:

We recommend using Mercedes-Benz original parts as well as conversion parts and accessories explicitly approved by us for your vehicle model.

We have subjected these parts to a special test in which their reliability, safety and their special suitability for Mercedes-Benz vehicles have been determined.

We are unable to make an assessment for other products and therefore cannot be held responsible for them, even if in individual cases an official approval or authorization by governmental or other agencies should exist. Use of such parts and accessories could adversely affect the safety performance or reliability of your vehicle. Please do not use them.

Mercedes-Benz original parts as well as conversion parts and accessories approved by us are available at your Mercedes-Benz authorized dealer where you will receive comprehensive information, also on permissible technical modifications, and where proper installation will be performed.

Printed in the U.S.A.

We reserve the right to modify the technical details of the vehicle as given in the data and illustrations of this Owner's Manual. Reprinting, translation and copying, even of excerpts, is not permitted without our prior authorization in writing.

Press time 09/30/98 MBNA/TI

Operator's manual

Our company and staff congratulate you on the purchase of your new Mercedes-Benz.

Your selection of our product is a demonstration of your trust in our company name. Further, it exemplifies your desire to own an automobile that will be as easy as possible to operate and provide years of service.

Your Mercedes-Benz represents the efforts of many skilled engineers and craftsmen. To ensure your pleasure of ownership, and for your safety and that of your passengers, we ask you to make a small investment of your time:

- Please read this manual carefully before putting it aside. Then return it to your vehicle where it will be handy for your reference.
- Please abide by the recommendations contained in this manual. They are designed to acquaint you with the operation of your Mercedes-Benz.

We extend our best wishes for many miles of safe, pleasurable driving.

Daimler-Benz Aktiengesellschaft

Introduction

This Owner's Manual contains a great deal of useful information. We urge you to read it carefully and familiarize yourself with the vehicle before driving.

For your own safety and longer service life of the vehicle, we urge you to follow the instructions and warnings contained in this manual. Ignoring them could result in damage to the vehicle or personal injury to you or others. Vehicle damage caused by failure to follow instructions is not covered by the Mercedes-Benz Limited Warranty.

Your vehicle may have some or all of the equipment described in this manual. Therefore, you may find explanations for optional equipment not installed in your vehicle. If you have any questions about the operation of any equipment, your authorized Mercedes-Benz dealer will be glad to demonstrate the proper procedures.

Owner's Service and Warranty Information

The Owner's Service and Warranty Information Booklet contains detailed information about the warranties covering your Mercedes-Benz, including:

- New Car Limited Warranty,
- Emission System Warranty,
- Emission Performance Warranty,
- California and Massachusetts Emission Control System Warranty (California and Massachusetts only),
- State Warranty Enforcement Laws (Lemon Laws).

Important Notice for California Retail Buyers of Mercedes-Benz Automobiles

Under California law you may be entitled to a replacement of your vehicle or a refund of the purchase price, if Mercedes-Benz of North America, Inc. or its authorized dealer fails to conform the vehicle to its express warranties after a reasonable number of repair attempts during the period of one year or 12 000 miles from original delivery of the vehicle. A reasonable number of repair attempts is presumed for a retail buyer (1) if the vehicle is out of service by reason of repair of substantial nonconformities for a cumulative total of more than 30 calendar days or (2) the same substantial nonconformity has been subject to repair four or more times **and you have at least once directly notified us in writing of the need to repair the non-conformity and have given us an opportunity to perform the repair ourselves.** Notifications should be sent to the nearest Mercedes-Benz Regional Office listed in the Owner's Service and Warranty Information Booklet.

Maintenance

The Service Booklet describes all the necessary maintenance work which should be performed at regular intervals. Always have the Service Booklet with you when you take the vehicle to your authorized Mercedes-Benz dealer for service. The service advisor will record each service in the booklet for you.

Roadside Assistance

The Mercedes-Benz Roadside Assistance Program provides factory trained technical help in the event of a breakdown. Calls to the toll-free Roadside Assistance number:

1-800-FOR MERCEdes (in the U.S.A.) 1-800-387-0100 (in Canada)

will be answered by Mercedes-Benz Customer Assistance Representatives 24 hours a day, 365 days a year. For additional information refer to the Mercedes-Benz Roadside Assistance Program brochure in your glove box.

Change of Address or Ownership

If you change your address, be sure to send in the "Change of Address Notice" found in the Owner's Service and Warranty Information booklet, or simply call the Mercedes-Benz Customer Assistance Center (in the U.S.A. only) at 1-800-FOR-MERCEdes. It is in your own interest that we can contact you should the need arise.

If you sell your Mercedes, please leave all owner's literature with the vehicle to make it available to the next owner.

If you bought this vehicle used, be sure to send in the "Notice of Purchase of Used Car" found in the Owner's Service and Warranty Information booklet, or call the Mercedes-Benz Customer Assistance Center (in the U.S.A. only) at 1-800-FOR-MERCEdes.

Operating Your Vehicle Outside the U.S.A. or Canada

If you plan to operate your vehicle in foreign countries, please be aware that:

- service facilities or replacement parts may not be readily available,
- unleaded gasoline for vehicles with catalytic converters may not be available; the use of leaded fuels will damage the catalyts,
- gasoline may have a considerably lower octane rating, and improper fuel can cause engine damage.

Certain Mercedes-Benz models are available for delivery in Europe under our European Delivery Program. For details, consult your authorized Mercedes-Benz dealer or write to:

Mercedes-Benz of North America, Inc. European Delivery Department One Mercedes Drive Montvale, NJ 07645

In Canada write to:

Mercedes-Benz Canada, Inc. European Delivery Department 849 Eglinton Avenue East Toronto, Ontario M4G 2L5

We continuously strive to improve our product, and ask for your understanding that we reserve the right to make changes in design and equipment. Therefore, information, illustrations and descriptions in this Owner's Manual might differ from your vehicle. Optional equipment is also described in this manual, including operating instructions wherever necessary. Since they are special-order items, the descriptions and illustrations herein may vary slightly from the actual equipment of your vehicle. If there are any equipment details that are not shown or described in this Owner's Manual, your authorized Mercedes-Benz dealer will be glad to inform you of correct care and operating procedures.

The Owner's Manual and Service Booklet are important documents and should be kept with the vehicle.

The First 1000 Miles (1500 km)

The more cautiously you treat your vehicle during the break-in period, the more satisfied you will be with its performance later on. Therefore, drive your vehicle during the first 1000 miles (1500 km) at moderate vehicle and engine speeds. During this period, avoid heavy loads (full throttle driving) and excessive engine speeds. Avoid accelerating by kickdown. It is not recommended to brake the vehicle by manually shifting to a lower gear. We recommend that you select positions "3", "2" or "1" only at moderate speeds (for hill driving). After 1000 miles (1500 km) speeds may be gradually increased to the permissible maximum.

Check Regularly and Before a Long Trip

See page 148.

Maintenance

Approximately 30 days or 2 000 miles (2 000 km) prior to the next recommended service, the remaining distance or days are displayed in the multifunction indicator. See *Flexible Service System (FSS)* in Index.

We strongly recommend that you have your vehicle serviced by your authorized Mercedes-Benz dealer, in accordance with the Service Booklet.

Failure to have the vehicle maintained in accordance with the Service Booklet may result in vehicle damage not covered by the Mercedes-Benz Limited Warranty.

Radio Transmitters

Warning!

Never operate radio transmitters equipped with a built-in or attached antenna (i.e. without being connected to an external antenna) from inside the vehicle while the engine is running. Doing so could lead to a malfunction of the vehicle's electronic system, possibly resulting in an accident and personal injury.

Radio transmitters, such as a portable telephone or a citizens band unit should only be used inside the vehicle if they are connected to an antenna that is installed on the outside of the vehicle.

Refer to the radio transmitter operation instructions regarding use of an external antenna.

Introduction

[Product information](#)

[Operator's manual](#)

[Consumer Information](#)

[Problems with your vehicle](#)

[Reporting Safety Defects](#)

[Index](#)

Instruments and controls

[Instruments and controls](#)

[Instrument Cluster](#)

[Indicator Lamp Symbols](#)

[Catalytic Converter](#)

[Starting and Turning Off](#)

[Gasoline Engine](#)

[Diesel Engine](#)

[Driving Instructions](#)

Operation

[Automatic Climate Control](#)

[Basic Setting – Automatic Mode](#)

[Defogging Windows](#)

[Defrosting](#)

[Rear Window Defroster](#)

[Air Recirculation](#)

[Activated Charcoal Filter](#)

[Front Center Console](#)

[Compartment Ventilation](#)

[Rear Passenger Compartment](#)

[Adjustable Air Outlet](#)

[Car keys](#)

[Start Lock-out](#)

[Infrared Remote Control](#)

[Central Locking System](#)

[Doors](#)

[Central Locking Switch](#)

[Trunk](#)

[Power Window and Sliding/Pop-Up Roof](#)

[Anti-Theft Alarm System](#)

[Power Seats, Front](#)

[Multicontour Seat](#)

[Heated Seats](#)

[Adjusting Steering Wheel](#)

[Arm Rest, Rear Bench](#)

[First Aid Kit](#)

[Head Restraints, Rear](#)

[Cargo Tie-Down Hooks](#)

[Shelf below Rear Window](#)

[Seat belts and Supplemental Restraint](#)

[_system \(SRS\)](#)

[Seat belts](#)

[Emergency tensioning retractor \(ETR\)](#)

[Airbag](#)

[Child Restraint](#)

[Steering Lock](#)

[Combination Switch](#)

[Split Rear Seat](#)

[Headlamp Cleaning System](#)

[Exterior Lamp Switch](#)

[Night Security Illumination](#)

[Inside Rear View Mirror](#)

[Exterior Rear View Mirror](#)

[Ashtrays](#)

[Lighter](#)

[Sun Visors](#)

[Illuminated Vanity mirrors](#)

[Interior Lighting](#)

[Storage Compartments](#)

[Cup Holder](#)

[Sliding Roof with Rear Pop-Up Feature](#)

[Power Windows](#)

[Trunk Release Switch](#)

[Rear Window Sunshade](#)

[Instrument Lamps](#)

[Display Illumination](#)

[Trip Odometer](#)

[Clock](#)

[Garage Door Opener](#)

[Cellular telephone](#)

Driving

[Drinking and driving](#)

[Parking Brake](#)

55

58

56

57

58

58

59

60

61

61

61

62

63

63

64

65

66

66

67

67

67

67

68

69

72

72

Driving off	72	Traveling Abroad	92	MERCEDES-BENZ Spare Part Service	123
Automatic Transmission	73			Layout of Poly-V-Belt Drive	124
Cruise Control	77	Practical Hints			
Parking Assist (Parktronic)	91			Technical Data. Fuels,	
Multifunction Indicator		Hood	94	Coolants, Lubricants etc.	
Language Selection	79	Checking Coolant Level	95	Consumer Information	
Multiple Malfunctions	79	Adding Coolant	95		
Temporarily Switching off	79	Checking Engine Oil Level	96	Identification Plates	126
Defective	79	Bleeding of Diesel Fuel System	96	Vehicle Data Card	127
Charge Indicator Lamp	79	Automatic Trans. Fluid Level	96	Warranty Coverage	127
Low Engine Oil Level Warning Lamp	80	Trunk Lamp	97	Technical Data	
Engine Oil Consumption	80	Spare Wheel, Vehicle Tools,		E 300 Diesel	128
Fuel Oil Consumption	80	Storage Compartment	97	E 320	130
Tachometer	80	Vehicle Jack	98	E 420	132
Outside Temperature Indicator	81	Wheels	98	Fuels, Coolants, Lubricants etc.	134
Coolant Temperature Gauge	81	Changing Wheels	100	Capacities	134
Low Engine Coolant Level		Tire Inflation Pressure	103	Engine Oils	136
Warning Lamp	82	Exterior Lamps	104	Engine Oils Additives	136
Low Windshield and Headlamp		Battery	109	Air Conditioner Refrigerant	136
Washer Fluid Level Warning Lamp	82	Fuses	111	Brake Fluid	136
Exterior Lamp Failure Indicator Lamp	83	Jump Starting	112	Vehicle with Gasoline Engine	
Brake Pad Wear Indicator Lamp	83	Towing the Vehicle	113	Premium Unleaded	
Brake Warning	83	Cleaning and Care of the Vehicle	115	Gasoline	137
Antilock Brake System (ABS)	84	Testing Infrared Remote Control	119	Fuel Requirements	137
Electronic Traction System (ETS)	85	Front Head Restraint	120	Gasoline Additives	137
Acceleration Stability Program (ASR)	86	Rear Seat Cushion	121	Vehicle with Diesel Engine	
Electronic Stability program (ESP)	88	Emergency Operation of		Diesel Fuels	138
Emission Control	90	Sliding/Pop-Up Roof	121	Coolants	139
On-Board Diagnostic System	90	Replacing Wiper Blades Insert	122	Service and Literature	147
Winter Driving	91	Manual Release of Fuel Filler Flap	123	Check Regularly Before a Long Trip	148
Snow Chains	92	Roof Rack	123		

Instruments and Controls

For more detailed descriptions see *Index*

For adjustment of air outlets, refer to *Automatic Climate Control* (see *Index*).

- | | | | |
|-----------|---|-----------|---|
| 1 | Exterior lamp switch | 14 | Central locking switch Indicator lamp for antitheft alarm system |
| 2 | Parking brake release | 15 | Right front seat heater switch |
| 3 | Parking brake pedal | 16 | Glove box (illuminated with key in steering lock position 1 or 2) |
| 4 | Hood lock release | 17 | Automatic climate control, Rear window defroster switch
Activated charcoal filter switch |
| 5 | Combination switch | 18 | Radio |
| 6 | Cruise control switch | 19 | Storage/eyeglasses compartment |
| 7 | Horn, airbag | 20 | Ashtray with lighter |
| 8 | Instrument cluster | 21 | ASR or ESP control switch |
| 9 | Gasoline engine: Steering lock with ignition/starter switch | 22 | Left power window switch group |
| 9 | Diesel engine: Steering lock with preglow/starter switch | 23 | Right power window switch group |
| 10 | Left front seat heater switch | 24 | Trunk lid release switch |
| 11 | Headlamp washer switch | 25 | Mirror adjustment switch |
| 12 | Switch for rear head restraints | 26 | Switch for rear window sunshade |
| 13 | Hazard warning flasher switch | | |





P54.30-0331-24

Instrument Cluster

- 1** Push buttons for intensity of instrument lamps. See Index
- 2** Push button for resetting trip odometer. See Index
- 3** Coolant temperature gauge. See Index
- 4** Fuel gauge with reserve warning lamp (yellow). See Index
- 5** Left turn signal indicator lamp (green)
- 6** Speedometer
- 7** Right turn signal indicator lamp (green)
- 8** Tachometer. See Index
- 9** Push buttons for setting clock. See Index
- 10** Push button for resetting multifunction indicator. See Index
- 11** Outside temperature indicator. See Index
- 12** Trip odometer. See Index
- 13** Main odometer. See Index
- 14** Clock. See Index
- or
- 11-14** Malfunction indicator

Multifunction Indicator

If a malfunction occurs, the appropriate warning symbol appears, supplemented by a message in the field normally occupied by the displays for outside temperature, odometers, and clock.

In the case of more than one malfunction, symbols and messages are displayed in sequence. Push reset button (R) for subsequent messages.

A warning sounds at the beginning of each message.

Notes:

Refer to *Multifunction Indicator* in the Index for temporarily switching off a Warning Symbol and its message.

Warning message selection is available in the English, French, German, Italian, or Spanish language. See Index.

Indicator Lamp Symbols

Symbols and Warnings in the Multifunction Indicator



Brake pads worn down. See Index



Exterior lamp failure. See Index



Engine oil level low. See Index



Coolant level low. See Index



Battery not being charged properly. See Index



Fluid level for windshield and headlamp washer system low. See Index



Exterior lamps are on. See Index



Take key.
Remove electronic key from steering lock.



Display defective. See *Multifunction Indicator* in Index



See *Multifunction Indicator* in Index
Multifunction indicator for several messages.

Additional Lamp Symbols in the Instrument Cluster, and Warnings in the Multifunction Indicator



Fasten seat belts. See Index.



Brake fluid low (except Canada).



Brake fluid low (Canada only).



Parking brake engaged.



ETS malfunction. See Index



ASR malfunction. See Index



ESP malfunction. See Index



Engine malfunction.
If the lamp comes on when the engine is running, it indicates a malfunction of the O2-sensor on Federal version vehicles, and fuel injection system or emission control system on the California version vehicles. In either case, we recommend that you have the malfunction checked as soon as possible. See Index.

Function Indicator Lamps in the Instrument Cluster



High beam



Preglow (Diesel engine only). See Index



ABS malfunction. See Index



SRS malfunction. See



ASR, ESP or ETS.
Adjust driving to road condition. See Index

Catalytic Converter

Your Mercedes-Benz is equipped with monolithic type catalytic converters, an important element in conjunction with the oxygen sensors to achieve substantial control of the pollutants in the exhaust emissions. Keep your vehicle in proper operating condition by following our recommended maintenance instructions as outlined in your Service Booklet.

Caution!

To prevent damage to the catalytic converters, use only premium unleaded gasoline in this vehicle.

Any noticeable irregularities in engine operation should be repaired promptly. Otherwise, excessive unburned fuel may reach the catalytic converter causing it to overheat, which could start a fire.

Warning!

As with any vehicle, do not idle, park or operate this vehicle in areas where combustible materials such as grass, hay or leaves can come into contact with the hot exhaust system, as these materials could be ignited and cause a vehicle fire.

Starting and Turning Off the Engine

Before Starting

Ensure that parking brake is engaged and that selector lever is in position "P" or "N". Turn electronic key in steering lock to position 2.

Cold Engine

Do not depress accelerator. Turn key in steering lock clockwise to the stop. Release key only when the engine is firing regularly

Hot Engine

Do not depress accelerator. Turn key in steering lock clockwise to the stop. If the engine has not fired after approx. 4 seconds, depress accelerator and continue cranking until the engine is firing regularly. Release key and back off accelerator.

At very high coolant temperatures the engine starting time can be shortened if the accelerator is depressed slowly at the beginning of the starting process.

Turning Off

Turn the electronic key in the steering lock to position 0 to stop the engine.

The electronic key can only be removed with your foot off the brake pedal and the selector lever in position "P".

Important!

Due to the installed starter non-repeat feature, the electronic key must be turned completely to the left before attempting to start the engine again.

In areas where temperatures frequently drop below -4°F (-20°C) we recommend that an engine block heater be installed. Your authorized Mercedes-Benz dealer will advise you on this subject.

Starting and Turning Off Diesel Engine

Before Starting

Engage parking brake and ensure selector lever is in position "P" or "N".
Turn key in steering lock to position 2.

Cold Engine

Turn key to steering lock position 2.
Preglow indicator lamp should come on.
The preglow process starts. When the preglow indicator lamp goes out, the engine is ready for starting.

Do not depress accelerator. Turn key in steering lock clockwise to the stop.
Release key only when the engine is firing regularly.

Do not interrupt the starting process, but limit it to maximum 20 seconds. If the engine is very cold, it is possible that it will fail to start on subsequent attempts.

Hot Engine

Turn key in steering lock clockwise to the stop and start engine immediately without depressing the accelerator.

Turning off

Turn the key in the steering lock to position 0 only when the vehicle has stopped moving.

The key can only be removed with the selector lever in position "P".

Important!

Due to the installed starter non-repeat feature, the key must be turned completely to the left before attempting to start the engine again.

If the preglow indicator lamp fails to light up, or lights up while driving, the preglow system is defective and should be repaired at your authorized Mercedes-Benz dealer at the earliest possible date.

The engine is equipped with a block heater to provide reliable starting at temperatures below 0°F(-18°C). Refer to *Winter Driving* in Index.

Driving Instructions

Warning!

If you feel a sudden significant vibration or ride disturbance, or you suspect that possible damage to your vehicle has occurred, you should turn on the hazard warning flashers, carefully slow down, and drive with caution to an area which is a safe distance from the roadway.

Inspect the tires and under the vehicle for possible damage. If the vehicle or tires appear unsafe, have it towed to the nearest Mercedes-Benz or tire dealer for repairs.

Power Assistance

Warning!

When the engine is not running, the brake and steering systems are without power assistance. Under these circumstances, a much greater effort is necessary to stop or steer the vehicle.

Brakes

Warning!

After driving in heavy rain for some time without applying the brakes or through water deep enough to wet brake components, the first braking action may be somewhat reduced and increased pedal pressure may be necessary. Be sure to maintain a safe distance from vehicles in front.

Resting your foot on the brake pedal will cause excessive and premature wear of the brake pads.

It can also result in the brakes overheating thereby significantly reducing their effectiveness. It may not be possible to stop the vehicle in sufficient time to avoid an accident.

The condition of the parking brake system is checked each time the vehicle is in the shop for the required service.

If the parking brake is released and the brake warning lamp in the instrument cluster stays on, the brake fluid level in the reservoir is too low.

Brake pad wear or a leak in the system may be the reason for low brake fluid in the reservoir.

Have the brake system inspected at an authorized Mercedes-Benz dealer immediately.

All checks and service work on the brake system should be carried out by an authorized Mercedes-Benz dealer.

Install only brake pads and brake fluid recommended by Mercedes-Benz.

Warning!

If other than recommended brake pads are installed, or other than recommended brake fluid is used, the braking properties of the vehicle can be degraded to an extent that safe braking is substantially impaired. This could result in an accident.

Caution!

When driving down long and steep grades, relieve the load on the brakes by shifting into a lower gear to use the engine's braking power. This helps prevent overheating of the brakes and reduces brake pad wear.

After hard braking, it is advisable to drive on for some time, rather than immediately parking, so the air stream will cool down the brakes faster.

Tires

Tread wear indicators (TWI) are required by law. These indicators are located in six places on the tread circumference and become visible at a tread depth of approximately $\frac{1}{16}$ in (1.5 mm), at which point the tire is considered worn and should be replaced.

The tread wear indicator appears as a solid band across the tread.

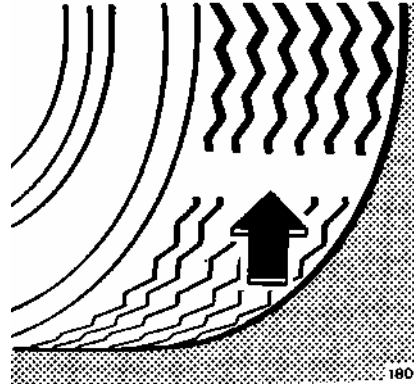

Warning!

Do not allow your tires to wear down too far. As tread depth approaches $\frac{1}{16}$ in (1.5 mm), the adhesion properties on a wet road are sharply reduced.

Depending upon the weather and/or road surface (conditions), the tire traction varies widely.

Specified tire pressures must be maintained. This applies particularly if the tires are subjected to high loads (e.g. high speeds, heavy loads, high ambient temperatures).

Warning!

Do not drive with a flat tire. A flat tire affects the ability to steer or brake the vehicle. You may lose control of the vehicle. Continued driving with a flat tire or driving at high speed with a flat tire will cause excessive heat build-up and possibly a fire.

Aquaplaning

Depending on the depth of the water layer on the road, aquaplaning may occur, even at low speeds and with new tires. Reduce vehicle speed, avoid track grooves in the road and apply brakes cautiously in the rain.

Tire Traction

The safe speed on a wet, snow covered or icy road is always lower than on a dry road.

You should pay particular attention to the condition of the road whenever the outside temperatures are close to the freezing point.

Warning!

If ice has formed on the road, tire traction will be substantially reduced. Under such weather conditions, drive, steer and brake with extreme caution.

We recommend M+S rated radial-ply tires for the winter season for all four wheels to insure normal balanced handling characteristics. On packed snow, they can reduce your stopping distance as compared with summer tires. Stopping distance, however, is still considerably greater than when the road is not snow or ice covered.

Tire Speed Rating

Your vehicle is factory equipped with "H"-rated tires, which have a European speed rating of 130 mph (210 km/h).

Despite the tire rating, local speed limits should be obeyed. Use prudent driving speeds appropriate to prevailing conditions.

Models E 320, E 420: An electronic speed limiter prevents your vehicle from exceeding the speed rating.

Warning!

Even when permitted by law, never operate a vehicle at speeds greater than the maximum speed rating of the tires.

Exceeding the maximum speed for which tires are rated can lead to sudden tire failure causing loss of vehicle control and resulting in personal injury and possible death.

Parking

Warning!

To reduce the risk of personal injury as a result of vehicle movement, before turning off the engine and leaving the vehicle always:

1. **Keep right foot on brake pedal.**
2. **Firmly depress parking brake pedal.**
3. **Move the selector lever to position "P".**
4. **Slowly release brake pedal.**
5. **Turn front wheels towards the road curb.**
6. **Turn the electronic key to steering lock position 0 and remove.**

Important!

It is advisable to set the parking brake whenever parking or leaving the vehicle. In addition, move selector lever to position "P".

When parking on hills, always set the parking brake.

Winter Driving Instructions

The most important rule for slippery or icy roads is to drive sensibly and to avoid abrupt acceleration, braking and steering maneuvers. Do not use the cruise control system under such conditions.

When the vehicle is in danger of skidding, move selector lever to position "N". Try to keep the vehicle under control by corrective steering action.

Road salts and chemicals can adversely affect braking efficiency. Increased pedal force may become necessary to produce the normal brake effect. We therefore recommend depressing the brake pedal periodically when traveling at length on salt-strewn roads. This can bring road salt impaired braking efficiency back to normal. A prerequisite is, however, that this be done without endangering other drivers on the road.

If the vehicle is parked after being driven on salt treated roads, the braking efficiency should be tested as soon as possible after driving is resumed while observing the safety rules in the previous paragraph.

Warning!

If the vehicle becomes stuck in snow, make sure that snow is kept clear of the exhaust pipe and from around the vehicle with engine running. Otherwise, deadly carbon monoxide (CO) gases may enter vehicle interior resulting in unconsciousness and death.

To assure sufficient fresh air ventilation, open a window slightly on the side of the vehicle not facing the wind.

Passenger Compartment



Warning!

Always fasten items being carried as securely as possible.

In an accident, during hard braking or sudden maneuvers, loose items will be thrown around inside the vehicle, and cause injury to vehicle occupants unless the items are securely fastened in the vehicle.

Operation



- 1 Air volume control for center air outlets, turn wheel up to open.
- 2 Air volume control for side air outlet.
To open air outlets: Turn wheel to position .
- 3 To open defroster outlets: Turn wheel to position .
- 4 Center air outlet, adjustable
- 5 Side air outlet, adjustable
- 6 Side defroster outlets
- 7 Display and Controls

The automatic climate control removes considerable moisture from the air during operation in the cooling mode. It is normal for water to drip on the ground through ducts in the underbody.

The desired interior temperature can be selected separately for the left and right side of the passenger compartment.

Automatic Climate Control

The system is always at operational readiness, except when manually switched off.

The automatic climate control only operates with the engine running.

The temperature selector should be left at the desired temperature setting. The temperature selected is reached as quickly as possible.

The system will not heat or cool any quicker by setting a higher or lower temperature.

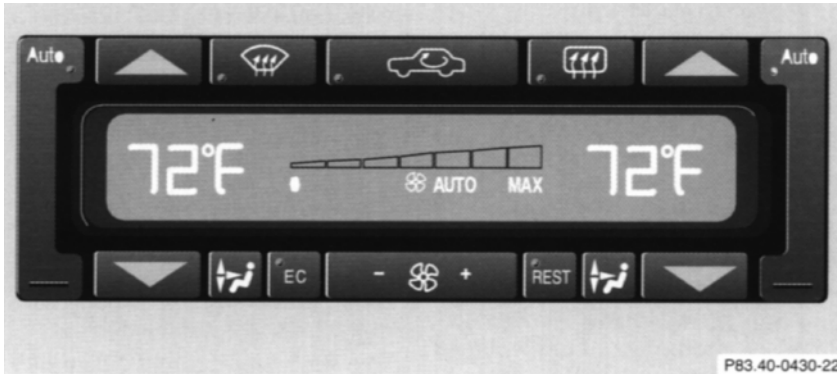

Display and Controls

Press the desired button to activate, indicator lamp is on while activated.

AUTO Automatic mode

▲ Raise temperature

▼ Lower temperature

☀ Defrost

🚗 Air recirculation

🏠 Activated charcoal filter

🚗 Rear window defroster

🚗 Air distribution, manual

EC Economy mode

0 + Air volume, manual

REST Residual engine heat utilization.

Basic Setting - Automatic Mode

Press left and right **AUTO** button for automatic mode.

Simultaneously press both **▲** and **▼** buttons for temperature setting of 72°F.



Air volume and distribution are controlled automatically.

This setting can be used all year around.

Economy

The function of this setting corresponds to the automatic mode. However, because the air conditioning compressor will not engage (fuel savings), it is not possible to air condition in this setting.



Press **EC** button to activate.

Press **EC** button once again to return to previous setting.

Special Settings (use only for short duration)

Defogging Windows

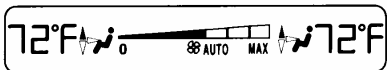

Switch off  button.

Press left and right  buttons.
Press  button repeatedly until air is directed upward.



Turn wheels (2) to position  to open left and right air outlets (5).

Defrosting

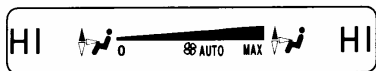

Turn wheels (2) to position  to open left and right air outlets (5).
Adjust air outlets upward. Press  button. Maximum heated and automatically controlled amount of air is directed to the windshield and side windows.



Press  button once again to return to previous setting.

Rear Window Defroster

Turn electronic key in steering lock to position 2.

To select, press  button.
To cancel, press  button again.

Note:

Heavy accumulation of snow and ice should be removed before activating the defroster.

The rear window defroster consumes a large amount of electrical power. To keep the battery drain to a minimum, turn off the defroster as soon as the window is clear.

The defroster is automatically turned off after a maximum of 12 minutes of operation.
If several power consumers are turned on simultaneously, or the battery is only partially charged, it is possible that the defroster will automatically turn itself off. When this happens, the indicator lamp inside the switch starts blinking.

As soon as the battery has sufficient voltage, the defroster automatically turns itself back on.

Air Distribution

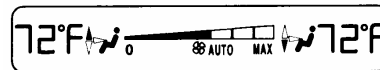

Press  button repeatedly until the requested symbol is displayed.

Air Volume

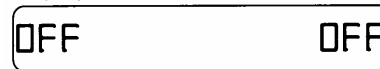

Press - or +side of rocker switch  until the requested blower speed is attained. A choice of 7 blower speeds is available.

To switch the automatic climate control off, press -side of rocker switch  until symbol OFF is displayed.



The fresh air supply to the car interior is shut off.

While driving, use this setting only temporarily, otherwise the windshield could fog up.

To switch the automatic climate control on again, press , , or +side of 

Air Recirculation

This mode can be selected to temporarily reduce the entry of annoying odors or dust into the vehicle's interior. Outside air is not supplied to the car's interior.

To select, press  button.

To cancel, press  button again.

The system will automatically switch from recirculated air to fresh air

- after approx. 5 minutes at outside temperatures below approx. 40°F (5°C),
- after approx. 30 minutes, at outside temperatures above approx. 40°F (5°C),
- after approx. 5 minutes, if button  is pressed.

If the windows should fog up from the inside, switch from recirculated air back to fresh air.

At high outside temperatures, the system automatically engages the recirculated air mode thereby increasing the cooling capacity performance, switching to partially fresh air within 20 minutes.

Dust Filter

Nearly all dust particles and pollen are filtered out before outside air enters the passenger compartment through the air distribution system.

Note:

Do not obstruct the air flow by keeping the air intake grille in front of windshield free of snow and debris.

Also keep the air intake grille in front of windshield free of snow and debris.



Activated Charcoal Filter

To select, press  button.

To cancel, press  button again.

An activated charcoal filter markedly reduces bad odors and removes pollutants from the air entering the passenger compartment.

The blower speed is slightly increased to supply a constant volume of air. The system switches automatically to the air recirculation mode, if the carbon monoxide (CO) or nitric oxide (NO) of the outside air increases.

When pressing button  or , the filter is also switched off.

Notes:

The automatic air recirculation does not function when selecting the Economy mode , or the outside temperature is below 45°F (7°C).

The activated charcoal filter should be switched off when windows fog up on the inside, or if the passenger compartment needs to be quickly heated or cooled down.

Residual Engine Heat Utilization

With the engine switched off, it is possible to continue heating the interior for a short while.

Air volume and distribution are controlled automatically.

To select:

Turn electronic key in steering lock to position 1 or 0 or remove key.

Press **REST** button.

This function selection will not activate if the battery charge level is insufficient.

To cancel: Press **REST** button.

The system will automatically shut off

- if you turn electronic key in steering lock to position 2,
- after approx. 30 minutes,
- if the battery voltage drops.

Front Center Console Compartment Ventilation

The front center console compartment has its own air outlet.

To open: Push lever down.
To close: Push lever up.

The air volume is dependent on the setting of the

- air volume control
- air distribution control
- air outlets in the dashboard and rear passenger compartment.

The air temperature is about the same than that of the dashboard air outlets. It cannot be regulated separately.

Note:

The compartment can get very warm due to its confined space. When storing heat sensitive objects in the compartment, close the air outlet while heating the passenger compartment. Also, do not obstruct the air outlet.



Rear Passenger Compartment Adjustable Air Outlet

To open air outlet, rotate wheel (1) upward.

The air outlet is adjustable.

Important!

This vehicle is equipped with an air conditioner system that uses R-134a (HFC: ozone-friendly hydrofluorocarbon) as a refrigerant. Repairs should always be performed by a qualified technician, and refrigerant should be collected in a recovery system for recycling.

Car Keys

Included with your vehicle are:

- 2 Infrared remote controls with folding master keys,
- 1 Valet key,
- 1 Flat key.

Infrared Remote Control with Folding Master Key

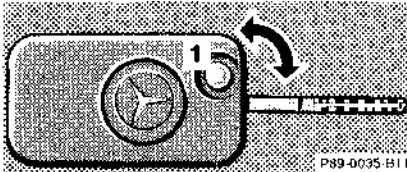

The master key fits all locks on the car.

To release the key, press button (1). The key unfolds from the holder by itself.

The transmitter for the infrared remote control is located in the key holder, the receivers are located on the inside rear view mirror, in the driver's door handle, and next to the trunk lock.

The valet key works only in the front passenger door lock and the steering lock.

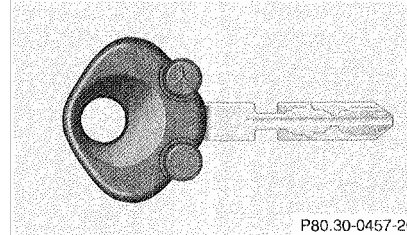

The valet key will not work in the trunk and storage compartments locks.

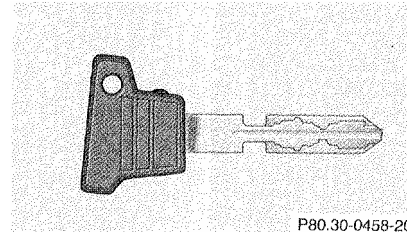

The flat key fits all locks on the car.

Notes:

Do not give the master key to an unauthorized person.

We recommend that you carry the flat key with you and keep it in a safe place (e.g. your wallet) so that it is always handy. Never leave the flat key in the vehicle.

Warning!

When leaving the vehicle always remove the key from the steering lock. Do not leave children unattended in the vehicle. Unsupervised use of vehicle equipment may cause serious personal injury.

Obtaining Replacement Keys

Your vehicle is equipped with a theft deterrent locking system requiring a special key manufacturing process. For security reasons, replacement keys can only be obtained from your authorized Mercedes-Benz dealer.

Starter Lock-Out

Important!

Removing the key from the steering lock activates the start lock-out. The engine cannot be started.

Turning the key in the steering lock to position 2 deactivates the start lock-out.

Infrared Remote Control

The vehicle doors, trunk and fuel filler flap can be centrally locked and unlocked, as well as the windows and sliding roof closed with infrared remote control.

With vehicle centrally locked, the trunk can also be opened by using the infrared remote control. Aim transmitter eye at receiver and press transmit button twice.

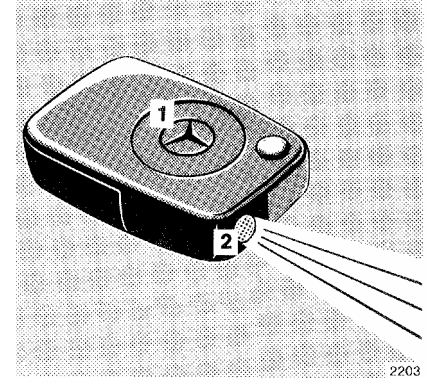

- 1 Transmit button
- 2 Transmitter eye and battery check
- 3 Key release button

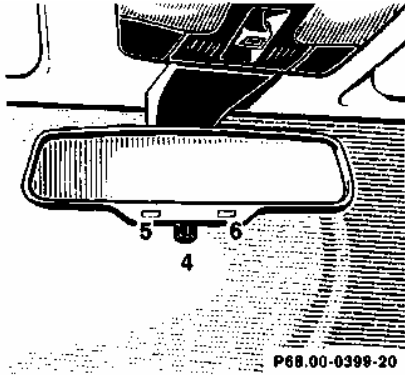

- 4 Receiver on inside rear view mirror
- 5 Red indicator lamp (locking)
- 6 Green indicator lamp (unlocking)

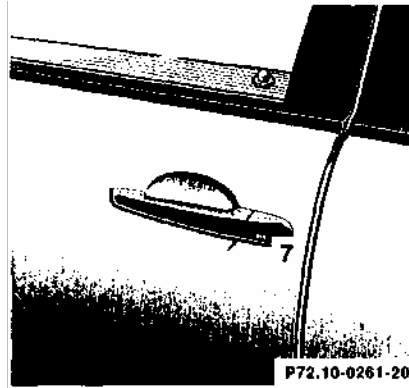

- 7 Receiver, red indicator lamp (locking) and green indicator lamp (unlocking) in driver's door handle.

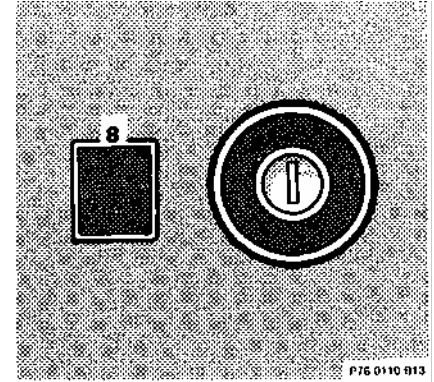

- 8 Receiver, red indicator lamp (locking) and green indicator lamp (unlocking) next to trunk lock.

Locking and Unlocking

Aim transmitter eye (2) at a receiver (4, 7 or 8) and press transmit button.

The red or green indicator lamp on the receiver should blink. It stops blinking when the vehicle is properly locked or unlocked.

Notes:

If the trunk was previously locked separately, it will remain locked (see Index).

If the vehicle cannot be locked or unlocked by pressing the transmit button, then it may be necessary to change the batteries in the transmitter (if ok, battery indicator lamp in transmitter will light briefly when transmitting) or to synchronize the system, see *Remote Control, Infrared* in Index.

Closing Windows and Sliding/ Pop-Up Roof from Outside

Continue to press transmit button after locking car.

The windows and sliding/pop-up roof begin to close after approx. 2 seconds.

Warning!

Never close the windows or sliding/pop-up roof if there is the possibility of anyone being harmed by the closing procedure.

In case the closing procedure causes potential danger, the closing procedure can be immediately reversed by releasing and pressing the remote control button again until the green indicator lamp at the receiver blinks. The sliding/pop-up roof and windows will open again. The sliding/pop-up roof will only open if it was not fully closed.

Note:

If the side windows and sliding/ pop-up roof cannot be closed automatically by pressing the transmit button of the infrared remote control then it may be necessary to change the batteries in the transmitter (if ok, battery indicator lamp in transmitter will light briefly when transmitting), or to synchronize the system, see *Remote Control, Infrared* in Index.

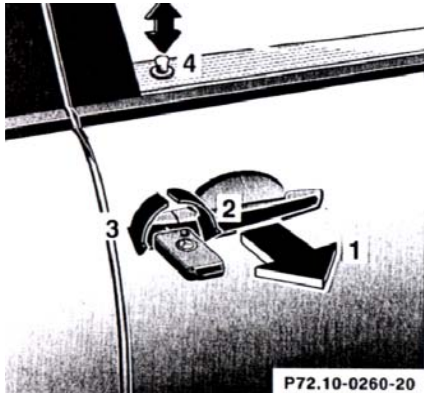

Central Locking System

The entire vehicle may be locked or unlocked by either using the master key in the door or trunk locks, or central locking switch located in center console. The central locking system also locks or unlocks the fuel filler flap.

Note:

If the fuel filler flap cannot be opened, refer to *Fuel Filler Flap, Manual Release* (see Index).

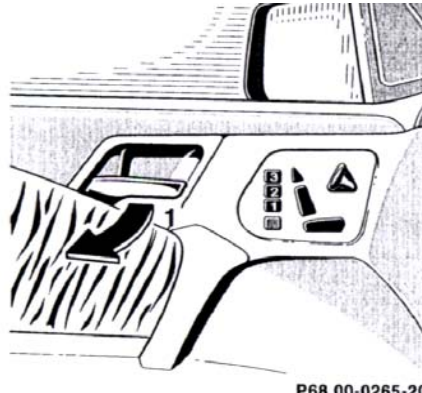

Doors

- 1 Opening - pull handle
- 2 Unlocking
- 3 Locking
- 4 Individual door from inside:
 - Push lock button down to lock.
 - Pull lock button up to unlock.

When you lock the car, all door lock buttons should move down. If any one stays up, the respective door is not properly closed.

You should then unlock the car, open and reclose this door, and lock the car again. Each individual door can be locked with door lock button - the driver's door can only be locked when it is closed.

If the car has previously been locked from the outside, only the door being opened from the inside will unlock, and the alarm will come on. The remaining doors, the trunk lid and fuel filler flap remain locked.



Central locking switch

- 1 Locking
- 2 Unlocking

The central locking switch is located on the center console.

The doors can only be locked with the central locking switch, if the front doors are closed.

The doors cannot be unlocked with the central locking switch, if car was previously locked with the remote control.

If the car has previously been locked with the central locking switch, only the opened door is unlocked.

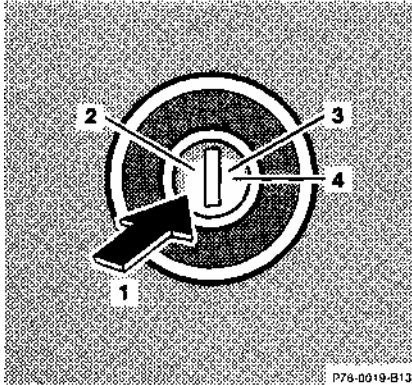

Trunk

- 1 Neutral position - push to open
- 2 Unlocking
- 3 Locking (detent)
- 4 Separate locking of trunk - remove key in this position.

When the trunk is separately locked, it remains locked when unlocking any door.

To deny any unauthorized person access to the trunk, lock it separately. Leave only the valet key with the vehicle.

Notes:

In case of a malfunction in the central locking system the doors and trunk can be locked and unlocked individually.

To lock, turn key to position 3 or push down lock buttons.

To unlock, turn key to position 2 or pull up lock buttons.

If the fuel filler flap cannot be opened, refer to *Fuel Filler Flap, Manual Release* (see Index).

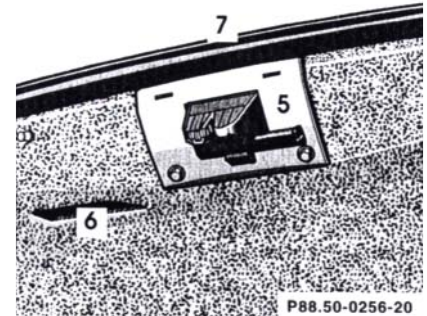

Lower trunk lid using handle (5) or recessed grip (6), and close it with grip molding (7).

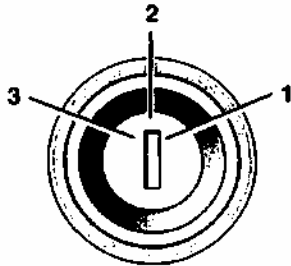

P54.25-0232-20

Power Windows and Sliding/Pop-Up Roof

- 1 Opening
- 2 Interrupting
- 3 Closing

When locking doors or trunk, turn mechanical key in door lock or trunk lock to position 3 and hold. The windows begin to close automatically after approximately 1 second.

To interrupt the closing procedure, turn mechanical key to position 2.

Warning!

Never close the windows or sliding/pop-up roof if there is the possibility of anyone being harmed by the closing procedure.

In case the closing procedure causes potential danger, the closing procedure can be immediately reversed by turning the key to the unlocking position (3) within 10 seconds. The sliding/pop-up roof and windows will open again. The sliding/pop-up roof will only open if it was not fully closed.

Note:

If the closing procedure is interrupted, it can only be continued by first turning the key to the unlocked position (3) and then again to the locking position (1) and hold.



P82.50-0587-20

- 1** Indicator lamp in switch located in center console

Antitheft Alarm System

The antitheft alarm is automatically armed or disarmed with the remote control or any of your vehicle's mechanical keys by locking or unlocking the driver's door or the trunk.

A blinking lamp (1) indicates that the alarm is armed.

The antitheft alarm is disarmed when unlocking the front passenger door or the trunk with any of your vehicle's keys or infrared remote control

Operation:

Once the alarm system has been armed, the exterior vehicle lamps will flash and an alarm will sound when someone:

- opens a door,
- opens the trunk,
- opens the hood,
- switches on or bridges the ignition circuit,
- steps on the brake pedal.

The alarm will last approximately 2¹/₂ minutes in the form of flashing exterior lamps. At the same time an alarm will sound for 30 seconds. The alarm will stay on even if the activating element (a door, for example) is immediately closed.

Note:

We recommend that you carry the electronic reserve key plus mechanical key with you and keep it in a safe place (e.g. your wallet) so that it is always handy. Never leave the electronic reserve key in the vehicle.

Power Seats, Front

Warning!

Do not adjust the driver's seat while driving. Adjusting the seat while driving could cause the driver to lose control of the vehicle.

Never ride in a moving vehicle with the backrest reclined. Sitting in an excessively reclined position can be dangerous. You could slide under the seat belt in a collision. If you slide under it, the belt would apply force at the abdomen or neck. That could cause serious or even fatal injuries. The backrest and seat belt provide the best restraint when the wearer is in an upright position and the belt is properly positioned on the body.

Never place hands under seat or near any moving parts while a seat is being adjusted.



The slide switches are located in each front door.

Warning!

When leaving the vehicle always remove the electronic key from the steering lock.

The power seats can also be operated with the driver's or passenger door open. Do not leave children unattended in the vehicle or with access to an unlocked vehicle. Unsupervised use of vehicle equipment may cause serious personal injury.

Turn electronic key in steering lock to position 1 or 2 (with the driver's or passenger's door open, the power seats can also be operated with the electronic key removed or in steering lock position 0).

- 1 Seat, up/down
- 2 Seat, fore/aft
- 3 Seat cushion tilt
- 4 Backrest tilt
- 5 Head restraint

During seat adjustment, the head restraint is automatically adjusted to support the back of the head approximately at ear level.

The head restraint angle can also be adjusted manually.

Note:

Your vehicle is equipped with power head restraints, do not try to raise or lower them manually.

Synchronizing Head Restraints

If the power supply was interrupted (battery disconnected or empty), the power seats and head restraints are no longer adjusted automatically.

To resynchronize the adjustment feature, move the seat completely forward and the head restraint fully down.

Caution!

Do not remove head restraints except when mounting seat covers. For removal refer to *Head Restraints, Front*, see Index. Whenever restraints have been removed be sure to reinstall them before driving.



P54.00-0221-20

Memory Storing and Recalling

- 6 Memory button
- 7 Position buttons

Storing

Three sets of seat/head restraint and exterior rear view mirror positions may be programmed into memory. After the seat/head restraint and exterior rear view mirrors are positioned, push memory button (6), release, and within 3 seconds push position button "1". A second and third set of positions for the same seat/head restraint and exterior

rear view mirrors can be programmed into memory by pushing first memory button (6) and then "2", respectively "3".

Note:

See Index for instructions on adjustment of mirrors.

Recalling

To recall a seat/head restraint and exterior rear view mirror position, push and hold position button "1", "2" or "3" until seat/head restraint and exterior rear view mirror movement has stopped. The seat/head restraint and exterior rear view mirror movement stops when the position button is released.

Important!

Prior to operating the vehicle, the driver should adjust the seat height for proper vision as well as fore/aft placement and seat back angle to insure adequate control, reach, operation, and comfort. The head restraint should also be adjusted for proper height. See also airbag section for proper seat positioning.

head restraint should also be adjusted for proper height.

Both the inside and outside rear view mirrors should be adjusted for adequate rearward vision.

Fasten seat belts. Infants and small children should be seated in a properly secured restraint system that complies with U.S. Federal Motor Vehicle Safety Standard 213 and Canadian Motor Vehicle Safety Standard 213.

All seat, head restraint, steering wheel, and rear view mirror adjustments as well as fastening of seat belts should be done before the vehicle is put into motion.



Multicontour Seat (optional)

- 1** Seat cushion depth
- 2** Backrest bottom
- 3** Backrest center
- 4** Side bolster adjustment

Some models may be equipped with multicontour seats. These seats have movable seat cushions, and inflatable air cushions built into the backrest to provide additional lumbar and side support.

The seat cushion movement and amount of backrest cushion height and curvature can be continuously varied with regulators (1, 2 and 3) after turning the electronic key in steering lock to position 2.

The side bolsters of the backrest can be adjusted with rocker switch (4):

- press down forward end - increase side support,
- press down rearward end - decrease side support.

If the engine is turned off, the last cushion setting is retained in memory, and automatically adjusts the cushion to this setting when the engine is restarted.



The front seat heater switches are located in the center console.

Heated Seats (optional)

The front seat heaters can be switched on with the electronic key in steering lock positions 1 or 2.

Press switch to turn on seat heater:

- 1** Normal seat heating mode. One indicator lamp in the switch light up.
- 2** Rapid seat heating mode. Both indicator lamps in the switch light up.
After approximately 5 minutes in the rapid seat heating mode, the seat heater automatically switches to normal operation and only one indicator lamp will stay on.

Turning off seat heater:

If one indicator lamp is on, press upper half of switch.

If both indicator lamps are on, press lower half of switch.

If left on, the seat heater automatically turns off after approximately 30 minutes of operation.

Note:

When in operation, the seat heater consumes a large amount of electrical power. It is not advisable to use the seat heater longer than necessary.

The seat heaters may automatically switch off if too many power consumers are switched on at the same time, or if the battery charge is low. When this occurs, the indicator lamp in the switch will blink (both indicator lamps blink during rapid seat heating mode). The seat heaters will switch on again automatically as soon as sufficient voltage is available.

If the blinking of the indicator lamps is distracting to you, the seat heaters can be switched off.



Adjustable Steering Wheel

Turn electronic key in steering lock to position 1 or 2 (with the driver's or front passenger's door open, the steering wheel can also be operated with the electronic key removed or in steering lock position 0).

To lengthen or shorten the steering column, push switch forward or backward.

To raise or lower steering wheel, push switch up or down.

Note:

The steering wheel position can be stored in memory together with the seat/head restraint and exterior rear view mirror positions, see Index.

Warning!

Do not adjust the steering wheel while driving. Adjusting the steering wheel while driving could cause the driver to lose control of the vehicle

Armrest, Rear Bench

Pull down the armrest by its top.

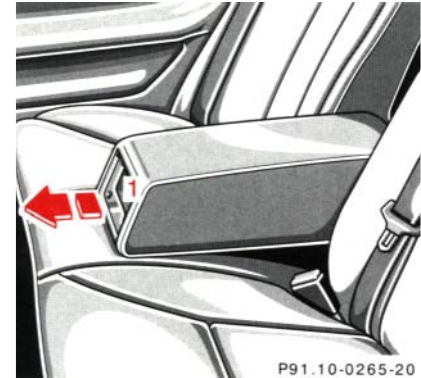

Cup Holder in Rear Bench Armrest

Briefly press drawer (1) and pull out to its detent.

First Aid Kit in Rear Bench Armrest

Press button (1) and pull drawer out to its final stop.



P54.25-0204-20

Head Restraints, Rear

Folding head restraints backward (with engine running):
Press symbol-side of rocker switch to release the head restraints. The head restraints will then fold backward for increased visibility.

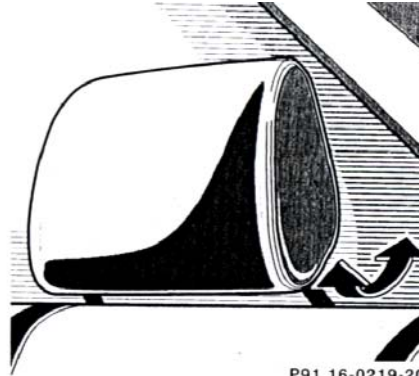

P91.16-0219-20

Placing head restraints upright:
Pull head restraint forward until it locks in position.
Inclination of head restraints:
The head restraint inclination can be adjusted manually.

Important!

For safety reasons, always drive with the rear head restraints in the upright position when the rear seats are occupied.
Keep area around head restraints clear of articles (e.g. clothing) to not obstruct the folding operation of the head restraints.

Cargo Tie-Down Hooks

Inside the trunk are four cargo tie-down hooks.

Secure cargo by applying even load on all four hooks.

Shelf below Rear Window

Warning!

The shelf below the rear window should not be used to carry objects. This will prevent such objects from being thrown about and injuring vehicle occupants during an accident or sudden maneuver.

Seat Belts and Supplemental Restraint System (SRS)

Your vehicle is equipped with seat belts for all seats, emergency tensioning retractors for the front seat belts, as well as front and side impact airbags and knee bolsters for driver and front passenger.

Seat Belts

Important!

Laws in most states and all Canadian provinces require seat belt use.

All states and provinces require use of child restraints that comply with U.S. Federal Motor Vehicle Safety Standard 213 and Canadian Motor Vehicle Safety Standard 213.

We strongly recommend their use

Warning!

Never ride in a moving vehicle with the backrest reclined. Sitting in an excessively reclined position can be dangerous. You could slide under the seat belt in a collision. If you slide under it, the belt would apply force at the abdomen or neck. That could cause serious or even fatal injuries. The backrest and seat belt provide the best restraint when the wearer is in an upright position and the belt is properly positioned on the body.

Seat Belt Warning System

With the electronic key in steering lock position 2, a warning sounds for a short time if the driver's seat belt is not fastened.

Warning!

Failure to wear and properly fasten and position your seat belt greatly increases your risk of injuries and their likely severity in an accident. You and your passengers should always wear seat belts.

If you are ever in an accident, your injuries can be considerably more severe without your seat belt properly buckled. Without your seat belt buckled, you are much more likely to hit the interior of the vehicle or be ejected from it. You can be seriously injured or killed.

In the same crash, the possibility for injury or death is lessened with your seat belt buckled.

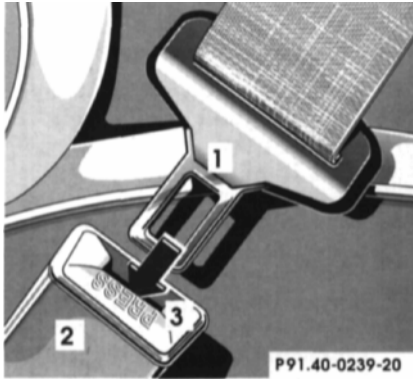

Fastening of Seat Belts

- 1 Latch plate
- 2 Buckle
- 3 Release button
- 4 Button for belt outlet height adjustment

Push latch plate (1) into buckle (2) until it clicks. Do not twist the belt. A twisted seat belt may cause injury.

The lap belt should be positioned as low as possible on your hips and not across the abdomen



Tighten the lap portion to a snug fit by pulling shoulder portion up.

The shoulder portion of the seat belt must be pulled snug and checked for snugness immediately after engaging it.

Adjust seat belt so that shoulder portion is located as close as possible to the middle of your shoulder (it should not touch the neck). For this purpose, you can adjust the belt height. Five positions are available

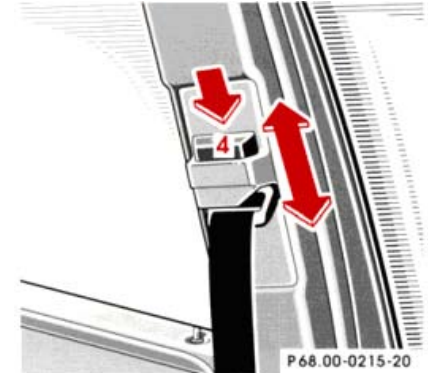

Raising:
Slide belt outlet upward.

Lowering:
Press button (4) and slide belt outlet downward.

For safety reasons, avoid adjusting the seat or seat back into positions which could affect the correct seat belt position.

Note:

For cleaning and care of the seat belts, see *Cleaning and Care of the Vehicle* in Index.

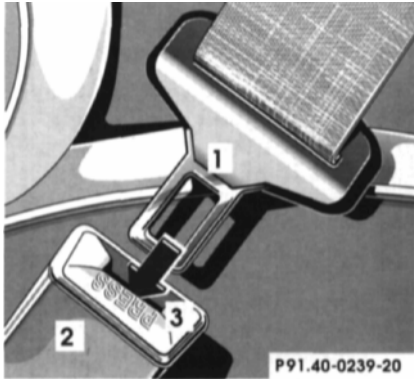

Unfastening of Seat Belts

Push the release button (3) in the belt buckle (2).

Allow the retractor to completely rewind the seat belt by guiding the latch plate (1).

Operation:

The inertia reel stops the belt from unwinding during sudden vehicle stops or when quickly pulling on the belt. The locking function of the reel may be checked by quickly pulling out the belt.

Warning!

USE SEAT BELTS PROPERLY.

- Each occupant should wear their seat belt at all times, because seat belts help reduce the likelihood of and potential severity of injuries in accidents, including rollovers. "SRS" (driver airbag, front passenger airbag, side impact airbags), "ETR" (seat belt emergency tensioning retractors), and knee bolsters are designed to enhance the protection offered to properly belted occupants in certain frontal impacts which exceed preset deployment thresholds.
- Improperly positioned seat belts do not provide maximum protection and may cause serious injuries in case of an accident.
- Never wear the shoulder belt under your arm, against your neck or off your shoulder. In a crash, your body would move too far forward. That would increase the chance of head and neck injuries. The belt would also apply too much force to the ribs or abdomen, which could severely injure internal organs such as your liver or spleen.
- Position the lap belt as low as possible on your hips and not across the abdomen. If the belt is positioned across your abdomen, it could cause serious injuries in a crash.
- Each seat belt should never be used for more than one person at a time. Do not fasten a seat belt around a person and objects.
- Belts should not be worn twisted. In a crash, you wouldn't have the full width of the belt to take impact forces. The twisted belt against your body could cause injuries.
- Pregnant women should also use a lap-shoulder belt. The lap belt portion should be positioned as low as possible on the hips to avoid any possible pressure on the abdomen.

Warning!

USE CHILD RESTRAINTS PROPERLY.

- **Infants and small children must be seated in an infant or child restraint system, which is properly secured by a lap belt or lap belt portion of a lap-shoulder belt. Children could be endangered in an accident if their child restraints are not properly secured in the vehicle.**
- **Rear-facing child restraints must not be used in the front seat. They could be struck by the airbag when it inflates in a crash. If this happens, a child in the restraint could be seriously or fatally injured.**

- **According to accident statistics, children are safer when properly restrained in the rear seating positions than in the front seating positions.**
- **Children too big for child restraint systems should ride in rear seats using regular seat belts. Position shoulder belt across chest and shoulder, not face or neck. A booster seat may be necessary to achieve proper belt positioning.**
- **Adjust the front passenger seat as far as possible rear ward from the dashboard when a child restraint is installed.**

Supplemental Restraint System (SRS)

The term SRS means that airbags are intended as a supplement to seat belts. Airbags alone cannot protect as well as airbags plus seat belts in impacts for which the air-bags were designed to operate, and do not afford any protection whatsoever in crashes for which the system is not designed to deploy.

The SRS uses two crash severity levels (thresholds) to activate either the Emergency Tensioning Retractor (ETR) or airbag or both. Activation depends on the direction and severity of the impact, exceeding the thresholds and fastening of the seat belt.

Seat belt fastened

- first threshold exceeded:
ETR activates
- second threshold exceeded:
airbag also activates

Seat belt not fastened

- first threshold exceeded:
airbag activates, but not ETR

Driver and front passenger systems operate independently of each other.

Emergency Tensioning Retractor (ETR)

The seat belts for the front seats are equipped with emergency tensioning retractors. These tensioning retractors are located in each belt's inertia reel and become operationally ready with the electronic key in steering lock position 1 or 2.

The emergency tensioning retractors are designed to activate only when the seat belts are fastened during frontal impacts exceeding the first threshold of the SRS and in rear impacts exceeding a preset security level. They remove slack from the belts in such a way that the seat belts fit more snugly against the body restricting its forward movement as much as possible.

In cases of other frontal impacts, angled impacts, roll-overs, certain side impacts, or other accidents without sufficient frontal or rear impact forces, the emergency tensioning retractors will not be activated. The driver and passengers will then be protected by the fastened seat belts and inertia reel in the usual manner.

For seat belt and emergency tensioning retractor safety guidelines see *Safety Guidelines* in Index.



P91 60-0542-20

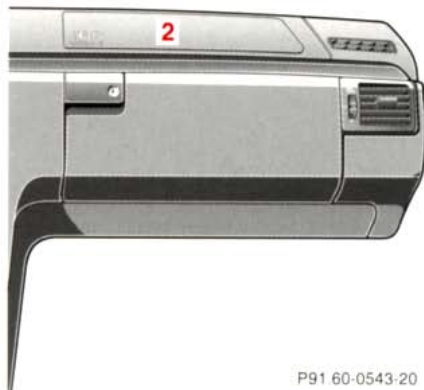

P91 60-0543-20

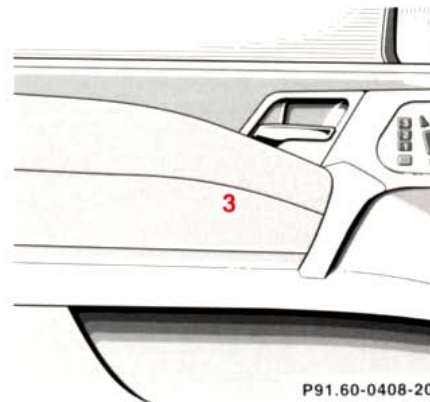

P91.60-0408-20

Airbags

- 1 Driver airbag
- 2 Front passenger airbag
- 3 Side impact airbag

The most effective occupant restraint system yet developed for use in production vehicles is the seat belt. In some cases, however, the protective effect of a seat belt can be further enhanced by an airbag.

The driver airbag is located in the steering wheel hub. The passenger front airbag is located in the dashboard ahead of the front passenger

The side impact airbags are located in the doors. In conjunction with wearing the seat belts with emergency tensioning retractors, the airbags can provide increased protection for the driver and front passenger in certain major frontal (for front airbags), and side impacts (for side impact airbags).

The operational readiness of the airbag system is verified by the indicator lamp "SRS" in the instrument cluster when turning the electronic key in steering lock to position 1 or 2. If no fault is detected, the lamp will go out after approximately 4 seconds; after the lamp goes out, the system continues to monitor the components and circuitry

of the airbag system and will indicate a malfunction by coming on again.

The following system components are monitored or undergo a self-check: crash-sensor(s), airbag ignition circuits, front seat belt buckles, emergency tensioning retractors, seat sensor.

Initially, when the electronic key is turned from steering lock position 0 to positions 1 or 2, malfunctions in the crash-sensor are detected and indicated (the "SRS" indicator lamp stays on longer than 4 seconds).

In the operational mode, after the indicator lamp has gone out following

the initial check, interruptions or short circuits in the airbag ignition circuit and in the driver and passenger seat belt buckle harnesses, and low voltage in the entire system are detected and indicated.

In the event a malfunction of the "SRS" is indicated as outlined above, the "SRS" may not be operational. We strongly recommend that you visit an authorized Mercedes-Benz dealer immediately to have the system checked; otherwise the "SRS" may not be activated when needed.

Front Airbags

The driver and front passenger "SRS" airbags are designed to activate only in certain frontal and front-angled impacts.

The front passenger airbag deploys only if the passenger seat is occupied.

Note:

Do not place heavy objects on front passenger seat, otherwise the front airbag may deploy.

Side Impact Airbags

The side impact "SRS" airbags are designed to activate only in certain side impacts. Only the impacted side airbag deploys.

The passenger side airbag deploys only, if the seat is occupied.

Note:

Do not place heavy objects on front passenger seat, otherwise the side airbag may deploy.

Important!

The "SRS" airbags are designed to activate only in certain frontal, front-angled or side impacts. Only during these types of impacts, if of sufficient severity to meet the deployment thresholds, will they provide their supplemental protection. The driver and passenger should always wear the seat belts, otherwise it is not possible for the airbags to provide their intended supplemental protection.

In cases of other frontal impacts, roll-overs, other side impacts, rear

collisions, or other accidents without sufficient forces, the airbag will not be activated.

The driver and passengers will then be protected by the fastened seat belts.

We caution you not to rely on the presence of an airbag in order to avoid wearing your seat belt. The "SRS" is designed to reduce the potential of injury in certain frontal, front-angled and side impacts which may cause injuries, however, no system available today can totally eliminate injuries and fatalities. The activation of the "SRS" temporarily releases a small amount of dust from the air-bags. This dust, however, is neither injurious to your health, nor does it indicate a fire in the vehicle.

The service life of the airbags extends to the date indicated on the label located on the driver-side door latch post. To provide continued reliability after that date, they should be inspected by an authorized Mercedes-Benz dealer at that time and replaced when necessary.

Warning!

It is very important for your safety to always be in a properly seated position and to wear your seat belt.

For maximum protection in the event of a collision always be in normal seated position with your back against the backrest. Fasten your seat belt and ensure that it is properly positioned on the body.

Since the airbag inflates with considerable speed and force, a proper seating and hands on steering wheel position will help to keep you in a safe distance from the airbag:

- **Sit properly belted in an upright position with your back against the backrest.**
- **Adjust the driver seat as far as possible rearward, still permitting proper operation of vehicle controls.**
- **Do not lean with your head or chest close to the steering wheel or dashboard.**
- **Keep hands on the outside of steering wheel rim. Placing hands and arms inside the rim can increase the risk and potential severity of hand/arm injury when the driver front airbag inflates.**
- **Adjust the passenger seat as far as possible rearward from the dashboard, especially when a child restraint is installed.**
- **Infants and small children should only be seated in an infant or child restraint which is properly secured.**
- **Rear-facing child restraints must not be used in a front seat.**

Failure to follow these instructions can result in severe injuries to you or other occupants.

Safety Guidelines for the Seat Belt, Emergency Tensioning Retractor and Airbag

Warning!

- **Damaged belts or belts that were highly stressed in an accident must be replaced and their anchoring points must also be checked. Use only belts installed or supplied by an authorized Mercedes-Benz dealer.**
- **Do not pass belts over sharp edges.**
- **Do not make any modification that could change the effectiveness of the belts.**
- **The "SRS" is designed to function on a one-time-only basis. An airbag or emergency tensioning retractor (ETR) that was activated must be replaced.**
- **No modifications of any kind may be made to any components**

or wiring of the "SRS". This includes the installation of additional trim material, badges etc. over the steering wheel hub, front passenger airbag cover, or front door trim panels, and installation of additional electrical/electronic equipment on or near "SRS" components and wiring.

- **An airbag system component within the steering wheel gets hot after the airbag has inflated.**
- **Improper work on the system, including incorrect installation and removal, can lead to possible injury through an uncontrolled activation of the "SRS".**
- **In addition, through improper work there is the risk of rendering the "SRS" inoperative. Work on the "SRS" must therefore only be performed by an authorized Mercedes-Benz dealer.**

- **When scrapping the airbag unit or emergency tensioning retractor, it is mandatory to follow our safety instructions. These instructions are available at your authorized Mercedes-Benz dealer.**

When you sell the vehicle we strongly urge you to give notice to the subsequent owner that it is equipped with an "SRS" by alerting him to the applicable section in the Owner's Manual.

Infant and Child Restraint Systems

We recommend that all infants and children be properly restrained at all times while the vehicle is in motion.

All lap-shoulder belts except driver seat have special seat belt retractors for secure fastening of child restraints. To fasten a child restraint use this seat belt:

Follow child restraint instructions for routing. Then pull shoulder belt out completely and let it retract. The belt is now locked. Push down on child restraint to take up any slack.

Important!

The use of infant or child restraints is required by law in all 50 states and all Canadian provinces.

Infants and small children should be seated in an appropriate infant or child restraint system properly secured by a lap-shoulder belt, and that complies with U.S. Federal Motor Vehicle Safety Standard 213 and Canadian Motor Vehicle Safety Standard 213. A statement by the child restraint manufacturer of compliance with this standard can be found on the instruction label on the restraint and in the instruction manual provided with the restraint.

When using any infant or child restraint system, be sure to carefully read and follow all manufacturer's instructions for installation and use.

Warning!

According to accident statistics, children are safer when properly restrained in the rear seating positions than in the front seating positions.

Rear-facing child restraints must not be used in the front passenger seat. They could be struck by the airbag when it inflates in a crash. If this happens, a child in the restraint could be seriously or fatally injured.

Infants and small children should never be held on the lap while the vehicle is in motion. During an accident they would be almost impossible to hold, and could be crushed between the adult and the dashboard.

Infants and small children should never share a seat belt with another occupant. During an accident, they could be crushed between the occupant and seat belt.

Children too big for child restraint systems should ride in rear seats using regular seat belts. Position shoulder belt across chest and shoulder, not face or neck. A booster seat may be necessary to achieve proper belt positioning.

When the child restraint is not in use, remove it from the car or secure it with the seat belt to prevent the child restraint from becoming a projectile in the event of an accident.

U.S.A. Models only:

Since 1986 all U.S. child restraints comply with U.S. regulations without the use of a tether strap.

Canada Models only:

This vehicle is provided with tether anchorages for a top tether strap. Consult your authorized Mercedes-Benz dealer for installation of these anchorages.

In compliance with Canadian Motor Vehicle Safety Standard 210.1, child restraint tether anchorage hardware is attached to the tool kit located in the trunk.

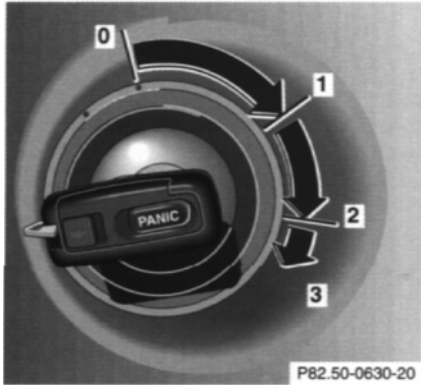

Steering Lock

0 The electronic key can be withdrawn in this position only. The steering is locked with the electronic key removed from the steering lock. If necessary, move steering wheel slightly to allow the locking mechanism to engage. The electronic key can be removed only with the selector lever in position "P" and your foot off the brake pedal. After removing the electronic key or with the electronic key in steering lock position 0, the selector lever is locked in position "P".

- 1 Steering is unlocked.
(If necessary, move steering wheel slightly to allow the electronic key to be turned clockwise to position 1.) Most electrical consumers can be operated. For detailed information see respective subjects.
- 2 Driving position.
- 3 Starting position.

Refer to Index for *Starting and turning off the engine*.

Warning!

When leaving the vehicle always remove the electronic key from the steering lock, and lock the vehicle. Do not leave children unattended in the vehicle, or with access to an unlocked vehicle. Unsupervised use of vehicle equipment may cause serious personal injury.

Important!

If the electronic key is left in the steering lock position 0 for an extended period of time, it can no longer be turned in the lock. In this case, remove electronic key from steering lock and reinsert.

Notes:

A warning sounds when the driver's door is opened with the electronic key in steering lock position 1 or 0.

With the engine at idle speed, the charging rate of the alternator (output) is limited.

It is therefore recommended to turn off unnecessary electrical consumers while driving in stop-and-go traffic. This precaution helps to avoid draining of the battery.



Unnecessary strain on the battery and charging system may be minimized by turning off the following power consumers, for example: Heated seats, rear window defroster.

Caution!

To prevent accelerated battery discharge and a possible dead battery, always remove the electronic key from the steering lock. **Do not** leave the electronic key in steering lock position 0.



Combination Switch

- 1 Low beam (exterior lamp switch position )
- 2 High beam (exterior lamp switch position )
- 3 High beam flasher (high beam available independent of exterior lamp switch position)
- 4 Turn signals, right
- 5 Turn signals, left



To signal minor directional changes, such as changing lanes on a highway, move combination switch to the point of resistance only and hold it there.

To operate the turn signals continuously, move the combination switch past the point of resistance (up or down). The switch is automatically canceled when the steering wheel is turned to a large enough degree.

- 6 Control for windshield wiper/washer system:
Push briefly for single wipe without adding washer fluid (use only when windshield is wet)
Push past detent and hold to activate wiper and washer
- 7 Windshield wiper
 - 0 Wiper off
 - I Intermittent wiping (optional rain sensor: One initial wipe, pauses between wipes are automatically controlled by a rain sensor monitoring the wetness of the windshield.)
 - II Normal wiper speed
 - III Fast wiper speed

Note:

The windshield washer reservoir, hoses and nozzles are automatically heated.

Windshield and Headlamp Washer Fluid Mixing Ratio

For temperatures above freezing:

MB Windshield Washer Concentrate "S" and water

1 part "S" to 100 parts water
(40 ml "S" to 1 gallon water).

For temperature below freezing:

MB Windshield Washer Concentrate "S" and commercially available premixed windshield washer solvent/antifreeze

1 part "S" to 100 parts solvent
(40 ml "S" to 1 gallon solvent).

Windshield Wiper Smears

If the windshield wiper smears the windshield, even during rain, activate the washer system as often as necessary. The fluid in the washer reservoir should be mixed in the correct ratio.

Blocked Windshield Wiper

If the windshield wiper becomes blocked (for example, due to snow), switch off the wiper.

For safety reasons before removing ice or snow, remove electronic key from steering lock. Remove blockage.

Activate combination switch again (electronic key in steering lock position 1).

Turn Signal Failure

If one of the turn signals fails, the turn signal indicator system flashes and sounds at a faster than normal rate.



Headlamp Cleaning System (optional)

The headlamp washer can be activated with the electronic key in steering lock position 2.

Briefly press symbol side of switch.



Exterior Lamp Switch



Canada only:

When the engine is running and the selector lever is in a driving position, the low beam (includes parking lamps, side marker lamps, taillamps and license plate lamps) are automatically switched on.

When shifting from a driving position to position "N" or "P", the low beam switches off (2 seconds delay). For nighttime driving the exterior lamp switch should be turned to position  to permit activation of the high beam headlamps.



Off



Parking lamps

(also side marker lamps, taillamps, license plate lamps, instrument panel lamps) Canada only:

When the engine is running, the low beam is additionally switched on.



Parking lamps plus low beam

or high beam headlamps (combination switch pushed forward)



Standing lamps, right

(turn left one stop)



Standing lamps, left

(turn left two stops)



Front fog lamps

(pull out one stop) with parking lamps and/or low beam headlamps on. Green indicator lamp in lamp switch comes on.



Rear fog lamp

(pull out to 2nd detent) in addition to fog lamps.

Yellow indicator lamp in lamp switch comes on.

Standing Lamps

When the vehicle is parked on the street the standing lamps (right or left side parking lamps) can be turned on, making the vehicle more visible to passing vehicles.

The standing lamps cannot be operated with the electronic key in steering lock position 2.

Note:

With the electronic key removed and the driver's door open, a warning sounds and the message "SWITCH OFF LIGHTS" in the multifunction indicator appears if the vehicle's exterior lamps (except standing lamps) are not switched off.

Fog lamps will operate with the parking lamps and/or the low beam headlamps on. Fog lamps should only be used in conjunction with low beam headlamps. Consult your State or Province Motor Vehicle Regulations regarding allowable lamp operation.

Fog lamps are automatically switched off when the exterior lamp switch is turned to position .

Night Security Illumination

When exiting the vehicle after driving with the exterior lamps on, they switch on again for added illumination for approximately 30 seconds after closing the last door.

Inside Rear View Mirror

Manually adjust the mirror.

Use your inside mirror to determine the size and distance of objects seen in the passenger side convex mirror.

Antiglare Night Position

With the electronic key in steering lock position 2, the mirror reflection brightness responds to changes in light sensitivity.

With gear selector lever in position "R", or with the interior lamp switched on, the mirror brightness does not respond to changes in light sensitivity.



Exterior Rear View Mirrors

The switch is located on the center console.

Turn electronic key in steering lock to position 2.

First select the mirror to be adjusted - press button:



Left mirror

Right mirror

To adjust, toggle the switch forward, backward or to either side.

With the electronic key in steering lock position 2, the driver's side mirror reflection brightness responds to changes in light sensitivity.

With gear selector lever in position "R", or with the interior lamp switched on, the driver's side mirror brightness does not respond to changes in light sensitivity.

Warning!

Exercise care when using the passenger-side mirror. The passenger-side exterior mirror is convex (outwardly curved surface for a wider field of view). Objects in mirror are closer than they appear. Check your inside rear view mirror or glance over your shoulder before changing lanes.

Note:

The exterior mirrors have electrically heated glass. The heater switches on automatically, depending on outside temperature.

If an exterior mirror housing is forcibly pivoted from its normal position, it must be repositioned by applying firm pressure until it snaps into place.

Storing Mirror Positions in Memory

The exterior rear view mirror positions are stored in memory with the seat/head restraint position and can be recalled when necessary, see Index.

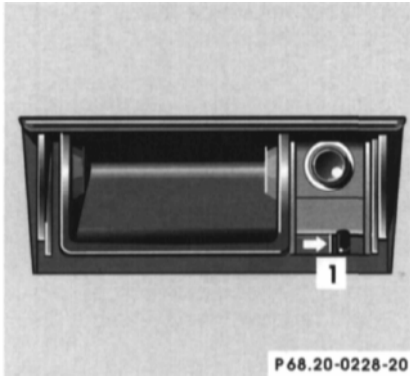

Ashtrays

Center Console, Front

By touching the bottom of the cover lightly, the ashtray opens automatically.

Prior to removing the ashtray insert, move the gear selector lever to position "N".

Warning!

With the gear selector lever in position "N", turn off the engine and set the parking brake. Otherwise the vehicle might move unintentionally.

To remove ashtray:
Push sliding knob (1) toward the right to eject the insert.

To install ashtray:
Install insert into ashtray frame and push down to engage.

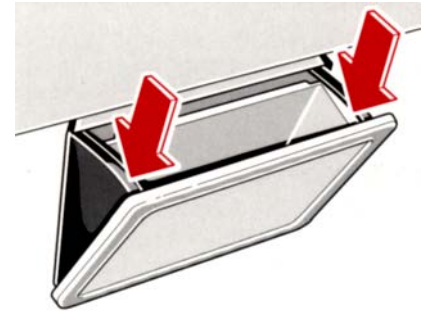

P68.00-0208-20

Rear Doors

To remove ashtray:
Push left and right sides down and pull out the ashtray.

To install ashtray:
Install top of ashtray, push bottom part in to engage

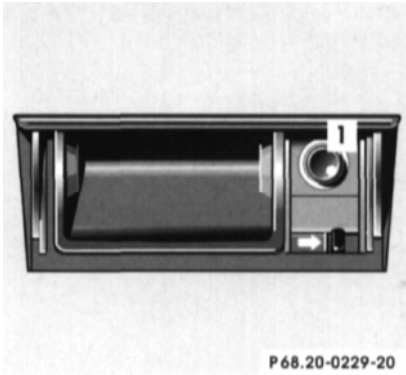

Lighter

Turn electronic key in steering lock to position 1 or 2.
Push in lighter (1); it will pop out automatically when hot.

Warning!

Never touch the heating element or sides of the lighter, they are extremely hot, hold at knob only.

Note:

The lighter socket can be used to accommodate electrical accessories up to maximum 85 W.

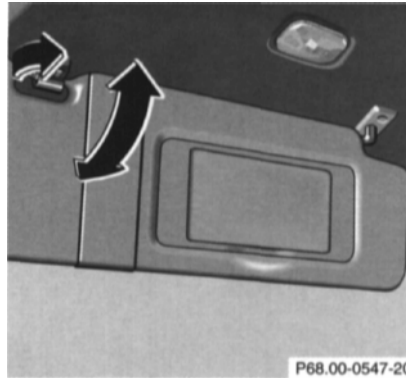

Sun Visors

Swing sun visors down to protect against sun glare.

If sunlight enters through a side window, disengage visor from inner mounting, pivot it to the side.

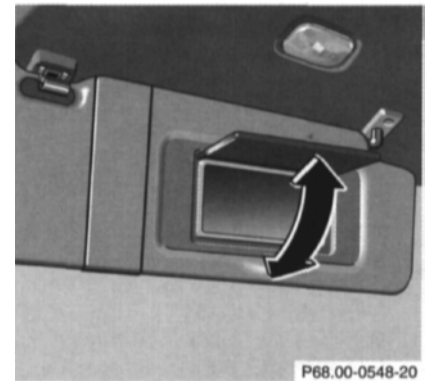

Illuminated Vanity Mirrors

With the visor engaged in its inner mounting, the lamp is switched on by opening the cover.

Warning!

Do not use the vanity mirror while driving.

The lamp goes out automatically after approximately 5 minutes.

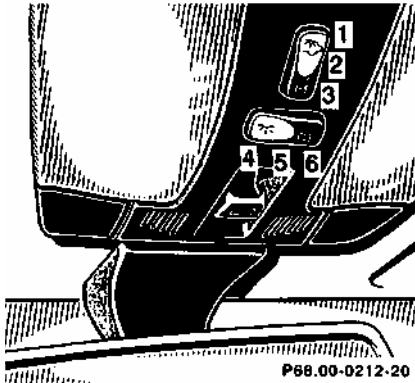

Interior Lighting

- 1** Rear passenger compartment lamp on.
- 2** Door contact on.
Interior lamps are switched on when opening a door.
Interior lamps are switched on, and off (soft fade) delayed, when unlocking or locking the vehicle, or when opening or closing a door. However, there will be no (soft fade) delay when the key is in steering lock position 2.
- 3** Door contact off.
Interior lamps remain switched off, even when opening a door.
- 4** Interior and reading lamp on.
- 5** Interior and reading lamps off.
- 6** Reading lamp on.

Note:

If a door remains open, the interior lamps switch off after approximately 5 minutes.

Entrance Lamps, Exit Lamps in Doors

The lamps are switched on and off by the door contact switches.

Note:

To prevent the vehicle battery from being discharged, with doors open all interior lamps go out after approximately 5 minutes.

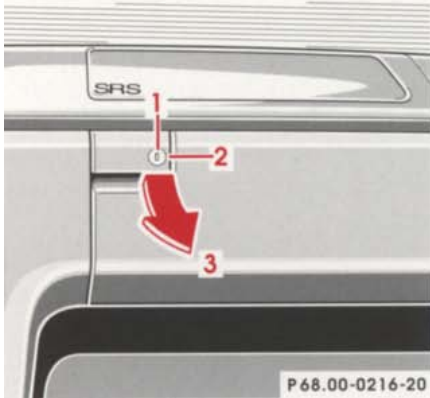

Storage Compartments and Cup Holder Glove Box

- 1** Unlocking: Turn mechanical key to vertical position and remove.
- 2** Locking: Turn mechanical key to the right and remove.
- 3** Opening: Pull on handle.

Storage Compartments above Ashtray in Center Console

To open: Touch bottom of cover slightly. The cover opens automatically.

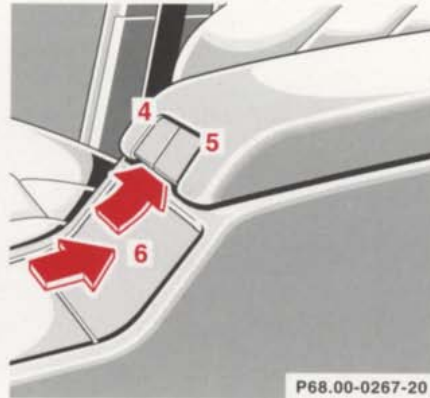

Storage Compartments in Center Console

To open compartment in armrest: Lift lid with handle (4).
To open compartment under armrest: Lift lid with handle (5).
To close: Lower lid until it engages in lock.

Cup Holder in Center Console

To open cover: Touch top of cover (6) slightly. The cover opens automatically.



To open cup holder: Briefly press button (7). The cup holder opens automatically.

To store cup holder: Push button (7) down until cup holder engages. Close cover (6).

Caution!

Keep compartment lids closed. This will prevent stored objects from being thrown about and injuring vehicle occupants during an accident

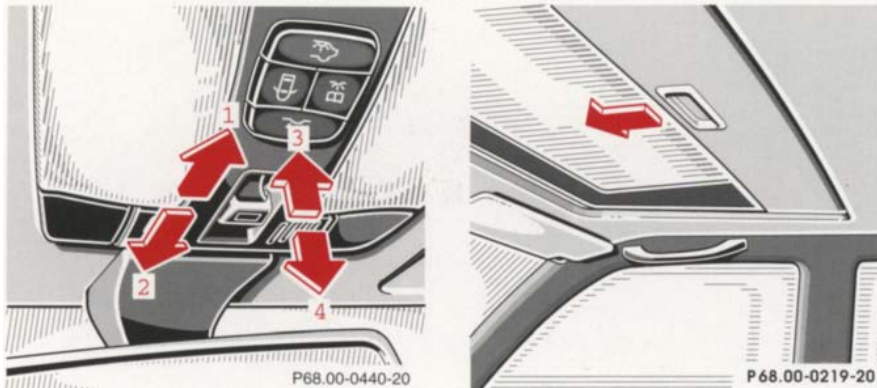

Sliding/Pop-Up Roof (optional)

- 1 to slide roof open
- 2 to slide roof closed
- 3 to raise roof at rear
- 4 to lower roof at rear

Turn electronic key in steering lock to position 1 or 2.

The switch is illuminated when the exterior lamps are switched on (except standing lamps).

An additional screen can be slid into the roof opening to guard against sun rays. When sliding the roof open, the screen will also retract.

Warning!

When closing the sliding/ pop-up roof, be sure that there is no danger of anyone being harmed by the closing procedure.

Notes:

The sliding/pop-up roof can be opened or closed manually should an electrical malfunction occur, refer to *Sliding Roof, Emergency Operation* in Index.

The sliding/pop-up roof can also be closed with the mechanical key or infrared remote control while locking the vehicle doors or trunk (see *Central Locking System* in Index).



Power Windows

Power window switches located on center console

Switches for:

- 1 left, front
- 2 left, rear
- 3 right, front
- 4 right, rear
- 5 safety switch
- 6 individual switches (rear doors)

Turn electronic key in steering lock to position 1 or 2.





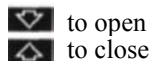

In rear doors

Press switch in to resistance point:



Release switch when window is in desired position.

Express Opening and Closing

Press switch  or  past resistance point and release - window opens or closes completely.
To interrupt procedure, briefly press  or .

Blocking of Rear Door Window Operation

If no operation of the rear windows by switch (6) (for instance by children) is desired, slide safety switch (5) to right, symbol  becomes visible.

Warning!

When closing the windows, be sure that there is no danger of anyone being harmed by the closing procedure.

When leaving the vehicle, always remove the key from the steering lock. Do not leave children unattended in the vehicle. Unsupervised use of vehicle equipment can cause serious personal injury.

Note:

The power windows can also be closed with the key or infrared remote control while locking the vehicle doors or trunk (see *Central Locking System* in Index).



P82.50-0653-20

Trunk Lid Release Switch

The switch is located in the center console.

To open the trunk, the vehicle must be parked and unlocked. Press symbol side of switch.

With vehicle centrally locked, the trunk can also be opened by using the infrared remote control. Aim transmitter eye at a receiver and press transmit button twice.

Note:

The trunk lid cannot be released by the switch when previously locked with the key. To open, refer to *Trunk, separately locked* (in Index).

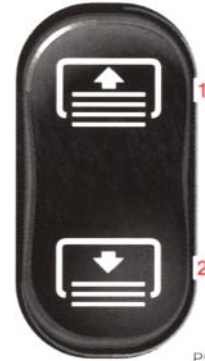

P54.25-0295-20

Rear Window Sunshade

- 1 Raising
- 2 Lowering

The switch is located on the center console.

Turn key in steering lock to position 1 or 2.

The sunshade should always be either fully raised or fully lowered.



Instrument Lamps

Press + or - button to vary intensity of instrument lamps.

Display Illumination

The display for temperature, odometer, multifunction indicator, FSS indicator and clock is illuminated briefly when opening the driver door.

The display illumination brightness responds automatically according to changes in the surrounding light sensitivity.

To briefly illuminate the display (with electronic key removed or in steering lock position 0 or 1), press button **O**, +, -, **h**, **m** or **R**.

Trip Odometer

To reset:

- Press and hold button **O** (with display illuminated).
- Press button **O** twice and hold (with display not illuminated).

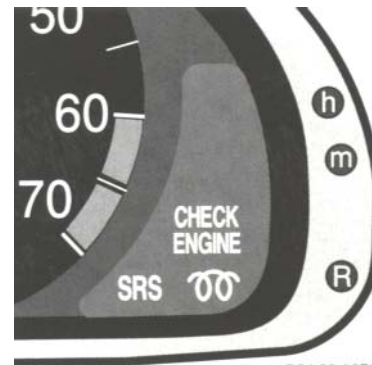

Clock

Adjusting clock (display illuminated):

Press button **m** or **h** briefly. The display flashes to indicate that the clock can be adjusted.

Minute: Press button **m** briefly.

Minutes: Press and hold button **m**.

Hour: Press button **h** briefly. Hours:

Press and hold button **h**.



Garage Door Opener

- 1 Remote control transmitter located on inside rear view mirror
- 2 Portable remote control transmitter

The visor remote control is capable of operating up to three separately controlled objects.

Warning!

When programming a garage door opener, the door moves up or down.

When programming or operating the remote control make sure there is no possibility of anyone being harmed by the moving door.

Notes:

Certain types of garage door openers are incompatible with the integrated opener. If you should experience difficulties with programming the transmitter, contact your authorized Mercedes-Benz dealer or call Mercedes-Benz Customer Assistance Center (in the U.S.A. only) at 1 -800-FOR-MERCEdes.

Programming or reprogramming the remote control:

1. Turn electronic key in steering lock to position 1 or 2.
2. Press and hold one button of the remote control located on the inside rear view mirror until its control light begins to flash at a rate of about once a second. Continue holding down the button.

Note:

The light blinks immediately if the remote control is being programmed for the first time, or if its memory was previously erased. If you are reprogramming a previously used button, the light will flash after about 20 seconds.

3. Hold end opposite to battery of portable remote control against the inside rear view mirror transmitter to be programmed. While still holding down the button on the transmitter on the inside rear view mirror, press down the button on your portable remote

control, until the inside rear view mirror remote control light starts to flash rapidly. This means that the integrated remote control has accepted the frequency and code of the portable transmitter.

4. If you wish, repeat the procedure for each remaining button.

Operation of remote control:

1. Turn electronic key in steering lock to position 1 or 2.
2. Select and press the appropriate button (1, 2 or 3) to activate the remote controlled device. The remote control transmitter continues to send the signal as long as the button is pressed - up to 20 seconds.

Erasing the remote control memory:

1. Turn electronic key in steering lock to position 1 or 2.
2. Simultaneously holding down buttons 1 and 3 for approximately 20 seconds, or until the control light blinks rapidly, will erase the codes of all three channels.

Cellular Telephone

The vehicle is prepared for the installation of a cellular telephone. For further information and installation contact your authorized Mercedes-Benz dealer.

Warning!

Some jurisdictions prohibit the driver from using a cellular telephone while driving a vehicle. Whether or not prohibited by law, for safety reasons, the driver should not use the cellular telephone while the vehicle is in motion. Stop the vehicle in a safe location before answering or placing a call.

Driving

Drinking and Driving

Warning!

Drinking and driving can be a very dangerous combination. Even a small amount of alcohol or drugs can affect your reflexes, perceptions and judgement.

The possibility of a serious or even fatal accident is sharply increased when you drink and drive.

Please don't drink and drive or allow anyone to drive after drinking.

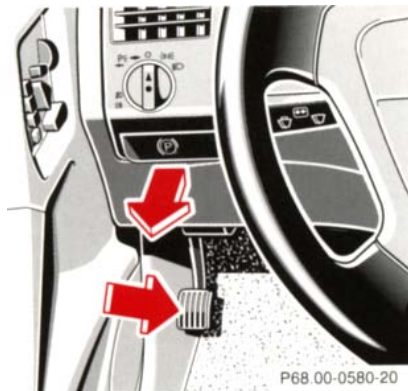

Parking Brake

To engage, firmly depress parking brake pedal. When the electronic key is in steering lock position 2, the brake warning lamp in the instrument cluster should come on brightly.

To release the parking brake, pull handle on instrument panel. The brake warning lamp in the instrument cluster should go out.

A warning sounds, if you start to drive without having released the parking brake.

Also see *Brake Warning Lamp* in Index

Driving Off

Apply the service brakes to test them briefly after driving off. Perform this procedure only when the road is clear of other traffic.

Warm up the engine smoothly. Do not place full load on the engine until the operating temperature has been reached.

When starting off on a slippery surface, do not allow one drive wheel to spin for an extended period.

Warning!

Keep driver's foot area clear at all times. Objects stored in this area may impair pedal movement.

Automatic Transmission

The automatic transmission selects individual gears automatically, dependent upon:

- Selector lever position
- Program mode selector
- Accelerator position
- Vehicle speed

Important!

When parking the car or before working on the vehicle with the engine running, firmly depress the parking brake pedal and shift the selector lever into "P".

Driving

The selector lever is automatically locked while in position "P". To move the selector lever out of position "P", the service brake pedal must be firmly depressed before the shift lock will release.

Shift selector lever to the desired position only when the engine is idling normally and the service brake is applied. Do not release

the brake until ready to drive. The vehicle may otherwise start creeping when the selector lever is in drive or reverse position.

Warning!

It is dangerous to shift the selector lever out of "P" or "N" if the engine speed is higher than idle speed. If your foot is not firmly on the brake pedal, the vehicle could accelerate quickly forward or in reverse. You could lose control of the vehicle and hit someone or something. Only shift into gear when the engine is idling normally and when your right foot is firmly on the brake pedal.

Important!

After selecting any driving position from "N" or "P", wait a moment to allow the gear to fully engage before accelerating, especially when the engine is cold.

Accelerator Position

Partial throttle = early upshifting = normal acceleration

Full throttle = later upshifting = rapid acceleration

Kickdown (depressing the accelerator beyond full throttle) = downshifting to a lower gear = maximum acceleration. Once the desired speed is attained, ease up on the accelerator - the transmission shifts up again.

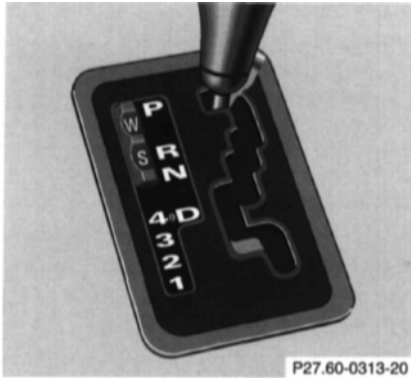

Selector Lever Positions

The automatic gear shifting process can be adapted to specific operating conditions using the selector lever.

P Parking position.
The parking position is to be used when parking the vehicle. Engage only with the vehicle stopped.
Note:

The electronic key can be removed from the steering lock only with the foot off the brake pedal and the selector lever in position "P". With the electronic key removed, the

selector lever is locked in position "P".

- R** Reverse gear.
Shift to reverse gear only with the vehicle stopped.
- N** Neutral.
No power is transmitted from the engine to the drive axle. When the brakes are released, the vehicle can be moved freely (pushed or towed). Do not engage "N" while driving except to coast when the vehicle is in danger of skidding (e.g. on icy roads, see *Winter driving Instructions* in Index).

Important!

Coasting the vehicle, or driving for any other reason with selector lever in "N" can result in transmission damage that is not covered by the Mercedes-Benz Limited Warranty.

- D** The transmission automatically upshifts through 5th gear. Position "D" provides optimum driving characteristics under all normal operating conditions.

- 4** Upshift through 4th gear only. Suitable for performance driving. To shift from position "D" to "4", push selector lever to the left.
- 3** Upshift through 3rd gear only. Suitable for moderately steep hills. Since the transmission does not shift higher than 3rd gear, this gear selection will allow use of the engine's braking power downhill.
- 2** Upshift through 2nd gear only. For driving in mountainous regions or under extreme operating conditions. This gear selection will allow use of the engine's braking power when descending steep grades.
- 1** In this position, the engine's braking effect is utilized by shifting into 1st gear. Use this position while descending very steep or lengthy downgrades and only at speeds below 40 mph (60 km/h).

Important!

With selector lever in position "D", "4" or "3", upshifting from 1st to 2nd to 3rd gear is delayed depending on vehicle speed and engine temperature. This allows the catalytic converter to

heat up more quickly to operating temperatures.

During the brief warm-up period this delayed upshift and increased engine noise might be perceived as a malfunction. However, neither the engine nor transmission are negatively affected by this mode of operation.

The delayed upshift is effective with vehicle speeds below 31 mph (50 km/h) at partial throttle and engine temperatures below 95°F (35°C).

To avoid overrevving the engine when the selector lever is moved to a lower driving range, the transmission will not shift to a lower gear as long as the vehicle speed exceeds the speed limit of that gear.

To prevent the engine from laboring at low RPMs, do not allow the engine speed to drop too low on uphill gradients.

Depending on the degree of the incline, shift selector lever to a lower gear range early enough to maintain engine RPM within the best torque range.

Warning!

On slippery road surfaces, never downshift in order to obtain braking action. This could result in drive wheel slip and reduced vehicle control. Your vehicle's ABS will not prevent this type of loss of control.

Maneuvering

To maneuver in tight areas, e.g. when pulling into a parking space, control the vehicle speed by gradually releasing the brakes. Accelerate gently and never abruptly step on the accelerator.

To rock a vehicle out of soft ground (mud or snow), alternately shift from forward to reverse, while applying slight partial throttle.

Rocking a vehicle free in this manner may cause the ABS malfunction indicator lamp to come on. Turn off and restart the engine to clear the malfunction indication.

Stopping

For brief stops, e.g. at traffic lights, leave the transmission in gear and hold vehicle with the service brake.

For longer stops with the engine idling, shift into "N" or "P" and hold the vehicle with the service brake.

When stopping the vehicle on an uphill gradient, do not hold it with the accelerator, use the brake. This avoids unnecessary transmission heat build up.

Warning!

Getting out of your car with the selector lever not fully engaged in position "P" is dangerous. Also, when parked on an incline, position "P" alone may not prevent your vehicle from moving, possibly hitting people or objects.

Always set the parking brake in addition to shifting to position "P".

When parked on an incline, also turn front wheel against curb.



Program Mode Selector Switch

The transmission is provided with a selector switch for Standard "S" and Winter/Wet (snow and ice) "W" program modes.

Warning!

Always be certain of the program mode selected since the vehicle driving characteristics change with the selection of the program mode.

S Standard mode

Press switch on symbol "S". Use this mode for all regular driving.

The vehicle starts out in 1st gear.

W Winter/Wet (snow and ice) mode

Press switch on symbol "W". The vehicle starts out in 2nd gear, except with selector lever in 1st gear, or with accelerator pedal in kick-down position.

The "W" mode helps to improve traction and driving stability of the vehicle.

With hard acceleration the upshifts occur at lower vehicle and engine speeds than in the "S" program mode.

Warning!

During stops use the brake, especially on an incline, to prevent the vehicle from rolling.

Emergency Operation (Limp Home Mode)

If vehicle acceleration worsens, or the transmission no longer shifts, the transmission operates in Limp Home Mode. In addition the "CHECK ENGINE" malfunction indicator lamp in the instrument cluster may come on.

In this mode only the 2nd gear or reverse gear can be activated.

To engage 2nd gear or reverse:

1. Stop the vehicle.
2. Move selector lever to position "P".
3. Turn off the engine.
4. Wait 10 seconds.
5. Restart the engine.
6. Move selector lever to position "D" (for 2nd gear), or move selector lever to position "R" (for reverse gear).

Have the transmission checked at your authorized Mercedes-Benz dealer as soon as possible.

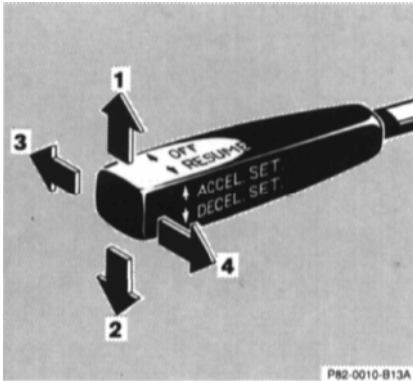

Cruise Control

Any given speed above approximately 25 mph (40 km/h) can be maintained with the cruise control by operating the lever.

- 1** Accelerate and set:
Lift lever briefly to set speed. Hold lever up to accelerate.
- 2** Decelerate and set:
Depress lever briefly to set speed.
Hold lever down to decelerate

Normally the vehicle is accelerated to the desired speed with the accelerator.

Speed is set by briefly pushing the lever to position 1 or 2. The accelerator can be released.

The speed can be increased (e.g. for passing) by using the accelerator. After the accelerator is released, the previously set speed will be resumed automatically.

If a set speed is to be increased or decreased slightly, e.g. to adapt to the traffic flow, hold lever in position 1 or 2 until the desired speed is reached, or briefly tip the lever in the appropriate direction for increases or decreases in 0.6 mph (1 km/h) increments. When the lever is released, the newly set speed remains.

3 Canceling

To cancel the cruise control, briefly push lever to position 3.

When you step on the brake pedal or the vehicle speed drops below approx. 25 mph (40 km/h), for example when driving upgrade, the cruise control will be canceled.

If the cruise control cancels by itself and remains inoperative until the engine is restarted, have the system checked at your authorized Mercedes-Benz dealer as soon as possible.

4 Resume

If the lever is briefly pushed to position 4 when driving at a speed exceeding approx. 25 mph (40 km/h), the vehicle resumes the speed which was set prior to the cancellation of the cruise control. The last memorized speed is canceled when the electronic key in the steering lock is turned to position 1 or 0.

Notes:

If the engine does not brake the vehicle sufficiently while driving on a downgrade, the speed you set on the cruise control may be exceeded and you may have to step on the brake pedal to slow down. As soon as the grade eases, the cruise controlled speed will again be maintained as long as the brakes were not previously applied, or the lever may be used to resume the previously set speed if the brakes were applied.

Important!

Moving gear selector lever to position "N" switches the cruise control off.

Warning!

Only use the cruise control if the traffic and weather conditions make it advisable to travel at a steady speed.

- **The use of cruise control can be dangerous on winding roads or in heavy traffic because conditions do not allow safe driving at a steady speed.**
- **The use of cruise control can be dangerous on slippery roads. Rapid changes in tire adhesion can result in wheel spin and loss of control.**

The "Resume" function should only be operated if the driver is fully aware of the previously set speed and wishes to resume this particular preset speed.

Multifunction Indicator

Language Selection

Warning message selection is available in the English, French, German, Italian, or Spanish language.

With the electronic key in steering lock position 2, simultaneously press reset buttons for Trip Odometer (**O**) and Multifunction Indicator (**R**), located in the instrument cluster, until the presently selected language appears on the screen.

Press button **O** until the requested language appears.

Turn the electronic key in steering lock to position 0.

Multiple Malfunctions

When the multiple malfunction symbol appears, this indicates that several malfunction messages are stored in memory.

Push reset button (**R**) in the instrument cluster for subsequent messages.

Temporarily Switching Off

To temporarily switch off the multifunction indicator warning symbol and message, push reset button (**R**) in the instrument cluster.

The multifunction indicator display is inoperative until the electronic key in steering lock is turned again to position 0 or 2.

The symbols and messages for Parking Brake, Seat Belts, Exterior Lights, and Display Defective cannot be switched off.

Defective

When the message "Display Defective" appears, this indicates that the system is not operational, and possibly other warnings cannot be shown.

Have the vehicle electronic system checked at your authorized Mercedes-Benz dealer as soon as possible.

Charge Indicator

When the symbol and message appear while the engine is running, this indicates a fault which must be repaired at an authorized Mercedes-Benz dealer immediately.

It may indicate that the poly-V-belt has broken. Should this condition occur, the poly-V-belt must be replaced before continuing to operate the vehicle. Otherwise, the engine will overheat due to an inoperative water pump which may result in damage to the engine.

Do not continue to drive the vehicle with the charge indicator symbol displayed. Doing so could result in serious engine damage that is not covered by the Mercedes-Benz Limited Warranty.

Low Engine Oil Level Warning

When the symbol and message appear while the engine is running and at operating temperature, the engine oil level has dropped to approximately the minimum mark on the dipstick.

When this occurs, the warning will first come on intermittently and then stay on if the oil level drops further.

If no oil leaks are noted, continue to drive to the nearest service station where the engine oil should be topped to the "full" mark on the dipstick with an approved oil.

The low engine oil level warning should not be ignored. Extended driving with the symbol displayed could result in serious engine damage that is not covered by the Mercedes-Benz Limited Warranty.

In addition to the warning symbol, the engine oil level should be periodically checked with the dipstick or via the multifunction indicator, for example during a fuel stop, or before a long trip (see Index).

Engine Oil Consumption

Engine oil consumption checks should only be made after the break-in period. During the break-in period, higher oil consumption may be noticed and is normal. Frequent driving at high engine speeds results in increased consumption.

Fuel Reserve Warning

When the symbol and message appear after starting the engine, or if it comes on while driving, it indicates that the fuel level is down to the reserve quantity of approximately: 2.6 gal (10 liters).

Tachometer

Red marking on tachometer:
Excessive engine speed.

Avoid this engine speed, as it may result in serious engine damage that is not covered by the Mercedes-Benz Limited Warranty.

For engine protection, the fuel supply is interrupted if the engine is operated within the red marking.

Outside Temperature Indicator

The temperature sensor is located in the front bumper area. Due to its location, the sensor can be affected by road or engine heat during idling or slow driving. This means that the accuracy of the displayed temperature can only be verified by comparison to a thermometer placed next to the sensor, not by comparison to external displays (e.g. bank signs etc.).

Adaptation to ambient temperature takes place in steps and depends on the prevailing driving conditions (stop-and-go or moderate, constant driving) and amount of temperature change.

Warning!

The outside temperature indicator is not designed to serve as an Ice-Warning Device and is therefore unsuitable for that purpose. Indicated temperatures just above the freezing point do not guarantee that the road surface is free of ice.

Coolant Temperature Gauge

If the antifreeze mixture is effective to -22°F (-30°C), the boiling point of the coolant in the pressurized cooling system of your vehicle is approx. 266°F (130°C).

During severe operating conditions and stop-and-go city traffic, the coolant temperature may rise close to the red marking.

The engine should not be operated with the coolant temperature in the red zone. Doing so may cause serious engine damage which is not covered by the Mercedes-Benz Limited Warranty.

Warning!

- **Driving when your engine is badly overheated can cause some fluids which may have leaked into the engine compartment to catch fire. You could be seriously burned.**
- **Steam from an overheated engine can cause serious burns and can occur just by opening the engine hood. Stay away from the engine if you see or hear steam coming from it.**

Turn off the engine, get out of the vehicle and do not stand near the vehicle until it cools down.

Low Engine Coolant Level Warning

When the symbol and message appear while driving, then the coolant level has dropped below the required level. If no leaks are noticeable and the engine temperature does not increase, continue to drive to the nearest service station and have coolant added to the coolant system (see Index).

The low engine coolant level warning should not be ignored. Extended driving with the symbol displayed may cause serious engine damage not covered by the Mercedes-Benz Limited Warranty.

In cases of major or frequent minor coolant loss, have the cooling system checked at your authorized Mercedes-Benz dealer as soon as possible.

Note:

Do not drive without coolant in the cooling system. The engine will overheat causing major engine damage. Monitor the coolant temperature gauge while driving.

Warning!

Do not spill antifreeze on hot engine parts. Antifreeze contains ethylene glycol which may burn if it comes into contact with hot engine parts. You can be seriously burned.

Low Windshield and Headlamp Washer System Fluid Level Warning

When the symbol and message appear while the engine is running, the level of the reservoir has dropped to approx. $\frac{1}{3}$ of the total volume. The reservoir should be refilled with MB Windshield Washer Concentrate "S" and water (or commercially available premixed windshield washer solvent/antifreeze, depending on ambient temperature - see Index) at the next opportunity. The reservoir for the windshield and headlamp washer systems is located in the engine compartment.

Exterior Lamp Failure Indicator

When the symbol and message appear after starting the engine, or if it comes on while driving, this symbol indicates a failure in the parking lamp, taillamps, stop lamp, or low beam headlamp. If an exterior lamp fails, the indicator symbol will come on only when that lamp is switched on.

If a brake lamp fails, the lamp failure indicator will come on when applying the brake and stays on until the engine is turned off.

Note:

If additional lighting equipment is installed (e.g. auxiliary headlamps etc.) be certain to connect into the fuse before the failure indicator monitoring unit in order to avoid damaging the system.

Brake Pad Wear Indicator

When the symbol and message appear during braking, this indicates that the brake pads are worn down.

Have the brake system checked at your authorized Mercedes-Benz dealer as soon as possible.

Brake Warning

When the brake warning lamp and message appear while the engine is running, this means:

- there is insufficient brake fluid in the reservoir (engine running and parking brake released), or
- the parking brake is set (engine running).

Warning!

Driving with the brake warning lamp illuminated can result in an accident. Have your brake system checked immediately if the brake warning lamp stays on. Don't add brake fluid before checking the brake system. Overfilling the brake fluid reservoir can result in spilling brake fluid on hot engine parts and the brake fluid catching fire. You can be seriously burned.

Note:

If you find that the minimum mark on the brake fluid reservoir is reached, have the brake system checked for brake pad thickness and leaks.

Antilock Brake System (ABS)

Important!

The ABS improves steering control of the vehicle during braking maneuvers. Do not pump the brake pedal, rather use firm, steady brake pedal pressure. Pumping the brake pedal defeats the purpose for ABS and significantly reduces braking effectiveness.

The ABS prevents the wheels from locking up above a vehicle speed of approximately 5 mph (8 km/h) independent of road surface conditions.

At the instant one of the wheels is about to lock up, a slight pulsation can be felt in the brake pedal, indicating that the ABS is in the regulating mode. Keep firm and steady pressure on the brake pedal while experiencing the pulsation.

On slippery road surfaces, the ABS will respond even with light brake pedal pressure because of the increased likelihood of locking wheels. The pulsating brake pedal can be an indication of hazardous road conditions and functions as a reminder to take extra care while driving.

ABS Control

The ABS malfunction indicator lamp in the instrument cluster comes on with the electronic key in steering lock position 2 and should go out with the engine running.

When the ABS malfunction indicator lamp symbol and warning in the instrument cluster come on while the engine is running, it indicates that the ABS has detected a malfunction and has switched off. In this case, the brake system functions in the usual manner, but without antilock assistance.

With the ABS malfunctioning, the BAS, ASR or ESP, if vehicle so equipped, are also switched off. Both malfunction indicator lamps come on with the engine running.

If the charging voltage falls below 10 volts, the malfunction indicator lamp comes on and the ABS is switched off. When the voltage is above this value again, the malfunction indicator lamp should go out and the ABS should be operational. Have the system checked at your authorized Mercedes-Benz dealer as soon as possible.

Warning!

ABS cannot prevent the natural laws of physics from acting on the vehicle, nor can it increase the traction made available by the road conditions. The ABS cannot prevent accidents, including those resulting from excessive speed in turns, following another vehicle too closely, or aquaplaning. Only a safe, attentive, and skillful driver can prevent accidents. The capabilities of an ABS equipped vehicle must never be exploited in a reckless or dangerous manner which could jeopardize the user's safety or the safety of others.

Note:

To alert following vehicles to slippery road conditions you discover, operate your hazard warning flashers as appropriate.

Electronic Traction System (ETS)

The ETS improves vehicle traction, especially under slippery road conditions. It engages at vehicle speeds up to approximately 24 mph (40 km/h), and applies the brakes to the spinning drive wheel. At approximately 50 mph (80 km/h), the ETS switches off.

The ETS warning lamp, located in the speedometer dial, starts to flash at any vehicle speed, as soon as the tires lose traction and the wheels begin to spin.

Important!

If the ETS warning lamp flashes:

- during take-off, apply as little throttle as possible,
- while driving, ease up on the accelerator.

Adapt your speed and driving to the prevailing road conditions.

ETS Control

If the yellow ETS malfunction indicator lamp comes on while the ETS warning symbol flashes, with the engine running, the electronic traction system is being switched off temporarily to prevent overheating of the drive wheel brakes.

If the ETS malfunction indicator lamp comes on with the engine running, a malfunction has been detected.

Have the ETS checked at your authorized Mercedes-Benz dealer as soon as possible.

With the ABS malfunctioning, the ETS is also switched off.

Caution!

If the vehicle is towed with the front axle raised (see *Towing the vehicle* in Index), or when testing the parking brake on a brake test dynamometer, the engine must be shut off. Otherwise, the electronic traction system will immediately be engaged and will apply the rear wheel brakes.

Note:

In winter operation, the maximum effectiveness of the electronic traction system is only achieved with Mercedes-Benz recommended M+S radial-ply tires and/or snow chains.

Acceleration Slip Regulation (ASR)

The acceleration slip regulation will engage at all vehicle speeds, if one or both drive wheels begin to lose traction and spin due to excessive acceleration. While engaged, the yellow warning lamp in the speedometer flashes.

With the acceleration slip regulation engaged, the brake is applied to the spinning drive wheel until it regains sufficient traction. If both drive wheels lose traction and spin, the brake is applied to both drive wheels and simultaneously, engine torque is limited, to improve the vehicle's driving stability.

As traction on the road surface increases, the allowable engine torque also increases again and the brake is no longer applied to drive wheels.

Important!

If the ASR warning lamp flashes, adapt your speed and driving to the prevailing road conditions.

Caution!

If the vehicle is towed with the front axle raised (see *Towing the vehicle* in Index), the engine must be shut off. Otherwise, the acceleration slip regulation will immediately be engaged and will apply the rear wheel brakes.

Notes:

If the ASR malfunction indicator lamp comes on with the engine running, a malfunction has been detected. Pressing the accelerator pedal will require greater effort. Only partial engine output is available.

Have the ASR checked at your authorized Mercedes-Benz dealer as soon as possible.

With the ABS malfunctioning, the ASR is also switched off.

Driving the vehicle with varied size tires will cause the wheels to rotate at different speeds, therefore the acceleration slip regulation may activate (yellow ASR warning lamp in instrument cluster comes on). For this reason, all wheels, including the spare wheel, must have the same tire size.

When testing the parking brake on a brake test dynamometer, the engine must be shut off. Otherwise, the acceleration slip regulation will immediately be engaged and will apply the rear wheel brakes.

In winter operation, the maximum effectiveness of the acceleration slip regulation is only achieved with Mercedes-Benz recommended M+S radial-ply tires and/or snow chains.



ASR control switch located in center console

ASR Control Switch

ASR control switch located on center console

To improve the vehicle's traction when driving with snow chains, or starting off in deep snow, sand or gravel, press the upper half of the ASR switch. The ASR warning lamp, located in the speedometer dial, is continuously illuminated.

With the ASR system switched off, the engine torque reduction feature is cancelled. Therefore, the enhanced vehicle stability offered by ASR is unavailable.

Adapt your speed and driving to the prevailing road conditions.

A portion of the ASR system remains active, even with the switch in the OFF position.

If one drive wheel loses traction and begins to spin, the brake is applied until the wheel regains sufficient traction. The traction control engages at vehicle speeds up to approximately 24 mph (40 km/h), and switches off at 50 mph (80 km/h).

The ASR warning lamp, located in the speedometer dial, starts to flash at any vehicle speed as soon as the tires lose traction and the wheels begin to spin.

To return to the enhanced vehicle stability offered by ASR: press lower half of the switch (the ASR warning lamp in the speedometer dial goes out).

Important!

If the ASR warning lamp flashes:

- during take-off, apply as little throttle as possible,
- while driving, ease up on the accelerator.

Electronic Stability Program (ESP) Model E 420 (optional)

The ESP enhances directional control and reduces driving wheel spin of the vehicle under any driving condition.

Over/understeering of the vehicle is counteracted by applying brakes to the appropriate wheel to create a counterpointing vehicle movement. The ESP warning lamp, located in the speedometer dial, starts to flash.

Important!

If the ESP warning lamp flashes, adapt your speed and driving to the prevailing road conditions.

Caution!

If the vehicle is towed with the front axle raised (see *Towing the vehicle* in Index), the engine must be shut off (electronic key in steering lock position 0 or 1). Otherwise, the ESP will immediately be engaged and will apply the rear wheel brakes.

Notes:

If the ESP malfunction indicator lamp comes on with the engine running, a malfunction has been detected. It is possible that now only partial engine output is available.

Have the ESP checked at your authorized Mercedes-Benz dealer as soon as possible.

With the ABS malfunctioning, the ESP is also switched off.

Driving the vehicle with varied size tires will cause the wheels to rotate at different speeds, therefore the ESP may activate (yellow ESP warning lamp in speedometer dial comes on). For this reason, all wheels, including the spare wheel, must have the same tire size.

When testing the parking brake on a brake test dynamometer, the engine must be shut off. Otherwise, the ESP will immediately be engaged and will apply the rear wheel brakes.

In winter operation, the maximum effectiveness of the ESP is only achieved with Mercedes-Benz recommended M+S rated radial-ply tires and/or snow chains.



ESP control switch located on center console

ESP Control Switch

To improve the vehicle's traction when driving with snow chains, or starting off in deep snow, sand or gravel, press the upper half of the ESP switch. The ESP warning lamp, located in the speedometer dial, is continuously illuminated.

With the ESP system switched off, the engine torque reduction feature is cancelled. Therefore, the enhanced vehicle stability offered by ESP is unavailable.

Adapt your speed and driving to the prevailing road conditions.

A portion of the ESP system remains active, even with the switch in the OFF position.

If one drive wheel loses traction and begins to spin, the brake is applied until the wheel regains sufficient traction. The traction control engages at vehicle speeds up to approximately 24 mph (40 km/h), and switches off at 50 mph (80 km/h).

The ESP warning lamp, located in the speedometer dial, starts to flash at any vehicle speed as soon as the tires lose traction and the wheels begin to spin.

To return to the enhanced vehicle stability offered by ESP: press lower half of the switch (the ESP warning lamp in the speedometer dial goes out).

Important!

If the ESP warning lamp flashes:

- during take-off, apply as little throttle as possible,
- while driving, ease up on the accelerator.

Emission Control

Certain systems of the engine serve to keep the toxic components of the exhaust gases within permissible limits required by law.

These systems, of course, will function properly only when maintained strictly according to factory specifications. Any adjustments on the engine should, therefore, be carried out only by qualified Mercedes-Benz authorized dealer technicians. Engine adjustments should not be altered in any way. Moreover, the specified service jobs must be carried out regularly according to Mercedes-Benz servicing requirements. For details refer to the Service Booklet.

Warning!

Inhalation of exhaust gas is hazardous to your health. All exhaust gas contains carbon monoxide, and inhaling it can cause unconsciousness and lead to death.

Do not run the engine in confined areas (such as a garage) which are not properly ventilated. If you think that exhaust gas fumes are entering the vehicle while driving, have the cause determined and corrected immediately. If you must drive under these conditions, drive only with at least one window fully open.

On-Board Diagnostic System

Vehicles with Diesel engine

When the "CHECK ENGINE" malfunction indicator lamp comes on while the engine is running, this indicates a malfunction in the fuel injection system. Only partial engine output is available. Have the system checked at your authorized Mercedes-Benz dealer as soon as possible.

Vehicles with gasoline engine

The Sequential Multiport Fuel Injection (SFI) control module monitors emission control components that either provide input signals to or receive output signals from the control module. Malfunctions resulting from interruptions or failure of any of these components are indicated by the "CHECK ENGINE" malfunction indicator lamp in the instrument cluster and are simultaneously stored in the diagnostic module.

If the "CHECK ENGINE" malfunction indicator lamp comes on, have the system checked at your authorized Mercedes-Benz dealer as soon as possible.

An on-board diagnostic connector is located in the passenger compartment near to the parking brake pedal, allowing the accurate identification of system malfunctions through the readout of diagnostic trouble codes.

Winter Driving

Have your vehicle winterized at your authorized Mercedes-Benz dealer before the onset of winter.

- Change the engine oil if the engine contains an oil which is not approved for winter operation. For viscosity (SAE/CCMC class) and filling quantity, see *Capacities: Fuels, Coolants, Lubricants etc.* in Index.
- Check engine coolant anticorrosion/antifreeze concentration.
- Additive for the windshield washer and headlamp cleaning system: Add MB Concentrate "S" to a premixed windshield washer solvent/antifreeze which is formulated for below freezing temperatures (see Index).

- Test battery: Battery capacity drops with decreasing ambient temperature. A well charged battery helps to ensure that the engine can be started, even at low ambient temperatures.
- Tires: We recommend M+S rated radial-ply tires on all four wheels for the winter season. Observe permissible maximum speed for M+S rated radial-ply tires and the legal speed limit.

Note:

In winter operation, the maximum effectiveness of the acceleration slip regulation or of the electronic traction system can only be achieved with M+S radial-ply tires and/or snow chains recommended by Mercedes-Benz. Snow chains maximize performance.

Vehicles with diesel engine –

- For diesel fuels, refer to Index.
- Engine block heater: The engine is equipped with a block heater. The electrical cable may be installed free-of-charge at your authorized Mercedes-Benz dealer by using the coupon in the "Owner's Service and Warranty Policy" booklet. The coupon is valid for 12 months from date of vehicle delivery.

Snow Chains

Use only snow chains that are tested and recommended by Mercedes-Benz. Your authorized Mercedes-Benz dealer will be glad to advise you on this subject.

Chains should only be used on the rear wheels. Follow the manufacturer's mounting instructions.

Snow chains should only be driven on snow covered roads at speeds not to exceed 30 mph (50 km/h). Remove chains as soon as possible when driving on roads without snow.

For tips on driving on slippery winter roads, refer to Index.

Vehicles with Acceleration Slip Regulation (ASR) or Electronic Stability Program (ESP):

When driving with snow chains, press the ASR control switch or the ESP control switch, refer to Index.

Vehicles with Sport Package

Use of snow chains is not permissible with tire size 235/45 ZR 17.

Traveling Abroad

Abroad, there is a widely-spread Mercedes-Benz service network at your disposal. If you plan to travel into areas which are not listed in the index of your dealer directory, you should request pertinent information from your authorized Mercedes-Benz dealer.

Practical Hints

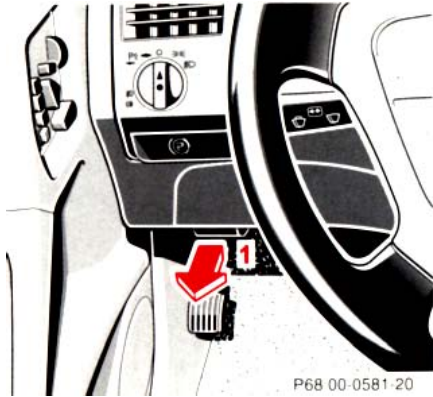

Hood

To open:

To unlock the hood, pull release lever (1) under the driver's side of the instrument panel. At the same time handle (2) will extend out of the radiator grill (it may be necessary to lift the hood up slightly).

Caution!

To avoid damage to the windshield wiper or hood, open the hood only with wiper in the parked position.

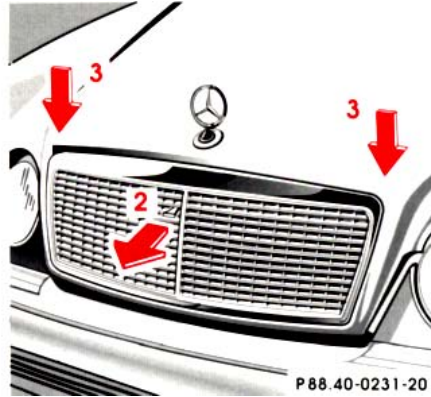

Pull handle (2) completely out of radiator grill and open hood (do not pull upon handle).

To close:

Lower hood and let it drop into lock from a height of approx. 1 ft. (30 cm), assisting with hands placed flat on edges of hood (3).

To avoid hood damage, if hood is not fully closed, repeat closing procedure. Do not push down on hood to attempt to fully close it.

Warning!

To help prevent personal injury, stay clear of moving parts when the hood is open and the engine is running. Be sure the hood is properly closed before driving. When closing hood, use extreme caution not to catch hands or fingers.

Warning!

Vehicles with gasoline engine:

The engine is equipped with a transistorized ignition system. Because of the high voltage it is dangerous to touch any components (ignition coils, spark plug sockets, ignition cables, diagnostic socket) of the ignition system

- with the engine running,
- while starting the engine,
- if ignition is "on" and the engine is turned manually.

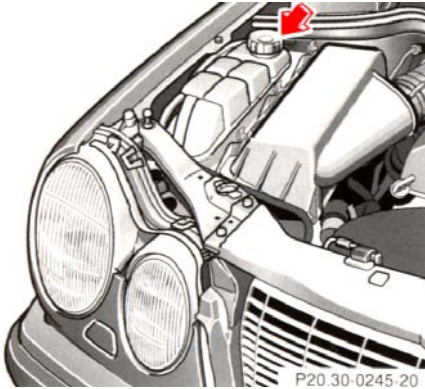

Checking Coolant Level

To check the coolant level, the vehicle must be parked on level ground and the engine stopped.

Check coolant level only when coolant is cold.

Adding Coolant

If coolant has to be added, a 50/50 mixture of water and MB anticorrosion/antifreeze should be added.

The drain plugs for the cooling system are located on the right side of the engine block and at the bottom of the radiator.

Anticorrosion/antifreeze, see *Coolants* in Index.

Warning!

In order to avoid possible serious burns or injury:

- **Use extreme caution when opening the hood if there are any signs of steam or coolant leaking from the cooling system, or if the coolant temperature gauge indicates that the coolant is overheated.**
- **Do not remove pressure cap on coolant reservoir if engine temperature is above 194°F (90°C). Allow engine to cool down before removing cap. The coolant reservoir contains hot fluid and is under pressure.**
- **Using a rag, slowly open cap approximately 1/2 turn to relieve excess pressure. If opened immediately, scalding hot fluid and steam will be blown out under pressure.**
- **Do not spill antifreeze on hot engine parts. Antifreeze contains ethylene glycol which may burn if it comes into contact with hot engine parts.**

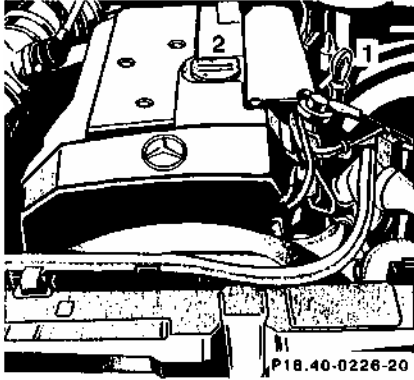

Checking Engine Oil Level

- 1 Oil dipstick
- 2 Oil filler cap

The engine oil level can be checked by either the oil dipstick or via the multifunction indicator in the instrument cluster.

To check the engine oil level, park vehicle on level ground, with engine at normal operational temperature.

Check engine oil level approximately 5 minutes after stopping the engine, allowing for the oil to return to the oil pan.



Oil level must be between the lower (min) and upper (max) mark of the dipstick.

Fill quantity between upper and lower dipstick marking level is approximately 2.1 US qt (2.0 l).

Do not overfill the engine. Excessive oil must be drained or siphoned. It could cause damage to engine and catalytic converter not covered by the Mercedes-Benz Limited Warranty.

For *Low engine oil level warning*, see Index.

Bleeding of Diesel Fuel System

If the engine ran out of fuel, the fuel system has to be purged of air after refilling the tank.

Turn the key in steering lock fully to the right and crank engine (for up to 40 seconds maximum). Only release key after engine fires evenly.

Automatic Transmission Fluid Level

The transmission has a permanent fill of automatic transmission fluid. Regular automatic transmission fluid level checks and changes are not required. For this reason the dipstick is omitted.

When noticing fluid loss or gear shifting malfunctions, have your authorized Mercedes-Benz dealer check the transmission fluid level.



Trunk Lamp

If the trunk is to remain open for a long period of time, the trunk lamp can be switched off by pulling out the plunger in the switch (arrow). This prevents the vehicle battery from being discharged. When the trunk lid is closed, the switch will reset and turn on the lamp next time the lid is opened.

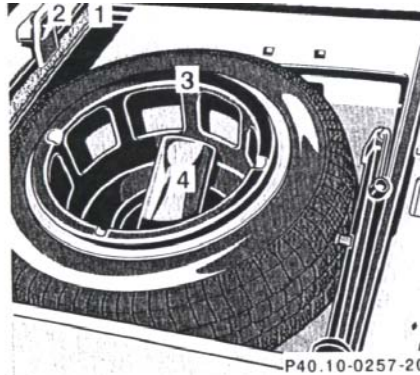

Spare Wheel, Vehicle Tools, Storage Compartment

- 1 Trunk floor
- 2 Handle
- 3 Luggage bowl
- 4 Vehicle tools

Lift trunk floor and engage handle in upper edge of the trunk.

To remove spare tire: Turn luggage bowl counterclockwise and remove. To store spare tire: Place spare tire in wheel well and secure it with luggage bowl. Turn luggage bowl clockwise to its stop.

Note:

Always lower trunk floor before closing trunk lid.

Stowing Things in the Vehicle

Warning!

To help avoid personal injury during a collision or sudden maneuver, exercise care when stowing things. Put luggage or cargo in the trunk if possible. Do not pile luggage or cargo higher than the seat backs. Do not place anything on the shelf below the rear window.



Vehicle Jack

- 1 Jack arm
- 2 Jack base

The vehicle jack is stored behind the spare wheel.

See illustration for proper storage of jack. To remove, first remove vehicle tools and spare wheel. Then open clamp and remove vehicle jack.

Before storing the jack in the spare wheel well, the jack arm must be lowered almost to the base of the jack.

Warning!

The jack is designed exclusively for jacking up the vehicle at the jack tubes built into either side of the vehicle. To help avoid personal injury, use the jack only to lift the vehicle during a wheel change. Never get beneath the vehicle while it is supported by the jack. Keep hands and feet away from the area under the lifted vehicle. Always firmly set parking brake and block wheels before raising vehicle with jack.

Do not disengage parking brake while the vehicle is raised. Be certain that the jack is always vertical when in use, especially on hills. Always try to use the jack on level surface. Be sure that the jack arm is fully inserted in the jack tube. Always lower the vehicle onto sufficient capacity jackstands before working under the vehicle.

Wheels

Replace rims or tires with the same designation, manufacturer and type as shown on the original part. See your authorized Mercedes-Benz dealer for further information.

Warning!

Do not mix different tire construction types (i.e. radial, bias, and bias-belted) on your car because handling may be adversely affected and may result in loss of control.

See your authorized Mercedes-Benz dealer for information on tested and recommended rims and tires for summer and winter operation. They can also offer advice concerning tire service and purchase.

Tire Replacement

Front tires should be replaced in sets. Furthermore - in the event of tire replacement - the spare wheel (except model E 420 with Sport Package), if possible, should be used on the rear axle. Rims and tires must be of the correct size and type. For dimensions, see "Technical Data".

We recommend that you break in new tires for approx. 60 miles (100 km) at moderate speed.

It is imperative that the wheel mounting bolts be retightened after approximately 60-300 miles (100-500 km) whenever wheels are fitted, e.g. when the spare wheel is used for the first time or when a set of wheels with M+S tires is installed.

Tightening torque:
80 ft.lb. (110 Nm).

For rim and tire specifications, refer to "Technical Data".

Warning!

Worn, old tires can cause accidents. If the tire tread is badly worn, or if the tires have sustained damage, replace them.

When replacing rims, use only genuine Mercedes-Benz wheel bolts specified for the particular rim type. Failure to do so can result in the bolts loosening and possibly an accident.

Rotating Wheels

The wheels can be rotated according to the degree of tire wear while retaining the same direction of travel.

Rotating, however, should be carried out at the scheduled service intervals, before the characteristic tire wear pattern (shoulder wear on front wheels and tread center wear on rear wheels) becomes visible, as otherwise the driving properties deteriorate.

Important!

Unidirectional tires must always be mounted with arrow on tire sidewall pointing in direction of vehicle forward movement.

Notes:

Thoroughly clean the inner side of the wheels any time you rotate the wheels or wash the vehicle underside.

The use of retread tires is not recommended. Retread tires may adversely affect the handling characteristics and safety of the vehicle.

Dented or bent rims can cause tire pressure loss and damage to the tire beads. For this reason, check rims for damage at regular intervals. The rim flanges must be checked for wear before a tire is mounted. Remove burrs, if any.

Check and ensure proper tire inflation pressure after rotating the wheels. For *Tire Inflation Pressure* refer to Index.

Warning!

The jack is designed exclusively for jacking up the vehicle at the jack tubes built into either side of the vehicle. To help avoid personal injury, use the jack only to lift the vehicle during a wheel change. Never get beneath the vehicle while it is supported by the jack. Keep hands and feet away from the area under the lifted vehicle. Always firmly set parking brake and block wheels before raising vehicle with jack.

Do not disengage parking brake while the vehicle is raised. Be certain that the jack is always vertical when in use, especially on hills. Always try to use the jack on level surface. Be sure that the jack arm is fully inserted in the jack tube. Always lower the vehicle onto sufficient capacity jackstands before working under the vehicle.

Spare Wheel for Sport Package

The spare wheel rim size is 7 $\frac{1}{2}$ Jx16 H 2 with tire size 215/55 R 16 93 H.

In the case of a flat tire or breakdown, you may temporarily use a 7 $\frac{1}{2}$ J x 16 H 2 instead of the 8 J x 16 H 2 wheel rim on the rear axle, when observing the following restrictions:

- Do not exceed vehicle speed of 50 mph (80 km/h).
- Drive to the nearest repair facility.

For additional information, refer to "Technical Data".

Changing Wheels

Move vehicle to a level area which is a safe distance from the roadway.

1. Set parking brake and turn on hazard warning flasher.
2. Move selector lever to position "P" and turn off engine.

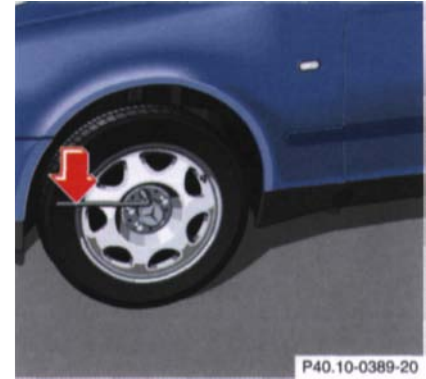

3. Prevent vehicle from rolling away by blocking wheels with wheel chocks (not supplied with vehicle) or sizable wood block or stone. When changing a wheel on a hill, place chocks on the downhill side blocking both wheels of the other axle. On a level road, place one chock in front of and one behind the wheel that is diagonally opposite to the wheel being changed.
4. Using the wrench, loosen but do not yet remove the wheel bolts.

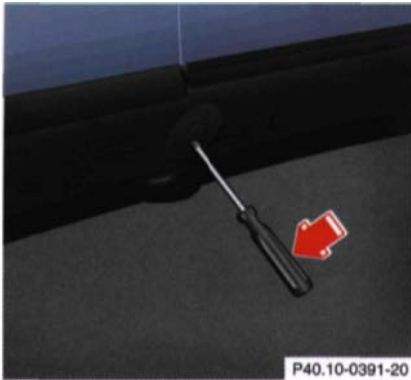

5. Remove the protective cover from the jack support tube opening by inserting the screwdriver (supplied in the tool kit) in the opening and prying it out.

The tube openings are located directly behind the front wheel housings and in front of the rear wheel housings.



6. Insert jack arm fully into the tube hole up to the stop. Place jack on firm ground. Position the jack so that it is always vertical (plumb-line) as seen from the side (see arrow), even if the vehicle is parked on an incline.
7. Jack up the vehicle until the wheel is clear of the ground. Never start engine while vehicle is raised.



8. Unscrew upper-most wheel bolt and install alignment bolt (1) supplied in the tool kit. Remove the remaining bolts. Keep bolt threads protected from dirt and sand.
9. Remove wheel. Grip wheel from the sides. Keep hands from beneath the wheels.

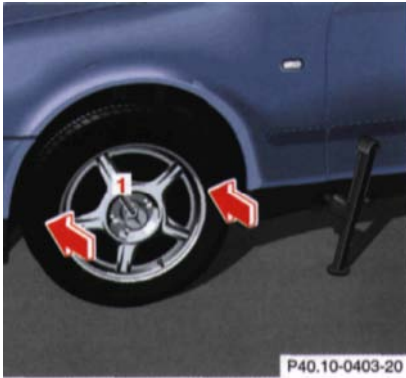

10. Clean contact surfaces of wheel and wheel hub. Install spare wheel on wheel hub. Insert wheel bolts and tighten them slightly.
To avoid paint damage, place wheel flat against hub and hold it there while installing first wheel bolt.
Unscrew the alignment bolt (1) to install the last wheel bolt.
11. Lower car. Remove jack and insert jack tube cover.

Before storing the jack, the jack arm must be lowered almost to the base of the jack.



Warning!

Always replace wheel bolts that are damaged or rusted.

Never apply oil or grease to wheel bolts.

Damaged wheel hub threads should be repaired immediately.

Incorrect mounting bolts or improperly tightened mounting bolts can cause the wheel to come off. This could cause an accident. Be sure to use the correct mounting bolts.

12. Using the wrench, tighten the five bolts evenly, following the sequence illustrated, until all bolts are tight.

Observe a tightening torque of 80 ft.lb. (110 Nm).

13. Ensure proper tire pressure.

Important!

When installing new wheels the mounting bolts must be retightened after approx. 60 - 300 miles (100 to 500 km).

Tire Inflation Pressure

A table (see fuel filler flap) lists the tire inflation pressures specified for Mercedes-Benz recommended tires as well as for the varying operating conditions.

Important!

Tire pressure changes by approx. 1.5 psi (0.1 bar) per 18°F (10°C) of air temperature change. Keep this in mind when checking tire pressure inside a garage - especially in the winter.

Example:

If garage temperature = approx. +68°F (+20°C) and ambient temperature = approx. +32°F (0°C) then the adjusted air pressure = specified air pressure +3 psi (+0.2 bar).

Tire pressures listed for light loads are minimum values offering high driving comfort. Increased inflation pressures for heavy loads produce favorable handling characteristics with lighter loads and are perfectly permissible.

The ride of the vehicle, however, will become somewhat harder.

Tire temperature and pressure increase with the vehicle speed. Tire pressure should therefore only be corrected on cold tires. Correct tire pressure in warm tires only if pressure has dropped below the pressure listed in the table and the respective operating conditions are taken into consideration.

An underinflated tire due to a slow leak (e.g. due to a nail in the tire) may cause damage such as tread separation, bulging etc.. Regular tire pressure checks (including the spare tire) at intervals of no more than 14 days are therefore essential.

If a tire constantly loses air, it should be inspected for damage.

Warning!

Do not overinflate tires. Overinflating tires can result in sudden deflation (blowout) because they are more likely to become punctured or damaged by road debris, potholes etc.. Follow recommended inflation pressures.

Do not overload the tires by exceeding the specified vehicle capacity weight (as indicated by the label on the driver's door latch post). Overloading the tires can overheat them, possibly causing a blowout.

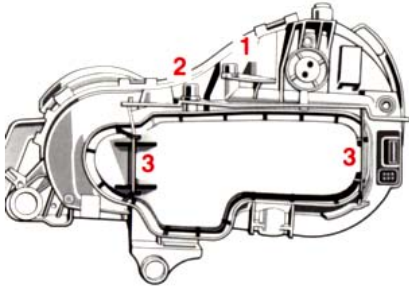

P82.10-0329-20

Exterior Lamps

Headlamp Adjustment

Correct headlamp adjustment is extremely important. Check and readjust headlamps at regular intervals and when a bulb has been replaced.

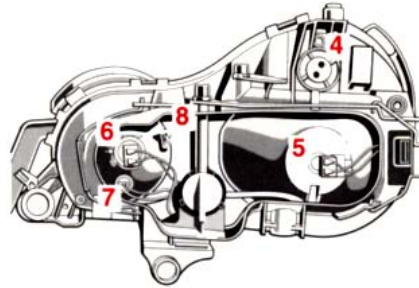

P82.10-0328-20

Headlamp Assembly

- 1 Headlamp horizontal adjustment screw
- 2 Headlamp vertical adjustment screw

- 3 Clamps for headlamp cover
- 4 Bulb socket for turn signal lamp
- 5 Electrical connector for low beam headlamp bulb
- 6 Electrical connector for high beam headlamp bulb
- Xenon lamp (optional) ignition module for low beam
- 7 Bulb socket for parking and standing lamp
- 8 Level for headlamp vertical adjustment

Replacing Bulb:

When replacing bulbs, install only 12 volt bulbs with the specified watt rating.

When replacing halogen bulbs do not touch glass portion of bulb with bare hands. Use plain paper or a clean cloth.

Warning!

Halogen lamps contain pressurized gas. A bulb can explode if you:

- touch or move it when hot,
- drop the bulb,
- scratch the bulb.

Wear eye and hand protection.

Bulbs for Low or High Beam

H7 (55 W)

Open hood.

Move retaining clamps (3) aside and remove cover. Pull off electrical connector (5) or (6). Unhook clamping ring and pull out bulb together with clamping ring. Remove bulb.

Insert new bulb (seating properly in cutouts of bulb socket), mount clamping ring. Reinstall and push electrical connector on securely. Reinstall cover and fasten with retaining clamps (3).

Xenon (optional)

Bulb for Low Beam

Warning!

Because of high voltage in Xenon lamps, it is dangerous to replace the bulb or repair the lamp and its components. We recommend that you have such work done by a qualified technician.

Turn Signal Lamp

1156 NA (26.9/5 W/32/4 cp bulb)

Open hood.

Twist bulb socket (4) counterclockwise and pull out. Push bulb into socket, turn counterclockwise and remove. Insert new bulb in socket, push in and twist clockwise. Reinstall bulb socket. Reinstall lamp assembly until properly seated.

Parking and Standing Lamp

H 6W (6 W bulb)

Open hood.

Rotate cover (3) counterclockwise and remove.

Twist bulb socket (7) counterclockwise and pull out. Push bulb into socket, turn counterclockwise and remove.

Insert new bulb in socket, push in and twist clockwise. Reinstall bulb socket. Reinstall lamp assembly until properly seated.

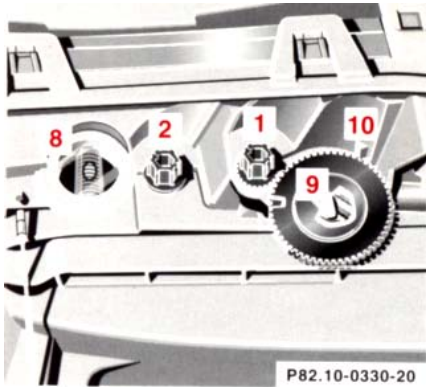

P82.10-0330-20

Adjusting Headlamp

Correct headlamp adjustment is extremely important. To check and readjust a headlamp, follow steps 1 through 7. Please note:

- Low beam adjustments simultaneously aim the high beam.
- Vehicle should have a normal trunk load.
- Vertical aim adjustments change horizontal aim.

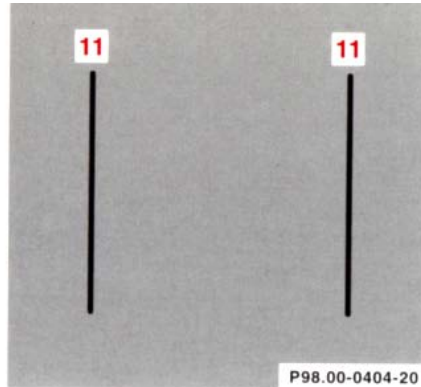

P98.00-0404-20

1. Park vehicle on level surface approx. 6 inches (152 mm) from a vertical test screen or wall. The centerline of the vehicle must be at a 90° angle to the test screen.
2. Using a "T" square and a carpenter's level, align and mark a vertical centerline (8) on the test screen using the outer reference point (low beam) as found on each headlamp lens. As a check, the distance between centerlines should be 49¹/₄ inches (1250 mm).
3. Move vehicle on the level surface 25 feet (7.6 m) straight back from the wall.
4. Open hood.
5. Vertical headlamp aim (low beams on):
Turn adjusting screw (2) (counterclockwise to adjust headlamp downward, clockwise upward) until bubble in the level (8) is centered on the "O" mark.
Graduations: 0.18° pitch.

- Horizontal headlamp aim (low beams on):
Turn adjusting screw (1) (counterclockwise to adjust to the left, clockwise to the right) until the headlamps (low beam) illuminate the test screen as shown. The vertex of the angle formed in each beam image should align with the vertical centerline (11) of each lamp.

The left and right headlamps must be adjusted individually

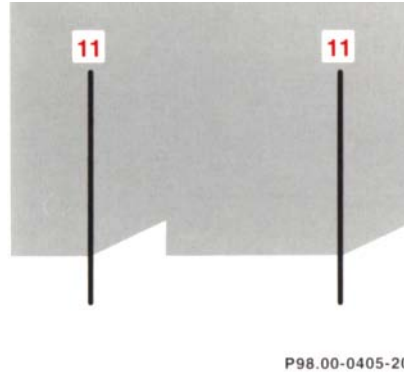

- The "O" on the indicator wheel (9) should align with projection (10). If it does not, with a small screwdriver, pry indicator wheel up and rotate so that the "O" aligns with projection (1). Push down indicator wheel until it snaps in place.

Graduations: 0.38° pitch.

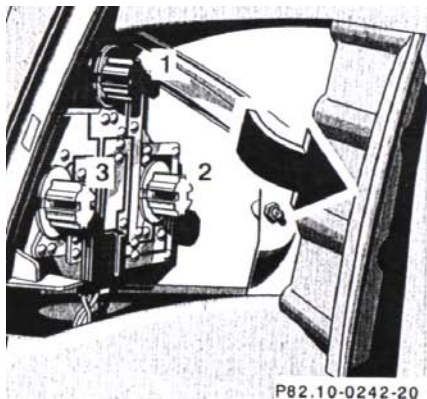

P82.10-0242-20

Taillamp Assemblies

Open trunk lid.

- 1** Turn signal lamp
(21 W/32 cp bulb)
- 2** Stop, tail and parking lamp
(21/4 W/35/1.2 cp bulb)
- 3** Tail, parking and side marker lamp
(5 W/4 cp bulb)

Swing cover aside. Twist bulb socket counterclockwise and pull out. Push bulb into socket, turn counterclockwise and remove.

Insert new bulb in socket, push in and twist clockwise. Reinstall bulb socket, and close cover



P82.10-0252-20

- 4** Driver's side:
Rear fog lamp
(21 W/32 cp bulb)
- 5** Backup lamp
(21 W/32 cp bulb)

Twist bulb socket counterclockwise and pull out. Push bulb into socket, turn counterclockwise and remove.

Insert new bulb in socket, push in and twist clockwise. Reinstall bulb socket.

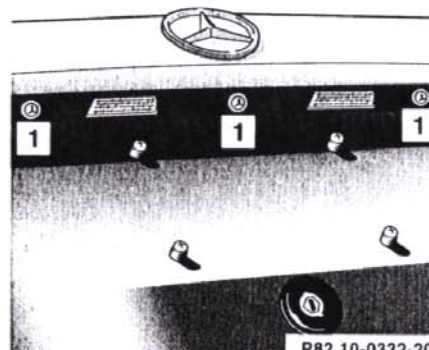

P82.10-0332-20

License Plate Lamps (5 W/4 cp bulb)

Loosen three securing screws (1), remove trunk handle with lamps and take out bulb.



Side Marker Lamp, Front (5 W/4 cp bulb)

From inside wheel house (arrow) reach behind side marker lamp and press tab. Remove lamp from bumper and take out bulb.

Battery

Warning!

Failure to follow these instructions can result in severe injury or death.

Never lean over batteries while connecting, you might get injured.

Battery fluid contains sulfuric acid. Do not allow this fluid to come in contact with eyes, skin or clothing. In case it does, immediately flush affected area with water and seek medical help if necessary.

A battery will also produce hydrogen gas, which is flammable and explosive. Keep flames or sparks away from battery, avoid improper connection of jumper cables, smoking etc..

Important!

Battery replacement information:

The maintenance-free battery is located under the rear seat cushion. To minimize the chance for acid leakage which could cause severe burns during a crash or rollover, a special acid leakage resistant battery was factory installed. A replacement battery for the car must not leak acid when upside down for at least 15 minutes. Your authorized Mercedes-Benz dealer can provide such a special battery.

The service life of the battery is dependent on its condition of charge. The battery should always be kept sufficiently charged, in order to last an optimum length of time.

Therefore, we strongly recommend that you have the battery charge checked frequently, and corrected if necessary, especially if you use the vehicle less than approximately 200 miles (300 km) per month, mostly for short distance trips, or if it is not used for long periods of time.

Only charge a battery with a battery charger after the battery has been disconnected from the vehicle electrical circuit.

Always disconnect the battery negative lead first and connect last.

When removing and connecting the battery, always make sure that all electrical consumers are off and the key is in steering lock position 0. The battery, its filler caps, the vent tube and the opposite plug must always be securely installed when the car is in operation. During removal and installation always protect the disconnected battery positive (+) terminal with the cover attached to the battery.

While the engine is running the battery terminal clamps must not be loosened or detached, otherwise the generator and other electronic components would be damaged.

Notes:

After reconnecting the battery also resynchronize the front seats, front seat head restraints, the Express feature of the power windows, and the Electronic Stability Program (ESP) (see *Power seats, front, Head restraints, Power windows, and Electronic stability program* in Index).

Battery Recycling

Batteries contain materials that can harm the environment with improper disposal.

Large 12 Volt storage batteries contain lead.

Recycling of batteries is the preferred method of disposal.

Many states require sellers of batteries to accept old batteries for recycling.

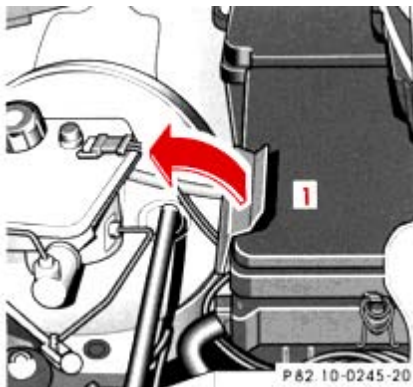

Fuses

Before replacing a blown fuse, determine the cause of the short circuit.

Spare fuses are supplied inside the main fuse box. Observe amperage and color of fuse.

A special fuse puller is supplied with the vehicle tools.

Always use a new fuse for replacement. Never attempt to repair or bridge a blown fuse.

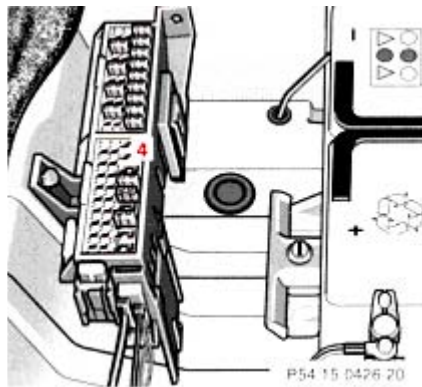

- 1 Main fuse box in engine compartment

To gain access to the main fuse box (1), release clamp (arrow), lift the fuse box cover up and remove it.

To close the main fuse box, engage right end of cover and secure with clamp.

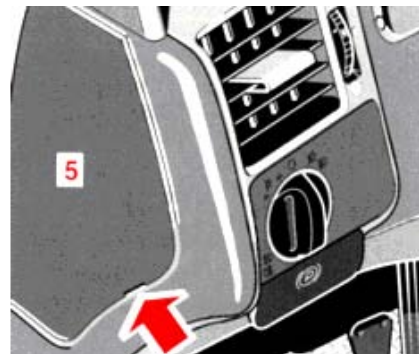

- 2 Auxiliary fuse box below rear seat bench

To gain access, remove rear seat bench. See Index.

- 3 Auxiliary fuse box to left of Exterior lamp switch

To gain access, open door, pry off cover and remove.

Jump Starting

Warning!

Failure to follow these directions will cause damage to the electronic components, and can lead to a battery explosion and severe injury or death.

Never lean over batteries while connecting or jump starting, you might get injured.

Battery fluid contains sulfuric acid. Do not allow this fluid to come in contact with eyes, skin or clothing. In case it does, immediately flush affected area with water, and seek medical help if necessary.

A battery will also produce hydrogen gas, which is flammable and very explosive. Keep flames or sparks away from battery, avoid improper connection of jumper cables, smoking etc..

Read all instructions before proceeding.

If the battery is discharged, the engine should be started with jumper cables and the (12 V) battery of another vehicle.

Jump start the car by using the battery terminals located under hood.

Proceed as follows:

1. Position the vehicle with the charged battery so that the jumper cables will reach, but never let the vehicles touch. Make sure the jumper cables do not have loose or missing insulation.
2. On both vehicles:
 - Turn off engine and all lights and accessories, except hazard warning flashers or work lights.
 - Apply parking brake and shift selector lever to position "P".

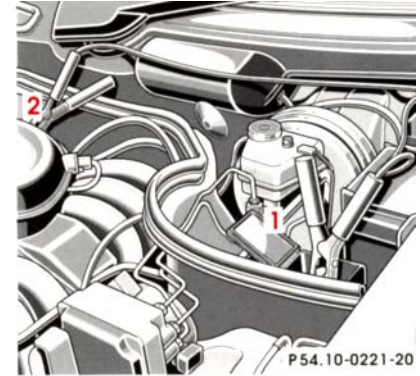

Important!

3. Clamp one end of the first jumper cable to the positive (+) terminal of the discharged battery and the other end to the positive (+) terminal of the charged battery. Make sure the cable clamps do not touch any other metal parts.
4. Clamp one end of the second jumper cable to the grounded negative (-) terminal of the charged battery and the final connection to the negative (-) terminal of the discharged battery.

Important!

5. Start engine of the vehicle with the charged battery and run at high idle. Make sure the cables are not on or near pulleys, fans, or other parts that move when the engine is started. Allow the discharged battery to charge a few minutes. Start engine of the disabled vehicle in the usual manner.
6. After the engine has started, remove jumper cables by exactly reversing the above installation sequence, starting with the last connection made first. When removing each clamp, make sure that it does not touch any other metal while the other end is still attached.

Important!

A discharged battery can freeze at approx. +14°F (-10°C). In that case, it must be thawed out before jumper cables are used. A frozen battery can explode and cause personal injury. Jumper cable specifications:

- Minimum cable cross-section of 25 mm² or approx. 2 AWG
- Maximum length of 11.5ft. (3.5 m).



P88.20-0220-20

Towing the Vehicle

The rear towing eye is located at the right, below the bumper. The front towing eye is located on the passenger side behind a flap in the bumper panel.

Flap removal:

Insert finger in recess of flap and pull flap out.

Flap installation:

Engage flap at bottom and press in top securely.

We recommend that the vehicle be transported using flat bed equipment. This method is preferable to other types of towing.

The vehicle may be towed with all wheels on the ground and the selector lever in position "N" for distances up to 30 miles (50 km) and at a speed not to exceed 30 mph (50 km/h). The electronic key must be in steering lock position 2.

To positively avoid a possibility of damage to the transmission, however, we recommend to disconnect the drive shaft at the rear axle drive flange on any towing beyond a short tow to a nearby garage.

Do not tow with sling-type equipment. Towing with sling-type equipment over bumpy roads will damage radiator and supports.

Use wheel lift, dolly, or flat bed equipment, with electronic key in steering lock turned to position 0.

Warning!

With the engine not running, there is no power assistance for the braking and steering systems. In this case, it is important to keep in mind that a considerably higher degree of effort is necessary to brake and steer the vehicle.

Note:

To signal turns while being towed with hazard warning flasher in use, turn electronic key in steering lock to position 2 and activate combination switch for left or right turn signal in usual manner - only the selected turn signal will operate.

Upon canceling the turn signal, the hazard warning flasher will operate again.

Caution!

Vehicles with Acceleration Slip Regulation (ASR)

If the vehicle is towed with the front axle raised, the engine must be shut off (electronic key in steering lock position 0 or 1). Otherwise, the ASR will immediately be engaged and will apply the rear wheel brakes.

Caution!

Vehicles with Electronic Traction System (ETS)

If the vehicle is towed with one axle raised, the engine must be shut off (key in steering lock position 0 or 1). Otherwise, the ETS will immediately be engaged and will apply the brakes

Cleaning and Care of the Vehicle

Warning!

Many cleaning products can be hazardous. Some are poisonous, others are flammable. Always follow the instructions on the particular container. Always open your car's doors or windows when cleaning the inside.

Never use fluids or solvents that are not designed for cleaning your car.

In operation, your vehicle is subjected to varying external influences which, if gone unchecked, can attack the paint-work as well as the underbody and cause lasting damage.

Such damage is caused not only by extreme and varying climatic conditions, but also by air pollution, road salt, tar, gravel and stone chipping. Grease and oil, fuel, coolant, brake fluid, bird droppings, insects, tree resins etc. should be removed immediately to avoid paint damage.

Frequent washing reduces and/or eliminates the aggressiveness and potency of the above adverse influences.

More frequent washings are necessary to deal with unfavorable conditions; for example, near the ocean, in industrial areas (smoke, exhaust emissions), or during winter operation.

You should check your vehicle from time to time for stone chipping or other damage. Any damage should be repaired as soon as possible to prevent the start of corrosion.

In doing so, do not neglect the underside of the vehicle. A prerequisite for a thorough check is a washing of the underbody followed by a thorough inspection. Damaged areas need to be re-undercoated.

Your vehicle has been treated at the factory with a wax-base rust-proofing in the body cavities which will last for the lifetime of the vehicle. Post-production treatment is neither necessary nor recommended by

Mercedes-Benz because of the possibility of incompatibility between materials used in the production process and others applied later.

We have selected car-care products and compiled recommendations which are specially matched to our vehicles and which always reflect the latest technology. You can obtain Mercedes-Benz approved car-care products at your authorized Mercedes-Benz dealer.

Scratches, corrosive deposits, corrosion or damage due to negligent or incorrect care cannot always be removed or repaired with the car-care products recommended here. In such cases it is best to seek aid at your authorized Mercedes-Benz dealer.

The following topics deal with the cleaning and care of your vehicle and give important "how-to" information as well as references to Mercedes-Benz approved car-care products.

Additional information can be found in the booklet titled "Car Care".

Engine Cleaning

Prior to cleaning the engine compartment make sure to protect electrical components and connectors from the intrusion of water and cleaning agents.

Corrosion protection, such as MB Anticorrosion Wax should be applied to the engine compartment after every engine cleaning. Before applying, all control linkage bushings and joints should be lubricated. The poly-V-belt and all pulleys should be protected from any wax.

Car Washing

Do not use hot water or wash your car in direct sunlight. Use only a mild car wash detergent, such as Mercedes-Benz approved Car Shampoo.

Thoroughly spray the car with a diffused jet of water. Direct only a very weak spray towards the.

ventilation intake. Use plenty of water and rinse the sponge and chamois frequently.

Rinse with clear water and thoroughly wipe dry with a chamois. Do not allow cleaning agents to dry on the finish.

If the vehicle has been run through an automatic car wash - in particular one of the older installations -rewipe the recessed sections in the taillamps (designed to prevent soiling) if necessary. No solvents (fuels, thinners etc.) must be used.

In the winter, thoroughly remove all traces of road salt as soon as possible.

When washing the underbody, do not forget to clean the inner sides of the wheels.

Tar Stains

Quickly remove tar stains before they dry and become more difficult to remove. A tar remover is recommended.

Window Cleaning

Use a window cleaning solution on all glass surfaces. An automotive glass cleaner is recommended.

Headlamps, Taillamps, Turn Signal Lenses

Use a mild car wash detergent, such as Mercedes-Benz approved Car Shampoo, with plenty of water.

To prevent scratches, never apply strong force or use a hard cloth when cleaning the lenses. Do not attempt to wipe dirty lenses with a dry cloth or sponge.

Plastic and Rubber Parts

Do not use oil or wax on these parts.

Wiper Blade

Clean the wiper blade rubber with a clean cloth and detergent solution. Replace blade twice a year; once before and once after winter.

Seat Belts

The webbing must not be treated with chemical cleaning agents. Use only clear, lukewarm water and soap. Do not dry the webbing at temperatures above 176°F (80°C) or in direct sunlight.

Warning!

Do not bleach or dye seat belts as this may severely weaken them. In a crash they may not be able to provide adequate protection.

Hard Plastic Trim Items

Pour Mercedes-Benz approved Interior Care onto soft lint-free cloth and apply with light pressure.

Headliner and Shelf below Rear Window

Clean with soft bristle brush, or use a dry-shampoo cleaner in case of excessive dirt.

Instrument Cluster

Use a gentle dishwashing detergent or mild detergent for delicate fabrics as a washing solution. Wipe with a cloth moistened in lukewarm solution. Do not use scouring agents.

Steering Wheel and Gear Selector Lever

Wipe with a damp cloth and dry thoroughly or clean with Mercedes-Benz approved Leather Care.

Upholstery

Using aftermarket seat covers or wearing clothing that have the tendency to give off coloring (e.g. when wet etc.) may cause the upholstery to become permanently discolored. By lining the seats with a proper intermediate cover, contact-discoloration will be prevented.

Leather Upholstery Wipe leather upholstery with a damp cloth and dry thoroughly or clean with Mercedes-Benz approved Leather Care. Exercise particular care when cleaning perforated leather as its underside should not become wet.

MB Tex Upholstery Pour Mercedes-Benz approved Interior Care onto soft lint-free cloth and apply with light pressure.

Paintwork, Painted Body Components

Mercedes-Benz approved Paint Care should be applied when water drops on the paint surface do not "bead up"; normally in 3 to 5 months, depending on climate and washing detergent used.

Mercedes-Benz approved Paint Cleaner should be applied if paint surface shows signs of dirt embedding (i.e. loss of gloss).

Do not apply any of these products or wax if your car is parked in the sun or if the hood is still hot.

Use the appropriate MB-Touch-Up Stick for quick and provisional repairs of minor paint damage (i.e. chips from stones, car doors etc.).

Light Alloy Wheels

Mercedes-Benz approved Wheel Care should be used for regular cleaning of the light alloy wheels.

If possible, clean wheels once a week with Mercedes-Benz approved Wheel Care, using a soft bristle brush and a strong spray of water.

Follow instructions on container.

Note:

Use only acid-free cleaning materials. The acid could lead to corrosion.

Ornamental Moldings

For regular cleaning and care of very dirty chrome-plated parts, use a chrome cleaner.

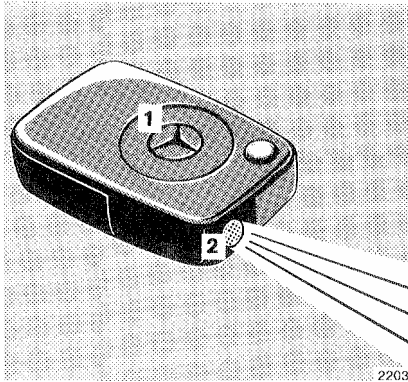

**Testing Infrared Remote Control
Checking Batteries:**

If the transmit button (1) is pressed longer than 1 second, the battery indicator lamp in the transmitter eye (2) briefly illuminates -indicating that the batteries are in order.

Change batteries if the indicator lamp does not come on.

Changing Batteries:

Slide release (3) laterally and pull off battery cover (4).

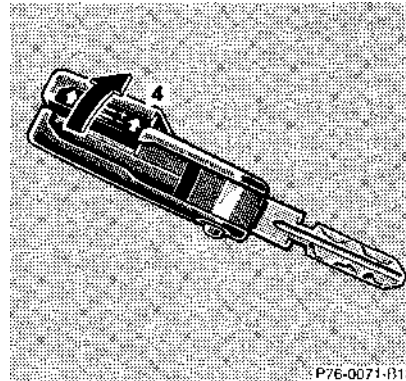

Change batteries, inserting new ones under contact spring (5) with plus (+) side facing up.

Press battery cover onto housing until locked in place.

Important!

Batteries contain materials that can harm the environment if disposed of improperly. Recycling of batteries is the preferred method of disposal. For disposal, please follow manufacturer's recommendation on battery package. Replacement battery: Lithium, type CR 2025 or equivalent.

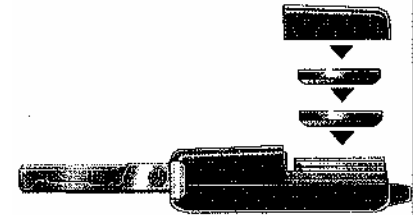

Synchronizing System:

The system may have to be re-synchronized, if the transmitter is without voltage for several minutes.

To synchronize system, aim transmitter eye (2) at inside rear view mirror receiver and briefly press transmit button (1) twice. Within approx. 30 seconds, insert key in steering lock and turn it to position 2.

The infrared remote control should once again be operational.

Front Head Restraints

Warning!

For your protection, drive only with properly positioned head restraints.

Adjust head restraint to support the back of the head approximately at ear level.

Do not drive the vehicle without the seat head restraints. Head restraints are intended to help reduce injuries during an accident.

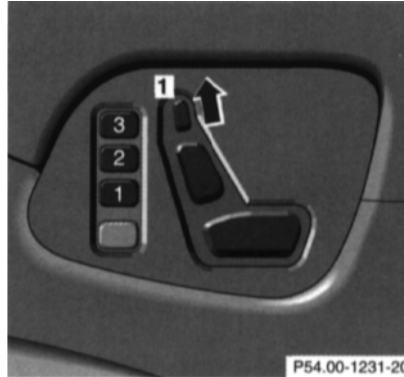

Front seat head restraint, removal

Removal:

Push button (1) up to bring the power adjustable head restraint to its highest position.

Pull out head restraint completely with both hands.

Installation:

Push button (1) of the power adjustable head restraint up for approximately 5 seconds.

Insert the head restraint and push it down to the stop.

Adjust head restraint to the desired position.

For positioning of head restraints refer to sections *Power Seats*, and *Head Restraints, Rear* in Index.

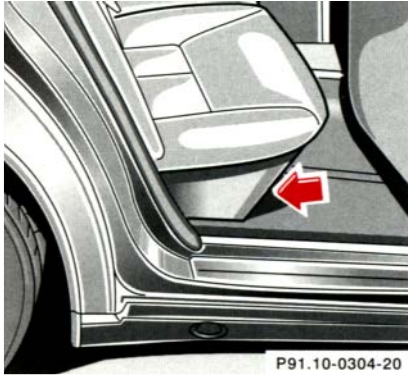

Rear Seat Cushion

Removal: Pull locking tabs up (on left and right side of seat) and lift seat at the front.

Installation: Guide seat belt buckles through openings in seat cushion. Slide rear edge of cushion under the backrest as far as it will go, and push front of cushion down until it locks in place.

Caution!

Watch out for sharp edges when removing or installing the rear seat cushion, and make sure that it is securely locked in place again, to prevent personal injury.



Emergency Operation of Sliding/Pop-Up Roof

The sliding/pop-up roof can be opened or closed manually should an electrical malfunction occur.

The sliding/pop-up roof drive is located behind the lens of the left interior lamp between the sun visors.

1. Pry off lens (1) by using a screw driver.
2. Obtain crank (2) (supplied with vehicle) and insert it through hole.



To slide the roof closed or to raise the roof at the rear: turn crank clockwise.

To slide the roof open or to lower the roof at the rear: turn crank counterclockwise.

Replacing Wiper Blade Insert

For safety reasons, remove electronic key from steering lock before replacing the wiper blade, otherwise the motor can suddenly turn on and cause injury.

Notes:

Do not open engine hood with wiper arm folded forward.

Do not allow the wiper arm to contact the windshield glass without a wiper blade inserted. The glass may be scratched or broken.

Make certain that the wiper blade is properly installed. An improperly installed wiper blade may cause windshield damage.

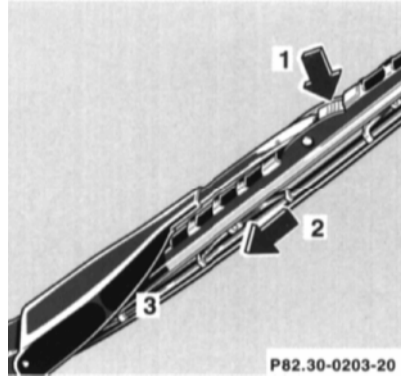

Removal:

Fold wiper arm forward. Press safety tab down (1), push wiper blade downward (2) and remove.

Place wiper blade on firm support. Slide (direction of arrow) the wiper blade insert out of the retainer claws.

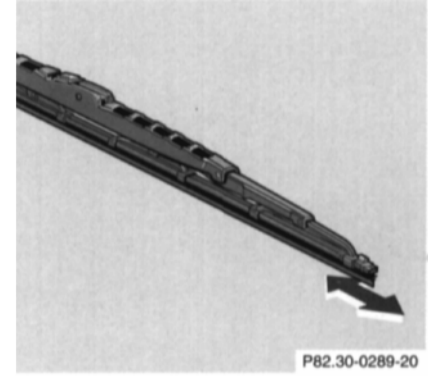

Installation:

Slide (direction of arrow) wiper blade insert into retainer claws until tabs are engaged.

Insert wiper blade between tabs (3) on the wiper arm, and slide into end of wiper arm. Press safety tab upward until it locks in place.

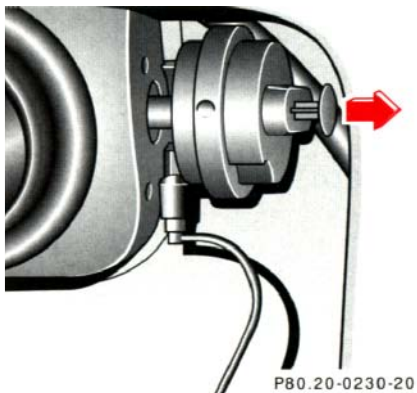

Manual Release of Fuel Filler Flap

The manual release knob is located behind the right side trunk panel.

In case the central locking system does not release the fuel filler flap, pull the manual release knob while simultaneously opening the fuel filler flap.

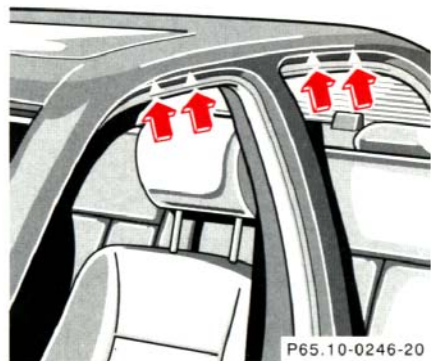

Roof Rack

Use only those roof racks approved by Mercedes-Benz to avoid damage to the vehicle. Follow manufacturer's installation instructions.

Mount supports only between markings on border of roof which are visible when doors are opened.

Spare Parts Service

All authorized Mercedes-Benz dealers maintain a stock of original spare parts required for maintenance and repair work. In addition, strategically located parts distribution centers provide quick and reliable parts service.

More than 300,000 different spare parts, for other Mercedes-Benz models, are available.

Mercedes-Benz original spare parts are subjected to the most stringent quality inspections. Each part has been specifically developed, manufactured or selected for and adapted to Mercedes-Benz vehicles.

Therefore, Mercedes-Benz original spare parts should be installed.

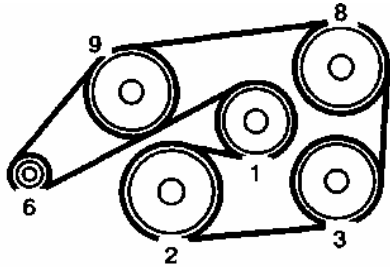

P13.20-0203-20

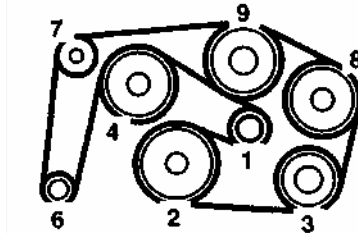

P13.20-0208-20

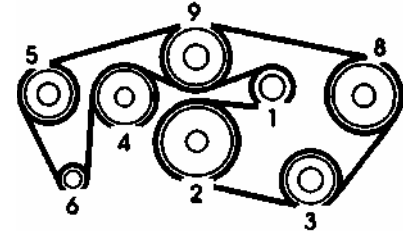

P13.20-0205-20

E 300 DIESEL

Layout of Poly-V-belt Drive

- 1 Automatic belt tensioner
- 2 Crankshaft
- 3 Air conditioning compressor

E 320

- 4 Fan
- 5 Idler pulley
- 6 Generator (alternator)
- 7 Idler pulley
- 8 Power steering pump

E420

- 9 Model E 300 DIESEL: Coolant pump, fan
Models E 320, E 420: Coolant pump

For dimensions of the poly-V-belt, see *Technical Data* in Index.

Technical Data

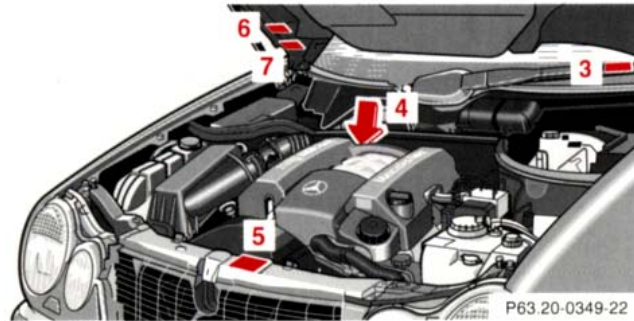
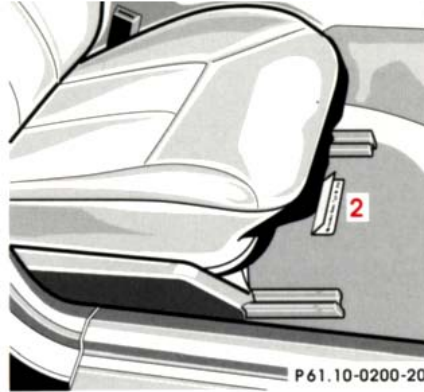

Identification Labels

When ordering spare parts, please specify vehicle identification and engine numbers.

- 1** Certification Label
- 2** Vehicle Identification No. (VIN)
- 3** VIN, visible (lower edge of windshield)
- 4** Engine No.
E 300 Diesel,
E 320
(E 420 only: front right)
- 5** Body No. and Paintwork No.
- 6** Emission Control Label
- 7** Information Label
California version
Vacuum line routing for
emission control system

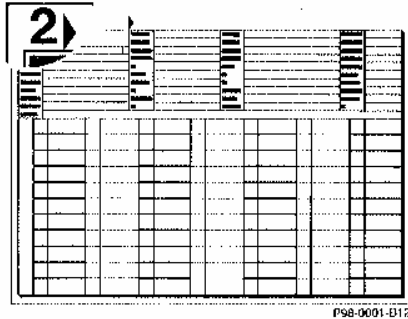

Vehicle Data Card

The vehicle data card contains all important data pertaining to the vehicle. It should be kept in the service booklet where indicated, and it is needed when obtaining replacement or additional keys at your authorized Mercedes-Benz dealer.

Warranty Coverage

Your vehicle is covered under the terms of the "warranties" printed in the Owner's Service and Warranty Information Booklet and your authorized Mercedes-Benz dealer will exchange or repair any defective parts in accordance with the terms of the following warranties:

1. New vehicle limited warranty
2. Emission systems warranty
3. Emission performance warranty
4. California and Massachusetts emission control systems warranty.

Loss of Owner's Service and Warranty Information Booklet

Should you lose your Owner's Service and Warranty Information Booklet, have your authorized Mercedes-Benz dealer arrange for a replacement. It will be mailed to you.

Technical Data

Model E 300 DIESEL (210 020)¹

Engine	606
Mode of operation	Diesel 4-stroke
No. of cylinders	6
Bore	87.00 mm (3.43 in)
Stroke	84.00 mm (3.31 in)
Total piston displacement	2996 m ³ (182.8 cu.in)
Compression ratio	22
Output acc.to SAE J 1349	100 kW/5000 rpm (134 hp/5000 rpm)
Maximum torque acc. to SAE J 1349	210 Nm/2600 rpm (155 ft-lb/2600 rpm)
Maximum engine speed	5450 rpm
Firing order	1-5-3-6-2-4
Poly – V belts length	2140 mm

Rims – Tires

Rims (light alloy rims)	7 ¹ / ₂ J x 16 H 2
Wheel offset	41 mm (1.6 in)
All season tires:	
Radial-ply tires	215/55 R 16 93 H
Winter tires:	
Radial-ply tires	215/55 R 16 93 H M+S

Electrical System

Generator (alternator)	14 V/90 A
Starter motor	12 V/2.2 kW
Battery	12 V/100 Ah

¹ The quoted data apply only to the standard vehicle. See an authorized Mercedes-Benz dealer for the corresponding data of all special bodies and special equipment.

Technical Data

Weights

See certification tag

Roof load max.	100 kg (220 lb)
Trunk load max.	100 kg (220 lb)

Main Dimensions

Overall vehicle length	4810 mm (189.4 in)
Overall vehicle width	1799 mm (70.8 in)
Overall height:	1439 mm (56.7 in)
Wheel base	2833 mm (111.5 in)
Track, front	1529 mm (60.2 in)
Track, rear	1521 mm (59.9 in)

Technical Data E 300 Diesel

Model	E 320 (210 055) ¹
Engine	104
Mode of operation	4-stroke engine, gasoline injection
No. of cylinders	6
Bore	89.90 mm (3.54 in)
Stroke	84.00 mm (3.30 in)
Total piston displacement	3199 m ³ (195.2 cu.in)
Compression ratio	10
Output acc.to SAE J 1349	162 kW/5500 rpm (217 hp/5500 rpm)
Maximum torque acc. to SAE J 1349	315 Nm/3850 rpm (232 ft-lb/3850 rpm)
Maximum engine speed	6400 rpm
Firing order	1-5-3-6-2-4
Poly – V belts length	2445 mm

Rims – Tires

Rims (light alloy rims)	7 1/2 J x 16 H 2
Wheel offset	41 mm (1.6 in)
All season tires:	
Radial-ply tires	215/55 R 16 99 H
Winter tires:	
Radial-ply tires	215/55 R 16 93 H M+S

Electrical System

Generator (alternator)	14 V/90 A
Starter motor	12 V/1.7 kW
Battery	12 V/100 Ah
Spark plugs	Bosch F 8 DPER Beru 14 F-8 DPER
Electrode gap	1.0 mm (0.039 in)
Tightening torque	15-22 ft.lb. (20-30 Nm)

¹ The quoted data apply only to the standard vehicle. See an authorized Mercedes-Benz dealer for the corresponding data of all special bodies and special equipment.

Technical Data E 320

Weights

See certification tag

Roof load max.	100 kg (220 lb)
Trunk load max.	100 kg (220 lb)

Main Dimensions

Overall vehicle length	4810 mm (189.4 in)
Overall vehicle width	1799 mm (70.8 in)
Overall height:	1439 mm (56.7 in)
Wheel base	2833 mm (111.5 in)
Track, front	1529 mm (60.2 in)
Track, rear	1521 mm (59.9 in)

Technical Data

Model	E 420 (210 072) ¹
Engine	119
Mode of operation	4-stroke engine, gasoline injection
No. of cylinders	8
Bore	92.00 mm (3.62 in)
Stroke	78.90 mm (3.11 in)
Total piston displacement	4196 m ³ (256.1 cu.in)
Compression ratio	10
Output acc.to SAE J 1349	205 kW/5700 rpm (275 hp/5700 rpm)
Maximum torque acc. to SAE J 1349	400 Nm/3900 rpm (295 ft-lb/3900 rpm)
Maximum engine speed	6000 rpm
Firing order	1-5-4-8-6-7-2
Poly – V belts length	2510 mm

¹ The quoted data apply only to the standard vehicle. See an authorized Mercedes-Benz dealer for the corresponding data of all special bodies and special equipment.

² Must not be used with snow chains.

Rims – Tires (except Sport Package)

Rims (light alloy rims)	7 1/2 J x 16 H 2
Wheel offset	41 mm (1.6 in)
All season tires: Radial-ply tires	215/55 R 16 99 H
Winter tires: Radial-ply tires	215/55 R 16 93 H M+S

Rims and Summer Tires (Sport Package)

Rims AMG light alloy rims	7 1/2 J x 17 H 2
Wheel offset	35 mm (14 in)
Summer tires: Radial-ply tires	235/45 R ZR 17 ²

Spare Wheel

Rims (light alloy rims)	7 1/2 J x 16 H 2
Wheel offset	41 mm (1.6 in)
Summer tires: Radial-ply tires	215/55 R 16 93 H

Technical Data E 420

Electrical System

Generator (alternator)	14 V/115A
Starter motor	12 V/1.8 kW
Battery	12 V/100 Ah
Spark plugs	Bosch F 8 DPER Beru 14 F-8 DPER
Electrode gap	1.0 mm (0.039 in)
Tightening torque	15-22 ft.lb. (20-30 Nm)

Weights

	See certification tag
Roof load max.	100 kg (220 lb)
Trunk load max.	100 kg (220 lb)

Main Dimensions

Overall vehicle length	4810 mm (189.4 in)
Overall vehicle width	1799 mm (70.8 in)
Overall height:	1439 mm (56.7 in)
Wheel base	2833 mm (111.5 in)
Track, front	1529 mm (60.2 in)
Track, rear	1521 mm (59.9 in)

Fuels, Coolants, Lubricants etc. – Capacities

Vehicle components and their respective lubricants must match. Therefore use only brands tested and recommended by us. Please refer to the Factory Approved Service Products pamphlet, or inquire at your authorized Mercedes-Benz dealer.

	Model	Capacity	Fuels, coolants, lubricants etc.
Engine with oil filter	E 300 Diesel	7.4 US qt (7.0 l)	Recommended engine oils
	E 320		
	E 420	8.5 US qt (8.0 l)	
Automatic transmission	E 300 Diesel	7.5 US qt (7.1 l)	Automatic transmission fluid
	E 320	7.7 US qt (7.3 l)	
	E 420	9.9 US qt (9.4 l)	
Rear axle	E 300 Diesel	1.2 US qt (1.1 l)	Hypoid gear oil SAE 90, 85 W 90
	E 320	1.4 US qt (1.3 l)	
	E 420		
Power steering		approx. 1.1 US qt (1.0 l)	MB Power steering fluid
Front wheel hubs		approx. 2.1 oz (60g) each	High temperature roller bearing grease

	Model	Capacity	Fuels, coolants, lubricants etc.
Accelerator control linkage			Hydraulic fluid
Brake system		approx. 0.5 US qt (0.5 l)	MB Brake fluid (DOT 4)
Windshield washer system		approx. 5.8 US qt (5.5 l)	MB Windshield washer concentrate "S" ¹
Headlamp washer system		approx. 1.9 US qt (1.8 l)	MB Windshield washer concentrate "S" ¹
Cooling system	E 300 Diesel	approx. 10.0 US qt (9.5 l)	MB Anticorrosion/antifreeze
	E 320		
Fuel tank including a reserve of	E 420	approx. 16.4 US qt (15.5 l)	
	E 300 Diesel	approx. 21.1 US gal (80.0 l) approx. 2.6 US gal (10.0 l)	Diesel fuels acc. to ASTM D 975 grades 1-D and 2-D
	E 320	approx. 21.1 US gal (80.0 l)	Premium unleaded gasoline: Posted
	E 420	approx. 2.6 US gal (10.0 l)	Octane 91 (Avg. of 96 RON/86 MON)
Air conditioner system			R-134a refrigerant and special lubricant (<i>Never R-12</i>)

¹ Use MB Windshield Washer Concentrate "S" and water for temperatures above freezing or MB Windshield Washer Concentrate "S" and commercially available premixed windshield washer solvent/antifreeze for temperatures below freezing. Follow suggested mixing ratios, see *Windshield/Headlamp Washer System* in Index.

Engine Oils

Engine oils are specifically tested for their suitability in our engines. Therefore, use only engine oils recommended by Mercedes-Benz. Information on recommended brands is available at your authorized Mercedes-Benz dealer.

Please follow Service Booklet recommendations for scheduled oil changes. Failure to do so could result in engine damage not covered by the Mercedes-Benz Limited Warranty.

Engine Oil Additives

Do not blend oil additives with engine oil. They may be harmful to the engine operation.

Damage or malfunctions resulting from blending oil additives are not covered by the Mercedes-Benz Limited Warranty.

Air Conditioner Refrigerant

R-134a (HFC) refrigerant and special PAG lubricating oil is used in the air conditioner system.

Never use R-12 (CFC) or mineral-based lubricating oil, otherwise damage to the system will occur.

Brake Fluid

During vehicle operation, the boiling point of the brake fluid is continuously reduced through the absorption of moisture from the atmosphere. Under extremely hard operating conditions, this moisture content can lead to the formation of bubbles in the system thus reducing the system's efficiency.

The brake fluid must therefore be replaced every two years, preferably in the spring.

It is recommended to use only brake fluid approved by Mercedes-Benz. Your authorized Mercedes-Benz dealer will provide you with additional information.

Vehicles with Gasoline Engine

Premium Unleaded Gasoline

Caution!

To maintain the engine's durability and performance, premium unleaded gasoline must be used. If premium unleaded is not available and low octane fuel is used, follow these precautions:

- have the fuel tank filled only partially with unleaded regular and fill up with premium unleaded as soon as possible,
- avoid full throttle driving and abrupt acceleration,
- do not exceed an engine speed of 3000 rpm, if the vehicle is loaded with a light load such as two persons and no luggage,
- do not exceed $\frac{2}{3}$ of maximum accelerator pedal position, if the vehicle is fully loaded or operating in mountainous terrain.

Fuel Requirements

Use only Premium unleaded meeting ASTM standard D 439:

The octane number (posted at the pump) must be 91 min. It is an average of both the Research (R) octane number and the Motor (M) octane number: $[(R+M)/2]$. This is also known as ANTI-KNOCK INDEX.

Unleaded gasoline containing oxygenates such as Ethanol, I PA, IBA and TBA can be used provided the ratio of any one of these oxygenates to gasoline does not exceed 10%, MTBE not to exceed 15%.

The ratio of Methanol to gasoline must not exceed 3% plus additional cosolvents.

Using mixtures of Ethanol and Methanol is not allowed. Gasohol, which contains 10% Ethanol and 90% unleaded gasoline, can be used.

These blends must also meet all other fuel requirements such as resistance to spark knock, boiling range, vapor pressure etc..

Gasoline Additives

A major concern among engine manufacturers is carbon build up caused by gasoline. Mercedes-Benz recommends the use of only quality gasoline containing additives that prevent the build up of carbon deposits.

After an extended period of using fuels without such additives, carbon deposits can build up especially on the intake valves and in the combustion area, leading to engine performance problems such as:

- warm-up hesitation,
- unstable idle,
- knocking/pinging,
- misfire,
- power loss.

Do not blend other specific fuel additives with fuel. They only result in unnecessary cost, and may be harmful to the engine operation.

Damage or malfunctions resulting from poor fuel quality or from blending specific fuel additives are not covered by the Mercedes-Benz Limited Warranty.

Vehicles with Diesel Engine Diesel Fuels

Use only commercially available vehicular diesel fuels No. 2 or No. 1 (ASTM D 975 No. 2-D or No. 1-D). If diesel fuels are used with a sulphur content exceeding 0.5% by weight, refer to the "Engine Oil Change and Oil Filter Service" section. Marine diesel fuel, heating oil or the like must not be used.

At very low temperatures the fluidity of No. 2 diesel fuel may become insufficient due to paraffin separation. For this reason the vehicle comes equipped with a fuel preheater. The fuel preheater only works with the vehicles interior heater operating. It permits a troublefree engine operation to a temperature of approximately +14°F (-10°C) when using No. 2 diesel fuel.

To avoid malfunctions, No. 2 diesel fuel of a lowered cloud point is marketed during the cold season.

At temperatures below +14°F (-10°C) use winterized or No. 1 diesel fuel only.

If not available, a certain quantity of kerosene or fuel flow improver (refer to MB Factory Approved Service Products pamphlet) may be added. Mixing only to be done within the cars' fuel tank. Kerosene has to be filled in before the diesel fuel.

Engine power may drop according to the proportion of kerosene. For this reason, keep percentage of kerosene added to the minimum necessitated by the ambient temperature.

The following table can be used as a reference, if adding of kerosene becomes necessary. The mixing ratios shown refer to the total mixture.

Ambient temperature
+14°F to -4°F (-10°C to -20°C)
No. 2 Diesel Fuel: 70%
Kerosene: 30%

Ambient temperature
below -4°F (-20°C)
No. 2 Diesel Fuel: 50%
Kerosene: 50%

Even in extreme climatic conditions, the maximum mixture ratio should not exceed 50%. Adding of kerosene to No. 1 diesel fuel is not recommended even at low temperatures.

Do not blend other specific fuel additives with fuel. They only result in unnecessary cost, and may be harmful to the engine operation. Damage or malfunctions resulting from poor fuel quality or from blending specific fuel additives are not covered by the Mercedes-Benz Limited Warranty.

Warning!

Under no circumstances should gasoline be mixed with diesel fuel.

Always follow basic safety rules when working with any combustible material. Do not fill the fuel tank or mix diesel fuel and kerosene when smoking, near an open flame or while the vehicle's engine is running. An explosion or fire can result.

Coolants

The engine coolant is a mixture of water and anticorrosion/antifreeze, which provides:

- corrosion protection,
- freeze protection,
- boiling protection (by increasing the boiling point).

The cooling system was filled at the factory with a coolant providing freeze protection to approximately -22°F (-30°C) and corrosion protection.

The coolant solution must be used year round to provide the necessary corrosion protection and increase in the boil-over protection. You should have it replaced every 3 years.

To provide the important corrosion protection, the solution must be at least 45% anticorrosion/antifreeze (equals a freeze protection to approx. -22°F [-30°C]). If you use a solution that is more than 55% anticorrosion/antifreeze (freeze protection to approx. -49°F [-45°C]), the engine temperature will increase due to the lower heat transfer

capability of the solution. Therefore, do not use more than this amount of anticorrosion/ antifreeze.

If the coolant level is low, water and MB anticorrosion/antifreeze should be used to bring it up to the proper level (have cooling system checked for signs of leakage).

The water in the cooling system must meet minimum requirements, which are usually satisfied by normal drinking water. If you are not sure about the water quality, consult your authorized Mercedes-Benz dealer.

Anticorrosion/antifreeze

Your vehicle contains a number of aluminum parts. The use of aluminum components in motor vehicle engines necessitates that anticorrosion/ antifreeze coolant used in such engines be specifically formulated to protect the aluminum parts. (Failure to use such anticorrosion/ antifreeze coolant will result in a significantly shortened service life.)

Therefore the following product is strongly recommended for use in your car: Mercedes-Benz Anti corrosion/ Antifreeze Agent.

Before the start of the winter season (or once a year in the hot southern regions), you should have the anticorrosion/antifreeze concentration checked. The coolant is also regularly checked each time you bring your vehicle to your authorized Mercedes-Benz dealer for service.

Anticorrosion/antifreeze quantity

Model	Approx. freeze protection	
E 300 Diesel	-35 °F	-49 °F
E 320	(-37 °C)	(-45 °C)
E 420	5.0 US qt (4.75 l)	5.5 US qt (5.25 l)
	8.2 US qt (7.75 l)	9.0 US qt (8.50 l)

Consumer Information

This has been prepared as required of all manufacturers of passenger cars under Title 49, Code of U.S. Federal Regulations, Part 575 pursuant to the "National Traffic and Motor Vehicle Safety Act of 1966".

Uniform Tire Quality Grading

Refer to the tire sidewall for the specific tire grades for the tires with which this vehicle is equipped.

All passenger car tires must conform to federal safety requirements in addition to these grades.

Treadwear

The treadwear grade is a comparative rating based on the wear rate of the tire when tested under controlled conditions on a specified government test course. For example, a tire graded 150 would wear one and one-half ($1\frac{1}{2}$) times as well on the government course as a tire graded 100. The relative performance of tires depends upon the actual conditions of their use, however, and may depart significantly

from the norm due to variations in driving habits, service practices and differences in road characteristics and climate.

Traction

The traction grades, from highest to lowest, are AA, A, B, and C. Those grades represent the tire's ability to stop on wet pavement as measured under controlled conditions on specified government test surfaces of asphalt and concrete. A tire marked C may have poor traction performance.

Warning!

The traction grade assigned to this tire is based on straight-ahead braking traction tests, and does not include acceleration, cornering, hydroplaning, or peak traction characteristics.

Temperature

The temperature grades are A (the highest), B, and C, representing the tire's resistance to the generation of heat and its ability to dissipate heat when tested under

controlled conditions on a specified indoor laboratory test wheel. Sustained high temperature can cause the material of the tire to degenerate and reduce tire life, and excessive temperature can lead to sudden tire failure. The grade C corresponds to a level of performance which all passenger car tires must meet under the Federal Motor Vehicle Safety Standard No. 109. Grades B and A represent higher levels of performance on the laboratory test wheel than the minimum required by law.

Warning!

The temperature grade for this tire is established for a tire that is properly inflated and not overloaded. Excessive speed, underinflation, or excessive loading, either separately or in combination, can cause excessive heat build up and possible tire failure.

Problems with your Vehicle

If you should experience a problem with your vehicle, particularly one that you believe may affect its safe operation, we urge you to immediately contact your authorized Mercedes-Benz dealer to have the problem diagnosed and corrected if required. If the matter is not handled to your satisfaction, please discuss the problem with the dealership management, or if necessary contact us at the following addresses:

In the U.S.A.: Customer Assistance Center
Mercedes-Benz of North America Inc.
One Mercedes Drive Montvale,
NJ 07645-0350

In Canada: Customer Relations Department
Mercedes-Benz Canada Inc.
849 Eglinton Avenue East Toronto,
Ontario, M4G 2L5

For the U.S.A. only.

The following text is published as required of manufacturers under Title 49, Code of U.S. Federal Regulations, Part 575 pursuant to the "National Traffic and Motor Vehicle Safety Act of 1966".

Reporting Safety Defects

If you believe that your vehicle has a defect which could cause a crash or could cause injury or death, you should immediately inform the National Highway Traffic Safety Administration (NHTSA) in addition to notifying Mercedes-Benz of North America Inc..

If NHTSA receives similar complaints, it may open an investigation, and if it finds that a safety defect exists in a group of vehicles, it may order a recall and remedy campaign. However, NHTSA cannot become involved in individual problems between you, your dealer, or Mercedes-Benz of North America Inc..

To contact NHTSA, you may either call the Auto Safety Hotline toll-free at 1-800-424-9393 (or 366-0123 in Washington, D.C. area) or write to: NHTSA, U.S. Department of Transportation, Washington, D.C. 20590. You can also obtain other information about motor vehicle safety from the Hotline.

Index

ABS [75](#), [84-86](#), [88](#)
Acceleration slip regulation (ASR) [86](#)
Air conditioner refrigerant [136](#)
Air distribution [26](#)
Air volume [26](#) Airbag [49](#)
Alarm system [37](#)
Anticorrosion/antifreeze [91](#), [95](#), [135](#),[139](#)
Antilock brake system (ABS) [84](#)
Antitheft alarm system [37](#)
Armrest, rear bench [42](#)
Ashtrays [60](#)
ASR [84](#),[86-87](#),[92](#),[114](#)
ASR Control Switch [87](#)
Automatic climate control
Activated charcoal filter [25](#), [27](#)
Air recirculation [25](#), [27](#)
 Basic setting [25](#)
 Dust filter [27](#)
 Economy [25](#), [27](#)
 Special setting
 Defogging windows [26](#)
 Defrosting [26](#)
Automatic transmission fluid level [96](#)

Battery [109](#)
Battery charge indicator [79](#)
Battery not being charged
 Charge indicator lamp [79](#)
Brake fluid [18](#), [83](#),[115](#),[135-136](#)
Brake pad wear indicator [83](#)
Brake warning lamp
 Brake fluid low [83](#)
Brakes [18-19](#),[72](#),[74-75](#),[78](#), [85-86](#),[88](#),[114](#)

Capacities: Fuels, coolants, lubricants etc. [134](#)
Catalytic converter [15](#)
Cellular telephone [69](#)
Central locking switch [34](#)
Central locking system [33](#)
Check regularly and before a long trip [150](#)
Child restraint [47](#),[51-53](#)
Cleaning and care of the vehicle [115](#)
Clock, setting [67](#)
Combination switch [55](#)
Consumer information [141](#)
Coolant level low
 Adding coolant [95](#)
Coolant level, checking [95](#)
Coolant temperature gauge [81-82](#)
Coolants [139](#)
Cruise control [77](#)
Cup holder [42](#), [63](#)

Diesel fuel system, bleeding [96](#)
Display illumination [67](#)
Doors [33](#)
Drinking and driving [72](#)
Driving instructions [18](#)
Driving off [72](#)

Electronic stability program (ESP) [88](#)
Electronic traction system (ETS) [85](#)
Emergency tensioning retractor (ETR) [48](#)
Emission control [90](#)
Engine malfunction
 "CHECK ENGINE" malfunction indicator lamp [76](#), [90](#)
Engine oil additives [136](#)
Engine oil consumption [80](#)
Engine oil level low
 Low engine oil level warning lamp [96](#)
Engine oil level, checking [96](#)
Engine oils [134](#), [136](#)
Engine overheating [81](#)
Engine speed limit Overrevving [75](#)
ESP [84](#), [88-89](#)
ETS [84-85](#), [114](#)
Exterior lamp failure indicator [83](#)
Exterior lamp switch [57](#)

First aid kit [42](#)
Front center console compartment ventilation [28](#)
Fuel
 Diesel fuel additives [138](#)
 Diesel fuels [91](#), [135](#), [138](#)
 Gasoline additives [137](#)
 Premium unleaded gasoline [15](#), [135](#), [137](#)
Fuel filler flap, manual release [123](#)
Fuel requirements [138](#)
Fuel reserve warning lamp [80](#)
Fuses [111](#)

Garage door opener [68](#)

Head restraints, front [38](#)
Head restraints, rear [43](#)
Head restraints, removal [120](#)
Headlamp cleaning system [56](#)
Headlights [57](#)
Heated seats [41](#)
Hood [94](#)

Identification plates [126](#)
Indicator lamp symbols [13](#)
Instrument cluster [12](#)
Instrument lamps [67](#)
Interior lighting [62](#)

Jump starting [112](#)

Keys, vehicle [29](#)

Lamps, exterior
 Fog lamps [57](#)
 Headlamp, adjusting [106](#)
 Headlamps [57](#), [83](#), [104](#), [107](#), [116](#)
 License plate lamp [57](#), [108](#)
 Standing lamps [57](#), [64](#)
 Taillamps [57](#), [108](#), [116](#)
Layout of poly-V-belt drive [124](#)
Lighter [61](#)
Locking and unlocking [32](#)
Low engine coolant level warning [82](#)
Low engine oil level warning [80](#)

Maintenance [4](#), [7](#)
Memory
 Recalling [39](#)
 Storing [28](#), [39](#), [59](#), [98](#), [102](#)
Mirror, exterior, rear view [59](#)
Mirror, inside, rear view [58](#)
Mirrors, adjusting [59](#)
Malfunction indicator [13](#)
Multicontour seat [40](#)
Multifunction indicator
 Defective [79](#)
 Language selection [79](#)
Multiple malfunctions [79](#)

Night security illumination [58](#)

Outside temperature indicator [81](#)

Parking brake [16-18](#), [20](#), [60](#), [72-75](#), [83](#), [85-86](#), [88](#), [90](#), [98](#), [100](#), [112](#)
Power seats, front [38](#)
Power windows
 Opening and closing [65](#)
 Synchronizing remote control [119](#)
 Problems with your vehicle [141](#)

Radio transmitters [7](#)
Rear passenger compartment adjustable air outlet [28](#)
Rear seat cushion [121](#)
Rear window defroster [26](#)
Rear window sunshade [66](#)
Remote control, infrared [30](#), [119](#)
Replacing bulbs [105](#)
Residual engine heat utilization [28](#)
Roadside assistance [5](#)
Roof rack [123](#)

Safety guidelines for the seat belt,
emergency tensioning retractor and
airbag [52](#)
Seat belts and warning system [44](#)
Shelf below rear window [43](#)
Side marker lamp [109](#)
Sliding roof
Emergency operation [121](#)
Sliding roof operation [64](#)
Sliding/pop-up roof [36](#)
Snow chains [92](#)
Spare parts service [123](#)
Spare wheel [97](#)
Special Settings [26](#)
SRS malfunction [49](#)
Start lock-out [30](#)
Starting and turning off
diesel engine [17, 54, 90-91](#)
gasoline engine [16, 54, 90, 94](#)
Steering lock [54](#)
Steering wheel, adjustable [42](#)
Storage compartments [63](#)
Stowing things in the vehicle [97](#)
Sun visors [61](#)
Supplemental restraint system (SRS)
[44, 47](#)

Tachometer [80](#)
Technical data [129](#)
Temporarily switching off [79](#)
Tie down hooks [43](#)
Tire inflation pressure [103](#)
Tires [18-20, 85-89, 91, 98-99,](#)
[103, 128, 130, 132, 140](#)
Towing the vehicle [113](#)
Transmission [73](#)
Traveling abroad [92](#)
Trip odometer [67](#)
Trunk [35](#)
Trunk lamp [97](#)
Trunk lid Release switch [65-66](#)
Trunk, separately locked [35](#)
Turn signals [55-56](#)

Vanity mirrors [61](#)
Vehicle data card [128](#)
Vehicle jack [98](#)
Vehicle tools [97](#)
Warranty coverage [127](#)
Washing the car [116](#)
Wheels
Alloy wheels [118](#)
Rims and tires [98-99](#)
Wheels, changing [100](#)
Windshield/headlamp washer system
Fluid level low [82](#)
Washer fluid mixing ratio [56](#)
Winter driving [91](#)
Winter driving instructions [21](#)
Wiper blade insert, replacing [122](#)

Service and Literature

Your authorized Mercedes-Benz dealer has trained technicians and original Mercedes-Benz parts to service your vehicle properly. For expert advice and quality service, see your authorized Mercedes-Benz dealer. If you are interested in obtaining service literature for your vehicle, please contact your authorized Mercedes-Benz dealer.

We consider this to be the best way for you to obtain accurate information for your vehicle.

Warning!

To help avoid personal injury, be extremely careful when performing any service work or repairs. Improper or incomplete service or the use of incorrect or inappropriate parts or materials may damage the vehicle or its equipment, which may in turn result in personal injury.

If you have any question about carrying out some service, turn to the advice of an authorized Mercedes-Benz dealer.

Check Regularly and Before a Long Trip

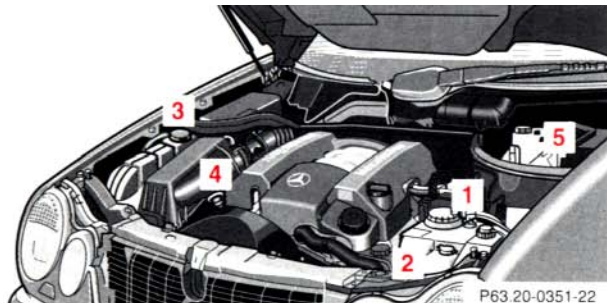

E 320 shown

- 1 Windshield Washer System**
For refilling reservoir see Index
- 2 Headlamp Cleaning System**
Auxiliary tank connected to windshield washer reservoir. Open filler caps on both reservoirs during refilling.
- 3 Coolant Level**
See *Adding coolant* in Index.
- 4 Engine Oil Level**
See *Engine oil level, checking* in Index.
- 5 Brake Fluid**
See *Brake fluid* in Index.

Vehicle Lighting: **Check function and cleanliness. For replacement of light bulbs, see *Lamps, exterior* in Index.**



P88.60-0200-20

• Fuel Supply

Open flap by pushing near front (arrow). Turn fuel cap to the left and hold on to it until possible pressure in tank has been released, then remove cap. Failure to remove slowly could result in personal injury.

Warning!

Gasoline is highly flammable and poisonous. It burns violently and can cause serious injury. Whenever you are around gasoline, avoid inhaling fumes and skin contact, extinguish all smoking materials. Never allow sparks, flame or smoking materials near gasoline!

What You Should Know at the Gas Station

- **Fuel:**

To prevent fuel vapors from escaping into open air, fully insert filler nozzle unit.
Only fill fuel tank until the filler nozzle unit cuts out - do not top up or overfill.
Leaving the engine running and the fuel cap open can cause the "Check Engine" lamp to illuminate.
Use premium unleaded gasoline: Posted Octane Index 91 (Average of 96 RON/86 MON).
Fuel tank capacity approx. 16.4 US gal (62.0 l). This includes approx. 2.1 US gal (8.0 l) reserve.

- **Engine Oil:**

Engine oil level check, see Index.
Fill quantity between upper and lower dipstick marking level: 2.1 US qt (2.0 l).
Recommended engine oils, see Index.

- **Coolant:**

For normal replenishing, use water (potable water quality).
For further information (e.g. anticorrosion/antifreeze), refer to Index.

- **Spark Plugs:**

Approved spark plugs, refer to "Technical Data".

- **Bulbs:**

High and low beams: H7 (55 W), low beam:
Xenon (optional) fog lamps: H1 (55 W),
turn signal lamps, front: 11 56 NA
(26.9/5 W/32/4 cp),
parking and standing lamps, front: H6 W, side marker lamps, front: 5 W/4 cp, turn signal lamps, side: W Y 5 W, stop, tail, parking, and side marker lamps: 21/4 W, turn signal lamps, rear: 21 W/24 cp, tail and parking lamp: 5 W/4 cp, rear fog lamp, driver's side: 21 W/32 cp, backup lamps: 21 W/32 cp, license plate lamps: 5 W/4 cp.

- **Tire Pressure:**

For tire pressure, refer to tire pressure label inside the fuel filler flap.

- **Air Conditioner:**

R-134a refrigerant and special PAG lubricant, refer to "Technical Data" (also see Index).