

# EMC Testing

## Part 5 – Conducted Immunity

By Eur Ing Keith Armstrong C.Eng MIEE MIEEE, Partner, Cherry Clough Consultants,  
Associate of EMC-UK

Tim Williams C.Eng MIEE, Director, Elmac Services, Associate of EMC-UK

This is the fifth in a series of seven bi-monthly articles on 'do-it-yourself' electromagnetic compatibility (EMC) testing techniques for apparatus covered by the EMC Directive (EMCD). This series covers the whole range of test methods – from simple tests for development and fault-finding purposes, through lowest-cost EMC checks; 'pre-compliance' testing with various degrees of accuracy; on-site testing for large systems and installations; to full-specification compliance testing capable of meeting the requirements of national test accreditation bodies. Previous articles are available on-line at [www.compliance-club.com](http://www.compliance-club.com), using the site's Archive Search facility.

What is low-cost to an organisation with 5000 employees could be thought fairly expensive by a company with 50, and might be too expensive for a one-person outfit, but we will cover the complete range of possible costs here so that no-one is left out. It is important to understand, however, that the more you want to save money on EMC testing or reduce the risk of selling non-compliant products, the more EMC skills you will need. *Low cost, low risk and low EMC skills do not go together.*

This series does not cover management and legal issues (e.g. how much testing should be done to ensure compliance with the EMCD). Neither does it necessarily describe how to actually perform EMC tests in sufficient detail to do them. Much more information is available from the test standards themselves and from the references provided at the end of these articles.

The topics covered in these seven articles are:

- 1) Radiated emissions
- 2) Conducted emissions
- 3) Fast transient burst, surge, electrostatic discharge
- 4) Radiated immunity
- 5) Conducted immunity**
- 6) Low frequency magnetic fields emissions and immunity; plus mains dips, dropouts, interruptions, sags, brownouts and swells
- 7) Emissions of mains harmonic currents, voltage fluctuations, flicker and inrush currents; and miscellaneous other tests

### Table of contents for this Part

- 5 Conducted RF immunity
  - 5.1 Non-CE issues with immunity testing
  - 5.2 Introduction to conducted immunity testing
    - 5.2.1 Injecting a reasonably accurate RF voltage (or current)
    - 5.2.2 Preventing leakage
    - 5.2.3 The non-linear sensitivity of analogue and digital semiconductors to RF.
    - 5.2.4 Determining an 'engineering margin'
    - 5.2.5 Monitoring the EUT to be able to tell when its performance has degraded too much.
  - 5.3 Alternative transducers and test methods
    - 5.3.1 [unnecessary repetition] Close-field probes
    - 5.3.2 Voltage injection probe
    - 5.3.3 'Crosstalk' injection techniques
    - 5.3.4 Licensed radio transmitters
    - 5.3.5 Bulk Current Injection (BCI)
    - 5.3.6 Direct injection with a CDN
    - 5.3.7 The 'EM Clamp'
    - 5.3.8 General notes on test set-ups
  - 5.4 Signal generators and power amplifiers
    - 5.4.1 Alternative types of signal generator
    - 5.4.2 RF Power Amplifiers
  - 5.5 Correlating alternative test methods with EN 61000-4-6

- 5.6 On-site testing
- 5.7 Full compliance conducted RF immunity testing
  - 5.7.1 Generator
  - 5.7.2 Transducers
  - 5.7.3 Calibration and levels
  - 5.7.4 Test setup
- 5.8 References

## 5 Conducted RF immunity

Part 0 of this series [1] described the various types of EMC tests that could be carried out, including:

- Development testing and diagnostics (to save time and money)
- Pre-compliance testing (to save time and money)
- Full compliance testing
- 'Troubleshooting' to quickly identify and fix problems with compliance tests, or with interference in the field
- QA testing (to ensure continuing compliance in volume manufacture)
- Testing of changes and variants (to ensure continuing compliance).

And Part 0 also described how to get the best value when using a third-party test laboratory [1].

This part of the series focuses on testing continuous conducted radio-frequency (RF) immunity, sometimes called conducted electromagnetic susceptibility (EMS) to the EN standards for typical domestic / commercial / industrial environments. Other kinds of immunity tests may be required for automotive, aerospace, space, rail, marine and military environments. Over the years these, and other industries, have often developed their own immunity test standards based on their own particular kinds of disturbances, usually for reliability reasons.

**IMPORTANT SAFETY NOTE:** Some of these tests involve electrical hazards, particularly the outputs from RF power amplifiers and the cables, connectors and transducers connected to them, and transducers which make direct connection to the mains supply or other hazardous conductors. Also, performing some of these tests outside a shielded room could create interference problems for other equipment, possibly interfering with aircraft communications, navigational radio beacons, or automatic landing systems so could have safety implications. These tests can be dangerous, and all appropriate safety precautions must be taken. If you don't know what safety precautions to take, ask a competent person.

The basic EN test methods described here are identical to the basic IEC test methods (e.g. EN 61000-4-6 = IEC 61000-4-6), so this article may also be of use where non-EU EMC requirements apply.

### 5.1 Non-CE issues with immunity testing

See Part 4 of this series [2] for more detail on the following important issues for immunity testing:

- Saving costs by early EMC testing (section 4.1).
- Immunity testing for reliability and functional safety (section 4.2).

### 5.2 Introduction to conducted immunity testing

Continuous conducted RF immunity testing involves injecting RF voltages or currents into each of the cables associated with the equipment under test (EUT).

The purpose of the test is to simulate the proximity of the EUT and its connected cables to radio transmitters and RF manufacturing equipment operating at low frequencies. These frequencies are not easy to test using the radiated RF immunity techniques described in [2]. It is hard to generate uniform fields in typical test facilities at frequencies much below 80MHz, but for typical sizes of apparatus the immunity problems at frequencies below 80MHz are normally associated with cable coupling, so conducted testing of the cables is seen as a reasonable alternative to radiated methods at such frequencies. Conducted RF immunity testing is also a lot less costly to do properly than radiated RF immunity, and complete systems for full-compliance testing can be purchased for under £15,000.

EN 61000-4-6 [3] is the basic EMC test method for conducted RF immunity called-up by the latest editions of harmonised product or generic immunity test standards. Alternative conducted test methods described here should always follow the methodology of [3] as far as is practical to help make compliant products.

For small products [3] considers it acceptable to use its conducted tests over the range 150kHz to 230MHz, but for larger products the range is 150kHz to 80MHz. Small products with short cables may not need to be tested to as low a frequency as 150kHz. See Annex B of [3] for more on frequency ranges versus EUT dimensions. But remember that it will be the

relevant EMCD harmonised standard (product or generic) that specifies the frequency range and test levels for a given type of EUT. In general, when self-declaring conformity to the EMCD using the 'standards route' you will not be able to choose your own frequency ranges.

A lack in [3] is that it only injects common-mode RF and does not test differential-mode RF even though it can exist on mains and other types of cables. Differential-mode RF noise is mostly an issue at frequencies under 10MHz, especially when switch-mode power converters and other 'noisy' technologies are powered from the same mains distribution as the product concerned.

A lack in most of the conducted RF test methods is that in real life all the cables associated with a product will be exposed to varying amounts of RF conducted noise simultaneously, but the test methods only inject into one cable at a time. Clearly, it is possible for different interactions to occur when more than one cable has RF on it – and in real life the frequencies on different cables can be different and so cause cross-modulation effects which cannot be simulated by single-frequency testing – so this is a weakness in any of the standardised conducted test methods.

However it is possible to vary the test methods described here to test for differential-mode immunity, and also to test multiple cables at the same time with the same or different RF stimuli, to help ensure reliability in real applications.

There are five main issues in radiated RF immunity testing which are of concern for all the test methods discussed here:

- Injecting a reasonably accurate RF voltage (or current) into the EUT's cables.
- Preventing the tests from 'leaking' and possibly causing interference.
- The non-linear sensitivity of analogue and digital semiconductors to RF.
- Determining a reasonable 'engineering margin'.
- Monitoring the EUT to be able to tell when its performance has degraded too much.

It will help if we discuss these issues before moving on to describe the test methods themselves.

### 5.2.1 Injecting a reasonably accurate RF voltage (or current)

[3] describes how to perform a level-setting procedure (calibration) for each of the three types of test transducers it employs:

- Direct voltage injection using coupling-decoupling networks (CDNs).
- Induced voltage injection using the 'EM Clamp'.
- Induced current injection using 'Bulk Current Injection' (BCI).

The level-setting procedures described in [3] can be adapted for use with many of the alternative test methods described here.

### 5.2.2 Preventing leakage

When RF voltages or currents are injected onto cables, the cables can act as antennas and re-radiate ('leak') them. The CDNs and EM-Clamp transducers recommended by [3] provide significant amounts of decoupling for the (usually long) length of the cable on their 'Ancillary Equipment' side, to prevent leakage from this part of the cables and also to protect the ancillary equipment. With these two kinds of transducers, only the cables on their EUT side have high levels of RF on them, and they are short in any case and so are not usually very efficient antennae below 80MHz.

BCI transducers inject currents equally into the cables on both sides, so significant radiation is possible from the longer cables on the 'Ancillary Equipment' side. This leakage can be reduced by adding a large number of clip-on split-ferrite RF suppressers to the cable on the non-EUT side of the BCI transducer – close to the transducer. Usually a total length of ferrite of at least 200mm is enough.

Some experts recommend that conducted immunity tests are always done inside shielded rooms or shielded tents (no need for any RF absorber if the enclosure is room-sized) to prevent leakage from the cables / EUT from causing interference problems, whilst others seem to find that leakage is low enough not to need a shielded room.

Perhaps the best approach, if a shielded room is not already available, is to consider whether there are sensitive electronics or radio receiver antennas near to where the test is to be conducted; whether the conducted testing is going to use high levels of stimulus (e.g. for 'industrial' equipment); and whether frequencies above 80MHz are going to be applied to large EUTs, or above 230MHz to any size of EUT. If any of these are true it would be best to do these conducted tests inside a shielded room or shielded tent. Tents have the advantage that they are easily movable and can be packed away when not in use.

### 5.2.3 The non-linear sensitivity of analogue and digital semiconductors to RF

The problems of test repeatability would be bad enough if electronic circuits responded linearly to variations in the fields. But both digital and analogue devices respond *non-linearly* (typically a square-law demodulation response, sometimes called rectification). As a result, even small variations in the level of the injected RF voltage or current or in the set-up of the EUT and its cables can make the difference between a good pass and a bad fail.

See section 4.3.2 of Part 4 of this series [2] for more on this issue and its very important implications for test repeatability and engineering margins.

[3] uses a modulated waveform: a 1kHz sine-wave modulation with 80% depth. Because of the non-linear response of analogue and digital circuits due to demodulation an 80% increase in RF level (at the peak of the modulation) can translate into a 224% increase in circuit error. So *all* the alternative test methods described here should use similarly modulated test stimuli.

#### 5.2.4 Determining an 'engineering margin'

Even having [3] fully applied by accredited test laboratories cannot guarantee that a given EUT and its cables will be exposed to *exactly* the same RF stimuli (say, within  $\pm 3\text{dB}$ ) each time it is tested. So, because of the non-linear sensitivity of analogue and digital circuits to RF and because serially-manufactured products have variable immunity performance due to component and assembly tolerances (often uncontrolled for EMC), an 'engineering margin' is recommended.

When testing an example product to [3] in a fully compliant manner, at least a 6dB higher test level (e.g. 6Vrms instead of 3Vrms) is suggested, with the product still meeting its required functional specifications. Where there are significant differences in the test method compared with [3], a much larger engineering margin is recommended, as indicated by Figure 5A.

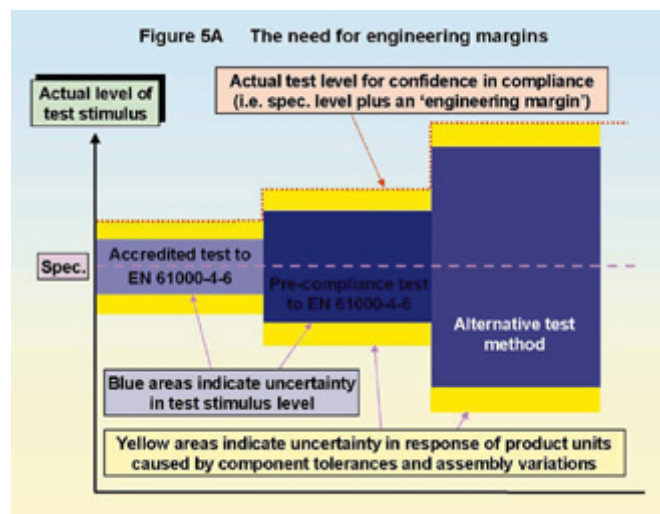

It is clear that saving costs by using alternative radiated immunity test methods can lead to over-engineering. The additional cost to make the product pass the alternative test method with the necessary engineering margins should be weighed against the cost of doing the testing properly.

#### 5.2.5 Monitoring the EUT to be able to tell when its performance has degraded too much

The functional performance degradation allowed during and after conducted RF immunity tests may be specified by product-family standards (e.g. EN 55024), but if applying the generic standards EN 50082-1 or EN 50082-2 all that is necessary is that the performance is no worse than the specification in the manufacturers 'data sheet' for the product – which should represent what its users would find acceptable given the marketing claims for the product.

Thought should be given to how the functional performance of the product is to be tested, especially if it is to be tested in a shielded room with no observers inside. See section 4.3.5 of [2] for more on this.

### 5.3 Alternative transducers and test methods

Alternative conducted RF immunity test transducers and methods can be used for all the six test purposes listed in the introduction to this article. For some test purposes the alternative methods described here will have some advantages over [3].

For all but compliance and 'pre-compliance' tests, using an uncalibrated test (for which the quantitative measurement is not traceable to the national physical standards) is not very important. But it *is* very important for any tests to be *repeatable* – so consistency is required in the test equipment and test methodology. Refer to section 5.5 for more in this.

When doing remedial work after an immunity test failure, you will know which frequencies the EUT fails at and can test at only those frequencies to find the problem areas most quickly. However, when you make any changes to fix the known immunity problems you then need to test over the full frequency range, in case all you have done is 're-tuned' the problems so they appear at different frequencies.

During design or development testing, always try to reproduce the final assembly of the circuit being tested (shielding, earth bonding, proximity to metal objects or structures, etc.), as the stray inductances and capacitances in the final build state can have a dominant effect on the RF behaviour of the circuit. And always carefully record all the details of the test set-up in the test documentation (photographs can be very useful).

### 5.3.1 Close-field probes

The close-field magnetic and electric field probes described in section 1.1 and Figures 1, 2, 3, 4 of [1] can be used as localised sources of disturbances in RF immunity tests. They can be very useful indeed for design and development testing on ICs and PCBs, and for localising the immunity problems discovered on a 'proper' immunity test.

Although loop probes generate local fields rather than inject voltages or current directly into a circuit, they are still effective at discovering which circuits, transistors or ICs will be vulnerable to the conducted RF immunity tests. For frequencies between 10 and 100MHz loop probes will generally need to be around 50mm diameter. At frequencies below 30MHz, multi-turn loop probes can be used to apply higher levels of RF stimulus to the EUT without needing unwieldy probe sizes or powerful amplifiers. See section 4.4.1 of [2] for more detail on using close-field probes.

### 5.3.2 Voltage injection probe

'Pin' probes similar to the one shown in Figure 2 of [1] can be used to inject RF signals directly into conductors and component leads, and are useful for design and development testing on ICs and PCBs, and for identifying the locations of problems that cause compliance test failures.

They will need to use a high-voltage Class Y capacitor when injecting into mains or other high voltages. Use capacitors of around 100nF for frequencies up to 1MHz, 10nF for up to 10MHz, and 1nF for up to 100MHz. If the load that this adds affects the circuit's operation, smaller capacitors should be used (say down to 1nF, 100pF, 10pF respectively) although these may require a higher RF drive voltage at lower frequencies.

For more on using these probes, see section 4.4.2 of [2].

### 5.3.3 'Crosstalk' injection techniques

Another way to inject RF into cables is to drive RF into a length of wire laid close to the cable being injected into, or into a capacitive clamp normally used for fast transient burst testing to EN 61000-4-4, or a length of shielded "Zippertubing", or aluminium or copper foil wrapped around the cable. The capacitive coupling of the wire method might prove inadequate to inject enough current at lower frequencies. For more on this see section 4.4.3 of [2].

### 5.3.4 Licensed radio transmitters

Licensed radio transmitters can be used, providing they operate in the right frequency band for the conducted tests. They should be used in exactly the same way as described in section 4.4.4 of [2] for radiated RF immunity tests, and have the same problems and limitations.

### 5.3.5 Bulk Current Injection (BCI)

BCI is a useful test method as it is so easy to clamp its current-injection transducers (essentially simple RF current transformers) over the cables to be tested. It is a favourite technique in the aerospace, military and automotive industries, and appears as a formal test method in some of their EMC standards (e.g. DO160 for civil aircraft, DEF STAN 59-41 Part 3 test DCS02, available from <http://www.dstan.mod.uk/home.htm> for military equipment; SAE J1113-4 and ISO 11452-4:1995 for motor vehicles). It is also an alternative test method in [3] and its use for compliance testing is described later in this article.

Clearly, aircraft and vehicles don't have mains or data cables trailing behind them, but the aerospace, military, and automotive industries use BCI because it helps them ensure that after they have installed new electronic systems their vehicles will still meet their whole-vehicle radiated immunity tests. They use it as a design/development test tool as much as for final compliance testing.

What they do is to expose their aircraft, battle tank, motor car (or whatever) to RF fields and measure the resulting RF currents in their wiring harnesses. Scaling factors are calculated for each harness [4] so that if the vehicle needs to withstand, say, 30V/m at a given frequency the level of the RF currents in the relevant wiring harnesses can be calculated and used as a test specification for the electronic units which will connect to those harnesses.

The Rover Advanced Technology Centre at Warwick University have produced a software product that will control a BCI test on the cables of an electronic system and analyse the results to give a statistical likelihood of the new system passing a whole vehicle radiated-field test [5], [6].

Clearly, this technique can be used by other industries to help save time and costs in the system integration and compliance stages of a project. It can also be used to help localise compliance test failures down to individual wiring harnesses in an apparatus, and then to the individual electronic units connected to the wiring harness.

The 'traditional' test method for the kind of BCI testing described above is shown in Figure 5B. One RF current transformer (a clip-on device) is used to induce a current in the cable being tested, while a second clipped-on RF current transformer samples the cable's injected RF current and sends a signal to the feedback control circuit of the signal generator or power amplifier to ensure that the specified current is injected regardless of the cable's RF impedance. This type of RF level control is often called a 'levelling loop'.

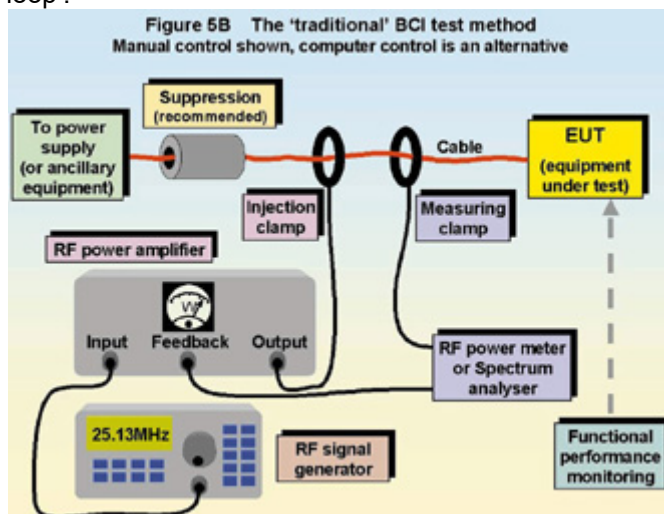

Proprietary BCI transducers from a number of companies (e.g. EMC Hire Ltd) can be used for BCI testing. Figure 5C shows two BCI probes being used on an automotive wiring harness by the Rover Advanced Technology Centre – one probe driven from an RF power amplifier to inject the current and the second probe for the levelling loop.

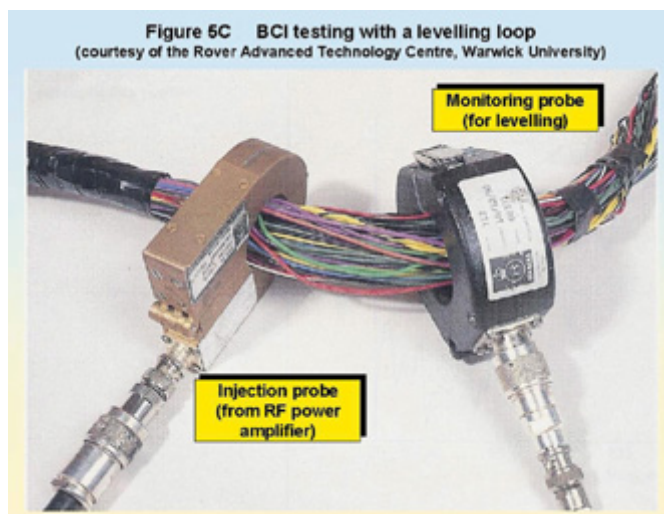

The home-made current probe shown in Figure 5 of [1] can be used as either the injection or sensing current clamp in a BCI test, although as shown it will not be very effective at frequencies below 10MHz. Good injection and sensing performance below 10MHz generally needs much larger ferrites and/or ferrite materials with better low-frequency performance. Multi-turn windings can avoid the need for high-voltage drive (i.e. more expensive RF amplifiers). If it is wished to extend the frequency range below 100kHz silicon-iron, mu-metal or other types of metal cores may be better than ferrite.

The current clamps are usually attached to the cables as close to the point where they enter the EUT as possible, so that cable losses do not attenuate the higher frequencies before they get to the EUT's circuits.

The typical use of BCI is to inject a common-mode current into a cable or cable bundle to simulate an illuminating RF field, but it can also be used on individual conductors within a cable or a bundle to simulate conducted differential-mode disturbances, for example from other electronic units connected to the same conductors. This can be very useful for developing the conducted RF emissions specification for, say, a new switch-mode power converter that is to share the same AC or DC power distribution as existing instrumentation.

When BCI is used to test cables **external** to an EUT as an alternative to radiated field testing of the EUT, for simplicity's sake you can assume that the common-mode impedance of the cables is  $150\Omega$ . Then convert the V/m field strength into Amps rms of injected current by merely dividing the V/m by 150. The conversion factor is thus 6 to 7mA/V/m. So 3V/m is considered to be equivalent to between 18 and 21mA rms of injected RF current.

The assumption of  $150\Omega$  common-mode RF impedance may not be true where there are cable resonances, when the impedance can become very high, or very low. BCI testing with a levelling loop can be fooled by cable resonances – high-impedance resonances cause the RF power amplifier's output to rise to try to achieve the set test current, possibly requiring a very powerful amplifier to avoid clipping of the waveform. This situation is unrealistic of most real life electromagnetic environments so could create a severe over-test situation.

In a similar way, a low-impedance cable resonance can cause the test current to be too low compared with real-life, possibly causing an undertest situation (although using 6 or 7mA of injected current per V/m of field strength appears to be high enough in most applications for undertesting not to be a concern). But where BCI is used to simulate differential-mode conducted disturbances, such as switch-mode converters operating from the same mains supply (instead of simulating the effects of external fields) the actual source impedance of the 'noise' can be very low indeed, especially at frequencies below 1MHz, so the current injected into a low-impedance resonance can be very high. This needs to be considered when planning the test, and suitably powerful RF amplifiers and BCI transducers obtained.

[3] and DEF STAN 59-41 DCS02 attempt to get around these 'traditional BCI' overtest/undertest problems by using a substitution method to set the RF drive levels, and by doing away with the levelling loop. A record is kept of the drive voltages needed at the various test frequencies to inject the desired test current into a short (non-resonant) cable terminated in  $50\Omega$  (a calibration piece). The drive voltages associated with each test frequency are then simply 'played back' into the actual cable to be tested without using a second probe in a levelling loop. More detail on using BCI for compliance testing is provided later in this article.

Of course, the substitution method means that the actual currents in the tested cables can vary considerably from those originally generated in the calibration piece, but this test method is less likely to over-test and is arguably more representative of real-life exposure to RF fields. This method is also a little bit closer to the EN 61000-4-3 method used for compliance testing for radiated fields, so will help when BCI is used as an alternative to radiated field testing (e.g. for the on-site testing of large installations). When doing compliance-related tests some labs have been known to make the error of using a levelling loop instead of the substitution method, despite [3] being quite clear on this point. Since the CE marking of a product is always the sole responsibility of its manufacturer (and never the test lab that they used), it is always a good idea to check that your test labs employ the correct methods.

If using BCI to simulate differential-mode conducted disturbances from equipment sharing the same mains supply (for example) the substitution method as described above (and later in this article) may need to be modified accordingly, and it may be that the levelling loop method is more appropriate. Such tests are not required for compliance (yet) so there are no standard methods.

One problem with BCI is that it has no directionality – so it tests the ancillary equipment required to exercise the EUT as much as it tests the EUT itself. Where the ancillary equipment is susceptible it can be protected to some degree by fixing a 200mm or more length of clip-on ferrite suppresser to the ancillary equipment side of the BCI injection transducer. Doing the BCI testing inside a shielded room and placing the ancillary equipment outside the room, running the interconnections through filtered bulkhead connectors in the wall of the room, is a good way to protect the ancillary equipment. But unless special  $150\Omega$  'chamber exit filters' are used (see reference [12] in [2]) these will dramatically alter the common-mode impedance of the cable being tested and could make the test unrepresentative.

Despite the problems of using conducted test methods to simulate radiated field exposure at frequencies above 100MHz (see section 5.2) BCI methods are often employed up to 400MHz – even for large products – where radiated testing is not feasible (e.g. for on-site radiated immunity testing). When cables are energised with RF they have fields associated with them and these will search out weaknesses in the EUT itself; although in a fairly uncontrolled manner. To use BCI up to 400MHz with any degree of repeatability it is important to ensure that the cable under test always sits in exactly the centre of the current transducer, ideally with a proper centring device but if not by packing the transducer with flexible foam

plastic. Repeatability of the set-up, especially cable routing, placement of the clamps, and proximity to metal structures is also very important. Bear in mind that at this frequency the half wavelength is 37.5cm – the impedance of a resonating cable passes from minimum to maximum through this distance.

Injecting substantial amounts of RF power into typical BCI clamps can cause them to get very hot and even be damaged. A ferrite-free BCI clamp was developed by DRA (now Qinetiq) to handle high powers from 10kHz to at least 400MHz without overheating, and this was sold by Chase EMC Ltd (Now Schaffner EMC Systems Ltd) as Part No. CIP 9136.

### 5.3.6 Direct injection with a CDN

[3] specifies the use of coupling-decoupling networks (CDNs) which directly inject RF voltages into the cables under test. The CDN method is described in great detail in [3] and later in this article.

Typical CDNs cost in the order of £500 each, but it is very easy to build your own using the guidance in [3]. Figure 5D shows an example of the internal construction of a home-made CDN that worked well up to 230MHz. Scrappy though it appears, many proprietary CDNs that work well enough appear not to be constructed with such good attention to RF assembly. In use, the ground plane of the CDN in Figure 5D was bonded to the ground reference plane with conductive-adhesive-backed copper tape as well as by its braid strap. Clearly, when used on hazardous voltages the circuitry in a CDN can be hazardous to touch so it should be protected by a plastic or earthed metal box. CDNS, like all transducers, need calibrating, but if you have calibrated RF emissions measuring equipment it is easy to do yourself using the method described in [3]. They can also be calibrated easily using an oscilloscope which has a bandwidth at least 50% higher. Note: it can be tricky to figure out the voltages you should see on your spectrum analyser or oscilloscope when using the calibration technique from [3], so take great care to understand what is going on.

Don't forget that CDNs handle several watts of RF power, so make sure their resistors are rated accordingly. Most people who build CDNs are familiar with the smell of burning resistors. Many EMC test engineers are also familiar with burning resistor smells because they tend to use power amplifiers which are more powerful than required simply for conducted immunity testing. Accidentally setting the output power to full on such an amplifier can rapidly burn out a CDN.

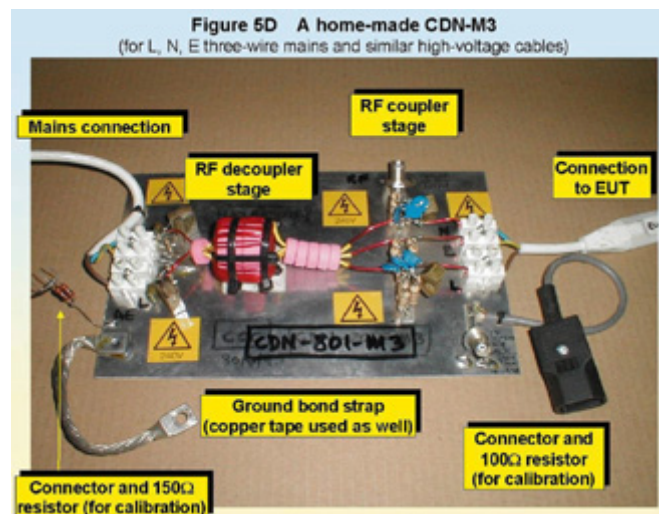

CDNs can be used at higher frequencies than [3] as an alternative to radiated test methods, for example for development or QA testing, or the on-site testing of large systems. Most commercial CDNs are only specified for use up to 80MHz, although some are specified at up to 230MHz. Richard Marshall Ltd manufacture a 'Versatile CDN' (see Figure 5E) that can be used for shielded or unshielded cables with from one to a number of conductors, and is also specified for use up to 500MHz [7], [8].



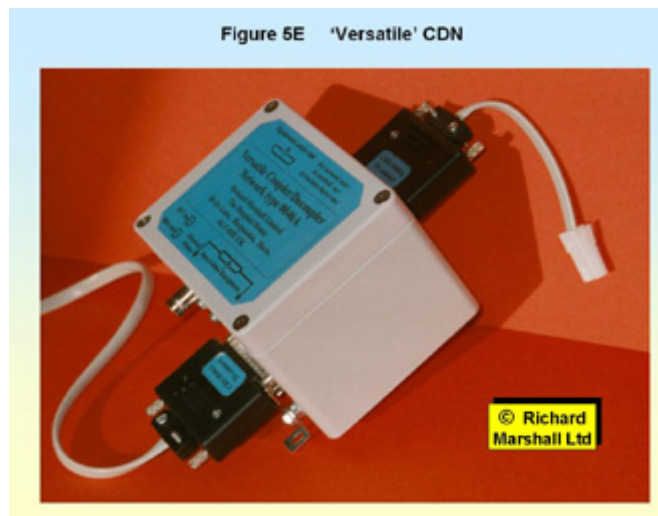

**Figure 5E**

For the same stress level, the IEC standards use the same voltage for conducted testing as the field strength in V/m for radiated. However, the conducted test level is specified as Volts emf, that is the voltage applied into an open circuit load; the actual voltage applied from  $150\Omega$  into the EUT's common mode impedance is less.

Remember that V/m are specified when unmodulated, as are  $V_{rms}$  for conducted immunity tests, however the actual radiated or conducted immunity tests should use modulated fields or waveforms (1kHz at 80% amplitude modulation depth preferred) which will have a higher peak level and may measure a different rms voltage.

Similar comments to those above on BCI, about the use of the substitution method when doing compliance-related testing using [3], apply to the use of CDNs as well.

### 5.3.7 The 'EM-Clamp'

[3] also specifies the use of the 'EM-Clamp', a transducer which was originally developed for the Swiss PTT and which induces RF voltages into the cables under test using a combination of inductive and capacitive coupling. The EM-Clamp test method is described in detail in [3] and later in this article in the section on full compliance testing.

The original model of EM-Clamp was specified for use at up to  $100V_{rms}$  from 150kHz to 1000MHz so can be used as an alternative to radiated test methods, for example for development or QA testing, or the on-site testing of large systems. If it is intended to use an EM-Clamp for such high test levels or high frequencies, it would be as well to check that it meets the original Swiss PTT specification and has not been 'value engineered' so that it is only suitable for testing at up to 80 or 230MHz, or at levels only up to  $10V_{rms}$ .

New EM-Clamps can cost over £2,000, but [3] may give enough constructional detail to allow keen EMC engineers who are good with their hands to build their own and save quite a bit of money (if they don't cost their time).

Similar comments to those above about the use of the substitution method in compliance-related testing to [3] apply to the use of the EM-Clamp as well as to BCI and CDNs.

### 5.3.8 General notes on test set-ups

For conducted immunity tests to be repeatable, test set-ups must be carefully controlled with, wherever possible, all the cables associated with the EUT and the EUT itself mounted at a set height (often 100mm) above a ground reference plane that lies under the EUT and extends beyond it by at least 200mm.

The terminations at the other ends of the cables from the EUT should either be to a coupling/decoupling network or to the specified ancillary equipment, or else be terminated to the ground reference plane in a controlled manner representative of the intended use of the EUT (a  $150\Omega$  common-mode resistance is often specified).

CDNs are relatively expensive items to buy, given the number of different types that a test lab may need to cover the majority of its customer's products. Although the CDN is the preferred transducer in [3], some test labs may prefer to use an EM-Clamp or BCI to avoid the need to stock dozens of types of CDNs. The results from using each type of transducer on the same EUT will be different, hence different labs may find they get different results. [9] also comments on this source of uncertainty.

The need to terminate most types of RF power amplifiers (apart from those specifically designed to work with unmatched loads) has already been mentioned. CDNs built according to [3] include a series impedance of  $100\Omega$  and other types of transducers may have non- $50\Omega$  impedances which can cause a 'frequency ripple' related to the length of their cable from the ( $50\Omega$  output impedance) RF power amplifier. The reflections at the mismatched load termination are the problem, and they are usually dealt with by connecting a  $50\Omega$  through-line 6dB attenuator in series with the RF drive very close to the transducer. A further important reason for this attenuator is to ensure that the drive impedance seen by the CDN remains close to  $50\Omega$ , so that the test source impedance of  $150\Omega$  is maintained. Figure 5F shows a typical proprietary 6dB through-line attenuator rated at 20 Watts.



**Figure 5F**

The RF power amplifier needs to be increased in size to include the losses in the attenuator. It is also best to rate the through-line attenuator for the maximum power output of the amplifier to avoid the possibility of damage to it by over-dissipation.

Because the EUT is not bonded to the ground reference plane during conducted RF tests, the signals that are injected into one cable tend to 'leak out' via other cables. Thus, testing just one cable port (e.g. the mains) tends to reveal the weaknesses in all the other cable ports. This is a very useful feature that can save a great deal of time when using conducted RF testing for design/development, troubleshooting or QA purposes.

Where a shielded cable is used, it is normal to inject the conducted voltage or current onto just the shield. However, if the shield is not terminated at the EUT (as might happen when following some single-ended shield terminating installation techniques) it may simulate the real-life environment better to inject the RF directly into the cable's inner conductors and ignore the unterminated shield. For BCI and EM-Clamp injection this may mean preparing a special cable, while for CDN injection it will mean using a model which uses an unshielded cable.

*Continued on next page...*

*Continued from previous page*

## **5.4 Signal generators and power amplifiers**

### **5.4.1 Alternative types of signal generator**

Compliant testing using [3] specifies an RF signal generator that increments its frequency according to specified rules for step size and dwell time at each step. It might be tempting for low-cost testing, and testing in design/development, fault-finding, or production QA to just use a simple RF signal generator with manual tuning. But the temptation to save money at all costs should be tempered by consideration of the testing time required. For some kinds of tests, especially close-field probing, covering the frequency range from 150kHz to 80MHz (or more) with a manually-tuned signal generator could take so long to do that it would be a false economy.

Happily, most of the RF signal generators manufactured over the last 20 years have a useful degree of automation – even the low cost ones feature automatic analogue sweeping (or digital synthesiser 'stepping') between two frequencies plus a variety of useful modulation waveforms. Old Marconi 2022s and the like usually have all the features required to minimise testing time. They can now often be found at very reasonable prices in second-hand electronic equipment or radio amateur shops.

It is especially useful to use a signal generator that ‘sweeps’ or ‘steps’ automatically over the whole frequency range of interest. When close-field probing, the sweep rate should be fast enough so that several sweeps occur for each position of the probe, but not so fast that the circuit can’t respond in time to a particular problem frequency. The alternative procedure for a manually tuned generator is to set the signal generator to one frequency, physically scan the EUT with the probe, reset the frequency, physically scan again, and so on – which can be very time consuming.

The tracking generators sometimes included with spectrum analysers can also be used as sweep signal generators for conducted immunity testing, but unfortunately they don’t have a modulation feature. For some types of products (e.g. pure digital products with digital I/Os) modulation might not be crucial, so simply increasing the test level by 80% might allow the use of a tracking generator. However, for most types of products, especially those with analogue functions, an external RF modulator would be needed. Rather than use sinewave modulation, the much simpler technique of on/off switching the RF carrier at a 1kHz rate should be simpler to arrange, remembering to increase the RF level by 80% first.

An alternative to sweeping or stepping the frequency is to use a broadband noise generator, such as the RF ‘comb’ generators or random noise sources used in Comparison Noise Emitters (CNEs) or equivalent available from a number of manufacturers. CNEs (or equivalent) are usually sold for characterising emissions test sites, and although their output spectrum may not be very ‘flat’, they are very repeatable.

Comb generators can be fairly readily designed and assembled. For a 100MHz top frequency they would typically pass a square-wave of between 100kHz and 1MHz through a very fast switching device to generate a very broad band of harmonics of the basic switching rate. The maximum rise and fall times ( $t$ ) of the fast switcher set the top frequency ( $f$ ) of the comb, according to the rule-of-thumb:  $f = 1/\pi t$ . So for example rise/fall times of 3ns are needed for an upper frequency approaching 100MHz. Note that achieving rise/fall times of 3ns or less with a 5V signal swing requires attention to detail – RF design and assembly techniques will be needed.

It is difficult to get a comb generator to have a high level of signal at a high frequency due to the natural roll-off of the amplitude of the harmonics at 20dB/decade according to the Fourier series for a square wave. A single-pole high-pass filter after the fast switcher will help compensate for this to create a flatter frequency/amplitude characteristic, but it does this by attenuating the lower-frequencies. For example, with a 1MHz switching rate if a level of 1V<sub>rms</sub> is required at 100MHz then either the fast switcher must run from around 100V or the high-pass filter must be followed by an RF power amplifier. If the fast switcher was running from a 5V rail, the RF amplifier would need a gain of about 30dB. Figure 5G shows a block diagram of such a comb generator and indicates the types of spectra that could be expected at each stage.

There is a trade-off between the spacing of the frequencies in the comb and the RF amplifier gain or fundamental switching voltage. To keep the design simple and avoid high-voltage switching or high-gain RF amplification it may be best to use a number of switching rates (e.g. 10kHz, 100kHz and 1MHz) to cover different frequency ranges (e.g. 100kHz-1MHz, 1-10MHz and 10-100MHz respectively). The comb spacing that these will be adequate for many applications, but to be more thorough requires filling in the gaps between the comb’s ‘teeth’ by, for instance, modulating the switching frequency by  $\pm 6\%$ . It may be possible to use one of the increasingly popular spread-spectrum clock generators instead, if they can spread the clock frequency by this large a percentage.

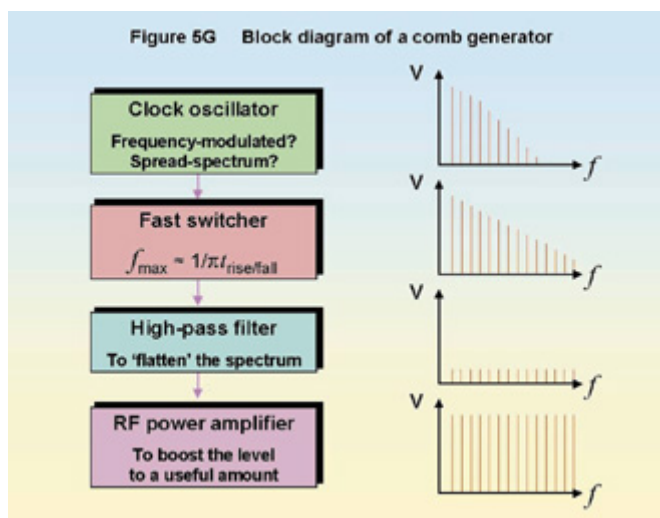

The output from a CNE (or other noise generator) should be isolated from the load by passing it through a broadband RF amplifier which has enough power to drive a loop probe over the frequency range required. A filter could be fitted between the CNE’s output and the amplifier’s input to restrict the frequency range of the test, if required.

Schaffner EMC Ltd (now Schaffner EMC Systems Ltd) used to sell a product called NSG 420 which used a pseudo-random signal generator based on a shift register with a frequency-modulated clock to drive a maximum output of 320mWrms. The power amplifier drove a current through a ferrite coupling clamp similar in principle to the home-made one shown in Figure 5 of [1] (although more professionally realised, of course). EUT cables were placed in the clamp and subjected to a broad spectrum of RF stimuli simultaneously, with a flat spectrum over the 1 to 10MHz range. A level control was provided, as was a bar-graph to indicate the coupled current.

The NSG 420 was a useful low-cost product for design/development, production QA, or field testing to help identify the causes of 'gremlins'. Unfortunately it is no longer available as a Schaffner product although it may be worth contacting the original designer, Richard Marshall, to see if he can help (email: richard.marshall@iee.org). A keen electronic designer should be able to design and make something similar without a great outlay in components if they don't mind spending some time on it.

Even driving loop probes and current probes from a Fast Transient Burst generator will, to some degree, test over the frequency range covered by typical conducted immunity tests and may be a way to get extra value from equipment you already own.

Section 3.5.4 and Figure 3J in Part 3 of this series [10] described the 'chattering relay' alternative fast transient burst generator. With a little ingenuity it is possible to use this as a random noise generator to drive a conducted RF immunity transducer. Note that the spectrum at the sparking contacts is literally DC to daylight (and beyond) so some filtering may be required.

### 5.4.2 RF Power Amplifiers

To test using [3] at the 3Vrms level required for residential, commercial, and light industrial environments may require a power amplifier rated at about 2-3W. For the 10Vrms industrial level power amplifiers of around 15-20W may be required.

Simple calculations based on the 150Ω impedance used by [3] indicates much lower power levels, but they usually forget the loss in the 6dB through-line attenuator and the nearly quadrupled power required to cope with the peaks of an 80% amplitude modulated RF waveform; plus the fact that the maximum output power rating of RF amplifiers is usually given for a certain degree of 'compression' – so we need to use an amplifier which is more powerful to achieve the peak test levels.

To overtest by 6dB (to give a good safety margin on an accurate compliance test) requires a four-fold increase in RF power, so a 45 or 50W amplifier may be necessary for testing industrial products to [3] using CDNs.

Other types of transducers to the CDNs described in [3] are less efficient. The EM-Clamp typically requires three to four times the RF power of a CDN for the same actual test level. BCI clamps, because of their higher loss, are even less efficient.

A problem with high-power amplifiers is that the transducers and any termination resistors or through-line attenuators should be rated to take the full power of the amplifier. Most proprietary CDNs may not be rated for much higher powers than the 10Vrms of the 'industrial' level immunity test, and they are expensive to replace unless you build your own.

### 5.5 Correlating alternative test methods with EN 61000-4-6

When an alternative radiated RF immunity test method is used for design, development, or troubleshooting after a test failure repeatability is very important (even though the correlation with [3] may not be). All such tests will need to follow a procedure which has been carefully worked out to help ensure that adequate repeatability is achieved.

When alternative methods are used as part of a QA programme, or to check variants, upgrades, or small modifications, a 'golden product' is recommended to act as some sort of a 'calibration' for the test equipment and test method. Golden product techniques allow low-cost EMC test gear and faster test methods to be used with much more confidence. Refer to section 1.9 of [1] for a detailed description of how to use the golden product correlation method.

If alternative methods are used to gain sufficient confidence for declaring compliance to the EMCD, the golden product method is very strongly recommended. Without a golden product or some similar basis for correlating a proper compliance test (using [3]) with the alternative method actually used, the alternative method can only give any confidence at all if gross levels of overtesting are applied, and this can result in very expensive products. Refer to 1.9 in [1].

The closer a test method is to using the proper test transducers and methodology in [3], the more likely it is that a good correlation will be achieved. So testing with a close-field probe (for example) can probably only be correlated on a particular build state of a specific product, while EM-Clamp testing using a pseudo-random noise source instead of the stepped frequency source may be able to be correlated for a range of products from one manufacturer sharing the same electronic technology and assembly/construction methods.

## 5.6 On-site testing

Section 10.2.5 of [11] describes the methods that have been developed for on-site testing for conducted immunity. These are not a great deal different from the three methods used by [3], but BCI is often easier to employ on a site because it disturbs the cables less.

One problem with on-site testing is that it may be impractical to arrange for a ground plane as specified by [3] and as a consequence the parasitics which can have a significant effect at the higher testing frequencies might not be well controlled. Although this is often acceptable for a Technical Construction File for an individual apparatus, it is less satisfactory if used to predict the conducted immunity of the same or similar type of apparatus on a different site.

Don't forget that interference, especially with aircraft or other vehicular systems, some machinery or process control systems, and implanted electronic devices such as pacemakers, can have lethal consequences and appropriate precautions **must** be taken to make sure that nobody's safety is compromised. It is also a good idea to take precautions where there is a possibility of significant financial loss being caused by the interference from on-site testing.

Where radiated emissions from on-site conducted RF immunity testing could be significant (i.e. when the conductors injected into are longer than  $\lambda/10$  at the highest frequency tested) it may be necessary to shield the system being tested with a shielded tent. Where there are no safety or financial loss implications of the radiated emissions from the tests and a shielding tent is not to be used, it may be necessary (for legal testing) to first obtain a special license from the National Radiocommunications Agency responsible (refer to [12]).

## 5.7 Full compliance conducted RF immunity testing

EN/IEC 61000-4-6, the basic test method for "*Immunity to conducted disturbances, induced by radio frequency fields*", is a complex standard which is very easy to misinterpret. This section offers a simplified stroll through the minefield to highlight the principal requirements. If you are actually doing a full compliance test on anything other than a very simple EUT, you will almost certainly have to make some compromises and deviations from the letter of the standard. Understanding the rationale for some of the requirements will enable you to make an informed decision.

### 5.7.1 Generator

The basic requirement for the test system is to generate a modulated RF signal of sufficient amplitude, swept or stepped over the frequency range from 150kHz to 80MHz. The upper frequency range may be extended by some product standards to 230MHz. The system normally uses a standard GPIB-controlled signal generator feeding a broadband linear power amplifier of the required power level – Table 1 gives the necessary power levels for a 10V (level 3) test, depending on transducer. The standard modulation on the signal, as usual, is a 1kHz sinusoidal tone modulated at 80% depth.

The amplifier must be linear so that it does not distort the modulated waveform, and so that it does not introduce harmonics of the wanted stress frequency. The specification for harmonic amplitudes is that they should be -15dBc, that is 15dB below the wanted frequency stress signal level, across the whole test range, whatever the load conditions on the amplifier.

The output of the amplifier could be coupled directly to the cable transducer, but as we shall see, the common mode source impedance of the transducer is affected by the driving impedance, which should be  $50\Omega$ . To achieve an accurate common mode impedance this  $50\Omega$  must be carefully controlled, but the amplifier's output impedance can vary quite widely. To deal with this, an attenuator of at least 6dB is required between the amplifier output and the transducer. Naturally, this means that three-quarters of the amplifier's output power is lost in this attenuator before it reaches the transducer, so the amplifier must be sized for a four times greater power level than would be needed without the attenuator. This factor is allowed for in Table 1.

**Table 1 Required power levels (from IEC 61000-4-6 table E.1) for 10V emf**

Transducer type	Coupling factor	Required power output from amplifier
CDN	0dB	7W
Current clamp (5:1)	-14dB	176W
EM-clamp	-6dB	28W

### 5.7.2 Transducers

The standard allows three types of transducer: the coupling/decoupling network (CDN), the EM-clamp and the current injection probe. It also allows direct injection, that is coupling directly onto the screen of screened cables via a resistor, but demands that a decoupling network is used in addition, and frequently these are combined into a CDN designed for particular screened cables.

As can be seen from Table 1, the CDN requires the least power and is also the most definitive method, since it automatically and accurately controls the injected source impedance (specified in Table 2) and the attenuation towards the AE, that is, the cable end away from the EUT. Therefore it is the preferred choice of transducer. Unfortunately it also requires a specific type of network for each type of cable to be tested, since it needs a direct connection to each line in the cable.

Because it is invasive, it may also have a significant effect on the signals carried in the cable, particularly if these are broadband. For some types of cable, particularly mains and DC power, low frequency signals, audio telecom, and the more common types of screened cable, it is reasonable to have a variety of CDNs on the shelf which you can select for particular tests. If you are a product manufacturer and you know you will only be testing certain types of cable, you can carry CDNs just for these types, but this option isn't available to a general test house.

**Table 2 Common mode source impedance specification**

	0.15 - 26MHz	26 - 80MHz
$ Z_{cm} $ with 50 $\Omega$ at input port, AE port both open and short circuit	150 $\Omega$ $\pm$ 20 $\Omega$	150 $\Omega$ +60 $\Omega$ -45 $\Omega$

For cables for which CDNs are not "suitable" (and the interpretation of "suitable" is entirely up to the tester) two other non-invasive injection methods are provided. These use the EM-clamp and the current injection probe. The EM-clamp (see Figure 5H) is specifically designed for this test and although it looks similar to the ferrite absorbing clamp used for emissions tests, it is in fact quite different. It is described in Annex A of the standard and provides both inductive coupling through a string of ferrites, clamped around the cable, and capacitive coupling via a close-coupled electrode running the length of the clamp.

The two modes of coupling are so designed as to give significant (better than 10dB at some frequencies) directivity, so that the AE end of the clamp is reasonably adequately decoupled. It requires no connection to the cable under test and is therefore popular for situations where many different types of cable must be tested, and it is also reasonably efficient, as Table 1 demonstrates. Even so, the common mode impedance is not nearly so well controlled as in the CDN case, and the directivity and efficiency fall off at the lower frequencies.

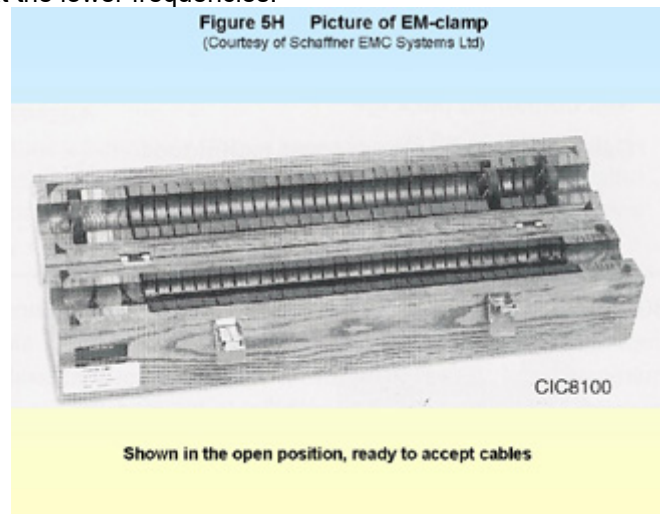

The third method uses the current injection probe. This is equivalent to the BCI (bulk current injection) method described in the previous part of this series. The probe is convenient and easy to use but is inefficient compared to the other methods, needing a higher power amplifier, and provides absolutely no directivity or common mode impedance setting. For this reason it should only be used if there is no alternative method.

For both EM-clamp and current probe methods, the standard points out that the AE (auxiliary equipment) is part of the test and should present the proper 150 $\Omega$  common-mode impedance and be adequately immune. The first of these is not at all easy to ensure and the standard describes using a combination of decoupling networks (assemblies of wideband ferrite sleeves) and CDNs to achieve it. For complex or multiple AEs this becomes cumbersome or impractical and a modification of the test method involving an extra monitoring current probe is used.

### 5.7.3 Calibration and levels

The basis of the IEC 61000-4-6 test is that it uses a substitution method. That is, the stress is calibrated into a fixed impedance in the absence of the EUT, and then the same power level versus frequency is re-played into the EUT itself. This method avoids unwarranted peaks or nulls due to variations in the EUT's common mode port impedance. However, it requires stability on the part of the generation system and transducers, and it also means that variations between different transducers can contribute to the lack of reproducibility of the test. In other words, both the choice and quality of the transducer are critical to standardising the test between laboratories.

Figure 5J shows the calibration setup for the CDN method. The same setup applies for the EM-clamp, and a modification to it applies for the current injection probe. The CDN is terminated at both its AE and EUT ports – all wires shorted together – with a  $150\Omega$  load, and its input port is fed in exactly the same manner as it will be in the test proper. The EUT port load is made up of the measuring instrument's  $50\Omega$  input impedance plus a " $150\Omega$  to  $50\Omega$  adaptor". This adaptor is nothing more than a series  $100\Omega$  resistor. Although this resistor and associated connecting parts is obviously a very simple piece of apparatus, you should remember that its accuracy is fundamental to the accuracy of the set level, and make sure that it is maintained across the applicable frequency band and at the power levels applied.

The test levels (standard levels are 1V, 3V or 10V) are specified in volts emf: this means voltage into an open circuit, not the voltage that is actually applied to the EUT, nor even that which is observed on the measuring instrument during calibration. Because both source and load impedances are known during calibration the actual indicated voltage for an applied emf level can be calculated. For the CDN calibration jig, the source impedance is  $150\Omega$ , the load impedance is also  $150\Omega$  and the measuring instrument impedance is  $50\Omega$ . The indicated voltage must be multiplied by 3 to allow for the  $50\Omega$ -to- $150\Omega$  conversion and again by 2 to reach the open-circuit voltage, hence the indicated value is  $1/6^{\text{th}}$  the desired stress level. The current probe calibration jig uses a  $50\Omega$  rather than  $150\Omega$  system and therefore the indicated value is half the stress level, since no  $50\Omega$ -to- $150\Omega$  conversion takes place.

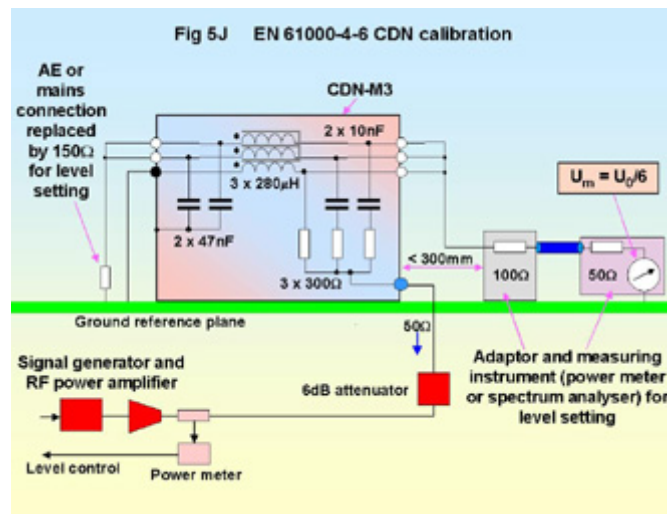

Once the power level for the required stress value has been established at each frequency then it is stored in software and re-played during the actual test. Modulation is not applied during calibration – the test levels are specified as the unmodulated voltage – but it is applied during the test. The standard allows level setting to be applied at the output of the signal generator, but this of course assumes that the power amplifier is adequately linear and stable. Many test software suites use a coupler at the output of the power amplifier, and monitor and control on the measured output power. This negates any effects of gain drift in the amplifier. Either method is allowable.

This method is of course open-loop; there is no requirement to check the actual applied level during the test, although a prudent test facility may leave a monitoring device in place merely to confirm that nothing has broken. Because of the nature of the substitution method, the indication on this monitor bears no real relationship to the intended stress level.

But in the case where clamp injection is used and the  $150\Omega$  AE common mode impedance is not achievable, then clause 7.3 of the standard requires that the applied current is monitored during the test sweep, and limited if necessary to the value that would have been applied into a common mode impedance of  $150\Omega$ , e.g.  $66.7\text{mA}$  for a 10V emf level. This prevents over-testing in situations where the EUT common-mode impedance is substantially less than  $150\Omega$ . It doesn't, though, represent full closed-loop testing.

#### 5.7.4 Test setup

Figure 5K shows an example test set-up for compliant conducted RF immunity tests to EN 61000-4-6. The important aspects of the test setup are to control the common mode impedance presented by the transducers, the EUT and its AE, and to ensure that cable resonances are avoided. The first of these is achieved by having an adequate ground plane for the whole test area, and placing the EUT a defined distance (10cm) above this ground plane. The AE is also placed at this

height if clamp injection is used. The ground plane is the reference for the applied voltage and so the CDNs and EM-clamp must be fully bonded to it, preferably by direct bolted fixing. Since the test extends up to 80MHz, any inductance in this bond is unacceptable. The ground plane itself need not be externally grounded for EMC purposes, but it is advisable to connect it to the facility earth for safety.

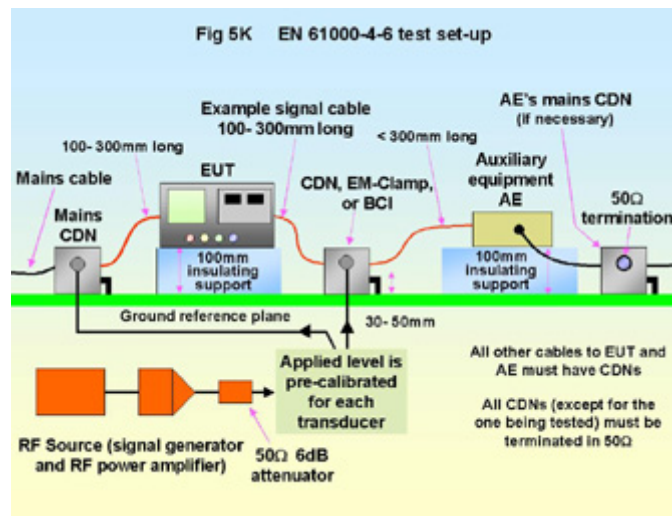

Cable resonances are potentially serious: a distance of a quarter wavelength transforms a short-circuit impedance into an open circuit, completely altering the coupling properties of the setup. A quarter wavelength at 80MHz is 94cm and therefore no cables included in the test environment should approach this length, even if they are not being tested. The standard insists that on the tested cables, the coupling/decoupling devices should be between 10 and 30cm from the EUT and the cables themselves should be maintained 3-5cm above the ground plane, as short as possible and un-bundled. When you are using the current injection probe, the cable length on the other side of the probe (the AE side) should also be less than 30cm.

If there are multiple cable ports on the EUT, only a limited number need be tested, exciting between 2 and 5 current paths through the EUT. The most sensitive configurations should be selected, although no guidance is given as to how to determine these. Other cables should be disconnected or isolated with decoupling networks. Each CDN or other transducer associated with the EUT is tested with injected RF in turn, while each of the other CDNs associated with the EUT are terminated in 50Ω. When several cables are loomed together in the normal installation, they can be treated as one cable for the purposes of testing. Separate earth ports on the EUT are treated like any other cable port and also tested, most easily with a one-line CDN.

Hand-held devices and keyboards need to be tested with an artificial hand, which is a simple RC network simulating hand-to-ground impedance. EUTs consisting of several interconnected units should be tested by considering each sub-unit as an EUT in its own right, with all other parts treated as AE. But if the interconnecting cables will always be less than 1m they can be treated as internal and left untested, the component sub-units of the EUT being grouped together and close to each other on the 10cm insulating support, with only the "external" cables subject to testing.

## 5.8 References

- [1] "EMC Testing Part 1 – Radiated Emissions" Keith Armstrong and Tim Williams, EMC Compliance Journal February 2001, pages 27-39. (Also includes Part 0.) Available on-line at [www.compliance-club.com](http://www.compliance-club.com) (using the site's Archive Search facility).
- [2] "EMC Testing Part 4 – Radiated Immunity" Keith Armstrong and Tim Williams, EMC Compliance Journal, August 2001 pages 22-32 and continued in the October 2001 issue. On-line at [www.compliance-club.com](http://www.compliance-club.com) (using the site's Archive Search facility if necessary).
- [3] EN 61000-4-6, Electromagnetic Compatibility (EMC) – Part 4: Testing and measurement techniques – Section 6: immunity to conducted disturbances, induced by radio-frequency fields.
- [4] "Economic susceptibility testing", Nigel J Carter, IEE Colloquium on Low Cost EMC Testing, 21<sup>st</sup> September 1993, Digest Reference No. 1993/169.
- [5] "EMC testing Rover cars", Robert Ball, Paul Jennings and Peter Lever, IEE Engineering and Science Journal December 1992, pages 261-266.
- [6] "Autoprofiling – saving time in RF immunity testing", Peter Lever, Robert Ball and Paul Jennings, IEE Colloquium on Low Cost EMC Testing, 21<sup>st</sup> September 1993, Digest Reference No. 1993/169, pages 4/1 to 4/5
- [7] "Desk-top Immunity Testing and Diagnostics" Richard Marshall, IEE Colloquium on 'In-House EMC Measurements and Diagnostics', Savoy Place London 14<sup>th</sup> November 2000, IEE Reference: 00/092 ([sales@iee.org.uk](mailto:sales@iee.org.uk))
- [8] "A new approach to coupling/decoupling networks for EMC testing" R C Marshall, York EMC '99, July 1999.



- [9] “*Subjecting failure modes in immunity tests to uncertainty analysis*”. Brian Jones, The EMC Journal, June 1997, Pages 7-10.
- [10] “*EMC Testing Part 3*” Keith Armstrong and Tim Williams, EMC Compliance Journal, June 2001 pages 19-29. On-line at [www.compliance-club.com](http://www.compliance-club.com) (using the site's Archive Search facility if necessary).
- [11] “*EMC for Systems and Installations*”, Tim Williams and Keith Armstrong, Newnes, January 2000, ISBN 0-7506-4167-3 (available from RS and Farnell).
- [12] “*EMC testing on-site*”, Dag Björklöf, Compliance Engineering magazine, September/October 1997, pages 73-79 in their US edition, 41-45 in their European edition.

*Eur Ing Keith Armstrong C.Eng MIEE MIEEE*

*Partner, Cherry Clough Consultants, [www.cherryclough.com](http://www.cherryclough.com), Associate of EMC-UK*

*Phone: 01457 871 605, Fax: 01457 820 145,*

*Email: [keith.armstrong@cherryclough.com](mailto:keith.armstrong@cherryclough.com)*

*Tim Williams C.Eng MIEE*

*Director, Elmac Services, [www.elmac.co.uk](http://www.elmac.co.uk), Associate of EMC-UK*

*Phone: 01243 533 361, Fax: 01243 790 535,*

*Email: [elmactimw@cix.compulink.co.uk](mailto:elmactimw@cix.compulink.co.uk)*