



E-terminals

Installation manual

MA00614A 2002-09

Installation manual

Content

Česky	1-1
Deutsch	2-1
Dansk	3-1
Español.....	4-1
Français	5-1
Suomen kielinen.....	6-1
English	7-1
Italiano	8-1
Norsk.....	9-1
Nederlands	10-1
Português.....	11-1
Svenska	12-1
Slovenia.....	13-1
Technical Data.....	A-1
Connection to MELSEC PLC systems	B-1
Settings for the C24 module on MELSEC PLC systems.....	C-1
Front data	D-1
Terminal drawings.....	E-1
Cable drawings.....	F-1

© Beijer Electronics AB, MA00614A, 2002-09

Beijer Electronics AB absolves itself of all responsibilities for damage and injuries that may occur during installation or use of this equipment.

Beijer Electronics AB absolves itself of all responsibilities for any type of modification made to the equipment.

Obsah

Bezpečnostní předpisy	2
Úvod.....	4
Instalace.....	5
Technická data	A-1
Připojení k systému PLC MELSEC	B-1
Nastavení modulu C24 v systému PLC MELSEC.....	C-1
Čelní panel	D-1
Schéma svorek	E-1
Schéma kabeláže	F-1

Další informace jsou uvedeny v manuálu k tomuto terminálu.

© Beijer Electronics AB 2002

před instalací a použitím tohoto výrobku si prosím pozorně přečtete celý Instalční manuál. Výrobek může být instalován a opravován pouze kvalifikovanými osobami. Firma Beijer Electronics AB není zodpovědná za jakkoli pozměněný nebo upravovaný výrobek. Tento výrobek má široké možnosti použití. Uživatel si musí osvojit znalosti potřebné pro správné použití výrobku v zamýšlené aplikaci. K tomuto výrobku je dovoleno používat jen díly a příslušenství vyrobené podle specifikace Beijer Electronics AB.

FIRMA BEIJER ELECTRONICS AB NENÍ ZODPOVĚDNÁ ZA JAKÉKOLI PŘÍMÉ, NEPŘÍMÉ, MIMOŘÁDNÉ, VEDLEJŠÍ NEBO NÁSLEDNÉ ŠKODY VYPLÝVAJÍCÍ Z INSTALACE, POUŽITÍ NEBO OPRAVY TOHOTO VÝROBKU, AŤ UŽ PŘEROSTOU V DELIKT, SMLUVNÍ VZTAH NEBO JINAK. JEDINÝ OPRAVNÝ PROSTRĚDEK JE OPRAVA, VÝMĚNA NEBO VRÁCENÍ NÁKUPNÍ CENY KUPCI, PŘIČEMŽ VÝBĚR POUŽITÉHO OPRAVNÉHO PROSTRĚDKU ZÁVISÍ VÝHRADNĚ NA BEIJER ELECTRONICS AB.

Bezpečnostní předpisy

Obecně

- Pročtete si pozorně bezpečnostní předpisy.
- Zkontrolujte dodávku, abyste objevili eventuální škody vzniklé přepravou. Zjistíte-li škodu, uveďte ihned dodavatele.
- Terminál splňuje požadavky dle článku 4 v direktive EMC 89/336/EEC.
- Nepoužívejte terminál v prostředí, kde je velké nebezpečí výbuchu.
- Dodavatel nezodpovídá za modifikované, změněné nebo přestavené vybavení.
- Pouze náhradní díly a příslušenství vyrobené dle specifikace dodavatele se smí používat.
- Před instalací, používáním nebo opravou terminálu si pozorně pročtete návod k instalaci a návod k používání.
- Montujete-li baterii chybně může dojít k výbuchu. Používejte pouze baterie doporučené dodavatelem.
- Nikdy nejlte kapalinu do mezer nebo otvoru v terminálu. Toto může způsobit požár nebo může vybavení být elektricky vodivé.
- Je nutno, aby s terminálem pracovaly osoby s příslušným školením.

Při instalaci

- Terminál je konstruován k pevné instalaci na rovné ploše.
- Behem instalace umístete terminál na stabilní podklad. Jestliže terminál upustíte nebo jestli spadne, může dojít k jeho poškození.
- Instalujte terminál dle přiloženého návodu k instalaci.
- Uzemnění je nutno provést dle přiloženého návodu k instalaci.
- Je nutno, aby instalaci prováděly osoby s příslušným školením.
- Kabely vysokého napětí, kabely signální a kabely napětí je nutno od sebe oddělit.
- Než dáte terminál pod napětí, přesvědčte se, že je napětí a polarita od zdroje proudu korektní.
- Otvory v pouzdře jsou určeny k cirkulaci vzduchu a nesmí být překryty.
- Neumísťujte terminál tam, kde je nebezpečí jeho vystavení silným magnetickým polím.
- Terminál nesmí být namontován v přímém slunečním světle.
- Okolní vybavení musí být vhodné tam, kde je použit.
- Některé modely mají na skle displaye laminovanou folii, aby nedošlo k jeho poškrábání. Stáhněte folii pomalu, abyste zabránili statické elektrine, která by mohla terminál poškodit.

**UL installation**

- Power, input and output (I/O) wiring must be in accordance with Class I, Division 2 wiring methods (Article 501-4 (b) of the National Electrical Code, NFPA 70) and in accordance with the authority having jurisdiction.

Pri používání

- Udržujte terminál v čistotě.
- Funkce nouzového zastavení nebo jiné funkce bezpečnosti se nesmí ovládat terminálem.
- Klávesy, sklo displaye atd. nesmí být vystaveny vlivu ostrých predmetu.

Servis a údržba

- Záruka platí dle smlouvy.
- K čištění skla displaye a panelu použijte jemný čistící prostředek a mekký hadřík.
- Opravy smí provádět pouze osoby s příslušným školením.

Pri demontáži a destrukci

- Recyklace terminálu nebo jeho částí se provádí dle platných pravidel v aktuální zemi.
- Dejte pozor na to, že následující komponenty obsahují materiály, které mohou být škodlivé pro zdraví a prostředí: litiové baterie, kondenzátory elektrolytu a display.

Úvod

Terminál je operátorský panel, příslušející do rodiny terminálů, vyvinutých pro uspokojení potřeb komunikace člověk-stroj. Funkce zabudované v terminálu zahrnují možnost zobrazování a řízení textu, dynamické indikace, alarmy, zpracování receptů a časové kanály.

Terminály mají z největší části objektově orientovaný způsob práce, který umožňuje jejich jednoduché používání. Terminál se programuje přímo z PC softwareovým balíkem E-Designer for Windows. V dalším je produkt E-Designer uváděn jako software pro PC. Celý program je uložen v terminálu.

Přepínání mezi programovacím módem PROG, a módem run-time RUN se provádí stisknutím kláves podle následující tabulky.

Terminály	Kláves
E50	[F1] + [F4]
E100, E150	[←] + [ENTER]
E200, E300, E600, E700, E900	[←] + [MAIN]
E610, E615, E910	The switch on the side of the terminal in position number 4. RUN = position 0.
E710	[F1] + [F2] + [F4]

Další informace jsou uvedeny v manuálu k tomuto terminálu.

Instalace

Požadavky na napětí

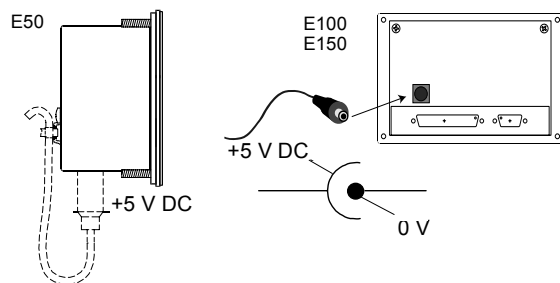

E900T/E900VT/E910T

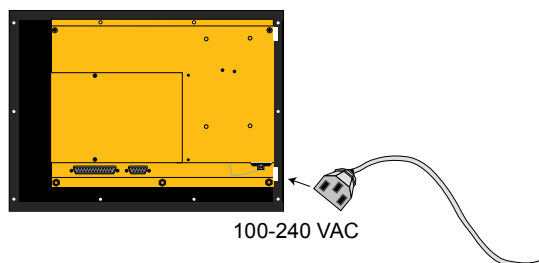

Tabulka kabelů

Název	Kontinentální Evropa	GB	USA	Zbytek světa
Cable 1	MAC-PC-CAB-R2/ CAB5	MAC-PROG/9-CAB/ CAB5	MTA-PROG-C/ CAB5	MAC-PROG/9-CAB/ CAB5
Cable 2	CAB6	CAB6	CAB6	CAB6

(CZ)

Připojení k osobnímu počítači

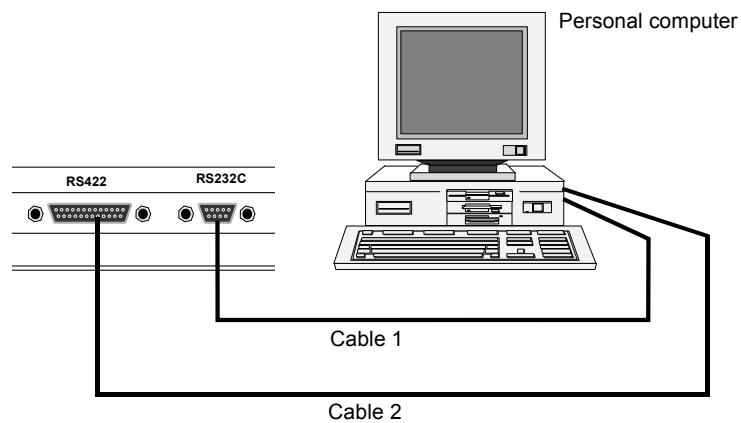

Pro programování terminálu se doporučuje software na PC. Instalace PC software je uvedena v manuálu tohoto produktu. Komunikační parametry v terminálu a v software PC musí být nastaveny stejně.

Připojení k tiskárně

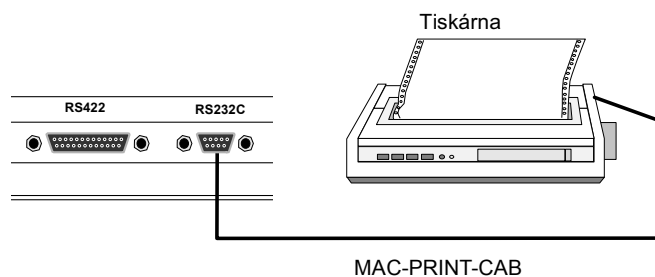

Tiskárna musí být vybavena sériovým interfejsem a znakovou sadou IBM. Správná konfigurace se nastaví dle manuálu tiskárny. V případě použití tiskárny s paralelním portem musíte použít rozšiřující kartu IFC PI. Návod k instalaci obdržíte s kartou IFC PI.

Inhalt

Sicherheitshinweise	2
Einleitung	4
Installation.....	5
Technische Daten	A-1
Anschluß an des MELSEC SPS-Systems	B-1
Einstellungen für das C24-Modul im MELSEC SPS-System	C-1
Vorderansicht.....	D-1
Abbildung der Klemmen.....	E-1
Abbildung der Kabel	F-1

Wenn Sie detaillierte Informationen benötigen, ziehen Sie die ausführliche Bedienungsanleitung für das Bedienterminal zu Rate.

© Beijer Electronics AB 2002

Lesen Sie zu erst der ganzen Installationsanleitung vor Sie dem Gerät installiert. Beijer Electronics AB übernimmt keine Verantwortung dafür, wenn diese Beispiele in einer Applikation benutzt werden. Aufgrund der Vielzahl der anwendungsmöglichkeiten dürfen sämtliche Arbeiten mit dem Gerät nur von ausgebildeten Elektrofachkräften durchgeführt werden. Die verwendeten Ersatz- und Zubehörteile müssen der Spezifikationen der Beijer Electronics AB entsprechen.

BEIJER ELECTRONICS AB ÜBERNIMMT KEINE HAFTUNG FÜR SCHÄDEN ODER VERLETZUNGEN, DIE SICH AUS DEM GEBRAUCH ODER MIßBRAUCH DIESES GERÄTS ERGEBEN. BEIJER ELECTRONICS AB ÜBERNIMMT KEINE VERANTWORTUNG FÜR JEDLICHE VERÄNDERUNG DES GERÄTS.

Sicherheitsvorschriften

Allgemeines

- Sicherheitsvorschriften sorgfältig durchlesen.
- Überprüfen Sie die Lieferung beim Empfang auf etwaige Transportschäden. Informieren Sie den Lieferanten umgehend, wenn Schäden entdeckt werden.
- Das Terminal erfüllt die Anforderungen gemäß Artikel 4 der EMC-Richtlinie 89/336/EEC.
- Setzen Sie das Terminal nicht in Umgebungen ein, in denen Explosionsgefahr besteht.
- Der Lieferant übernimmt keine Verantwortung für modifizierte, geänderte oder umgebaute Ausrüstung.
- Es dürfen nur Ersatzteile und Zubehör verwendet werden, die im Einklang mit den Spezifikationen des Lieferanten hergestellt wurden.
- Die Installations- und Benutzeranweisungen sorgfältig lesen, bevor das Terminal installiert, in Betrieb genommen oder repariert wird.
- Es besteht Explosionsgefahr, wenn die Batterie falsch montiert wird. Ausschließlich Batterien verwenden, die vom Lieferanten empfohlen werden.
- In die Schlitze oder Löcher des Terminals darf unter keinen Umständen Flüssigkeit eindringen. Dies kann einen Brand verursachen oder dazu führen, dass die Ausrüstung stromführend wird.
- Die Installation muss von speziell ausgebildetem Fachpersonal vorgenommen werden.

Hinweise zur Installation

- Dieses Terminal ist für den Betrieb an einem festen Standort und an einem ebenen Gebiet ausgelegt.
- Das Terminal während der Installation auf einer festen Unterlage platzieren. Wenn das Terminal herunter fällt, kann es zu Beschädigungen kommen.
- Installieren Sie das Terminal gemäß der beiliegenden Installationsanleitung.
- Erden Sie das Gerät gemäß den Vorgaben in der beiliegenden Installationsanleitung.
- Die Installation muss von speziell ausgebildetem Fachpersonal vorgenommen werden.
- Hochspannungs-, Signal- und Versorgungsleitungen müssen getrennt verlegt werden.
- Bevor das Terminal an die Stromversorgung angeschlossen wird, sicherstellen, dass Spannung und Polarität von der Stromquelle korrekt sind.
- Die Öffnungen im Gehäuse sind für die Luftzirkulation bestimmt und dürfen nicht überdeckt werden.
- Das Terminal nicht an Stellen platzieren, an denen es einem starken Magnetfeld ausgesetzt wird.
- Das Terminal darf nicht in direkter Sonneneinstrahlung montiert werden.
- Die Peripherieausrüstung muss dem Verwendungszweck entsprechen.
- Bei bestimmten Terminalmodellen ist das Displayglas mit einem laminierten Film versehen, um Kratzern vorzubeugen. Um zu verhindern, dass es aufgrund von statischer Elektrizität zu Schäden am Terminal kommt, den Film vorsichtig abziehen.

D

UL installation

- Power, input and output (I/O) wiring must be in accordance with Class I, Division 2 wiring methods (Article 501-4 (b) of the National Electrical Code, NFPA 70) and in accordance with the authority having jurisdiction.

Hinweise zum Betrieb

- Halten Sie das Terminal stets sauber.
- Nothalt- und andere Sicherheitsfunktion dürfen nicht vom Terminal aus gesteuert werden.
- Achten Sie darauf, dass Tasten, Bildschirm usw. nicht mit scharfkantigen Gegenständen in Berührung kommen.

Service und Wartung

- Garantieansprüche sind per Vertrag geregelt.
- Säubern Sie Bildschirm und Gerätevorderseite mit einem milden Reinigungsmittel und einem weichen Tuch.
- Reparaturen müssen von speziell ausgebildetem Fachpersonal vorgenommen werden.

Hinweise zu Demontage und Entsorgung

- Eine vollständige oder teilweise Wiederverwertung des Terminals ist entsprechend den jeweils geltenden Bestimmungen vorzunehmen.
- Beachten, dass folgende Komponenten Stoffe enthalten, die eine Gefahr für Gesundheit und Umwelt darstellen können. Lithiumbatterie, Elektrolytkondensatoren und Bildschirm.

Einleitung

Das Terminal ist ein Bedienpanel und gehört zu den Geräten der Mensch-Maschine-Kommunikation. Das Terminal umfaßt Funktionen wie das Anzeigen und Kontrollieren von Text, die dynamische Anzeige, Alarmbehandlung, Daten- und Rezepturspeicherung und Zeitschaltuhren.

Das Terminal arbeitet weitestgehend objekt-orientiert und ist daher sehr anwenderfreundlich. Die Programmierung des Terminals erfolgt über einen Personal Computer mit Hilfe der Windows-Software E-Designer. Das erstellte Programm wird im Terminal gespeichert.

Das Umschalten zwischen Programming mode, PROG, Run-time mode, RUN, erfolgt durch gleichzeitiges Drücken der folgenden Tastenkombinationen.

Terminal	Tastenkombination
E50	[F1] + [F4]
E100	[←] + [ENTER]
E200, E300, E600, E700, E900	[←] + [MAIN]
E610, E615, E910	Der Schalter seitens der Terminale in Position Nummer 4. RUN=Position Nummer 0.
E710	[F1] + [F2] + [F4]

Wenn Sie detaillierte Informationen benötigen, ziehen Sie die ausführliche Bedienungsanleitung für das Bedienterminal zu Rate.

D

Installation

Spannungsversorgung

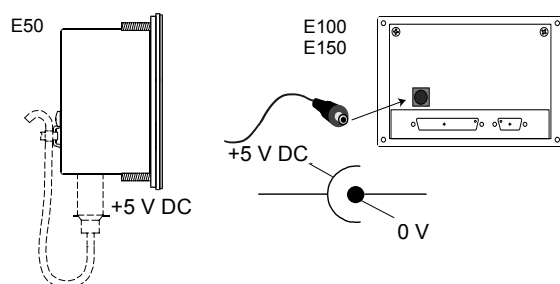
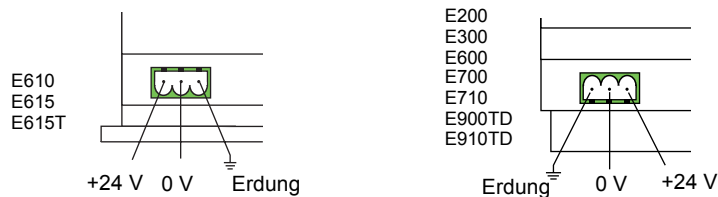

Achtung!
Achten Sie beim Anschluss auf die richtige Polarität. Kommt es zu einer Verwechslung, wird das Gerät beschädigt.

E900T/E900VT/E910T

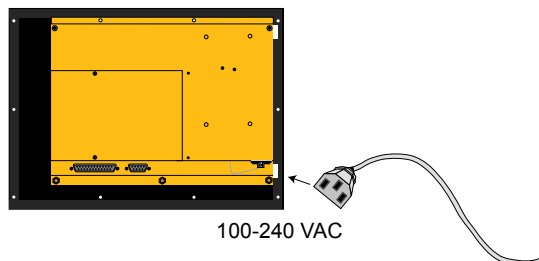

Kabeltabelle

Name	Kontinental-europa	GB	USA	Rest der Welt
Cable 1	MAC-PC-CAB-R2/ CAB5	MAC-PROG/9-CAB/ CAB5	MTA-PROG-C/ CAB5	MAC-PROG/9-CAB/ CAB5
Cable 2	CAB6	CAB6	CAB6	CAB6

D

Anschluss an einen Personal Computer

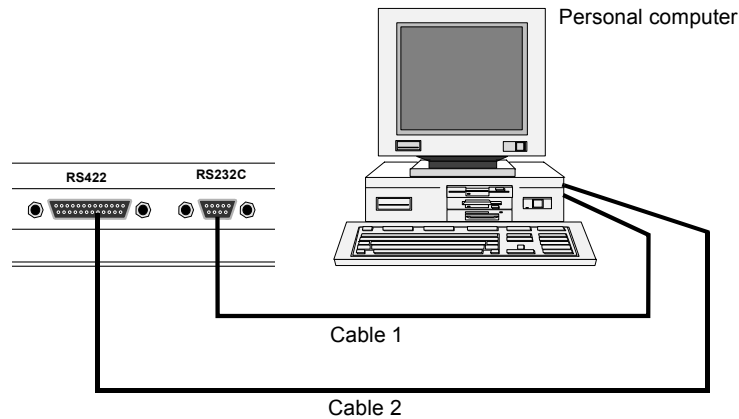

Die Programmierung des Terminals wird über die Software E-Designer vorgenommen. Die Kommunikationsparameter im Terminal und in der PC-Software müssen übereinstimmen.

Anschluss an einen Drucker

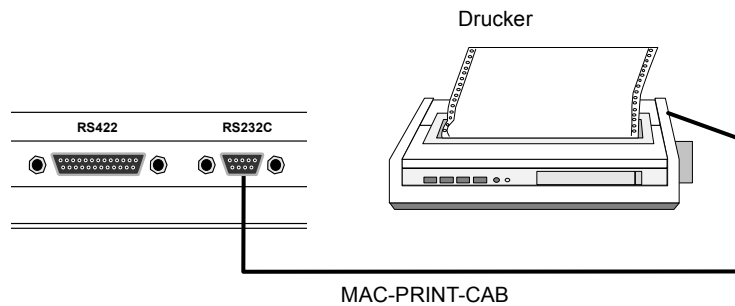

Der Drucker muß über eine serielle Schnittstelle und den IBM-Zeichensatz verfügen. Beachten Sie die Hinweise in der Bedienungsanleitung Ihres Druckers. Wenn Sie das Terminal an einen Drucker mit einer parallelen Schnittstelle anschließen möchten, müssen Sie die Erweiterungskarte IFC PI einsetzen. Weitere Informationen hierzu erhalten Sie in der Bedienungsanleitung zum IFC PI.

Indhold

Sikkerheds forholdsregler	2
Introduktion.....	4
Installation.....	5
Tekniske data.....	A-1
Tilslutning till MELSEC PLC-system	B-1
Indstillinger for C24 modulet på MELSEC PLC system.....	C-1
Front data.....	D-1
Panel tegning	E-1
Kabeltegning	F-1

Ønskes der mere detaljerede oplysninger om håndtering af operatørpanelet, henvises til manualen for dette.

© Beijer Electronics AB 2002

Läs hela Installationsmanualen innan produkten installeras och används. Produkten skall installeras, användas och repareras av adekvat personal. Beijer Electronics AB förbjuder all modifiering, ändring, eller ombyggnad av utrustningen. På grund av det stora antalet användningsområden för denna utrustning, måste användaren själv inhämta tillräcklig kunskap för att rätt använda denna i sin speciella applikation. Endast reservdelar godkända enligt specifikation från Beijer Electronics AB får användas.

BEIJER ELECTRONICS AB FRÆLÆGGER SIG ALT ANSVAR DER MÅTTE OPSTÅ I FORBINDELSE MED INSTALLATIONEN AF DETTE PRODUKT, OM DET MÅTTE VÆRE DIREKTE ELLER INDIREKTE SKADER DER ER OPSTÅET VED REPARATION ELLER ANVENDELSE AF DETTE PRODUKT.

Sikkerhedsforskrifter

Generelt

- Læs sikkerhedsforskrifterne grundigt igennem.
- Kontrollér leverancen for eventuelle transportskader. Giv straks leverandøren besked i tilfælde af skader.
- Terminalen opfylder kravene efter artikel 4 i EMC-direktivet 89/336/EØF.
- Anvend ikke terminalen i et miljø med stor eksplosionsfare.
- Leverandøren påtager sig ikke noget ansvar for modificeret, ændret eller ombygget udstyr.
- Anvend kun reservedele og tilbehør, der er fremstillet i overensstemmelse med leverandørens specifikationer.
- Læs installations- og betjeningsvejledningen grundigt igennem, inden du installerer, anvender eller reparerer terminalen.
- Ved forkert montering af batteriet kan der opstå eksplosionsfare. Anvend kun batterier, der er anbefalet af leverandøren.
- Undgå, at der kommer væske i terminalens huller eller åbninger. I modsat fald kan udstyret blive strømførende, og der kan opstå brand.
- Sørg for, at terminalen kun håndteres af personer med relevant uddannelse.

Ved installation

- Terminalen er konstrueret med henblik på fast installation på en plan overflade.
- Anbring terminalen på et stabilt underlag under installationen. Hvis terminalen tabes eller falder på gulvet, kan der opstå skader.
- Installer terminalen i overensstemmelse med den medfølgende installationsvejledning.
- Forbind terminalen til et stik med jordforbindelse i overensstemmelse med den medfølgende installationsvejledning.
- Sørg for, at terminalen installeres af personer med relevant uddannelse.
- Hold højspændings-, signal- og spændingskabler adskilt.
- Sørg for, at spænding og polaritet fra strømkilden er korrekt, inden du kobler terminalen til.
- Dæk ikke åbningerne i kassen til, da de er beregnet til luftcirkulation.
- Placer ikke terminalen på steder, hvor den kan udsættes for stærke magnetfelter.
- Undgå at udsætte terminalen for direkte sollys.
- Kontrollér, at de perifere enheder er tilstrækkelige til terminalens anvendelsesformål.
- På visse terminalmodeller er displayet beklædt med en lamineret film for at minimere risikoen for ridser. Træk forsigtigt filmen af for at forhindre statisk elektricitet, der kan beskadige skærmen.

UL installation

- Power, input and output (I/O) wiring must be in accordance with Class I, Division 2 wiring methods (Article 501-4 (b) of the National Electrical Code, NFPA 70) and in accordance with the authority having jurisdiction.

**Ved anvendelse**

- Hold terminalen ren.
- Styr ikke nødstopfunktioner eller andre sikkerhedsfunktioner fra terminalen.
- Undgå at berøre taster, display etc. med skarpe genstande.

Service og vedligeholdelse

- Der ydes garanti i henhold til aftalen.
- Anvend et mildt rengøringsmiddel og en blød klud til rengøring af display og front.
- Sørg for, at terminalen repareres af personer med relevant uddannelse.

Ved afmontering og skrotning

- Genvinding af terminalen eller dele af terminalen skal ske i overensstemmelse med de gældende regler i de enkelte lande.
- Bemærk, at følgende komponenter indeholder dele, der kan være skadelige for helbred og miljø: lithiumbatteri, elektrolytkondensatorer samt display.

Introduktion

Panelet er et operatørpanel, der er udviklet til at klare de krav, der stilles til mand-maskine kommunikation.

De indbyggede funktioner i panelet indeholder blandt andet muligheder for at manøvrere og præsentere tekst, dynamisk indikering, alarm behandling, recept- og tidsstyring.

Panelet er for en stor del objektorienteret, hvilket gør det meget enkelt at arbejde i. Programmeringen af panelet foretages på PC'er via programmet E-Designer for Windows. Efter programmeringen i PC'eren overføres og lagres programmet i panelet.

Skifte mellem PROG och RUN ved at trykke på tasterne enligt tabellen samtidig.

Terminal	Tastekombinasjon
E50	[F1] + [F4]
E100, E150	[←] + [ENTER]
E200, E300, E600, E700, E900	[←] + [MAIN]
E610, E615, E910	Omskifteren på siden i position 4. RUN=position 0.
E710	[F1] + [F2] + [F4]

Ønskes der mere detaljerede oplysninger om håndtering af operatørpanelet, henvises til manualen for dette.

DK

Installation

Spændingsforsyning

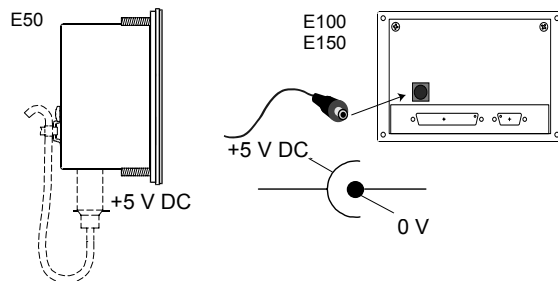
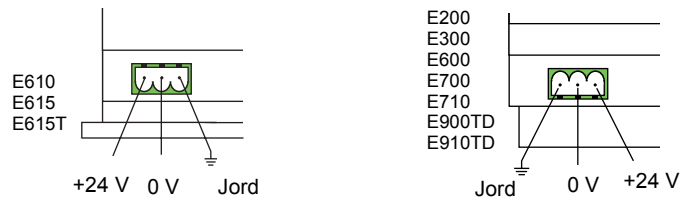

PAS PÅ!
Byt ikke om på + og -,
da forkert polairsering
vil give permanent
skade.

E900T/E900VT/E910T

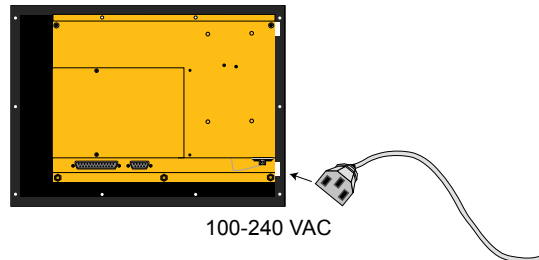

Lednings oversigt

Navn	Hele Europa	England	USA	Resten af verden
Cable 1	MAC-PC-CAB-R2/ CAB5	MAC-PROG/9-CAB/ CAB5	MTA-PROG-C/ CAB5	MAC-PROG/9-CAB/ CAB5
Cable 2	CAB6	CAB6	CAB6	CAB6

DK

Tilslutning til PC'er

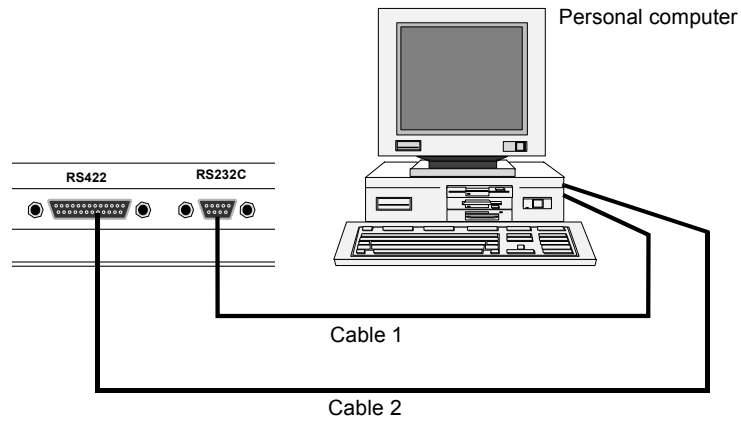

Panelet programmeres via programpakken E-Designer som skal være installeret på PC'eren. Kommunikations parametrene i panelet og E-Designer skal have samme indstilling.

Printertilslutning

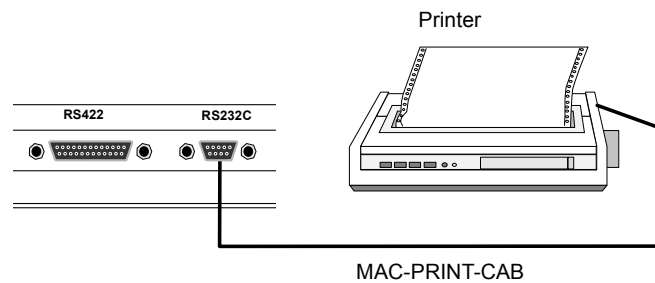

Printeren skal have en seriel snitflade og skal indeholde IBM-tegnsetning. Læs printerens manual for den korrekte konfiguration. For tilslutning til printer med parallelt snitflade anvendes ekspansionskortet IFC PI. Se manualen for IFC PI for yderlig information.

Contenidos

Medidas de seguridad.....	2
Introducción	4
Instalación	5
Datos Técnicos	A-1
Conexión del sistemas MELSEC PLC.....	B-1
Configuración para el módulo C24 en sistemas MELSEC PLC	C-1
Información	D-1
Esquema del terminal.....	E-1
Esquema del cableado	F-1

Para información más detallada remitase al terminal.

© Beijer Electronics AB 2002

Por favor lea detenidamente y completamente el "Manual de Instalación" antes de usar e instalar este producto. Este producto será instalado, manipulado y reparado solamente por personal cualificado. Beijer Electronics AB no es responsable de cualquier alteración o modificación de este producto. Debido a que existen muchas aplicaciones en las que se puede usar este producto, el usuario debe adquirir el conocimiento necesario para poder usar este producto en su aplicación particular. Solamente módulos y accesorios fabricados de acuerdo las especificaciones de Beijer Electronics AB podrán ser usadas en este producto.

BEIJER ELECTRONICS AB NO SERA RESPONSABLE DE NINGUN DAÑO DIRECTO,INDIRECTO, ESPECIAL, ACCIDENTAL O COMO CONSECUENCIA DE LA INSTALACION, USO O REPARACION DE ESTE PRODUCTO, EN EL CASO DE PRESENTACION DE DENUNCIA EL REMEDIO DEL VENDEDOR SERA REPARAR, SUSTITUIR O REEMBOLSAR SU PRECIO, Y LA ELECCION DEL REMEDIO APLICAR SERA A DISCRECCION DE BEIJER ELECTRONICS AB.

Reglas de seguridad

Generalidades

- Lea atentamente las reglas de seguridad.
- Controle el suministro para ver si se han producido daños de transporte. Si hay daños de transporte, notifíquelo inmediatamente al transportista.
- La terminal cumple con los requisitos del artículo 4 en la Directiva EMC 89/336/CEE.
- No use la terminal en un ambiente con alto riesgo de explosiones.
- El proveedor no asume la responsabilidad por un equipo modificado, alterado o reconstruido.
- Se deben utilizar únicamente repuestos y accesorios fabricados según la especificación del proveedor.
- Lea detenidamente las instrucciones de instalación y operación antes de instalar, usar o reparar la terminal.
- Si la batería es montada incorrectamente, puede surgir el riesgo de explosión. Use exclusivamente las baterías recomendadas por el proveedor.
- Nunca vierta líquidos en grietas u orificios de la terminal. Esto puede provocar incendios o la conductividad eléctrica del equipo.
- La terminal debe ser manipulada por personas que han recibido una formación adecuada.

Instalación

- La terminal está destinada a una instalación permanente sobre una superficie plana.
- Coloque la terminal sobre una base firme durante la instalación. La terminal puede dañarse si se cae o se deja caer.
- Instale la terminal conforme a las instrucciones de instalación que se incluyen en el suministro.
- La puesta a tierra se debe realizar conforme a las instrucciones de instalación que se incluyen en el suministro.
- La instalación debe ser realizada por personas que han recibido una formación adecuada.
- Los cables de alta tensión, de señales y de tensión deben separarse.
- Cerciórese de que la tensión y la polaridad de la fuente de energía sean correctas antes de conectar la tensión a la terminal.
- Las aberturas de la cubierta están destinadas a la circulación del aire y no deben cubrirse.
- No coloque la terminal en un lugar que pueda estar expuesto a campos magnéticos fuertes.
- La terminal no se debe montar a plena luz solar.
- Los equipos periféricos deben ser adecuados en el lugar de uso.
- Algunos modelos de terminal tienen una película laminada sobre el cristal del display para reducir el riesgo de rasguños. Para evitar la electricidad estática que puede ocasionar daños en la terminal, despegue la película con cuidado.

E

UL installation

- Power, input and output (I/O) wiring must be in accordance with Class I, Division 2 wiring methods (Article 501-4 (b) of the National Electrical Code, NFPA 70) and in accordance with the authority having jurisdiction.

Uso

- Mantenga limpia la terminal.
- Las funciones de parada de emergencia y otras funciones de seguridad no deben ser controladas desde la terminal.
- Las teclas, el cristal del display, etc. no deben ser activados con objetos puntiagudos.

Servicio y mantenimiento

- La garantía rige según el convenio.
- Para limpiar el cristal del display y el frente, use un detergente suave y un paño suave.
- Las reparaciones deben ser realizadas por personas que han recibido una formación adecuada.

Desmontaje y desguace

- El reciclaje de la terminal o piezas de la terminal debe cumplir con las reglas vigentes en cada país.
- Observe que los siguientes componentes contienen sustancias que pueden ser nocivas para la salud y el entorno: batería de litio, condensadores electrolíticos y display.

Introducción

El terminal es un panel de control de una familia de terminales desarrollados para satisfacer las necesidades de la comunicación entre operador y máquina. Las funciones incluidas en el terminal permiten la posibilidad de mostrar y controlar texto, indicadores dinámicos, alarmas, mantenimiento de recetas y canales de tiempo.

Los terminales tienen una forma de trabajar básicamente orientada a objeto, lo cual facilita bastante su utilización. El terminal se programa directamente desde un ordenador personal con el paquete de software E-Designer para Windows. De ahora en adelante nos referiremos al producto E-Designer como 'el software del PC'. Todo el proyecto se almacena en el terminal.

Para cambiar entre Modo Programación (PROG) y Modo Ejecución (RUN) es necesario pulsar simultáneamente las teclas de la siguiente tabla.

Terminal	Teclas
E50	[F1] + [F4]
E100, E150	[←] + [ENTER]
E200, E300, E600, E700, E900	[←] + [MAIN]
E610, E615, E910	The switch on the side of the terminal in position 4. RUN=la posición 0.
E710	[F1] + [F2] + [F4]

Para información más detallada remitase al terminal.

E

Instalación

Tensión de alimentación

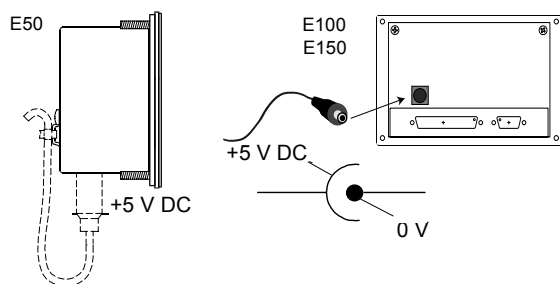
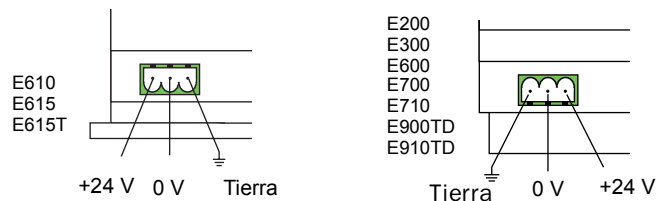

¡ATENCIÓN!
No aplique tensión
invertida. Causaría avería permanente.

E900T/E900VT/E910T



Tabla de cables

Nombre	Continente europeo	GB	USA	Resto del mundo
Cable 1	MAC-PC-CAB-R2/ CAB5	MAC-PROG/9-CAB/ CAB5	MTA-PROG-C/ CAB5	MAC-PROG/9-CAB/ CAB5
Cable 2	CAB6	CAB6	CAB6	CAB6

E

Conexión a un ordenador personal

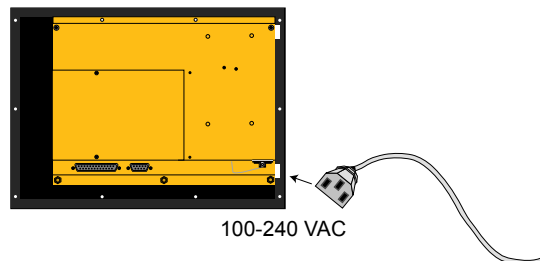
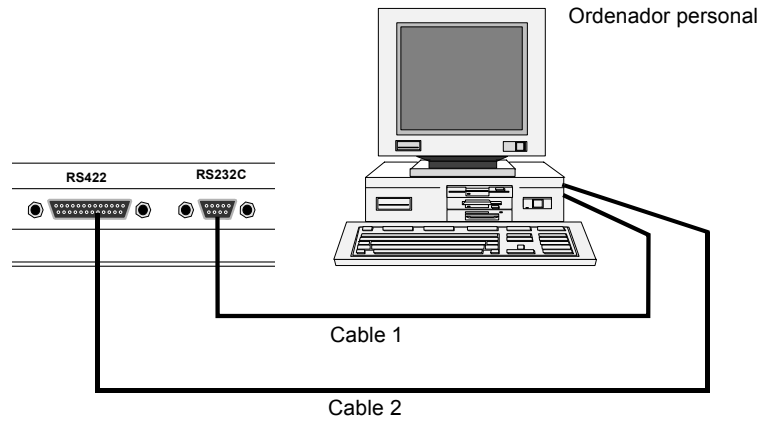

Para programar el terminal se recomienda el uso del software del PC. Para instalarlo consulte el manual específico del producto. Los parámetros en el terminal y en el software del PC deben ajustarse de la misma manera.

Conexión de una impresora

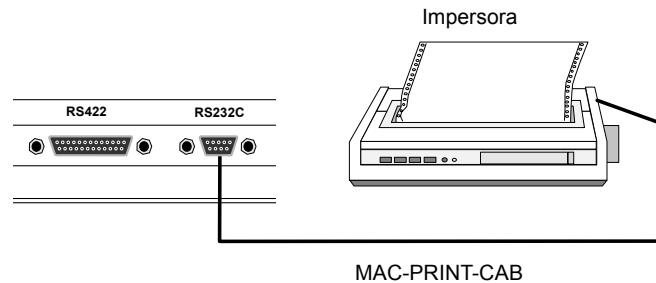

La impresora debe estar equipada de un interfaz serie y debe disponer del juego de caracteres IBM. Consulte el manual de la impresora para una correcta configuración. Si desea conectar el terminal a una impresora con un interfaz paralelo debe utilizar la tarjeta de expansión IFC PI. Ver el manual de la tarjeta para más información.

Sommaire

Précautions d'utilisations	2
Introduction	4
Installation.....	5
Caractéristiques techniques.....	A-1
Connexion sur les API MELSEC.....	B-1
Configuration du module C24 sur les API MELSEC.....	C-1
Face avant	D-1
Schema de connexion.....	E-1
Schema de cablage	F-1

Pour informations plus détaillées reportez-vous s'il vous plaît au manuel technique de l'appareil.

© Beijer Electronics AB 2002

Lisez complètement le manuel d'installation avant d'installer votre produit. Le produit doit être installé, utilisé et réparé par des gens compétents et qualifiés. Beijer Electronics AB ne peut être tenu responsable de toute dégradation ou modification du produit. Comme le produit peut être destiné à beaucoup d'applications différentes, l'utilisateur doit maîtriser la connaissance du produit. Seules des pièces ou machines fabriquées selon les spécifications de Beijer electronic AB doivent être utilisées avec le produit.

BEIJER ELECTRONIC NE PEUT ETRE ENU POUR RESPONSABLE DE TOUS DOMMAGES MONEURS OU MAJEURS DIRECTS OU INDIRECTS RESULTANT DE L'INSTALLATION. OU DE LA REPARATION DU PRODUIT. LA REPARATION EST DU RESSORT DE L'ACHETEUR, PEUT ETRE LA REPARATION LE REMPLACEMENT OU REMBOURSEMENT DU PRODUIT. LE CHOIX DE L'UNE DE CES METHODES EST DU SEULE RESSORT DE BEIJER ELECTRONICS AB.

Consignes de sécurité

Généralités

- Lire attentivement les consignes de sécurité.
- Contrôler la livraison afin de détecter les éventuels dommages dus au transport. Contacter le fournisseur au plus vite en cas de découverte de dommages.
- Le terminal remplit les exigences de l'article 4 de la directive sur la compatibilité électromagnétique 89/336/CEE.
- Ne pas utiliser le terminal dans un environnement présentant un risque élevé d'explosion.
- Le fournisseur décline toute responsabilité en cas de modification ou de reconstruction de l'équipement.
- Utiliser uniquement des pièces de rechange et des accessoires fabriqués conformément aux spécifications du fournisseur.
- Lire attentivement les instructions d'installation et d'utilisation avant de monter, d'utiliser ou de réparer le terminal.
- Un montage incorrect de la batterie peut entraîner un danger d'explosion. Utiliser uniquement des batteries recommandées par le fournisseur.
- Ne jamais verser de liquide dans les fentes et trous du terminal. Cela risque de déclencher un incendie ou l'équipement risque de devenir conducteur de courant.
- Le terminal doit être manipulé par des personnes ayant reçu une formation adéquate.

Lors de l'installation

- Le terminal est conçu pour une installation fixe sur une surface plane.
- Placer le terminal sur une surface solide pendant l'installation. Lâcher ou faire tomber le terminal risque de l'endommager.
- Installer le terminal conformément aux instructions d'installation fournies.
- La mise à la terre doit être effectuée conformément aux instructions d'installation fournies.
- L'installation doit être effectuée par des personnes ayant reçu une formation adéquate.
- Les câbles de haute tension, de signaux et de tension doivent être séparés.
- S'assurer que la tension et la polarité de la source d'alimentation sont correctes avant de mettre le terminal sous tension.
- Les ouvertures du boîtier sont destinées à permettre la circulation de l'air et ne doivent pas être recouvertes.
- Ne pas placer le terminal à un endroit où il risque d'être exposé à de forts champs magnétiques.
- Ne pas monter le terminal à un endroit où il est exposé à la lumière directe du soleil.
- Le cas échéant, les équipements périphériques utilisés doivent être appropriés.
- Certains modèles de terminaux sont équipés d'un film laminé sur l'écran d'affichage afin de minimiser le risque de rayures. Retirer prudemment le film afin d'éviter toute électricité statique risquant d'endommager le terminal.

UL installation

- Power, input and output (I/O) wiring must be in accordance with Class I, Division 2 wiring methods (Article 501-4 (b) of the National Electrical Code, NFPA 70) and in accordance with the authority having jurisdiction.

Lors de l'utilisation

- Maintenir le terminal propre.
- Les fonctions d'arrêt d'urgence et autres fonctions de sécurité ne doivent pas être commandées depuis le terminal.
- Les touches, l'écran d'affichage, etc., ne doivent pas entrer en contact avec des objets pointus.

Maintenance et entretien

- La validité de la garantie est conforme à l'accord.
- Utiliser un détergent neutre et un chiffon doux pour nettoyer l'écran d'affichage et l'avant.
- Les réparations doivent être effectuées par des personnes ayant reçu une formation adéquate.

Lors du démontage et de la mise au rebut

- Le recyclage du terminal ou de ses pièces doit être effectué conformément aux réglementations en vigueur dans le pays concerné.
- Noter que les composants suivants contiennent des substances pouvant être nuisibles à la santé et à l'environnement : batterie au lithium, condensateur électrolytes et affichage.

Introduction

Le terminal est une unité de contrôle et de commande, développée pour satisfaire aux demandes de communication homme machine. Le terminal a possibilité de visualiser et de contrôler des textes avec des variables dynamiques, des alarmes, des rapports, des canaux horodateurs.

Le terminal est programmé directement par un PC avec le logiciel de programmation E-Designer pour windows. Dans les paragraphes suivants ce produit sera désigné comme le logiciel PC.

Le projet de programme est entièrement stocké dans le terminal. Le terminal possède pour la plupart de ces fonctions un mode opératoire qui en facilite son utilisation.

Le passage de mode PROG à RUN se fait en pressant simultanément les touches montrées dans de tableau.

Terminal	Touches
E50	[F1] + [F4]
E100, E150	[←] + [ENTER]
E200, E300, E600, E700, E900	[←] + [MAIN]
E610, E615, E910	L'interrupteur à côté de terminal, en position 4. RUN=position 0.
E710	[F1] + [F2] + [F4]

Pour informations plus détaillées reportez-vous s'il vous plaît au manuel technique de l'appareil.

F

Installation

Alimentation

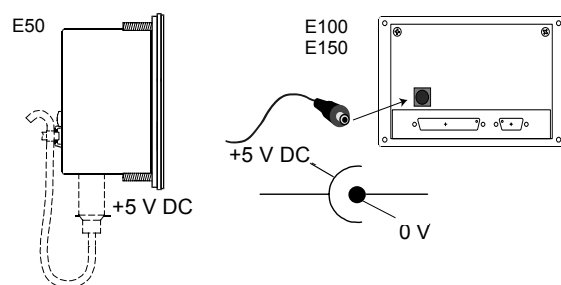
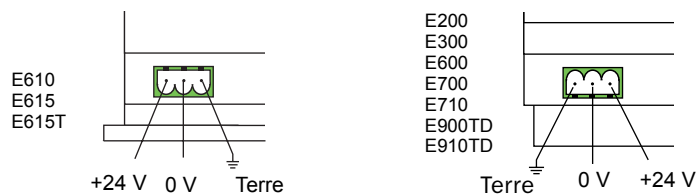

ATTENTION!
Ne pas effectuer une inversion de tension cela causerais une destruction de l'appareil.

E900T/E900VT/E910T

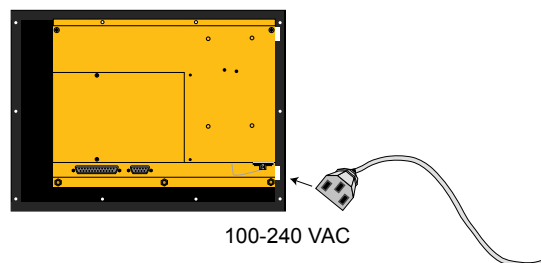

Cable table

Nom	Europe	GB	USA	Reste du monde
Cable 1	MAC-PC-CAB-R2/ CAB5	MAC-PROG/9-CAB/ CAB5	MTA-PROG-C/ CAB5	MAC-PROG/9-CAB/ CAB5
Cable 2	CAB6	CAB6	CAB6	CAB6

F

Raccordement à un PC

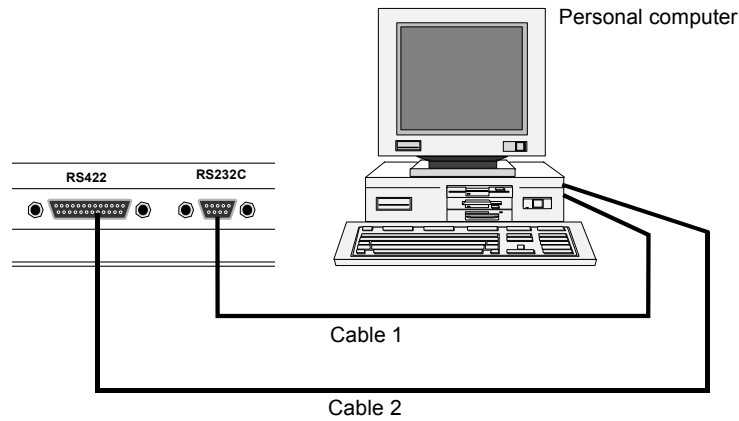

Pour programmer le terminal, il est recommandé d'utiliser le logiciel PC. Pour installer le logiciel PC référez-vous au manuel de ce produit. Il faut le paramétrage du logiciel PC et du terminal soient les mêmes.

Raccordement à une imprimante

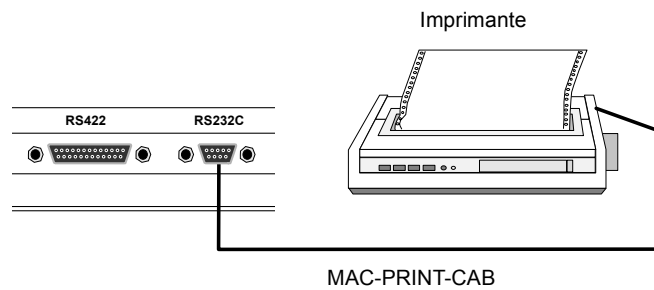

L'imprimante devra posséder un interface série et être équipée avec un ensemble de caractère IBM. Se référer au manuel de l'imprimante pour une configuration correcte. Si vous voulez connecter le pupitre à l'imprimante avec une liaison parallèle vous devez utiliser la carte d'extension IFC PI. Consultez le manuel pour le IFC PI pour plus d'informations.

Sisältö

Turvallisuusmääräykset	2
Johdanto	4
Asennus	5
Tekniset tiedot	A-1
Liittäminen MELSEC	B-1
MELSEC-logiikoiden C24 kommunikointimodulien asetukset.....	C-1
Etulevyn päällyskalvon ominaisuudet	D-1
Päätepiirroksiset.....	E-1
Kaapelipiirroksiset.....	F-1

Tarkemmat tiedot ovat päätteen käyttöohjeessa.

© Beijer Electronics AB 2002

Ystävällisesti tutustukaa koko asennuskäsikirjaan täydellisesti ja huolellisesti ennen tämän tuotteen asennusta ja käyttöä. Vain ammattihenkilöiden tulisi asentaa, käyttää ja korjata tuotetta. Beijer Electronics AB ei ole vastuussa, mikäli tuotetta on muunneltu tai muokattu. Koska tuotetta voidaan käyttää monessa eri sovelluksessa, on käyttäjän hankittava tarvittava asiantuntemus tuotteen käyttämiseksi hänen nimenomaan suunnittelemassaan sovelluksessa. Tämän tuotteen yhteydessä tulee käyttää ainoastaan Beijer Electronics AB:n antamien määräytysten mukaisesti valmistettuja osia ja tarvikkeita.

BEIJER ELECTRONICS AB EI OLE VASTUUSSA KENELLEKÄÄN MINKÄÄNLAISESTA VÄLITTÖMÄSTÄ TAI VÄLILLISESTÄ VAHINGOSTA, JOKA JOHTUU TÄMÄN TUOTTEEN ASENNUKSESTA, KÄYTÖSTÄ TAI KORJAUKSESTA, RIIPPUMAATTA SIITÄ, ONKO VAHINKO SYNTYNYT OIKEUDENLOUKKAUKSEN, SOPIMUSSUHTEEN TAI MUIDEN OLOSUHTEIDEN PERUSTEELLA. OSTAJA VOI AINOASTAAN VAATIA TUOTTEEN KORJAAMISTA TAI KORVAAMISTA UUDELLA TAIKKA KAUPPAHINNAN PALAUTUSTA, JA BEIJER ELECTRONICS AB ON OIKEUTETTU YKSIN VALITSEMAAN NÄISTÄ SOPIVAKSI KATSO-MANSA KEINON.

Turvamääräykset

Yleistä

- Lue turvamääräykset huolellisesti.
- Tarkasta toimitus havaitaksesi mahdolliset kuljetusvauriot. Ilmoita havaitut vauriot pikimmiten toimittajalle.
- Pääte täyttää EMC-direktiivin 89/336/EEC artiklan 4 mukaiset vaatimukset.
- Älä käytä päätettä ympäristössä, jossa on suuri räjähdysvaara.
- Toimittaja ei vastaa laitteesta, johon on tehty modifiointeja, muutoksia tai lisäyksiä.
- Vain toimittajan määrittysten mukaisia lisävarusteita saa käyttää.
- Lue asennus- ja käyttökuvaus huolellisesti ennen päätteen asennusta, käyttöä tai korjausta.
- Virheellisesti asennettu akku voi aiheuttaa räjähdysvaaran. Käytä vain toimittajan suosittelemia akkuja.
- Nestettä ei koskaan saa kaataa päätteen rakoihin tai reikiin. Seurauksena voi olla tulipalo tai laitteen muuttuminen virtaa johtavaksi.
- Päätettä saa käsitellä vain tarvittavan koulutuksen saanut henkilökunta.

Asennus

- Pääte on tarkoitettu kiinteään asennukseen tasaiselle pinnalle.
- Sijoita pääte tukevalle alustalle asennuksen ajaksi. Päätteen pudottaminen tai putoaminen voi aiheuttaa vahinkoa.
- Asenna pääte mukana toimitetun asennusohjeen mukaisesti.
- Maadoitus on tehtävä mukana toimitetun asennusohjeen mukaisesti.
- Asentajalla on oltava tarvittava koulutus.
- Suurjännite-, signaali- ja jännitekaapelit on erotettava toisistaan.
- Varmista, että teholähteestä saatavan jännite ja napaisuus ovat oikein ennen jännitteen kytkemistä päätteeseen.
- Kotelon aukot ovat kiertoilma-aukkoja eikä niitä saa peittää.
- Älä sijoita päätettä paikkaan, jossa se on alttiina voimakkaille magneettikentille.
- Päätettä ei saa asentaa suoraan auringonvaloon.
- Oheislaitteiden on sovelluttava käyttökohteisiinsa.
- Joidenkin päätemallien näytöissä on laminoitu kalvo naarmuuntumisvaaran vähentämiseksi. Vedä kalvo irti varovasti, ettei se synnytä staattista sähköä, joka voi vaurioittaa päätettä.

UL installation

- Power, input and output (I/O) wiring must be in accordance with Class I, Division 2 wiring methods (Article 501-4 (b) of the National Electrical Code, NFPA 70) and in accordance with the authority having jurisdiction.



Käyttö

- Pidä pääte puhtaana.
- Häätäpysäytystoimintoja tai muita turvatoimintoja ei saa ohjata päätteestä.
- Näppäimiä, näyttöruutua jne. ei saa käsitellä terävillä esineillä.

Huolto ja kunnossapito

- Takuu on voimassa sopimuksen mukaisesti.
- Käytä mietoa puhdistusainetta ja pehmeää liinaa näyttöruudun ja etuosan puhdistukseen.
- Korjaukset saa tehdä vain tarvittavan koulutuksen omaavat henkilöt.

Purkaminen ja romutus

- Pääte tai sen osat on kierrätettävä käyttömaassa voimassa olevien määräysten mukaisesti.
- Huomaa, että seuraavat komponentit sisältävät aineita, jotka voivat olla haitallisia terveydelle ja ympäristölle: litiumakku, elektrolyyttikondensaattorit sekä näyttö.

Johdanto

Pääte on käyttäjän pääte perheessä, joka on suunniteltu täyttämään kone-käyttäjä kommunikoinnin asettamat vaatimukset. Pääteen sisäänrakennetut toiminnot antavat mahdollisuuden esittää tekstejä näytössä. Näytöissä voi olla dynaamisia muuttujia kuten osoituksia, ohjauksia, hälytyksiä ja viikkokellotoimintoja.

Suurin osa sovelluksen teosta on objektorientoitunutta, mikä tekee pääteen ohjelmoinnin helpoksi. Pääte voidaan ohjelmoida suoraan pääteen omalta näppäimistöllä tai tietokoneen ja MAC Programmer+ for Windows-ohjelmiston avulla. Tästä eteenpäin tuotteen nimi on lyhennetty muotoon "tietokoneohjelma". Tehty sovellus tallennetaan kokonaisuudessaan pääteen muistiin.

Painamalla taulukon mukaisia painikkeita yhtäaikaan pääteen toimintatilaa voidaan vaihtaa ohjelmointitilan (PROG) ja Run-tilan välillä.

Pääte	Näppäinyhdistelmä
E50	[F1] + [F4]
E100	[←] + [ENTER]
E200, E300, E600, E700, E900	[←] + [MAIN]
E610, E615, E910	The switch on the side of the terminal in position number 4. RUN-tilan=0
E710	[F1] + [F2] + [F4]

Tarkemmat tiedot ovat pääteen käyttöohjeessa.

FIN

Asennus

Jännitesyöttö

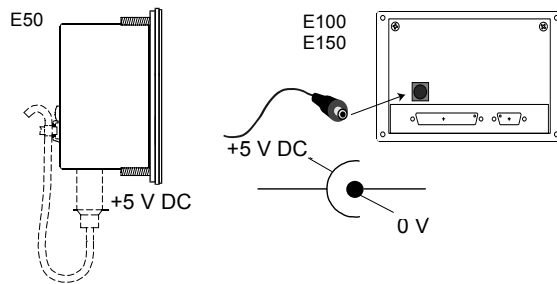
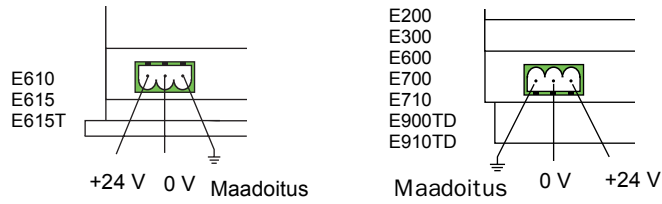

VAROITUS!
Jännitteen kytkeminen
väärin saattaa vaurioit-
taa päätettä pysyvästi.

E900T/E900VT/E910T

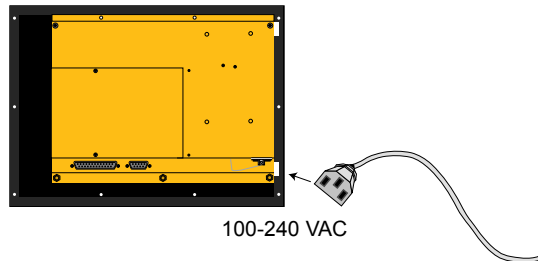

Kaapelitaulukko

Nimi	Manner- Eurooppa	GB	USA	Muu maailma
Cable 1	MAC-PC-CAB-R2/ CAB5	MAC-PROG/9-CAB/ CAB5	MTA-PROG-C/ CAB5	MAC-PROG/9-CAB/ CAB5
Cable 2	CAB6	CAB6	CAB6	CAB6

FIN

Liittäminen tietokoneeseen

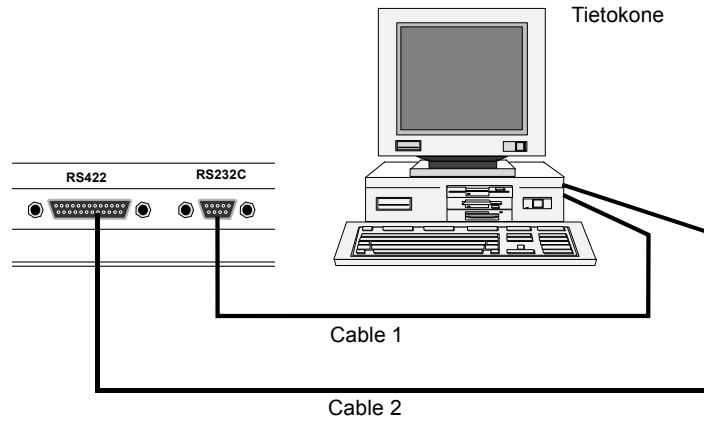

Päätteen ohjelmointiin suositellaan käytettäväksi tietokoneohjelmaa. Ohjelman asentaminen tietokoneeseen on selostettu ohjelmiston käsikirjassa. Kommunikointiparametrit soveluksen siirtoa varten täytyvät olla samat ohjelmassa ja päätteessä.

Kirjoitinliityntä

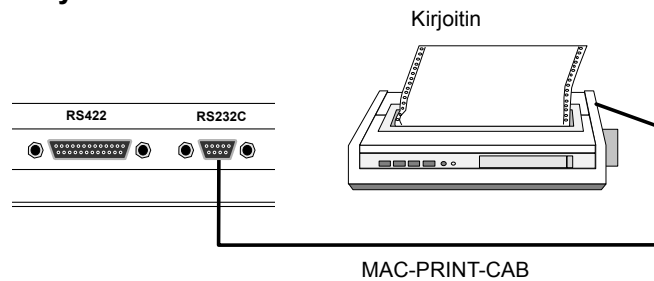

Kirjoittimessa täytyy olla sarjaliitettä ja IBM merkistö. Katso kirjoittimen ohjekirjasta mitkä ovat oikeat määrittelyt. Mikäli päätteeseen liitetään kirjoitin jossa on rinnakkaisliitettä, on päätteessä käytettävä IFC PI-laajennuskorttia. Lisätietoja on IFC PI-kortin ohjekirjassa.

Contents

Safety precautions	2
Introduction	4
Installation.....	5
Technical data.....	A-1
Connection to MELSEC PLC systems	B-1
Settings for the C24 module on MELSEC PLC systems.....	C-1
Front data.....	D-1
Terminal drawings.....	E-1
Cable drawings	F-1

For more detailed information please see the Manual for the terminal.

© Beijer Electronics AB 2002

Please read the entire Installation Manual completely and carefully prior to the installation and use of this product. The product should be installed, operated and repaired by qualified personnel only. Beijer Electronics AB is not responsible for any alterations or modification of this product. Because of the many applications for the use of this product, the user must acquire the appropriate knowledge needed to properly use the product for the particular application contemplated. Only parts and accessories manufactured according to specifications of Beijer Electronics AB should be used with this product.

BEIJER ELECTRONICS AB SHALL NOT BE LIABLE TO ANYONE FOR ANY DIRECT, INDIRECT, SPECIAL, INCIDENTAL OR CONSEQUENTIAL DAMAGES RESULTING FROM THE INSTALLATION, USE OR REPAIR OF THIS PRODUCT, WHETHER ARISING IN TORT, CONTRACT OR OTHERWISE. BUYER'S SOLE REMEDY SHALL BE THE REPAIR, REPLACEMENT OR REFUND OF PURCHASE PRICE, AND THE CHOICE OF THE APPLICABLE REMEDY SHALL BE AT THE SOLE DISCRETION OF BEIJER ELECTRONICS AB.

Safety precautions

General

- Read the safety precautions carefully.
- Check the delivery for transportation damage. If damage is found, notify the supplier as soon as possible.
- The terminal fulfills the requirements of article 4 of EMC directive 89/336/EEC.
- Do not use the terminal in an environment with high explosive hazards.
- The supplier is not responsible for modified, altered or reconstructed equipment.
- Use only parts and accessories manufactured according to specifications of the supplier.
- Read the installation and operating instructions carefully before installing, using or repairing the terminal.
- Replacing the battery incorrectly may result in explosion. Only use batteries recommended by the supplier.
- Never pour fluids into any openings in the terminal. This may cause fire or electrical shock.
- Only qualified personnel may operate the terminal.

During installation

- The terminal is designed for stationary installation on a plane surface.
- Put the terminal on a stable surface during installation. Dropping it or letting it fall may cause damage.
- Install the terminal according to the accompanying installation instructions.
- Ground the terminal according to the accompanying installation instructions.
- Only qualified personnel may install the terminal.
- Separate the high voltage, signal and supply cables.
- Make sure that the voltage and polarity of the power source is correct before connecting the terminal to the power outlet.
- The openings on the enclosure are for air convection. Do not cover these openings.
- Do not place the terminal where it might be exposed to strong magnetic fields.
- Do not install the terminal in direct sunlight.
- Peripheral equipment must be appropriate for the application.
- Some terminal models have a laminated film over the display to reduce the risk of scratches. To avoid static electricity that might damage the terminal, carefully remove the film.

UL installation

- Power, input and output (I/O) wiring must be in accordance with Class I, Division 2 wiring methods (Article 501-4 (b) of the National Electrical Code, NFPA 70) and in accordance with the authority having jurisdiction.

During use

- Keep the terminal clean.
- Emergency stop and other safety functions may not be controlled from the terminal.
- Do not touch the keys, displays, etc. with sharp objects.



Service and maintenance

- The agreed warranty applies.
- Clean the display and face with a soft cloth and mild detergent.
- Only qualified personnel should carry out repairs.

Dismantling and scrapping

- The terminal or parts thereof shall be recycled according to local regulations.
- The following components contain substances that might be hazardous to health and the environment: lithium battery, electrolytic capacitor and display.

Introduction

The terminal is an operator panel in a family of terminals developed to satisfy the demands of human-machine communication. The built-in functions in the terminal include the possibility to display and control text, dynamic indication, alarm, recipe handling and time channels.

The terminals have, for the most part, an object-oriented way of working, which makes them easy to use. The terminal can be programmed directly from the terminal or from a personal computer with the software package E-Designer for Windows. Hereafter, the product E-Designer is referred to as the PC software. The developed project is transferred to the terminal and stored in the terminal.

Switch between Programming mode, PROG, and Run-time mode, RUN, by pressing the keys according to the following table simultaneously.

Terminal	Key combination
E50	[F1] + [F4]
E100, E150	[←] + [ENTER]
E200, E300, E600, E700, E900	[←] + [MAIN]
E610, E615, E910	The switch on the back/side of the terminal in position number 4. RUN=position 0
E710	[F1] + [F2] + [F4]

For more detailed information please see the manual for the terminal.

GB

Installation

Voltage requirement

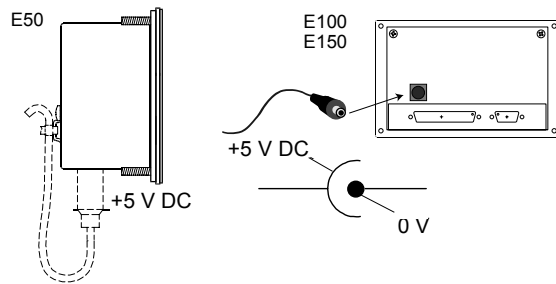
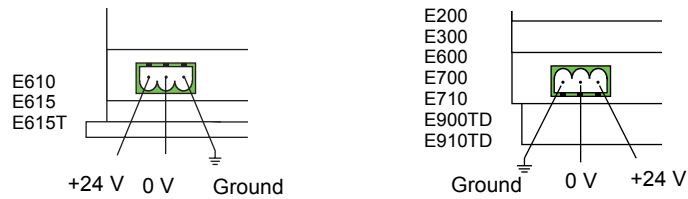

CAUTION!
Do not apply reverse voltage, it can cause permanent damage.

E900T/E900VT/E910T

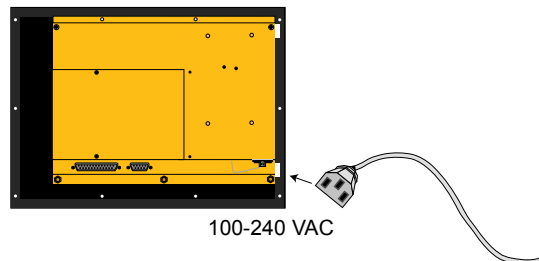

Cable table

Name	Continental Europe	GB	USA	Rest of the world
Cable 1	MAC-PC-CAB-R2/ CAB5	MAC-PROG/9-CAB/ CAB5	MTA-PROG- C/CAB5	MAC-PROG/9-CAB/ CAB5
Cable 2	CAB6	CAB6	CAB6	CAB6

GB

Connection to a personal computer

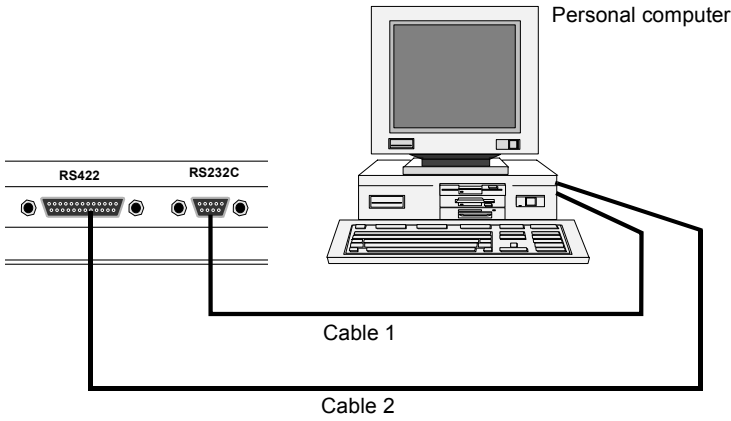

To program the terminal it is recommended that the PC software is used. To install the PC software see the manual for this product. The communication parameters in the terminal and in the PC software should be set in the same way.

Connection to a printer

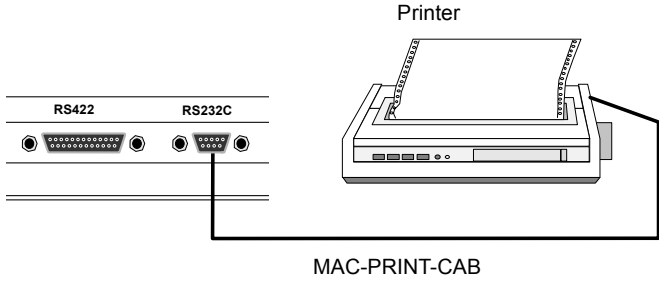

The printer should have a serial interface and be equipped with IBM character set. Refer to the printer manual for the correct configuration. If you want to connect the terminal to a printer with a parallel interface you have to use the expansion card IFC PI. See the manual for IFC PI for further information.

Indice

Precauzioni di sicurezza.....	2
Introduzione	4
Installazione	5
Dati Tecnici	A-1
Connessione del PLC MELSEC	B-1
Impostazione del modulo C24 nei PLC MELSEC	C-1
Frontale.....	D-1
Schema del terminale	E-1
Schema del cavo	F-1

Per ulteriori informazioni consultare il manuale del pannello operatore.

© Beijer Electronics AB 2002

Per cortesia leggere interamente il manuale di installazione ed uso di questo prodotto. Il prodotto deve essere installato, usato e riparato da personale qualificato. Beijer Electronics non è responsabile per qualsiasi alterazione o modifica effettuata sul prodotto. Poiché il prodotto può essere utilizzato per svariate applicazioni: l'utente deve acquisire l'appropriata conoscenza necessaria per un uso corretto.

CON QUESTO PRODOTTO POSSONO ESSERE SOLAMENTE UTILIZZATE PARTI ED ACCETTORI SECONDO LE SPECIFICHE DELLA BEIJER ELECTRONICS AB. A BEIJER ELECTRONICS AB NON È RESPONSABILE DI QUALQASI DANNO DIRETTO E INDIRETTO CHE SIA PROVOCATO DA UNA INSTALLAZIONE, USO E RIPARAZIONE DI QUESTO PRODOTTO.

Norme di sicurezza

Generalità

- Leggere attentamente le norme di sicurezza.
- Controllare che la merce consegnata non abbia subito danni durante il trasporto; in caso contrario comunicare al più presto i danni rilevati al fornitore.
- Il terminale soddisfa i requisiti stabiliti dall'art. 4 della direttiva EMC 89/336/CEE.
- Non utilizzare il terminale in un ambiente in cui sussiste un forte rischio di esplosione.
- Il fornitore non si assume la responsabilità per attrezzature modificate, manomesse o ricostruite.
- Utilizzare esclusivamente ricambi ed accessori prodotti secondo le specifiche del fornitore.
- Leggere attentamente le istruzioni per l'installazione e l'uso prima di installare, utilizzare o riparare il terminale.
- In caso di montaggio errato della batteria, sussiste il pericolo di esplosione. Utilizzare esclusivamente le batterie raccomandate dal fornitore.
- Non versare mai liquidi nelle aperture o nei fori del terminale, poiché potrebbero provocare incendi o trasformare l'attrezzatura in elemento elettroconduttore.
- Il terminale deve essere utilizzato da personale addestrato.

Durante l'installazione

- Il terminale è costruito per installazioni fisse su superfici piane.
- Durante l'installazione, posizionare il terminale su un piano stabile. In caso di caduta, il terminale potrebbe danneggiarsi.
- Installare il terminale secondo le istruzioni per l'installazione allegate.
- Effettuare la messa a terra secondo le istruzioni per l'installazione allegate.
- L'installazione deve essere effettuata da personale addestrato.
- Tenere separati i cavi di alta tensione, segnale e tensione.
- Prima di dare tensione al terminale, assicurarsi che la tensione e la polarità di rete siano corrette.
- Le aperture presenti nell'involucro sono destinate alla circolazione dell'aria e non devono essere coperte.
- Non posizionare il terminale in luoghi in cui sussiste il rischio di forti campi elettromagnetici.
- Non installare il terminale in modo che sia esposto a luce solare diretta.
- L'attrezzatura complementare deve essere adatta all'ambiente in cui è utilizzata.
- Il display di alcuni modelli di terminali è protetto da una pellicola antigraffio. Per evitare la formazione di elettricità statica che potrebbe danneggiare il terminale, rimuovere con cura la pellicola.

**UL installation**

- Power, input and output (I/O) wiring must be in accordance with Class I, Division 2 wiring methods (Article 501-4 (b) of the National Electrical Code, NFPA 70) and in accordance with the authority having jurisdiction.

Durante l'uso

- Tenere il terminale pulito.
- Non attivare le funzioni di arresto di emergenza o altre funzioni di sicurezza dal terminale.
- Non utilizzare oggetti affilati su tasti, display ecc.

Assistenza e manutenzione

- La garanzia segue le clausole del contratto.
- Per pulire il display e il frontalino, utilizzare detergente neutro ed un panno morbido.
- Le riparazioni devono essere effettuate da personale addestrato.

In sede di smontaggio e rottamazione

- Il riciclaggio del terminale o di parti di esso deve avvenire in base alla vigente legislazione nazionale.
- Ricordare che i seguenti componenti contengono sostanze nocive per la salute e l'ambiente: batterie al litio, condensatori ad elettrolito e display.



Introduzione

Il terminale é uno dei pannelli operatore della famiglia di terminali sviluppati per soddisfare le richieste di comunicazione uomo-macchina. Le funzioni implementate nei terminali, oltre le altre cose, contengono la possibilità di visualizzare testi e grafici in modo dinamico, controlli, allarmi, stampa di report e canali a tempo.

I terminali, per la maggior parte, hanno un modo di lavoro orientato agli oggetti, che li rende facili da usare.

I terminali si programmano direttamente dalla tastiera del frontale oppure tramite un software su personal computer per Windows chiamato E-Designer. L'intero progetto programmato viene memorizzato nel pannello.

Selezionare tra Programming mode, PROG e Run TIME, schiacciando simultaneamente i tasti come da tabella allegata.

Terminal	Key combination
E50	[F1] + [F4]
E100, E150	[←] + [ENTER]
E200, E300, E600, E700, E900	[←] + [MAIN]
E610, E615, E910	The switch on the side of the terminal in position number 4. RUN=position 0.
E710	[F1] + [F2] + [F4]

Per ulteriori informazioni consultare il manuale del pannello operatore.



Installazione

Alimentazione

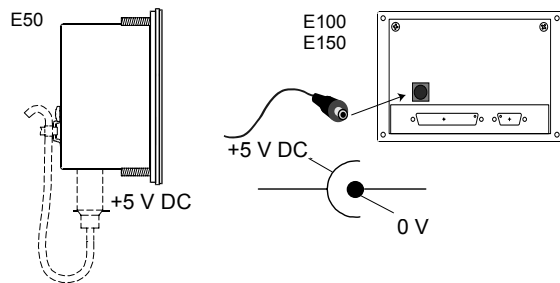
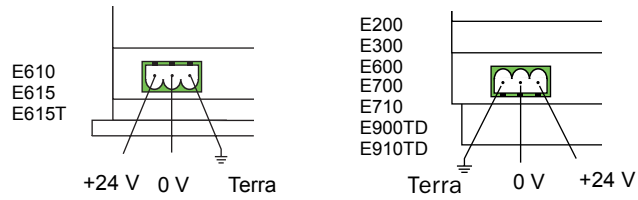

Attenzione!
Non invertire la polarità in
quanto si causano danni
permanenti.

E900T/E900VT/E910T



Tabella cavo

Nome	Europa continentale	GB	USA	Resto del mondo
Cable 1	MAC-PC-CAB-R2/ CAB5	MAC-PROG/9-CAB/ CAB5	MTA-PROG-C/ CAB5	MAC-PROG/9-CAB/ CAB5
Cable 2	CAB6	CAB6	CAB6	CAB6

1

Connessione ad un Personal computer

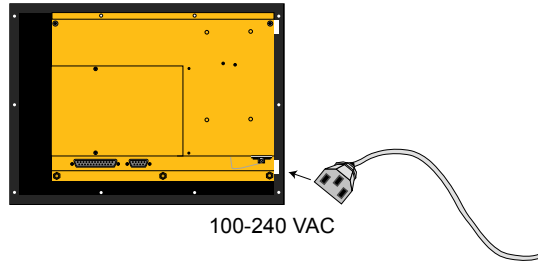
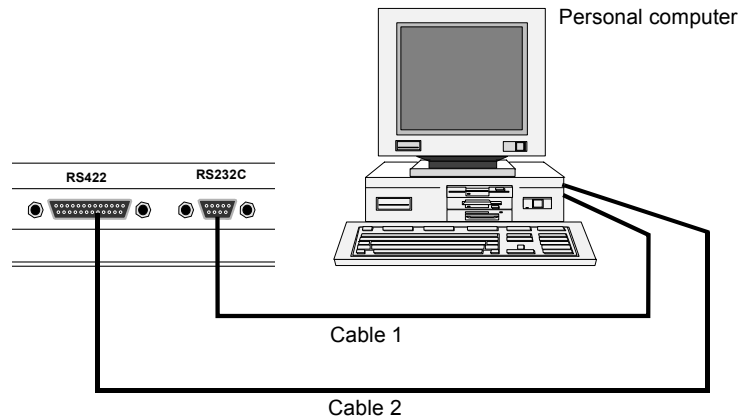

Per programmare il terminale si deve di usare il Software relativo. Per installare il software vedere il manuale del prodotto. I Parametri di comunicazione del terminale e del software di programmazione devono essere settati nello stesso modo.

Connessione ad una stampante

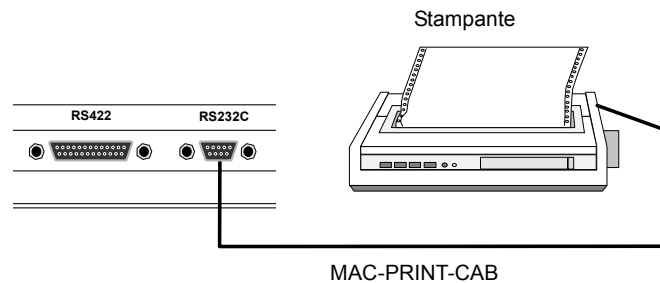

La stampante deve avere l'interfaccia seriale e deve essere IBM compatibile. Fare riferimento al manuale della stampante per la configurazione corretta. Se si vuole collegare il terminale ad una stampante parallela, si usare la scheda di espansione IFC PI. Per ulteriori informazioni consultare il manuale della IFC PI.

Innhold

Sikkerhetsforskrifter.....	2
Introduksjon	4
Installasjon	5
Tekniske data.....	A-1
Tilkobling til MELSEC PLS-system.....	B-1
Innstillinger for C24 modul på MELSEC PLS-system.....	C-1
Frontdata.....	D-1
Terminal tegning.....	E-1
Kabel tegning	F-1

For mer detaljert informasjon angående håndtering av terminalen henvises det til manualen for terminalen.

© Beijer Electronics AS 2002

Les hele Installasjonsmanualen før produktet installeres og brukes. Produktet skal installeres, brukes og repareres av kompetent personale. Beijer Electronics AS forbyr all modifisering, endringer eller ombygging av utstyret. På grunn av det store antallet brukerområder for dette utstyret, må brukeren selv innhente tilstrekkelig kunnskap for å bruke denne i sin spesielle applikasjon. Kun reservedeler som er godkjent i henhold til spesifikasjoner fra Beijer Electronics AS kan brukes.

BEIJER ELECTRONICS AS FRASKRIVER SEG ALT ANSVAR FOR DIREKTE ELLER INDIREKTE SKADER SOM FØLGE AV INSTALLASJON, BRUK ELLER REPARASJON AV DETTE PRODUKTET.

Sikkerhetsforskrifter

Generelt

- Les nøye gjennom sikkerhetsforskriftene.
- Kontroller leveransen for å oppdage eventuelle transportskader. Underrett leverandøren snarest dersom det oppdages skader.
- Terminalen oppfyller kravene ifølge artikkel 4 i EMC-direktivet 89/336/EEC.
- Ikke bruk terminalen i et miljø der det er stor risiko for eksplosjoner.
- Leverandøren tar ikke ansvar for modifisert, endret eller ombygd utstyr.
- Det må kun brukes reservedeler og tilbehør lagd ifølge leverandørens spesifikasjoner.
- Les installerings- og brukerbeskrivelsen nøye før terminalen installeres, brukes eller repareres.
- Det kan oppstå fare for eksplosjon dersom batteriet monteres feil. Bruk kun batterier som anbefales av leverandøren.
- Det må aldri helles væske i sprekker eller hull i terminalen. Dette kan forårsake brann eller at utstyret blir strømførende.
- Terminalen skal håndteres av personer med adekvat opplæring.

Ved installering

- Terminalen er konstruert for faste installasjoner på en plan flate.
- Plasser terminalen på et stabilt underlag under installeringen. Hvis terminalen mistes eller faller ned, kan det oppstå skader.
- Installer terminalen ifølge vedlagte installeringsbeskrivelse.
- Jording skal skje ifølge vedlagte installeringsbeskrivelse.
- Installering skal utføres av personer med adekvat opplæring.
- Høyspennings-, signal- og spenningskabler må separeres.
- Slå fast at spenning og polaritet fra kraftkilden er korrekt før terminalen settes under spenning.
- Åpningene i dekselet er ment til luftsirkulasjon og må ikke tildekkes.
- Ikke plasser terminalen der det er risiko for at den utsettes for kraftige magnetfelt.
- Terminalen bør ikke monteres i direkte sollys.
- Periferutstyr må være egnet der det brukes.
- Enkelte terminalmodeller har en laminert film over displayglasset for å redusere risikoen for riper. Trekk filmen forsiktig av for å unngå statisk elektrisitet som kan forårsake skader på terminalen.

UL installation

- Power, input and output (I/O) wiring must be in accordance with Class I, Division 2 wiring methods (Article 501-4 (b) of the National Electrical Code, NFPA 70) and in accordance with the authority having jurisdiction.

Ved bruk

- Hold terminalen ren.
- Nødstoppsfunksjoner eller andre sikkerhetsfunksjoner må ikke styres fra terminalen.
- Taster, displayglass osv. må ikke påvirkes med spisse gjenstander.

Service og vedlikehold

- Garanti gjelder ifølge avtale.
- Bruk mildt rengjøringsmiddel og myk klut for å rengjøre displayglass og front.
- Reparasjoner skal utføres av personer med adekvat opplæring.

Ved demontering og kassering

- Gjenvinning av terminalen eller deler av terminalen skal skje ifølge gjeldende regler i respektive land.
- Legg merke til at følgende komponenter inneholder stoffer som kan være skadelige for helse og miljø: litiumbatteri, elektrolyttkondensatorer samt display.

Introduksjon

Terminalen er et operatørpanel i en familie av terminaler utviklet til å klare de krav som stilles til man-maskin-kommunikasjon. De innebygde funksjonene i terminalen inneholder bl a muligheter til å manøvrere og presentere tekst, dynamisk indikering, alarmhåndtering, resepthåndtering og tidsstyring.

Terminalen har en objektorientert arbeidsmåte som gjør den lett å bruke. Programmeringen gjøres via en PC med programvaren E-Designer for Windows. Det programmerte prosjektet overføres til, og lagres i terminalen.

Bytt mellom programmeringsmodus, PROG, og driftsmodus, RUN, ved å trykke følgende tastkombinasjoner samtidig.

Terminal	Taste kombinasjoner
E50	[F1] + [F4]
E100, E150	[←] + [ENTER]
E200, E300, E600, E700, E900	[←] + [MAIN]
E610, E615, E910	Bryteren på siden av terminalen i posisjon 4. RUN=posisjon 0.
E710	[F1] + [F2] + [F4]

For mer detaljert informasjon angående håndtering av terminalen henvises det til manualen for terminalen.

N

Installasjon

Spenningsforsyning

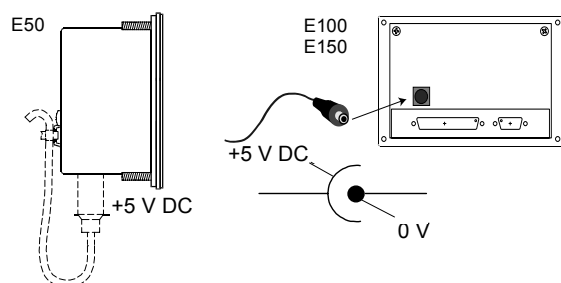
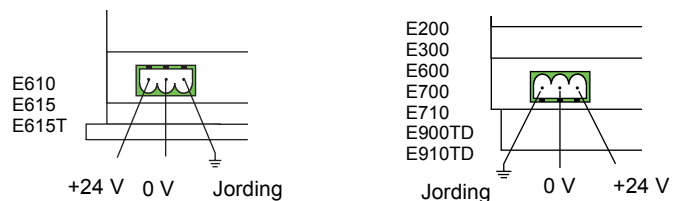

ADVARSEL!
Tilkobling av feil spenningspolaritet, kan forårsake permanent ødeleggelse av utstyret.

E900T/E900VT/E910T

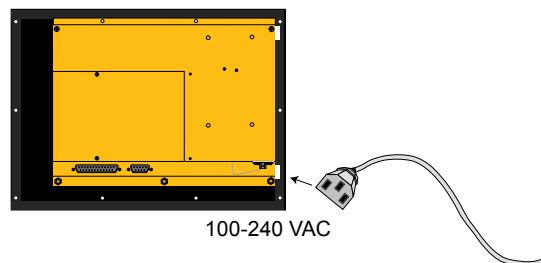

Kabel tabell

Navn	Sentral Europa	England	USA	Resten av verden
Cable 1	MAC-PC-CAB-R2/ CAB5	MAC-PROG/9-CAB/ CAB5	MTA-PROG-C/ CAB5	MAC-PROG/9-CAB/ CAB5
Cable 2	CAB6	CAB6	CAB6	CAB6

N

Tilkobling til PC

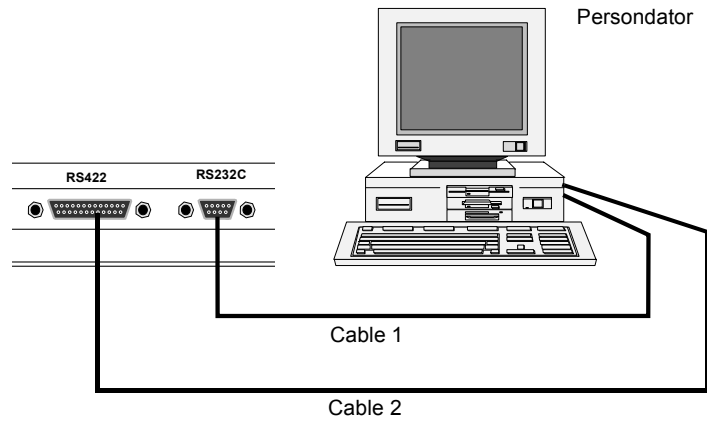

Terminalen programmeres via programpakken E-Designer som må være installert på PC'n. For installasjon se manual til E-Designer. Kommunikasjonsparametrene i terminalen og i E-Designer skal være innstilte på samme måte.

Tilkobling skrivere

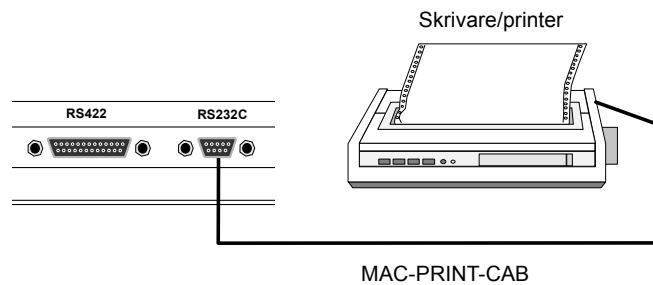

Skriveren skal ha et serielt grensesnitt og være satt opp med IBM-tegnoppsett. Se skrive-rens manual for korrekt konfigurering. For tilkobling til skriver med parallellt grensesnitt benyttes ekspansjonskortet IFC PI- Se manualen for IFC PI for ytterligere informasjon.

Inhoud

Veiligheidsvoorzieningen	2
Introductie	4
Installatie	5
Technische gegevens	A-1
Verbinding van een MELSEC PLC systeem.....	B-1
Instelling van een C24 Module van een MELSEC PLC systeem	C-1
Front data.....	D-1
Terminal tekening.....	E-1
Kabel tekening.....	F-1

Zie de handleiding van de terminal voor meer gedetailleerde informatie.

© Beijer Electronics AB 2002

Lees zorgvuldig het gehele Installatie handboek en volg precies de aanwijzingen voor de installatie en het gebruik. Het product dient alleen te worden geïnstalleerd, bediend en gerepareerd door gekwalificeerd personeel. Beijer Electronics AB is niet verantwoordelijk voor iedere verandering of modificatie van dit product. Vanwege de vele applicaties med gebruik van deze producten, moet de gebruiker beschikken over de juiste kennis, nodig voor het maken van de gewenste applicatie. Alleen delen en accessories gefabriceerd volgens de specificaties van Beijer Electronics AB kunnen met dit product gebruikt worden.P

BEIJER ELECTRONICS AB IS NIET VERANTWOORDELIJK VOOR IEDER DIRECTE OF INDIRECTE, SPECIALE, INCIDENTELE, OF CONSTATE SCHADE ALS GEVOLG VAN DE INSTALLATIE, GEBRUIK OF REPARATIE VAN DIT PRODUCT, DOOR ONRECHTMATIG GEBRUIK, CONTRACT OF IEDERE ANDERE WIJZE. de ENIGE OPLOSSING VOOR DE KOPER GEGRONDE REDEN IS HET REPAREREN, HET VERVANGEN OF HET VERGOEDEN VAN DE AANSCHAFPRIJS. de KEUZE VAN DE TOEGEPASTE OPLOSSING ZAL GEGROND WORDEN OP DE DISCRETIE VAN BEIJER ELECTRONICS AB.

Veiligheidsvoorschriften

Algemeen

- Lees de veiligheidsvoorschriften nauwkeurig door.
- Controleer de geleverde goederen op eventuele transportschade. Breng bij schade de leverancier zo snel mogelijk op de hoogte.
- De terminal voldoet aan de eisen als gesteld in artikel 4 in de EMC-richtlijn 89/336/EEC.
- Gebruik de terminal niet in een explosieve omgeving.
- De leverancier kan niet aansprakelijk worden gesteld voor aangepaste, gewijzigde of omgebouwde uitrusting.
- Alleen reserveonderdelen en accessoires die conform de specificaties van de leverancier zijn gefabriceerd, mogen worden gebruikt.
- Lees de installatie- en gebruikshandleiding nauwkeurig door, voordat de terminal wordt geïnstalleerd, bediend of gerepareerd.
- Bij verkeerde plaatsing van de batterij bestaat de kans op ontploffing. Gebruik alleen batterijen die door de leverancier worden aanbevolen.
- Er mag nooit vloeistof via spleten of openingen in de terminal komen. Dit kan brand of kortsluiting veroorzaken.
- De terminal moet door deskundig personeel worden bediend.

Installatie

- De terminal is geconstrueerd voor vaste installaties op een vlakke ondergrond.
- Plaats de terminal tijdens de installatie op een vaste ondergrond. Als de terminal kantelt of valt, kan er schade ontstaan.
- Installeer de terminal volgens de bijgeleverde installatiehandleiding.
- De aarding dient volgens de bijgeleverde installatiehandleiding te geschieden.
- De installatie dient door deskundig personeel te worden uitgevoerd.
- Scheid hoogspannings-, signaal- en spanningskabels.
- Ga na of de spanning en polariteit van de krachtbron juist zijn, voordat de terminal van spanning wordt voorzien.
- De openingen in de behuizing zijn bedoeld voor de luchtcirculatie en mogen niet worden afgedekt.
- Plaats de terminal niet op plaatsen waar de kans bestaat op sterke magnetische velden.
- Monteer de terminal niet in direct zonlicht.
- De randapparatuur moet geschikt zijn voor de gebruikte plaats.
- Bij bepaalde modellen van de terminal is gelamineerd folie aangebracht op het display om de kans op krassen te minimaliseren. Ter voorkoming van statische elektriciteit wat schade aan de terminal kan veroorzaken, moet het folie voorzichtig worden verwijderd.

**UL installation**

- Power, input and output (I/O) wiring must be in accordance with Class I, Division 2 wiring methods (Article 501-4 (b) of the National Electrical Code, NFPA 70) and in accordance with the authority having jurisdiction.

Gebruik

- Houd de terminal schoon.
- Bedien de noodstopfuncties of andere veiligheidsfuncties niet vanaf de terminal.
- Bewerk toetsen, display, e.d. niet met scherpe voorwerpen.

Service en onderhoud

- De garantie geldt zoals overeengekomen.
- Gebruik een mild schoonmaakmiddel en een zachte doek voor het reinigen van display en front.
- Reparaties mogen alleen door deskundig personeel worden uitgevoerd.

Demontage en verschroten

- Recycling van (delen van) de terminal dient in overeenstemming te zijn met de geldende regelgeving in het betreffende land.
- Let op dat de volgende onderdelen stoffen bevatten die schadelijk kunnen zijn voor gezondheid en milieu: lithiumbatterij, elektrolysecondensatoren en display.

Introductie

De terminal is een bedieningspaneel uit een familie van terminals, ontwikkeld om aan de behoefte naar mens machine communicatie te kunnen voldoen.

De ingebouwde functies in de terminal omvatten o.a. de mogelijkheid om tekst afbeeldingen dynamisch weer te geven, PLC gestuurde installaties te monitoren en te bedienen, storingsmeldingen te registreren, rapportages te genereren, en tijdkanalen aan te sturen aan de hand van de standaard geïntegreerde real-time klok.

De bedieningspanelen hebben grotendeels een object-georiënteerde manier van werken en zijn daardoor zeer gebruiksvriendelijk. Een terminal is direct vanaf een personal computer te programmeren met het software pakket E-Designer voor Windows. Hierna wordt aan het product E-Designer gerefereerd als "de PC software". Het gehele geprogrammeerde project wordt opgeslagen in de terminal.

Schakel fussen de Programming mode, PROG, RUN-time mode en RUN door de toets tegelijk intedrukken volgens onderstaande tabel.

Terminal	Toets combinatie
E50	[F1] + [F4]
E100, E150	[←] + [ENTER]
E200, E300, E600, E700, E900	[←] + [MAIN]
E610, E615, E910	The switch on the side of the terminal in position number 4. RUN=position 0.
E710	[F1] + [F2] + [F4]

Zie de handleiding van de terminal voor meer gedetailleerde informatie.

Installatie

Voltage vereiste

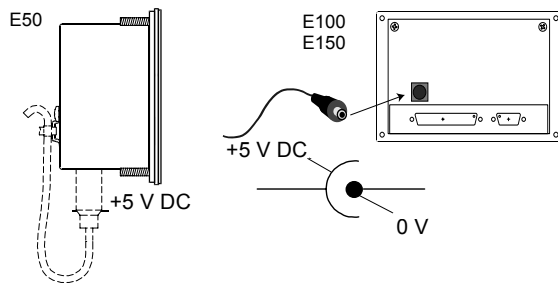
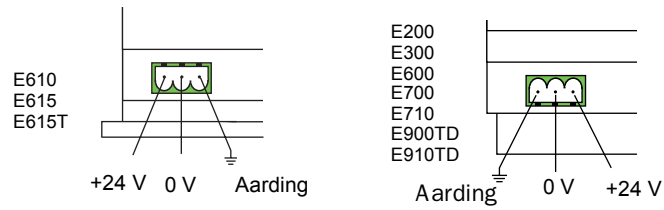

WAARSCHUWING!
Verwissel nooit de polariteit van de spanning; dit kan blijvende schade veroorzaken.

E900T/E900VT/E910T

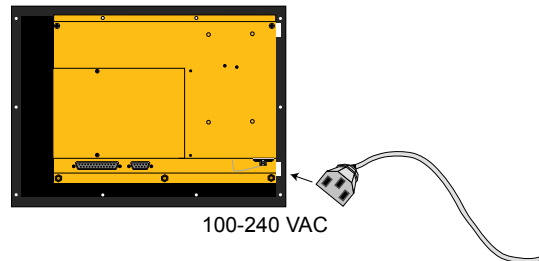

Kabel tabel

Naam	Continent Europa	GB	USA	Rest van de wereld
Kabel 1	MAC-PC-CAB-R2/ CAB5	MAC-PROG/9-CAB/ CAB5	MTA-PROG-C/ CAB5	MAC-PROG/9-CAB/ CAB5
Kabel 2	CAB6	CAB6	CAB6	CAB6

Verbinding met een personal computer

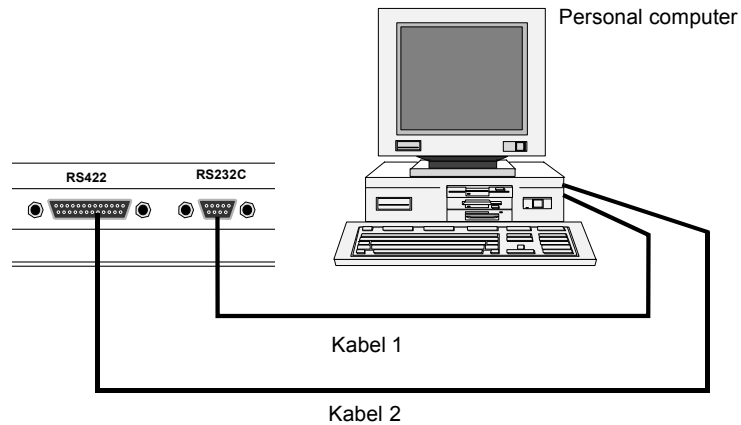

Om de terminal te programmeren wordt het aanbevolen om de PC software te gebruiken. Zie de handleiding van dit product om de PC software te installeren. De communicatie parameters in het bedieningspaneel en in de PC software dienen op dezelfde wijze ingesteld te worden.

Aansluiting op een printer

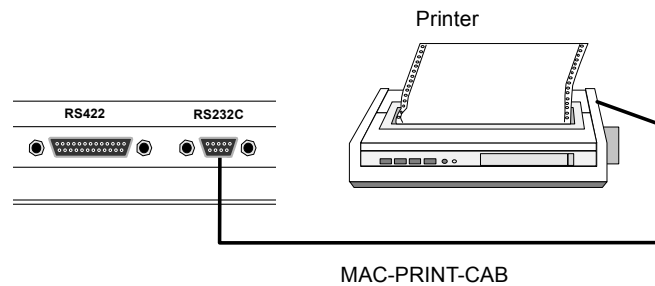

De printer moet voorzien zijn van een seriële interface en een IBM karakterset. Raadpleeg de printerhandleiding voor de juiste configuratie. Indien de terminal wordt aangesloten op een parallele interFace, dient er gebruik te worden gemaakt van de uitbreidingsmodule IFC PI. Zie de manual van de IFC PI voor verdere informatie.

Conteúdo

Precauções de segurança	2
Introdução	4
Instalação.....	5
Dados Técnicos	A-1
Ligação a MELSEC PLC's	B-1
Parametrização do módulo C24 em PLC's.....	C-1
Dados do painel frontal	D-1
Esquema do terminal.....	E-1
Esquemas de cabos	F-1

Para informação mais detalhada ver por favor o manual específico do terminal.

© Beijer Electronics AB 2002

Antes de utilizar o produto ou mesmo antes de o instalar deverá ler cuidadosamente, o manual de instalação. O produto deverá ser instalado, operado e reparado apenas por técnicos qualificados. A Beijer Electronics AB não se responsabiliza por quaisquer alterações ou modificações deste produto. Dado que, este produto tem muitas aplicações, o utilizador deve munir-se do conhecimento adequado para poder operar correctamente este produto. Com este produto, só podem ser utilizados acessórios produzidos de acordo com as especificações da Beijer Electronics AB.

A BEIJER ELECTRONICS AB NÃO SE RESPONSABILIZA POR QUAISQUER DANOS ACIDENTAIS DIRECTOS OU INDIRECTOS, RESULTANTES DA MÁ INSTALAÇÃO, UTILIZAÇÃO OU REPARAÇÃO DO PRODUTO. EM CASO DE AVARIA A SOLUÇÃO PODE SER A REPARAÇÃO, SUBSTITUIÇÃO OU DEVOLUÇÃO, SENDO A BEIJER ELECTRONICS AB A RESPONSÁVEL POR TOMAR ESSA DECISÃO.

Instruções de segurança

Generalidades

- Leia minuciosamente estas instruções de segurança.
- Verifique o conteúdo no acto da entrega quanto a eventuais danos de transporte. Comunique imediatamente ao fornecedor caso tenha encontrado algum dano.
- O terminal satisfaz as exigências contidas no artigo 4 da directiva CEM 89/336/CEE.
- Não utilize o terminal em ambientes com alto risco de explosões.
- O fornecedor não assume quaisquer responsabilidades por modificações, transformações ou conversões no equipamento.
- Só é permitida a utilização de peças sobresselentes e acessórios fabricados em conformidade com as especificações do fornecedor.
- Antes de instalar, utilizar ou efectuar reparações no terminal, leia atentamente as instruções de instalação e do utilizador.
- Poderão ocorrer situações de perigo de explosão se a bateria for montada incorrectamente. Utilize apenas as baterias recomendadas pelo fornecedor.
- Substâncias líquidas nunca poderão ser introduzidas em fendas ou aberturas do terminal. Tal prática poderá causar incêndios ou transformar o equipamento em condutor de electricidade.
- O terminal deverá ser manuseado por pessoas devidamente qualificadas.

Ao instalar

- O terminal é projectado para utilização em instalações fixas, sobre superfície plana.
- Durante a instalação, posicione o terminal sobre uma base estável. Se o deixar cair ou se este sofrer uma queda, poderão ocorrer danos.
- Instale o terminal em conformidade com as instruções de instalação que acompanham o mesmo.
- A ligação à terra deverá ser efectuada conforme as instalações de instalação que acompanham o produto.
- A instalação deverá ser realizada por pessoal devidamente qualificado.
- Os cabos de alta tensão, de sinal e de tensão deverão ser separados.
- Certifique-se de que a tensão e polaridade da fonte de corrente eléctrica estão correctas antes de ligar a tensão.
- As aberturas na tampa destinam-se à circulação de ar e não poderão ser cobertas.
- Não posicione o terminal em lugares sob risco de exposição a fortes campos magnéticos.
- O terminal não deverá ser montado em local directamente exposto à luz solar.
- O equipamento periférico deverá adequar-se ao local em que é utilizado.
- Alguns modelos de terminal possuem uma película laminada, aplicada sobre o vidro do visor para reduzir o risco de arranhões. Para evitar electricidade estática que possa ocasionar danos ao terminal, remova com cuidado esta película.

UL installation

- Power, input and output (I/O) wiring must be in accordance with Class I, Division 2 wiring methods (Article 501-4 (b) of the National Electrical Code, NFPA 70) and in accordance with the authority having jurisdiction.

Ao utilizar

- Conserve o terminal limpo.
- As funções de parada de emergência não podem ser comandadas a partir do terminal.
- Teclas, vidro do visor, etc., não poderão ser submetidos à acção de objectos cortantes.

Assistência e manutenção

- A garantia tem validade conforme os termos constantes no documento de garantia.
- Utilize um agente de limpeza leve e um pano macio para limpar o vidro do visor e a parte frontal.
- As reparações deverão ser executadas por pessoal devidamente qualificado.

Desmontagem e recolha à sucata

- A reciclagem do terminal ou suas partes deverão ser executadas em conformidade com as regras vigentes no país respectivo.
- Convém observar que os seguintes componentes contêm substâncias que podem ser prejudiciais à saúde e ao meio ambiente: baterias de lítio, condensadores electrolíticos e o visor.



Introdução

O terminal é um operador de painel numa família de terminais desenvolvidos para satisfazer as exigências surgidas na comunicação homem-máquina. As funções construídas no terminal incluem a possibilidade de utilizar e controlar texto, indicação dinâmica, alarmes, receitas e canais de tempo.

Os terminais possuem uma metodologia de programação orientada por objectos que os torna fáceis de usar. O terminal é programado directamente do PC com o programa E-Designer para Windows. Posteriormente o programa E-Designer é referido como "software". Todo o projecto programado é memorizado no terminal.

Para alterar entre o modo de programação PROG e o modo Operação RUN, pressionar simultaneamente as teclas indicadas na tabela seguinte.

Terminal	Teclas
E50	[F1] + [F4]
E100, E150	[←] + [ENTER]
E200, E300, E600, E700, E900	[←] + [MAIN]
E610, E615, E910	The switch on the side of the terminal in position number 4. RUN=position 0.
E710	[F1] + [F2] + [F4]

Para informação mais detalhada ver por favor o manual específico do terminal.

P

Instalação

Tensão de alimentação necessária

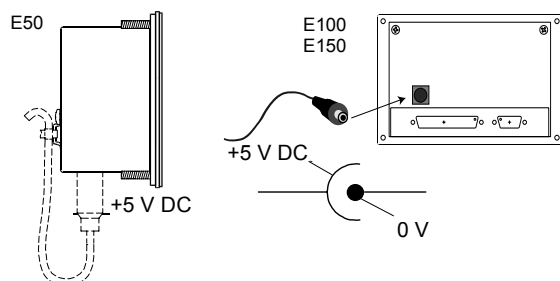
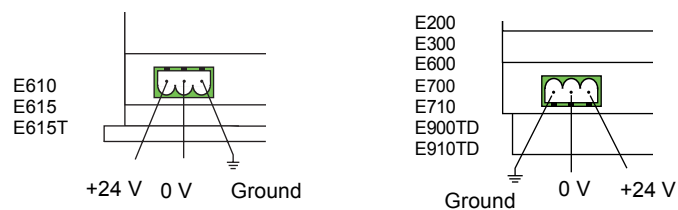

Atenção!
Não inverter a tensão,
poderá danificar o
terminal.

E900T/E900VT/E910T



Tabela de cabos

Name	Europa Continental	GB	USA	Outros países
Cable 1	MAC-PC-CAB-R2/ CAB5	MAC-PROG/9-CAB/ CAB5	MTA-PROG-C/ CAB5	MAC-PROG/9-CAB/ CAB5
Cable 2	CAB6	CAB6	CAB6	CAB6

P

Ligação a um computador pessoal

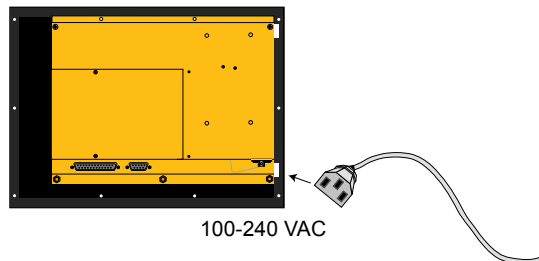
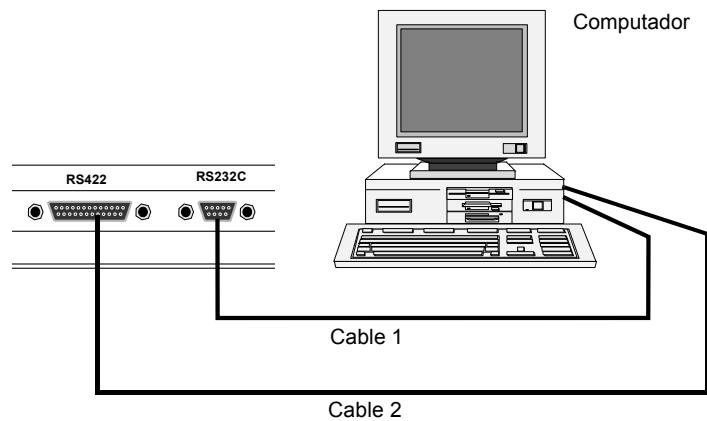

É recomendado software para PC na programação do terminal. Para instalar o software consultar o manual do produto. Os parâmetros de comunicação no terminal e no software devem ser iguais.

Ligação a uma impressora

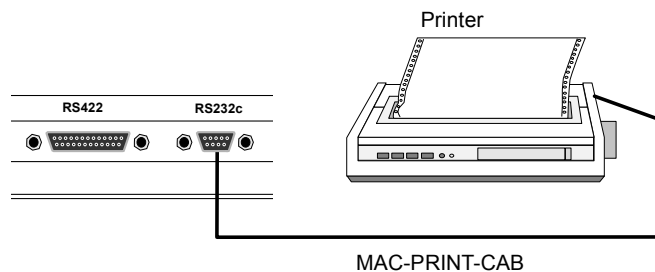

A impressora deve possuir uma interface série e estar equipada com a configuração de carácter IBM. Recorra ao manual da impressora para uma correcta configuração. Se pretender ligar o terminal a uma impressora através da Interface paralela, é necessário usar a expansão IFC PI. Consultar o manual IFC PI para mais informações.

Innehåll

Säkerhetsföreskrifter	2
Introduktion	4
Installation	5
Tekniska data	A-1
Anslutning till MELSEC PLC-system	B-1
Inställningar för C24 modul på MELSEC PLC-system	C-1
Frontdata	D-1
Terminalritningar	E-1
Kabelritningar	F-1

För mer detaljerad information angående handhavandet av terminalen hänvisas till manualen för terminalen.

© Beijer Electronics AB 2002

Läs hela installationsmanualen innan produkten installeras och används. Produkten skall installeras, användas och repareras av adekvat personal. Beijer Electronics AB förbjuder all modifiering, ändring, eller ombyggnad av utrustningen. På grund av det stora antalet användningsområden för denna utrustning, måste användaren själv inhämta tillräcklig kunskap för att rätt använda denna i sin speciella applikation. Endast reservdelar godkända enligt specifikation från Beijer Electronics AB får användas.

BEIJER ELECTRONICS AB FRÅNTAGER SIG ALLT ANSVAR FÖR DIREKTA ELLER INDIREKTA SKADOR SOM UPPKOMMIT I SAMBAND MED INSTALLATION, ANVÄNDNING ELLER REPARATION AV DENNA PRODUKT.

Säkerhetsföreskrifter

Allmänt

- Läs noga igenom säkerhetsföreskrifterna.
- Kontrollera leveransen för att upptäcka eventuella transportskador. Meddela leverantören snarast om skador upptäcks.
- Terminalen uppfyller kraven enligt artikel 4 i EMC-direktivet 89/336/EEC.
- Använd inte terminalen i en miljö där det finns hög risk för explosioner.
- Leverantören tar inte ansvar för modifierad, ändrad eller ombyggd utrustning.
- Endast reservdelar och tillbehör tillverkade enligt specifikation av leverantören får användas.
- Läs installations- och användarbeskrivningen noga innan terminalen installeras, används eller repareras.
- Fara för explosion kan uppstå om batteriet monteras felaktigt. Använd endast batterier som rekommenderas av leverantören.
- Vätska får aldrig hällas i springor eller hål i terminalen. Detta kan orsaka brand eller att utrustningen blir strömförande.
- Terminalen ska hanteras av personer med adekvat utbildning.

Vid installation

- Terminalen är konstruerad för fasta installationer på en plan yta.
- Placera terminalen på ett stadigt underlag under installationen. Om terminalen tappas eller faller ner kan skador uppstå.
- Installera terminalen enligt medföljande installationsbeskrivning.
- Jordning ska ske enligt medföljande installationsbeskrivning.
- Installation ska göras av personer med adekvat utbildning.
- Högspannings-, signal- och spänningskablar måste separeras.
- Fastställ att spänning och polaritet från kraftkällan är korrekt innan terminalen spänningssätts.
- Öppningarna i höljet är avsedda för luftcirkulation och får inte övertäckas.
- Placera ej terminalen där det finns risk att den utsätts för starka magnetfält.
- Terminalen bör ej monteras i direkt solljus.
- Kringutrustning måste vara lämplig där den används.
- Vissa terminalmodeller har en laminerad film över displayglaset för att minska risken för repor. För att förhindra statisk elektricitet som kan orsaka skador på terminalen, dra försiktigt av filmen.

UL installation

- Power, input and output (I/O) wiring must be in accordance with Class I, Division 2 wiring methods (Article 501-4 (b) of the National Electrical Code, NFPA 70) and in accordance with the authority having jurisdiction.

Vid användning

- Håll terminalen ren.
- Nödstoppsfunktioner eller andra säkerhetsfunktioner får ej styras från terminalen.
- Tangenter, displayglas etc får ej påverkas med vassa föremål.

Service och underhåll

- Garanti gäller enligt avtal.
- Använd mildt rengöringsmedel och mjuk trasa för att rengöra displayglas och front.
- Reparationer ska utföras av personer med adekvat utbildning.

Vid nedmontering och skrotning

- Återvinning av terminalen eller delar av terminalen skall ske enligt gällande regler i respektive land.
- Beakta att följande komponenter innehåller ämnen som kan vara skadliga för hälsa och miljö: litiumbatteri, elektrolytkondensatorer samt display.

Introduktion

Terminalen är en operatörspanel i en familj av terminaler utvecklade för att klara de krav som ställs på människa-maskinkommunikation. De inbyggda funktionerna i terminalen innehåller bl a möjligheter att manövrera och presentera text, dynamisk indikering, larmhantering, recepthantering och tidsstyrning.

Terminalen har till stor del ett objektorienterat arbetssätt, vilket gör den lättanvänd. Programmering sker antingen direkt på terminalen eller via en persondator med programvaran E-Designer för Windows. Det programmerade projektet överförs till och lagras i terminalen.

Växla mellan programmeringsläge, PROG, och driftläge, RUN, genom att trycka ner tangenterna enligt tabellen nedan samtidigt.

Terminal	Tangentkombination
E50	[F1] + [F4]
E100, E150	[←] + [ENTER]
E200, E300, E600, E700, E900	[←] + [MAIN]
E610, E615, E910	Sätt omkopplaren på sidan i position 4. RUN = position 0
E710	[F1] + [F2] + [F4]

För mer detaljerad information angående handhavandet av terminalen hänvisas till manualen för terminalen.

S

Installation

Spänningsmatning

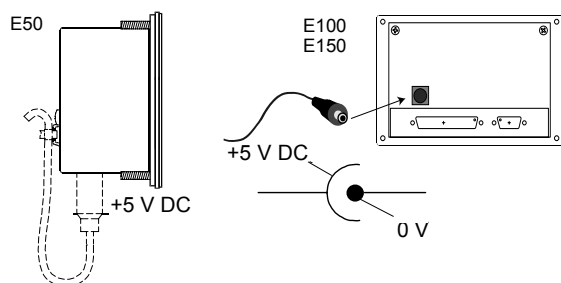
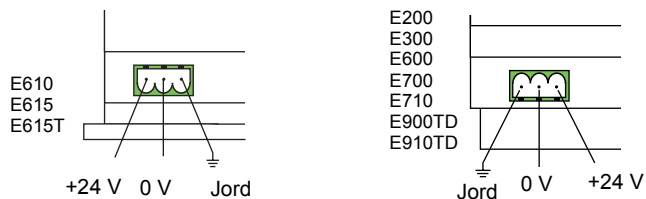

WARNING!
Vänd ej polerna för spänningsmatningen, då det kan orsaka bestående skador.

E900T/E900VT/E910T

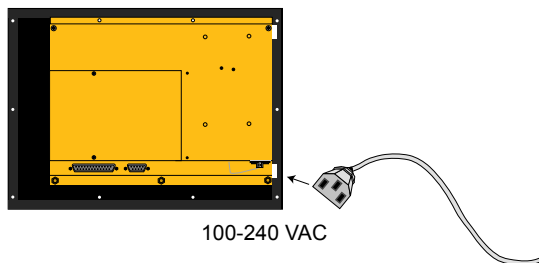

Kabeltabell

Namn	Kontinental-europa	Storbritannien	USA	Resten av världen
Cable 1	MAC-PC-CAB-R2/ CAB5	MAC-PROG/9-CAB/ CAB5	MTA-PROG-C/ CAB5	MAC-PROG/9-CAB/ CAB5
Cable 2	CAB6	CAB6	CAB6	CAB6

S

Anslutning till persondator

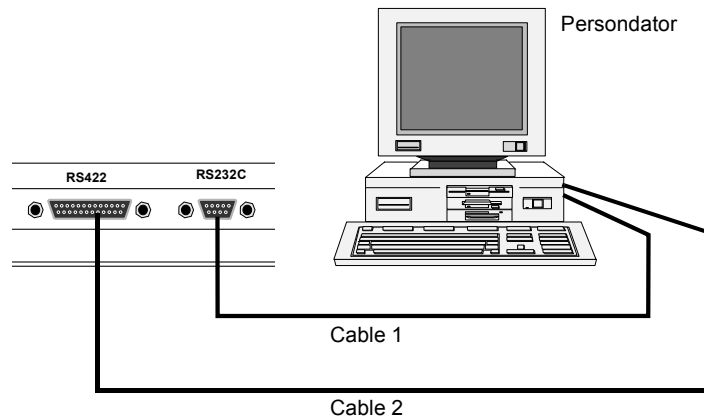

För programmering av terminalen måste programpaketet E-Designer vara installerad på persondatorn. Kommunikationsparametrarna i terminalen och i E-Designer måste vara inställda på samma sätt.

Anslutning till skrivare

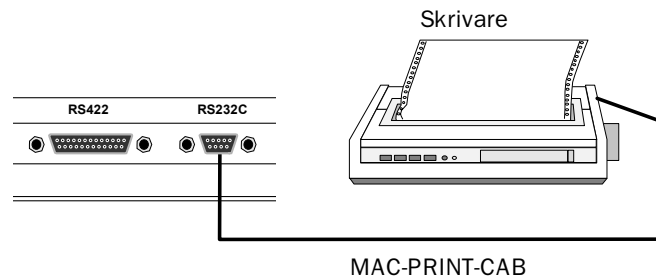

Skrivaren ska ha ett seriellt gränssnitt och vara försedd med IBM-teckenupsättning. Se skrivarens manual för korrekt konfigurering. För anslutning till skrivare med parallellt gränssnitt används expansionskortet IFC PI. Se manualen för IFC PI för vidare information.

Vsebina

Varovalni ukrepi.....	2
Uvod.....	4
Priključitev	5
Tehnični podatki.....	A-1
Povezava preko MELSEC PLC sistemih.....	B-1
Nastavitev C24 modula na MELSEC PLC sistemih.....	C-1
Osnovni podatki	D-1
Načrt terminala.....	E-1
Načrt povezav.....	F-1

Za podrobnejše informacije prosimo pogledjte Priročnik terminala.

© Beijer Electronics AB 2002

Prosimo vas, da v celoti preberete inštalacijska navodila, pred inštalacijo in uporabo tega proizvoda. Proizvod lahko inštalira in ga popravlja samo kvalificirano osebje. Beijer Electronics AB ni odgovorna za predelavo tega proizvoda. Uporabnik mora imeti ustrezno znanje za pravilno uporabo tega proizvoda, v točno določenem primeru aplikacije. S tem proizvodom se lahko uporabljajo samo rezervni deli in pripomočki ki so proizvedeni v skladu z specifikacijo Beijer Electronics AB.

BEIJER ELECTRONICS AB NI ODGOVOREN NIKOMUR ZA DIREKTNO, INDIREKTNO, SPECIALNO, PRILOŽNOSTNO IN POSLEDIČNO ŠKODO, KI SE NANAŠA NA INŠTALACIJO, UPORABO IN POPRA VILO TEGA PROIZVODA, RAZEN ČE TO NI DEL POGODBE. BEIJER ELECTRONICS AB ODLOČA ALIBO OKVARJENI PROIZVOD POPRA VIL, ZAMENJAL ALI VRNIL DENARV VREDNOSTI NAKUPNE CENE.

Varnostni predpisi

Splošno

- Natancno preberite varnostne predpise.
- Dobavljeno blago najprej preglejte zaradi morebitnih poškodb pri prevozu. Če odkrijete poškodbe, nemudoma obvestite dobavitelja.
- Terminal izpolnjuje zahteve, navedene v členu 4 v EMU-direktivi 89/336/EEC.
- Terminala ne uporabljajte v okolju, izpostavljenemu veliki nevarnosti eksplozij.
- Dobavitelj ne odgovarja za izdelek, ki je modificiran, spremenjen ali dograjen.
- Uporabljati smete le rezervne dele in pribor, ki so v skladu s specifikacijo dobavitelja.
- Natancno preberite navodila za inštalacijo in uporabo, predno terminal inštalirate, uporabite ali popravljate
- Če baterijo montirate napacno, obstaja nevarnost eksplozije. Uporabljajte le baterije, ki jih priporoča dobavitelj.
- Nikoli ne vlivajte tekočin v razmake in luknje v terminalu. Takšno ravnanje lahko povzroci požar ali pa električno prevodnost naprave.
- S terminalom smejo upravljati le osebe z ustreznim strokovnim znanjem.

Ob inštalaciji

- Terminal je primeren za trajne inštalacije na ravni površini.
- Ob inštalaciji mora terminal stati na trdni podlagi. Če pade na tla, ali pa ce se prevrne, se lahko poškoduje.
- Terminal inštalirajte v skladu s priloženim opisom za inštalacijo.
- Poskrbite za ozemljitev v skladu s priloženim opisom za inštalacijo.
- Instalacijo mora opraviti oseba z ustreznim strokovnim znanjem.
- Visokonapetostne, signalne in napetostne kable je potrebno lociti.
- Prepricajte se, da so napetost in poli iz izvora energije pravilni, predno terminal priključite.
- Odprtine na zunanjem ovoju so namenjene cirkulaciji zraka in jih zato ne smete prekrievati.
- Terminala nikoli ne postavite na mesto, kjer bo morebiti izpostavljen močnim magnetnim poljem.
- Terminala nikoli ne izpostavljajte direktni sončni svetlobi.
- Vse dodatne naprave morajo biti prilagojene namenu uporabe.
- Nekateri modeli terminala imajo preko displaya laminiran film, ki preprečuje praske. Da bi se izognili nevarnosti nastanka staticne elektrike, ki lahko poškoduje terminal, morate film odstraniti izredno previdno.

UL installation

- Power, input and output (I/O) wiring must be in accordance with Class I, Division 2 wiring methods (Article 501-4 (b) of the National Electrical Code, NFPA 70) and in accordance with the authority having jurisdiction.

Ob uporabi

- Poskrbite, da bo terminal vedno čist.
- Funkcij, namenjenih za ustavitev delovanja v stiski in drugih varnostnih funkcij, ne smete nikoli upravljati s pomočjo terminala.
- Tipk, stekla displaya ipd. nikoli ne izpostavljajte ostrim predmetom.

Servis in vzdrževanje

- Garancija velja v skladu s pogodbo.
- Za čiščenje stekla displaya in sprednje strani uporabite mehko krpo in blago čistilno sredstvo.
- Popravila smejo opravljati le osebe z ustreznim strokovnim znanjem.

Ko terminal demontirate in zavržete

- Reciklaža terminala in njegovih sestavnih delov mora biti v skladu s predpisi, veljavnimi v državi.
- Zavedajte se, da naslednje komponente vsebujejo snovi, nevarne zdravju in okolju: litij baterija, elektrolitski kondenzatorji in display.



Uvod

Terminal je operaterski pult iz družine terminalov, ki so namenjeni komunikaciji operaterja s PLC krmilniki MITSUBISHI. Terminal omogoča prikaz tekstov in shem skupaj z dinamičnimi elementi, spreminjanje vrednosti, obdelavo alarmov in receptov ter časovne funkcije.

Terminali so objektno orientirani, kar zelo poenostavi njihovo uporabo Terminal programiramo preko PC-ja s programom E-Designer za Windows okolje. V nadaljevanju ga imenujemo "PC program". Program projekta je shranjen v terminalu.

Preklop med programskim načinom delovanja, PROG in delovnim načinom, RUN naredimo z istočasnim pritskanjem tipk pe naslednj tabeli.

Terminal	Kombinacija tipla
E50	[F1] + [F4]
E100, E150	[←] + [ENTER]
E200, E300, E600, E700, E900	[←] + [MAIN]
E610, E615, E910	The switch on the side of the terminal in position number 4. RUN= pozicijo 0
E710	[F1] + [F2] + [F4]

Za podrobnejše informacije prosimo pogledjte Priročnik terminala.

Priključitev

Napajanje

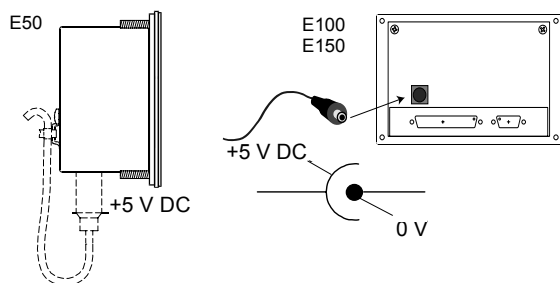
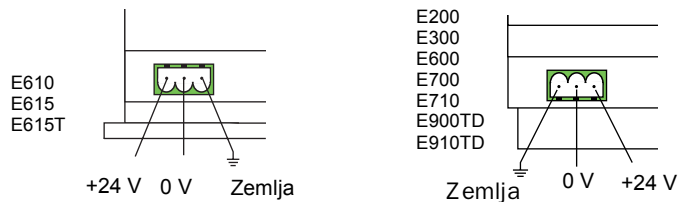

POZOR!

Ne uporabi nasprotnih napolnosti povzročila bo trajno okvaro.

E900T/E900VT/E910T

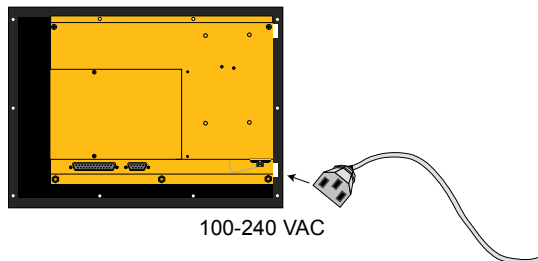

Popis kablov

Ime	Kontinentalna Evropa	GB	USA	Ostali del sveta
Cable 1	MAC-PC-CAB-R2/ CAB5	MAC-PROG/9-CAB/ CAB5	MTA-PROG-C/ CAB5	MAC-PROG/9-CAB/ CAB5
Cable 2	CAB6	CAB6	CAB6	CAB6

SI

Povezava z osebnim računalnikom

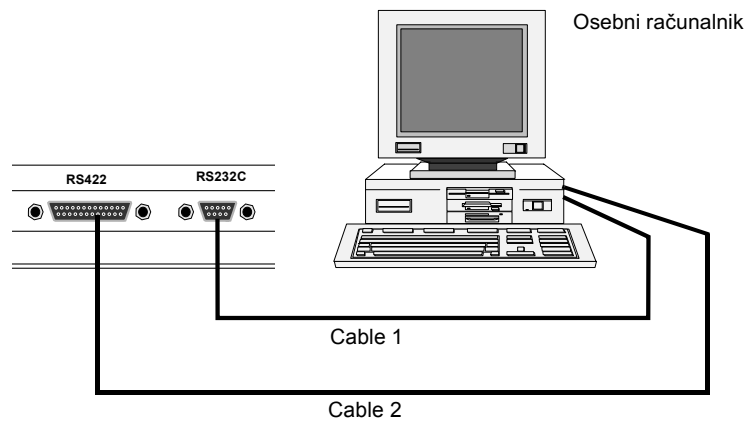

Za programiranje terminala priporočamo uporabo PC programa. Za instalacijo PC programa glej priročnik za PC program. V terminalu in PC programski oprepi morajo biti parametri enako nastavljeni.

Povezava s tiskalnikom

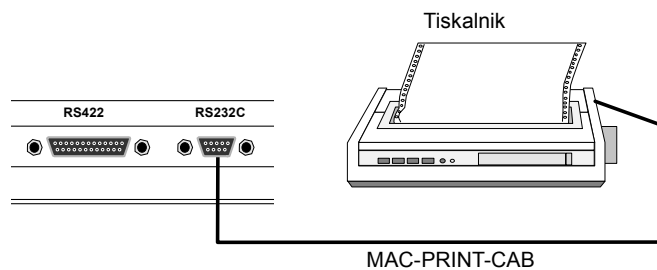

Tiskalnik naj bo opremljen s serijskim RS232 vmesnikom in IBM naborom znakov. Za pravilno konfiguracijo glej priročnik tiskalnika. Če želite povezati terminal s tiskalnikom preko paralelnega vmesnika, morate uporabiti razširitevno kartico IFC PI. Nadaljne informacije najdete v priročniku za IFC PI.

Technical data

Technical data for E50, E100, E150 and E200

Parameter	E50	E100	E150	E200
Front panel, WxHxD, mm	104 x 69 x 4.5	142 x 90 x 3.5	142 x 100 x 3.5	147 x 163.5 x 5
Mounting depth, mm	Excl. D-sub 38 Incl. D-sub 38	Excl. D-sub 28 Incl. D-sub 96.5	Excl. D-sub 28 Incl. D-sub 96.5	Excl. D-sub 38 Incl. D-sub 107
Panel cut out, see drawing	S-02857	S4-03205	S-03258	S4-02809
Front panel seal	IP 65, NEMA 4, NEMA 4X (Indoor use only)			
Rear panel seal	IP 20			
Keyboard material	Membrane keyboard with polyester snap discs. Overlay film of Autotex F207 with print on reverse side. 1 million operations. See <i>Appendix D</i> .			
Reverse side material	Alu-Zink			
Weight, excl. D-sub	0.2 kg	0.5 kg	0.5 kg	0.7 kg.
Serial port RS422	25-pin D-sub contact, chassis mounted female with standard locking screws 4-40 UNC.			
Serial port RS232C	9-pin D-sub contact, chassis mounted male with standard locking screws 4-40 UNC, available when the delivered converter 232-25-ADP is mounted on the RS422 port.	9-pin D-sub contact, chassis mounted male with standard locking screws 4-40 UNC.		
Flash memory for application	16 kb	64 kb	64 kb	64 kb

Parameter	E50	E100	E150	E200
Real time clock	–	±10 PPM + error because of ambient temperature and supply voltage. Total max error 1 min/month = 12min/year. Minimum life: 10 years of the battery for the real time clock.		
Current consumption at rated voltage	Max: 200 mA	Max: 200 mA	Max: 200 mA	Max: 150 mA
Display	LCD (liquid crystal display), 2 lines with 16 characters, 5 mm character height. Back light: lifetime 50000 h at the ambient temperature of +25°C. LED.	LCD (liquid crystal display), 2 lines with 20 characters, 5 mm character height. Back light: lifetime 50000 h at the ambient temperature of +25°C. LED.		LCD (liquid crystal display), 4 lines with 20 characters, 5 mm character height. Back light: lifetime 50000 h at the ambient temperature of +25°C. LED.
Active area of display, WxH, mm	55.7 x 11.0	73.5 x 11.5	73.5 x 11.5	70.4 x 20.8
Contrast setting	Potentiometer			
Supply voltage	5 V DC, ±5%, from PLC or external. Battery eliminator (connector 2.1 mm, centre pin 0V).			+24 V DC (20-30 V DC) 3-pin jack connection block. CE: The power supply must conform with the requirements for SELV or PELV according to IEC 950 or IEC 742. UL: The power supply must conform with the requirements for class 2 power supplies.
Fuse	–	–	–	1 AT, Littelfuse R452 001 (Nano ² SMF Slo-Blo) or 800 mA, 5 x 20 mm.

Parameter	E50	E100	E150	E200
Ambient temperature	0° to +50°C			
Storage temperature	-20° to +70°C			
Relative humidity	Max 85% non-condensed.			
EMC tests on the terminal	The terminal conforms with the essential protection requirements in article four of the directive 89/336/EEC. Noise tested according to: EN50081-1 emission and EN61000-6-2 immunity.			
UL approvals	UL 508, UL 1604 (Class I Div 2)			
DNV approval	Det Norske Veritas type approval certificate. Location classes: Temperature A, Humidity B, Vibration A, Enclosure C (panel front only).			
MTBF (Mean time between failure) (h)	402 225	345 155	345 155	128 062

Technical data for E300, E600, E610 and E615

Parameter	E300	E600	E610	E615	E615T
Front panel, WxHxD, mm	211.5 x 198 x 5,7	214 x 232 x 5.0	200 x 150 x 5.0	200 x 150 x 5.0	200 x 150 x 5.0
Mounting depth, mm	Excl. D-sub 69 Incl. D-sub 110	Excl. D-sub 69 Incl. D-sub 110	70	70	70
Panel cut out, see drawing	S4-02721	S4-03509	S-03611	S-03611	S-03611
Front panel seal	IP 65, NEMA 4, NEMA 4X (Indoor use only)				
Rear panel seal	IP 20				
Keyboard material/ Front panel	Membrane keyboard with polyester snap discs. Overlay film of Autotex F207 with print on reverse side. 1 million operations. See <i>Appendix D</i> .		Polyester on glass and Autotex F207. Touch screen. 1 million operations. See <i>Appendix D</i> .		
Reverse side material	Yellow-chromated steel plate				

Parameter	E300	E600	E610	E615	E615T
Weight, excl. D-sub	1.5 kg	1.4 kg	1.5 kg	1.5 kg	1.5 kg
Serial port RS422	25-pin D-sub contact, chassis mounted female with standard locking screws 4-40 UNC.				
Serial port RS485	–	–	4-pin jack connection block, chassis mounted male.		
Serial port RS232C	9-pin D-sub contact, chassis mounted male with standard locking screws 4-40 UNC.				
Expansion slots	1	1	1	1	1
Flash memory for application	400 kb	400 kb	400 kb	400 kb	400 kb
Real time clock	±10 PPM + error because of ambient temperature and supply voltage. Total max error 1 min/month = 12min/year. Minimum life: 10 years of the battery for the real time clock.				
Current consumption at rated voltage	Without load: 300 mA Max load: 450 mA		Without load: 250 mA Max load: 400 mA	Without load: 250 mA Max load: 450 mA	
Display	LCD (liquid crystal display), 240x64 pixel, monochrome, 4 rows of 20 characters or 8 rows of 40 characters. Back light: lifetime 50000 h at the ambient temperature of +25°C. LED.	LCD (liquid crystal display), 240x128 pixel, monochrome, 16 rows of 40 characters. Back light: lifetime 15000 h at the ambient temperature of +25°C. CFL.	LCD (liquid crystal display), 320x240 pixel, 16 grey scales, graphic and text. Back light: lifetime 25000h at the ambient temperature of +25°C. Touch screen. CFL.	LCD (liquid crystal display), 320x240 pixel, 256 colors, graphic and text. Back light: lifetime 25000h at the ambient temperature of +25°C. Touch screen. CFL.	TFT display, 320 x 240 pixel, 256 colors, graphic and text. Back light: lifetime 50000h at the ambient temperature of +25°C. Touch screen.
Active area of display, WxH, mm	127.2 x 33.9	120.0 x 64.0	115.2 x 86.4	115.2 x 86.4	115.2 x 86.4
Contrast setting	Programmable				-

Parameter	E300	E600	E610	E615	E615T
Supply voltage	+24 V DC (20-30 V DC) 3-pin jack connection block. CE: The power supply must conform with the requirements for SELV or PELV according to IEC 950 or IEC 742. UL: The power supply must conform with the requirements for class 2 power supplies.				
Fuse	1 AT, Littelfuse R452 001 (Nano ² SMF Slo-Blo) or 800 mA, 5 x 20 mm.				
Ambient temperature	0° to +50°C				
Storage temperature	-20° to +70°C				
Relative humidity	Max 85% non-condensed.				
EMC tests on the terminal	The terminal conforms with the essential protection requirements in article four of the directive 89/336/EEC. Noise tested according to: EN50081-1 emission and EN61000-6-2 immunity.				
UL approvals	UL 508, UL 1604 (Class I Div 2)				
DNV approval	Det Norske Veritas type approval certificate. Location classes: Temperature A, Humidity B, Vibration A, Enclosure C (panel front only).	-	-	-	-
MTBF (Mean time between failure) (h)	104 322	61 368	92 578	73 458	-

Technical data for E700 and E710

Parameter	E700	E710
Front panel, WxHxD, mm	276 x 198 x 5.7	211,5 x 198 x 5.7
Mounting depth, mm	Excl. D-sub 87 Incl. D-sub 110	
Panel cut out, see drawing	S3-02412	S4-02513
Front panel seal	IP 65, NEMA 4, NEMA 4X (Indoor use only)	
Rear panel seal	IP 20	

Parameter	E700	E710
Keyboard material/ Front panel	Membrane keyboard with polyester snap discs. Overlay film of Autotex F207 with print on reverse side. 1 million operations. See <i>Appendix D</i> .	Autoflex EB A180 or Polyester on glass and Autotex F207. Touch screen. 1 million operations. See <i>Appendix D</i> .
Reverse side material	Yellow-chromated steel plate	
Weight, excl. D-sub	1.7 kg	
Serial port RS422	25-pin D-sub contact, chassis mounted female with standard locking screws 4-40 UNC.	
Serial port RS232C	9-pin D-sub contact, chassis mounted male with standard locking screws 4-40 UNC.	
Expansion slots	2	2
Flash memory for application	400 kb	400 kb
Real time clock	±10 PPM + error because of ambient temperature and supply voltage. Total max error 1 min/month = 12 min/year. Minimum life: 10 years of the battery for the real time clock.	
Current consumption at rated voltage	Without load: 300 mA Max load: 550 mA	
Display	LCD (liquid crystal display), 320x240 pixel, 256 colors, graphic and text. Back light: lifetime 25000h at the ambient temperature of +25°C. CFL.	LCD (liquid crystal display), 320x240 pixel, 256 colors, graphic and text. Back light lifetime: 25000 h at the ambient temperature of +25°C. Touch screen. CFL.
Active area of display, WxH, mm	115.2 x 86.4	115.2 x 86.4
Contrast setting	Programmable	
Supply voltage	+24 V DC (20-30 V DC) 3-pin jack connection block. CE: The power supply must conform with the requirements for SELV or PELV according to IEC 950 or IEC 742. UL: The power supply must conform with the requirements for class 2 power supplies.	
Fuse	1 AT, Littelfuse R452 001 (Nano ² SMF Slo-Blo) or 800 mAT, 5 x 20 mm.	
Ambient temperature	0° to +50°C	
Storage temperature	-20° to +70°C	

Parameter	E700	E710
Relative humidity	Max 85% non-condensed.	
EMC tests on the terminal	The terminal conforms with the essential protection requirements in article four of the directive 89/336/EEC. Noise tested according to: EN50081-1 (EN50081-2 for E710) emission and EN61000-6-2 immunity.	
UL approvals	UL 508, UL 1604 (Class I Div 2)	
DNV approval	Det Norske Veritas type approval certificate. Location classes: Temperature A, Humidity B, Vibration A, Enclosure C (panel front only).	
MTBF (Mean time between failure) (h)	84 496	96 352

Technical data for E900T, E900VT, E900TD, E910TD and E910T

Parameter	E900T	E900VT	E900TD	E910TD	E910T
Front panel, WxHxD, mm	367 x 274 x 6.0	335 x 430 x 6.0	367 x 274 x 6.0	290 x 247 x 5.0	
Mounting depth, mm	Excl. D-sub 90 Incl. D-sub 110			Excl. D-sub 109 Incl. D-sub 130	
Panel cut out, see drawing	S3-03028	S3-03107	S3-03028	S3-03142	
Front panel seal	IP 65, NEMA 4				
Rear panel seal	IP 20				
Keyboard material/Front panel	Membrane keyboard with polyester snap discs. Overlay film of Autotex F207 with print on reverse side. 1 million operations. See <i>Appendix D</i> .			Polyester on glass and Autotex F207. Touch screen. 1 million operations. See <i>Appendix D</i> .	
Reverse side material	Yellow-chromated steel plate.				
Weight, excl. D-sub	3.5 kg	4.0 kg	3.2 kg	3.0 kg	3.3 kg
Serial port RS422	25-pin D-sub contact, chassis mounted female with standard locking screws 4-40 UNC.				
Serial port RS232C	9-pin D-sub contact, chassis mounted male with standard locking screws 4-40 UNC.				

Parameter	E900T	E900VT	E900TD	E910TD	E910T
Expansion slots	2	1	2	2	2
Flash memory for application	1600 kb				
Real time clock	±10 PPM + error because of ambient temperature and supply voltage. Total max error 1 min/month = 12 min/year. Minimum life: 10 years of the battery for the real time clock.				
Current consumption at rated voltage	Max: 0.17 – 0.35 A (240 – 100 VAC)		1 A	1 A	Max: 0.17 – 0.35 A (240 – 100 VAC)
Display	TFT display, 640x480 pixel, 256 colors, graphic and text. Back light: life 50000 h at the ambient temperature of +25°C.		TFT display, 640x480 pixel, 256 colors, graphic and text. Back light: life 50000 h at the ambient temperature of +25°C. Touch screen.		
Active area of display, WxH, mm	211.2 x 158.4				
Contrast setting	The brightness of the display (back light) is programmable.				
Fuse	External AC: F2.5 A, Internal DC: T4 A		1 AT, Littelfuse R452 001 (Nano ² SMF Slo-Blo) or 800 mAT, 5 x 20 mm.		External AC: F2.5 A, Internal DC: T4 A
Supply voltage	100-240 VAC	100-240 VAC	+24 V DC (20-30 V DC) 3-pin jack connection block. CE: The power supply must conform with the requirements for SELV or PELV according to IEC 950 or IEC 742. UL: The power supply must conform with the requirements for class 2 power supplies.		100-240 VAC
Ambient temperature	0° to +50°C				
Storage temperature	-20° to +70°C				
Relative humidity	Max 85% non-condensed.				

Parameter	E900T	E900VT	E900TD	E910TD	E910T
EMC tests on the terminal	The terminal conforms with the essential protection requirements in article four of the directive 89/336/EEC. Noise tested according to: EN50081-2 emission and EN61000-6-2 immunity.				
UL approvals	UL 1604 (Class I Div 2), UL 1950		UL 1604 Class I Div 2, UL 508		UL 1604 (Class I Div 2), UL 1950
DNV approval	Det Norske Veritas type approval certificate. Location classes: Temperature A, Humidity B, Vibration A, Enclosure C (panel front only).				
MTBF (Mean time between failure) (h)	89 274	91 867	104 464	101 016	91 650

Connection to MELSEC PLC systems

Connection to the MELSEC PLC system's CPU-port

Cable table

Name	Continental Europe	GB	USA	Rest of the world
Cable 1	MAC-PC-CAB-R2/ CAB5	MAC-PROG/9-CAB/ CAB5	MTA-PROG-C/ CAB5	MAC-PROG/9-CAB/ CAB5
Cable 2	MAC40-CPU-CAB- R4/CAB18	MAC 40+ CAB/ CAB18	MTA-D25-C/ CAB18	MAC30/40-CAB/ CAB18
Cable 3	FX20P-CAB/CAB19	FX-20P-CAB/ CAB19	MTA-MINI-D25/ CAB19	FX20P-CABN/ CAB19
Cable 4	FX20P-CADP	FX-20P-CADP	-	MAC10/FX0-CADP
Cable 5	CAB16	CAB16	CAB16	CAB16
Cable 6	CAB17	CAB17	CAB17	CAB17

A and QnA series

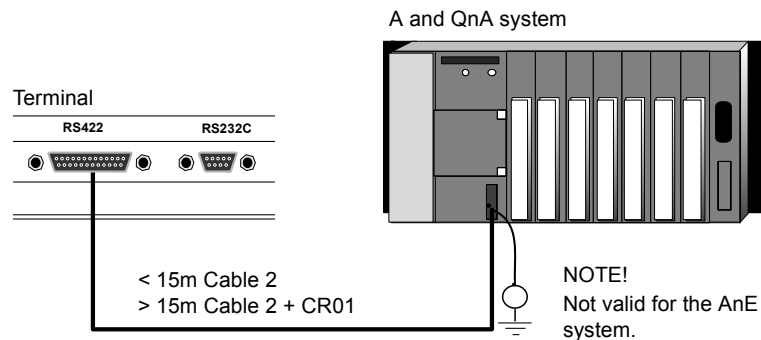

Q series

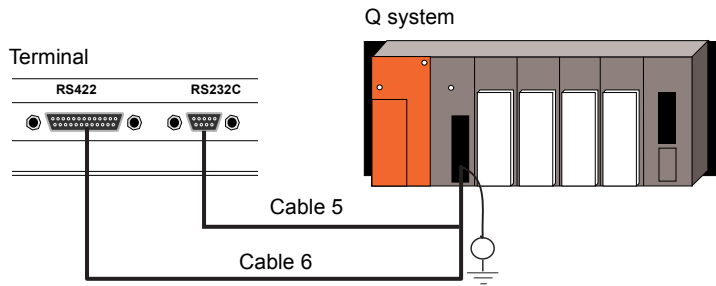

FX series

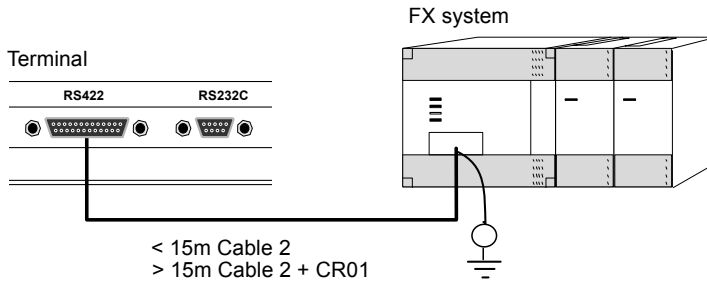

FX0, FX1 and FX2N series

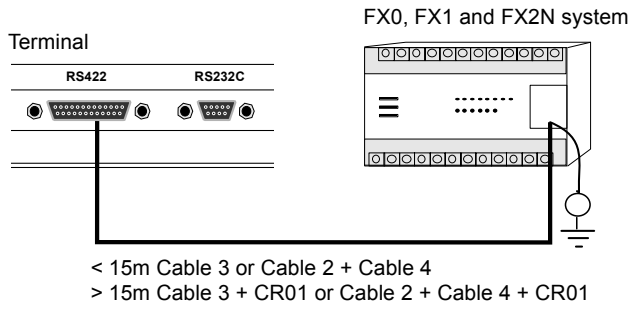

Connection to a C24 module in the MELSEC PLC system

See Appendix C for settings on a C24 module.

AJ71QC24/AJ71QC24N

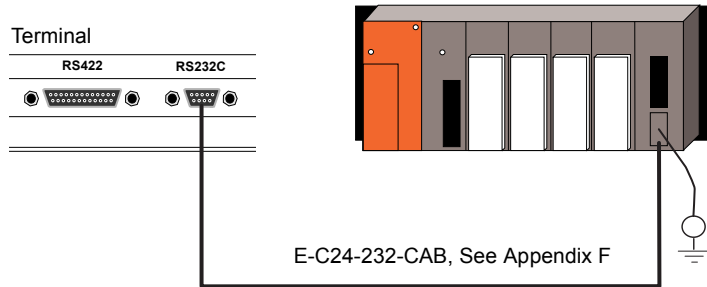

AJ71C24/A1SJ71QC24/A1SJ71C24-R4/A1SJ71UC24-R4

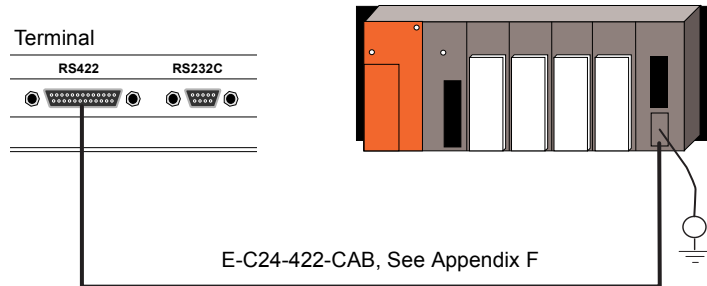

A1SJ71QC24/A1SJ71C24-R2/A1SJ71UC24-R2/A1SJ71QC24-R2

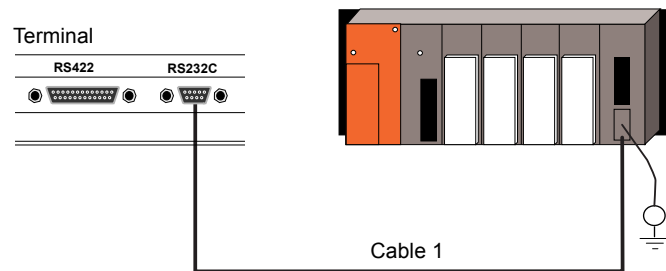

Settings on the C24 module in the MELSEC PLC system

AJ71(U)C24

Station number:

When communicating with the E-series: 0

Mode setting:

When communicating with the E-series: A

Setting of the switches:

Switch	Default comm. settings in E-series software	Setting items	Position of setting switch		Notes
			ON	OFF	
SW11	ON	Main channel settings	RS-422	RS-232C	Valid for modes A to D
SW12	ON	Data length	8 bits	7 bits	–
SW13	OFF	Transmission speed setting	Refer to the table below		–
SW14	ON				
SW15	ON				
SW16	OFF	Parity check	Enabled	Disabled	–
SW17	OFF	Parity setting	Even	Odd	Valid only when SW16 is ON
SW18	OFF	Stop bit	2 bits	1 bit	–
SW21	ON	Sum check	Enabled	Disabled	For dedicated protocol
SW22	ON	Write during RUN	Enabled	Disabled	

AJ71C24

Switch	Default comm. settings in software to E-series	Setting items	Position of Setting Switch		Notes
			ON	OFF	
SW23	OFF	Send area terminal resistance	Present	Absent	Valid only when SW11 is ON
SW24	OFF	Receive area terminal resistance	Present	Absent	

AJ71UC24

Switch	Default comm. settings in software to E-series	Setting items	Position of Setting Switch		Notes
			ON	OFF	
SW23	ON	Computer link/Multidrop	Computer link	Multidrop link	Must be ON
SW24	OFF	Multidrop settings	Master station	Local station	Valid only when SW23 is OFF

Baud rate	300	600	1200	2400	4800	9600	19200	Unusable
SW13	OFF	ON	OFF	ON	OFF	ON	OFF	ON
SW14	OFF	OFF	ON	ON	OFF	OFF	ON	ON
SW15	OFF	OFF	OFF	OFF	ON	ON	ON	ON

The settings of the switches must correspond with the communication settings in E-Designer and in the terminal.

For more detailed information see the manual for the module.

A1SJ71C24-R4/A1SJ71UC24-R4/A1SJ71C24-R2/A1SJ71UC24-R2

Station number:

When communicating with the E-series: 0

Mode setting:

When communicating with the E-series:

A1SJ71C24-R4/A1SJ71UC24-R4: 5

A1SJ71C24-R2/A1SJ71UC24-R2: 1

Setting of the switches:

Switch	Default comm. settings in software to E-series	Setting items	Position of Setting Switch		Notes
			ON	OFF	
SW01 Only -R4	OFF	Main drop settings	Master station	Local station	Valid only when SW2 is OFF
SW02 Only -R4	ON	Computer link/ Multidrop	Computer link	Multidrop link	Must be ON
SW03	OFF	Unused	–	–	–
SW04	ON	Write during RUN	Enabled	Disabled	For dedicated protocol
SW05	OFF	Transmission speed setting	Refer to the table below		–
SW06	ON				
SW07	ON				
SW08	ON	Data length	8 bits	7 bits	–
SW09	OFF	Parity check	Enabled	Disabled	–
SW10	OFF	Parity setting	Even	Odd	Valid only when SW09 is ON
SW11	OFF	Stop bit	2 bits	1 bit	–
SW12	ON	Sum check	Enabled	Disabled	For dedicated protocol

Baud rate	300	600	1200	2400	4800	9600	19200	Un-usable
SW05	OFF	ON	OFF	ON	OFF	ON	OFF	ON
SW06	OFF	OFF	ON	ON	OFF	OFF	ON	ON
SW07	OFF	OFF	OFF	OFF	ON	ON	ON	ON

The settings of the switches must correspond with the communication settings in E-Designer and in the terminal.

For more detailed information see the manual for the module.

AJ71QC24/AJ71QC24N/A1SJ71QC24/A1SJ71QC24-R2

Station number:

When communicating with the E-series: 00

Mode setting:

When communicating with the E-series: 5

Setting of the switches:

Switch	Default comm. settings in software to E-series	Setting items	Position of Setting Switch		Notes
			ON	OFF	
SW01	OFF	Operation setting	Interlocking	Independent	CH1 always OFF
SW02	ON	Data length	8 bits	7 bits	–
SW03	OFF	Parity check	Enabled	Disabled	–
SW04	OFF	Parity setting	Even	Odd	Valid only when SW03 is ON
SW05	OFF	Stop bit	2 bits	1 bit	–
SW06	ON	Sum check	Enabled	Disabled	For dedicated protocol
SW07	ON	Write during RUN	Enabled	Disabled	

Switch	Default comm. settings in software to E-series	Setting items	Position of Setting Switch		Notes
			ON	OFF	
SW08	OFF	Setting change	Allow	Prohibit	–
SW09	OFF	Transmission speed setting	Refer to the table below		–
SW10	ON				
SW11	ON				
SW12	OFF				
SW13-15	OFF	–	Set all to OFF		Placed on the left side of the AJ71QC24(N)

Transmission speed setting AJ71QC24/A1SJ71QC24/A1SJ71QC24-R2

Baud rate	300	600	1200	2400	4800	9600	19200
SW09	OFF	ON	OFF	ON	OFF	ON	OFF
SW10	OFF	OFF	ON	ON	OFF	OFF	ON
SW11	OFF	OFF	OFF	OFF	ON	ON	ON
SW12	OFF	OFF	OFF	OFF	OFF	OFF	OFF

Transmission speed setting AJ71QC24N

Baud rate	300	600	1200	2400	4800	9600
SW09	OFF	ON	OFF	ON	OFF	ON
SW10	OFF	OFF	ON	ON	OFF	OFF
SW11	OFF	OFF	OFF	OFF	ON	ON
SW12	OFF	OFF	OFF	OFF	OFF	OFF
Baud rate	19200	38400	14400	28800	57600	115200
SW09	OFF	ON	OFF	ON	OFF	ON
SW10	ON	ON	OFF	OFF	ON	ON
SW11	ON	ON	OFF	OFF	OFF	OFF
SW12	OFF	OFF	ON	ON	ON	ON

The total of CH1 and CH2 must be within 115200 bps.

The settings of the switches must correspond with the communication settings in E-Designer and in the terminal.

For more detailed information see the manual for the module.

QJ71C24/QJ71C24-R2

The settings for the QJ71C24 and QJ71C24-R2 are set in the PLC programming tool, for more information see the manual for the module.

Membrane keyboard

Solvent resistance and environmental data for Autotex 2

Autotex 2 withstands exposure of more than 24 hours duration under DIN 42 115 Part 2 to the following chemicals without visible change:

Ethanol	Formaldehyde 37%-42%	1.1.1. Trichloroethane (Genklene)
Cyclohexanol	Acetaldehyde	Ethylacetate
Diacetone alcohol	Aliphatic hydrocarbons	Diethyl ether
Glycol	Toluene	N-Butyl acetate
Isopropanol	Xylene	Amylacetate
Glycerine	White spirit	Butyccellosolve
Methanol	Formic acid <50%	Ether
Triacetin	Acetic acid <50%	Sodium hypchlorite <20% (Bleach)
Dowanol DRM/PM	Phosphoric acid <30%	Hydrogen peroxide <25%
Acetone	Hydrochloric acid <36%	Potassium carbonate
Metyl ethyl ketone	Nitric acid <10%	Washing powders
Dioxan	Trichloroacetic acid <50%	Fabric conditioner
Cyclohexanone	Sulphuric acid <10%	Ferric chloride
MIBK	Cutting oil	Ferrous chloride
Isophorone	Diesel oil	Dibutyl Phthalate
Ammonia <40%	Linseed oil	Diocetyl Phthalate
Caustic soda <40%	Paraffin oil	Sodium carbonate
Potassium hydroxide <30%	Blown castor oil	
Alkalicarbonate	Silicone oil	

Bichromate	Turpentine substitute	
Potassium ferrocyanide/ferricyanide	Universal brake fluid	
Acetonitrile	Decon	
Sodium bisulphate	Aviation fuel	
	Petrol	
	Teepol	
	Water	
	Sea water	

Autotex withstands DIN 42 115 Part 2 exposure of <1 hour duration to glacial acetic acid without visible change.

Autotex is **not** resistant to the following chemicals:

Concentrated mineral acids
Concentrated caustic solution
High pressure steam at over 100°C
Benzyl alcohol
Methylene chloride

Autotex withstands 24 hours exposure to the following reagents at 50°C without visible staining:

Top Job	Grape Juice	Ariel	Ajax
Jet Dry	Milk	Persil	Vim
Gumption	Coffee	Wisk	Domestos
Fantastic		Lenor	Vortex
Formula 409		Downey	Windex

Very slight discoloration was noted under critical viewing conditions with the following materials:

Tomato juice
Tomato ketchup
Lemon juice
Mustard

Environmental data

Minimum use temperature

Tactile embossed Autotex has been tested to 0.5 million switch operations at -40°C (-40°F) without loss of function.

Maximum use temperature

Low moderate humidity: 85°C

High humidity (>90% RH): 40°C

Outdoor use

In common with all polyester based films Autotex is not suitable for use in conditions of long term exposure to direct sunlight.

Display, E710

Solvent resistance and environmental data for Autoflex EB

Autoflex is based upon biaxial orientated polyester film and therefore has much enhanced solvent resistance, strength, durability and toughness substrates such as polycarbonate and vinyl.

Autoflex withstands exposure of more than 24 hours duration under DIN 42 115 Part 2 to the following chemicals without visible change:

Ethanol	Acetaldehyde	Fluorochlorohydrocarbons
Cyclohexanol	Aliphatic hydrocarbons	Perchloroethylen
Glycol	Petrol	1.1.1. Trichloroethane
Isopropanol	Toluene	Trichloroethane
Glycerine	Xylene	Ethylacetate
Methanol	Benzene	Diethyl ether
Acetone	Formic acid <50%	Sodium hypchlorite <20%
Metyl ethyl ketone	Acetic acid <50%	Hydrogen peroxide <25%
Dioxan	Phosphoric acid <30%	Potassium carbonate
	Hydrochloric acid <10%	Washing powders
	Nitric acid <10%	Fabric conditioner
	Sulphuric acid <10%	
Ammonia <2%	Cutting oil	
Caustic soda <2%	Diesel oil	
Alkalicarbonate	Linseed oil	
Bichromate	Paraffin oil	
Potassium ferrocyanide/ ferricyanide	Blown castor oil	
	Silicone oil	
	Turpentine substitute	

Autoflex withstands DIN 42 115 Part 2 exposure of <1 hour duration to glacial acetic acid without visible change.

Autoflex is **not** resistant to the following chemicals:

Concentrated mineral acids
Concentrated caustic solution
High pressure steam at over 100°C
Benzyl alcohol
Mehylene chloride

Resistance to household chemicals

Autotex withstands 24 hours exposure to the following reagents at 50°C without visible staining:

Top Job	Grape Juice	Ariel	Ajax
Jet Dry	Milk	Persil	Vim
Gumption	Mustard	Wisk	Domestos
Fantastic		Lenor	Vortex
Formula 409		Downey	Windex

Very slight discoloration was noted under critical viewing conditions with the following materials:

Tomato juice
Tomato ketchup
Lemon juice

Outdoor use

In common with all polyester based films Autoflex is not suitable for use in conditions of long term in exposure to direct sunlight. (See Autoflex UV).

Terminal drawings

E-series Installation, 5 V DC and 24 V DC

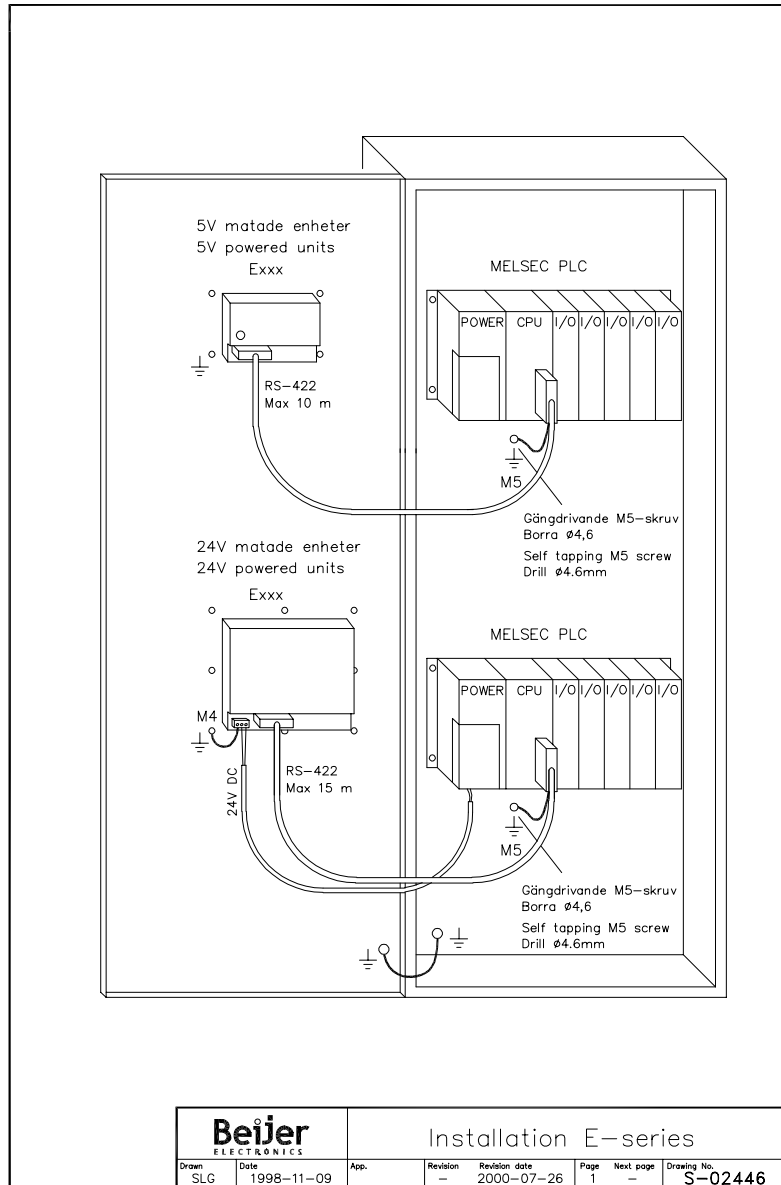

E-series RS232/RS422/RS485

RS-232

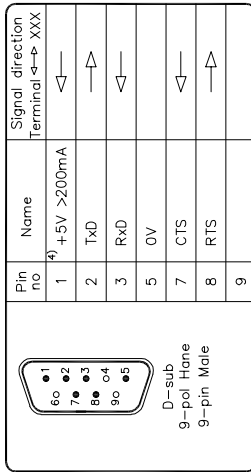

4) Only for E50 with 232-25-ADP. On all other terminals, not connected.

RS-485

Only for E610, E615

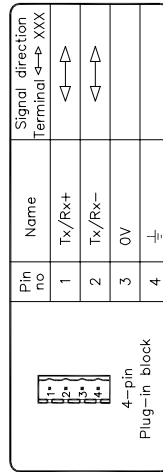

RS-422

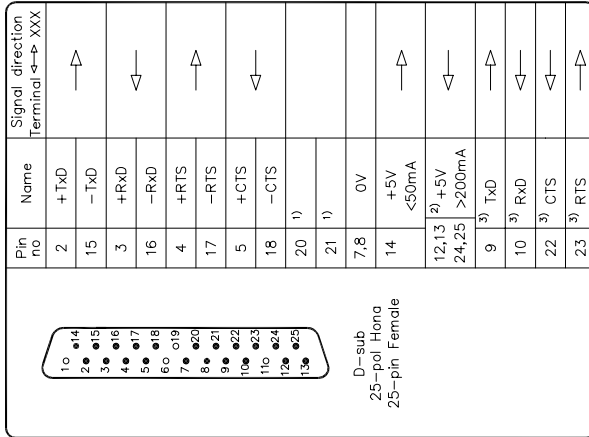

1) Pin no 20 connected to pin no 21 internal in the terminal
 2) Only for E50, E100, E150
 3) Only for E50

Beijer ELECTRONICS		E-Serien RS-232/RS-422/RS485	
Druck	Version	Revision	Page
SLG	1998-12-01	—	1
Bild Bezeichnet 1259w A3		Revision date	2001-03-29
		Page	1
		Next page	—
		Revision	S-02467

RS485 connection

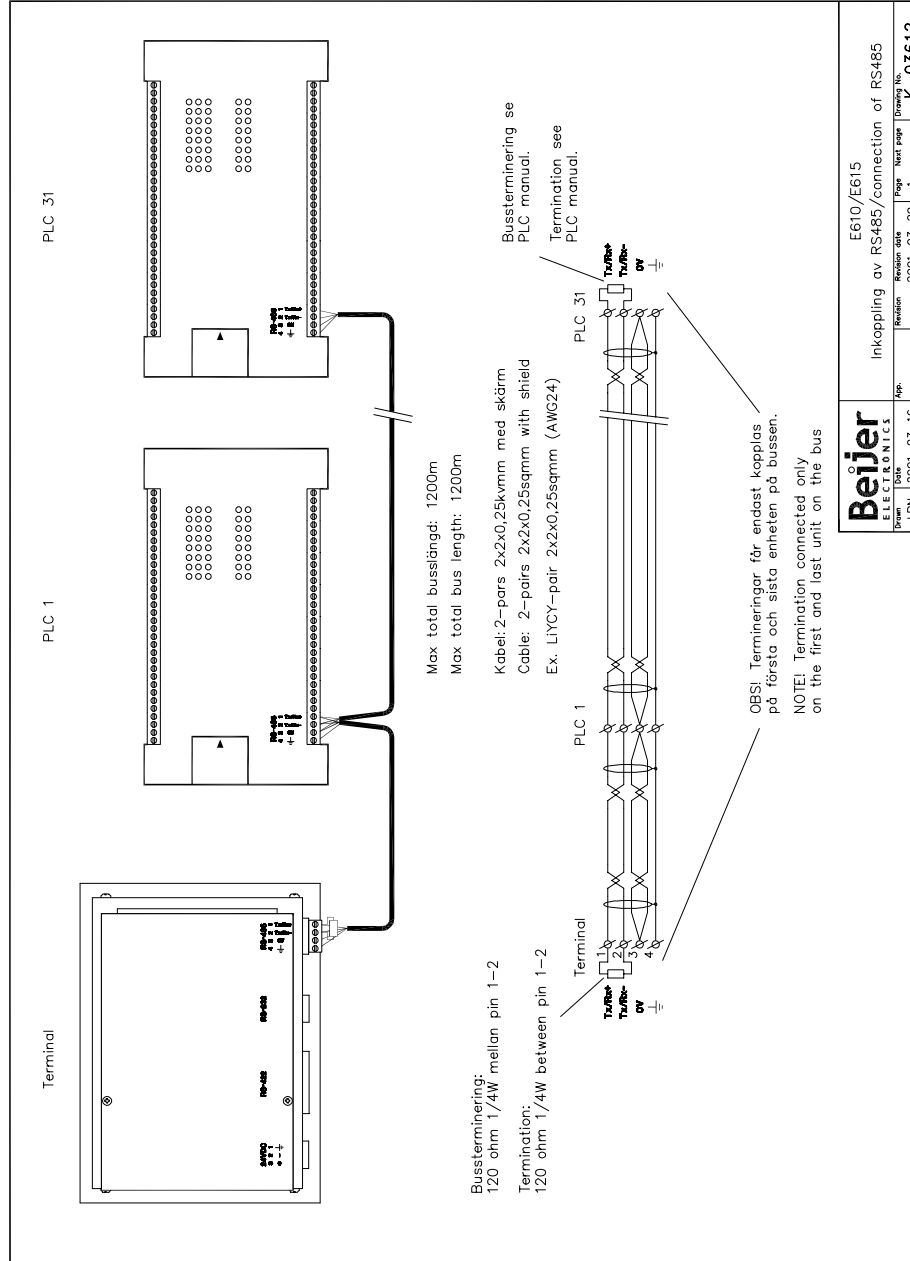

AS		LPN		2001-03-16		App		Revision		2001-03-29		Page		Next page		Drawing No.	
												1		-		K-03612	
Beijer ELECTRONICS										E610/E615							
Inkoppling av RS485/connection of RS485																	

E50 Outline

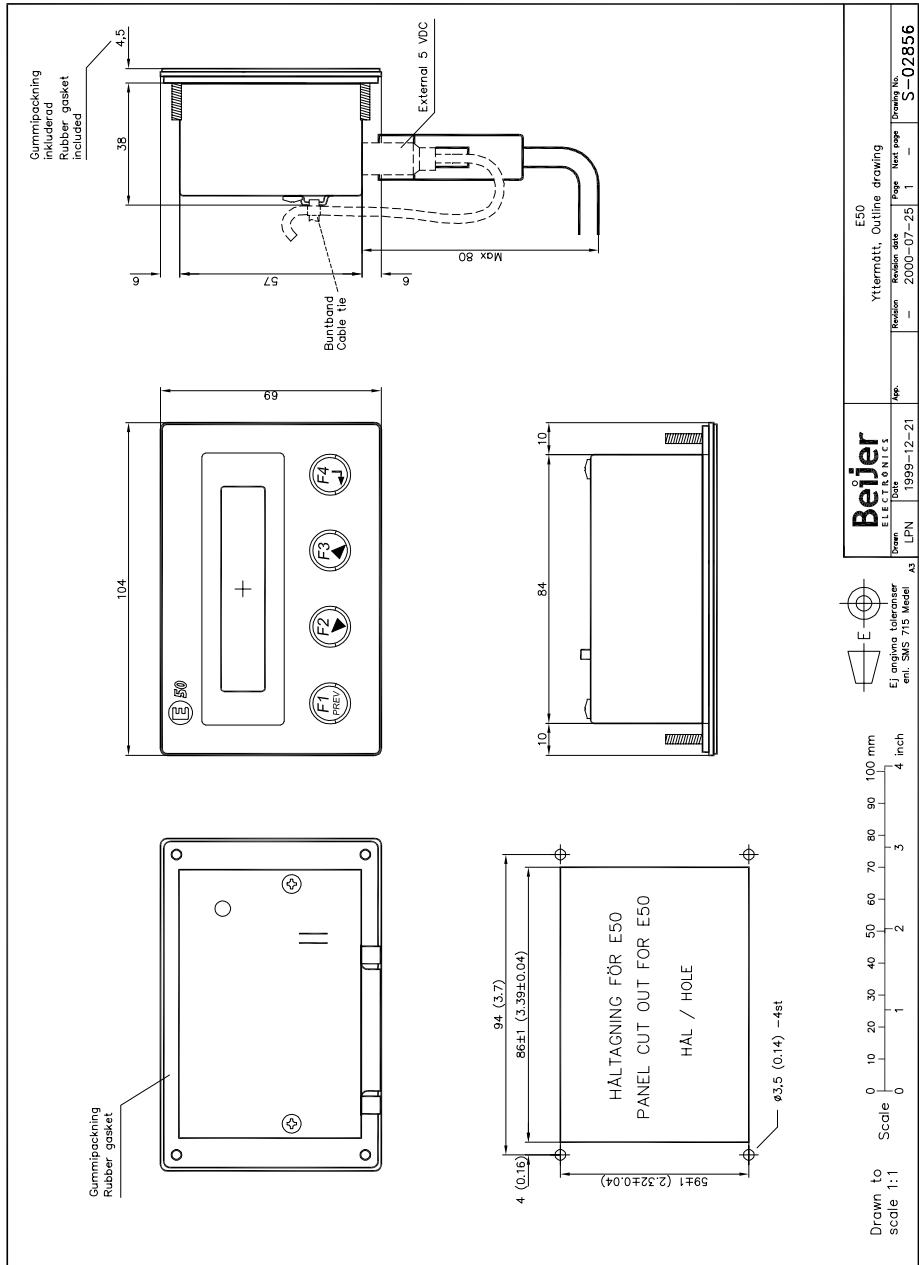

E100 Outline

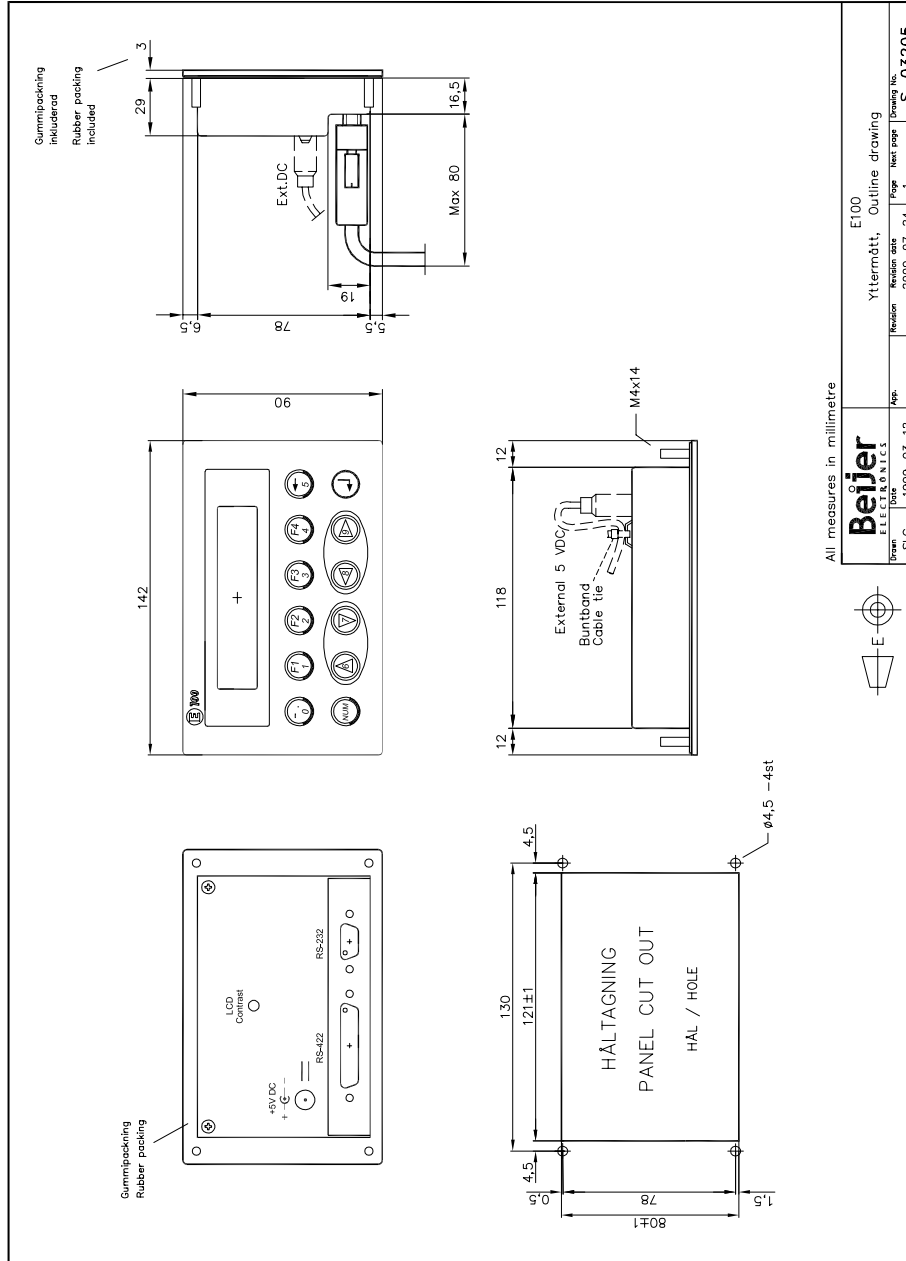

E150 Outline

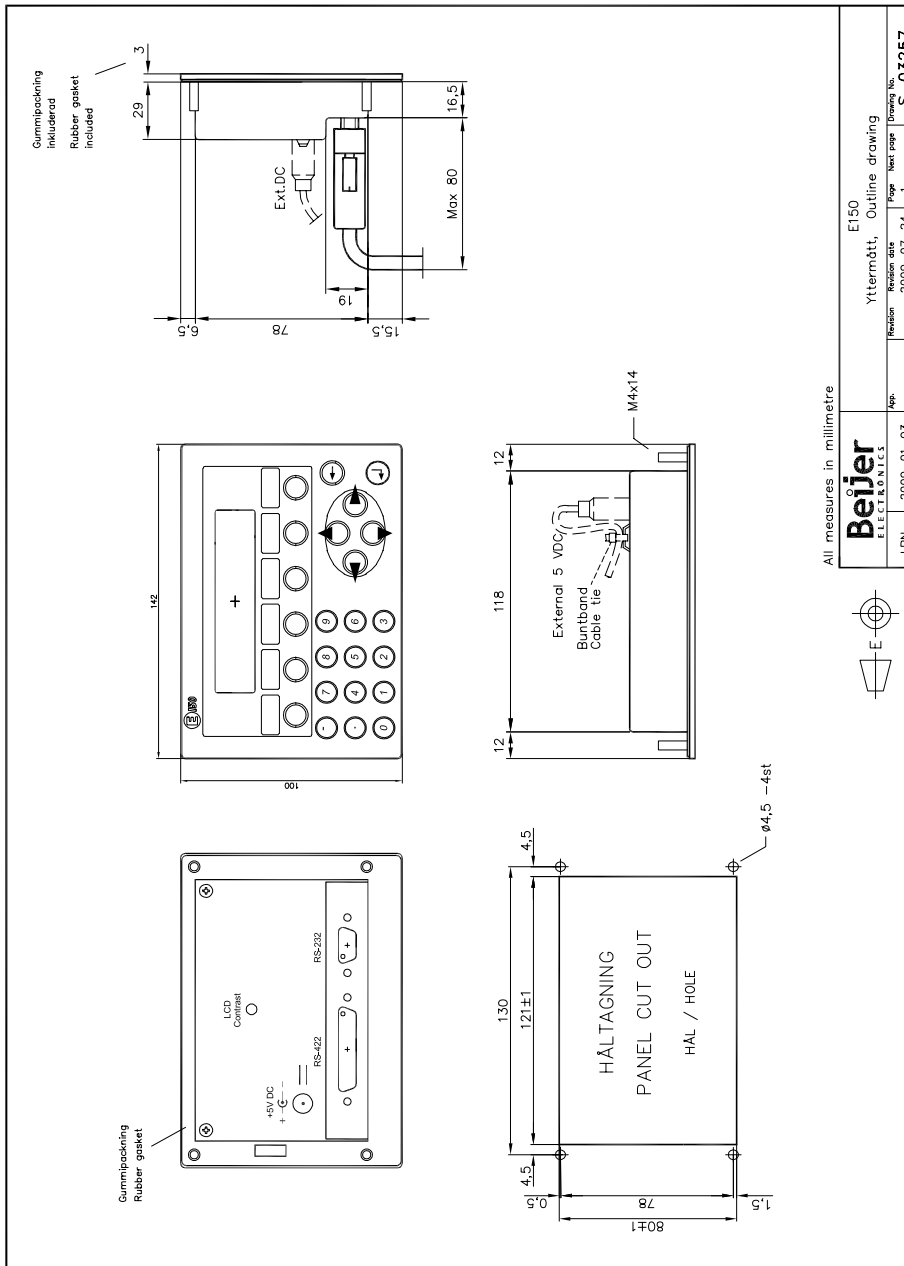

All measures in millimetre

LPN		2000-01-03		App.		Yttermött, Outline drawing		E150	
Revision		2000-07-24		Page		Next page		Drawing No.	
-		-		1		-		S-03257	

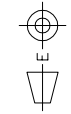

E150 Text strip

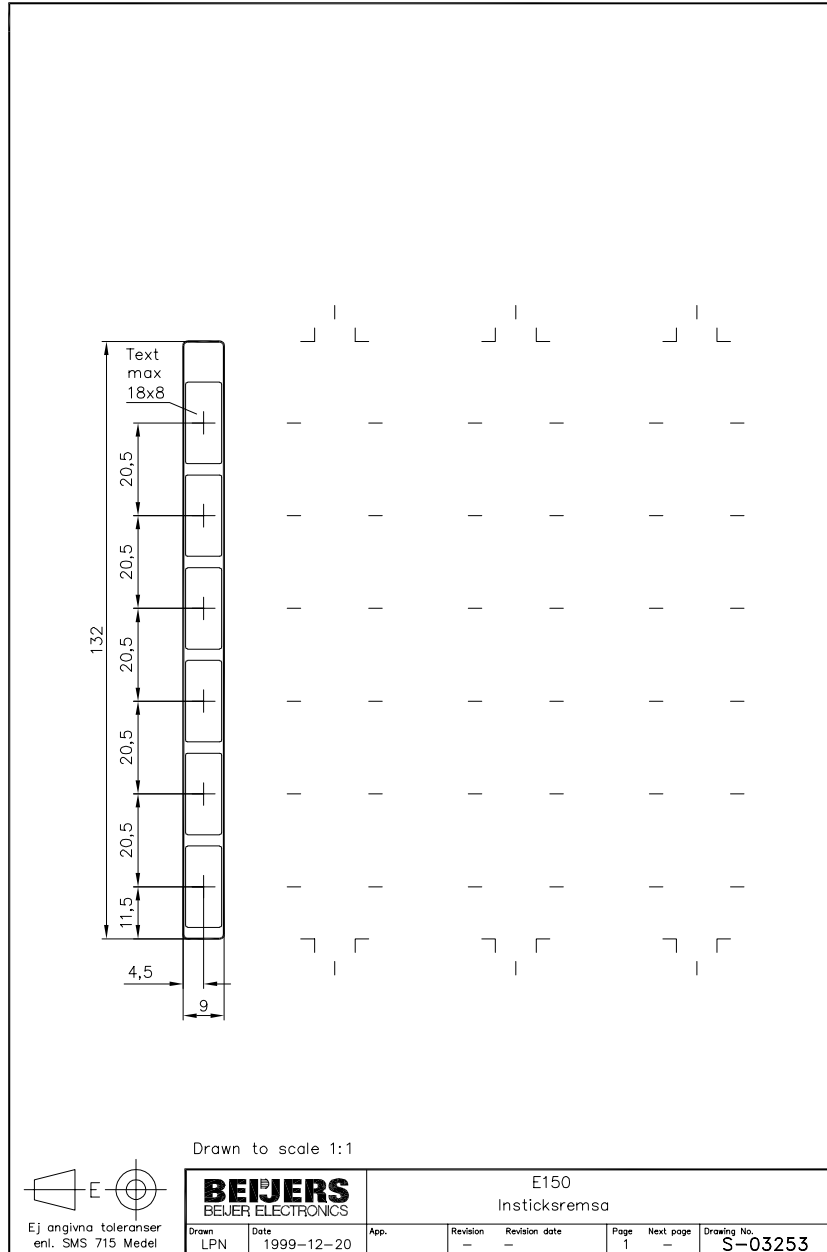

E200 Outline

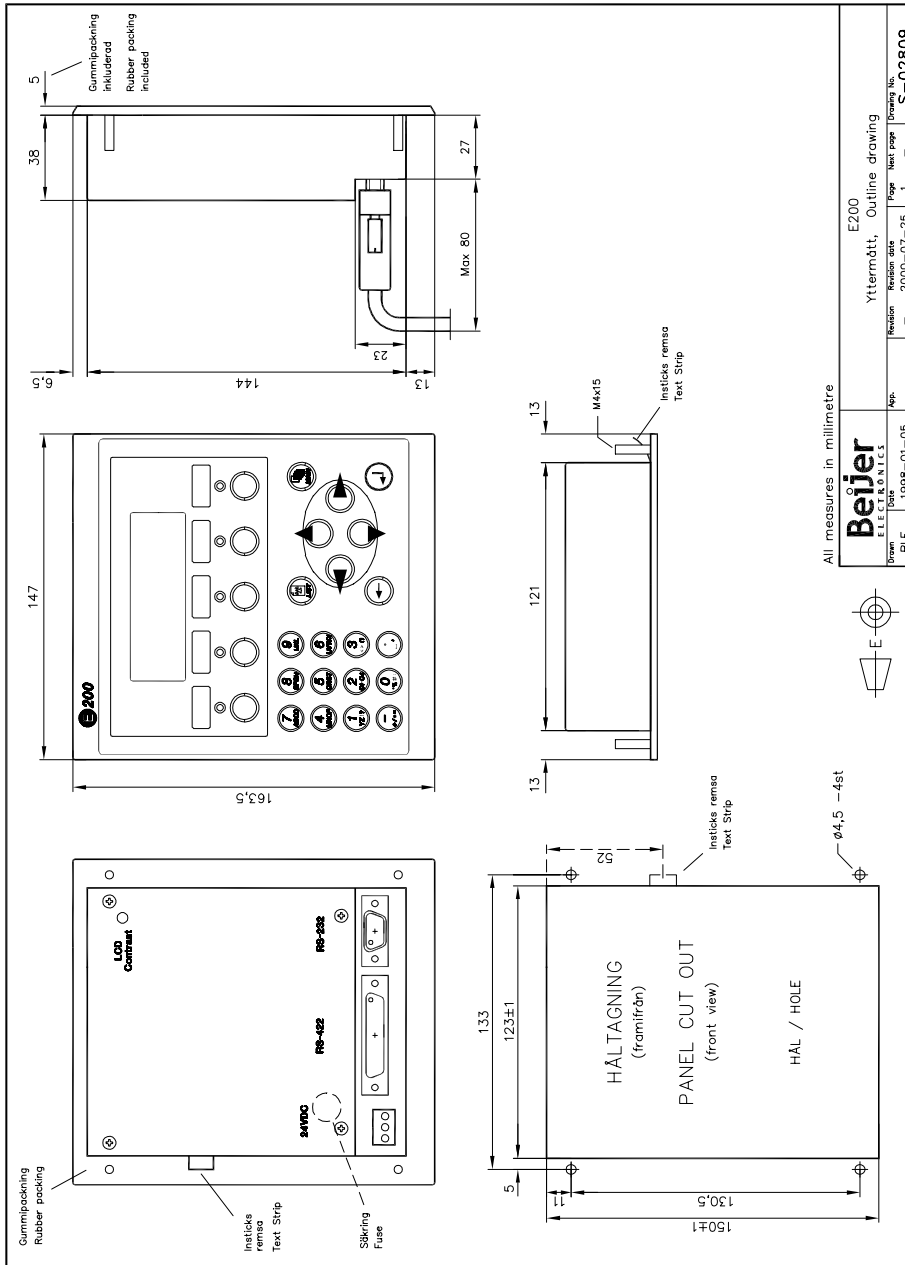

All measures in millimetre



Beijer		E200	
Elektronik		Yttermott, Outline drawing	
Version	1998-01-05	Revision	2000-07-25
Page	1	Page	1
Drawn	BLE	Drawn	BLE
Appr.		Appr.	
		Drawing No. S-02809	

E200 Text strip

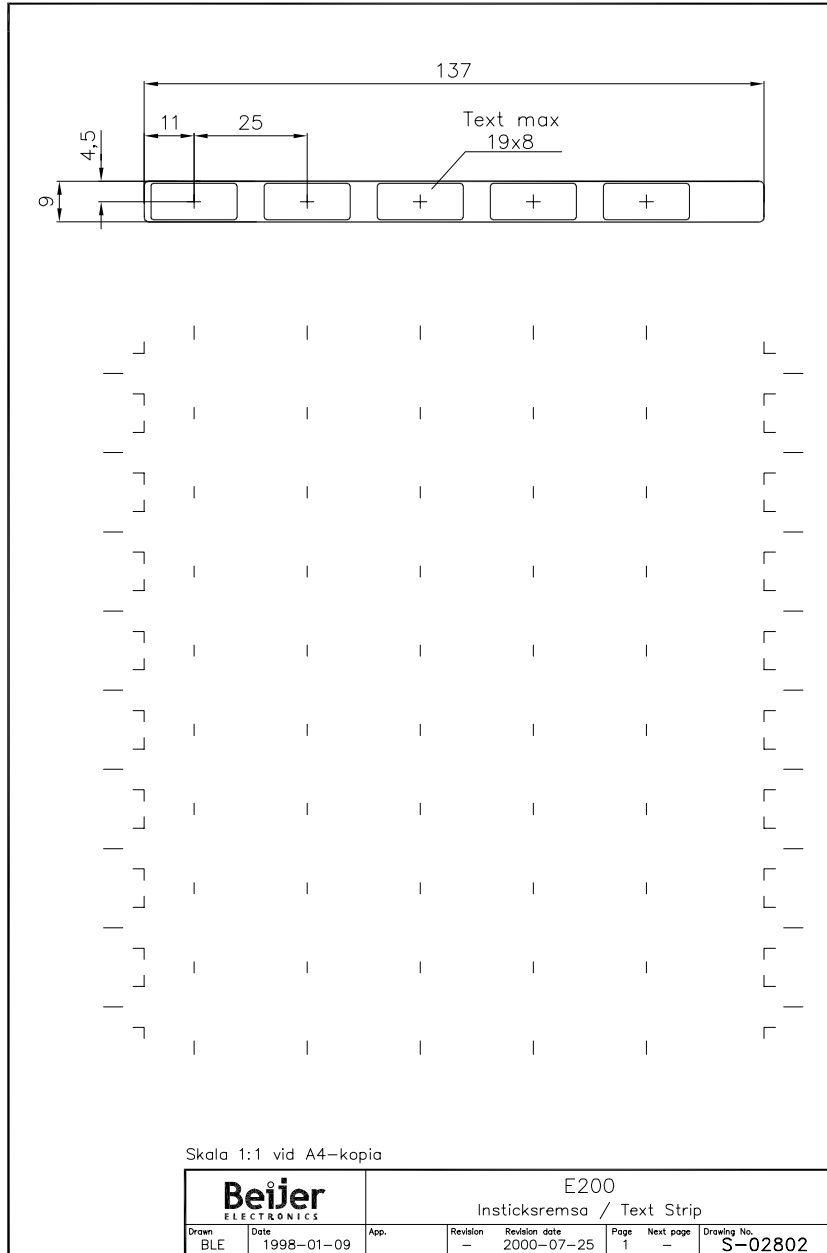

E300 Outline

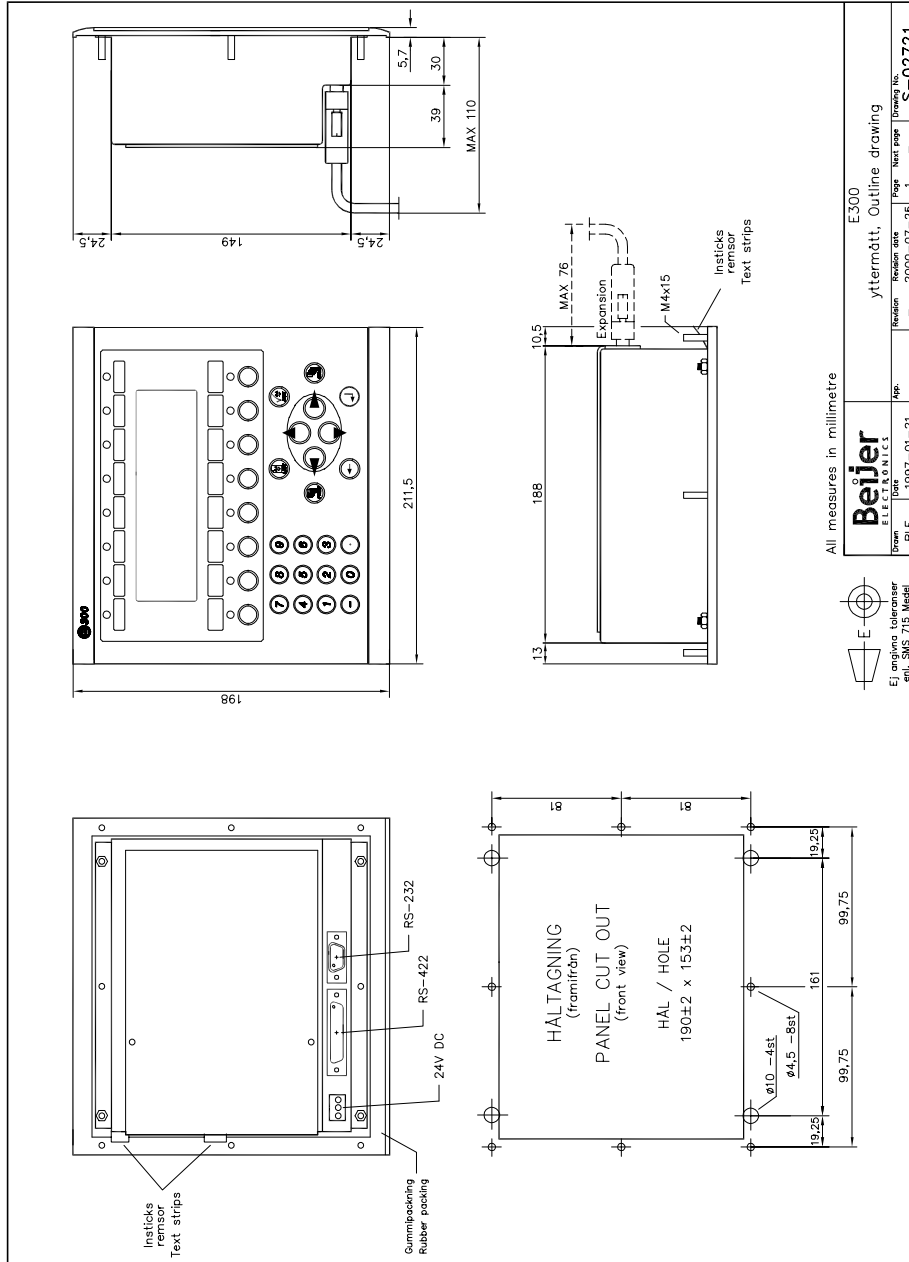

E300 Text strip

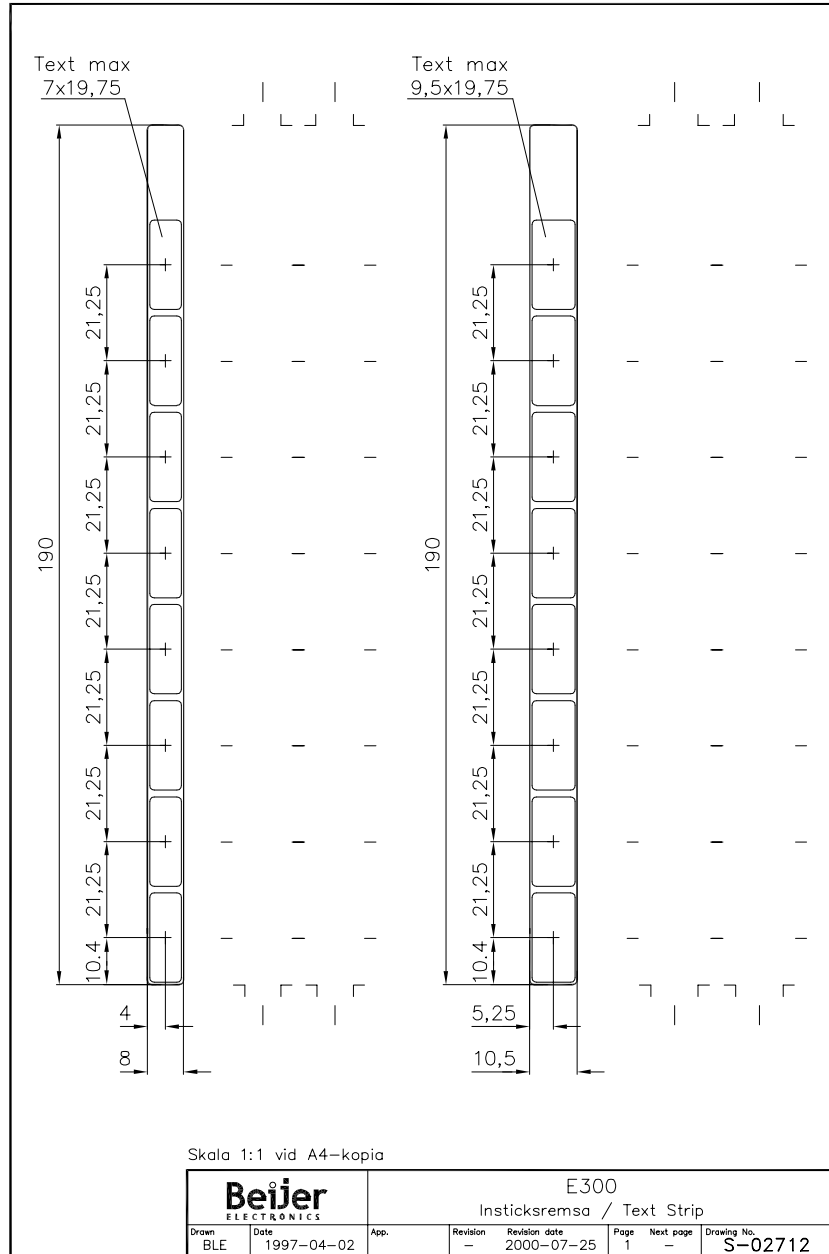

E600 Outline

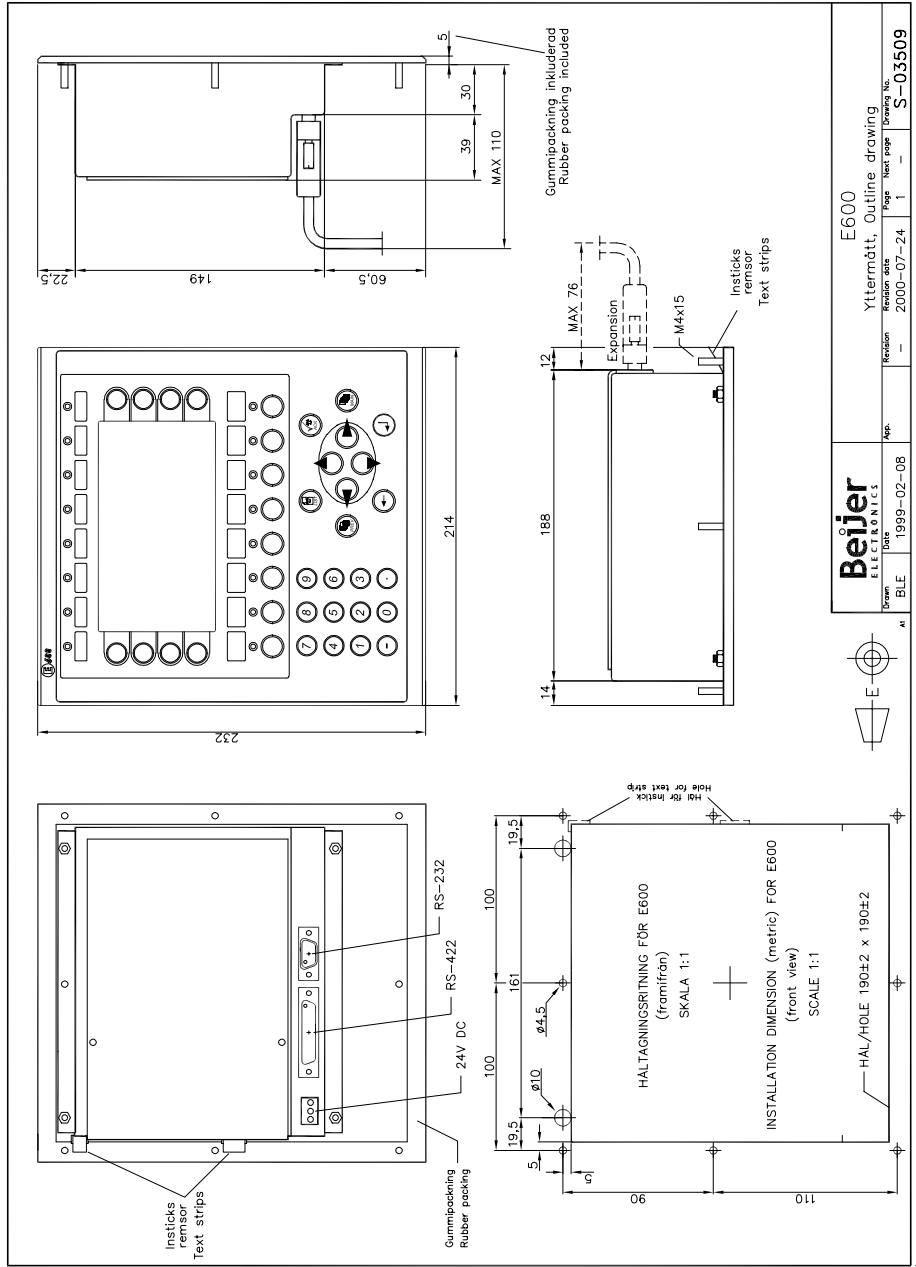

		E600 Yttermätt, Outline drawing	
Drawn	Revision date	Page	Next page
BLE	1999-02-08	1	—
At	2000-07-24	1	—
		Drawing No. S-03509	

E600 Textstrip

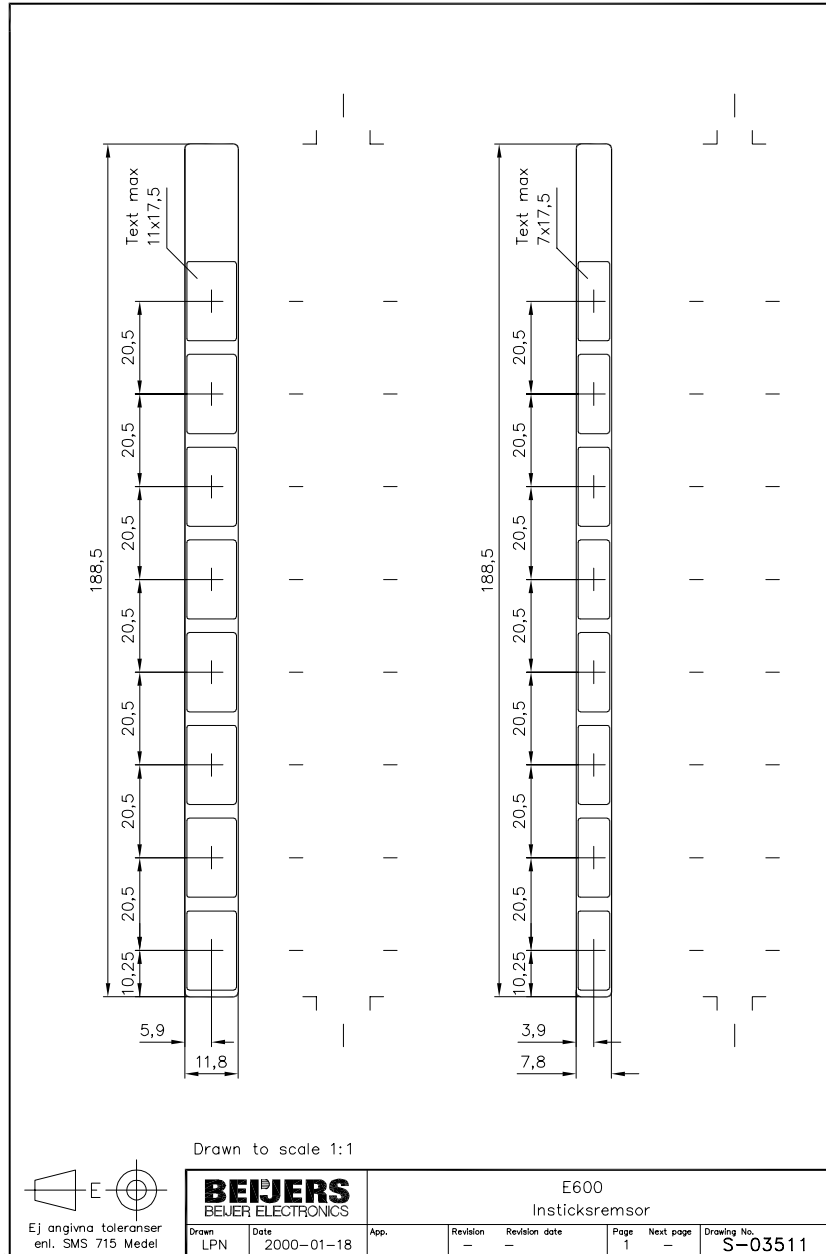

Drawn to scale 1:1

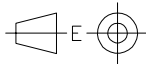

Ej angivna toleranser
enl. SMS 715 Medel

BEIJERS BEIJER ELECTRONICS		E600 Insticksremsor				
Drawn LPN	Date 2000-01-18	App.	Revision -	Revision date -	Page 1	Next page -
						Drawing No. S-03511

E610/E615/E615T Outline

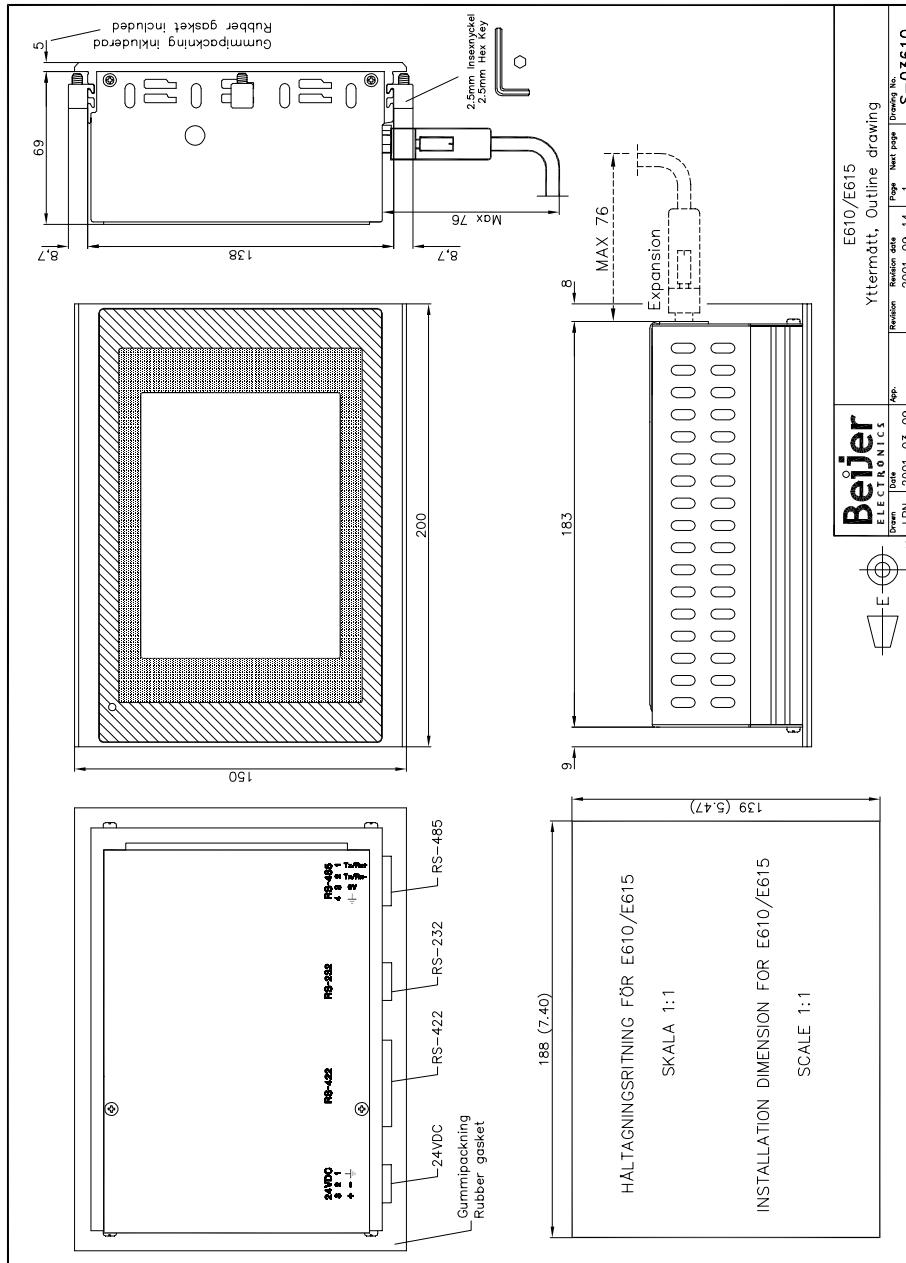

E700 Outline

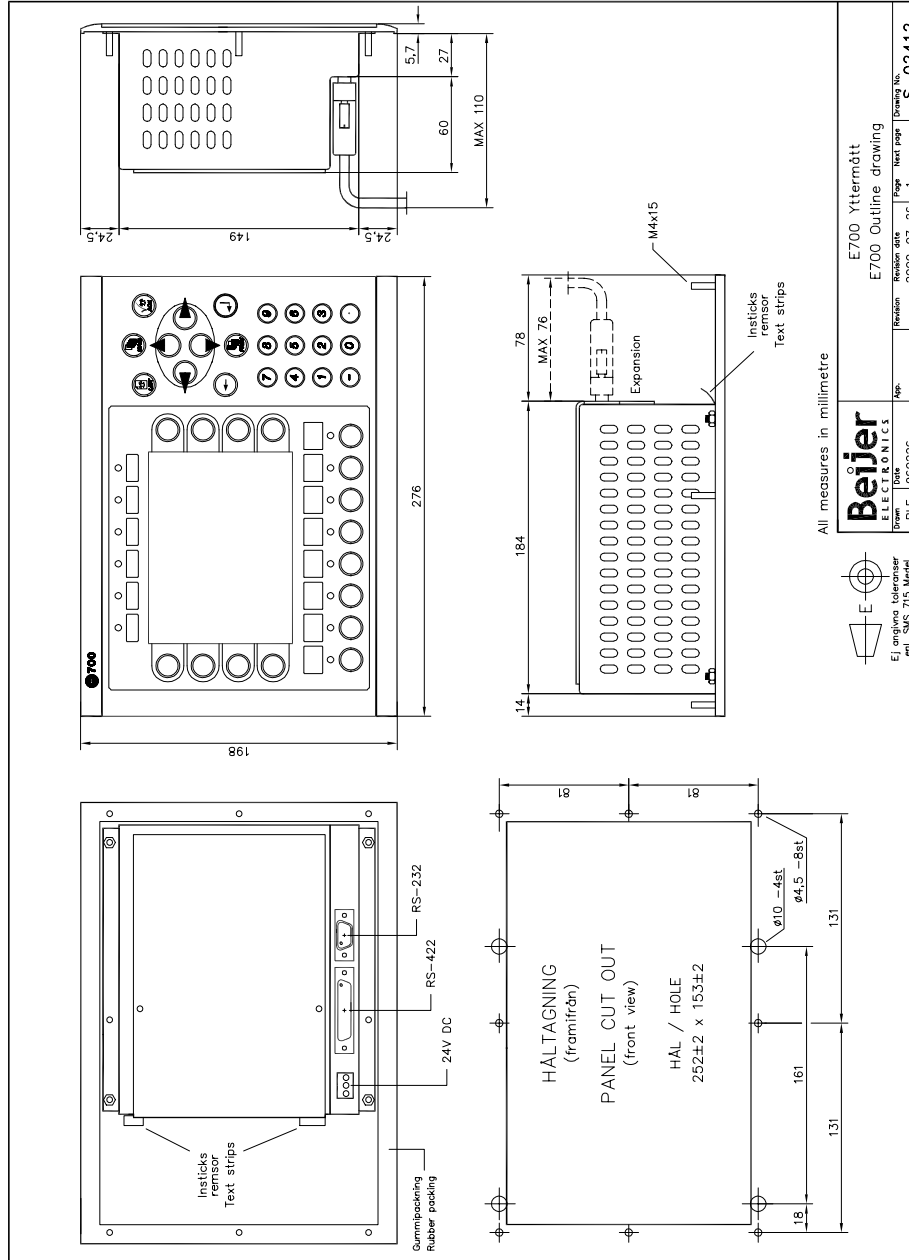

All measures in millimetre

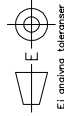

Ej originala toleranser enl. SMS 715 Medel A3

Beijer
ELECTRONICS

E700 Yttermött
E700 Outline drawing

Revision	2000-07-26	1	—	—	—
Page	Next page	1	—	—	—
Revision No.	—	—	—	—	S-02412

E700 Text strip

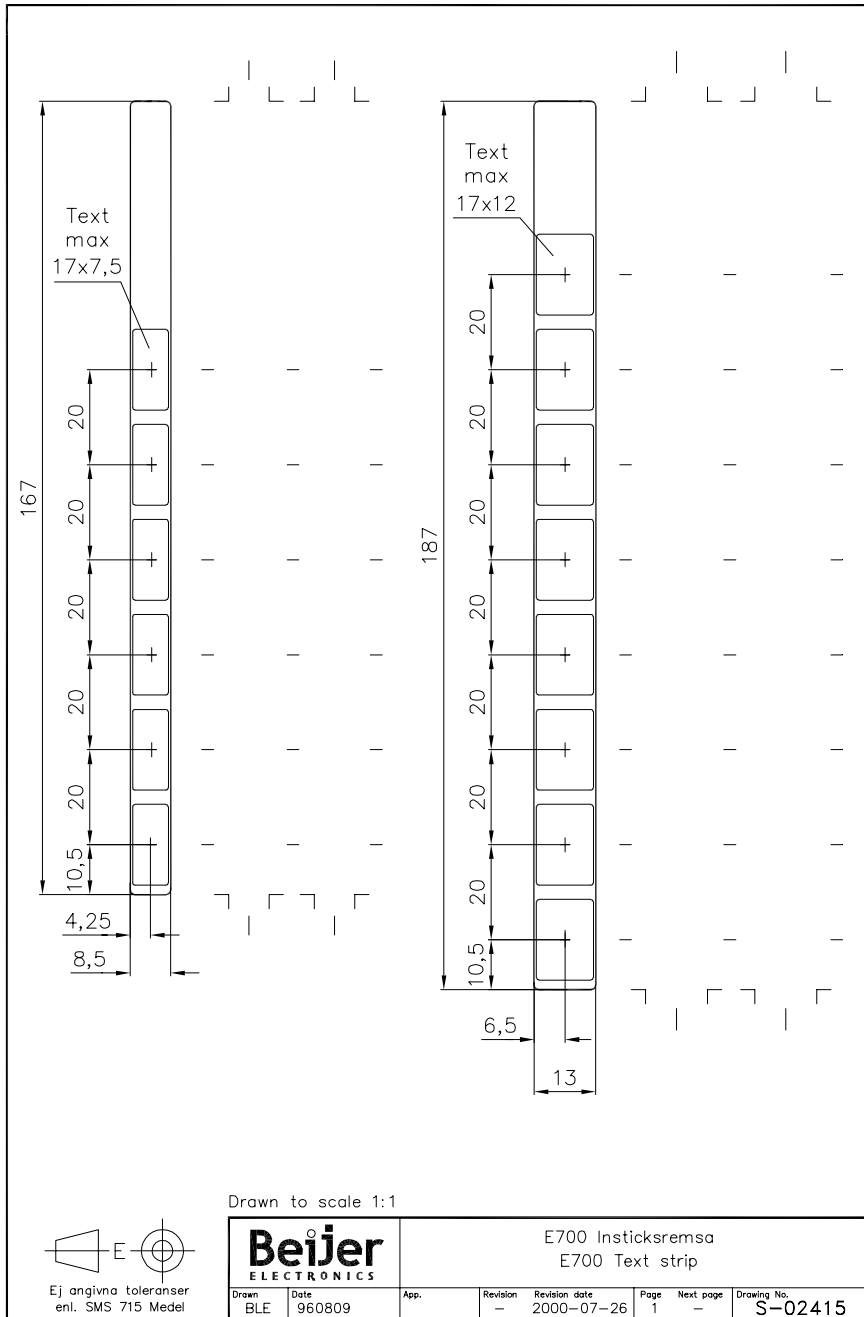

E710 Outline

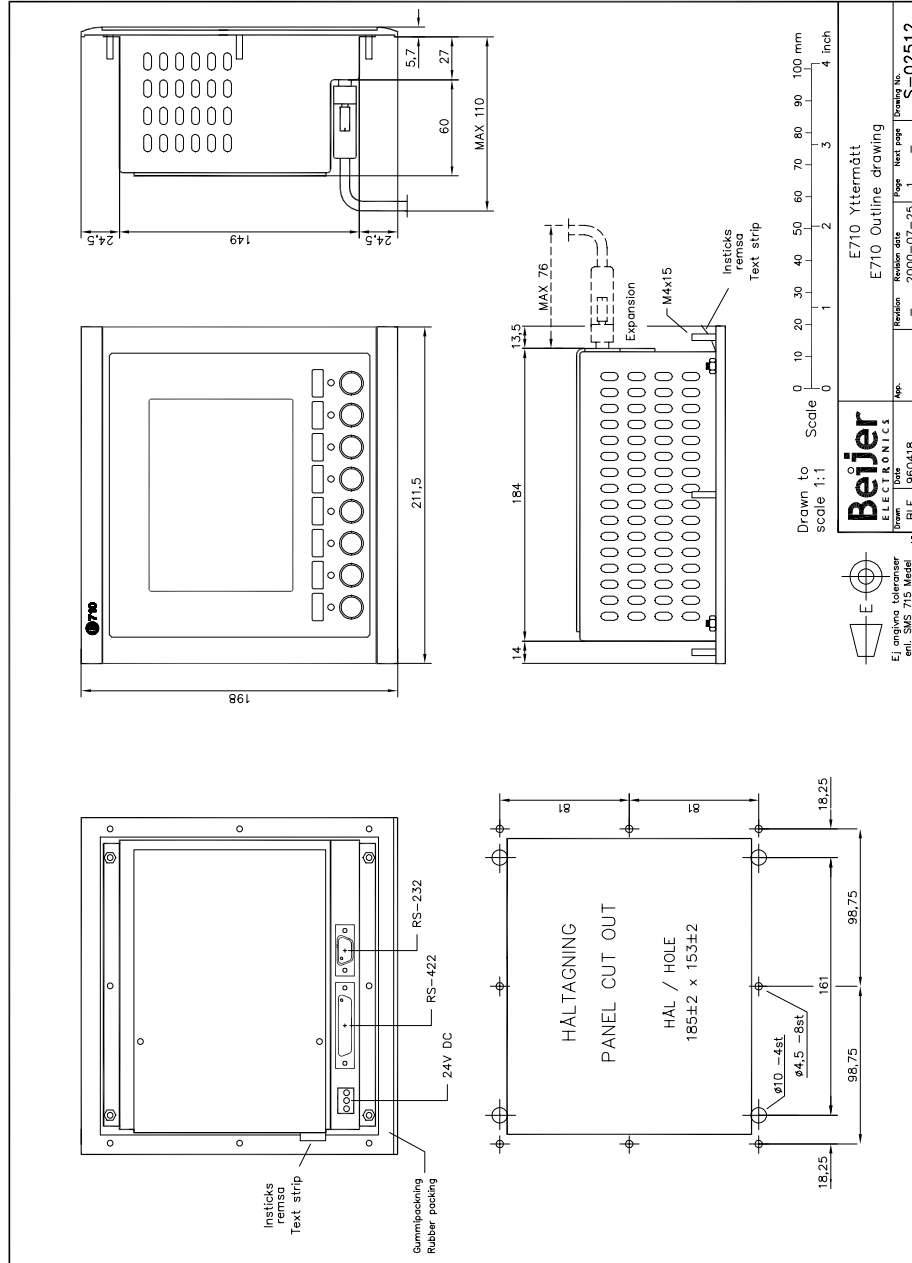



 E710 Yttermött
 E710 Outline drawing
 Drawn: BLE | 960418
 Date: 2000-07-25
 Revision: 1
 Page: 1
 Drawing No.: S-02512

E710 Text strip

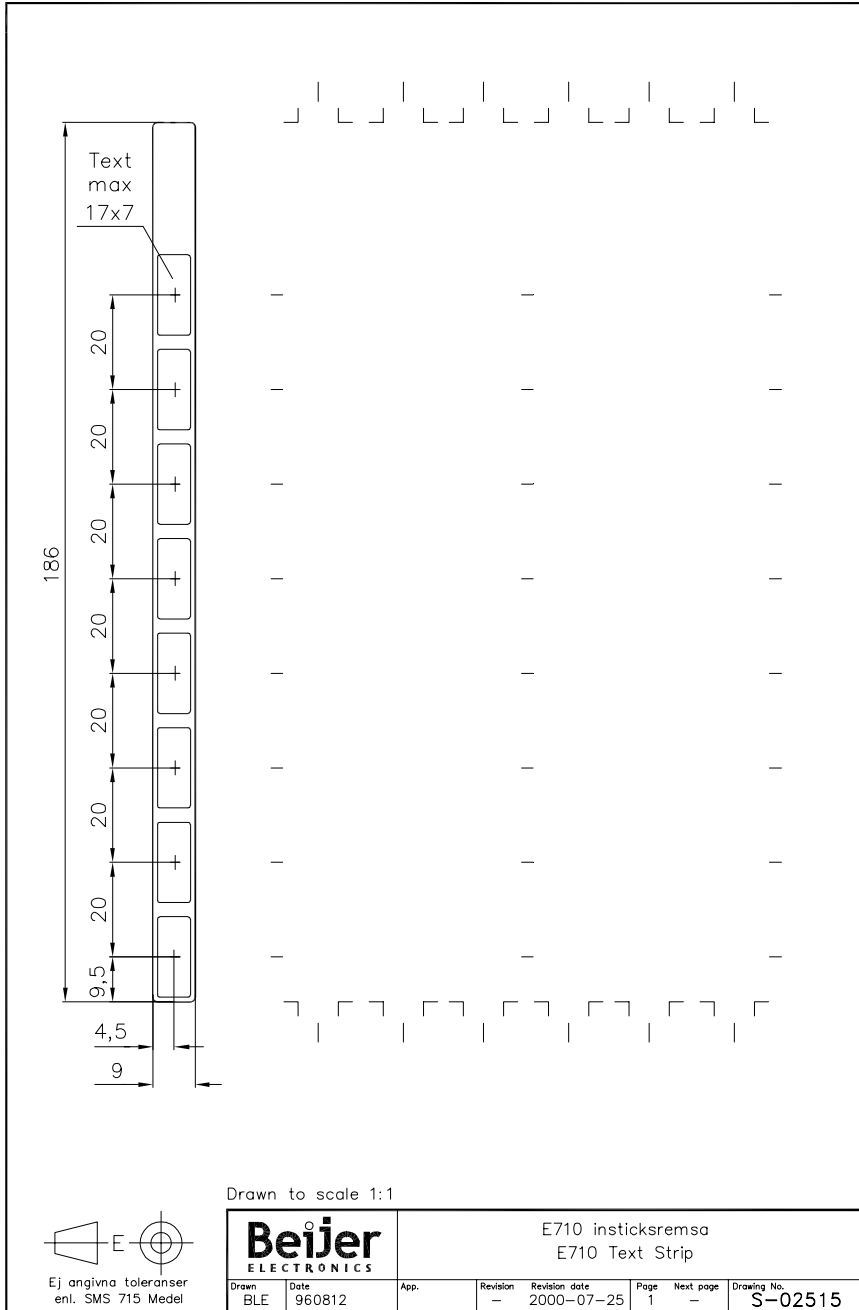

E900T Installation

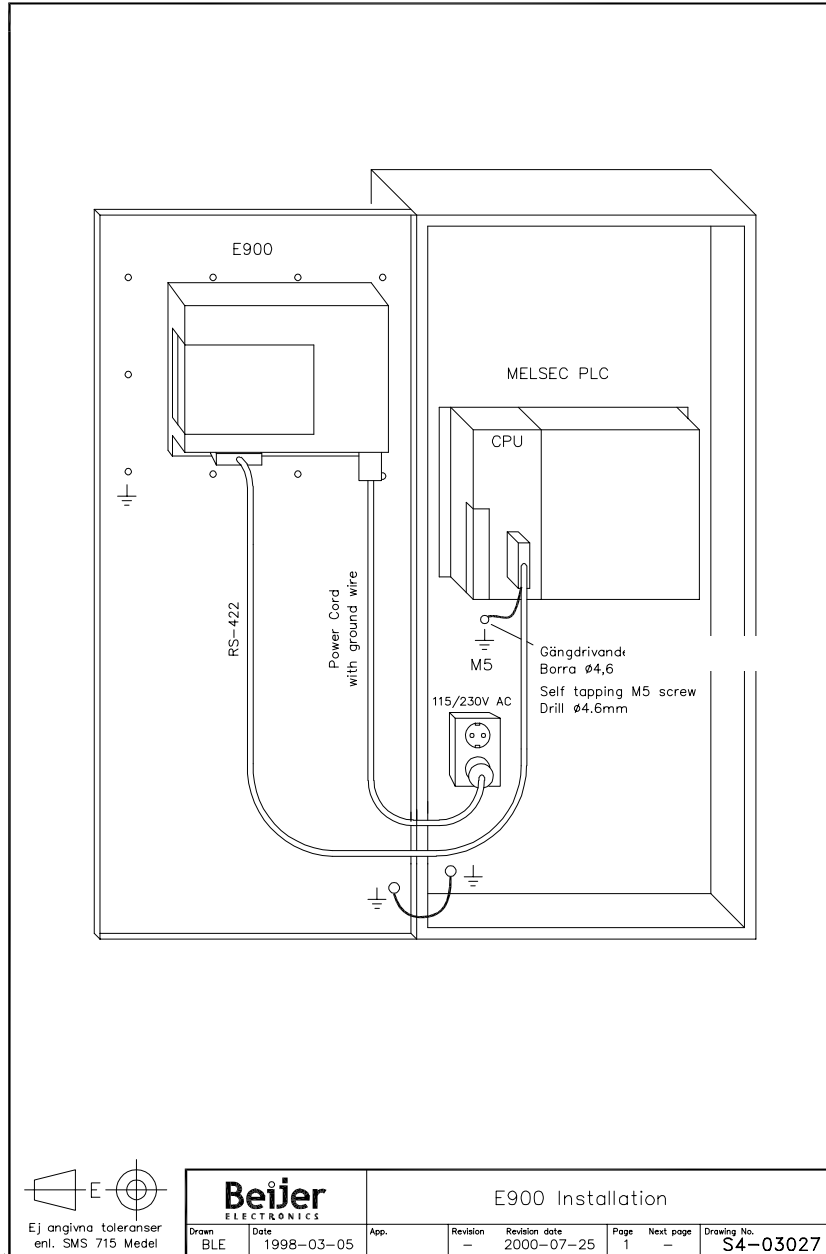

E900T Outline

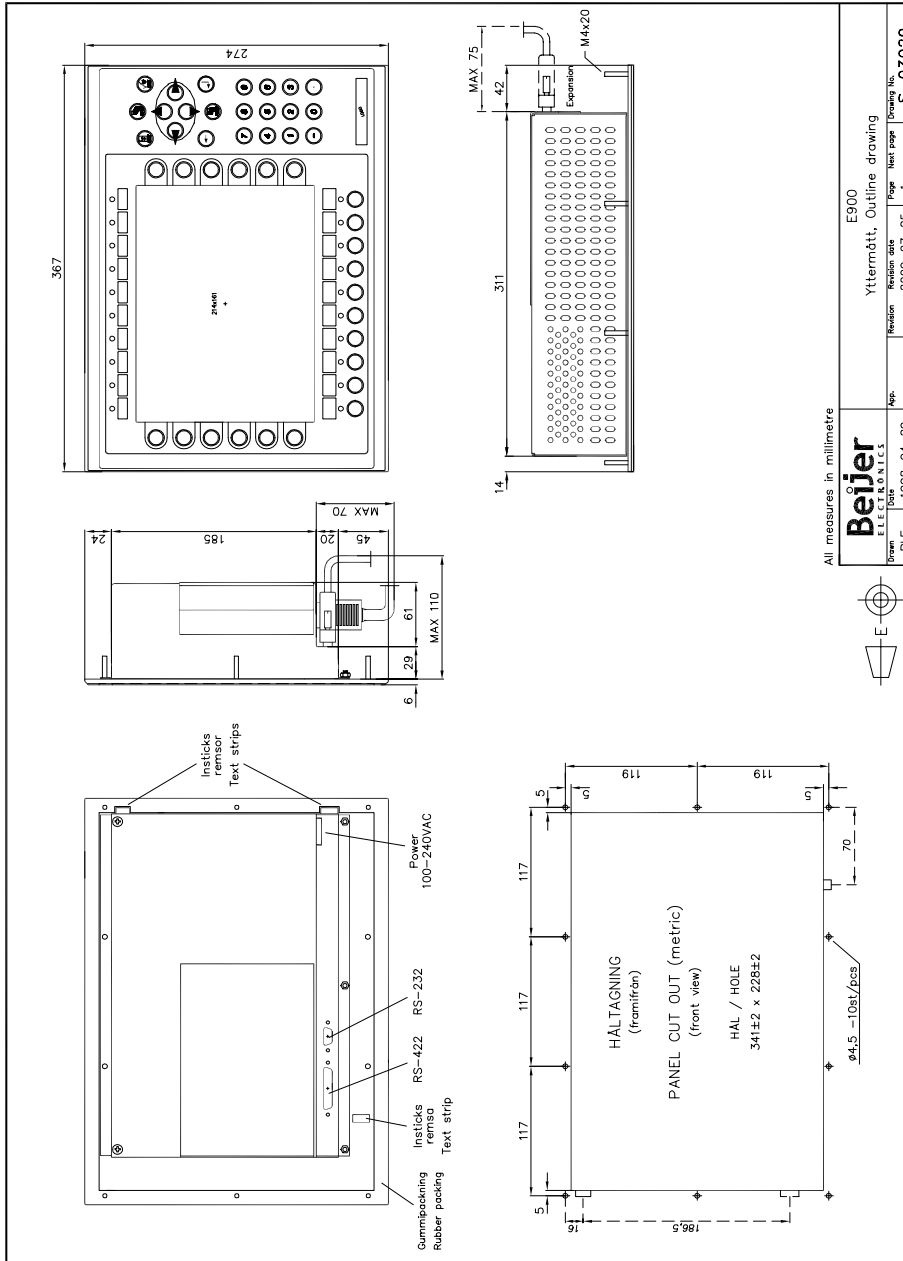

All measures in millimetre

Beijer		E900	
ELECTRONICS		Yttermøtt, Outline drawing	
Form	Task	Revision	Page
ELE	1398-04-29	—	1
		Revision date	Next page
		2000-07-25	—
		Drawing No.	S-03029



E900TD Installation

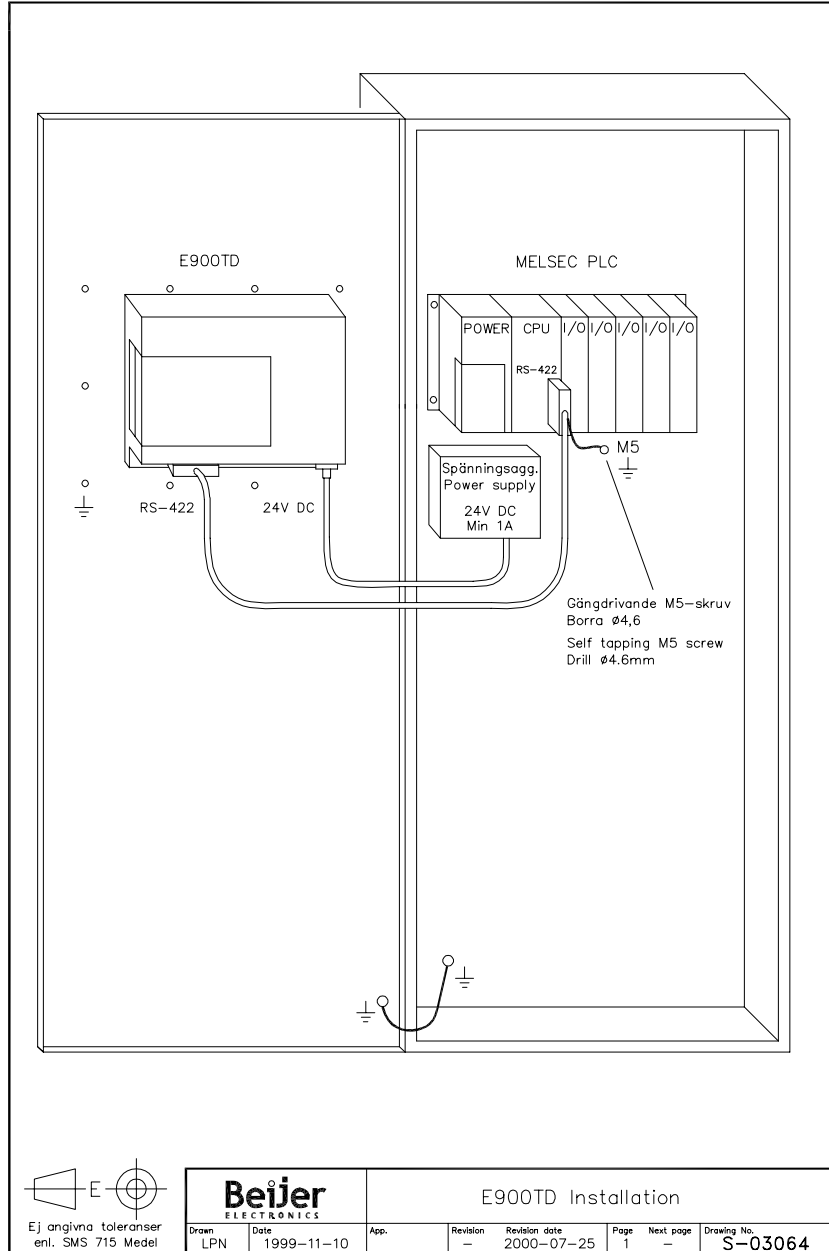

E
Ej angivna toleranser
enl. SMS 715 Medel

Beijer ELECTRONICS		E900TD Installation				
Drawn LPN	Date 1999-11-10	App.	Revision -	Revision date 2000-07-25	Page 1	Next page -
						Drawing No. S-03064

E900TD Outline

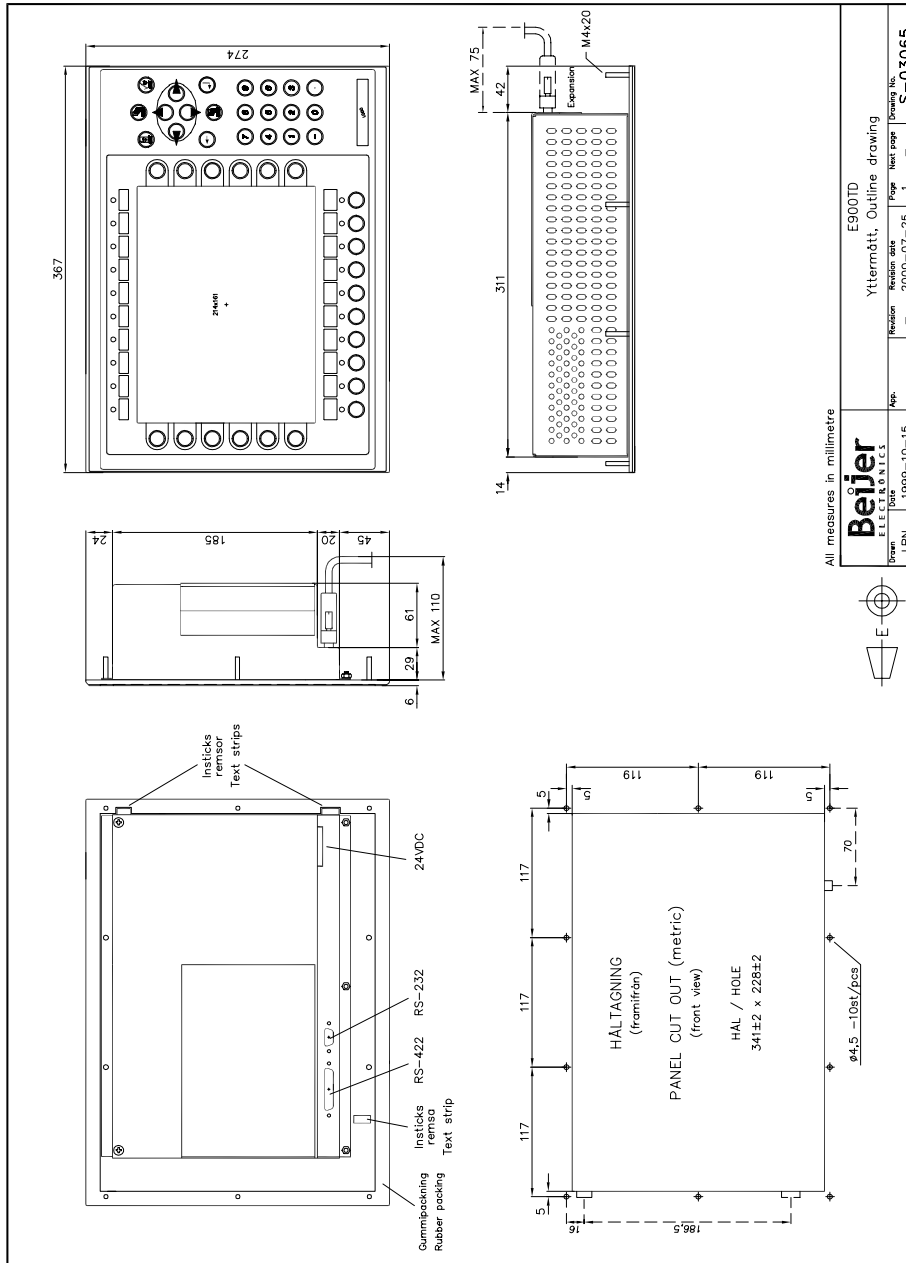

All measures in millimetre

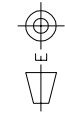

Drawn	LPN	1999-10-15	App.	Revision	2000-07-25	Page	1	Order No.	S-03065
Beijer ELECTRONICS			E900TD			Yttermätt, Outline drawing			

E900T/E900TD Text strip

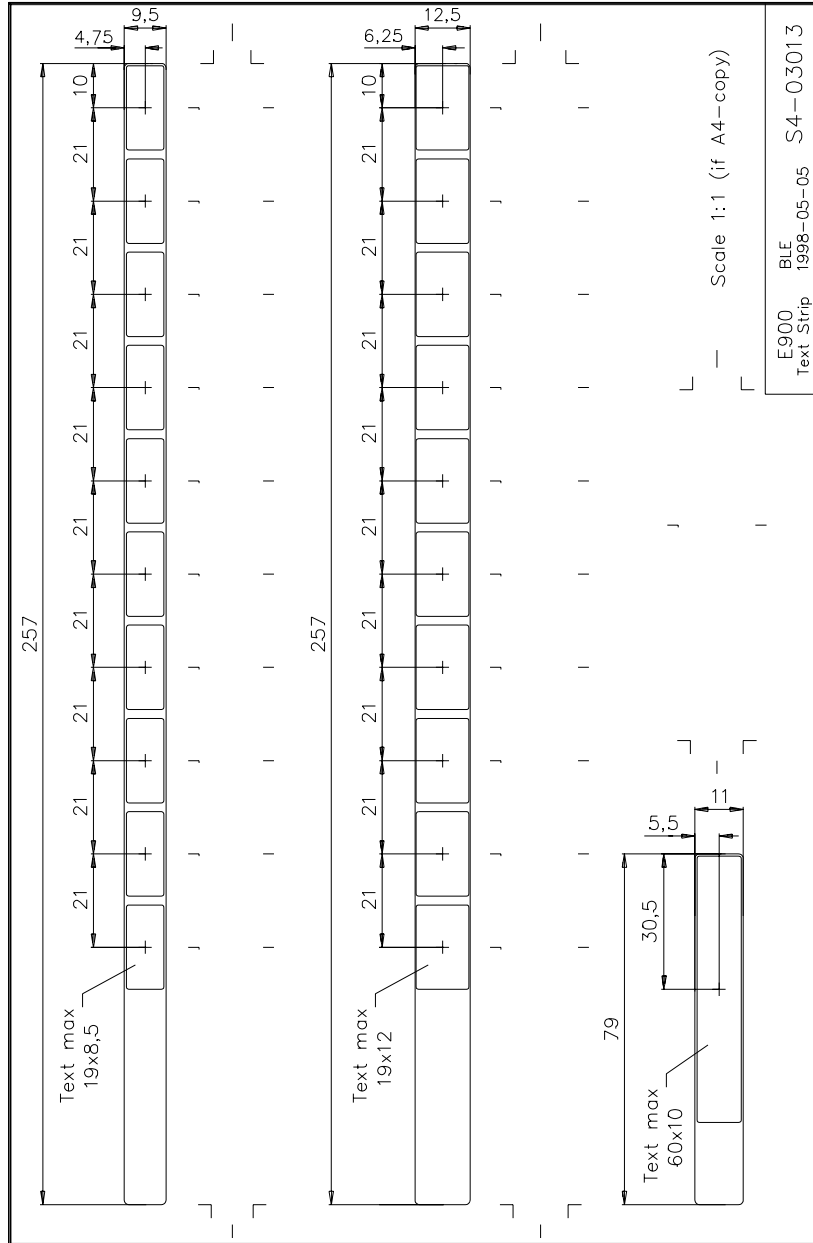

E900VT Installation

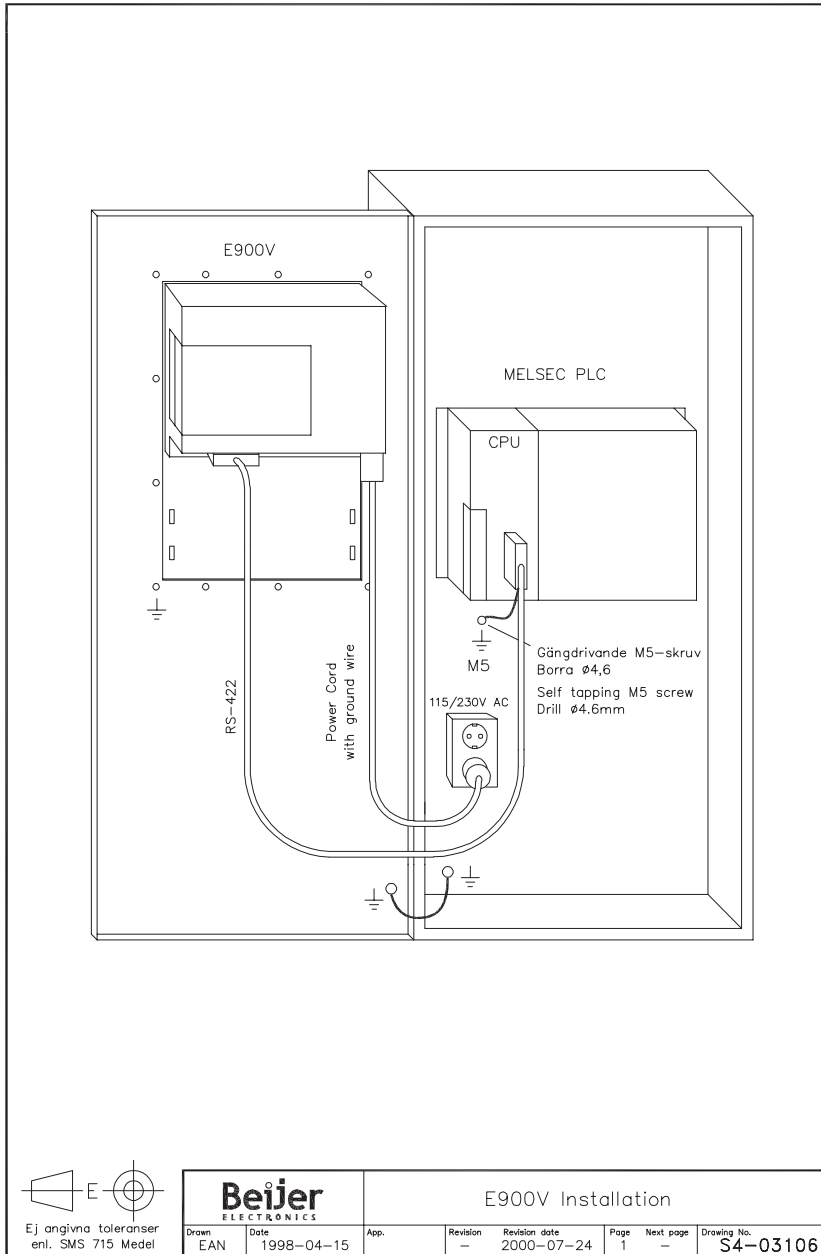

E900VT Outline

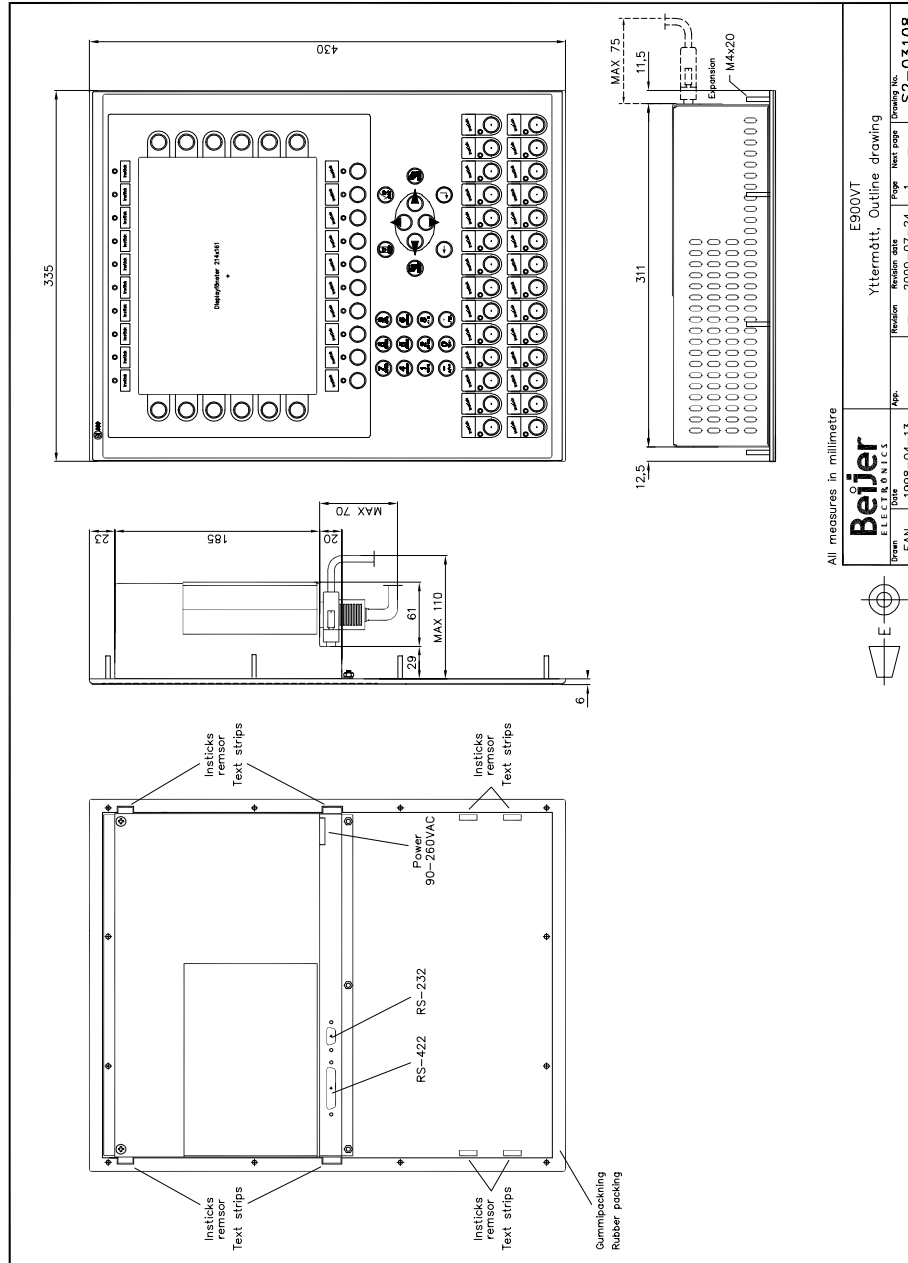

All measures in millimetre

		E900VT	
Yttermätt, Outline drawing		Revision date: 2000-07-24	
Drawn: EAN	Date: 1998-04-13	Page: 1	Drawing No.: S2-03108

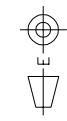

E900VT Text strip

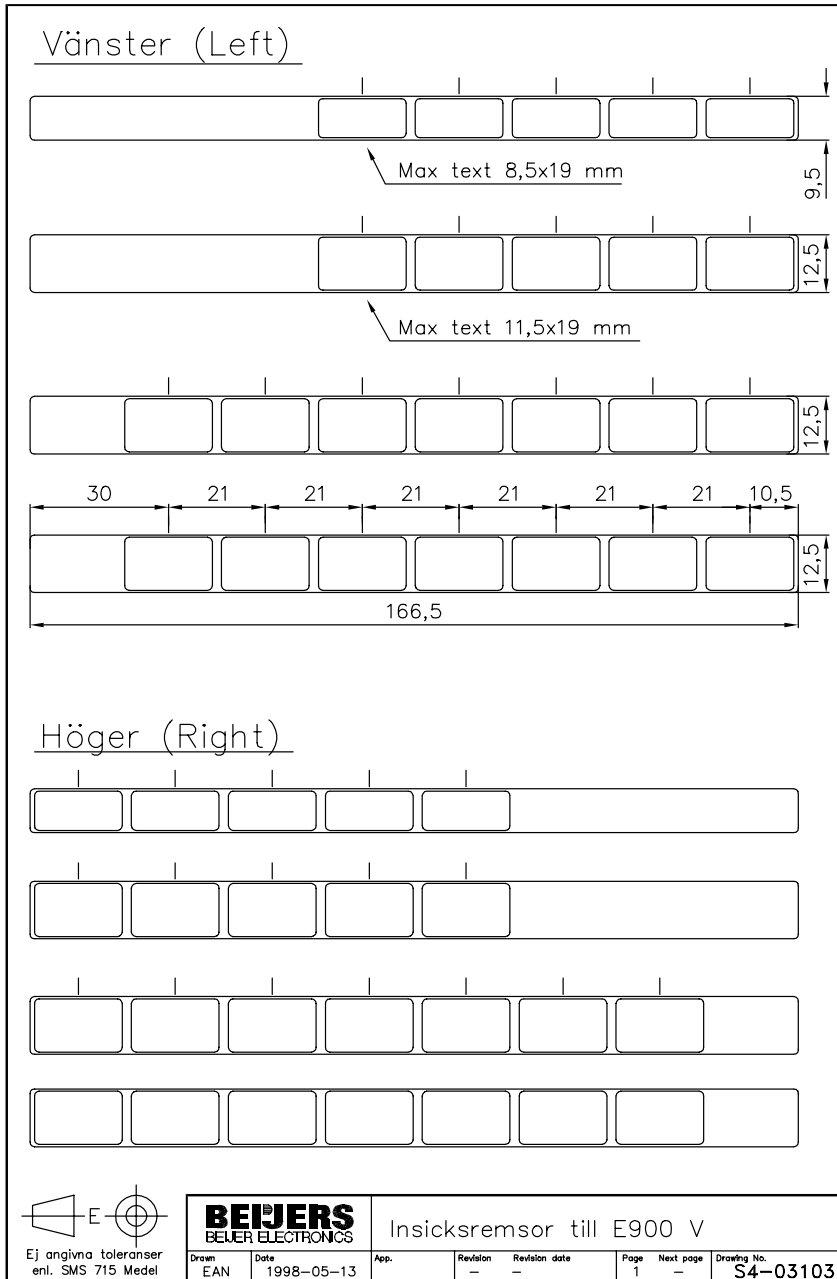

E910T Installation

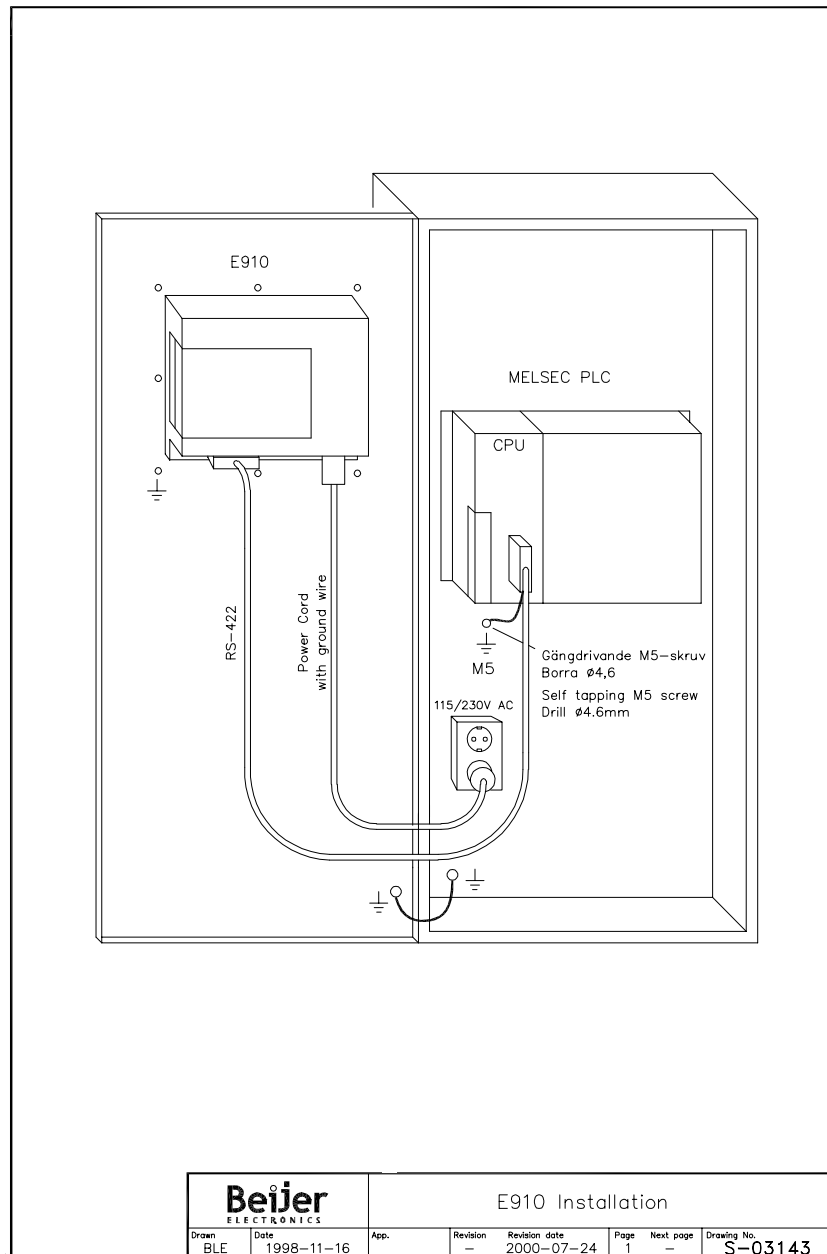

Beijer ELECTRONICS		E910 Installation					
Drawn BLE	Date 1998-11-16	App.	Revision -	Revision date 2000-07-24	Page 1	Next page -	Drawing No. S-03143

E910T Outline

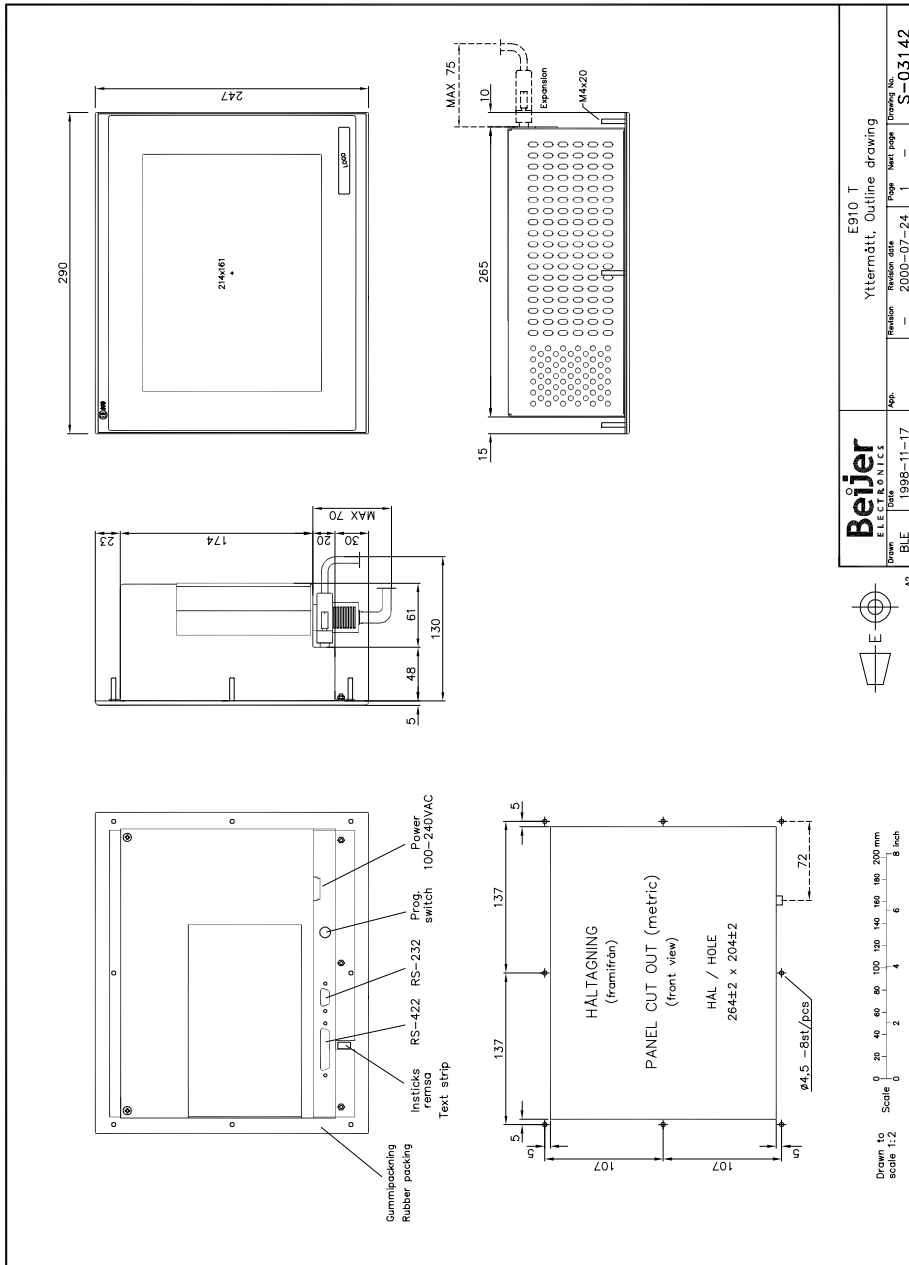

E910TD Installation

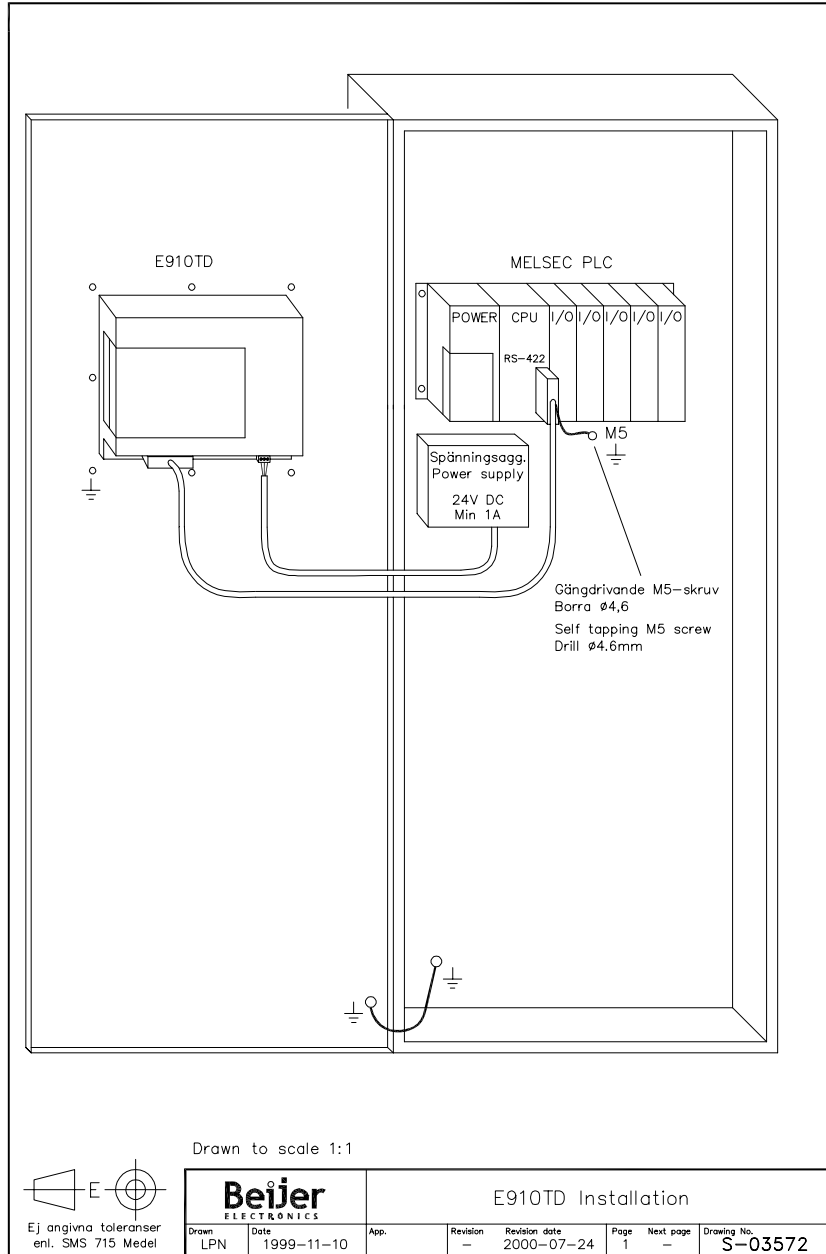

E910TD Outline

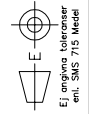
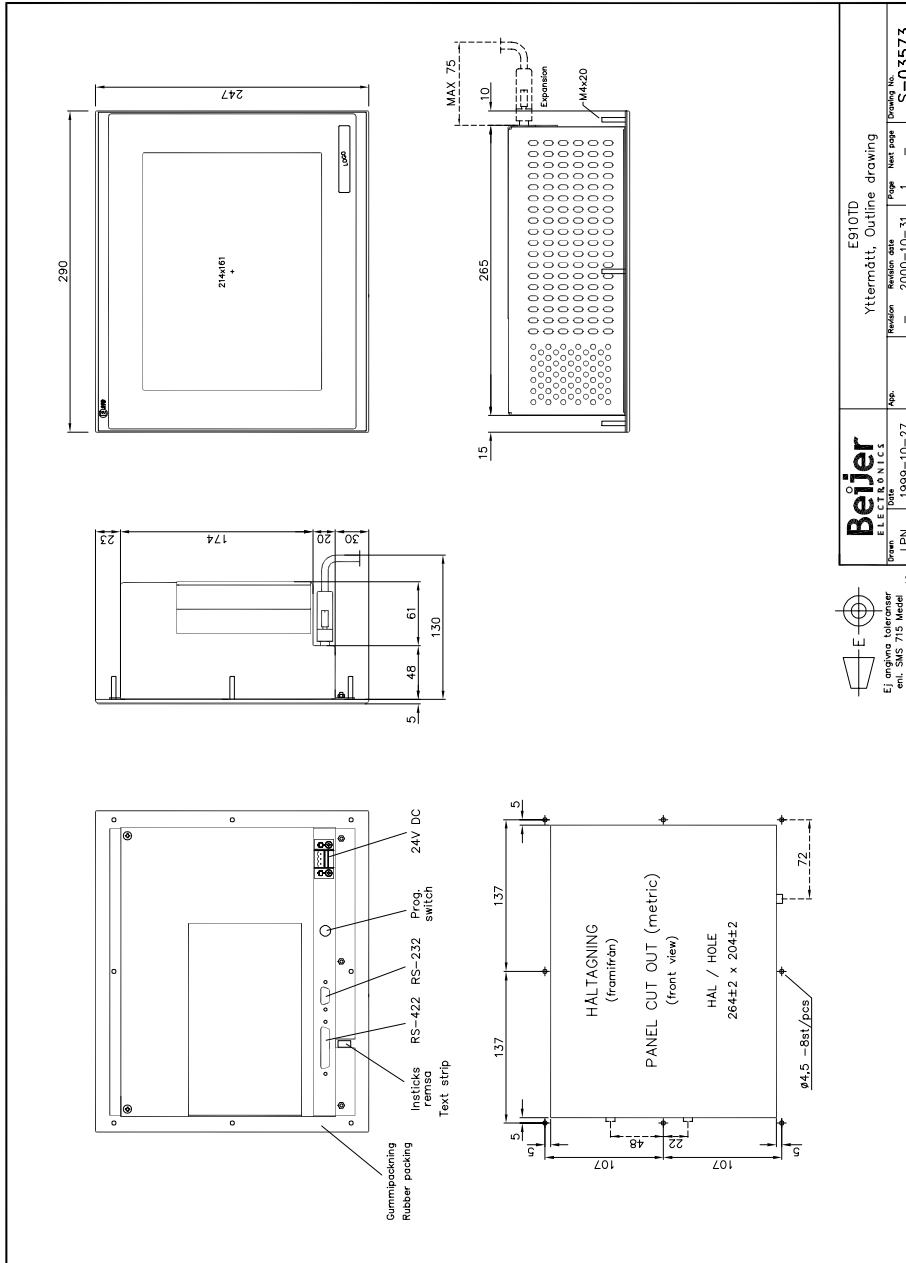

Ej anslutnings behövs
enl. SMS 715 Metel

Beijer
ELECTRONICS

Drum LPN	1989-10-27	App.	Version	2000-10-31	Page	1	Next page	1	Order No.	S-03573
----------	------------	------	---------	------------	------	---	-----------	---	-----------	---------

E910TD
Yttermätt, Outline drawing

Cable drawings

CAB16

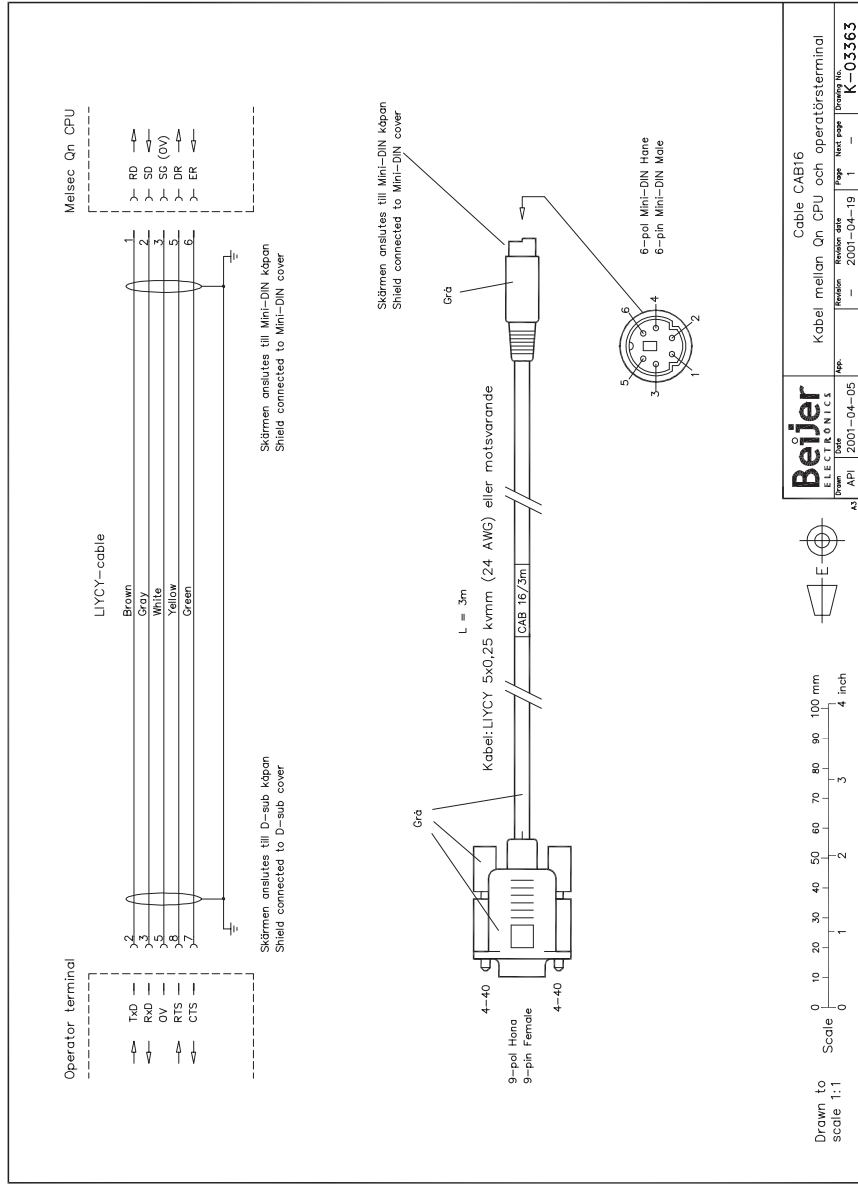

CAB17

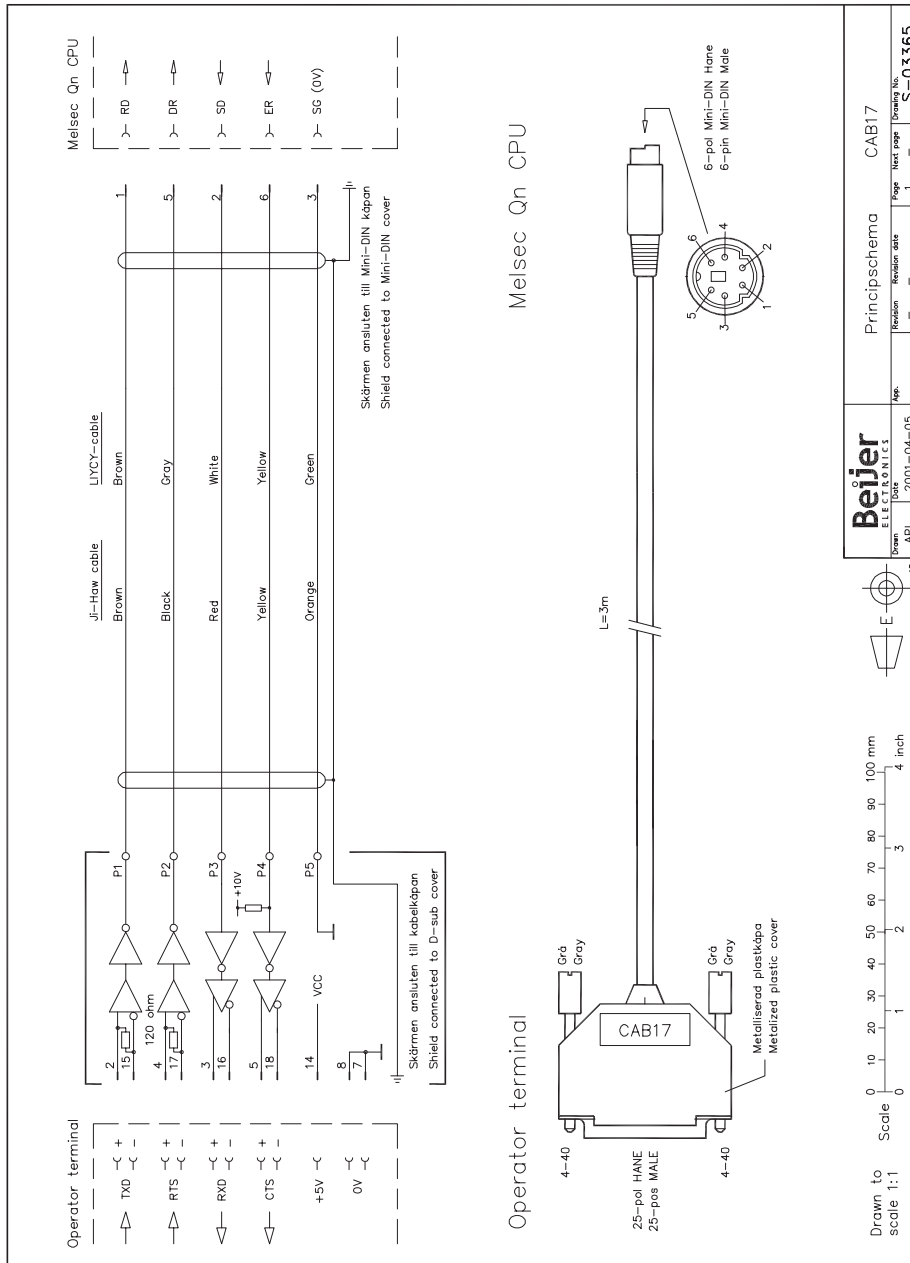

CAB18

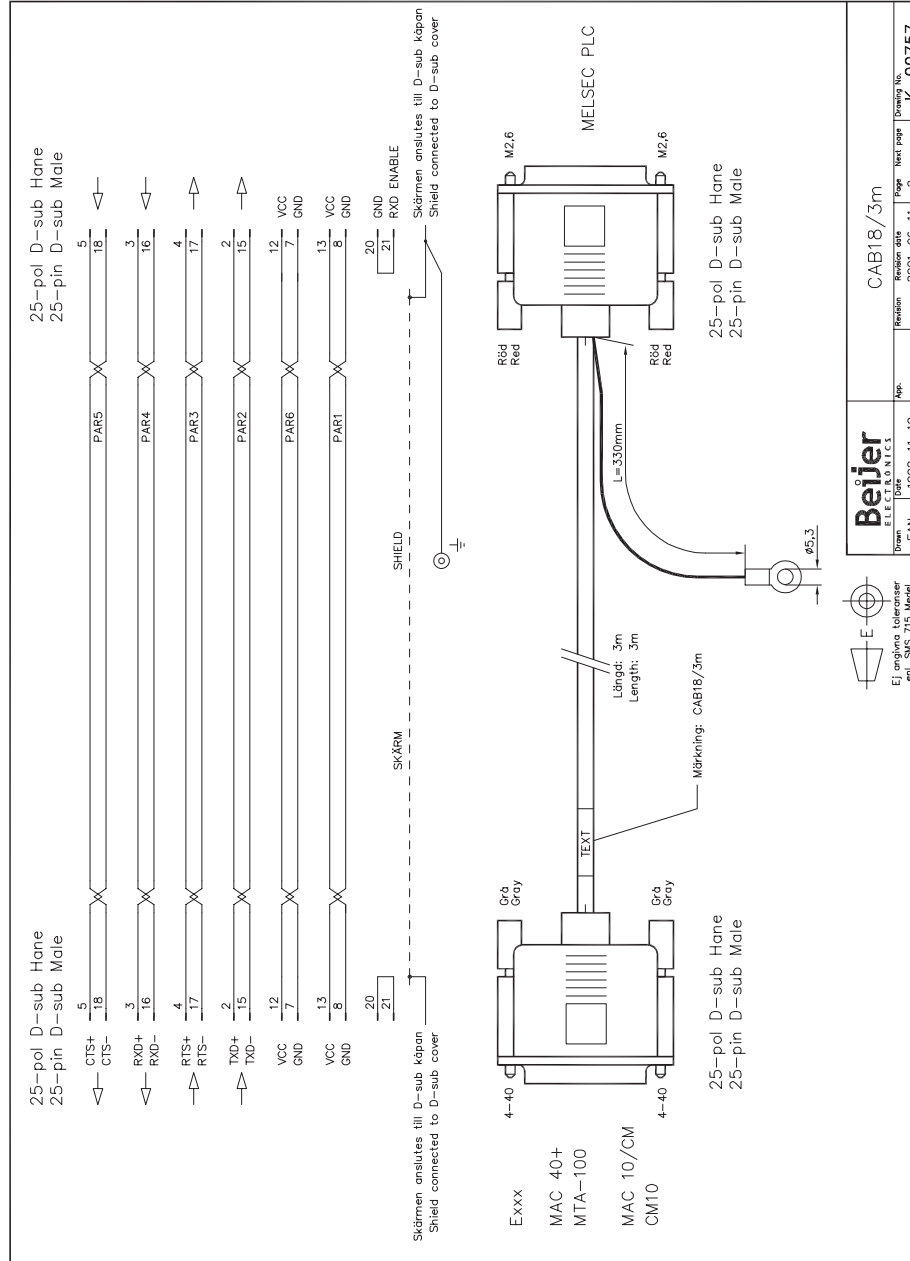

CAB19

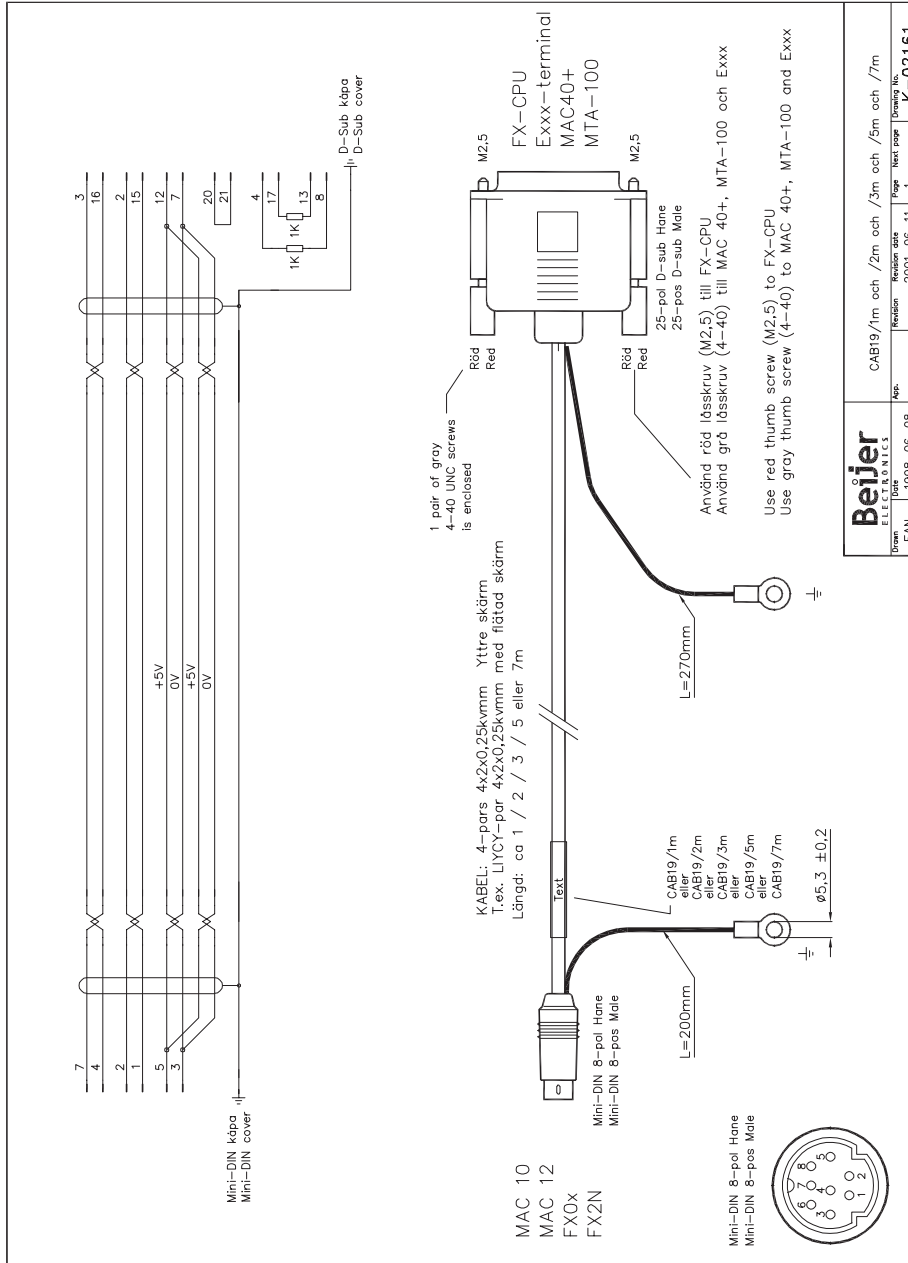

Adaptor cable

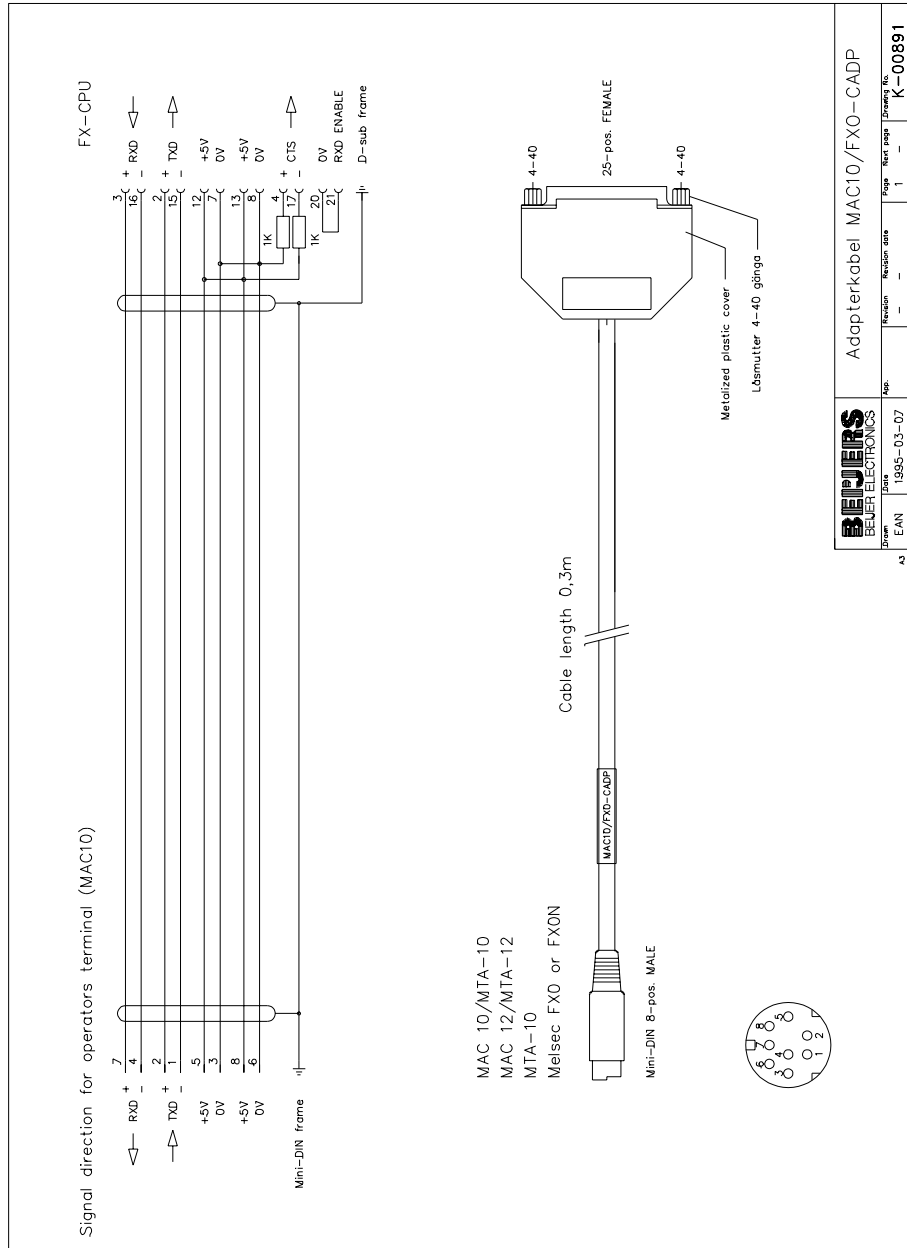

MAC-PRINT-CAB

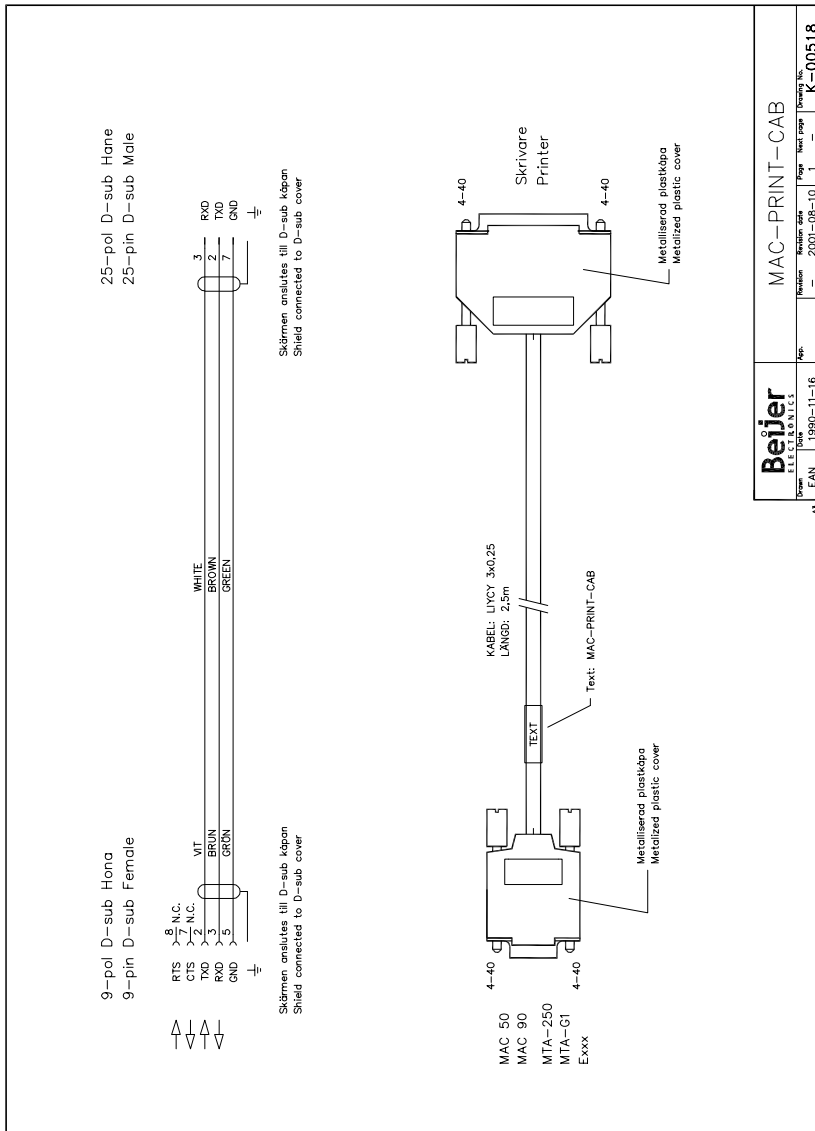

Beijer		MAC-PRINT-CAB	
Över	11	1990-11-16	Ap
År	EAN	Revision	Revision
2001-08-10	1	2001-08-10	1
Page	Next page	Drawing No.	K-00518

E-C24-422-CAB

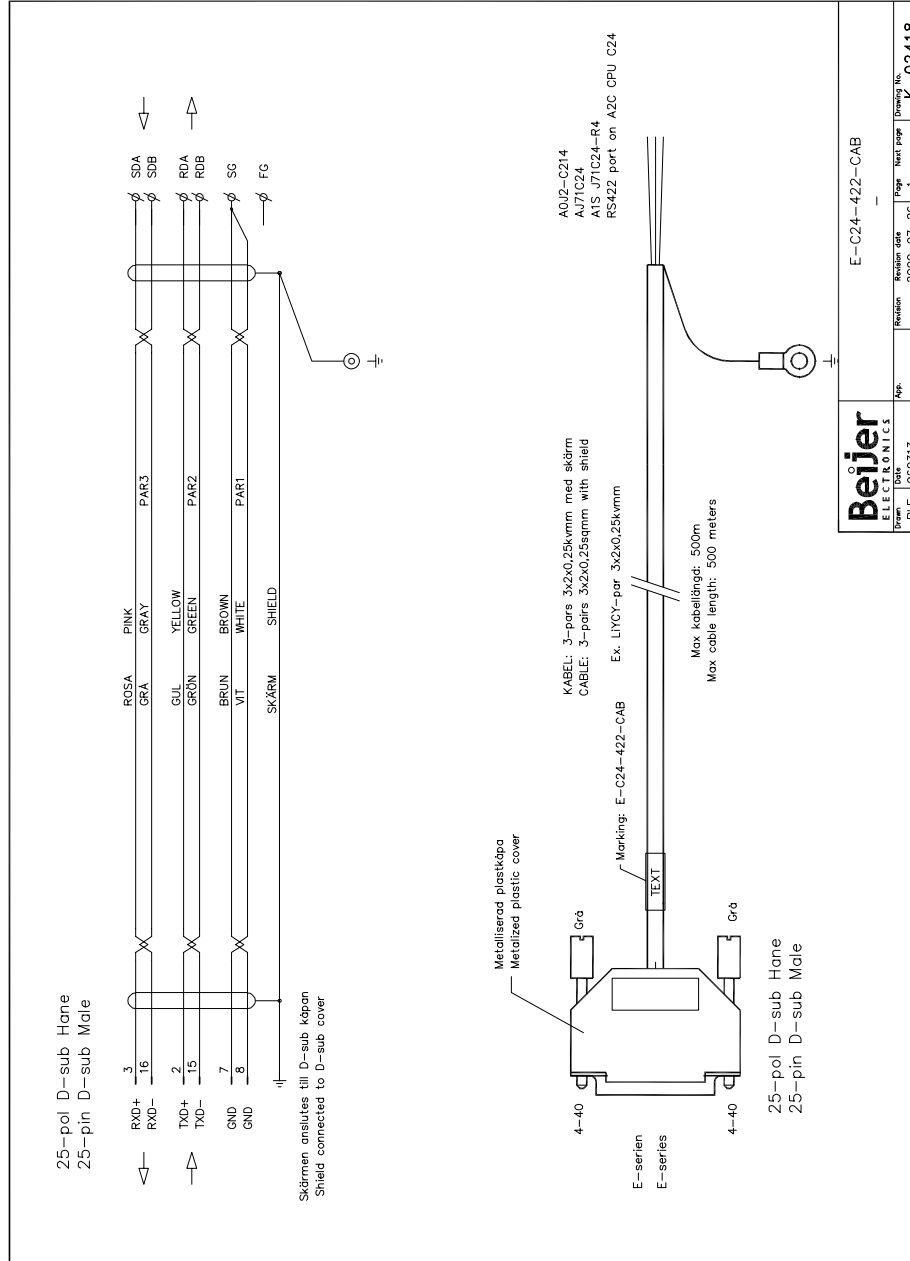

E-C24-232-CAB

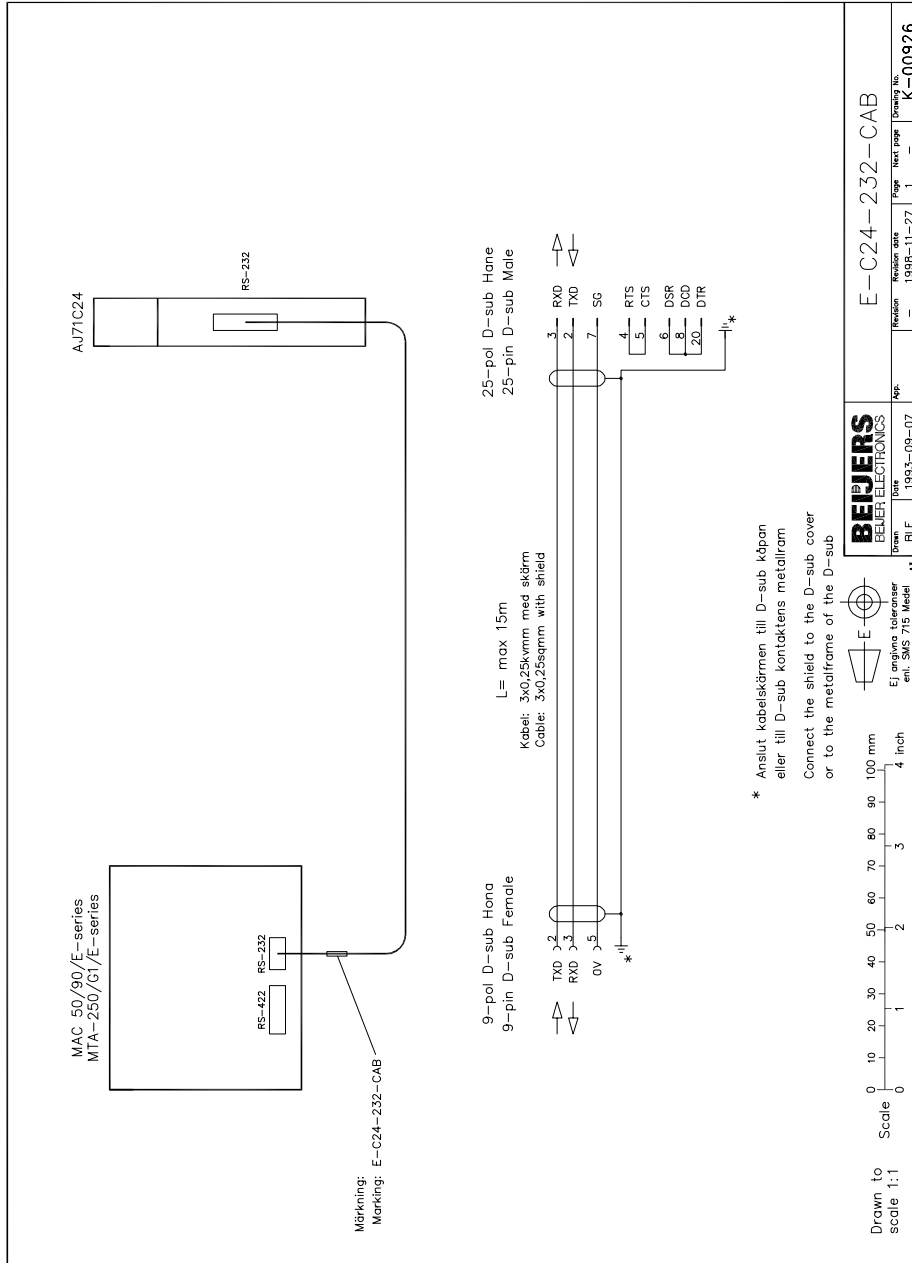

Transparent mode

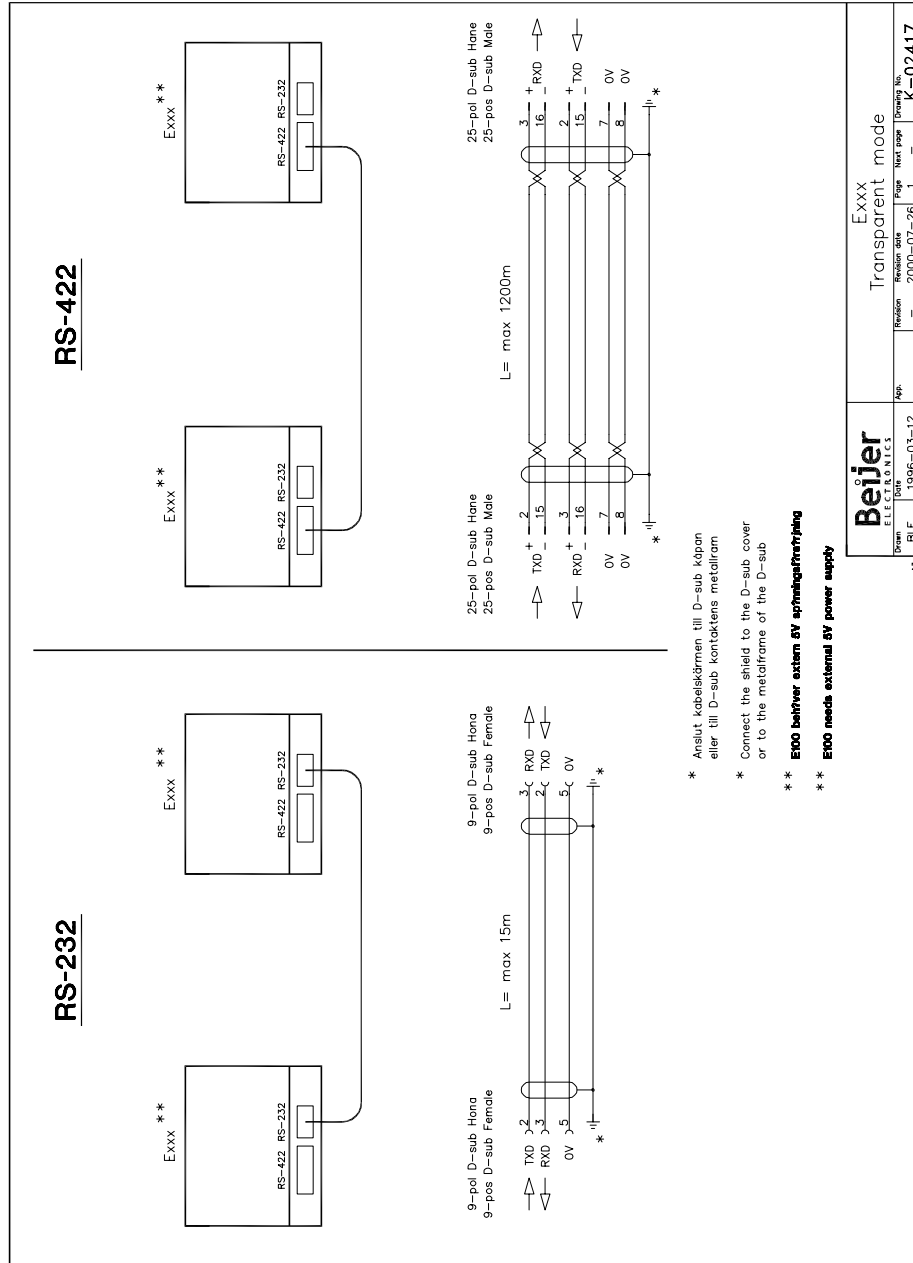

Beijer E L E C T R O N I C S		Exxx Transparent mode	
Drawn	Rev. date	Page	Next page
A3 BLE	1996-03-12	1	K-02417
App.	Revision	Revision date	Drawing No.
		2000-07-26	

CR01, MELSEC FX/A/QnA CPU to 5 V DC E-terminal

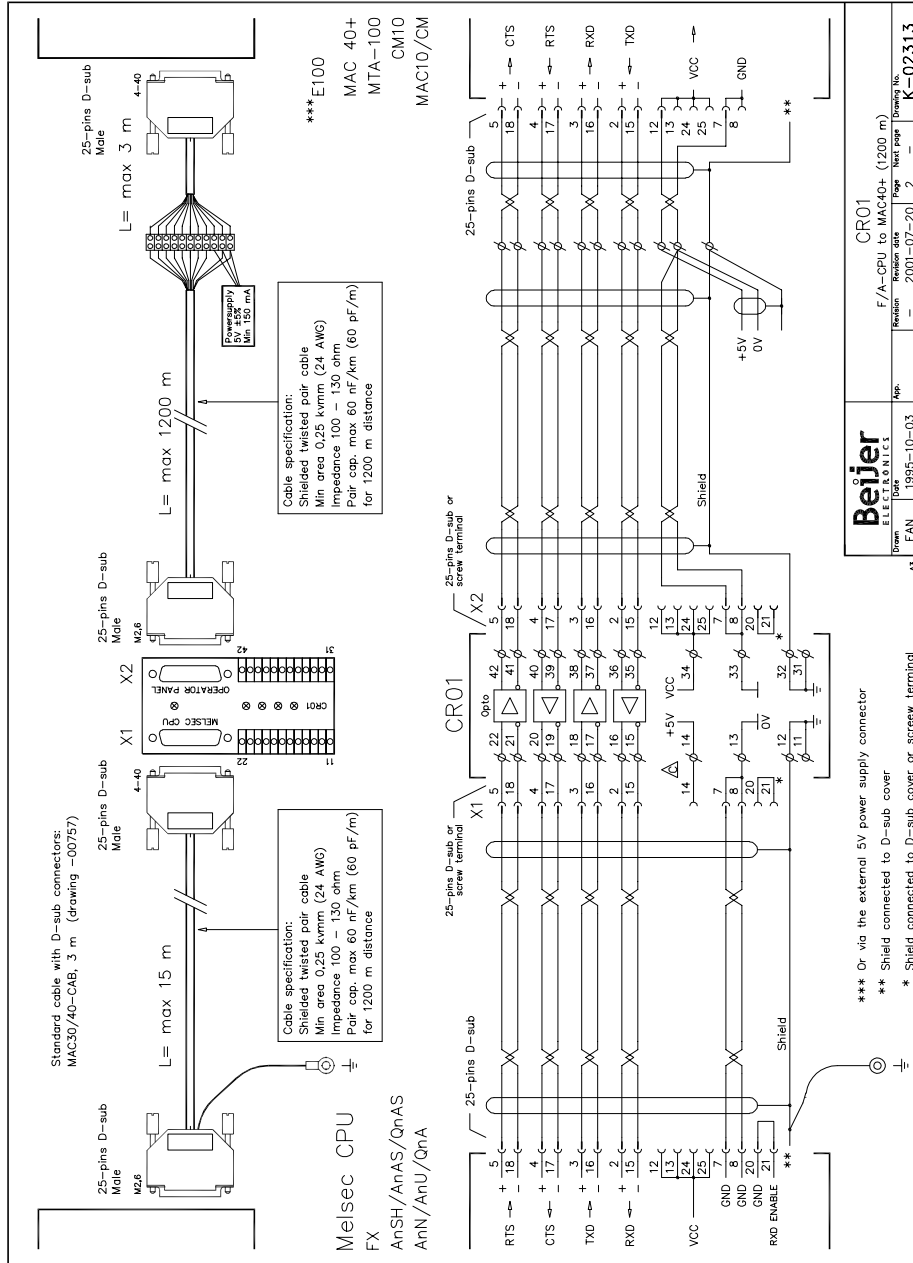

CR01, MELSEC FX0/FX1/FX2N CPU to 5 V DC E-terminal

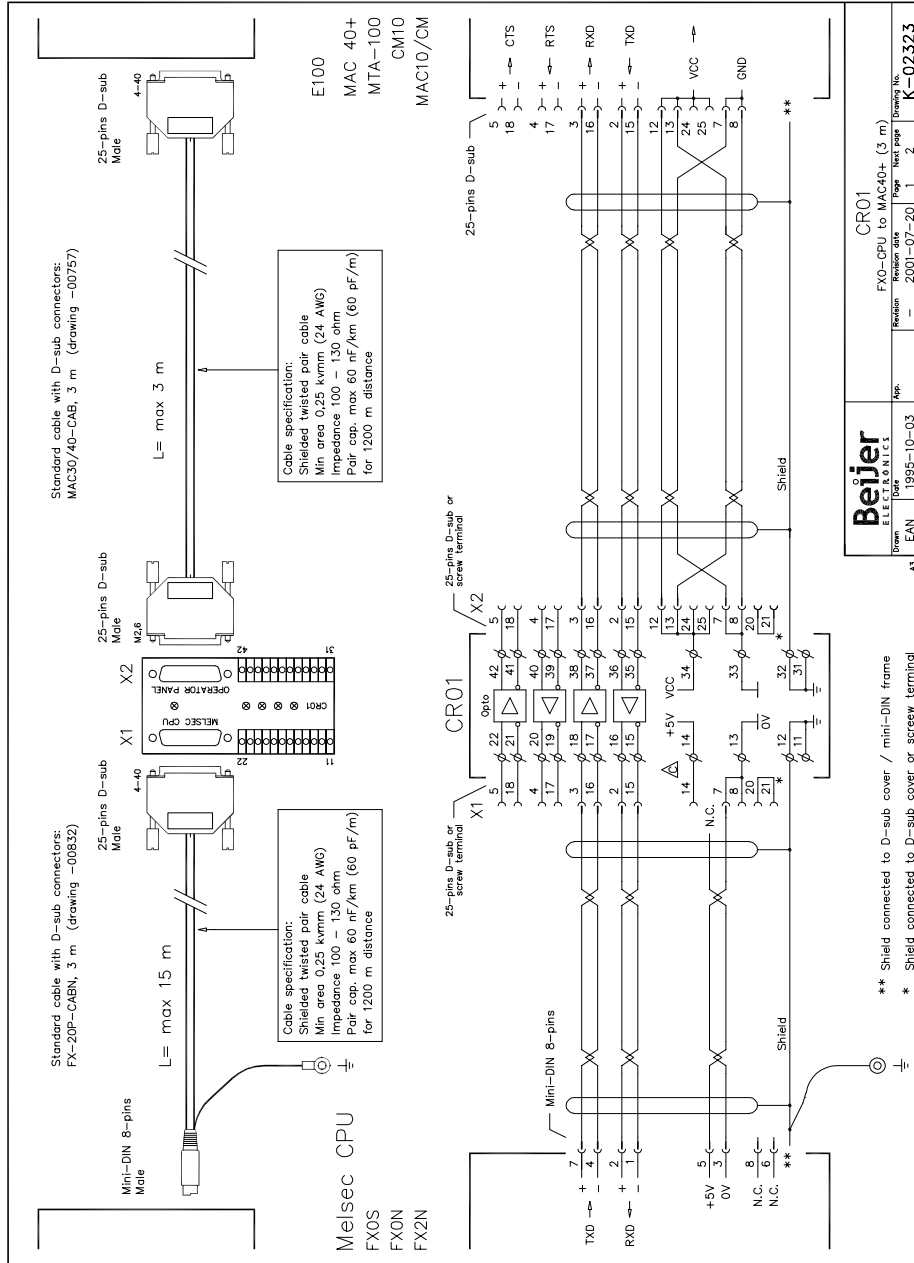

Beijer		CR01	
Drawn	Date	FX0-CPU to MAC40+ (3 m)	Revision No.
EAN	1995-10-03	2001-07-20	K-02323
As	App.	Page	Next page
		1	2

CR01, MELSEC FX0/FX1/FX2N CPU to 5 V DC E-terminal

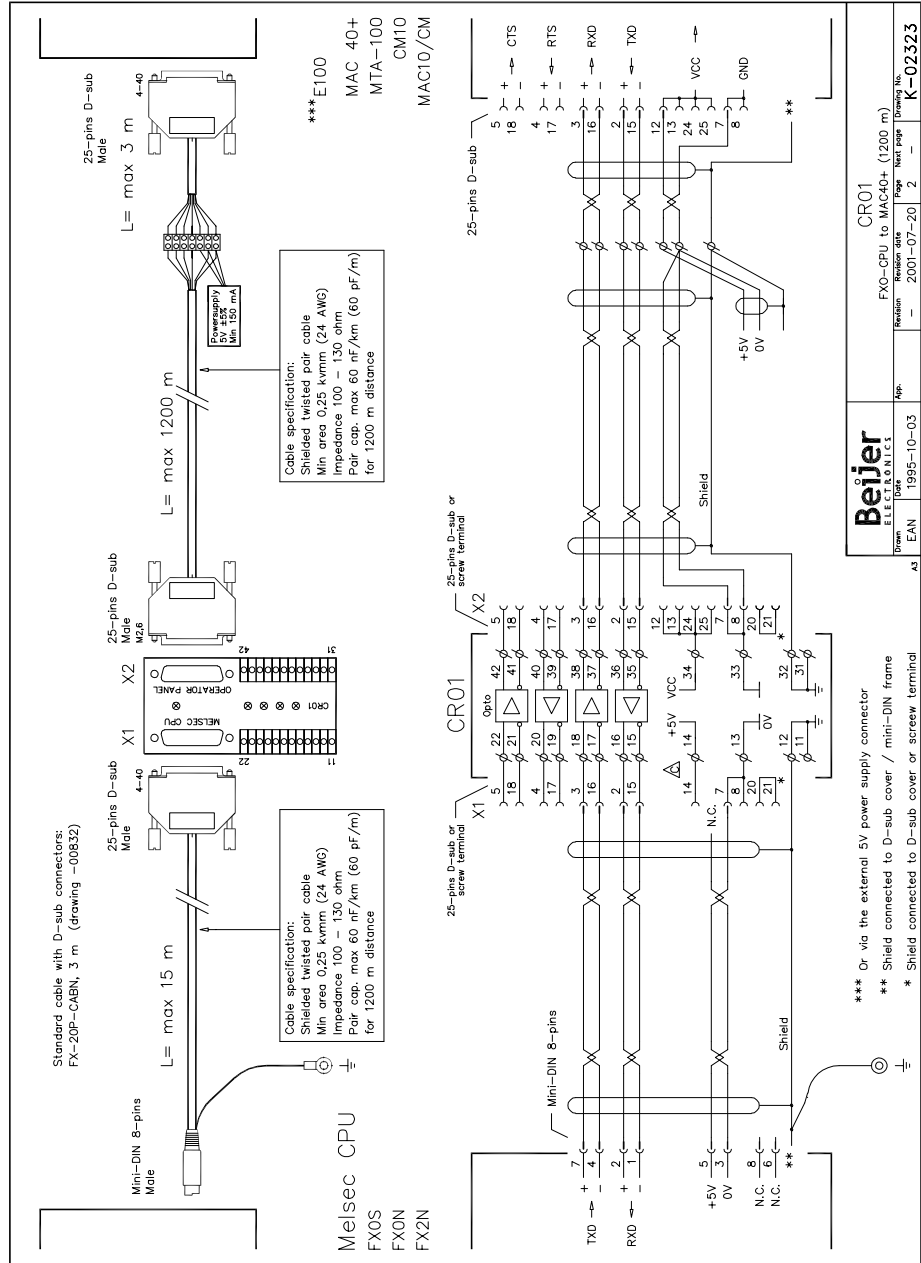

CR01, MELSEC C24 module to E-series

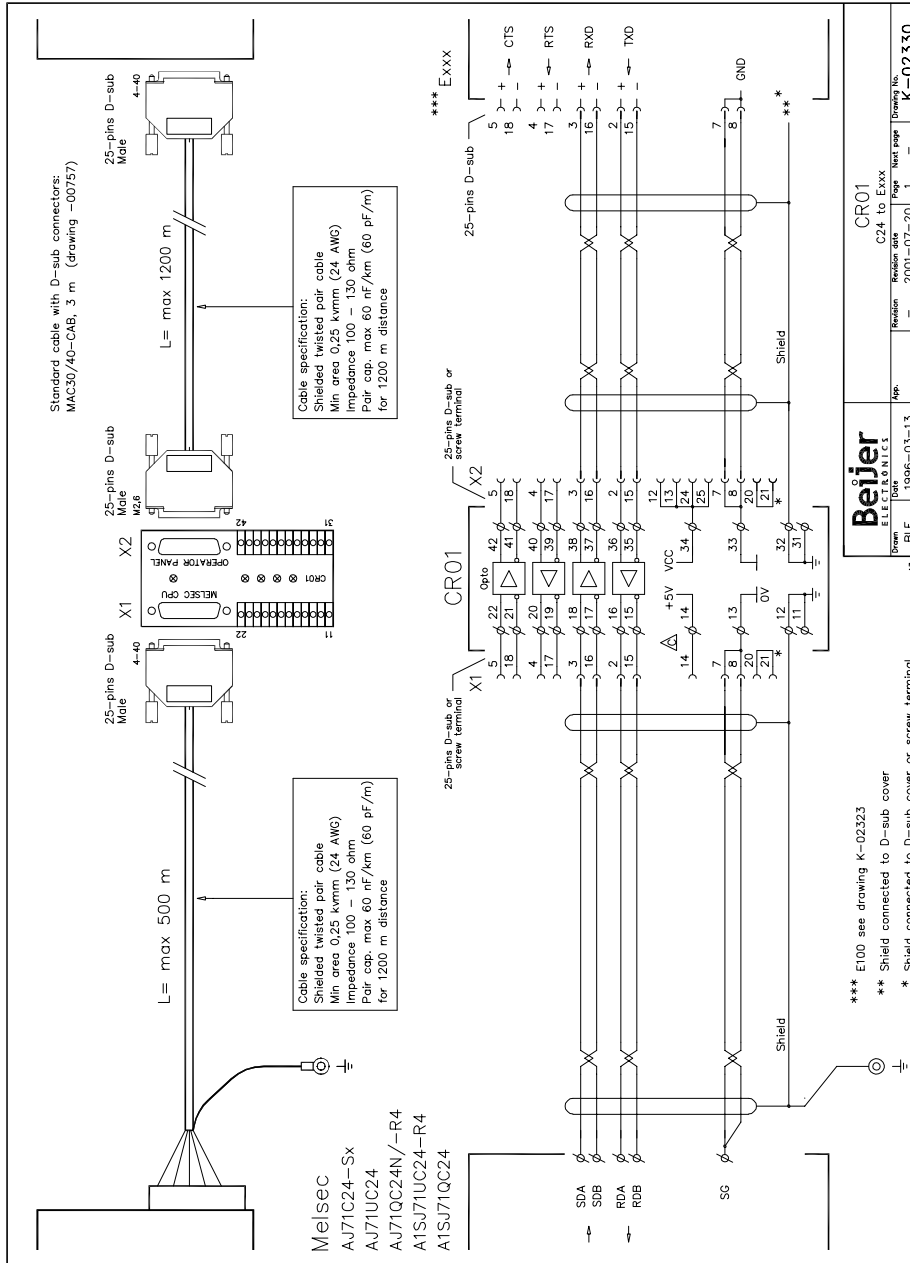

CR01, MELSEC C24 module to 5 V DC E-terminal

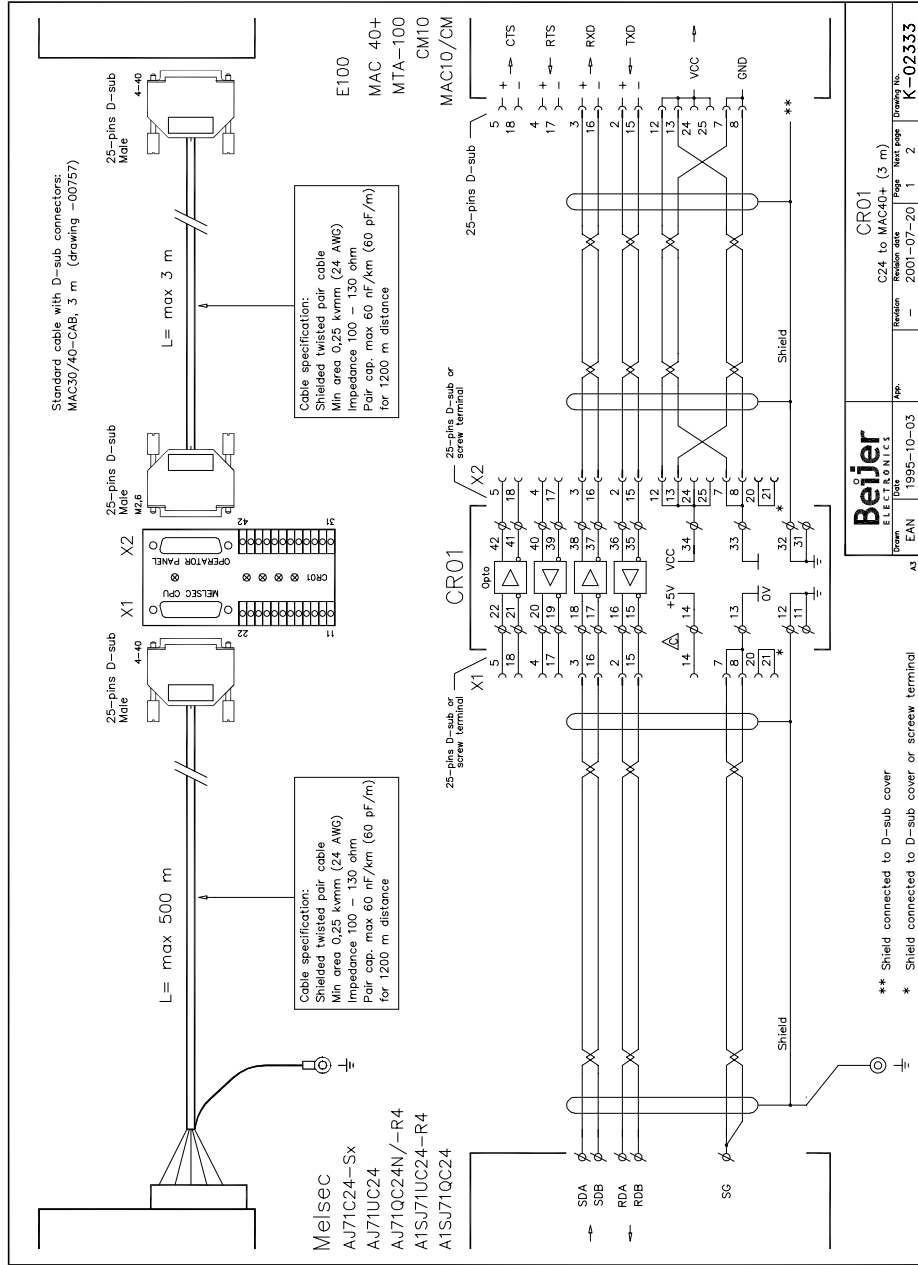

Drawn	Checked	Appr.	Revision	Revision date	Page	Next page	Drawing No.
EAN	EAN	EAN	1	2001-07-20	1	2	K-02333

Beijer
ELECTRONICS

CR01
C24 to MAC40+ (3 m)

CR01, MELSEC C24 module to 5 V DC E-terminal

