

# SHIMANO STEPS

*Shimano Total Electric Power System*

---

**User's manual**

**E6000 Series**

**Original instructions**



# CONTENTS

<b>IMPORTANT NOTICE</b> .....	<b>2</b>
<b>Important safety information</b> .....	<b>2</b>
<b>To ensure safety</b> .....	<b>2</b>
<b>Features of SHIMANO STEPS</b> .....	<b>5</b>
Features .....	5
Riding the bicycle.....	5
Assist mode .....	6
<b>Names of parts</b> .....	<b>7</b>
<b>Specifications</b> .....	<b>8</b>
<b>Method of use</b> .....	<b>8</b>
INTRODUCTION.....	8
Charging the battery .....	8
About battery and charger displays .....	11
Handling and charging the battery.....	12
Installing / removing the battery.....	13
<b>Switching between cycle computer operations and modes</b> .....	<b>15</b>
Installing and removing the cycle computer.....	16
Turning the power ON / OFF .....	17
SHIMANO STEPS logo screen.....	17
Basic screen display .....	18
About the settings menu .....	27
<b>Drive unit setting data backup function</b> .....	<b>35</b>
<b>Connection and communication with the PC</b> .....	<b>35</b>
Downloading application.....	35
<b>Troubleshooting</b> .....	<b>36</b>
Battery level and error indication.....	36
Error messages on the cycle computer .....	37
Troubleshooting.....	39



User's manuals in other languages are available at :

<http://si.shimano.com>

## IMPORTANT NOTICE

- Contact the place of purchase or a bicycle dealer for information on installation and adjustment of the products which are not found in the user's manual. A dealer's manual for professional and experienced bicycle mechanics is available on our website (<http://si.shimano.com>).
- Do not disassemble or alter this product.
- Use the product according to local laws and regulations.

**For safety, be sure to read this user's manual thoroughly before use, and follow them for correct use.**

## Important safety information

Guidelines that require replacement, contact the place of purchase or a bicycle dealer.

**Be sure to observe the following in order to avoid burns or other injury from fluid leakages, overheating, fire or explosions.**

## To ensure safety



### Handling the battery

- Do not deform, modify, disassemble or apply solder directly to the battery. Doing so may cause leakage, overheating, bursting, or ignition of the battery.
- Do not leave the battery near sources of heat such as heaters. Do not heat the battery or throw it into a fire. Doing so may cause bursting or ignition of the battery.
- Do not subject the battery to strong shocks or throw it. If this is not observed, overheating, bursting, or fire may occur.
- Do not place the battery into fresh water or sea water, and do not allow the battery terminals to get wet. Doing so may cause overheating, bursting, or ignition of the battery.
- Use the battery and charger combination specified by the company for charging and follow the charging conditions specified by the company. Not doing so may cause overheating, bursting, or ignition of the battery.



### To ensure safe riding

- Do not give too much of your attention to the cycle computer display while riding, otherwise accidents may result.
- Check that the wheels are securely installed to the bicycle before commencing riding. If the wheels are not securely installed, the bicycle may fall over and serious injury may result.
- If riding a power-assisted bicycle, make sure that you are fully familiar with the starting-off characteristics of the bicycle before riding it on roads with several vehicle lanes and pedestrian footpaths. If the bicycle starts off suddenly, accidents may result.
- Check that the bicycle lights illuminate before riding at night.

### Using the product safely

- Be sure to remove the battery and charging cable before wiring or attaching parts to the bicycle. Otherwise, an electric shock may result.
- When charging the battery while it is installed on the bicycle, do not move the bicycle. The power plug for the battery charger may come loose and not be fully inserted into the electrical outlet, resulting in risk of fire.
- When installing this product, be sure to follow the instructions given in the user's manual. Furthermore, it is recommended that you use only genuine Shimano parts at these times. If bolts and nuts are left loosened or the product is damaged, the bicycle may suddenly fall over and serious injury may result.
- Do not disassemble the product. Disassembling it may cause injury to persons.
- After reading the user's manual carefully, keep it in a safe place for later reference.

## Handling the battery

- If any liquid leaking from the battery gets into your eyes, immediately wash the affected area thoroughly with clean water such as tap water without rubbing your eyes, and seek medical advice immediately. If this is not done, the battery liquid may damage your eyes.
- Do not recharge the battery in places with high humidity or outdoors. Doing so may result in electric shock.
- Do not insert or remove the plug while it is wet. If this is not observed, electric shocks may result. If there is water leaking out of the plug, dry it thoroughly before inserting it.
- If the battery does not become fully charged after 6 hours of charging, immediately unplug the battery from the outlet to stop charging, and contact the place of purchase. Doing so may cause overheating, bursting, or ignition of the battery.
- Do not use the battery if it has any noticeable scratches or other external damage. Doing so may cause bursting, overheating or problems with operation.
- The operating temperature ranges for the battery are given below. Do not use the battery in temperatures outside these ranges. If the battery is used or stored in temperatures outside these ranges, fire, injury or problems with operation may occur.
  1. During discharge: -10 °C - 50 °C
  2. During charging: 0 °C - 40 °C

## Cleaning

- The frequency of maintenance will vary depending on the riding conditions. Periodically clean the chain using an appropriate chain cleaner. Do not use alkaline or acidic cleaning agents for removing rust under any circumstances. If such cleaning agents are used, they may damage the chain and serious injury may result.



## To ensure safe riding

- Observe the instructions in the user's manual for the bicycle, in order to ride safely.

## Using the product safely

- Periodically check the battery charger and adapter, particularly the cord, plug, and case, for any damage. If the charger or adapter is broken, do not use it until it has been repaired.
- This appliance is not intended for use by persons (including children) with reduced physical, sensory or mental capabilities, or lack of experience and knowledge, unless they have been given supervision or instruction concerning use of the appliance by a person responsible for their safety.
- Do not allow children to play near the product.

## Handling the battery

- Do not leave the battery in a place exposed to direct sunlight, inside a vehicle on a hot day, or other hot places. This may result in battery leakage.
- If any leaked fluid gets on your skin or clothes, wash it off immediately with clean water. The leaked fluid may damage your skin.
- Store the battery in a safe place out of the reach of infants and pets.

## Cleaning

- If any malfunctions or other problems occur, contact the place of purchase.
- Never attempt to modify the system yourself, as it may cause problems with system operation.

## Note

## Using the product safely

- Be sure to install caps to any connectors which are not being used.
- For installation and adjustment of the product, consult a dealer.
- The Product is designed to be fully waterproof to withstand wet weather riding conditions. However, do not deliberately place them into water.
- Do not clean the bicycle in a high-pressure wash. If water gets into any of the components, operating problems or rusting may result.
- Do not turn the bicycle upside down. The cycle computer or the shifting switch may get damaged.
- Handle the product carefully, and avoid subjecting it to any strong shocks.
- Although the bicycle still functions as a normal bicycle even when the battery is removed, the light does not turn on if it is connected to the electric power system. Be aware that using the bicycle under these conditions will be considered non-observance of the road traffic laws in Germany.
- When charging the battery while it is mounted on the bicycle, be careful of the following:
  - When charging, make sure there is no water on the battery mount charger outlet or the charger plug.
  - Ensure that the battery is locked into the battery mount before charging.
  - Do not remove the battery from the battery mount while charging.
  - Do not ride with the charger mounted.
  - Always place the cover over the battery mount charger socket when not charging.

## Handling the battery

- When you carry a power-assisted bicycle in a car, remove the battery from the bicycle and place the bicycle on a stable surface in the car.
- When attaching the battery, check that no water has accumulated on the connector to the battery, then connect it.

### Disposal information for countries outside the European Union



This symbol is only valid within the European Union. Follow local regulations when disposing of used batteries. If you are not sure, consult the place of purchase or a bicycle dealer.

## Cleaning

- The number found on the battery mount key is necessary when purchasing spare keys. Keep it in a safe place.
- Contact the place of purchase for updates of the product software. The most up-to-date information is available on the Shimano website. For details, refer to the "Connection and communication with the PC" section.
- Do not use thinner or other solvents to clean any of the products. As such substances may damage the surfaces.
- You should periodically wash the chainrings in a neutral detergent. In addition, cleaning the chain with neutral detergent and lubricating it can be an effective way of extending the useful life of the chainrings and the chain.
- Use a damp cloth, with the water well wrung out, when cleaning the battery and plastic cover.
- For any questions regarding handling and maintenance, contact the place of purchase.
- Products are not guaranteed against natural wear and deterioration from normal use and aging.
- For maximum performance we highly recommend Shimano lubricants and maintenance products.

## Assist

- If the settings are not correct, for instance if the chain tension is too tight, the proper assist force may not be obtained. If this happens, contact the place of purchase.

### <DU-E6010>

- This component is compatible with coaster brakes. If the crank is not installed in the correct position or the chain tension has not been correctly adjusted, contact the place of purchase, as there may not be proper assistance power.

## Label

- Some of the important information contained in this user's manual is also indicated on the battery charger label.

### ■ Features

- **Lightweight, compact design**

- **Silent, smooth ride**

- **High shifting performance system (In the case of electronic gear shifting)**

This system uses accurate sensors to enable shifting gears by providing the most appropriate level of power assistance carefully adjusted by computer controls.

- **Full Automatic Shifting (In the case of electronic 8-speed gear shifting)**

The sensors detect riding conditions, whether you are riding up a hill against the wind, or on flat ground with no wind; the automatic gear shifting system uses computer controls to make your ride more pleasant.

- **Start mode (In the case of electronic gear shifting)**

This function allows automatic shifting down to a preset gear when you stop the bicycle such as at traffic lights so that you can start traveling at a light gear.

\* If, while the bicycle is stopped, you shift to a gear lower than the set gear, the system will not automatically shift up.

- **Coaster break compatible (DU-E6010)**

Smoothly provides sufficient control power.

- **Light off road**

Sporty, provides powerful assistance. Can only be used when set by the manufacturer of the completed bicycle.

- **Walk assistance function (Walk assist mode)**

\* Some of the functions listed above can only be used once the firmware has been updated. If this is the case, consult the place of purchase, and carry out the firmware updates.

### ■ Riding the bicycle

#### 1. Turn on the power.

- Power cannot be turned on while charging.

#### 2. Select your preferred assist mode.



#### 3. Assistance will start when the pedals start turning.

#### 4. Change the assist mode in accordance with the riding conditions.

#### 5. Turn the power off when parking the bicycle.

## ■ Assist mode

You can select a SHIMANO STEPS assist mode for each particular application.

HIGH	NORMAL	ECO
		
<p>Use when powerful assistance is required, such as when riding up steep uphill slopes.</p>	<p>Use when an intermediate level of assistance is needed, such as when you want to enjoy riding comfortably on a gentle slope or level ground.</p>	<p>Use when you want to enjoy long distance riding on level ground. When pedaling is not very strong, the amount of assistance is reduced and energy consumption is lessened.</p>
<p>When the battery level is running low, the level of assistance is lowered to increase the traveling range.</p>		
<p><b>OFF</b></p>		
<p>This mode does not provide power assistance when the power is turned on. Since there is no power consumption associated with the power assistance, it is useful for reducing battery consumption when the battery is running low.</p>		
<p><b>WALK</b></p>		
<p>This mode is particularly useful when you walk the bicycle with heavy baggage on it or walk it out of a basement.</p>		



# Names of parts

<BT-E6000>

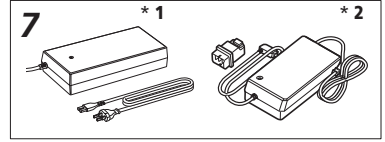
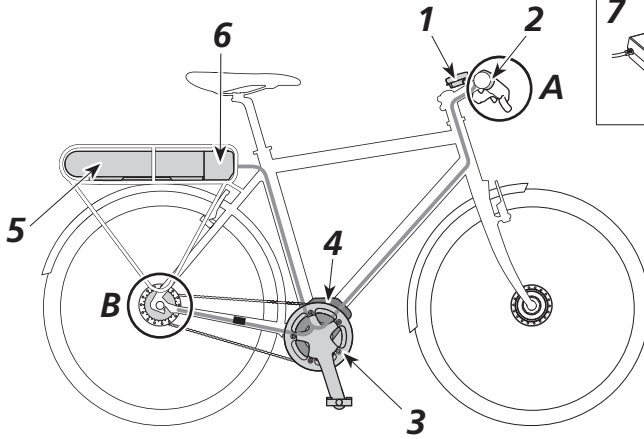

< In the case of electronic gear shifting >

<b>A</b>	Shifting switch	SW-E6000
<b>B</b>	Motor unit	MU-S705
	Internal geared hub	SG-C6060
		SG-S705
	SG-S505	

<BT-E6010>

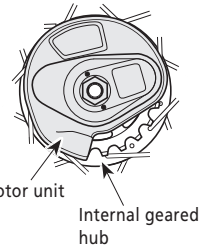
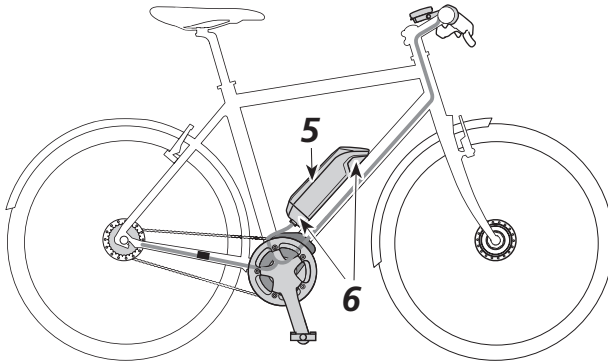

<b>1</b>	Cycle computer	<ul style="list-style-type: none"> <li>• SC-E6000</li> <li>• SC-E6010</li> </ul>	<b>5</b>	Battery	<ul style="list-style-type: none"> <li>• BT-E6000</li> <li>• BT-E6010</li> </ul>
<b>2</b>	Assist switch	<ul style="list-style-type: none"> <li>• SW-E6000</li> </ul>	<b>6</b>	Battery mount	<ul style="list-style-type: none"> <li>• SM-BME60</li> <li>• SM-BME61</li> <li>• BM-E6000</li> <li>• BM-E6010</li> </ul>
<b>3</b>	Front gear / Crank arm	<ul style="list-style-type: none"> <li>• FC-E6000</li> <li>• SM-CRE60</li> </ul>	<b>7</b>	Battery charger * 1: SM-BCE60+SM-BCC1 * 2: EC-E6000	
<b>4</b>	Drive unit / Speed sensor	<ul style="list-style-type: none"> <li>• DU-E6000</li> <li>• DU-E6001</li> <li>• DU-E6050</li> <li>• DU-E6010</li> </ul>			

## Specifications

Operating temperature range: During discharge	-10 – 50°C	Battery type	Lithium ion battery
Operating temperature range: During charging	0 – 40°C	Nominal capacity	11.6 Ah
Storage temperature	-20 – 70°C	Rated voltage	36 V DC
Storage temperature (Battery)	-20 – 60°C	Drive unit type	Midship
Charging voltage	100 – 240 V AC	Motor type	Brush-less DC
Charging time	< SM-BCE60 > About 4 hours < EC-E6000 > 100% charged: About 4 hours 80% charged: About 2 hours	Rated drive unit power	250 W

\* The range of the assist function speed is different depending on the specifications.

DU-E6000, E6001, E6010: 25km/h or less

DU-E6050: 20mile/h or less

## Method of use

### ■ INTRODUCTION

You cannot use the battery immediately after shipment.

The battery can be used after charging it with the designated charger.

Be sure to charge it before use. The battery can be used when the LED on it lights up.

### ■ Charging the battery

#### DANGER

- Use the battery and charger combination specified by the company for charging and follow the charging conditions specified by the company. Not doing so may cause overheating, bursting, or ignition of the battery.

#### CAUTION

- When removing the battery charger power plug from the outlet or the charging plug from the battery, do not pull it out by the cord.
- When charging the battery while it is mounted on the bicycle, be careful not to trip over the charger cord or get anything caught on it. This may lead to injury or cause the bicycle to fall over, damaging the components.



If the bicycle is stored for an extended period of time immediately after purchase, you will need to charge the battery before using the bicycle. Once the battery is charged, it starts to deteriorate.

**When charging the battery alone**

< EC-E6000 >

- 1.** Attach the adapter to the charging plug.
  - 2.** Plug the charger's power plug into the outlet.
  - 3.** Plug the adapter into the battery's charger connector.
- \* When inserting the adapter into the charger connector, hold the charging plug so it is facing down toward the adapter. Do not insert the charging plug upward into the adapter.
- \* Charge the batteries on a flat surface indoors.

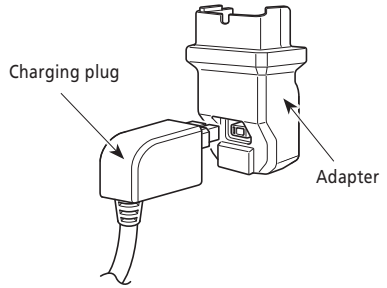

< BT-E6000 >

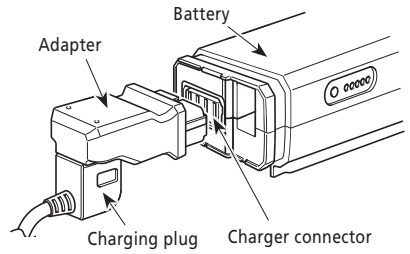

< BT-E6010 >

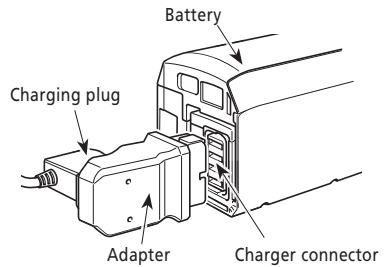

< SM-BCE60 >

1. Attach the charger plug to the charger connector of the battery.  
Insert it with the groove side of the connector facing up.

- \* You cannot insert it with the groove side facing down.
- \* Charge the batteries on a flat surface indoors.

< BT-E6000 >

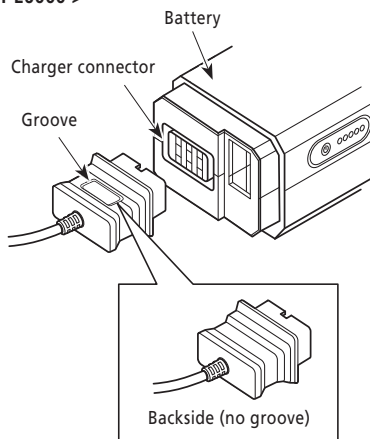

< BT-E6010 >

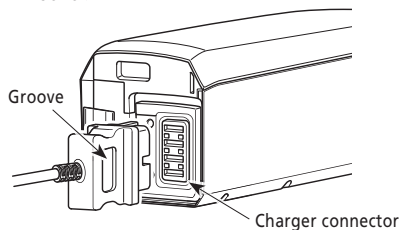

## Charging the battery while installed onto the bicycle

< EC-E6000 >

1. Insert the battery charger power plug into the outlet.
2. Insert the charging plug into the battery mount charger connector.

\* Place the battery charger main body on a steady surface such as the floor before charging.

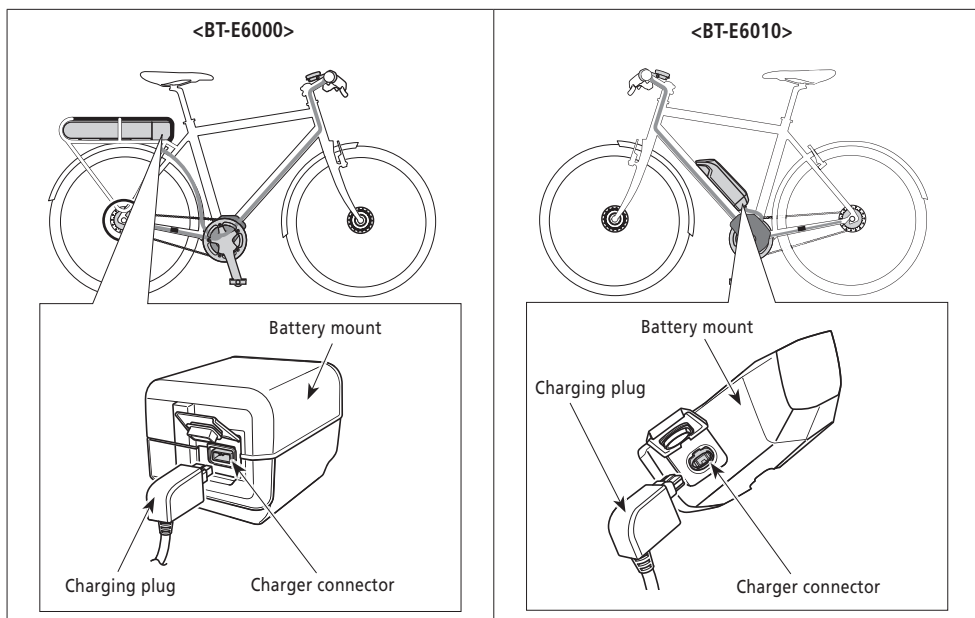

## ■ About battery and charger displays





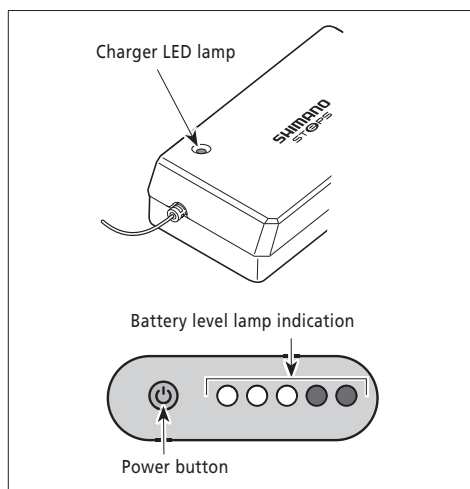

After charging has started, the LED lamp on the charger lights up.

You can check the current charging status on the battery level lamp located on the battery.

● Lights up	Charging (Within 1 hour after the completion of charging)
● (flashing) Flashing	Charging error
● (off) Turned off	Battery disconnected (1 hour or more after the completion of charging)









## Charging-in-progress indication

Battery level indicator*1	Battery level
	0% - 20%
	21% - 40%
	41% - 60%
	61% - 80%
	81% - 99%
	100%

\*1 ● : No light ○ : Lights up  : Flashing

## Battery level indication

The current remaining battery level can be checked by pressing the power button on the battery. The current battery level will not be displayed if the battery is installed onto the bicycle.

Battery level indicator*1	Battery level
	100% - 81%
	80% - 61%
	60% - 41%
	40% - 21%
	20% - 1%
	0%
	Power off / Shutdown

\*1 ● : No light ○ : Lights up  : Flashing

## ■ Handling and charging the battery

Charging can be carried out at any time regardless of the amount of charge remaining, but you should fully charge the battery at the following times. Be sure to use the special charger when recharging the battery at these times.

- The battery is not fully charged at the time of purchase. Before riding, be sure to charge the battery until it is fully charged.
- If you will not use the bicycle for an extended period of time, charge the battery before storing the bicycle.

If the battery has become fully spent, charge it as soon as possible. If you leave the battery without charging it, it will cause the battery to deteriorate.

- If you will not ride the bicycle for an extended period of time, charge the battery periodically. Do not let the battery discharge completely.

## ■ Installing / removing the battery

### How to use the key

The following description may not be applicable as different types of keys are available.

1. Insert the key into the key cylinder in the battery holder.



- The position of the key does not affect the insertion of the battery. You can insert it regardless of the key position.
- You cannot remove the key when it is not in the inserting position.

<BT-E6000>

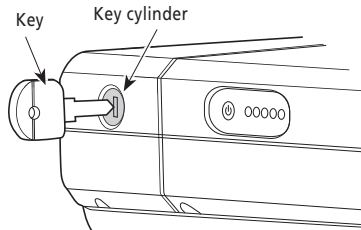

<BT-E6010>

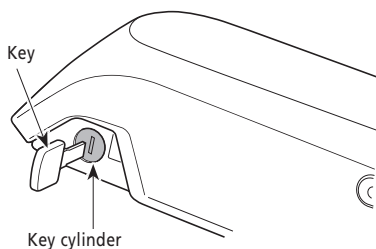

2. To unlock the battery turn the key to the left until you feel some resistance.

#### CAUTION

To prevent the battery from dropping off, do not ride the bicycle with the key inserted.

<BT-E6000>

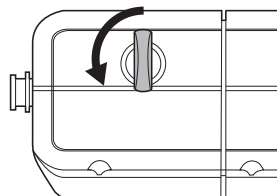

<BT-E6010>

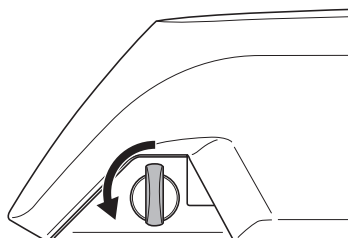

## Removing the battery

### <BT-E6000>

Turn off the power, then turn the key to the unlocking position, and pull out the battery.



You can remove the battery only when the key is in the unlocking position.

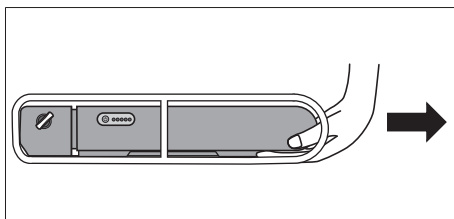

### <BT-E6010>

Turn off the battery then turn the key to the unlocking position. Hold the upper part of the battery and slide it to the left to remove it.

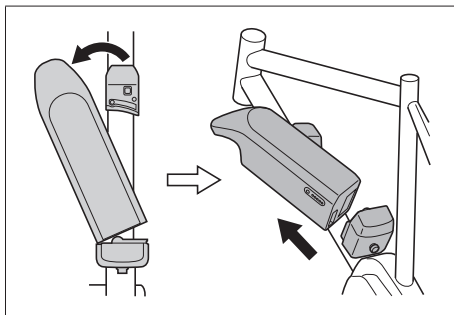

## Installation of the battery

### <BT-E6000>

1. Set the battery on the holder rail from behind and slide it forward. Push it in firmly.
2. Return the key to the locking position, remove it, and store it in a safe place.

### CAUTION

Check that the battery is locked before riding the bicycle. The battery may come loose and fall out if not properly locked in place before riding.

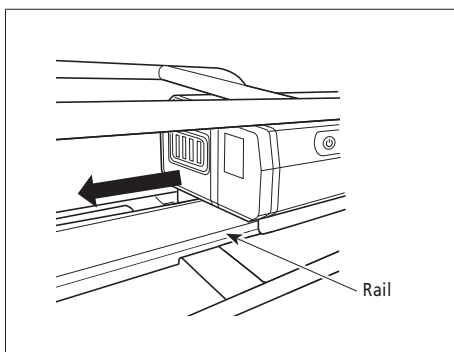



<BT-E6010>

1. Align the indentation in the bottom of the battery with the protrusion on the holder and insert the battery.

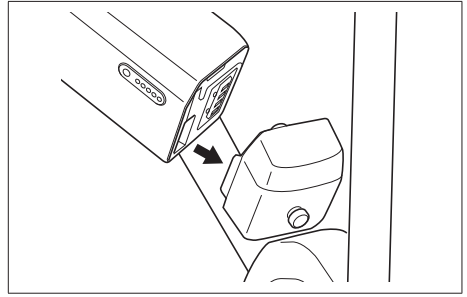

2. Slide the battery to the right starting from the point where it is inserted. Push in the battery until you hear it click.
3. Return the key to the locking position, remove it, and store it in a safe place.

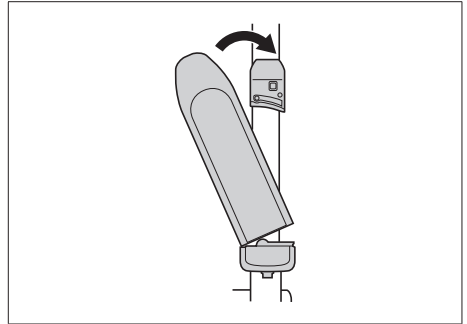

**CAUTION**

Check to see that the battery is locked before riding the bicycle.  
The battery may fall out while riding if not properly locked in place.

**Switching between cycle computer operations and modes**

For cycle computer screen operations and switching modes, use the buttons on the assist switch and shifting switch on the left and right.

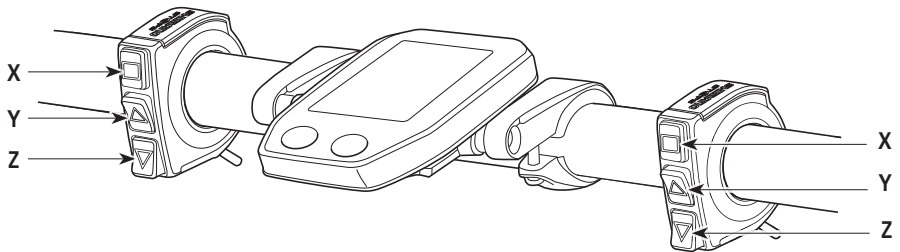

X	<ul style="list-style-type: none"><li>• Changing the cycle computer display</li><li>• Switching between automatic and manual gear shifting</li></ul>
Y	<p><b>When switching assist modes:</b> the level of assistance becomes stronger</p> <p><b>When shifting gears:</b> pedaling becomes heavier</p>
Z	<p><b>When switching assist modes:</b> the level of assistance becomes weaker</p> <p><b>When shifting gears:</b> pedaling becomes lighter</p>

The operation procedure provided here refers to cases where the cycle computer is set to the default values.

## ■ Installing and removing the cycle computer

Slide the cycle computer onto the bracket as shown in the illustration to install it.

Insert the cycle computer securely until it clicks into place.

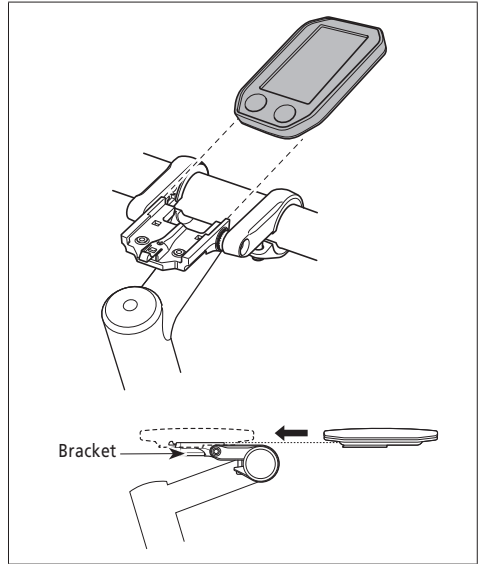

To remove the cycle computer, push the lever of the bracket firmly while sliding out the cycle computer.

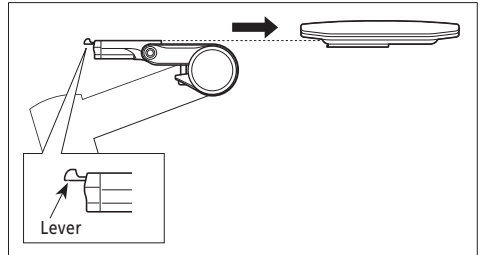

If the cycle computer is not correctly in place, the assist function will not operate normally.

## ■ Turning the power ON / OFF

< SC-E6010 >

Turning the power ON and OFF via the cycle computer

- With the power turned either ON or OFF, hold down the button for 2 seconds.

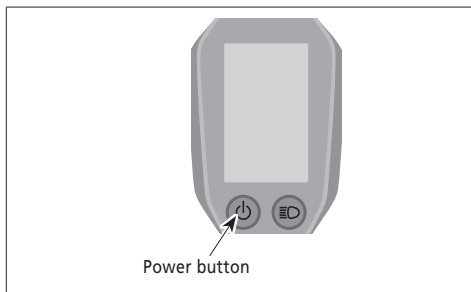

< BT-E6000/BT-E6010 >

Turning the power ON and OFF via the battery

Press the power button once with the power turned ON or OFF. All the indicators turn on when the power is on.

### CAUTION

- When turning on the power, check that the battery is firmly attached to the holder.
- Power cannot be turned on while charging.



When turning the power ON or OFF, do not place your foot on the pedal.

### Automatic power off function

If the bicycle has not moved for over 10 minutes, the power will automatically turn off.

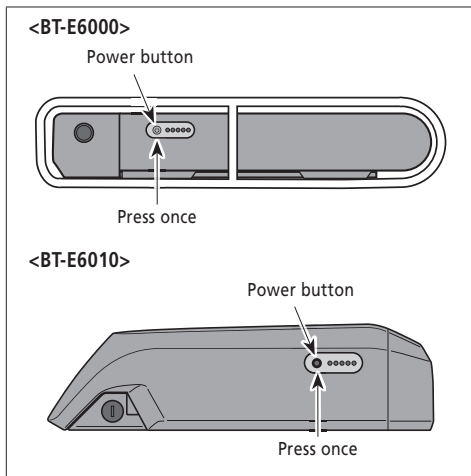

## ■ SHIMANO STEPS logo screen

This screen is displayed during system start up and shutdown.

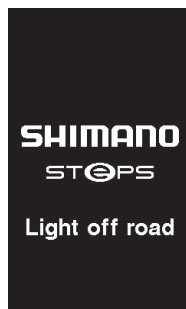

This screen is an example of the SC-E6010 in the Light off road setting.

## ■ Basic screen display

Displays the status of the power assisted bicycle, traveling data.

The number of gears and the shifting mode are only displayed when using electronic gear shifting.

< SC-E6000 >

1. **Current speed**  
Displays the current speed.
2. **Battery charge**  
Displays the current battery level in six levels.
3. **Speed unit display**  
You can switch between km/h and mph.
4. **Changing the assist mode display**  
Display the current assist mode.
5. **Gear position and traveling data display**  
Displays the current gear ratio or traveling data.
6. **Current time**  
Shows the current time.
7. **Gear shifting mode\***  
The current gear shifting mode is displayed as either "A" (automatic), or "M" (manual).

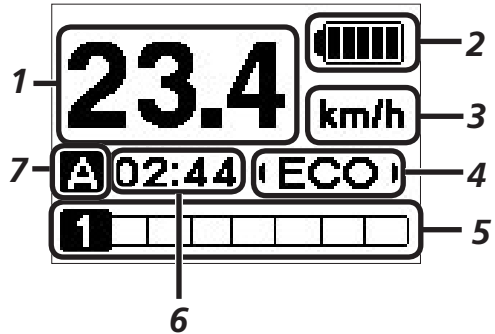

< SC-E6010 >







1. **Current speed**  
Displays the current speed.
2. **Current time**  
Shows the current time.
3. **Icon to indicate when the light is on**  
Notifies you when the battery-powered light is on.
4. **Battery charge**  
The current battery level is displayed as a percentage and with a level indicator.
5. **Speed unit display**  
You can switch between km/h and mph.
6. **Assist gauge**  
Displays assistance level.
7. **Gear position and traveling data display**  
Displays the current gear ratio and traveling data.
8. **Gear shifting mode\***  
The current gear shifting mode is displayed as either "Auto" (automatic), or "Manual" (manual).
9. **Changing the assist mode display**  
Display the current assist mode.







### Battery level indicator

You can check the battery level on the cycle computer while riding.

<SC-E6000>

Display	Battery level
	81 - 100%
	61 - 80%
	41 - 60%
	21 - 40%
	1 - 20%
	0%

<SC-E6010>

Display	Battery level
	100%
	
	0%



### Changing the assist mode display

Display the current assist mode.

Press Assist-Y or Assist-Z on the assist switch to switch assist modes.

Display	Details
HIGH	Assist high
NORM	Assist normal
ECO	Assist eco
OFF	Assist off
WALK	Walk assist

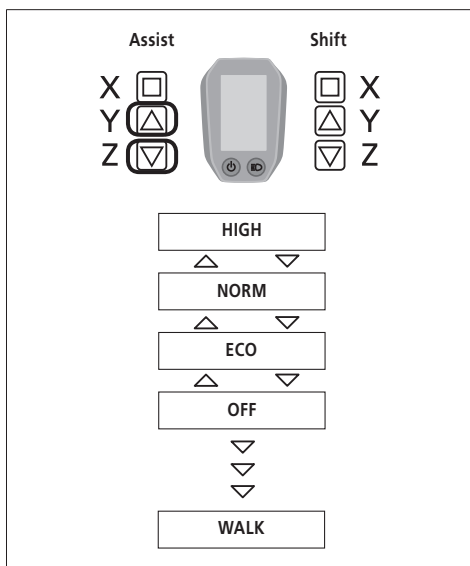

### <Switch to walk assist mode>

1. Press assist-Z to switch the mode to "OFF".
2. Press assist-Z once again 2 seconds until "WALK" is displayed.
3. Press and hold assist-Z to start walk assist.

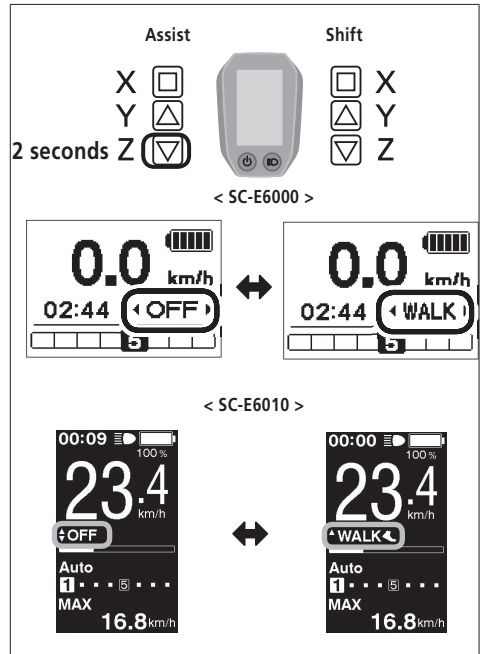

### <Walk assist mode operation>

When "WALK" is displayed, press and hold down Assist-Z on the assist switch to start the walk assist function. Releasing Assist-Z stops the walk assist function, or pressing Assist-Y can stop the walk assist function.

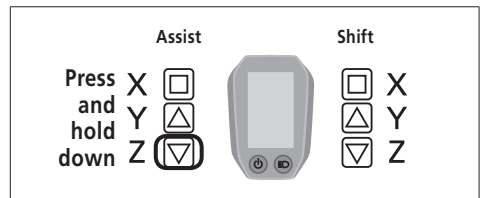

- If Assist-Z is not operated for over 1 minute, the mode will change to OFF.
- If the bicycle does not move after the walk assist function turns on, the function automatically stops. To restart the walk assist function, release the assist switch and press and hold down Assist-Z again.
- The walk assist function can operate at a maximum of 6 km/h.
- The assistance level and speed vary with the gear position.

< SC-E6000 >



< SC-E6010 >



### Gear position and traveling data display

Displays the current gear ratio or traveling data.

The type of traveling data displayed changes each time you tap Assist-X.

Display (SC-E6000)	Display (SC-E6010)	Details
	* 1	Gear position*7 (displayed only when the motor unit is connected)
	* 2	Gear position*6 (when setting start mode)
< DST 109.7 km >		Traveling distance
< ODO 11097 km >		Cumulative distance
< RANGE 107 km >		Traveling range*3 *5
		Traveling range (optional)*4
< TIME 143:29 >		Traveling time (optional)*4
< AVG 16.8 km/h >		Average speed (optional)*4
< MAX 16.8 km/h >		Maximum speed (optional)*4



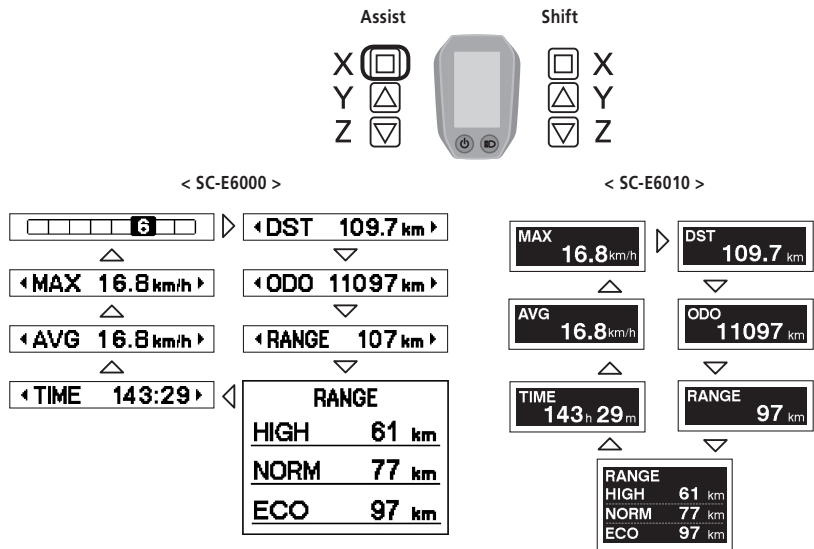

\*3 When "RANGE" is displayed, the battery level and the walk assist indicator do not appear on the screen.

\*4 Optional item: You can configure the display settings in E-tube Project. For details, refer to the "Connection and communication with the PC" section.

\*5 When the walk assist function is working, "-" is displayed in the "RANGE" screen.

\*6 The starting gear position is displayed when using start mode.

\*7 The gear position is only displayed when using electronic gear shifting.

## Turning the battery-powered light ON or OFF

### <SC-E6000>

When the battery-powered light is connected, pressing the Assist-X for 2 seconds displays this information instead of the clock and assist mode. The light turns on and off each time it is displayed. It is displayed for about 2 seconds.

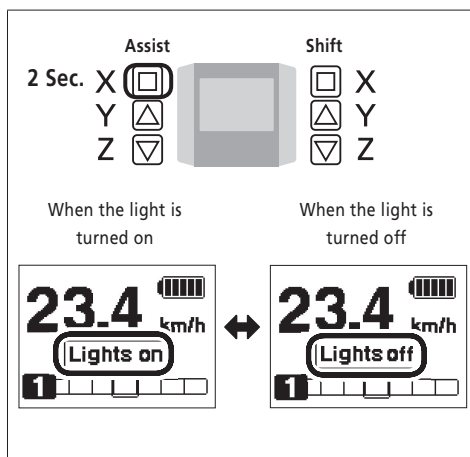

### <SC-E6010>

When the battery-powered light is connected, push the light button on the cycle computer to turn the light on. An icon indicating that the light is on appears on the screen. Push the button again to turn the light off. Once the light is turned off, the icon on the screen disappears.

\* When the battery powered light is not connected and "Backlight" is set to "MANUAL", pressing the light button turns the cycle computer's backlight on and off.

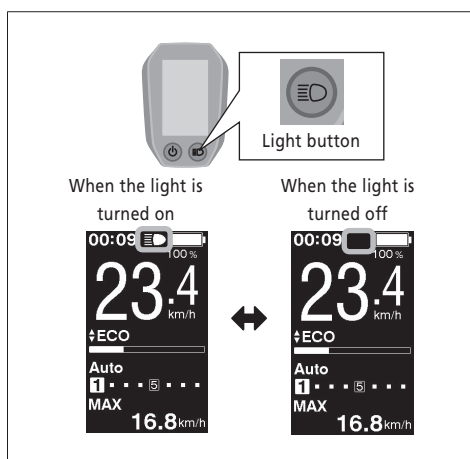

The light turns off in conjunction with the battery power. When the battery power is off, the light is off.

## Switching gear shifting mode

From the basic screen, press Shift-X to switch between automatic and manual gear shifting modes.

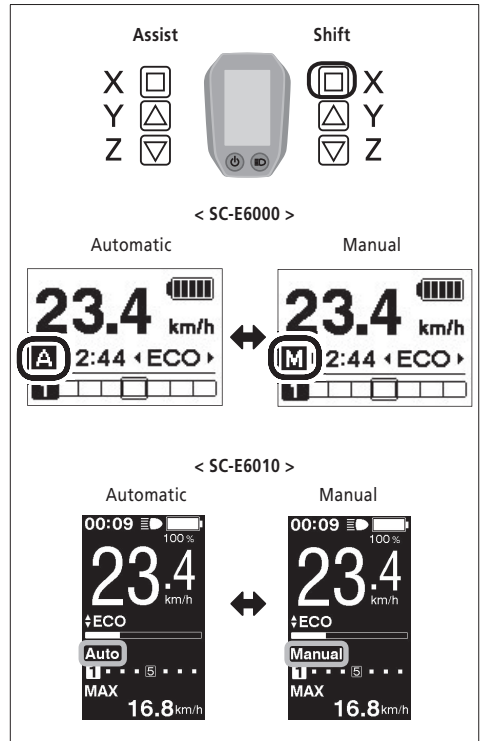

## Clearing the traveling distance

You can clear the traveling distance in the main screen. If the battery-powered light is connected and configured, clear the traveling distance (DST) according to "Clear (Clear settings)" in "About the settings menu".

\* When using the SC-E6000 this function can only be used when the light is not connected.

1. Change the traveling data display to DST and press the Assist-X for 2 seconds.

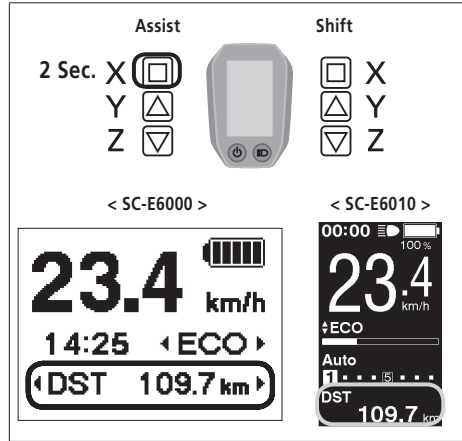

2. Release the finger when the DST indication starts blinking.

In this state, pressing the Assist-X again clears the traveling distance.



- The DST indicator light stops blinking and the screen takes you back to the basic screen after leaving it alone for 5 seconds.
- When the traveling distance is cleared, TIME, AVG, and MAX are also cleared.

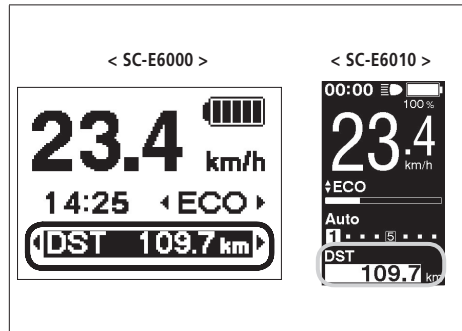

## About the settings menu

### Launching

- With the bicycle stopped, pressing both the Assist-Y and Assist-Z at the same time for 2 seconds displays the setting screen.

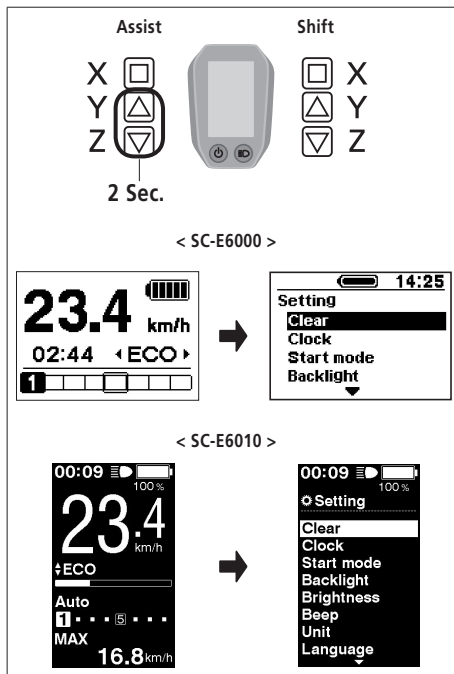

- Press the Assist-Y or Assist-Z to move the cursor to the item you want to configure.

Pressing the Assist-X displays the setting screen for the item selected.

Configurable items	Details
Clear	Clear settings
Clock	Clock setting
Start mode <sup>2</sup>	Start mode setting
Backlight	Backlight setting
Brightness <sup>1</sup>	Backlight brightness settings
Beep	Beep setting
Unit	Switching between km and miles
Language	Language setting
Font color <sup>1</sup>	Font color settings
Adjust <sup>2</sup>	Adjusting the power gear shifting unit
Auto <sup>2</sup>	Shift timing adjustment
Exit	Return to the main screen

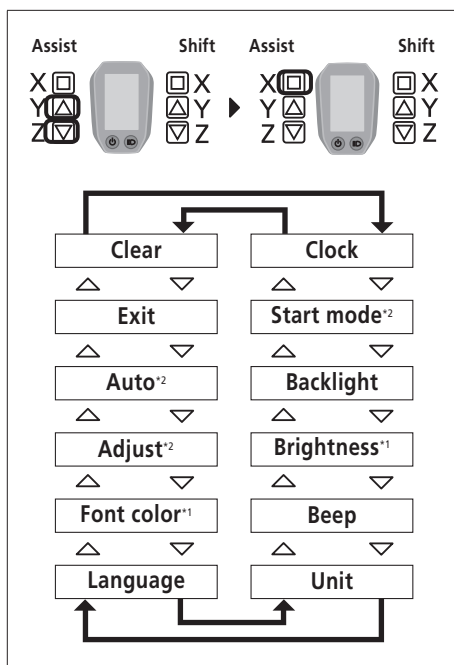

\* 1: This menu is only for the SC-E6010.

\* 2: This operation is only available when using electronic gear shifting.

## Clear (Clear settings)

Clear the traveling distance, or reset the display setting to default.

1. Press the Assist-Y or Assist-Z to move the cursor to the item you want to configure.

Configurable items	Details
Exit	Return to the setting menu screen
DST	Clearing the traveling distance
Default	Reset the SC display setting to default

Default value set in the SC display setting

Configurable items	Default value
Backlight	ON
Beep	ON
Unit	km
Language	English
<SC-E6010> Brightness	3
<SC-E6010> Font color	White

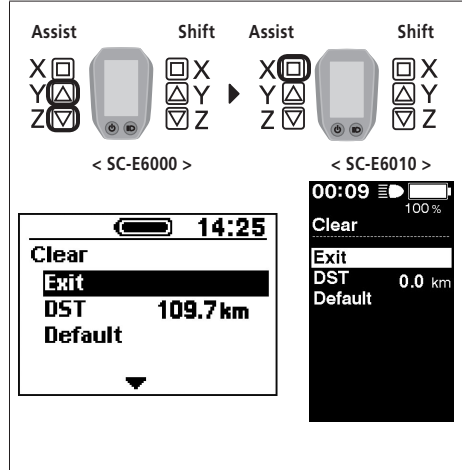

2. Pressing the Assist-X button enables the setting item indicate by the cursor and takes you back to the "Setting menu" screen.



When the traveling distance is cleared, TIME, AVG, and MAX are also cleared.

## Clock (Clock setting)

Configure the clock setting.

1. Press the Assist-Y or Assist-Z to set the hour.



Press Assist-Y to increase the numbers.

Press Assist-Z to decrease the numbers.

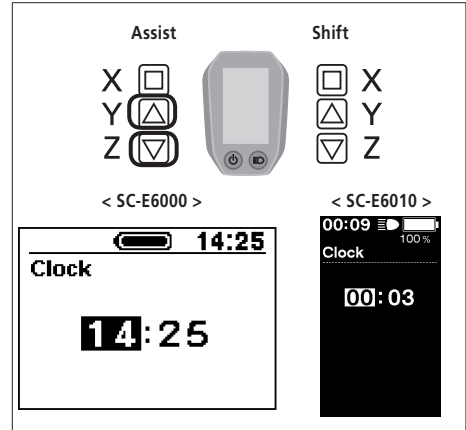

2. Pressing the Assist-X enables the set value and moves you to the minutes setting.

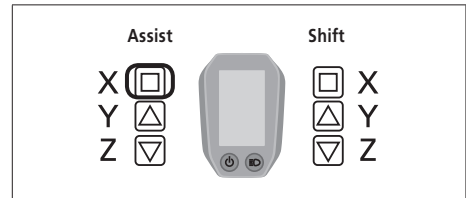

3. Press the Assist-Y or Assist-Z to set the minutes.

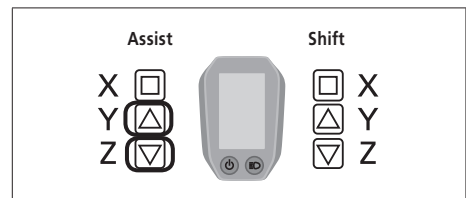

4. Pressing the Assist-X enables the set value and takes you back to the "Setting menu" screen.



You can change the numbers quickly by holding down the Assist-Y or Assist-Z.

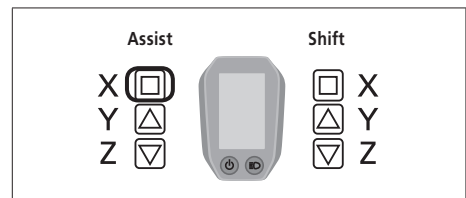

## Start mode (Start mode setting)

Sets the start gear when using start mode function.

1. Press the Assist-Y or Assist-Z to move the cursor to the item you want to configure.

Configurable items	Details
OFF	No setting
2	2-speed
3	3-speed
4	4-speed
5	5-speed

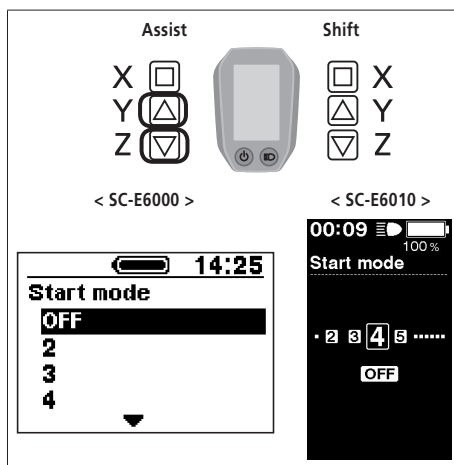

2. Pressing the Assist-X button enables the set value at the cursor position and takes you back to the "Setting menu" screen.

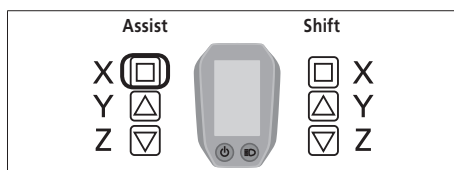

## Backlight (Backlight setting)

Configure the backlight setting.

1. Press the Assist-Y or Assist-Z to move the cursor to the item you want to configure.

Configurable items	Details
ON	Always turned on
OFF	Always turned off
MANUAL	Turns on and off in conjunction with the battery-powered light

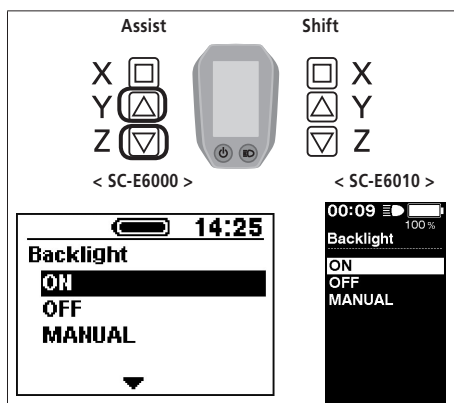

2. Pressing the Assist-X button enables the setting item indicated by the cursor and takes you back to the "Setting menu" screen.

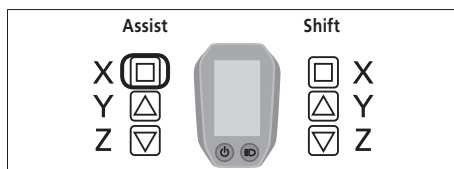



## Brightness (Backlight brightness settings) < SC-E6010 >

- Press Assist-Y or Assist-Z to adjust the brightness.
  - Brightness can be adjusted to one of 5 levels.

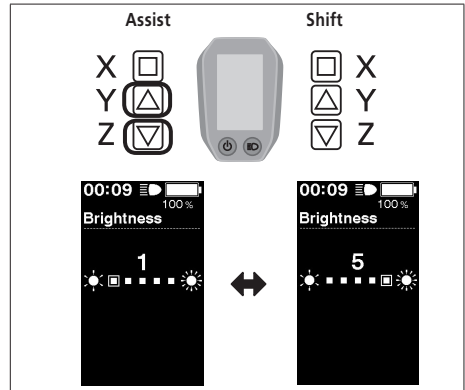

- Pressing the Assist-X button enables the set value at the cursor position and takes you back to the "Setting menu" screen.

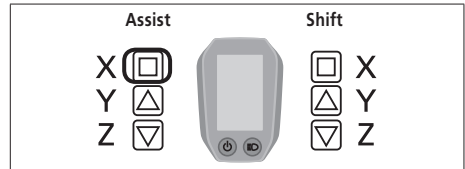

## Beep (Beep setting)

- Press the Assist-Y or Assist-Z to move the cursor to the item you want to configure.

Configurable items	Details
ON	Enable beeps
OFF	Disable beeps

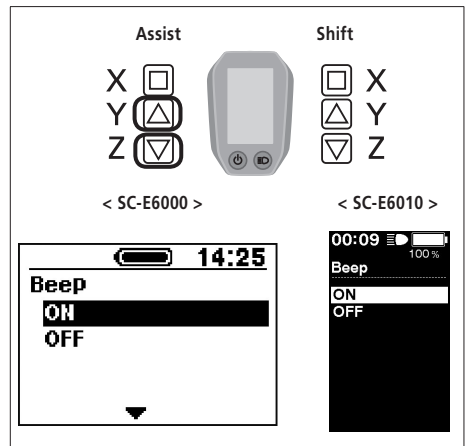

- Pressing the Assist-X button enables the setting item indicated by the cursor and takes you back to the "Setting menu" screen.

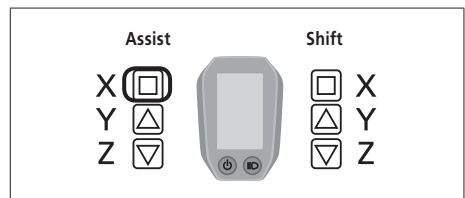

## Unit (Switching between km and miles)

Configure the distance unit setting.

1. Press the Assist-Y or Assist-Z to move the cursor to the item you want to configure.

Configurable items	Details
km	Displayed in km
mile	Displayed in miles

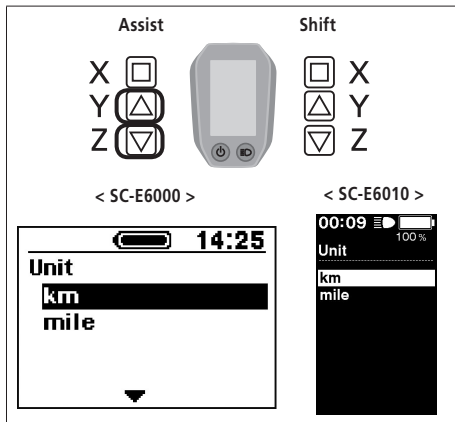

2. Pressing the Assist-X button enables the setting item indicated by the cursor and takes you back to the "Setting menu" screen.

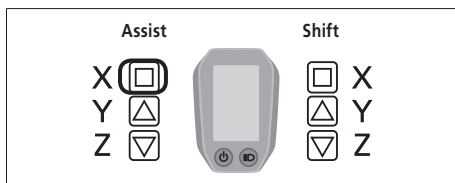

## Language (Language setting)

Configure the language setting.

1. Press the Assist-Y or Assist-Z to move the cursor to the item you want to configure.

Configurable items
English
Français
Deutsch
Nederlands
Italiano
Español

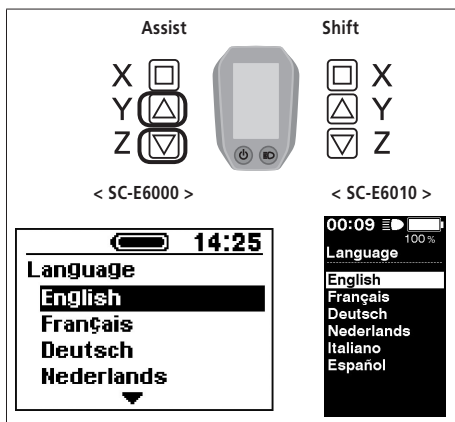

2. Pressing the Assist-X button enables the setting item indicated by the cursor and takes you back to the "Setting menu" screen.

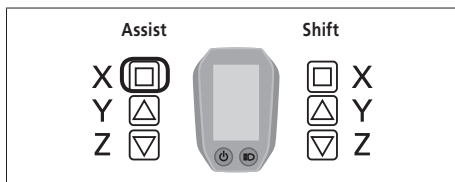

## Font color (Font color settings) < SC-E6010 >

1. Press the Assist-Y or Assist-Z to move the cursor to the item you want to configure.

Configurable items
White
Black

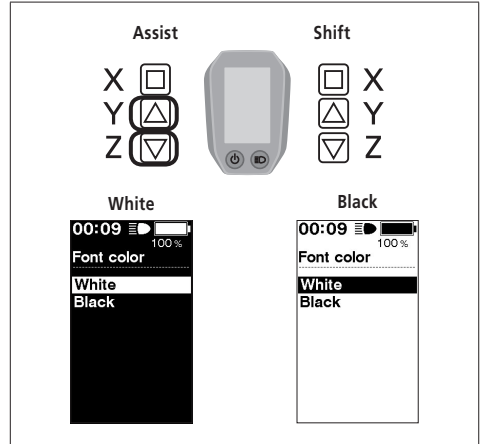

2. Pressing the Assist-X button enables the setting item indicated by the cursor and takes you back to the "Setting menu" screen.

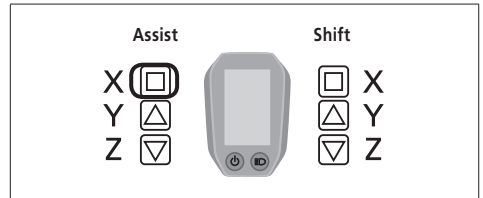

## "Adjust" (Adjusting the power gear shifting unit)

You can adjust gear shifting only when a built-in electronic gear shifting unit is connected.  
If you need to adjust the derailleur, contact the place of purchase.

## Auto (Shift timing adjustment)

Shift timing can be adjusted when in automatic shift mode.

1. Press Assist-Y or Assist-Z to adjust the values.
  - Pressing Assist-Y and adjusting the value upward adjusts shift timing to make pedaling easier.
  - Pressing Assist-Z and adjusting the value downward adjusts shift timing to make pedaling harder.

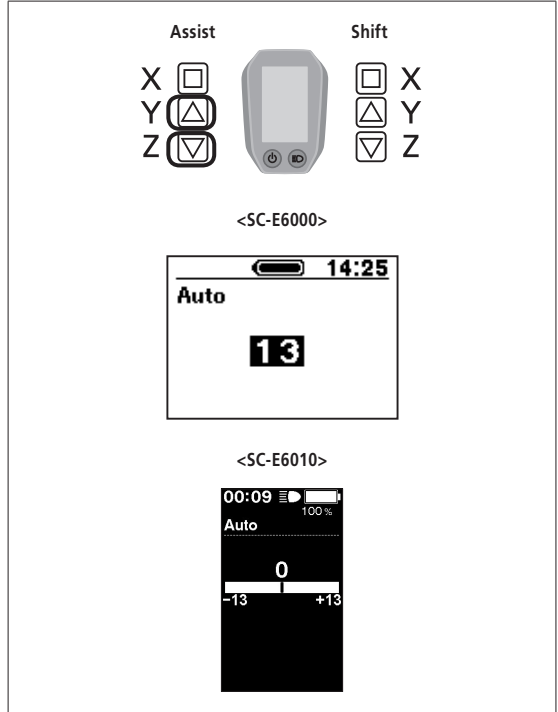

2. Pressing Assist-X enables the adjusted value and takes you back to the "Setting menu".

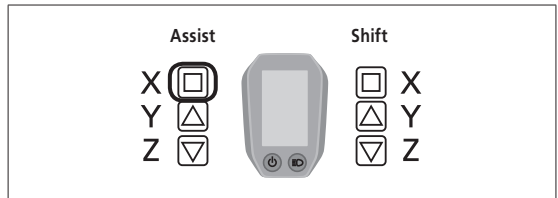

## Exit (Exit setting)

1. Press the Assist-Y or Assist-Z to move the cursor to "Exit".
2. Pressing the Assist-X exits the setting menu and takes you back to the basic screen.

## Drive unit setting data backup function

The data saved to the drive unit is usually backed up automatically. However, performing the following operations will cause a message to appear asking whether or not to update the backup data.

- Reinstalling the cycle computer on a bicycle with different settings.
- Changing the drive unit settings for an E-tube project.

## Connection and communication with the PC

### ■ Downloading application

You need E-tube Project to configure SHIMANO STEPS and update firmware.

Download an E-tube Project from the support website (<http://e-tubeproject.shimano.com>).

For information on how to install an E-tube Project, check the support website. For information on how to operate the PC, refer to the help manual on the E-tube Project.

### CAUTION





Connection and communication with a PC is not possible while charging.



- You need SM-PCE1 and SM-JC40 / JC41 to connect SHIMANO STEPS to a PC.
  - Firmware is subject to change without notice.
- If necessary, contact the place of purchase.

## Troubleshooting

### ■ Battery level and error indication

Error indication type	Indication condition	Lighting pattern *1	Recovery
System error	Communication error with the bicycle system		Make sure that the cable is not loose or improperly connected. If the situation does not improve, contact the place of purchase.
Temperature protection	If the temperature exceeds the guaranteed operating range, the battery output is turned off.		Leave the battery in a cool place away from direct sunlight until the internal temperature of the battery decreases sufficiently. If the situation does not improve, contact the place of purchase.
Security authentication error	This is displayed if a genuine drive unit is not connected. This is displayed if any of the cables are disconnected.		Connect a genuine battery and drive unit. Check the condition of the cables. If the situation does not improve, contact the place of purchase.
Charging error	This is displayed if an error occurs during charging.		Remove the charger from the battery and press the power button, if an error appears contact an agency.
Battery malfunction	Electrical failure inside the battery		Connect the charger to the battery and then remove the charger. Press the power button with only the battery connected. If an error appears with only the battery connected, contact the place of purchase.

\*1 ● : No light ○ : Lights up ☀ : Flashing

## ■ Error messages on the cycle computer

### WARNING

This disappears if the error is fixed.

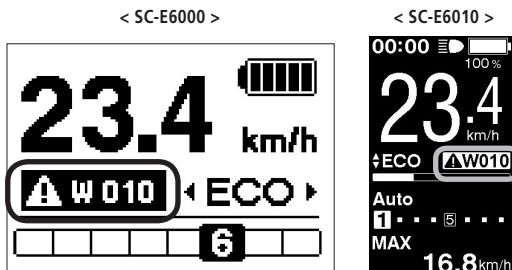

Code	Situation where the error occurred	Condition for removing the operational restriction when a warning is being displayed	Remedy
W031	The chain tension may not have been adjusted or the crank may have been installed in the wrong position.	The assist function is not available. (Electronic gear shifting does not function.)	Contact the place of purchase or bicycle dealer.

< SC-E6010 >

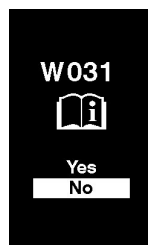

### List of warnings

Code	Situation where the error occurred	Condition for removing the operational restriction when a warning is being displayed	Remedy
W010	The temperature of the drive unit is high.	The level of assistance may decrease.	Stop using the assist function until the temperature of the drive unit drops. If the situation does not improve, contact the place of purchase.
W011	The traveling speed cannot be detected.	The maximum speed up to which power assistance is provided may decrease. (Power assistance is provided up to 25 km/h in top gear.)	Check that the speed sensor is properly installed. If the situation does not improve, contact the place of purchase.

Code	Situation where the error occurred	Condition for removing the operational restriction when a warning is being displayed	Remedy
W012	The crank may be installed in the wrong direction.	-	Install the crank in the correct direction, then turn on the power again.
W030	Two or more assist switches are connected to the system.	Gear shifting is not available for power gear shifting derailleurs.	Change the assist switch to the gear shifting switch, or connect only one assist switch and turn on the power again. If the situation does not improve, contact the place of purchase.
-	A communication error between the drive unit and the motor unit was detected.	Gear shifting is not available for power gear shifting derailleurs.	Check that the cable is properly connected between the drive unit and the motor unit. If the situation does not improve, contact the place of purchase.

## Error

If an error message is displayed on the entire screen, follow one of the procedures below to reset the display.

- Press the power button of the battery.
- Remove the battery from the holder.



If resetting the battery power does not solve the problem or the same problem occurs frequently, contact the place of purchase.

<SC-E6000>



<SC-E6010>

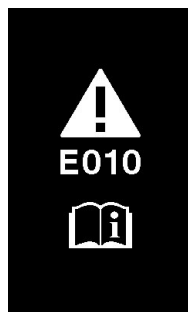

## List of errors

Code	Situation where the error occurred	Operational restriction when an error is being displayed	Remedy
E010	A system error was detected.	Power assistance is not provided during riding.	Press the power button of the battery to turn it on again. If the situation does not improve, contact the place of purchase.
E012	The initialization of the torque sensor failed.	Power assistance is not provided during riding.	With your foot off the pedal, press the battery power button and turn on the power again. If the situation does not improve, contact the place of purchase.
E013	An anomaly was detected in the drive unit's firmware.	Power assistance is not provided during riding.	Contact the place of purchase or bicycle dealer.



Code	Situation where the error occurred	Operational restriction when an error is being displayed	Remedy
E014	The speed sensor may have been installed in the wrong position.	Power assistance is not provided during riding.	Contact the place of purchase or bicycle dealer.
E020	A communication error between the battery and drive unit was detected.	Power assistance is not provided during riding.	Check that the cable between the drive unit and battery is properly connected. If the situation does not improve, contact the place of purchase.
E030	A setting error was detected.	Power assistance is not provided during riding.	If the situation does not improve even after pressing the battery power button and turning on the power again, contact the place of purchase.
E031	The chain tension may not have been adjusted or the crank may have been installed in the wrong position.	The assist function is not available. (Electronic gear shifting does not function.)	Contact the place of purchase or bicycle dealer.
E043	Part of the cycle computer's firmware may be damaged.	Power assistance is not provided during riding.	Contact the place of purchase or bicycle dealer.

## ■ Troubleshooting

### Assist function

Symptom	Cause / Possibility	Remedy
Assistance is not being provided.	Is the battery sufficiently charged?	Check the battery charge. If the battery is nearly spent, recharge it.
	Are you riding on long slopes in summer weather or riding for a long time carrying a heavy load? The battery may be overheating.	Turn off the power, wait for a while and then check once more.
	The drive unit (DU-E6000 / DU-E6001 / DU-E6050 / DU-E6010), cycle computer (SC-E6000 / SC-E6010) or assist switch (SW-E6000) may be connected incorrectly or there may be a problem with one or more of them.	Contact the place of purchase.
	Is the speed too high?	Check the Cycle Computer display. Assistance is not provided at speeds of 25 km/h or more.

Symptom	Cause / Possibility	Remedy
Assistance is not being provided.	Are you pedaling?	The bicycle is not a motorbike, so you need to operate the pedals.
	Is the assist mode set to "OFF"?	Set the assist mode to "HIGH". If you still do not feel that assistance is being given, contact the place of purchase.
	Is the system power ON?	If you have performed the steps below and still do not feel the assistance, contact the place of purchase. <SC-E6010> Press and hold the cycle computer power button for 2 seconds, or press the battery power button to turn the power ON. <SC-E6000> Press the battery power button to turn the power ON.
Assist traveling distance is too short.	The traveling distance may become shorter depending on road conditions, the gear position and whether the light are ON or OFF.	Check the battery charge. If the battery is nearly spent, recharge it.
	The battery characteristics will drop during winter weather.	This is not a sign of a problem.
	The battery is a consumable part. Repeated recharging and long periods of use will cause the battery to deteriorate (lose its performance).	If the distance that can be traveled on a single charge is very short, replace the battery with a new one.
Pedaling is stiff.	Are the tires inflated to a sufficient pressure?	Use a pump to add air.
	Is the assist mode set to OFF?	Set the assist mode to "HIGH". If you still do not feel that assistance is being given, contact the place of purchase.
	The battery may be running low.	After charging the battery well, check the level of assistance again. If you still do not feel that assistance is being given, contact the place of purchase.
	Did you turn on the power with your foot placed on the pedal?	Turn on the power again without putting pressure on the pedal. If you still do not feel that assistance is being given, contact the place of purchase.

## Battery

Symptom	Cause / Possibility	Remedy
All the five battery level indicators stay on.	The battery level indicators do not show battery levels when the battery is connected to the bicycle. Battery levels are shown during charging.	It is not a sign of a malfunction.
The battery quickly loses its charge.	The battery may be at the end of its service life.	Replace the battery with a new one.
The battery cannot be recharged.	Is the power plug of the charger securely inserted into the electrical outlet?	Disconnect and then reconnect the power plug of the charger, and then repeat the recharging operation. If the battery still cannot be recharged, contact the place of purchase.
	Is the recharging plug of the charger securely inserted into the battery?	Disconnect and then reconnect the recharging plug of the charger, and then repeat the recharging operation. If the battery still cannot be recharged, contact the place of purchase.
	Is the charging adapter securely connected to the charging plug, or to the battery charger connector?	Securely connect the charging adapter to the charging plug or to the battery charger connector, and charge again. If the battery still does not charge, consult a dealer.
	Is the connecting terminal for the battery charger, charging adapter, or battery dirty?	Wipe the connection terminals with a dry cloth to clean them, and then repeat the recharging operation. If the battery still cannot be recharged, contact the place of purchase.
The battery does not start recharging when the charger is connected.	The battery may be at the end of its service life.	Replace the battery with a new one.
The battery and charger are becoming hot.	The temperature of the battery or charger may exceed the operating temperature range.	Stop recharging, wait for a while and then recharge again. If the battery is too hot to touch, it may indicate a problem with the battery. Contact the place of purchase.
The charger is warm.	If the charger is being used continuously to charge batteries, it may become warm.	Wait a while before using the charger again.
The LED on the charger does not illuminate.	Is the recharging plug of the charger securely inserted into the battery?	Check the connection for any foreign objects before reinserting the charging connector. If there is no change, contact the place of purchase.
	Is the battery fully charged?	If the battery is fully charged, the LED on the battery charger turns off, but this is not a malfunction. Disconnect and then reconnect the power plug of the charger, and then repeat the recharging operation. If the LED on the charger still does not illuminate, contact the place of purchase.

Symptom	Cause / Possibility	Remedy
The battery cannot be removed.		Contact the place of purchase.
The battery cannot be inserted.		Contact the place of purchase.
Fluid is coming out from the battery.		Contact the place of purchase.
An abnormal odor can be detected.		Stop using the battery immediately and contact the place of purchase.
Smoke is coming out from the battery.		Stop using the battery immediately and contact the place of purchase.

## Lights

Symptom	Cause / Possibility	Remedy
The front light or the tail light does not illuminate even when the switch is pressed.	The E-tube Project settings may be wrong.	Contact the place of purchase.

## Cycle computer

Symptom	Cause / Possibility	Remedy
The cycle computer is not displayed when you push the battery power button.	The amount of battery charge may be insufficient.	Recharge the battery, and then turn the power on once more.
	Is the power turned on?	Hold down the power button to turn on the power.
	Is the battery charging?	The power cannot be turned on while the battery is mounted on the bicycle and being charged. Stop charging.
	Is the cycle computer correctly installed to the bracket?	Install the cycle computer correctly while referring to "Installing and removing the cycle computer".
	Is the electric wire connector correctly installed?	Check to see if the connector of the electric wire connecting the motor unit to drive unit is not disconnected. If you are not sure, contact the place of purchase.
	A component that the system cannot identify may be connected.	Contact the place of purchase.
<SC-E6010> The system does not start up when you press and hold the cycle computer power button for 2 seconds.	Did you use the cycle computer in, or expose it to, low temperatures for an extended period?	The cycle computer may become unable to turn on if used in, or exposed to, low temperatures for an extended period. Turn it on by pressing the power button on the battery. If it still does not turn on, consult a dealer.
	Is the cycle computer correctly installed to the bracket?	Install the cycle computer correctly while referring to "Installing and removing the cycle computer".

Symptom	Cause / Possibility	Remedy
The gear position is not displayed.	The gear position is only displayed when the power gear shifting unit is installed.	Check if the electric wire connector is disconnected. If you are not sure, contact the place of purchase.
Can the beep be turned off.		Change the setting. Refer to "Beep (Beep setting)".
Can the backlight be turned off.		Change the setting. Refer to "Backlight (Backlight setting)".
The setting menu cannot be launched while riding the bicycle.	The product is designed so that if it detects that the bicycle is being ridden, the Setting menu cannot be launched. This is not a sign of an abnormality.	Stop the bicycle and then make the settings.

#### Other

Symptom	Cause / Possibility	Remedy
When pressing the switch, two beeps sound, and the switch cannot be operated.	Operation of the switch being pressed has been disabled.	It is not a sign of a malfunction.
Three beeps sound.	An error or warning is occurring.	This occurs when a warning or error is displayed on the cycle computer. Refer to the section "Error messages on the cycle computer" and follow the instructions provided for the appropriate code.
When using a electronic gear shifting mode, I feel that the level of assistance weakens when the gears shift.	This occurs because the level of assistance is being adjusted to the optimum level by the computer control.	It is not a sign of a malfunction.
Sound occurs after gear shifting.		Contact the place of purchase.
A noise can be heard from the rear wheel during normal riding.	Gear shifting adjustment may not have been carried out correctly.	<b>For mechanical gear shifting</b> Adjust the cable tension. For details, refer to the Service Instructions for the derailleur. <b>For powered gear shifting</b> Contact the place of purchase.
When you stop the bicycle, the gear does not shift to the position preset in the start mode.	You may have been pressing the pedals too strongly.	If you press the pedals lightly, the gear shifts more easily.



**\* Key number**

The number that is attached to the key is needed in case you need to purchase spare keys.  
Make a note of the in the number following box and keep it in a safe place.

Key number

# SHIMANO

**SHIMANO AMERICAN CORPORATION**

One Holland, Irvine, California 92618, U.S.A. Phone: +1-949-951-5003

**SHIMANO EUROPE B.V.**

Industrieweg 24, 8071 CT Nunspeet, The Netherlands Phone: +31-341-272222

**SHIMANO INC.**

3-77 Oimatsu-cho, Sakai-ku, Sakai-shi, Osaka 590-8577, Japan

Please note: specifications are subject to change for improvement without notice. (English)

© Jun. 2015 by Shimano Inc. HTR