

**BUILDING
PERFORMANCE**

Earthquake geotechnical engineering practice

**Module 2. Geotechnical investigations
for earthquake engineering**

November 2021



**MINISTRY OF BUSINESS,
INNOVATION & EMPLOYMENT**
HĪKINA WHAKATUTUKI



**NEW ZEALAND
GEOTECHNICAL
SOCIETY INC**
www.nzgs.org

Contents

Acknowledgements.....	iv
Preface	vi
1 Introduction	1
1.1 Purpose and Scope.....	1
1.2 Definition of Geotechnical Professional	2
1.3 Role of Geotechnical Professional in Site Investigation	3
2 Project Planning/Initiation	4
2.1 Project Type	4
2.1.1 General.....	4
2.1.2 New Construction	4
2.1.3 Retrofit	4
2.2 Communication with the Wider Project Team.....	4
2.3 Initial Planning	5
2.3.1 Desktop Study.....	6
2.3.2 Site Walkover.....	6
2.4 Site Investigation Planning.....	7
2.4.1 Specification and Procurement of Site Investigation Services	7
2.4.2 Types of Investigation	8
2.4.3 Spacing of Investigation Points.....	9
2.4.4 Depth of Investigation.....	12
2.5 Standards and Guidelines	15
2.6 Data Collection and Record Keeping	15
2.7 New Zealand Geotechnical Database.....	16
2.8 Health and Safety.....	17
3 Site Investigation Methods	18
3.1 Cone Penetration Testing (CPT).....	19
3.1.1 General.....	19
3.1.2 CPT Resolution/Accuracy.....	22

3.1.3	Pore Pressure Measurement.....	22
3.1.4	Equipment Calibration/Maintenance	23
3.1.5	Baseline Readings	24
3.1.6	Piezocone Filter Elements	24
3.1.7	CPT Profiles.....	24
3.2	Borehole Drilling and Sampling	26
3.2.1	When to consider Machine-Drilled Boreholes.....	26
3.2.2	Types of Drilling.....	26
3.2.3	Common Drilling Errors	31
3.2.4	Soil Sampling.....	31
3.2.5	Standard Penetration Testing (SPT)	38
3.3	Test Pits.....	40
3.4	Plate Load Testing	41
3.5	Pressuremeter Testing.....	41
3.6	Dilatometer Test.....	42
3.7	In situ Seismic Testing.....	43
3.7.1	Overview of Seismic Waves.....	44
3.7.2	Overview of In situ Seismic Test Methods.....	46
3.7.3	Non-Invasive (Surface Wave) Methods	48
3.7.4	Invasive Methods.....	58
3.7.5	Minimum Reporting Requirements for In situ Seismic Testing	64
3.7.6	Other Geophysical Tests.....	64
3.8	Groundwater Measurement	65
3.8.1	General.....	65
3.8.2	Existing Well Information.....	65
3.8.3	Open Boreholes.....	65
3.8.4	Cone Penetration Test	66
3.8.5	Observation Wells and Piezometers.....	67
3.8.6	Water Level Measurements.....	67
4	Laboratory Testing of Soil Samples	69
4.1	General.....	69
4.1.1	Selection and Assignment of Tests	70

4.2	Visual Identification of Soils	71
4.2.1	Disturbed Samples.....	71
4.2.2	High Quality or ‘Undisturbed’ Samples	71
4.3	Index Properties	72
4.3.1	Moisture Content.....	72
4.3.2	Particle-Size Distribution	72
4.3.3	Atterberg Limits.....	73
4.4	Shear Strength and Cyclic Testing	74
4.4.1	Consolidated Undrained Triaxial Strength (CU Test).....	74
4.4.2	Direct Shear (Shear Box) Test.....	74
4.4.3	Cyclic Triaxial Test (CTX)	75
4.5	One-Dimensional Consolidation Test.....	76
4.6	Quality Assurance.....	77
4.6.1	Sample Storage.....	77
4.6.2	Sample Handling	77
4.6.3	Specimen Selection.....	77
4.6.4	Equipment Calibration	78
4.6.5	Testing Standards	78
4.6.6	Common Testing Pitfalls.....	78
5	Geotechnical Reports.....	80
5.1	Data Presentation	80
5.1.1	Site Investigation Logs.....	80
5.1.2	Test Investigation Locations	81
5.1.3	Subsurface Profiles and Geotechnical Models.....	81
5.1.4	Geotechnical Model Development Process.....	81
5.1.5	Limitations	82
6	References	83
	Appendix A. CPT Accuracy and Resolution.....	87
	Appendix B. Examples of Common CPT Output Errors and Anomalies	89
	Appendix C. CPT Fieldwork Checklists	97
	Appendix D. SPT Drilling and Sampling Procedures for Liquefaction Assessment	98

Acknowledgements

NZGS/ENGINEERING NEW ZEALAND PANEL FOR REVISION 1

- › Rick Wentz — Wentz Pacific Ltd (lead author)
- › Nick Traylen — Geotech Consulting Ltd (lead author)
- › Tony Fairclough — Tonkin & Taylor
- › Prof Misko Cubrinovski — University of Canterbury
- › Dr Kevin McManus — McManus Geotech Ltd
- › Mike Stannard — Engineering New Zealand (project lead)
- › John Scott — Earthquake Commission (EQC)
- › Kiran Saligame — Ministry of Business, Innovation & Employment (MBIE)
- › Ananth Balachandra — NZGS
- › Dr Alexei Murashev — WSP
- › Campbell Keepa — WSP
- › Mike Jacka — Tonkin & Taylor (contributor)

REVIEW

- › Dr Liam Wotherspoon — University of Auckland

NZGS/MBIE EDITORIAL PANEL AND CONTRIBUTORS FOR REVISION 0 (PUBLISHED NOVEMBER 2016)

- › Rick Wentz
- › Nick Traylen
- › Tony Fairclough
- › Misko Cubrinovski
- › Kevin McManus
- › Charlie Price — MWH Global, NZGS Chair
- › John Scott — MBIE
- › Gilles Seve — MBIE
- › Mike Stannard — MBIE
- › Clive Anderson — Golder Associates Ltd
- › Daniel Ashfield — Tonkin & Taylor
- › Paul Burton — Geotechnics Ltd
- › Guy Cassidy — Engeo Ltd
- › Dr Greg De Pascale — University of Chile
- › Riley Gerbrandt — County of Santa Cruz
- › Sally Hargraves — Terra Firma Engineering Ltd
- › Iain Haycock — McMillan Drilling Ltd
- › Marco Holtrigter — Ground Investigation Ltd
- › Edwyn Ladley — Tonkin & Taylor
- › Ian McPherson — Aurecon Ltd
- › Liam Wotherspoon

MINISTRY OF BUSINESS, INNOVATION & EMPLOYMENT

- › Jenni Tipler

NZGS MANAGEMENT

- › Ross Roberts

ENGINEERING NEW ZEALAND

- › Kaya Yamabe
- › Eleanor Laban
- › Tania Williams

EQC

- › Jo Horrocks

Document status

ISBN: (print) 978-0-947524-45-6

ISBN: (online) 978-0-947524-46-3

New Zealand Geotechnical Society (NZGS) and Ministry of Business Innovation & Employment (MBIE)
Earthquake Geotechnical Engineering Practice in New Zealand

Rev 1

Issue date November 2021

New Zealand Geotechnical Society (NZGS)

c/ Engineering New Zealand

PO Box 12-241

Wellington 6013

Ministry of Business Innovation & Employment (MBIE)

Building System Performance Branch

PO Box 1473

Wellington 6140

DISCLAIMER

This document published by the Chief Executive of MBIE as guidance under section 175 of the Building Act 2004 to assist parties to comply with their obligations under the Building Act 2004.

It is not mandatory to follow the guidance, but if followed:

- › it does not relieve any person of the obligation to consider any matter to which that information relates according to the circumstances of the particular case;
- › users should consider taking appropriate professional advice prior to entering into a construction contract which incorporates all or parts of this document.

While MBIE, Engineering New Zealand, and the NZGS have taken care in preparing this document, it is only a guide. It is not a substitute for legal advice or legislation.

All users should satisfy themselves as to the applicability of the content and should not act on the basis of any matter contained in this document without considering, and if necessary, taking appropriate professional advice.

The document may be updated from time to time and the latest version is available from the Ministry's website at www.building.govt.nz or the New Zealand Geotechnical Society's website at www.nzgs.org

IMPORTANT NOTICE

The contents may be subject to changes, additions, and deletions. Submissions by the geotechnical community to the Society are encouraged, as it is intended that the guidelines will be updated from time to time.

© COPYRIGHT

The copyright owner authorises reproduction of this work, in whole or in part, so long as no charge is made for the supply of copies, and the integrity and attribution of the contributors and publishers of the document is not interfered with in any way.

Preface

This document is part of a series of guidance modules developed jointly by the Ministry of Business, Innovation & Employment (MBIE) and the New Zealand Geotechnical Society (NZGS).

The guidance series along with an education programme aims to lift the level and improve consistency of earthquake geotechnical engineering practice in New Zealand, to address lessons from the Canterbury and Kaikōura earthquakes and the Canterbury Earthquakes Royal Commission recommendations. It is aimed at experienced geotechnical professionals, bringing up to date international research and practice.

This document should be read in conjunction with the other modules published to date in the series:

- › Module 1: Overview of the Guidelines
- › Module 3: Identification, assessment and mitigation of liquefaction hazards
- › Module 4: Earthquake resistant foundation design
- › Module 5: Ground improvement of soils prone to liquefaction
- › Module 5A: Specification of ground improvement for residential properties in the Canterbury region
- › Module 6: Earthquake Resistant Retaining Wall Design

On-line training material in support of the series is available on the MBIE and NZGS websites, www.building.govt.nz and www.nzgs.org/.

Undertaking adequate geotechnical investigations to understand likely ground performance in earthquakes is an essential aspect of good and economic building design.

We would encourage you to make yourselves familiar with the guidance and apply it appropriately in practice.

Eleni Gkeli
Chair
New Zealand Geotechnical Society

Jenni Tipler
Manager Building Performance and Engineering
Ministry of Business, Innovation & Employment

1 Introduction



1.1 Purpose and Scope

This guidance document (Module 2) is part of a series of Earthquake Geotechnical Engineering Practice guidelines and should be read in conjunction with the rest of the series.

It is intended that this document will be primarily used by Geotechnical Engineers, Engineering Geologists and their staff to scope, execute and review geotechnical site investigations.

This document has three primary objectives:

- 1 The promotion of good practices for the collection of consistent, high quality and reliable factual geotechnical data for the purposes of earthquake geotechnical engineering (primarily for buildings).
- 2 The provision of guidance on an appropriate minimum scope and methodology for undertaking such investigations.
- 3 The promotion of investigation techniques and methodologies which are consistent and compatible with the assessment and analysis methodologies which are referenced in Modules 3¹ and 4².

While this document is intended as a reference guide for earthquake geotechnical engineering, the methods presented herein represent good practice for geotechnical investigations in general in New Zealand.

The information in this document, while covering general ground investigation methods, is focussed on soil sites as these tend to have more issues arising from earthquake engineering considerations. This document does not purport to cover all methods of investigation and testing—methods other than those covered in this document may also be applicable on a project in certain circumstances; however, this document is intended to reflect good practice for routine projects.

-
- 1 Earthquake geotechnical engineering practice, Module 3 — Identification, Assessment, and Mitigation of Liquefaction Hazards.
 - 2 Earthquake geotechnical engineering practice, Module 4 — Earthquake Resistant Foundation Design.

Associated with this document is commentary which expands on the intent of some aspects of the guidance or best-practice advice, clarification of general principles, and/or experiences gained after Christchurch earthquakes that may be valuable. The commentary is presented in coloured boxes similar to this example.

The types of development to which this document pertains are generally residential and commercial with a Building Importance Level (IL) of 1 to 3 as defined in joint standard AS/NZS1170.

Information in this document will also be relevant for IL 4 and 5 structures, infrastructure projects and projects of significance such as high impact dams (as defined by NZSOLD), airports, marine structures and power stations. However, further detailed or specialised

investigations will likely be required for these types of structures; the scope and type of which may be beyond the scope of this document.

While the specifics of data analysis and interpretation are beyond the scope of this document, some guidance is provided on general requirements for reporting.

Earthquake geotechnical engineering is a highly specialised field. As such it is recommended that investigations for this are supervised by an appropriately qualified and experienced geotechnical engineer or engineering geologist.

Where discrepancies are identified between this guidance document and any other testing standard, guidance document or project specification it is the responsibility of the geotechnical professional to determine the appropriate application for the particular project situation, and site in question.

1.2 Definition of Geotechnical Professional

Earthquake geotechnical engineering is a highly specialised field. As such the investigations for this need to be developed and carried out by an appropriately qualified and experienced geotechnical engineer or engineering geologist (referred to herein as the geotechnical professional).

For the purposes of this document 'geotechnical professional' means the authorised representative of the consultancy that is ultimately responsible for design and execution of the geotechnical investigation. The geotechnical professional should be a geotechnical engineer and/or engineering geologist who holds a current CPEng accreditation in the geotechnical practice area and/or PEngGeol

registration, under the Chartered Professional Engineers of New Zealand Act 2002, or equivalent, with demonstrable extensive experience in investigating earthquake geotechnical hazards.

Currently, the Chartered Professional Engineer (CPEng) and Professional Engineering Geologist (PEngGeol) quality marks are registered as assessed and administered by Engineering New Zealand.

1.3 Role of Geotechnical Professional in Site Investigation

Geotechnical engineering, in particular earthquake geotechnical engineering, is a highly specialised field. The geotechnical professional, among others, is responsible for acquiring and interpreting soil, rock, and foundation data for design and construction of various types of structures.

The proper execution of this role requires a thorough understanding of the principles and practice of:

- › geotechnical engineering
- › subsurface investigation techniques and principles
- › design procedures
- › construction methods
- › a supplementary working knowledge of geology and hydrogeology.

While acquisition of site data (the focus of this module) can be carried out by either a CPEng geotechnical engineer, or a PEngGeol engineering geologist, analysis and interpretation of data is expected to require the specific skills of a CPEng geotechnical engineer experienced in earthquake geotechnical engineering.

For many projects, it will be necessary to have the involvement of a geologist or engineering geologist. This is particularly true for projects that involve identifying and mitigating geotechnical issues that are heavily influenced by the underlying geology or geological processes. Obvious examples of this include identification of liquefaction-prone soils on a regional basis, and assessment of slope stability. However, a good understanding of geology is also useful for several types of projects such as those involving volcanic soils, identification of potentially expansive clays and identification, mitigation (or both) of debris slides or flows.

The proper discharge of the geotechnical professional's duties will require that they are involved from the initial planning stage of a project. Once the project location, geometry and other attributes are determined, the geotechnical professional and the design team should jointly define the subsurface exploration needs. The geotechnical professional should be given the responsibility and the authority to make decisions involving the details of the subsurface investigation based on his or her knowledge of the site conditions and of the proposed design.

With respect to site investigation, it is the responsibility of the geotechnical professional to:

- › direct the collection of existing data
- › conduct field reconnaissance
- › plan and scope the site investigation
- › initiate and supervise the site investigation
- › review progress
- › develop and supervise laboratory testing of field samples.

Field supervision of site investigations by appropriately experienced personnel is recommended; particularly when drilling and SPT sampling, or using specialised investigation techniques (eg gel-push sampling). Field supervision of site investigations should always be performed for IL3 or higher projects, and sites with known complex ground conditions.

The perceived cost savings of not having field supervision can easily be lost due to the geotechnical professional not being able to see for themselves the behaviour of the ground during sampling, or because unusual or unexpected ground conditions are encountered. Observation of the investigation activities allows the geotechnical professional to make recommendations and implement changes as required, in a timely manner.

In some cases field supervision is performed by less experienced personnel (under the direction of the geotechnical professional). This is acceptable if they have a good working knowledge of the investigation techniques being used and their limitations, as well as soil types and behaviour. When unusual or unexpected conditions are encountered during the investigation or construction phase, the field engineer or engineering geologist should communicate these findings to the supervising geotechnical professional, make recommendations and implement changes as needed or directed by the geotechnical professional.

The geotechnical professional should be the authorising signatory on the final version of all geotechnical reports, drawings, producer statements, statements of suitability or statements of professional opinion.

2 Project Planning/Initiation

2.1 Project Type

2.1.1 GENERAL

Projects will typically be classified as either residential or commercial, and some of the design requirements will vary between the two types. The requirements for geotechnical investigation of single-family residential structures are normally less than those for commercial structures. However, some single-family dwellings can be as large or heavy as a medium-size commercial structure, meaning the geotechnical investigation requirements may be similar to those of a commercial building of similar size.

2.1.2 NEW CONSTRUCTION

For construction of a new building, the geotechnical investigation will need to consider:

- › foundation support
- › site earthworks
- › retaining walls
- › slopes
- › and perhaps ancillary structures such as underground services.

2.1.3 RETROFIT

A retrofit or renovation of an existing structure may include:

- › increasing structural loads on existing foundations
- › expanding the size of the structure or replacing a part of the structure.

Retrofit projects will often require the geotechnical engineer to consider the performance of new or additionally loaded foundations relative to existing foundations. Maintaining uniform foundation response under seismic loading is a key requirement to achieving good overall seismic performance.

2.2 Communication with the Wider Project Team

Most projects benefit if there is open communication between the geotechnical professional and the structural engineer as well as the project manager. A mutual understanding of project objectives can lead to an optimisation of investigation effort. Any unusual conditions or difficulties encountered, and any changes made in the investigation programme or schedule should be communicated in a timely fashion (even the possibility of this occurring should be communicated to the project manager and client at the proposal stage). The frequency of these communications will depend on the nature and scale of the project.

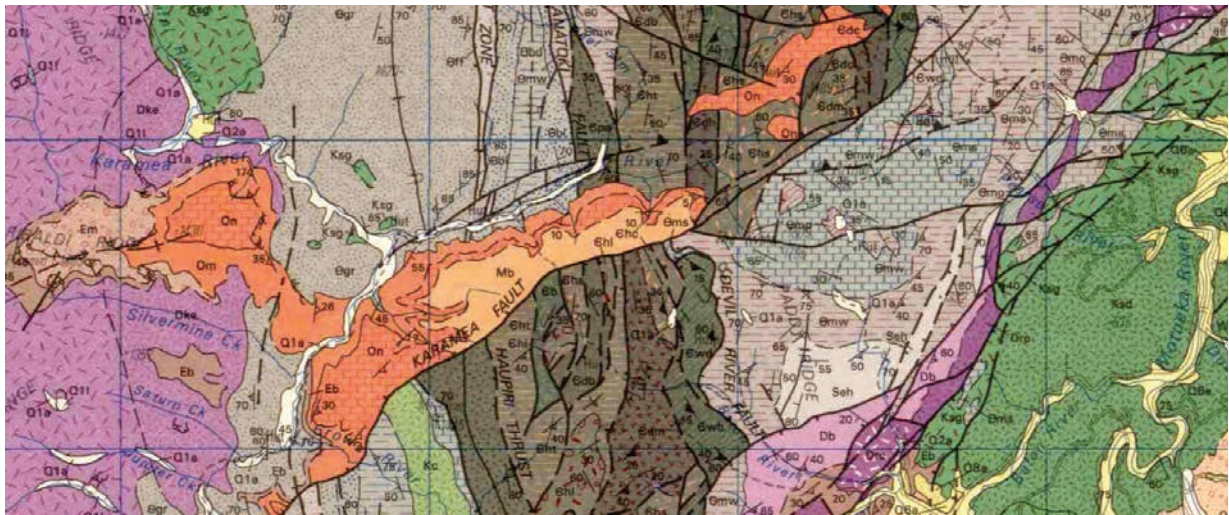

2.3 Initial Planning

The primary objective of most geotechnical investigation programmes is to provide an adequate understanding of the ground conditions for the project being undertaken. This would normally require an understanding of the type and spatial distribution of soils beneath a site, as well as an assessment of their material index and strength properties.

A geotechnical site investigation program for a 'routine' residential or commercial development typically comprises the following three key stages:

- 1 desktop study and site reconnaissance
- 2 site investigation(s)
- 3 analysis and reporting.

Large project sites, or sites containing unusually complex geotechnical conditions, may require a

second round of field investigation and analysis, as will sites where unexpected ground conditions are encountered. A graphical geotechnical model of the site may need to be developed to assist the geotechnical professional with identifying subsurface features which may impact the proposed project. Figure 2 illustrates the typical stages of a geotechnical site investigation for a large or complex project.

Figure 2.1: The Geotechnical Investigation Process

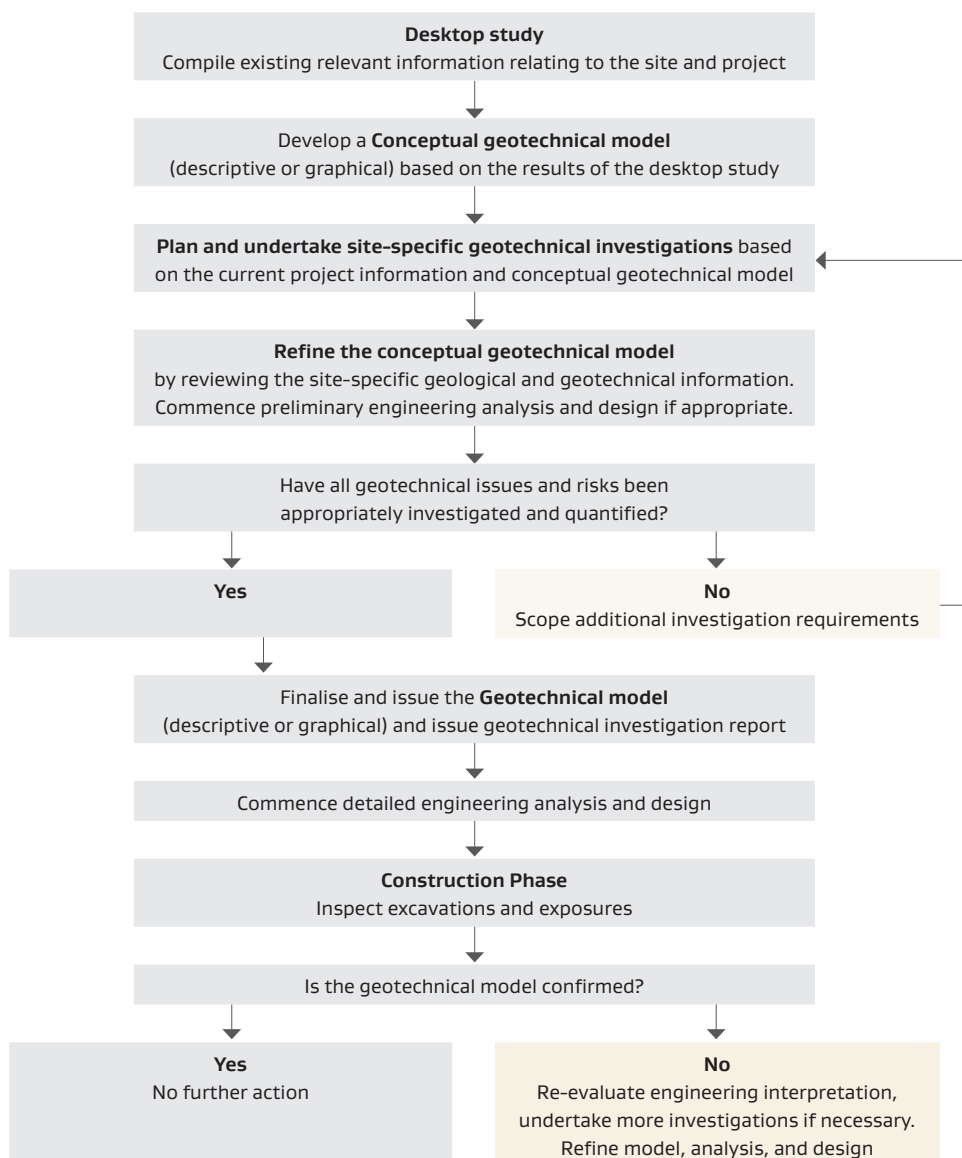

2.3.1 DESKTOP STUDY

A desktop study is normally undertaken at the start of a geotechnical site investigation programme to collate and analyse relevant existing information about the site, its geological setting and its surroundings. It is often appropriate to complete a site walkover as part of the desktop study programme, in particular in areas of complex geotechnical conditions, or where there is a lack of existing information.

The main purpose of the desktop study is to develop an understanding of the likely ground conditions, the geological setting and geomorphology, and to guide the scope of the subsequent site-specific investigations.

Potentially relevant data sources for the desktop study phase are listed below, noting that the components of a desk study will vary depending on the nature of the site, location, project scale and objectives:

- 1 geological and geomorphological maps and reports, previous geotechnical investigation reports, or published literature pertaining to the site and surrounding vicinity
- 2 existing hazard maps (ie liquefaction, flood, tsunami, etc.)
- 3 the national fault database
- 4 the New Zealand Geotechnical Database and other geotechnical databases
- 5 well or bore records

- 6 maps, photographs (including historical and recent aerial photographs) which may show topographic/geomorphic features such as swamps or creek lines which have been subsequently obscured by human activities, fault-like lineaments etc.
- 7 survey plans
- 8 published soils maps (eg Landcare S-Maps)
- 9 property file records
- 10 service plans and records
- 11 contamination maps or Hazardous Activities and Industries List (HAIL)
- 12 previous local and anecdotal experience from the area
- 13 historical records such as newspaper articles
- 14 construction records for nearby projects
- 15 local knowledge.

A review of the local, regional and national hazard maps and historical information should be completed in the early stages of the desktop study.

2.3.2 SITE WALKOVER

As part of the desktop study, it is recommended that the geotechnical professional complete a physical walkover of the site. This will aid in developing a better understanding of the site and its environs and may help reduce the likelihood of unanticipated geotechnical issues. Observations made during the site walkover can greatly inform the development of the preliminary site model and hence the planning of the site investigation.

2.4 Site Investigation Planning

Site investigations are carried out for a variety of purposes including:

- › site selection, or assessment of the overall stability and general suitability of a site for the proposed development
- › site screening for active faults
- › assessment of the suitable positioning and alignment of the proposed structures with regard to geotechnical constraints
- › assessment of liquefaction and lateral spread potential, and any other relevant geotechnical issues such as the presence of compressible deposits or other problematic soils
- › assessment of possible foundation options and associated design constraints for a site
- › evaluation of the possible effects of proposed works on surroundings, such as neighbouring buildings, structures and sites
- › investigation of unsatisfactory in-service performance
- › assessment of repair strategies
- › assessment of site sub-soil class and/or shear wave velocity (eg V_{s30})
- › identification of borrow areas/cut/fill and consider the effect of any proposed earthworks on the site or adjacent land
- › assessment of potential variations in groundwater levels.

The purpose and objectives of the site investigation should be carefully considered when planning the scope of the works to be undertaken.

Following completion of the desktop study, the geotechnical professional should have sufficient information to plan the site investigation programme. The investigation methods, sampling requirements, and types and frequency of field tests to be performed should be determined based on the existing subsurface information, project design requirements, the availability of equipment, and local best practice.

The geotechnical professional should develop the site investigation plan to obtain the data needed to define subsurface conditions and enable engineering analyses and design. As part of a site investigation, a geologist/engineering geologist

can often provide valuable input regarding the type, age and depositional environment of the geologic formations present at the site for use in planning and interpreting the site conditions. Understanding these geologic characteristics is important (eg in helping to assess the liquefaction potential, or potential slope instability) and can help refine the site investigation.

For most residential and many commercial projects, the site investigation can be completed in one phase. For larger projects, it may be beneficial, or even necessary, to carry out the investigation in stages so that the geotechnical model can be reviewed following the initial investigation. Further investigation can then be carried out to target key areas of geotechnical risk or uncertainty that have been identified during earlier phases of investigation.

Regardless of the number of site investigation stages, sufficient data should have been gathered at the end of the overall investigation programme to appropriately assess the relevant geotechnical hazards. These would be identified to a level appropriate to the project stage and allow data interpretation to be carried out with a minimum number of assumptions.

2.4.1 SPECIFICATION AND PROCUREMENT OF SITE INVESTIGATION SERVICES

For geotechnical investigation projects in general, but particularly for larger projects, it is important to clearly identify the investigation methods to be used. It is also important to procure the services of a ground investigation contractor who has the experience and capability to obtain high quality data and perform the work in an efficient, safe and consistent manner.

The New Zealand Ground Investigation Specification developed by the Auckland Council (2017) in partnership with EQC, MBIE, NZGS and New Zealand Drillers Federation contains detailed information on numerous aspects of specifying and procuring ground investigations including contractor qualifications, cost, standards, health and safety and contractor selection.

2.4.2 TYPES OF INVESTIGATION

2.4.2.1 Site Mapping

For many projects, it will be useful (and often necessary) to study and map the geology and geomorphology of the site and its surroundings in the field. This work is normally done by an engineering geologist.

Important information about a site and its geological setting can be obtained from:

- › inspection and logging of exposures of rock and soil
- › examination of landforms and active processes
- › considering how these might affect the site and any proposed development of the site.

2.4.2.2 Shallow Investigation and In situ Testing

Shallow investigations are often carried out:

- › for initial site screening purposes
- › for static design purposes for small structures
- › for fault studies
- › in areas of thin soil cover
- › as a complement to deep investigations.

Methods include test pits/trenching, hand augers, Scala penetrometer testing, and shear vane testing.

2.4.2.3 Deep Investigation and In situ Testing

Deep investigation refers to methodologies that assess the characteristics of the deeper soil profile in situ; sometimes complimented by sampling and laboratory testing. The most common deep investigation methods in New Zealand are:

- › cone penetration test (CPT)
- › machine-drilled boreholes with standard penetration test (SPT).

Other less common deep methods include:

- › heavy dynamic probe (HDP)
- › Swedish weight sounding (SWS)
- › Marchetti dilatometer test (DMT) — also known as the flat plate dilatometer test.

2.4.2.4 Disturbed Sampling

Disturbed samples (further discussed in Section 3.2.4) are generally obtained to determine index properties of soils, the soil type, gradation, classification, plasticity index, consistency, minimum and maximum density, natural moisture content, presence of contaminants and the like. Disturbed samples from deep geotechnical

investigation are typically recovered from machine-drilled boreholes. Other methods for obtaining disturbed samples include hand excavation or augering, window sampling, and collection of materials from machine-excavated test pits. Samples recovered from any of these methods, including drilling, are considered 'disturbed' because the sampling process modifies the in situ structure and density of the soil.

2.4.2.5 High Quality ('Undisturbed') Sampling

High quality samples (further discussed in Section 3.2.4) are used to assess the in situ strength, compressibility, natural moisture content, unit weight, permeability and stratigraphy of subsurface soils. High quality ('undisturbed') samples are typically recovered from machine-drilled boreholes using specialised samplers, and though such samples are designated as 'undisturbed', in reality they are disturbed to varying degrees.

The degree of sample disturbance depends on the soil, type and condition of the equipment used, the skill of the drillers and the storage and transportation methods used. As discussed in Section 3.2.4, significant and potentially costly inaccuracies may be introduced into the geotechnical design if appropriate care is not exercised during recovery, transport and storage of undisturbed samples.

2.4.2.6 Geophysical Testing

Geophysical information can be used to help identify macro changes in subsurface stratigraphy, as well as assess dynamic elastic properties of the soil. In particular, a profile of shear wave velocity (V_S) is required for assessing the site-specific response of the ground to earthquake shaking. V_S can also be used to estimate soil stiffness for use in assessing liquefaction potential. Compression wave velocity (V_P) is useful to determine the depth to full soil saturation.

Shear wave testing in New Zealand (refer to Section 3.4) includes:

- › multi-channel analysis of surface waves (MASW)
- › seismic refraction (SR)
- › down-hole and cross-hole testing (using CPT/boreholes)
- › horizontal/vertical spectral ratio testing (H/V).

Other geophysical methods used in New Zealand include ground penetrating radar (GPR) and electrical resistivity surveys (ER).

2.4.3 SPACING OF INVESTIGATION POINTS

The final number and spacing of intrusive investigation points will depend on:

- › anticipated variation in subsurface conditions across the project site
- › type of structures proposed
- › phase of the investigation being performed
- › availability of existing data.

The primary objective of the site investigation is to confidently characterise the subsurface conditions at the specific location(s) of the proposed development. Therefore, the arrangement and proximity of investigations across the project site can be as important as the minimum investigation density criteria. For preliminary investigation of a large site, a relatively wide spacing of investigation points may be acceptable; particularly in areas of known uniform subsurface conditions. For detailed design, involving a highly variable site, closely spaced investigations are likely to be required. Generally, a plan change or subdivision consent would require fewer, more widely spaced investigations while an investigation for detailed design or building consent would require reasonably closely spaced investigations (eg several within each building footprint).

Comment

Non-intrusive investigations can supplement intrusive investigations, but in most circumstances are not an appropriate substitute for intrusive investigations.

Subsurface investigation programmes, regardless of how well they may be planned, must be flexible enough to adjust for unexpected or significant variations in subsurface conditions that are encountered during the field work. The geotechnical professional should be available to confer with the field personnel during the investigation. On critical projects, the geotechnical professional should periodically observe the field investigation.

2.4.3.1 Plan Change or Subdivision Consent Applications

Table 2.1 below has been developed based on the MBIE guidance document for rebuilding residential buildings in Canterbury³. It presents the minimum number of geotechnical site investigations recommended for different sized locations when applying for a Plan Change or Subdivision Consent.

Table 2.2 gives some guidance on which area of the development that needs to be included in the investigation.

Comment

Each project site should be assessed on its own merits when planning an investigation. It is possible that a greater investigation intensity than recommended in Table 2.1 will be required to adequately characterise the ground conditions.

Table 2.1: Recommended Minimum Deep Geotechnical Investigation Intensity¹ for Plan Change or Subdivision Consent Applications

PROJECT STAGE	RECOMMENDED MINIMUM CUMULATIVE NUMBER OF DEEP INTRUSIVE GEOTECHNICAL SITE INVESTIGATION LOCATIONS ¹			
	SITE PLAN AREA ²			
	MORE THAN 10 HECTARES	1 TO 10 HECTARES	GREATER THAN 2,500 M ² BUT LESS THAN 1 HECTARE	2,500 M ² OR LESS
PLAN CHANGE	11 plus additional 1 per 4 hectares (or part thereof) of site area in excess of 10 hectares	6 plus additional 1 per 1.8 hectares (or part thereof) of site area in excess of 1 hectare	4 plus additional 1 per 3,750 m ² (or part thereof) of site area in excess of 2500 m ²	1 per 625 m ² (or part thereof) of site area
SUBDIVISION CONSENT	26 plus additional 1 per 0.5 hectares (or part thereof) of site area in excess of 10 hectares	6 plus additional 1 per 0.45 hectares (or part thereof) of site area in excess of 1 hectare		

1 In addition to the number, the spatial arrangement of investigations should be such that the site is adequately characterised.
 2 In areas where there is insufficient groundwater information, piezometers should also be installed at a density sufficient to adequately determine the depth to groundwater (eg 1 per 5 deep investigation locations), particularly for potentially liquefaction prone land.
 3 Repairing and Rebuilding Houses Affected by the Canterbury Earthquakes, MBIE Guidance, Version 3, December 2012

Table 2.2: Recommended minimum extent of deep geotechnical investigations for Plan Change or Subdivision Consent Applications

PROJECT STAGE	DEVELOPMENT SCENARIO	RECOMMENDED MINIMUM EXTENT OF DEEP INVESTIGATIONS 'SITE PLAN AREA' IN TABLE 2.1
PLAN CHANGE	Sparsely populated rural area (lot size more than 4 Ha) eg Change of rules to allow increasing intensity of land use, buildings and population	Only the parts of the land where intensification of land use or buildings (and supporting services and access) is proposed ^{1,2}
	Rural-residential setting (lot size of 1 to 4 Ha) eg Change of rules to reduce the minimum lot size for a residential dwelling	
	Small-scale urban infill (original lot size less than 2500 m ²) eg Relaxing minimum lot size limits in a residential area near the CBD to promote intensification	All land for which plan change is proposed
	Commercial or industrial development e.g. Rezoning urban fringe land from rural to business zoning	
	Urban residential development (typically 15–60 households per Ha) eg Rezoning vacant industrial land from business to residential zoning	
SUBDIVISION CONSENT	Sparsely populated rural area (lot size more than 4 Ha) eg Subdividing a farm into two and converting both to more intensive agricultural use	Only the parts of the land where intensification of land use or buildings (and supporting services and access) is proposed ^{1,2}
	Rural-residential setting (lot size of 1 to 4 Ha) eg Subdivision of an orchard for a 'lifestyle property' development	
	Small-scale urban infill (original lot size less than 2500 m ²) eg Subdividing a large inner city lot into four smaller lots	All land for which subdivision is proposed. Includes redefined lots housing existing buildings, as well as new vacant lots
	Commercial or industrial development eg Subdividing greenfield land to develop an industrial park	
	Urban residential development (typically 15–60 households per Ha) eg Subdividing brownfield land for new urban housing area	

- 1 If the extent of investigation is limited to the specific area where development is proposed then this should be made clear in the geotechnical report and consent application, and it may be appropriate for this to be incorporated as a condition of consent. If the development extent subsequently changes, then additional investigations and assessment will be required if the previous investigations do not adequately characterise the ground conditions.
- 2 If the final development extent is unknown, then investigations should cover the full extent of land where intensification of land use or buildings (and supporting services and access) is possible in future.

2.4.3.2 Detailed Design or Building Consent Application

Appropriate site-specific investigations should be incorporated into the detailed design phase of any new development. The primary purpose of site-specific investigation is to obtain the information required to enable detailed design of the structure(s) and earthworks, and to support the geotechnical aspects of building consent application (eg to confirm whether liquefiable soils, expansive soils, peat deposits or other potentially adverse geotechnical conditions are present).

Site-specific investigations for earthquake geotechnical engineering assessment typically require a combination of both deep (eg 10 m +) and shallow investigations (refer to Section 2.4.4). Table 2.3 summarises the recommended minimum number of intrusive geotechnical investigations recommended for detailed design or building consent application for typical IL2 residential and commercial building developments.

These investigation densities are the starting point for determining investigation requirements for typical situations — in many cases however there will be a need to increase the investigation density. The required density of site investigations will often need to be greater than those in Table 2.2 for structures that:

- › are greater than three stories in height
- › contain a deep basement
- › have a high variability of foundation loads across the structure footprint
- › have complex footprint geometry
- › are highly sensitive to foundation deformations.

The number of geotechnical investigations may also need to be increased to account for all relevant geotechnical issues and hazards present on a site, or for sites/projects that:

- › have highly variable (laterally or vertically) ground conditions
- › have a significant depth of earthworks
- › include retaining structures.

In all cases, the level of investigation/investigation density and spatial arrangement should be that which is necessary to adequately characterise the ground conditions for the intended project, and enable the appropriate level of geotechnical analysis.

In some cases (eg house structures or IL1 buildings) where ground conditions are reasonably well known, it may be acceptable to substitute a more robust foundation solution for increased deep investigations that might be required to rule out a particular hazard — in other words, assume the hazard is present and design for it.

Table 2.3: Recommended Minimum Density of Intrusive Geotechnical Investigation Locations for Detailed Design/Building Consent Application

INVESTIGATION TYPE	BUILDINGS UP TO IMPORTANCE LEVEL 3 ¹ AND UP TO 3 STORIES HIGH AND WITH A GROUND FLOOR AREA		
	LESS THAN 1000 M ²	GREATER THAN 1000 M ² BUT LESS THAN 2500 M ²	GREATER THAN 2500 M ²
DEEP INVESTIGATION ^{2,4,5}	Deep investigation (refer to Section 2.4.4) should be undertaken at no less than 2 locations within or immediately adjacent to the proposed building footprint	Deep investigations should be undertaken at no less than 2 locations within or immediately adjacent to the proposed building footprint, plus an additional 1 location/500 m ² of building footprint in excess of 1000 m ²	Deep investigations should be undertaken at no less than 5 locations within or immediately adjacent to the proposed building footprint, plus an additional 1 location/1500 m ² of building footprint in excess of 2500 m ²
SHALLOW GEOTECHNICAL INVESTIGATION ^{3,4,5} (taken in addition to the number of deep investigations required)	Shallow geotechnical investigations (refer to Section 2.4.4) should be undertaken at no less than 2 locations within or immediately adjacent to the proposed building footprint	Shallow geotechnical investigations should be undertaken at no less than 2 locations within or immediately adjacent to the proposed building footprint, plus an additional 1 location/500 m ² of building footprint in excess of 1000 m ²	Shallow geotechnical investigations should be undertaken at no less than 5 locations within or immediately adjacent to the proposed building footprint, plus an additional 1 location/1500 m ² of building footprint in excess of 2500 m ²

- 1 For structures such as IL4 buildings, dams, bridges, port works, canals, etc, a higher degree of investigation will be required.
- 2 See commentary in section 2.4.4.2 regarding the need for deep investigations
- 3 If deep investigations have been justifiably ruled out, then the number of shallow investigation points should be doubled
- 4 Not to be substituted for higher levels of investigation if required by other standards or local authority requirements
- 5 In addition to the number, the spatial arrangement of investigations should be such that the site is adequately characterized.

Comment

Information from historical, site-specific geotechnical investigations can form part of the minimum investigation, providing such data is confirmed to be both adequate and relevant.

Comment

For larger projects or more complex ground conditions, it can be particularly effective to combine CPT with machine boreholes and sampling to allow laboratory testing and development of more refined correlations between soil properties and in situ test results. An example of this would be the use of laboratory testing to correlate actual soil plasticity and fines content with the CPT-based estimates. In this situation, a borehole/CPT pair should be considered as one deep investigation location.

2.4.4 DEPTH OF INVESTIGATION

The depth of site investigation depends on:

- › type and nature of the structure(s)
- › anticipated nature of the subsurface materials (including variability in stratification)
- › anticipated geo-hazards
- › foundation loads and types
- › influence zone for the foundation being considered
- › earthworks proposed
- › type of analyses to be undertaken.

2.4.4.1 Shallow Investigations

The primary purpose of a shallow investigation programme is normally to assess the geotechnical bearing capacity of the subgrade materials within the primary zone of influence of slab-on-grade and lightly loaded shallow foundations. It can also be used to characterise the conditions anticipated for relatively shallow earthworks and provide a check on the existing fill depths or the presence of organics or

topsoil. A shallow investigation programme would typically comprise some combination of hand auger holes, Scala penetrometer tests (sometimes called 'dynamic cone' or DCP testing) and/or test pits.

The depth of the shallow geotechnical investigations should typically:

- › extend a minimum of 3.0 m below the existing ground surface
- › extend a minimum of 1.0 m into natural ground
- › extend a minimum of 1.0 m below the zone of influence of the proposed foundation system and at least twice the footing width
- › enable visual assessment and confirmation of the soil type and strength/density.

Shallow investigations will not enable characterisation of liquefaction potential on a site.

Where there is a need to extend the investigation deeper than 3 m, the use of these methods can become impractical.

Comment

The Scala Penetrometer was originally developed for testing pavement subgrade (Scala, 1956). Over time, it has become a common tool in New Zealand practice for shallow site investigation and assessing the bearing capacity of shallow foundations. As such, it is sometimes used to depths of 3 m or more. The use of the Scala is not recommended below a depth of 2 m, (or shallower in materials with a California Bearing Ratio — CBR > 15) where inertia effects, side friction on the rod and other energy losses are likely to influence the results (Paige-Green, Du Plessis; 2009). Clearing each metre increment with a hand auger, after the first metre of penetration, will reduce some of these effects. Energy also can be lost through compression of the Scala rod, elastic compression of the soil and various other unknown factors.

The use of the Scala penetrometer alone will not identify important geotechnical issues such as buried topsoil horizons, organic soil/peat layers, fill, expansive soils, etc. Therefore, it is recommended that such testing is always accompanied by boreholes or test pits to visually confirm whether these materials may be present.

2.4.4.2 Deep Investigations

Deep investigations (eg CPT or machine-drilled borehole) are typically required on sites where there is a suspected geo-hazard such as potentially liquefiable soils, thick, soft soil deposits or slope instability. They are also required where large or deep foundations are being considered (for heavy or concentrated loads, scour, uplift etc.). A liquefaction assessment for a single-family house or a one-storey commercial building with a small footprint may only require CPTs or boreholes to a depth of 10 to 15 m, as soil behaviour below this depth is unlikely to impact the structure in most cases. A similar assessment for a large commercial or critical facility structure, with heavy foundation loads, would typically require investigation to a depth of at least 20 to 25 m.

The depth of site investigation must be assessed and confirmed by the geotechnical professional on a case-by-case basis, after due consideration of the relevant site-specific geotechnical issues, including:

- › the site geology, hydrogeology and stratigraphy
- › the depth and extent of any critical sub-surface layers (eg liquefiable layers which may result in ground surface damage or impact foundation support)
- › the type and configuration of the proposed development/structures
- › the stage of the project development
- › the type, capability and reliability of the available investigation equipment.

Comment

Intrusive investigation to a depth of greater than 25 m is unlikely to be required for most typical IL2-type building projects. However, in some cases (ie for large heavy structures located in soft ground, large-diameter tanks, large dams, etc.), investigations may need to extend to significantly greater depths. Accurate shear wave velocity profiling for a site-specific ground response analysis may also require deeper investigation.

The following guidance is provided to assist with determination of depth of investigation:

- › In the absence of a potential geo-hazard requiring deeper investigation, the depth should, if possible, extend to at least the depth of influence of the foundation type(s) being considered for the proposed development for:
 - shallow pad or strip foundations, the depth should be in the order of two to four times the foundation width
 - mat and raft foundations, the depth of influence can be significant but the increase in effective stress relatively small depending on the magnitude of loading (judgement should be used to determine the depth of investigation considering the foundation plan dimensions and loads and the soil conditions anticipated)
 - pile foundations, the minimum depth should extend a minimum of 5 pile diameters below the anticipated pile tip elevation, with a minimum of 2 m penetration below the pile tip.
 - closely spaced piles, pile group effects to be considered — the depth of influence is two-thirds the depth of embedment of the piles, plus 1.5 times the width of the pile group.
- › When assessing liquefaction potential, the minimum depth of investigation should extend to the depth at which the liquefied soils are unlikely to have a consequential impact on the proposed development (eg foundation design or distortion of ground surface). For shallow foundations supporting lightweight structures, this can be in the order of 10 to 15 m. For heavily loaded or pile foundations, or for situations where total ground surface settlement may be a design issue (eg for assessing flooding potential), the investigation may need to extend to a depth of 20 m or more.
- › To the extent practical, a deep geotechnical investigation should not terminate within potentially problematic soils (ie liquefiable soils, peat, soft or organic silts and clays), or within a unit which is known to overlie problematic soils.

Comment

Field evidence from the Kobe and Loma Prieta earthquakes has shown that liquefaction may occur at depths of up to 20 m (Murashev, et al, 2014). For most typical projects, liquefaction below a depth of 20 m can be considered unlikely to have significant impact at the ground surface (for level ground conditions and excluding earth dams and reclamations). If deep piles are anticipated however, liquefaction below the pile base should be considered. Refer to Module 3 for further discussion regarding uncertainties in assessing liquefaction triggering at depth.

Shallow refusal of a CPT sounding is not necessarily proof that the base of all liquefiable layers has been identified. CPT, particularly when pushed with rigs having less than 15T push capacity, can refuse on thin but relatively dense gravel/sandy gravel layers. In alluvial plain deposits (for example those found in Canterbury and Hawke's Bay), this is a common occurrence. To overcome the problem of CPT refusal in interlayered but potentially liquefiable deposits, it may be necessary to either pre-drill (for example in the case of a shallow dense layer) or switch over to machine boreholes and SPT sampling. If pre-drilling followed by CPT is used, the liquefaction potential of any loose/medium dense soils drilled through should still be assessed utilising SPT.

An investigation may be terminated at a depth less than that recommended above if the geotechnical professional deems such investigation has proved the presence of bedrock or thick deposits of material which are known to be non-liquefiable and otherwise stable. The presence of such material should be proved for a continuous thickness that is appropriate to both the anticipated loading conditions and materials encountered.

Comment

When performing CPT investigation, it is often possible to extend the depth of investigation several metres for only a marginal increase in cost, and this may result in decreased design risk.

2.5 Standards and Guidelines

Site investigation for earthquake geotechnical engineering should be performed in accordance with applicable New Zealand standards and guidelines or, in the absence of these (for example, for SPT and CPT testing), an appropriate international standard. Local best practice, where appropriate, should also guide investigation techniques.

For liquefaction assessment, the use of ASTM investigation standards is generally recommended as these are often the basis for data that is relied upon in semi-empirical analysis methodologies. They are already widely used in New Zealand and are periodically updated. For the CPT, there are other test standards such as EN ISO 22476-1 (2012) and International Reference Test Procedure that are published by the International Society for Soil Mechanics and Geotechnical Engineering (IRTP, 1999) which may be useful.

Note: several of the international standards referenced herein are periodically revised/updated, hence it should be routinely confirmed that the appropriate version of a given investigation/test standard is being used.

It is important that the site investigation be performed using the appropriate equipment and an accepted testing standard to obtain repeatable and accurate results. Whichever standard is used,

Comment

In some cases, particularly where advanced techniques or research-level technologies are being used, specialist technical knowledge may result in the normally applicable laboratory or field-testing standards not being followed. In such cases, the methods or procedures used should be clearly documented in any reporting of results.

the standard procedures should always be followed. Deviation(s) from the standards may sometimes be required, but these should be minimised and clearly documented to allow the design engineer to assess the potential effects of the deviation(s). Incorrect procedures or improvisation of investigative techniques may result in erroneous or misleading results and potentially lead to an incorrect interpretation of the field data.

2.6 Data Collection and Record Keeping

Records should be kept for all site investigation tasks; particularly for field tests or measurements such as CPTs, SPTs and groundwater level measurements. The records should reference the project, date, location and results of the field task.

Geotechnical logs and records should be compiled for the investigation, in accordance with the recommendations outlined in the latest edition of the NZGS field classification and description guideline (NZGS, 2005).

Original laboratory test sheets which contain recorded test data and other items, such as the laboratory technician's observations of sample condition and behaviour during testing, should also be maintained.

It is very useful if records of field investigation results and laboratory testing are maintained in a form suitable for archiving and information transfer, ideally in a digital form. As outlined in Section 2.7, all such data should be uploaded to the New Zealand Geotechnical Database (NZGD).

2.7 New Zealand Geotechnical Database

The New Zealand Geotechnical Database (NZGD) is a searchable web-based repository for both existing and new geotechnical information. This enhances data management efficiency and, in areas where sufficient data density has been achieved, allows more accurate planning of site investigations (as likely ground conditions will be known in advance). It also allows early stage project planning implications such as high-level assessments of location and preliminary assessment of likely foundation solutions.

The NZGD is becoming, over time, a valuable resource. It was originally developed as an enhancement from the Canterbury Geotechnical Database (CGD), which was created to assist the rebuild of greater Christchurch following the 2010–2011 Canterbury Earthquake Sequence. The CGD proved to be a great collaborative success, which led to MBIE in a funding partnership with EQC expanding it in 2016 to take national data, so that the benefits can be similarly applied across the entire country.

The advantages of having a fully matured and populated database are obvious, in engineering and land use planning, as well as the development and construction sectors (and the many other sectors they serve). Natural disaster recovery, the resilience of New Zealand’s built environment, catastrophe loss modelling and regulatory processes can all be enhanced.

With the ongoing support of the private and public sectors, and ethical behaviour of all data users, the data set will grow over time and the benefits of the NZGD will progressively increase. Refer also to Section 5.1.1 for more discussion on geotechnical data and the NZGD.

The range of data types and total data points held in the NZGD as at October 2020 are shown on Figures 2.2 and 2.3 below.

Comment

It is a condition of the NZGD terms of use that data users also upload any data that they gather from subsurface investigations after obtaining client permission. Therefore, the geo-professional must ensure that any data gathered in a site investigation programme is promptly uploaded to the NZGD.

Comment

In order to maintain the integrity of the data on the NZGD, it is important that any data that is uploaded has been subject to a reasonable level of Quality Assurance and Quality Control (QA/QC) — this is especially so if the task of uploading data has been delegated to inexperienced staff, or to the site investigation contractor. The NZGD system carries out only a high-level screening process on a small sample of the data being uploaded, hence data quality is highly dependent on the QA/QC processes adopted by the system users.

If any data errors are encountered please contact NZGD Support and request that these errors are addressed.

Figure 2.2: Count of NZGD data by type

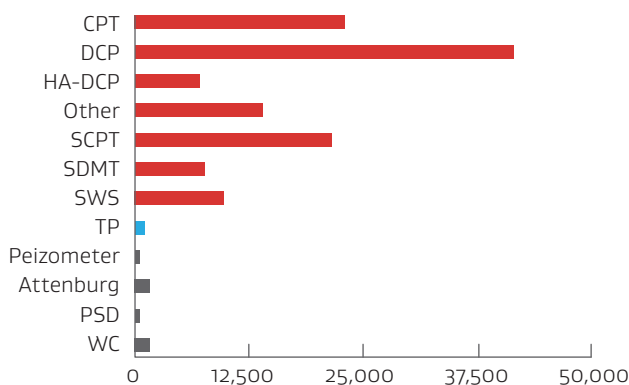
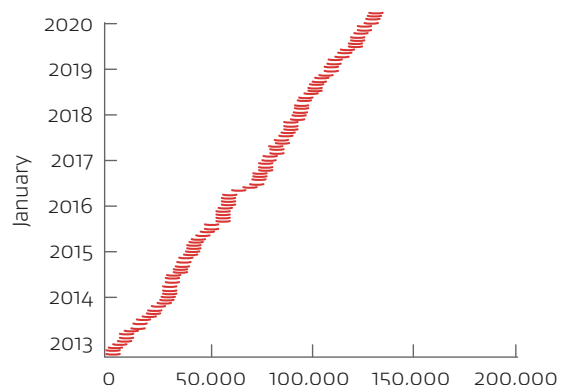

Figure 2.3: Cumulative count of NZGD data uploads



2.8 Health and Safety

By law, all geotechnical site investigation activities should comply with relevant work health and safety legislation. In many cases such compliance will incorporate site-specific risk assessment and work method statements. All persons who are involved in a geotechnical site investigation program, in particular the geotechnical professional and owner, should confirm that the health and safety risks have been assessed and that appropriate mitigation measures are implemented prior to commencing any physical site works.

Common risks in a geotechnical investigation include, but are not necessarily limited to:

- › buried and overhead services
- › heavy machinery
- › moving or rotating machinery
- › high pressure hydraulics
- › excavations
- › noise
- › traffic
- › environmental contamination
- › dust
- › fall from heights
- › weather.

Ground contamination is an environmental engineering issue, not a geotechnical engineering issue. However, the risk that part or all of any subject site contains contaminated land needs to be considered. The quantity of existing information available to help identify contaminated land sites can vary considerably within different regions of New Zealand. At the desk study phase, the relevant territorial authority maps and file records should be reviewed to identify any known potential contamination hazard at the subject site.

The issue of contaminated land is beyond the scope of this document; however, a wide range of contaminants may be present in the ground as a result of either current or historic land uses. For this reason, the following general guidance is provided.

Common site contaminants include:

- › asbestos
- › agrichemicals (pesticides, herbicides, and fungicides)
- › heavy metals and metalloids (lead, copper, arsenic etc.)
- › hydrocarbons (fuels, oils and greases)
- › solvents
- › bacteria and/or viruses
- › sewerage.

If contamination is observed in the field, an investigation should be halted until appropriate specialist advice has been obtained, and health and safety procedures implemented. Machinery and tools should remain on site in order to prevent the potential spread of contamination.

3 Site Investigation Methods



The methods to be deployed during a geotechnical site investigation program should be carefully considered and selected, taking due account of the following issues:

- › the objectives of the investigation
- › the ground conditions likely to be encountered
- › availability of equipment/expertise and associated limitations (eg CPT push capacity, purpose-built geotechnical drilling rigs with appropriate tooling for anticipated ground conditions)
- › site access limitations (eg boggy ground, low overhead clearance)
- › cost and time constraints
- › health, safety and environmental considerations; and
- › regulatory requirements.

The two most commonly used in situ tests for soils in New Zealand are the Cone Penetrometer Test (CPT) and the Standard Penetration Test (SPT). The CPT is often more economical and provides more continuous data than SPTs. However, the drilling and sampling associated with SPT provide soil samples for visual assessment and laboratory testing, and are able to penetrate dense soil/gravel layers that might cause refusal in a CPT.

Comment

For acquiring data for the assessment of liquefaction potential using the simplified triggering procedures, the two primary investigation methods that should be used are CPT, and SPT (if CPT is not feasible). Shear wave velocity testing may be used to compliment liquefaction investigations, or to help assess liquefaction potential of gravel deposits; however, it has been shown in Christchurch (in sandy/silty soils) to give inconsistent results relative to the CPT when using the *simplified liquefaction triggering procedures* (EQC, in press). Currently, it is recommended that all other investigation methods should only be viewed as providing supplementary data.

The use of seismic testing (and other geophysical methods) to assess subsurface stratigraphy, soil stiffness, liquefaction potential, etc, is becoming more common in New Zealand. However, these alone will generally not be sufficient to adequately characterise the ground conditions (there are exceptions such as using seismic investigation to obtain V_{s30} for seismic hazard analysis). In situ seismic investigation and other geophysical testing should generally be viewed as being complimentary to an investigation by CPT or borehole.

Other testing technologies such as flat plate (or Marchetti) Dilatometer (DMT), dynamic probes, Swedish Weight Sounding (SWS), screw driving sounding (SDS) can be used to obtain supplementary subsurface data. However, for routine projects

it is recommended that CPT investigation, and/or boreholes with SPT (in combination with laboratory testing and/or seismic investigation) are the primary means of investigation.

Comment

It is not possible to use Scala penetrometer/dynamic cone penetrometer investigation data to assess liquefaction risk and consequences. Scala penetrometer results cannot be used other than for assessing the near surface consistency and giving an approximation of the static geotechnical ultimate bearing capacity for shallow foundation design, for small structures (only).

3.1 Cone Penetration Testing (CPT)

3.1.1 GENERAL

The CPT is the most common intrusive investigation method in many parts of New Zealand. This is because it is a relatively quick, economical method of exploring soils ranging from sands to clays.

Interpreted stratigraphy and strength characteristics are obtained as the CPT progresses and, because all measurements are taken during the field operations and there are no laboratory samples to be tested, considerable time and cost savings may be gained. However, the opportunity for visual classification of soils is lost. As samples are not taken, it is not possible to get more refined soil properties from laboratory testing.

The CPT in New Zealand should be conducted in general accordance with the latest version of the ASTM D 5778 test standard (Note: updated in 2020). Other testing standards may also be useful, as discussed in Section 2.5.

Comment

The CPT is a sophisticated investigation tool. This section provides an overview of some of the more important points, and the reader is referred to references such as Mayne (2007), Lunne et al (1997), Campenalla and Howie (2005) and Robertson and Cabal (2015) for more detailed information.

The test consists of hydraulically pushing an instrumented steel probe (penetrometer) into the ground at a constant rate of about 20 mm/sec and measuring the resistance to penetration. A variety of types of cone penetrometer rigs

are available, ranging from small units track or man-portable units that can be used for limited access sites, to large truck and track vehicles. Utilising a push system capable of generating 10 tonnes of force, a CPT can be completed to a depth of about 20 to 25 m in approximately 1 to 1-½ hours in medium dense/stiff soil. The standard cone penetrometer consists of a three-channel instrumented steel probe that measures:

- › cone tip resistance (q_c)
- › sleeve friction (f_s)
- › penetration porewater pressure (u_m)

It can contain up to five channels (ie data collection sensors).

Porewater pressure measurements are not always made; when they are, the CPT is referred to as a CPTu. Another common addition is one or two geophones that are used as part of a seismic CPT (sCPT) in order to obtain shear wave velocities.

The standard CPT penetrometer has a conical tip with 60° angle apex. The penetrometer is normally available in two standard sizes:

- 1 35.7 mm diameter body (10 cm² projected tip area, A_c) and 150 cm² friction sleeve (A_s)
- 2 43.7 mm diameter body ($A_c = 15$ cm² and $A_s = 225$ cm²).

Figure 3.1: Procedures and Components of the Cone Penetration Test (from Mayne et al. 2001)

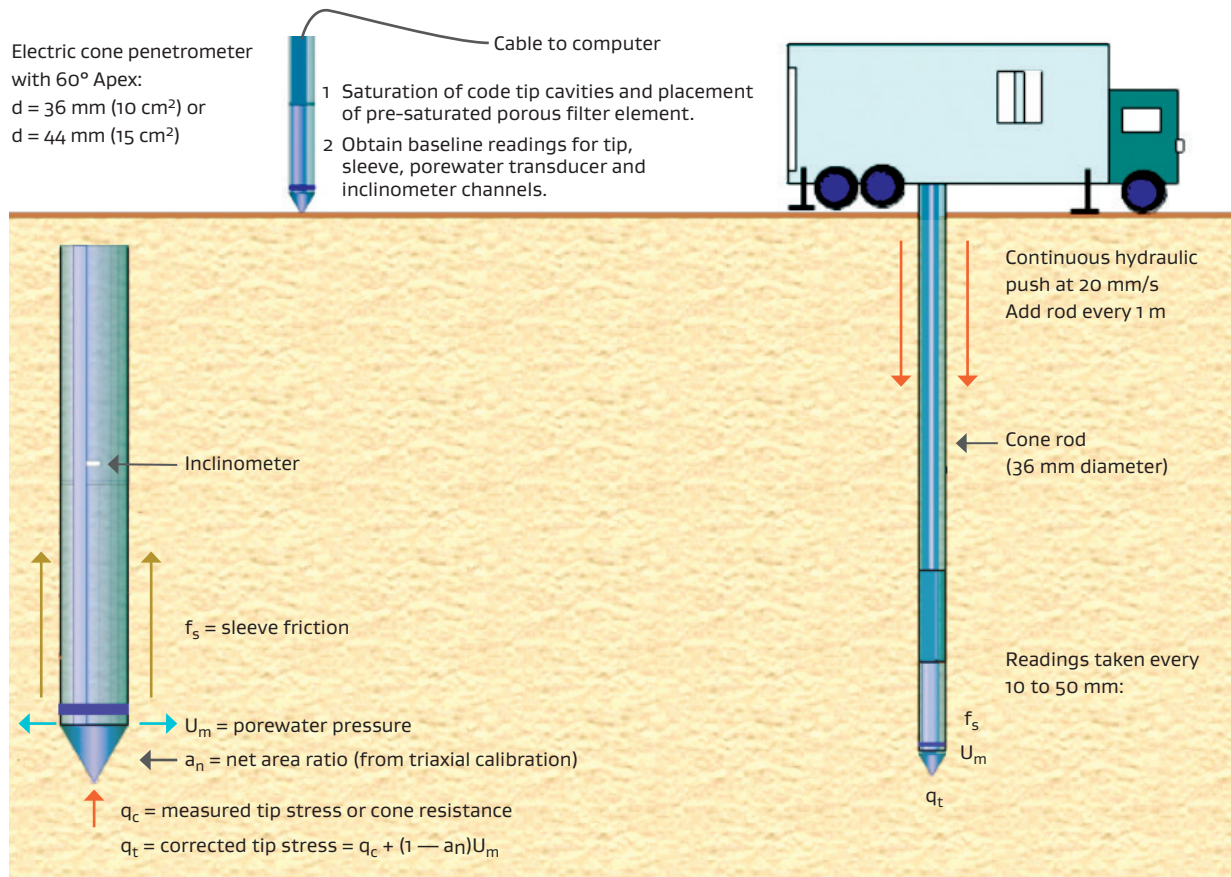

Some commercial operators have found the 15 cm² cone to be stronger for routine investigations and more easily outfitted with additional sensors for specific needs. As CPT push rods are normally 35.7 mm in diameter, the 15 cm² size cone also tends to open a larger hole, hence reducing rod friction during pushing. The larger cone has a lower sensitivity to the presence of thin layers than the smaller 10 cm² cone. The 15 cm² cone should yield essentially the same results as the 10 cm² cone, provided the friction sleeve has a surface area of 225 cm² to preserve geometric consistency. However, some manufacturers do not adhere to that requirement (ie sleeve surface areas can vary from about 200 to 300 cm²). Therefore, if a 15 cm² cone is to be used, the area of the friction sleeve should be checked to ensure the correct conversion factor is being used to report sleeve friction values.

A 'mini cone' with a 25 mm diameter body ($A_c = 5 \text{ cm}^2$, $A_s = 75 \text{ mm}$) is sometimes used for shallow investigations and in soft soils, due to increased measurement sensitivity of tip and sleeve friction.

Depending on the types of soils being tested, the porous filter for pore pressure measurement is located either:

- > at the apex or mid-face of the cone tip (Type 1)
- > at the shoulder (Type 2) just behind the tip
- > less commonly, behind the cone sleeve (Type 3).

These are sometimes referred to as u_1 , u_2 , or u_3 cones — however u_2 cones are the norm in New Zealand.

Specifications on the machine tolerances, dimensions and load cell requirements for electrical CPT penetrometers are outlined in the ASTM D 5778 test standard and in the international reference test procedure (IRTP, 1999).

An electronic data acquisition system records and processes the tip and sleeve resistance and pore pressure. The data is then used to generate continuous profiles of geostratigraphy, interpreted soil types, and various geotechnical parameters.

Because no drill spoils are generated, CPT is less disruptive and results in less clean-up than drilling. (As with conventional drilling, complications may still arise if a strongly artesian aquifer is penetrated.)

The continuous nature of CPT readings permit relatively detailed delineation of various soil strata, their depths, thicknesses and extent better than conventional mud rotary or auger drilling operations that rely on SPT or other sampler at 1 or 1.5 m intervals (noting also that some drilling methods such as sonic core drilling provide continuous core recovery and therefore a detailed delineation of the soil profile). In the case of assessments for piles that must bear in an established lower formation unit, CPT is often ideal for locating the pile tip elevations for installation operations.

In some ground conditions, such as dense gravels, CPT testing is often impractical because the penetrometer will not be able to be pushed without a high risk of damaging the penetrometer and/or breaking the push rods. Pre-drilling through the gravels, if at shallow depth, is often used to address this problem.

The CPT does not recover any soil sample and it relies on empirical relationships between the cone tip resistance and skin friction to estimate the soil type and behaviour (referred to as 'soil behaviour type'). To supplement the assessment of soil behaviour type, fines content and other soil properties inferred from the CPT data, fully sampled machine drilling can be used in conjunction with CPT to obtain samples for laboratory testing. CPT can also be used to broadly identify areas or layers of potential problem soils which can then be further investigated with drilling/laboratory testing. Due to cost, this is typically not done for smaller projects, but can be useful for larger and/or critical projects.

Comment

In Christchurch, it has been found that the CPT can sometimes under-predict the actual fines content in soils containing appreciable fines (ie silty sands, non-plastic/low-plasticity silts). This can result in an over-prediction of liquefaction triggering potential, and hence the potential impacts of liquefaction to a site/structure — sometimes markedly so. Under-prediction of the fines content can also lead to the selection of a ground improvement methodology that may not be appropriate, or may be less effective in mitigating liquefaction.

For sites where a significant liquefaction potential is identified from a CPT-based triggering analysis, it may be advisable to perform machine drilling and sampling adjacent to a representative number of the CPT soundings to confirm the actual fines contents (via laboratory testing) and develop a site-specific fines content correlation (Boulanger and Idriss, 2014). Site-specific correlation of soil properties can also be useful on soft soil sites — eg to refine shear strength or consolidation characteristics.

The frequency of CPT/borehole pairs required for such an exercise should be selected by the geotechnical professional using engineering judgement and general knowledge of soil variability in the site area. However, as a guide in the absence of previous site information of data in the immediate vicinity, one borehole per five CPT locations is likely to be adequate for large projects. Alternatively, for a small site with five CPT soundings and variable ground conditions, at least two boreholes may be needed to confirm the CPT correlations

Comment

CPT-based liquefaction triggering assessment of pumice-rich soils using common CPT correlations for soil strength and stiffness tend to underestimate the liquefaction resistance of such soils (Orense and Pender, 2013, 2015). All of the commonly used CPT empirical data is from quartz-derived soils and it is recognised that such soils often have quite different behaviour relative to pumiceous soils. This is because penetration resistance can be used as a proxy for density in silica-based sands — however, pumiceous soils are crushable and therefore density, stiffness and strength cannot be reliably estimated from penetration resistance. Similar issues may arise with other non-quartz derived soils such as micas and feldspars.

For such soils, cyclic testing of high-quality soil 'undisturbed' samples is considered the most robust method to assess liquefaction triggering potential (Orense et al. 2020).

Appendices A and B provide detailed discussions of CPT data accuracy, and some commonly encountered problems and errors encountered during CPT operations and data processing. Appendix C contains a series of field checklist items that both operators and geotechnical professionals may find useful when conducting routine CPT soundings.

3.1.2 CPT RESOLUTION/ACCURACY

Cone penetrometers are typically matched to the push capacity of the thrust machine being used, to allow penetration into a wide range of soil conditions. In New Zealand practice, the typical measuring range for q_c is 0 to 100 MPa for cone penetrometers with cross-sectional areas of 10 cm². (The ability to reach this stress level, however, is dictated by the push capacity of the rig. It is also usual for the test to be terminated at lower stress levels in any case to avoid damaging the penetrometer or push rods). Nominal ranges as low as 7.5 MPa are available.

The accuracy of most well-designed, strain-gauged load cells is 0.1 percent of the full-scale output (FSO). Hence, a 100 MPa cone would have an accuracy for q_t of around 0.1 MPa (100 kPa). In many sands, this would represent an accuracy of better than 1 percent. However, in soft, fine-grained soils, this may represent an accuracy of less than 10 percent. In very soft, fine-grained soils, low capacity cones (ie max. tip stress < 50 MPa) have better accuracy. A more detailed discussion of cone accuracy is presented in Appendix A.

The resolution of the data acquisition system is also important. A low (ie 12-bit) resolution analogue to digital (A/D) conversion system will result in 'stepped' readings with depth. In contrast, a 24-bit A/D conversion system would typically provide resolution at 1 N or 0.01 kPa or better, resulting in a very smooth data profile.

3.1.3 PORE PRESSURE MEASUREMENT

Although pore pressure measurements are commonly collected with the CPT (ie CPTu), the accuracy and precision of the cone pore pressure measurements (for on-shore testing environments) are not always reliable or repeatable. This is due to loss of saturation of the pore pressure element (Robertson, 2013). This problem can sometimes be reduced with very good equipment, procedures and well-trained operators.

Inaccurate pore pressure measurement potentially presents a problem when correcting measured tip resistance (q_c) to total tip resistance (q_t) in fine-grained soils — refer to Section 3.1.4. Nonetheless, Robertson (2013) recommends that pore pressure measurements be made for the following reasons:

- 1 any correction to q_t for unequal end area effects is better than no correction in soft fine-grained soils
- 2 dissipation test results provide valuable information concerning the equilibrium piezometric profile
- 3 penetration pore pressures provide a qualitative evaluation of drainage conditions during the CPT as well as assisting in evaluating soil behaviour type.

3.1.4 EQUIPMENT CALIBRATION/MAINTENANCE

As well as requiring well-trained, skilled and experienced operators to conduct CPT, cone penetrometers require calibration and maintenance on a regular basis. The regularity depends on the amount of overall use, and the care taken during storage between soundings. Data errors resulting from out-of-calibration or worn instruments can be significant. Adhere to the cone manufacturer's recommendations regarding calibration, maintenance and the frequency of both. The cone should also be recalibrated after every overhaul or repair. In most cases, the unit will need to be sent to the manufacturer for calibration. Calibration of cone and piezocone penetrometers is discussed in detail in several references, including Campanella and Howie, 2005; Lunne et al. 1997; Chen and Mayne 1994; and Mulabdic et al. 1990.

The CPT operator should maintain a log of the calibration, maintenance and routine operation of the cone penetrometer system. A current calibration certificate should be obtained for the specific cone used on any investigation, and a visual inspection of the cone (for damage or wear) is recommended. Each cone penetrometer should have a unique identification number. The log should list the recorded calibration values of the load cells for:

- › tip and sleeve readings
- › pore pressure transducer
- › inclinometer
- › any other sensors or channels.

The net area ratio (a_n) should also be listed for the cone being used as this is a particularly important calibration parameter.

The measured axial force at the tip of the penetrometer (F_c), divided by the projected tip area, equals the measured tip resistance, $q_c = F_c/A_c$. This stress should be corrected for pore water pressures acting behind the cone (depending on the cone design). The corrected tip stress or total cone tip resistance is commonly labelled q_t , and requires two prerequisites:

- 1 calibration of the particular penetrometer in a triaxial chamber to determine a_n
- 2 field pore water pressures to be measured at the shoulder position ($u = u_2$).

The determination of a_n should be performed by the cone manufacturer.

The total cone tip resistance is determined as:

$$q_t = q_c + (1 - a_n)u_2$$

Comment

In clean sands and dense granular soils, q_t is approximately equal to q_c , hence the correction is not critical. However, in soft to stiff clayey soils where appreciable porewater pressures are generated, the correction can be large — from 20 to 70 percent in some instances (Lunne et al. 1986; Campanella and Robertson 1988; Robertson 2013).

Before each test, the seals between different elements should be cleaned and inspected to ensure their integrity. The cone should also be cleaned and inspected.

Cone tip and sleeve wear can also result in potentially significant data errors. Published guidance regarding replacement of cone tips and sleeves varies. Mayne (2007) suggests that for a production rate of 60 m/day, used 4 days/week, an annual production of 12,000 m/year would likely require cone tip/sleeve replacement 1 or 2 times per year. The actual rate of replacement will depend on the soils tested, as sands and gravelly soils are considerably more abrasive than silts and clays.

Comment

In Christchurch, after the 2010–2011 earthquakes, thousands of CPT soundings were pushed in the following two years. Anecdotal evidence indicated that cone tips in particular, but also sleeves, required replacement about every 1,000 m of testing.

Other routine maintenance/inspection includes periodic cleaning of the penetrometer and rods, inspection of the electronic cables and power connections and removal of bent push rods.

A more detailed discussion of various types of common data errors is contained in Appendix B.

3.1.5 BASELINE READINGS

Before conducting an CPT sounding, it is very important to take initial baseline readings ('zero load' readings) of the separate data acquisition channels — eg cone tip resistance, sleeve friction, pore pressure. The baseline values represent the relative conditions when there are no forces on the load cells and transducers. The electrical signals values may shift before or during a sounding due to thermal effects (air, water, humidity, barometric pressures, ground temperatures, or frictional heat), as well as power interruptions or electromagnetic interference.

Baseline error is variable and should be determined for each sounding by recording the baseline reading both:

- › just before penetration
- › immediately after the cone is withdrawn from the ground.

The baseline readings should always be included on the recorded data sheets to enable a check of its variation. The baseline error should, in general, not exceed 0.5 percent to 1 percent of the full-scale output. For measurements in soft soils, the error should be considerably less than 0.5 percent of FSO. For more specific details regarding cone calibration, refer to ASTM D 5778. A good discussion on cone calibration is also contained in Campanella and Howie (2005).

For completeness, the effect of temperature on zero load output and on calibration factors should be determined by performing calibrations over a range in temperature that might correspond to field conditions. The effect of temperature variations can be minimized in the field by pushing the cone into the ground about 1 m and leaving it for 30 minutes or more while setting up the data system. When the test is started, the cone is withdrawn to ground surface, baseline readings are recorded, and the sounding is started with the cone at the ground temperature. Alternatively, the cone can be placed in a bucket of water which is near ground temperature for about 15 to 30 minutes immediately before starting a sounding.

3.1.6 PIEZOCONE FILTER ELEMENTS

The filter elements used for piezocone testing are typically made of porous plastic, ceramic, or sintered metal.

- › The plastic versions are common because they are disposable and can be replaced after each sounding to avoid clogging problems; particularly when testing plastic clays.
- › A ceramic filter is preferred for face elements (Type 1) because it offers better rigidity and is less prone to abrasion compared with plastic filters.
- › Sintered elements do not work well as face elements in some soils because of smearing problems. The sintered metal and ceramic filters are reusable and can be cleaned using an ultrasonic bath after each sounding.

Saturation of the filter elements is normally accomplished using a glycerine bath under vacuum for a period of 24 hours. Alternatively, silicone oil is sometimes used as the saturation fluid. It is also possible to use water or a 50–50 mix of glycerine and water; however, these fluids require much more care during cone assemblage to avoid desaturation of the filter. For efficiency during testing, it is preferable to pre-saturate a sufficient number of filter elements overnight to use on the next day's project.

In all cases the manufacturer's procedures (and ASTM D 5778) should be followed, as each manufacturer's cone is different, and is set up and calibrated in a particular manner.

3.1.7 CPT PROFILES

The results of the individual channels of a CPT_u are plotted with depth, as illustrated in Figure 3.2. With the continuous records and three independent channels, it is easy to discern detailed changes in strata and the inclusion of seams and lenses within the subsurface profile. Since soil samples are not obtained with the CPT, an indirect assessment of soil behaviour type is interpreted from the readings. The data can be automatically processed for interpretation, utilising empirical relationships (Robertson 1990, Robertson and Wride, 1998), or directly assessed visually to identify changes in soil stratigraphy.

Figure 3.2: CPTu results from site in Christchurch near Avon River

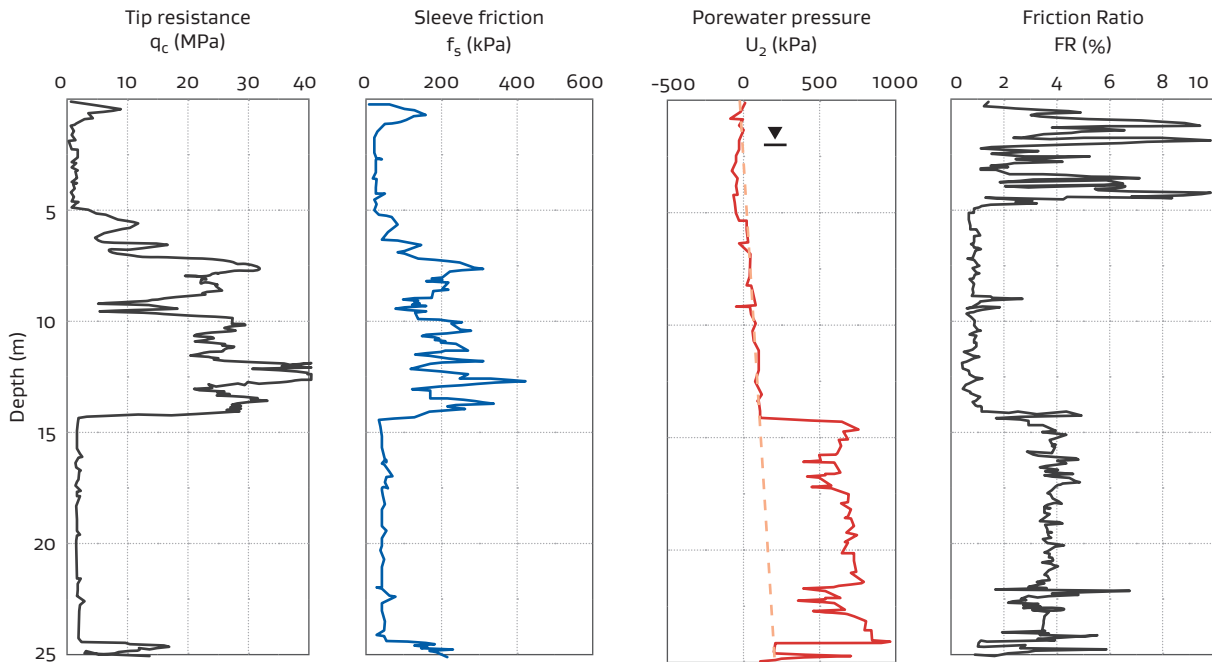

Note

Measured CPT tip resistance (q_c) is influenced by the strength and stiffness of the soils around the actual penetration interval. It is important to note that discrete measurements of q_c in particular taken near the interface between soils with significantly different strengths/stiffnesses may not be representative of either soil layer due to these 'transition zone' effects. A related issue is the difficulty in characterizing thin sand layers that have softer soils above and below them (ie 'thin layer effects'). More information on these effects and how to potentially address them specifically in the context of liquefaction evaluation can be found in Boulanger and Dejong (2018).

At test depths above the groundwater table, porewater pressure readings vary with capillarity, moisture, degree of saturation, and other factors and hence may not be accurate. Below the groundwater table and using a standard shoulder filter element, clean saturated sands have penetration porewater pressures often near hydrostatic ($u_2 \sim u_0$) (or negative in dense, dilative soils), whereas intact clays exhibit values considerably higher than hydrostatic ($u_2 > u_0$).

3.2 Borehole Drilling and Sampling

3.2.1 WHEN TO CONSIDER MACHINE-DRILLED BOREHOLES

Machine-drilled boreholes are typically used on soil sites when samples are required for:

- › laboratory testing (eg to calibrate CPT results, determine soil index properties, or for directly obtaining consolidation or shear-strength parameters)
- › when visual inspection of soil samples is required
- › when subsurface conditions preclude the use of the CPT because of difficulty in pushing through gravelly or dense soils
- › investigating sites on rock.

Assessment of liquefaction triggering can also be accomplished with a borehole if appropriate drilling methodologies and proper SPT are employed.

Comment

The introduction of rotary-sonic drilling in New Zealand after the 2010–2011 Canterbury earthquakes allows the collection of a more-or-less continuous sample of the soil profile. This allows the visual assessment of the stratigraphy and selection of specific samples for laboratory testing. When the borehole is paired with a CPT, various CPT parameters can be correlated on a site-specific basis through the use of targeted laboratory testing.

3.2.2 TYPES OF DRILLING

The following discussion is limited to soil drilling. It is acknowledged that some of the methods discussed, while historically used in New Zealand, may now be uncommon. However, they are included for the sake of completeness.

Double-Tube Coring or Triple Tube Coring

Core drilling was originally developed for coring into hard rock; however the methodology can be used to recover continuous soil samples. The 'core barrel' used in core drilling is typically double-tube or triple-tube. A double-tube or triple-tube core barrel offers better recovery by isolating the soil 'core' from the drilling fluid stream. An inner and outer core barrel is used, as pictured in Figure 3.3. The inner tube can be rigid or fixed to the core barrel head and rotate around the core, or it can be mounted on roller bearings which allow the inner tube to remain stationary while the outer tube rotates. The second or swivel type core barrel is less disturbing to the core as it enters the inner barrel and is often more successful in recovering soil 'core.'

The core barrel can come in a number of sizes and in general, a larger core size will produce greater recovery. The use of shorter core run lengths (eg reducing run length from 3 to 1.5 m or less) can improve core recovery if recovery is low in any core run (ie less than 80 percent).

Figure 3.3: Swivel-Type Double Tube Core Barrel

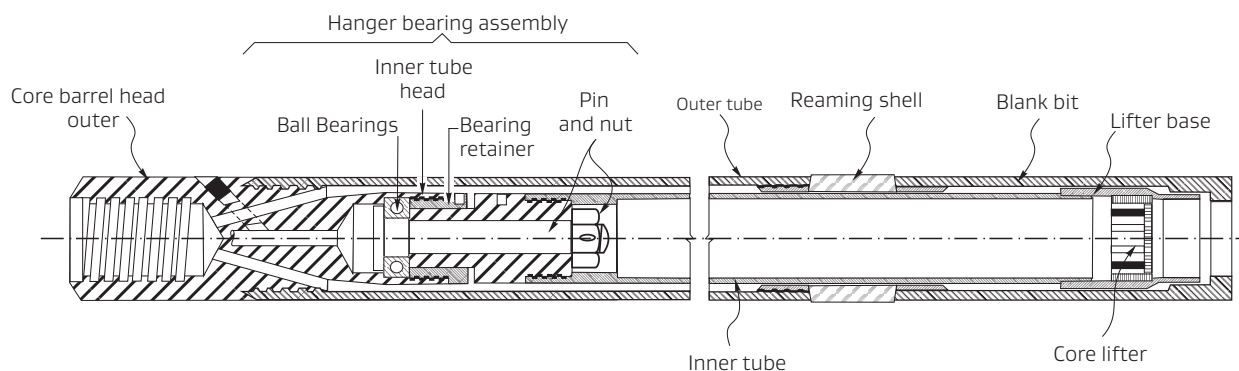

Coring in soil or rock can be accomplished with either conventional or wireline equipment. With conventional drilling equipment, the entire rod string and core barrel are brought to the surface after each core run. Wireline drilling allows the inner core tube to be uncoupled from the outer tube and quickly raised to the surface using a wireline hoist.

The main advantage of wireline over conventional drilling is the increased drilling production resulting from the more efficient removal of the core from the hole (most useful for deeper holes in rock). It also provides improved quality of recovered core because the method avoids rough handling of the core barrel during retrieval of the barrel from the borehole and when the core barrel is opened (from banging the rod joints or barrel to break them free).

Rotary Sonic

Rotary sonic drilling combines elements of rotary wash drilling but uses a vibrating bit in addition to rotation. The drill head rotates the drill casing but also contains an oscillator which creates a high-frequency force to be superimposed on the casing. This results in the drill bit rapidly vibrating up and down in addition to being pushed down and rotated. This combination of forces causes the soil adjacent to the drill bit to ‘fluidize’ and allows the bit to advance rapidly through most soil formations, including gravels.

The oscillator in the drill head is driven by a hydraulic motor and uses out of balance weights to generate high sinusoidal forces that are transmitted to the drill bit. Different equipment manufacturers use variations of the basic technology, but typical vibration frequencies are between 50 and 160 hertz. The higher frequencies, above 120 Hz, are thought to be more effective.

Typical steps during sonic drilling are:

- 1 the core barrel is advanced (typically 1.5 m) using sonic vibration — no water is circulating through the system
- 2 the sonic head is disconnected from the rod holding the barrel and connected to the outer casing, and the casing is advanced to just above the depth of the barrel tip using sonic vibration — water/drilling fluid is circulating through the annulus between the core barrel and the casing to remove cuttings
- 3 the core barrel is retrieved
- 4 the process is repeated.

Figure 3.4 illustrates a typical rotary sonic drilling sequence. It should be noted that the use of side flushing bits rather than end flushing bits will likely result in less disturbance in the base of the borehole, and thus reduce the potential for adversely affected SPT results.

Figure 3.4: Typical Sonic Drilling Sequence

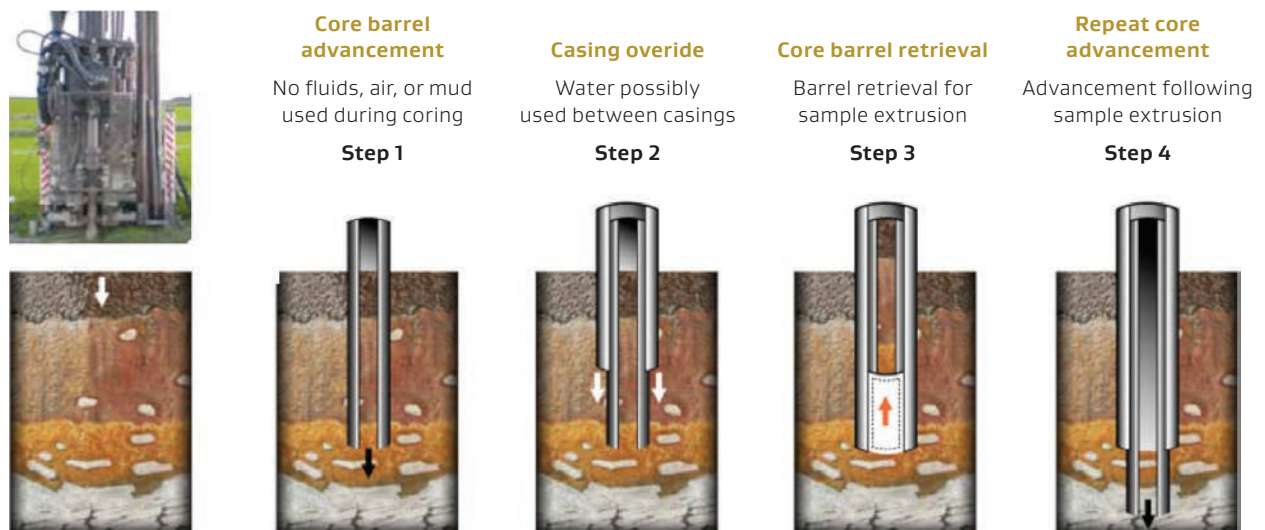

Comment

Variations of this drilling methodology came into widespread use in Christchurch after the Canterbury earthquakes due to its ability to drill rapidly through gravelly soils and recover continuous core. There have been some concerns regarding possible soil disturbance due to drilling vibration, and how this might affect SPT blow counts used for liquefaction triggering assessment. While there appears to be little published research on this topic, a New Zealand-based field study (Wentz and Dickenson, 2013) did show significant excess pore pressure due to 'liquefaction' of the soils around the drill bit may not occur. In any event, the potential for such disturbance can be reduced with the use of good SPT protocols as discussed in Appendix D.

Hollow-Stem Auger

Hollow-stem auger (HSA) drilling is very similar to continuous (ie solid stem) flight auger drilling except, as the name suggests, the auger has a large hollow centre. This drilling method is reasonably well-suited for sands and finer soils, but HSA is not very effective for drilling through dense gravelly or cobble soils.

The various components of the hollow stem auger system are shown schematically in Figure 3.5. When the borehole is advanced, a centre stem and plug are inserted into the hollow centre of the auger. The plug with a drag bit attached and located in the face of the cutter head aids in the advancement of the hole and also prevents soil cuttings from entering the auger stem. The centre stem consists of rods that connect to the bottom of the plug or bit insert, and at the top to a drive adapter to ensure that the centre stem and bit rotate with the augers. Some drillers prefer to advance the boring without the centre plug, allowing a natural 'plug' of compacted cuttings to form. This practice should be avoided because the extent of this plug is difficult to control and determine.

The cuttings produced from this drilling method are mixed as they move up the auger flights making them of limited use for the purpose of visual logging of the soil profile. At greater depths there may be considerable differences between the soil being drilled at the bottom of the borehole and the cuttings appearing at the ground surface. The field supervisor must be aware of these limitations when interpreting soil conditions between sample locations.

Figure 3.5: Typical Hollow-Stem Auger Components (ASTM D 4700)

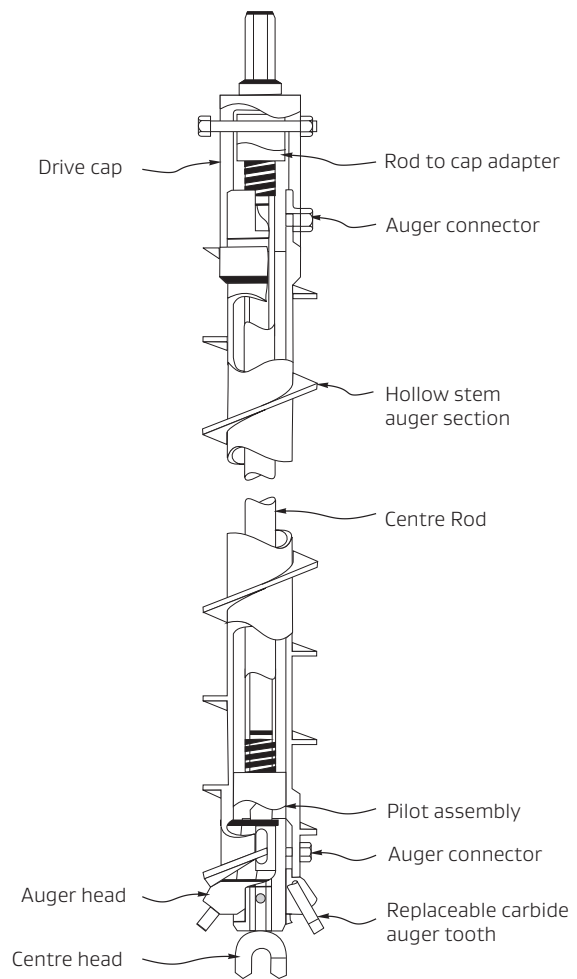

Once the augers have advanced the hole to the desired sample depth, the stem and plug are removed, and a SPT or other sampler can then be lowered through the stem to sample the soil at the bottom of the hole. HSA methods are commonly used in fine-grained soils or in granular soils above the groundwater level, where the boring walls may be unstable. The augers form a temporary casing to allow sampling of the 'undisturbed soil' below the bit.

Problems can occur where HSA is used to sample soils below the groundwater level. The hydrostatic water pressure acting against the soil at the bottom of the boring can significantly disturb the soil; particularly in loose sands and soft clay/silt. Sometimes the soils will 'heave' into the auger stem and plug it, hence preventing the sampler from reaching the bottom of the borehole. Where heave or disturbance occurs, the penetration resistance of a SPT sampler can be significantly reduced.

Figure 3.6: Rotary Wash Drilling (after Mayne et al. 2001)

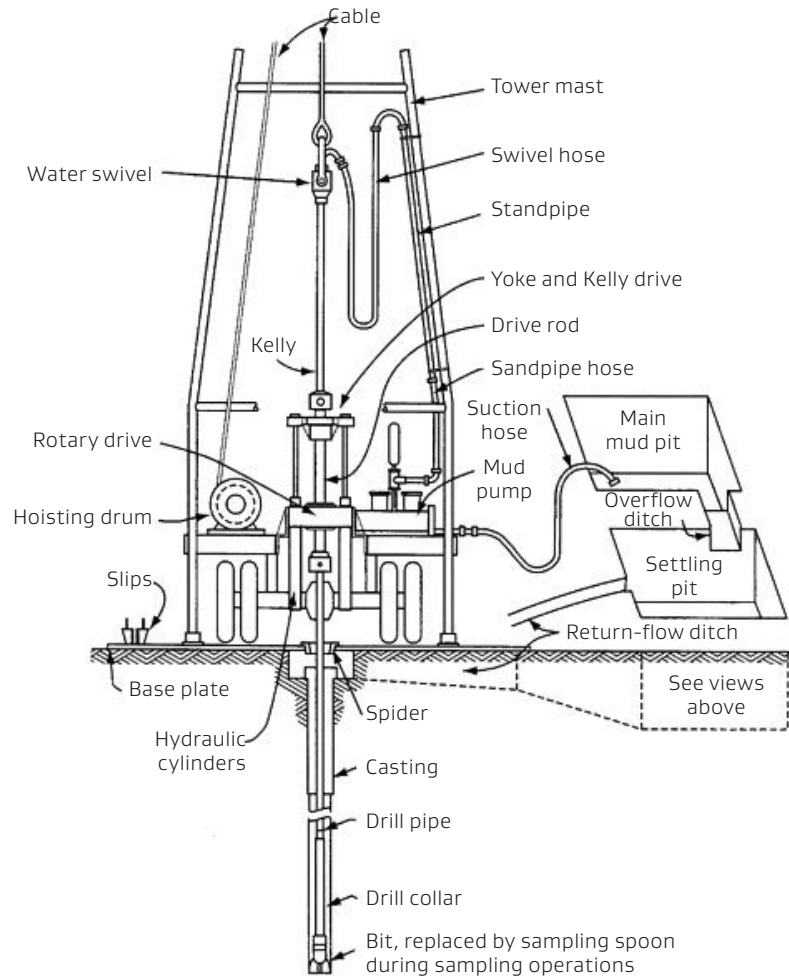

Comment

In the western US, in sandy soils, HSA is sometimes used when assessing liquefaction potential with the SPT on routine projects because it is typically less expensive than rotary drilling. The method generally works well in medium dense and dense soils. However, when borehole heave is encountered in loose soils, SPT blow counts are meaningless unless the heave is controlled. Heave can often be eliminated, or reduced to the point where an SPT is still valid if the auger stem is kept full of water or drilling fluid to stabilise the bottom of the hole. Alternatively, HSA can be stopped at the groundwater level and a switch to rotary wash drilling made.

Rotary Wash

Rotary wash drilling (Figures 3.6) (also referred to as 'mud rotary') is generally considered the most appropriate method to use to minimise drilling disturbance in soil formations below the groundwater level (Mayne et al. 2001; ASTM D 6066). However, the method is not well suited to dense gravelly soils, or soils with significant amounts of cobble or large (ie >20 mm) gravel. This is due to difficulty in 'cutting' through these materials, as well as returning the relatively heavy cuttings to the ground surface.

In rotary wash, the sides of the borehole are supported with either casing or the use of a drilling fluid. Where casing is used, the borehole is advanced sequentially as follows:

- 1 drive the casing to the desired sample depth
- 2 clean out the borehole to the bottom of the casing
- 3 insert the sampling device and obtain the sample from below the bottom of the casing.

The drill casing is usually selected based on the outside diameter of the sampling or coring tools to be advanced through the casing. However, the decision may also be influenced by other factors such as stiffness considerations for boreholes in water bodies or very soft soils, or dimensions of the casing couplings. Rotary wash drill casing is typically furnished with inside diameters ranging from 60 to 130 mm. Even with the use of casing, care must be taken when drilling below the groundwater table to maintain a head of water/drilling fluid within the casing above the groundwater level. Particular attention must be given to adding water to the hole, as the drill rods are removed after cleaning out the hole prior to sampling. Failure to maintain an adequate head of water may result in loosening or heave of the soil to be sampled beneath the casing.

For holes drilled using drilling fluids to stabilize the borehole walls, casing should still be used at the top of the hole to protect against sloughing of the ground around the top of the hole, and to form a seal around the top of the hole to facilitate circulation of the drilling fluid. In addition to stabilizing the borehole walls, the drilling fluid (ie water, bentonite, polymers or other synthetic drilling products) removes the drill cuttings from the hole.

In granular soils and soft cohesive soils, bentonite or polymer additives are typically used to increase the density of the drill fluid and reduce the stress reduction in the soil at the bottom of the hole. For boreholes advanced with the use of drilling fluids, it is important to maintain the level of the drilling fluid at or above the ground surface to maintain a positive pressure for the full depth of the hole.

Two types of bits are often used with the rotary wash method. Drag bits are commonly used in clays and loose sands, whereas roller bits are used to penetrate dense coarse-grained granular soils, cemented zones, and soft or weathered rock.

The properties of the drilling fluid and the quantity of water pumped through the bit will determine the size of particles that can be removed from the borehole with the circulating fluid. In formations containing gravel, cobbles, or larger particles, coarse material may be left in the bottom of the hole. In these instances, clearing the bottom of the hole with a larger-diameter sampler (such as a 75 mm OD split-barrel sampler) may be needed to obtain a representative sample of the formation.

During drilling, the cuttings suspended in the drilling fluid can be examined to help identify changes in the soil types between sample locations. A small strainer held in the drilling fluid discharge stream facilitates this process by catching the suspended particles. Sometimes during drilling (especially with uncased holes), 'fluid return' is reduced or lost. This is indicative of open joints, fissures, cavities, gravel layers, highly permeable zones and other stratigraphic conditions that may cause a sudden loss in pore fluid and should be noted on the borehole log.

Comment

Rotary wash drilling is typically considered to be the most appropriate method to acquire SPT data for liquefaction assessment, due to the relative lack of soil disturbance during drilling. However, as discussed above, the method is not well suited to soil deposits containing significant amounts of dense gravel or cobble typical of many interlayered alluvial deposits. While these soil conditions limit its utility to some parts of New Zealand, where soil conditions are favourable, it is recommended that this drilling method be used for site investigations where SPT will be used for liquefaction assessment.

Cable Tool

This method uses the repeated dropping of a bit (via a cable or wireline) onto the base of the borehole to loosen the ground formation. A 'bailer' or 'sand pump' is then lowered into the hole to retrieve the loosened materials, using a flapper valve arrangement to retain the sample in a tube.

Cable tool drilling has been a common method for constructing water wells in New Zealand and, because of their availability, these rigs have also been used for foundation investigation drilling purposes. However, the method greatly disturbs the soil at the base of the borehole hence making SPT results less reliable. Therefore, this drilling method is not recommended for SPT-based liquefaction assessment. The cable tool method also causes high levels of disturbance to the recovered samples (although thin walled tube samplers can still be deployed in the borehole if required, for example). For these reasons, the use of cable tool drilling for foundation investigation purposes (particularly where liquefaction potential is a concern) has been largely discontinued, as more appropriate equipment has become available.

Window Sampling

Window sampling is a technique whereby steel tubes (with cut-out broad slots down the side, or 'windows') are driven by percussive means into the soil — ie with a petrol, electric or hydraulically powered mechanical hammer. Hand portable versions use a jack hammer as the driving force. The sample tubes are then extracted manually or hydraulically. The sample tubes are generally a metre long and are driven via drill rods attached to the top of the sampler. The soil profile is logged by observation of the retrieved materials through the side 'windows' of the sampler.

3.2.3 COMMON DRILLING ERRORS

The driller's performance is often judged by the rate of production rather than the quality of the boreholes and samples. Recognising that there is always a field investigation budget to work to, the geotechnical professional should work with the driller to obtain data of the quality appropriate for the level of required geotechnical site characterisation. The geotechnical professional's field supervisors should be trained to recognise and help address typical 'problems,' and to work with the driller to assure that field information and samples are properly obtained. The following is a list of some of the more common problems that arise during drilling for geotechnical investigations:

- › Not thoroughly cleaning slough, cuttings, or heaved material from the bottom of the borehole prior to advancing the sampler.
- › The use of downward trajectory flushing methods (if not very carefully controlled and supervised), affecting both SPT test results and also undisturbed sampling.
- › In cohesionless soils, using jetting or 'washing' to advance a split-barrel (SPT) sampler to the bottom of the borehole.
- › Poor sample recovery due to use of improper sampling equipment and/or procedures.
- › Overdriving the sampling barrel when sampling soft or low plasticity silty soils with thin-wall tube samplers (ie Shelby tube) to improve sample recovery. In such soils, it may be difficult to recover an undisturbed sample because the sample will not stay in the barrel. Nonetheless, attempts to force recovery by overdriving the sampling barrel should be avoided if the goal is to obtain an undisturbed sample.

- › Use of inappropriate sampler types (ie for obtaining undisturbed samples) or insufficient quantity of samples. The driller should be given clear instructions regarding the sample frequency and types of samples required. The field supervisor must keep track of the depth of the borehole at all stages of the exploration to confirm proper sampling of the soil and/or rock formations.
- › Improper hole stabilization — particularly to control base heave when performing SPT sampling. Even cased boreholes below the groundwater level require a head of water or drilling fluid to be maintained at the top of the casing/hole at all times to prevent heave (and for uncased holes, to prevent the sides of the hole from collapsing). When the drill rods are withdrawn or as a cased hole is advanced, the fluid level will tend to drop, and must be maintained by the addition of more drilling fluid.
- › Sampler rods dropped into the borehole or lowered with pipe wrenches rather than a hoisting plug. The rods may be inclined and the sampler can hit the borehole walls, filling the sampler with debris and creating slough at the bottom of the hole.
- › Improper procedures used while performing SPT — particularly for liquefaction assessments (see section 3.2.5 and Appendix D).
- › SPT hammer energy reduced due to friction from hammer/sampling rod misalignment or insufficient hammer drop height.

3.2.4 SOIL SAMPLING

Disturbed

Disturbed samples are those obtained using sampling methods that destroy the macro structure of the soil but do not alter its mineralogical composition. Specimens from these samples can be used for determining the soil type, general lithology of soil deposits and for general classification purposes. They can also be used for determining typical material index properties such as particle size, plasticity and compaction characteristics of soils.

Undisturbed

The term 'undisturbed' in the context of soil sampling refers to the relative degree of disturbance to the soil's in situ properties — it does not mean that the sample is in the exact same state as it was prior to sampling. The objective of 'undisturbed'

sampling is to minimise sample disturbance effects ideally to the point where they have a minor effect on the results of laboratory testing. Hence, the effect can be confidently assessed when interpreting test results.

Undisturbed samples are typically obtained in cohesive soils for use in laboratory testing to determine the engineering properties such as shear strength, consolidation characteristics, permeability, density, and dynamic properties. The samples are obtained with specialized equipment designed to minimize the disturbance to the in situ structure and moisture content of the soils. Undisturbed samples of cohesionless/low plasticity soils can also be obtained. However, this often requires specialized procedures such as freezing or resin impregnation and block or core type sampling.

Sampler Types

A wide variety of samplers are available to obtain soil samples for geotechnical engineering purposes. These include standard, widely available sampling tools as well as specialized types to accommodate local conditions and preferences. Some of the samplers discussed in this section may not be widely available in New Zealand but are included so that the geotechnical professional is aware of some of the tools which may be available. The following sections present discussions/guidelines intended to assist geotechnical professionals and field supervisors with the selection of appropriate samplers; noting that in many instances local practice will control.

Comment

Some of the samplers and sampling methodologies described in the following sections are not routinely used in New Zealand. However, they are commonly used in many other countries including the US and Australia. For projects where it is important to obtain high quality geotechnical information that requires drilling or sampling, it is recommended that the geotechnical professional discuss his or her requirements with a knowledgeable and experienced driller. Some specialist geotechnical drillers in New Zealand are familiar with the tools and methods described herein, and either have the necessary equipment already, or can obtain it quite quickly.

Split-Barrel Sampler

The split-barrel (or split-spoon) sampler is used to obtain disturbed samples in all types of soils. This type of sampler is typically used in conjunction with the SPT, as specified in the ASTM D 1586 test method wherein the sampler is driven with a 63.5 kg hammer dropping from a height of 760 mm. The SPT is discussed in detail in Section 3.2.5.

Split-barrel samplers are typically available in standard lengths of 457 and 610 mm, with inside diameters (ID) ranging from 38.1 to 63.5 mm, although diameters can be as large as 114 mm. The 38.1 mm ID sampler (SPT sampler) is historically widely used because correlations have been developed between the number of blows required for penetration and various soil properties. The larger-diameter samplers (ID 50 mm +) are sometimes used when gravel particles are present or when more material is needed for classification tests.

The 38.1 mm ID standard split-barrel sampler has an outside diameter of 51 mm and a cutting shoe with an inside diameter of 34.9 mm. This corresponds to a thick-walled sampler with an area ratio, A_r , of 112 percent (Hvorslev, 1949), where:

$$A_r = 100 * (OD^2 - ID^2)/ID^2, \text{ OD} = \text{outside diameter of sampler, ID} = \text{inside diameter of sampler}$$

This high area ratio disturbs the natural characteristics of the soil being sampled, thus disturbed samples are obtained.

A ball check valve incorporated into the top of the sampler head facilitates the recovery of cohesionless materials. This valve closes when the sampler is withdrawn from the borehole, hence preventing water pressure on the top of the sample from pushing it out. Also, if the sample tends to slide out because of its weight, some vacuum is developed at the top of the sample which helps to retain it.

Figure 3.7: Split Barrel Sampler (Mayne et al. 2001)



As shown in Figure 3.7, when the cutting shoe and the sleeve of this type of sampler are unscrewed from the split barrel, the two halves of the barrel can be separated, and the sample easily extracted. Upon removal from the sampler, the sample is sealed in a plastic bag or glass jar. Alternatively, brass or stainless-steel liners with the same inside diameter as the cutting shoe may be placed inside the split-barrel. This allows samples to be sealed in the liners and remain intact during transport to the laboratory.

Steel or plastic sample retainers are often required to prevent samples of clean sands/small gravels or particularly 'slick' low plasticity silty/clayey soils from slipping out of the sampler during retrieval. Various types of plastic or sprung steel retainers are sometimes used to permit the soil to enter the sampler during driving, but upon withdrawal they close and hence retain the sample. Use of sample retainers should be noted on the borehole log.

Comment

The resistance of the sampler to driving is altered depending upon whether or not a liner is used (Skempton, 1986; Kulhawy & Mayne, 1990). Therefore, if a liner is used, it should be clearly noted on the borehole log as the reported penetration blow counts may affect the engineering analysis (ie require the use of a liner correction factor).

Modified California Sampler

The modified California sampler is a variation of a split-spoon sampler. The sampler is thick-walled (area ratio of 77 percent) with a 64 mm OD and 51 mm ID. It has a cutting shoe similar to the split-barrel sampler, but with a typical ID of 49 mm. Three or four (depending on the length of the sampler) 150 mm long brass liners with inside diameters of 49 mm are used to contain the sample. The modified California sampler is typically driven with the same hammer and rod system used for SPT sampling. In relatively soft soils the sampler can be pushed into the soil using the drill rig hydraulics. The unadjusted blow count (blows/150 mm) or hydraulic push pressure is recorded on the borehole log. The driving resistance obtained using a modified California sampler is not equal to the standard penetration test resistance. The modified California sampler can be a useful tool for obtaining intact samples of various soils but should not be substituted for a SPT sampler when assessing liquefaction potential.

Comment

The modified California sampler can be readily obtained in New Zealand by drilling companies or soil testing equipment suppliers. It is a useful tool for quickly obtaining intact and relatively undisturbed samples of medium-stiff to stiff cohesive soils including clays, sandy clays and cohesive silts/sandy silts (ie materials unlikely to successfully be sampled with a thin-walled tube sampler). The sample volume from one drive is large enough to allow index testing such as plasticity and particle size, as well as a sample for determining total unit weight and dry density. While the density determination will not be as accurate as that from a thin-walled sampler, for intact samples, it can still provide a reasonable idea of the in situ density of the soil.

Thin-Wall Sampler

The thin-wall tube (often referred to as 'Shelby tube') sampler is commonly used to obtain relatively undisturbed samples of cohesive soils for shear strength and consolidation testing. A typical sampler configuration is shown in Figure 3.8. Thin wall samplers vary between 51 and 76 mm OD and typically come in lengths from 700 to 900 mm. The sampler commonly used has a 76 mm OD and a 73 mm ID, resulting in an area ratio of 9 percent. Larger diameter sampler tubes are used

where higher quality samples are required and sampling disturbance must be reduced. A common test standard for thin-walled tube sampling is ASTM D 1587.

Figure 3.8: Schematic of Thin-Walled Shelby Tube (after ASTM D 4700)

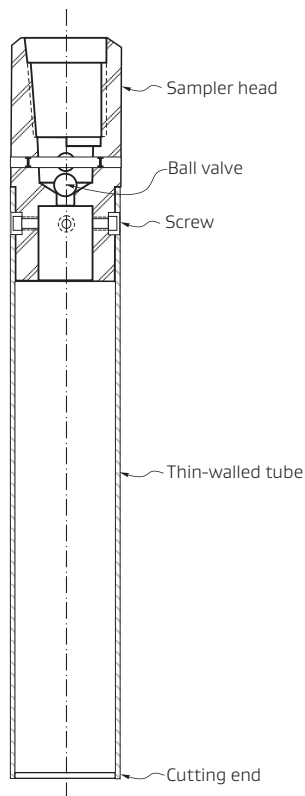

The thin-walled tubes are manufactured from carbon steel, galvanized-coated carbon steel, stainless steel or brass.

Carbon steel tubes are often the least cost, but are unsuitable if the samples are to be stored in the tubes for more than a few days due to rusting which significantly increases the friction between the tube and the soil sample during extrusion (or sampling if the tube is rusted before use).

Stainless steel or brass tubes are generally preferred to obtain high quality samples. It should be noted that stainless steel tubes typically result in higher sample disturbance than brass tubes due to higher liner friction. The thin-walled tube is typically manufactured with a bevelled front edge for cutting a reduced-diameter sample (commonly 72 mm ID) to reduce friction.

Comment

To reduce the potential for sample disturbance, the 'inside clearance ratio' of bevelled edge tubes should not exceed 1 percent. This ratio is defined as the ratio of the difference in the inside diameter of the tube (D_i) minus the inside diameter of the cutting edge (D_e) to the inside diameter of the tube (D_i) expressed as a percentage. Refer to ASTM D 1587 for further commentary and recommendations.

Thin-wall tubes can be pushed with a fixed head or piston head. The sampler head should contain a check valve that allows water to pass through the sampling head into the drill rods. The valve must be clear of mud and grit to operate freely and should be checked prior to each sampling attempt. The thin-walled tube sampler should be pushed slowly into the soil using the drill rig's hydraulic system in a single, continuous motion. The hydraulic pressure required to advance the thin-walled tube sampler should be noted and recorded on the borehole log. After the push is completed, the driller should let the sample 'rest' for a minimum of 5 to 10 minutes to allow the sample to swell slightly within the tube. After this wait period, the drill rod string is rotated through two complete revolutions to shear off the sample, then the tube is raised slowly and carefully to the surface (ie without banging the drill rods or hitting the sampler on the side of the borehole).

During sampling, the sample tube should be pushed about 75 mm less than the total length up to the connecting cap. The remaining length of tube is provided to accommodate the slough that accumulates, to a greater or lesser extent, at the bottom of the borehole. Where low density soils or collapsible materials are being sampled, a reduced push length of 300 to 450 mm may be helpful to prevent the disturbance of the sample.

After retrieving the sample tube from the borehole:

- 1 the slough or cuttings from the upper end of the tube should be removed using a cleanout tool
- 2 the length of sample recovered should be measured and the soil exposed at the base of the sampler visually classified for the borehole log
- 3 both ends of the sample tube should then be sealed with at least a 25 mm thick layer of molten microcrystalline (non-shrinking) wax

- 4 the remaining void above the top of the sample should be filled with moist sand. Alternatively, O-ring packers can be inserted into the ends of the tube — packers may be preferable as they are a cleaner and faster method for sealing the sample
- 5 after sealing the sample, plastic end caps should then be placed over both ends of the sample tube and electrician's tape wrapped over the joint between the collar of the cap and the tube and over the tube screw holes
- 6 the capped ends of the tubes are then dipped in molten wax.

Samples must be stored upright in a protected environment to prevent disturbance due to bouncing or sharp impacts, and to prevent freezing, desiccation, and changes in sample moisture content.

Piston Sampler

Piston samplers are essentially a thin-wall tube sampler with a piston, rod and modified sampler head (Figure 3.9). They are also known as Osterberg, or Hvorslev samplers, and are particularly useful for sampling soft soils where sample recovery is often difficult, although it can also be used in stiff soils. The sampler, with its piston located at the base of the sampling tube, is carefully lowered into the borehole by lowering the rods down the centre of the borehole. The rods should not be slid down the side of the hole. When the sampler reaches the bottom of the hole, the piston rod is held fixed relative to the ground surface, and the thin-wall tube is slowly pushed into the soil by hydraulic pressure. Upon completion of sampling, the sampler is removed from the borehole and the vacuum between the piston and the top of the sample is broken. The piston head and the piston are then removed from the tube and the tube is labelled and sealed in the same way as a Shelby tube described in the previous section.

The quality of the samples obtained with a correctly operated piston sampler is typically very good and the probability of obtaining a satisfactory sample is high.

Figure 3.9: Schematic of Piston Sampler (after ASTM D 4700)

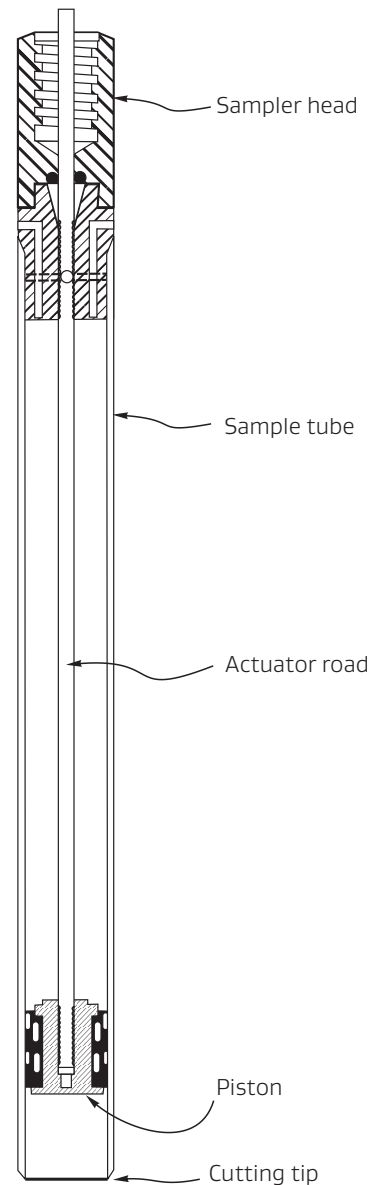

One of the major advantages of the piston sampler is that the fixed piston helps prevent the entrance of excess soil at the beginning of sampling, thereby precluding recovery ratios greater than 100 percent. It also helps the soil enter the sampler at a constant rate throughout the sampling push. Thus, the opportunity for 100 percent recovery is increased. The head used on this sampler also acts to create a better vacuum which helps retain the sample better than the ball valve in thin-walled tube (Shelby) samplers.

A variation of the piston sampler is the Dames & Moore (DM) sampler. The DM sampler was developed specifically for sampling clays and silts, but silty sands and fine sands with some silt have also been successfully sampled. A detailed description of the DM sampler and the procedures for its use are detailed in Bray et. al. (2016).

Gel-push Sampler

Gel-push (GP) sampling is a recent development in the sampling of saturated cohesionless soils (Tani and Kaneko, 2006). The GP samplers are a variation on existing rotary and drive samplers, with the use of a gel-polymer lubricant during the sampling process. The use of the gel-polymer is primarily to reduce undesired frictional shear resistance between the sample core and the inside surface of the sample tube as it enters the internal liner.

Figure 3.10: Schematic of GP-S

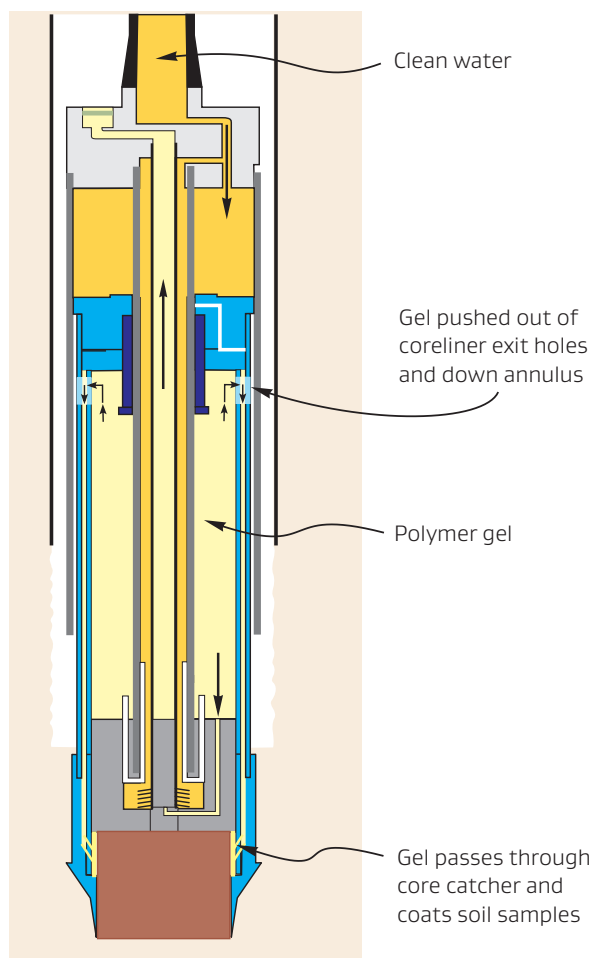

GP sampling is currently carried out with one of three types of samplers; GP-S, GP-TR and GP-D, with the key and common feature of the samplers being the delivery of a lubricating polymer gel to the bottom end of the samplers. Figure 3.10 shows an example (from sampling in Christchurch) of the gel coating the bottom end of the sample using the GP-S sampler. The gel coats the sample, with the aim of significantly reducing the friction between the sample and core barrel. While GP sampling theoretically overcomes some of the deficiencies associated with conventional techniques, the method is still being researched through ongoing field-based studies. A high level of skill and training is required for successful application of this method. A comprehensive description of GP sampling in Christchurch is provided by Stringer, et. al. (2016).

Continuous Sampling

Several types of continuous soil samplers have been developed. The conventional continuous sampler consists of a 1.5 m long, thick-walled tube which obtains 'continuous' samples of soil as hollow-stem augers are advanced into soil formations. This type of system uses bearings or fixed hexagonal rods to restrain or reduce rotation of the continuous sampler as the hollow-stem augers are advanced and the tube is pushed into undisturbed soil below the augers. More recently, the rotary sonic drilling method (Section 3.2.2) effectively results in continuous sampling of the borehole.

Continuous samplers have been shown to work well in most clayey soils and in soils with thin sand layers. Less success is typically observed when sampling cohesionless soil below the groundwater level, soft soils, or samples that swell following sampling although modifications are available to increase sample recovery.

Recovery of all soil types is quite good using rotary sonic drilling, although loose soils below the water table may be subject to relatively high levels of disturbance. Continuous samples are generally disturbed and therefore are only appropriate for visual observation, and material index and classification-type laboratory tests (ie plasticity, particle-size, moisture content).

Sample Interval and Selection of Sampler Type

In general, split-spoon samples can be collected in both granular and cohesive soils, and thin-walled tube samples in cohesive soils. The sampling interval will vary depending on specific project requirements. A common US practice is to obtain split-barrel samples at 0.75 m intervals in the upper 3 m (10 ft) and at 1.5 m intervals below this depth. In some instances, a greater sample interval (eg 3 m) may be acceptable below a depth of 20 to 25 m in a known homogeneous soil deposit.

In cohesive soils of interest, at least one undisturbed soil sample should be obtained from each different stratum encountered. If a uniform cohesive soil deposit extends for a considerable depth, obtaining additional undisturbed samples at regular intervals (ie 3 to 6 m) will allow for confirmation of uniform soil properties. When boreholes are widely spaced, it may be appropriate to obtain undisturbed samples in each hole. However, for closely spaced boreholes, or in deposits which are generally uniform in lateral extent, it is often appropriate to take undisturbed samples from selected boreholes only.

Sample Recovery and Identification

Occasionally, sampling is attempted and little or no material is recovered. In cases where a split-barrel, or another disturbed-type sample is to be obtained, it is appropriate to make a second attempt to recover the soil sample immediately following the failed attempt. In such instances, the sampling device is often modified to include a retainer basket, a hinged trap valve or other measures to help retain the material within the sampler.

When performing undisturbed sampling, the field supervisor should ask the driller to drill to, or just beyond, the bottom of the attempted sampling interval and repeat the sampling attempt. The method of sampling should be reviewed, and the sampling equipment should be checked to understand why no sample was recovered (eg plugged ball valve). It may be appropriate to change the sampling method and/or the sampling equipment, ie extending the waiting period before extracting the sampler, extracting the sampler more slowly and with greater care, etc. This process should be repeated, or a second boring may be advanced to obtain a sample at the same depth.

Every sample attempted should be noted in the borehole log, regardless of whether the sample recovery was successful. Sample identification should be clearly shown on sample bags, liners and tubes. Sample labels are preferable for liner, tube and jar samples as there is less risk of the label falling off. The labels should be placed on the sample container and also on the lid or cap. All labels/tags should be written in indelible ink and be clearly legible.

Each sample should be uniquely marked with the following details as applicable:

- > project number
- > project name
- > borehole/test pit number
- > sequential sample attempt number
- > sample depth
- > date sampled.

A durable label, indelibly marked with the details listed above, should also be placed on top of the material inside each disturbed sample bag/container.

Where tube or liner samples are obtained, the top and bottom of the samples should be identified. Any disturbed tube samples should be clearly marked as such.

Sample Logging

Core recovered from double-barrel or triple-barrel coring or rotary sonic will most likely be sampled or disturbed during logging. Photography of all drill core provides a permanent visual record of the ground conditions encountered. Photographs should identify the project name and show the borehole designation, depth of the core, date of sampling, date of photographing and the location and extent of zones of no core recovery. It is helpful if the core photographs also include a colour reference chart.

If possible, core photographs should be taken at the time of drilling, and within a maximum of 24 hours after recovery from the borehole. All core should be handled and stored in a manner which minimises the risk of breakage or decomposition upon exposure to air and water.

Care and Preservation of Soil Samples

Each step in sampling, storing, extruding and testing introduces varying degrees of sample disturbance. The extraction, storage, preparation and transportation of laboratory test samples should be completed in a way that is appropriate for the type of sample taken (ie a disturbed or 'undisturbed' sample).

Proper sampling, handling, and storage methods are essential to minimise disturbances. The geotechnical professional must be cognizant of disturbance introduced during the various steps in sampling through testing, and the field supervisor should be aware of disturbance, how to minimise it and its consequences. Recommendations outlined in the ASTM D 4220 standard should be followed.

All samples should be protected from extreme temperatures, and should be kept out of direct sunlight and covered with wet burlap or other material in hot weather. In winter, precautions should be taken to prevent samples from freezing during handling, shipping and storage. To the extent practical, thin-walled tubes should be kept vertical, with the top of the sample in the up position. If available, the thin-walled tubes should be kept in a carrier with an individual slot for each tube. Padding should be placed below and between the tubes to cushion them and to prevent them from striking one another. The entire carrier should be securely fastened to prevent it from tilting or tipping over while the vehicle is in motion.

Storage of undisturbed samples (in or out of tubes) for long periods of time under any condition is not recommended. Storage exceeding one month may substantially alter soil strength and compressibility as measured by laboratory testing.

3.2.5 STANDARD PENETRATION TESTING (SPT)

The standard penetration test (SPT) is performed during the advancement of a borehole, to obtain an approximate measure of the dynamic soil resistance, as well as a disturbed drive sample (split-barrel type). The test can be performed in a wide variety of soil types and is commonly used for measuring the density of sands and non-plastic or low-plasticity silts for liquefaction assessment. It is not particularly useful in the characterization of gravel deposits or soft clays because it can greatly over-estimate the density of gravels and is not sensitive enough to characterise very soft clays. The remainder of the discussion of SPT is primarily in the context of liquefaction assessment.

The procedures for the SPT are detailed in the ASTM D 1586 test standard and, specifically for liquefaction assessment, in the ASTM D 6066 test standard. The test involves driving a split-spoon sampler into the ground and measuring the number of hammer blows to advance the sampler 450 mm. A 63.5-kg hammer is repeatedly dropped from a height of 0.76 m to achieve six successive increments of 75 mm each. The first two increments (150 mm) is recorded as the 'seating', while the number of blows to advance the next four increments are summed to give the N-value (eg the 'blow count') or SPT-resistance (reported in blows/300 mm). If the sampler cannot be driven 450 mm, the number of blows per each 75- or 150 mm increment, or portion thereof, is recorded on the borehole log. For partial increments, the depth of penetration is recorded in addition to the number of blows.

The SPT is conducted at the bottom of a borehole at regular depth intervals. Tests are typically taken every 1.5 m, but can be more frequent if necessary to define thinner soil deposits. The head of water/drilling fluid in the borehole must be maintained at or above the ambient groundwater level to avoid inflow of water and borehole instability.

Comment

It is not uncommon for high-quality, relatively undisturbed samples to be recovered at considerable expense, only to disturb them during transport and handling to the testing laboratory. The ASTM D 4220 test standard provides a robust procedure for handling and transport of undisturbed samples. Particularly useful is a recommended design for transport containers to reduce disturbance due to vibration and impacts.

Also important for disturbed (eg bag) samples is proper sealing to preserve the natural moisture content.

Knowing the natural moisture content of the soil is useful in a variety of engineering analyses, including liquefaction assessment of low-plasticity soils. Representative bag samples should be collected from drill core immediately upon retrieval from the borehole to preserve the natural moisture content. The practice of placing the core box in a plastic bag does not preserve the natural soil moisture due to the inability to completely seal the bag and avoid evaporation/condensation.

Figure 3.11: Sequence of Driving Sampler during Standard Penetration Test

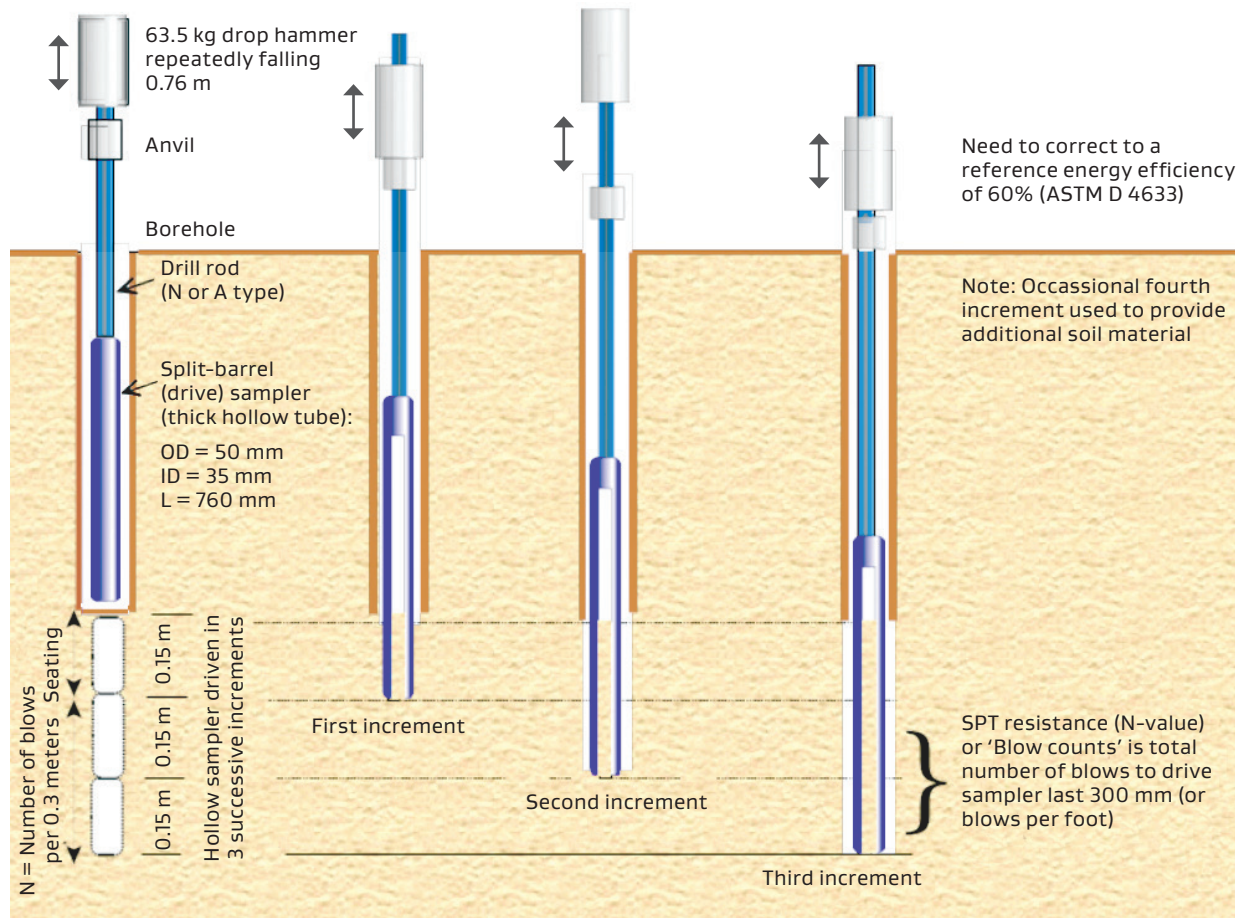

The SPT can be terminated when either:

- 1 100 blows has been achieved
- 2 the number of blows exceeds 50 in any given 150-mm increment
- 3 the sampler fails to advance during 10 consecutive blows.

SPT refusal is often defined by penetration resistances exceeding 100 blows per 50 mm, although ASTM D 1586 has re-defined this limit at 50 blows per 25 mm. Figure 3.11 illustrates the sequence of the SPT test.

A more detailed discussion of the specific steps performed during standard penetration testing for liquefaction assessment is contained in Appendix D.

Comment

As discussed in Section 1.3, field supervision of drilling and sampling by a suitably qualified and experienced geotechnical engineer or engineering geologist is recommended. It is also important to have a suitably experienced driller carrying out the drilling and sampling.

Supervision of SPT testing performed for liquefaction assessment is particularly important in order to ensure that the test results are as consistent and accurate as possible, and to note any issues that might affect the results and how these were corrected.

In New Zealand and US practice, there are commonly three types of drop hammers (donut, safety, and automatic) and four types of drill rods (N, NW, A, and AW) used to conduct the SPT. The validity of the test results for liquefaction assessment are highly dependent upon the equipment used and operator performing the test.

The most important factor in performing SPT is the energy efficiency of the test system. The theoretical energy of the free-fall hammer system, with the specified mass and drop height, is 48 kg-m; however, the actual energy is less, due to frictional losses and eccentric loading.

A rotating cathead and rope system was historically used for performing the SPT. Its efficiency depended on a number of factors which are well-discussed in the literature (eg Skempton, 1986) including:

- › type of hammer
- › number of rope turns
- › conditions of the sheaves and rotating cathead (eg lubricated, rusted, bent, new, old)
- › age of the rope
- › actual drop height
- › verticality
- › weather and moisture conditions (eg wet, dry, freezing)
- › other variables.

Today, it is much more common to use automated systems for lifting and dropping the hammer, in order to minimize these variables and maintain repeatable energy delivery.

The older SPT hammer systems typically delivered about 55 to 60 percent of the theoretical maximum energy (Kovacs, et al., 1983). The newer automatic trip-hammers can deliver between 80 and

100 percent efficiency, depending on the type of commercial system. Seed et al. (1984) use N_{60} as a standard for liquefaction assessment in the simplified method. If the hammer energy efficiency is measured (ER_m), then N_{60} is given by:

$$N_{60} = (ER_m/60) N_m$$

where N_m is the measured blow count, ER_m is the measured delivered energy ratio as a percentage, and N_{60} is the energy-corrected blow count (adjusted to 60 percent efficiency).

The energy ratio is one of the most important variables in obtaining reliable N_{60} values. Hence, it is important that energy ratios be measured prior to drilling and sampling for liquefaction assessment for important projects.

The calibration of energy efficiency for a specific drill rig and SPT hammer system is described in the ASTM D 4633 test standard, and uses instrumented strain gages and accelerometer measurements. For routine practice, a drill rig/hammer system with a calibration certificate less than 12 months old is typically sufficient, unless there is reason to believe that the hammer efficiency has changed (eg due to damage and repair, a change of hammers, etc). For large or critical projects, the geotechnical professional or project owner may require a more frequent calibration interval.

Comment

It is important to note that most of the SPT correlations in international geotechnical foundation practice and engineering usage have been developed on the basis of an average energy ratio of 60 percent.

Note: other corrections must also be applied to SPT results for aspects such as borehole diameter, rod length and sampler configuration.

3.3 Test Pits

Test pits or trenching can be a relatively quick and economical method to assess shallow ground conditions. They are particularly useful for in situ examination of the subsurface conditions and for geologic mapping (eg trenching for fault traces), and they allow the collection of large disturbed and undisturbed samples of geomaterials.

Test pits are typically made with a mechanical excavator, the size of which is determined by the required depth of excavation and anticipated excavation conditions. If test pits are to be located within a planned structure footprint, when backfilling the pits it will typically be necessary to properly compact the fill to prevent potentially damaging foundation/floor slab settlement.

It is important to follow appropriate health and safety guidelines/regulations when working in and around test pits as there have been a number of serious injuries as well as deaths resulting from people entering test pits or excavations in unstable ground.

3.4 Plate Load Testing

The plate load test (PLT) theoretically replicates the loading imposed by a small shallow foundation and is used to assess soil stiffness (ie soil modulus of modulus of subgrade reaction) and nominal bearing capacity.

The procedures for the PLT are detailed in the ASTM D 1194 (1994) and BS EN ISO 22476-13. The test consists of loading a rigid metal plate (typically 300 mm diameter or larger—the plate diameter should be at least six times the maximum soil particle size, but typically the larger the better) bedded into the soil or rock layer of interest. Layers are targeted that have the most substantive effect on the deformation or stability of the structure being considered. The PLT can be performed at the ground surface, in a trial pit, at the base of an excavation, or at the bottom of a borehole.

Typically, a heavy machine such as a mechanical excavator is used to provide a reaction force, against which an instrumented hydraulic jacking device is used to load the bearing plate. The deformation of the bearing plate is measured using a reference beam and a dial gauge.

The plate is normally loaded in increments of about one-fifth of the design load. Each load increment is held until the rate of measured settlement reduces to an acceptable level (0.004 mm/min over 60 min — but in soft saturated soils of low permeability, even longer load periods may be required to allow pore pressure dissipation and consolidation as the PLT may otherwise not represent the full potential for long-term

consolidation). The test is terminated when the soil fails, or when the contact pressure is twice the design bearing pressure. The measured results are plotted as time-settlement curves for each applied load, and also as a load-settlement curve for the entire test in order to determine stiffness parameters.

A minimum of three tests are normally required to take account of soil variability. PLT results should be applied only within relatively uniform soil or rock units.

Because the PLT has a limited depth of influence, scale effects should be addressed when extrapolating the results to performance of full-scale footings (Oh & Vanapalli, 2014), giving due consideration to stratification effects.

Soil stiffness parameters determined from the plate load tests are normally higher than the stiffnesses determined from oedometer or triaxial cell tests. These differences are attributed to the lower level of soil disturbance during the plate load test compared to the process of sampling, transporting, and trimming soil samples prior to laboratory testing. The in situ stress state of soils in the field are also different to those found in laboratory tests.

3.5 Pressuremeter Testing

The Pressuremeter Test (PMT) expands a cylindrical probe into the surrounding ground to measure the stress-strain response of the soil. A typical test setup is shown in Figure 3.12.

The PMT can be performed at any number of depths, either within a pre-drilled borehole ('Menard' type PMT, detailed in BS EN ISO 22476-4 and ASTM D4719-20) or with a self-boring pressuremeter (BS EN ISO 22476-6 or ASTM D4719-20) which advances the hole itself, reducing soil disturbance and preserving the K_0 state of stress in the ground (the PMT test is very sensitive to borehole disturbance). Full displacement pressuremeters are also available (BS EN ISO 22476-8) where the probe device is pushed into the ground in a similar manner to a CPT.

Either a fluid or a gas are used to inflate a cylindrical cell, and measurements are made of the 'lift off' pressure, volume change with applied pressure, and the 'limit' pressure. Results are interpreted based on semi-empirical correlations to estimate in situ horizontal stresses, shear strength, bearing capacities, and settlement parameters. The PMT results can also be used to obtain load transfer curves (p-y curves) for lateral load analyses.

Figure 3.12: Test Procedure for the Pre-Bored (Menard) Pressuremeter Test (Mayne et al. 2001)

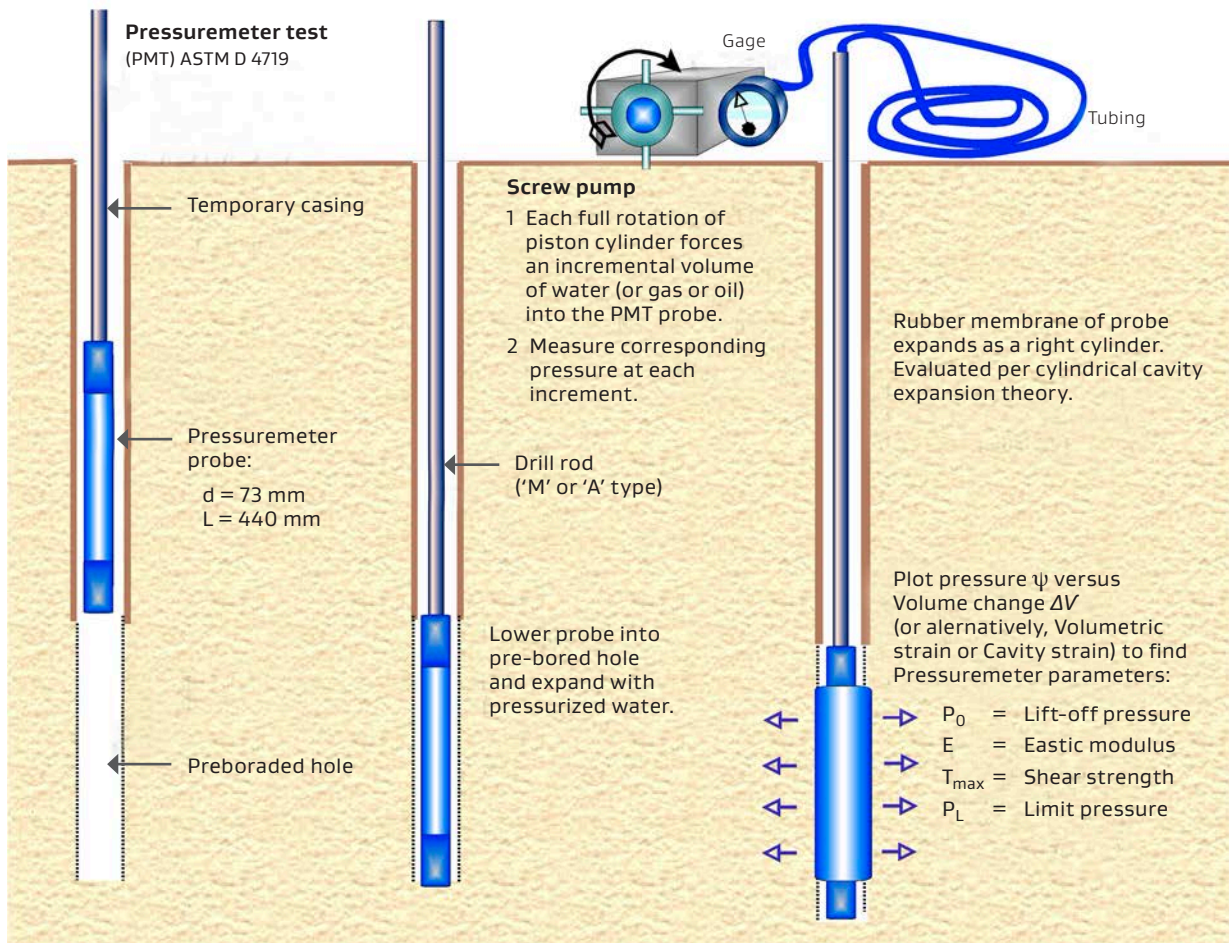

3.6 Dilatometer Test

The Marchetti dilatometer test (DMT) expands a membrane into the surrounding soil to measure the stress-strain response of the soil. International standards for the DMT include BS EN ISO 22476-11 and ASTM D6635

The DMT can generate profiles of horizontal stress, stiffness and strength of soils relatively quickly, normally at 200 mm intervals vertically.

In this test, a 250 mm long, 90 mm wide blade is pushed into the ground. The blade has a flat, 60 mm diameter steel membrane mounted flush on one side. Gas pressure is applied to the membrane to first bring it flush with the soil, and then to advance it a further small increment (1.1 mm). The gas pressure is then reduced until membrane is once again flush with the blade. These three pressures, corrected for membrane

stiffness, are converted to a 'material index' (ID), a horizontal stress index (KD), and the dilatometer modulus (ED) which, through empirical correlations, are used to infer soil type, shear strength, over-consolidation ratio, stiffness and density.

The DMT is suitable for use in sands, silts and clays (ie where the grains are small compared to the membrane diameter) with a very wide range of stiffnesses. Compared to the pressuremeter, the flat dilatometer has the advantage of reduced soil disturbance during penetration.

3.7 In situ Seismic Testing

This section describes various in situ seismic test methods for measuring the shear (S) wave velocity (V_S) and primary/constrained compression (P) wave velocity (V_P) of geomaterials. It is intended to provide a broad overview of the commonly available testing methods. A comprehensive source of information on non-invasive V_S testing can be found in *Guidelines for the good practice of surface wave analysis: a product of the InterPACIFIC project* (Foti et al, 2017). A detailed review of invasive seismic testing can be found in *Invasive Seismic Testing — A Summary of Methods and Good Practice* (Wentz, 2019).

Seismic velocities V_S and V_P are used in a variety of applications in earthquake geotechnical engineering. Accurate determination of V_S within the upper 30 m of the soil profile is needed for seismic site classification using the New Zealand Code (for site subsoil classes A and B), and some international building codes, site-specific seismic response analysis and seismic hazard analysis. V_S can also be directly used in liquefaction triggering analysis (Kayen et al. 2013). V_P can be used to determine the depth at which the soil is fully saturated, as well as to help assess the effect of a partially saturated soil profile when assessing liquefaction hazard.

V_S and V_P are directly linked to several important geotechnical properties including:

- › small-strain shear modulus (G_0)
- › small-strain constrained modulus (M_0)
- › Young's modulus (E); and
- › Poisson's ratio (ν).

Therefore, they are routinely used in soil-foundation-structure-interaction (SFSI) analyses, and sometimes for calculation of foundation settlement.

Unlike laboratory testing, in situ seismic testing does not require undisturbed sampling, maintains in situ stresses during testing and measures the response of a larger volume of soil. Kramer (1996) and Mayne et al. (2001) discuss various geophysical methods for measuring the shear wave velocities of geomaterials.

Comment

Simplified procedures for assessing liquefaction triggering, based on V_S measurements, have been developed (Kayen, et al., 2013; Andrus and Stokoe, 2000). However, the 2013 EQC shallow ground improvement trials in Christchurch (EQC, in press) showed that the results of the V_S -based simplified procedures do not fit well with field observations of liquefaction/land performance during the 4 September 2010 and 22 February 2011 earthquakes. They were also shown to be inconsistent with the results from CPT-based triggering procedures by Idriss and Boulanger (2008) and Boulanger and Idriss (2014). In the Christchurch study, the V_S -based procedures generally underestimated the triggering of liquefaction.

New Zealand-based research also indicates that the V_S -based simplified procedures are not appropriate for estimating the liquefaction resistance of natural pumice sands due to underestimation of cyclic resistance (Asadi et al. 2019).

The use of the V_S -based simplified procedures as the only means of liquefaction assessment is not recommended.

3.7.1 OVERVIEW OF SEISMIC WAVES

There are four basic mechanical waveforms generated within a semi-infinite elastic halfspace. Shear or secondary (S) waves and primary or compression (P) waves are body waves, that is, they propagate spherically from the energy source within the medium and travel through it (ie through the earth). Rayleigh (R) waves and Love (L) waves are hybrid compression/shear waves that occur at the free boundary of the ground surface. Figures 3.13 provides generalised illustrations of P-waves, S-waves and R-waves.

The P-wave is the fastest travelling form of seismic wave and moves as an expanding spherical front emanating from the source with particle motion parallel to the direction of wave propagation. P-waves travel through fluids and solid; inherently causing volume change. In most soils, V_p is primarily controlled by the degree of saturation, and because the V_p of water is approximately 1500 m/s, a V_p measured in soil greater than this value indicates a saturated or near-saturated soil condition (Allen et al. 1980).

The S-wave is the second fastest wave type and expands as a cylindrical front, with particle motion perpendicular to the direction of wave propagation. Hence, one can polarise the wave as vertical (up/down) or horizontal (side-to-side) in relation to the direction of propagation.

S-waves do not result in a volume change of the soil. Because water cannot transmit shear forces, V_s is independent of the degree of soil saturation. (When testing saturated soils, P-waves are generally quite easy to separate from S-waves because they travel in the order of twice the speed or more of S-waves.) V_s is largely controlled by effective stress, material density, and soil age and cementation effects (Richart et al. 1970).

Typical values of V_s and V_p for various materials are shown in Figures 3.14 and 3.15, and typical waveforms generated by seismic testing are shown in Figure 3.16.

R-waves have a near-surface retrograde elliptical particle motion and are sometimes referred to as 'ground roll'. They are produced by the interaction of P-waves and vertical S-waves with the ground surface. L-waves have a particle motion perpendicular to the direction of wave propagation and are produced by the interaction of horizontal S-waves with the ground surface. In layered soil deposits, both R- and L- waves are dispersive, meaning that different wavelengths can travel through the medium at different velocities, based on the velocity of the materials they encounter (Aki and Richards 2003).

Figure 3.13: Particle Displacements with the Passage of P-Waves, S-Waves and Rayleigh Waves (Mayne et al. 2001)

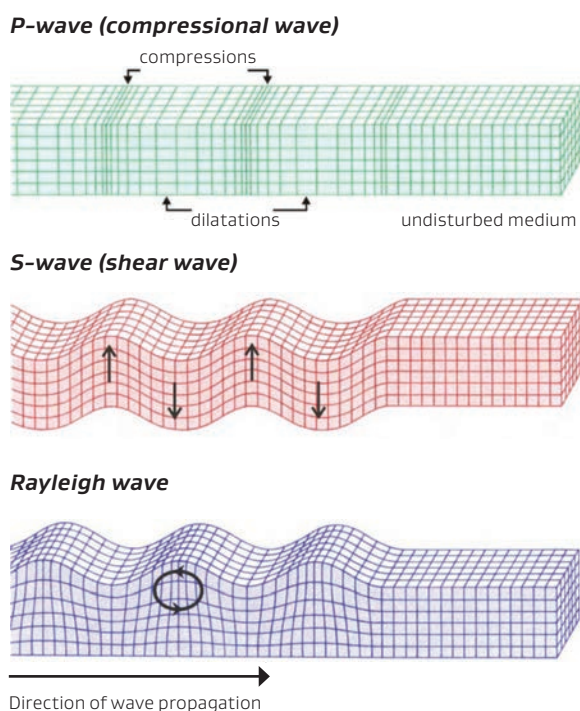

Figure 3.14: Typical P-Wave Velocities of Various Materials (Mayne et al. 2001)

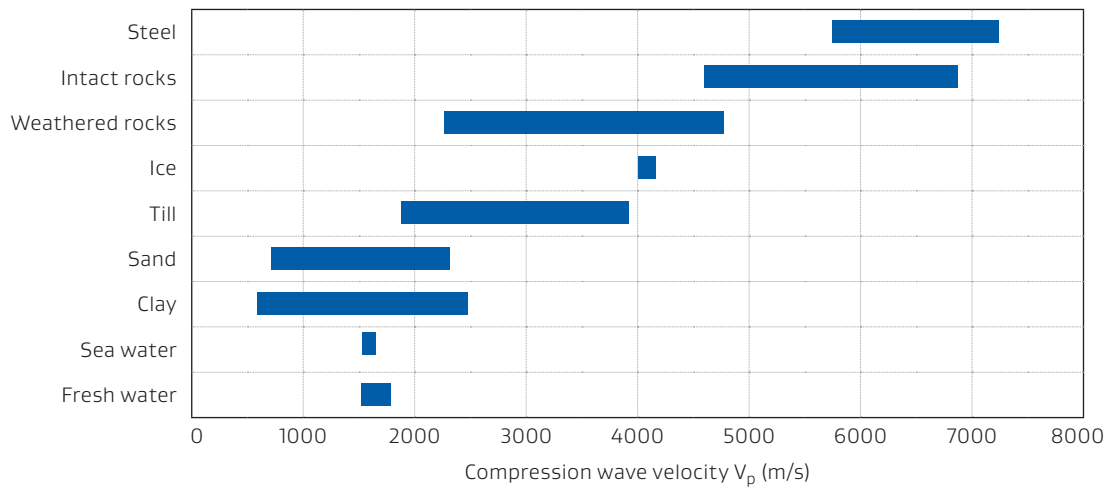

Figure 3.15: Typical S-Wave Velocities of Various Materials (Mayne et al. 2001)

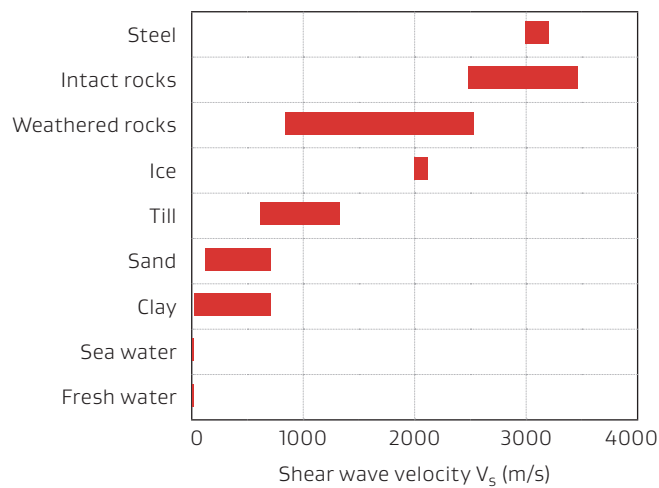
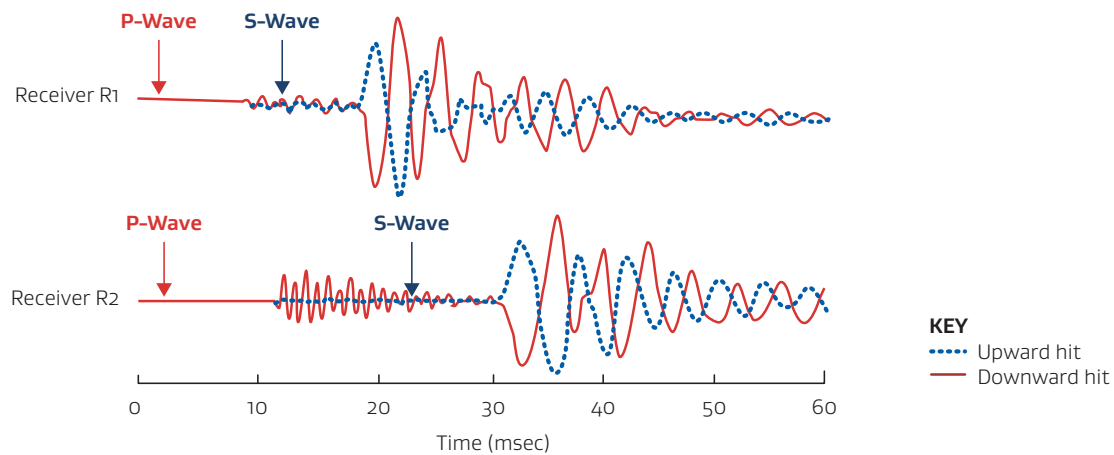

Figure 3.16: Typical Waveforms from Seismic Testing (modified from Kramer 1996)



3.7.2 OVERVIEW OF IN SITU SEISMIC TEST METHODS

In situ seismic testing can be divided into two categories:

- 1 invasive; and
- 2 non-invasive.

Irrespective of the method used, in situ seismic testing requires three main components:

- 1 a source to generate seismic waves
- 2 receivers with transducers (eg geophones or accelerometers) to measure the propagation of the seismic waves at specific locations; and
- 3 a data acquisition system (DAQ) to acquire, digitise and store dynamic signals from the source and receiver(s).

Non-invasive test methods, also known as ‘surface methods’, involve placement of the seismic energy source (or the use of ambient vibrations in the case of passive methods) and receivers on the ground surface. Non-invasive methods that are common in New Zealand geotechnical engineering practice include:

- › multi-channel analysis of surface waves (MASW)
- › seismic refraction (SR)
- › horizontal/vertical spectral ratio (H/V).

Invasive testing requires the seismic energy source to be located either on the ground surface or within the ground, and the receiver(s) to be located within the ground. Downhole methods use a source located at the ground surface and receivers that are advanced to a range of different measurement depths using a single borehole/probe. Crosshole methods use a source and receiver located in separate boreholes/probes located at a common measurement depth, which are then advanced to a range of different depths. Invasive methods were initially borehole-based wherein the source and/or receiver packages are lowered into the borehole and clamped against the borehole wall. Later, direct-push variants of the borehole test methods were developed wherein the instrumentation is installed in apparatus attached to the end of a steel probe which is pushed into the ground. Invasive in situ seismic test methods typically used in New Zealand include:

- › downhole (DH)
- › seismic CPT (sCPT) — direct push equivalent of DH
- › seismic dilatometer (sDMT) — direct push equivalent of DH
- › crosshole (CH)
- › direct push crosshole (DPCH) — direct push equivalent of CH.

Comment

Invasive test methods are generally considered to provide more reliable results (ie contain less uncertainty) than non-invasive methods because they are based on interpretation of local measurements of shear wave travel times, and theoretically provide a good resolution of velocity as a function of depth. However, some studies (Garofalo, 2016) have shown that the uncertainties in V_s profiles developed using invasive methods can be comparable to those developed using non-invasive methods (based on interpretations of the same data by a range of analysts). The key issue is that there are uncertainties associated with both invasive and non-invasive test methods.

Because invasive testing requires at least one borehole or direct push sounding, it is often more expensive to perform than surface wave testing — particularly when obtaining deep

information. While acquisition of surface wave data requires comparatively less effort (ie the field work is less), the processing and inversion of the data required to obtain reliable results are much more computationally intensive than what is required for invasive testing.

When comparing invasive and non-invasive methods, it is important to note that the results from invasive methods are only representative of the soil column located immediately adjacent to the borehole/probe (or in the case of cross-hole testing, the soils located between the source and receiver at the depth of the test). In contrast, the results from surface-wave methods are representative of the entire volume of material underlying the array(s). Hence, differences in the V_s obtained with the two classes of methods can be expected simply based on the ‘sampling’ of different volumes of a vertical and lateral heterogeneous material.

Figure 3.17: Summary of various seismic methods and the steps required to produce seismic velocity data for each (Wotherspoon et al. in press)

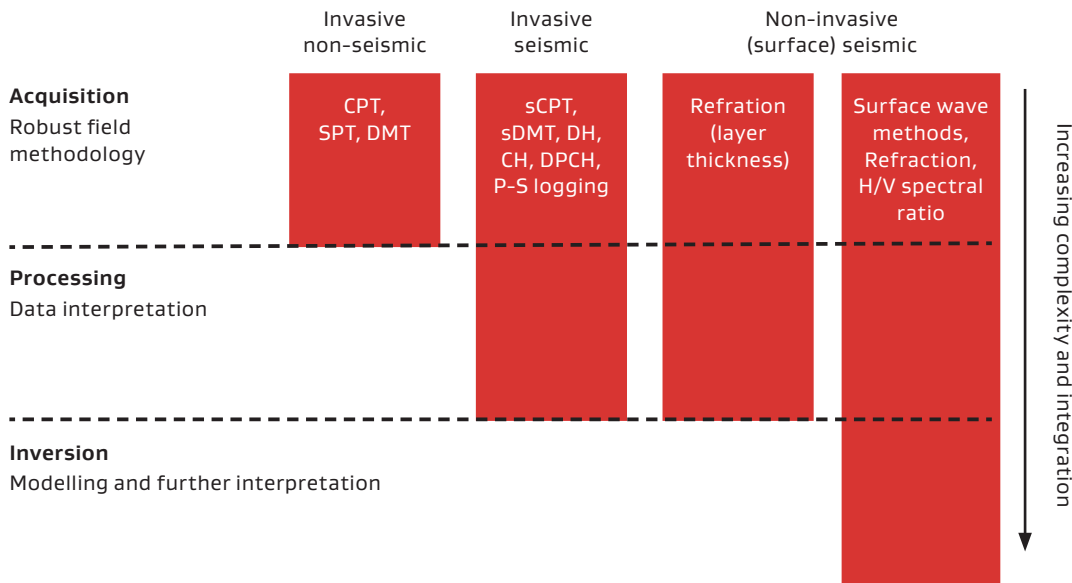

Figure 3.17 summarises the key steps that are required for each method in order to output the parameters required to inform engineering design. All methods require the acquisition of data through a robust field methodology, with seismic methods requiring the processing of data into a format that enables interpretation and the development design parameters. Some methods require the additional step of inversion, involving the use of modelling and further interpretation.

Comment

The increased use of in situ seismic testing has highlighted a need for better understanding of some of the key aspects of these methods, related to all three steps illustrated in Figure 3-17. The primary issues identified as needing to be addressed and improved are:

- > the use of correct field acquisition methodologies
- > the correct use of processing and inversion techniques — a key issue for surface seismic methods
- > increased understanding the limitations of the different methods
- > acknowledging and quantifying the uncertainties associated with the methods

Comment

There are numerous published correlations for computing V_S from cone penetration test (CPT) tip resistance (q_c) and standard penetration test (SPT) N-values. V_S is a small-strain measurement (in the order of 10^{-3} percent strain or less) while SPT and CPT are large-strain measurements (ie associated with soil failure). While correlations can be useful to check if the measured V_S profile is following the expected trend (ie V_S , q_c and N should generally rise and fall together), there is not a one-to-one relation between them. Also, there is significant scatter in the data used to develop the correlations. Therefore, correlations with CPT and SPT test values should only be used as a check or initial assessment of V_S (Cox 2018, GEESD V).

If a region-specific correlation between V_S and CPT or SPT is used, it should be done so with an understanding of its applicability and limitations (regional context, acknowledgement of variability and uncertainty). Direct measurement of V_S is the most robust approach to obtaining a representative velocity profile.

3-7-3 NON-INVASIVE (SURFACE WAVE) METHODS

General

Surface wave testing methods use the propagation of surface waves (most commonly Rayleigh waves, but also Love waves), and the relationship between surface wave velocities and shear wave velocities, to develop shear wave velocity profiles. Rayleigh waves have an elliptical particle motion, meaning particle movement both in line and perpendicular to the wave propagation direction, as shown in Figure 3.18a. Rayleigh wave velocity (V_R) is similar to V_S , with $V_S \approx 1.1V_R$, and importantly for surface wave testing, Rayleigh waves are dispersive in layered deposits.

The dispersive nature of Rayleigh waves means that different wavelengths will travel at different velocities. Figure 3.18b shows an idealized soil profile with different Rayleigh wave wavelengths. Surface waves of different wavelengths sample different depths of a material profile. For surface waves, the bulk of the wave energy is limited to one wavelength in depth. As the wavelength increases (or frequency decreases), the particle motion extends to a greater depth in the profile. Accordingly, the velocities of the surface waves are representative of the stiffness of the material to the depth where there is significant particle motion. It is possible to evaluate the properties of materials over a range of depths using surface waves with a range of wavelengths.

Figure 3.18:

a) Characteristics of Rayleigh waves (Foti et al. 2017)

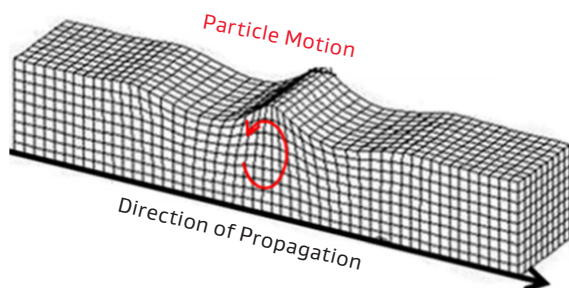

Surface wave methods rely on the fundamental assumption that the medium being tested is laterally homogeneous. Therefore, they are less applicable at sites where there are large lateral changes in the thickness or composition of soil layers. Testing should be carried out on relatively level ground, as significant changes in topography along a survey line affect the nature of propagation of the surface waves along the line. The length of the testing area can be a limitation, as it needs to be approximately twice the length of the target depth of the survey.

As illustrated previously in Figure 3.17, the main steps in surface wave testing are:

- 1 field data acquisition
- 2 signal processing to develop dispersion curve
- 3 inversion to estimate shear wave velocity profile.

Non-invasive seismic investigation methods can be based on surface waves that are generated by an 'active' source (ie an artificial, purpose-specific source at a known location) or a 'passive' source (ie ambient vibration from natural and anthropogenic sources). The source type determines the appropriate field setup for data acquisition (step 1 above), as described in the next sections. However, the signal processing and inversion (steps 2 and 3 above) have commonalities across active and passive source methods.

b) Schematic of the propagation of Rayleigh waves of different wave lengths (Wotherspoon et al. in press)

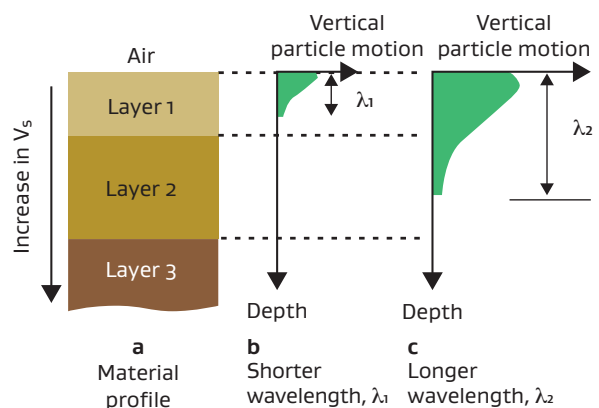

Comment

Because surface wave methods are generally quick to perform in the field and considerably less expensive than invasive methods, they are often preferred. However, the dispersion processing and inversion of surface wave data required to produce reliable results requires the knowledge and judgement of an experienced analyst. Somewhat paradoxically, the availability of 'black-box' processing software has encouraged the use of surface wave methods by contractors/end-users lacking the necessary expertise to correctly interpret the data. The incorrect interpretation of surface wave data may lead to significant errors in the resulting V_S profile.

The following discussion of surface wave testing is intended to provide a general overview of the acquisition, processing and inversion of data associated with the methods. These are described in more detail in Foti et al. (2017).

Active Source Methods

Active source methods use a seismic source at a known location and receivers at known locations to record the propagation of surface waves (most commonly, Rayleigh waves). In New Zealand, the most common active source surface wave method is MASW — multi-channel analysis of surface waves — first proposed in the late 1990's (Park et al. 1999). MASW uses multiple receivers and is an extension of the earlier spectral analysis of surface wave (SASW) method which uses only two receivers (Stokoe and Nazarian, 1985). MASW was specifically developed to take advantage of the multichannel capabilities of modern seismograph equipment to reduce testing time compared to SASW.

Acquisition of Active Source Field Data

Active source data is collected using a linear array of vertical geophones to record the wave propagation from an in-line source through the array (Figure 3.19). The natural frequency of the geophones must be adequate to sample the expected frequency band of surface waves without distortion. For investigation depths of up to about 30 m, geophones with a natural frequency of 4.5 Hz are generally adequate. The geophones must have good connection with the ground, and this is achieved either through the use of small tripod feet on hard surfaces, or short spikes that can be pushed into the soil. A minimum of a 24-geophone array is recommended to confidently assure adequate sampling of the seismic waves.

The seismic source that generates the surface waves can range from a sledgehammer to larger portable sources such as drop weights or accelerated masses. Whatever the source, it must produce vibrational energy over the frequency band appropriate for the target investigation depth (with an adequate signal-to-noise ratio). This may require making an estimate of the expected velocity range within the depth of investigation in order to estimate the required frequency band of the seismic source. Using a large tracked bulldozer, such as a Caterpillar D8 running back and forth over a small distance can allow depths of investigation from 30 to 60+ m. Low frequency generating vibroseis units have the capability to profile to depths of 30 to 100+ m (Stokoe et al., 2006). For soft sites, a lower frequency source will be necessary to achieve the same investigation depth than at a stiff site. For routine investigations, a commonly used source is a 6 to 8 kg sledgehammer impacting a steel or rubber strike plate on the ground surface. However, its limited low frequency energy generation means that the depth of investigation will often be limited to around 10 to 20 m, particularly in soft sedimentary soils.

Figure 3.19: Active source array. L = array length, ΔX = geophone spacing, shot = source location (Foti et al. 2017)

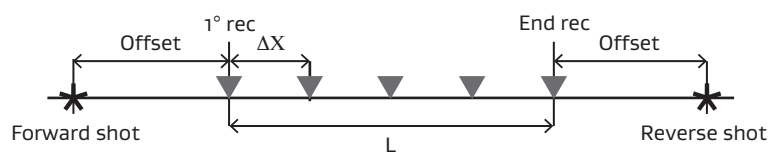

For a sledgehammer energy source located off the end of the geophone array, the length of the array ('L' in Figure 3.19) should be approximately twice the target depth of investigation. For example, a commonly used array of 24 geophones spaced 2 m apart (ie $L = 46$ m) would be adequate for an investigation depth of in the order of 20 m. For a deeper investigation depth, different sources, larger source offsets, or larger geophone spacings may be required.

Good practice includes attaching a trigger to the seismic source so that the time of the initiation of the source can be recorded, and 'stacking' multiple impacts ('shots') in order to improve the signal-to-noise ratio (ie the quality of the signal). It is also good practice to use multiple different source offsets from each end of the array. This allows for identification of any lateral variability beneath the array, and to account for near source effects, which could lead to an inaccurate representation of V_S . Throughout the data collection, signal quality be carefully checked.

The product of the field data acquisition is velocity time series data for each geophone for the range of source offsets used as shown in Figure 3.20.

Figure 3.20: Example of raw time series data from acquisition using 46 geophones (Cox and Wotherspoon, 2018)

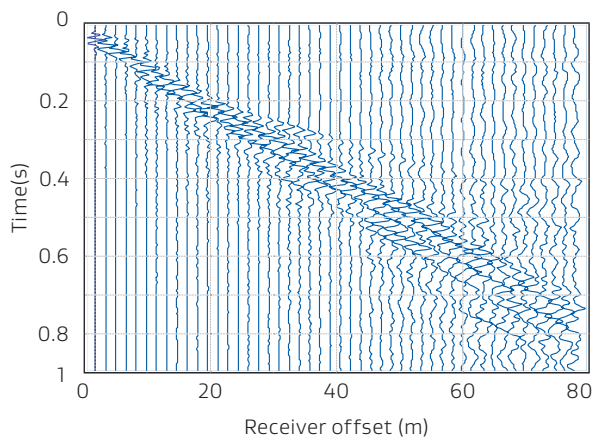

Passive Source Methods

Passive surface-wave analysis uses measurements of ambient vibrations that are produced from a variety of sources — there is no need for an investigation-specific artificial seismic source. In passive seismic testing, the terms 'noise' and 'signal' are sometimes confused. The 'signal' is what we wish to analyse, and 'noise' is what is disturbing the signal processing. Examples of noise include:

- > sensor instrument self-noise
- > wind or rain
- > thermal fluctuation; and
- > bad sensor coupling with the soil.

Sources of ambient vibrations ('signal') include, but are not limited to, vehicle traffic, construction/ industrial activities, micro-seismicity, ocean waves, wind acting on trees. The signal for passive seismic testing is typically highly variable from one site to another, and this variability directly affects the ability to obtain reliable results.

Comment

For passive seismic testing, there is no 'set' rule or rules that can be used to define what type or number of sensors is necessary, or what sensor layout geometry is sufficient for a particular site as these are largely determined by the site conditions and ambient vibration level (ie the 'signal strength'). This is discussed in more detail in the following section; however, it also highlights the need for appropriately qualified and experienced personnel to conduct passive seismic testing in order to obtain reliable results.

Developing good resolution of near-surface soil layering, such as that often required for geotechnical engineering assessment requires measuring short wave lengths (ie high frequencies) which may be difficult with passive source methods alone. Therefore, it is recommended that passive surveys be used in combination with a MASW investigation in cases where resolution of the near-surface soils is important.

Acquisition of Passive Source Field Data

Vertical geophones are typically adequate for acquisition of passive surface (Rayleigh) waves when obtaining a dispersion curve is the primary objective. Geophones with a natural frequency of 4.5 Hz — as used for MASW — are generally adequate for depths of up to about 30 m if there is a high level of ambient vibration. For characterisation of deep structures (eg 100 m or more), velocimeters or seismometers with natural periods of 1 to 30 sec are more appropriate for data acquisition. The use of velocimeters or seismometers is also recommended on sites where there is a low level of ambient vibration because they are more sensitive than geophones. The use of these sensors sometimes requires particular attention during setup and signal processing (eg perfect levelling, long stabilization time of acquisition system, proper high-pass filtering prior to signal windowing) which can limit their use for routine commercial investigations and by non-expert users.

The use of an ‘intermediate’ period seismometer is often a good compromise for the above situations. The use of accelerometers is not recommended as they are not sensitive enough to achieve proper acquisition on sites exhibiting low-amplitude vibrations.

It is recommended that passive source data be collected using 2D sensor arrays because the ambient vibrations are, in most cases, expected to propagate from multiple and unknown directions (as opposed to an active source investigation where the location of the seismic source relative to the receivers is known). For this reason, the array geometry should have no preferential direction(s). Circular or triangular-shaped arrays are examples of this. For sites where the presence of obstacles limits the use of complex array shapes, T- or L-shaped arrays can also be used. Commonly used passive array geometries are shown in Figure 3.21.

Figure 3.21: Commonly used array geometries for passive source data acquisition (Foti et al. 2017):

a) circular

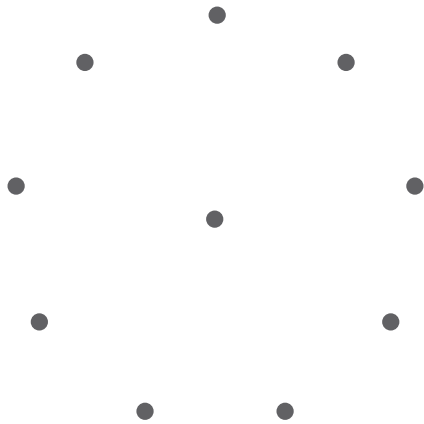

b) nested triangles

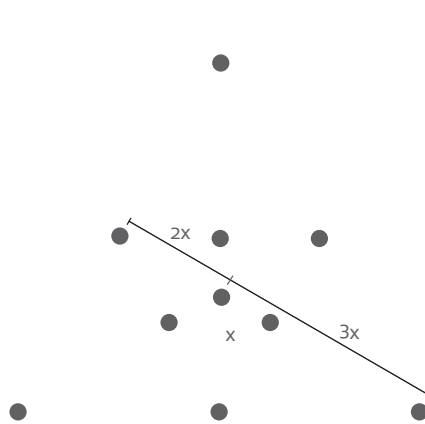

c) T-shape

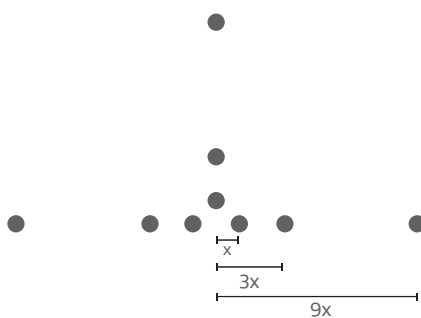

d) L-shape

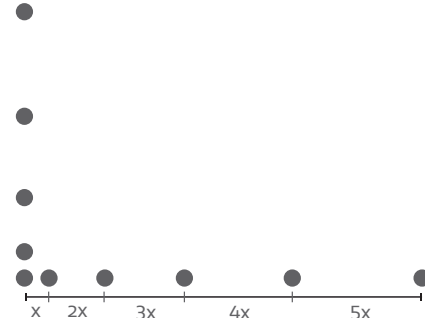

There is no minimum required number of receivers/geophones for passive testing. Foti et al (2017) recommend using at least four sensors but note that the use of 8 to 10 sensors will give better results and is still quite manageable in the field. In any case, at sites with a low level of ambient vibrations, a higher number of receivers will increase the probability of correctly measuring the dispersion. In general, the more sensors used, the better the results will be — noting that there are practical limitations with respect to equipment cost and setup time.

Comment

The use of linear arrays for passive source testing such as the Refraction Micro-tremor (ReMi) technique is quite common. However, the use of linear arrays has been strongly discouraged by the authors of a well-known international study that compared invasive and non-invasive methods for seismic site characterization (Garofalo et al. 2016). This is because the use of a linear array assumes either a homogeneous, isotropic distribution of ambient vibrations around the site, or passive sources in-line with the linear array. In many instances, these assumptions are likely to be incorrect given the inherent randomness of potential ambient sources, and in any case, it is not possible to verify the assumptions using data from a linear array.

The investigation results from a linear array can be strongly biased in the case of non-homogenous source distribution or out-of-line directional propagation, and this can result in an overestimation of the V_S of the soil profile. Therefore, it is recommended that 2D passive arrays be used whenever possible, and that caution should be used when only using linear passive arrays. If 1D passive arrays are used, they should be combined with active source methods to enable comparisons with a more theoretically robust method. More information can be found in Cox and Beekman (2010) and Strobbia and Cassiani (2011).

Processing

The following discussion is generally applicable to both active and passive source data. The aim of processing is to extract the ‘experimental’ (ie measured) dispersion data that is representative of the soil/rock beneath the array using the velocity time series data from each geophone location. The experimental dispersion curve (as illustrated in Figures 3.22a and 3.22b) shows the Rayleigh wave velocity (phase velocity) for each wavelength or frequency that has been measured (noting that all three are linked as discussed above). While it is common to plot phase velocity with frequency, it is also useful to plot phase velocity with wavelength, as wavelength is related to depth within the soil profile (refer to Figure 3.24 later in this section).

Figure 3.22: Examples of experimental dispersion curves (Foti et al. 2017):
(Note: mean and +/- 1 standard deviation are shown)

a) using frequency

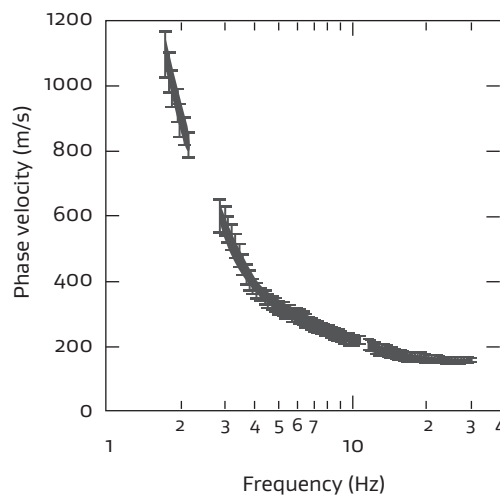

b) using wavelength

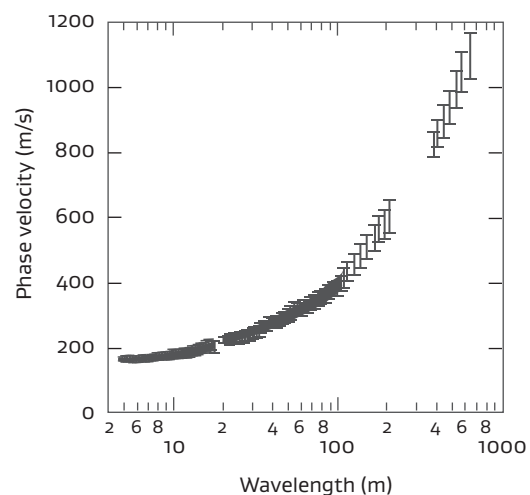

There is a range of methods available to convert the velocity time series data from each geophone — which represent time (sec) and space (m) — to a frequency (Hz) and wavenumber (1/m). This ‘wavefield’ transformation approach creates a surface plot relating phase velocity, frequency and energy, and the peaks in the surface at each frequency/wavelength are extracted to define the experimental dispersion curve. The various transformation methods, when done correctly, will often result in comparable dispersion curve estimates. The wavefield transformation (from which the experimental dispersion curve is derived) is illustrated in Figure 3.23.

Comment

The quality of the V_S data collected will be reflected in the quality of the dispersion curve extracted. The commonly used methods for processing active source data require the picking of amplitude peaks in 2D spectral representations of the wavefield. This data should be provided and the picks of the peaks representing the dispersion curves presented, as the quality of this data can be visually assessed by someone with a limited knowledge of the processing methods.

It is important to try to quantify the uncertainty in this experimental data, as this will have a significant influence on the inversion process. The use of MASW data collected from multiple source offsets enables the characterisation of this uncertainty. An illustration of this is shown in Figures 3.22a and 3.22b above, where the mean and ± 1 standard deviation of the experimental dispersion data are

Figure 3.23: Example of waveform transformation (Cox and Wotherspoon, 2018)

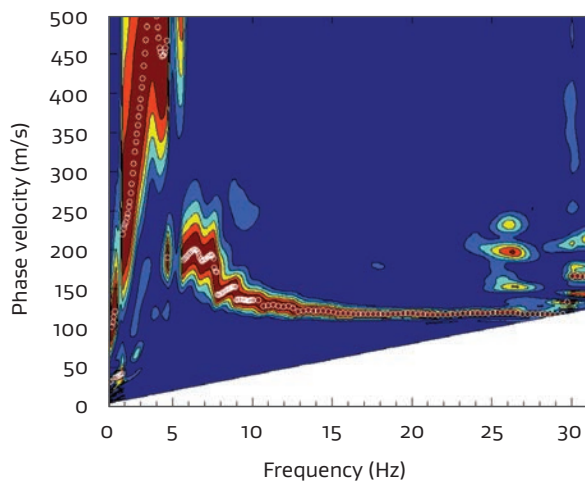

plotted. The extracted experimental dispersion curve data can then be used to provide an initial estimate of the bounds of velocities and depths that can be extracted in the inversion process that follows.

With reference to the diagram shown in Figure 3.24, the dispersion curve provides an initial indication of the bounds of information that can be reasonably extracted from the surface wave data during the inversion process. The minimum wavelength (λ_{min}) in the dispersion curve data is equal to approximately twice the minimum depth that can be resolved. One-half to one-third of the maximum wavelength (λ_{max}) can provide an estimate of the maximum depth that can be resolved. As $V_S \approx 1.1V_R$, estimates of the V_S of the surface layer can be estimated.

For example, the information that can be immediately extracted from Figure 3.24 includes the following:

- › Surface layers less than about 2.5 m in thickness (ie $\lambda_{min}/2$) cannot be resolved.
- › Layers deeper than about 200 to 300 m (ie $\lambda_{max}/2$ or 3) cannot be resolved.
- › The V_S of the surface layer is approximately 200 m/s (ie $1.1 * V_R$ at λ_{min}).
- › The V_S of the deepest layer is greater than 1200 m/s (ie $1.1 * V_R$ at λ_{max}).

There are several other complex factors that should be assessed in the processing stage; however, these are outside the scope of this document, and the reader is referred to Foti et al. (2017) for further information.

In any event, an experienced analyst is needed to be able to interpret the processed data to then inform the inversion stage of the analysis.

Figure 3.24: Example of dispersion curve with interpretations (Cox and Wotherspoon, 2018)

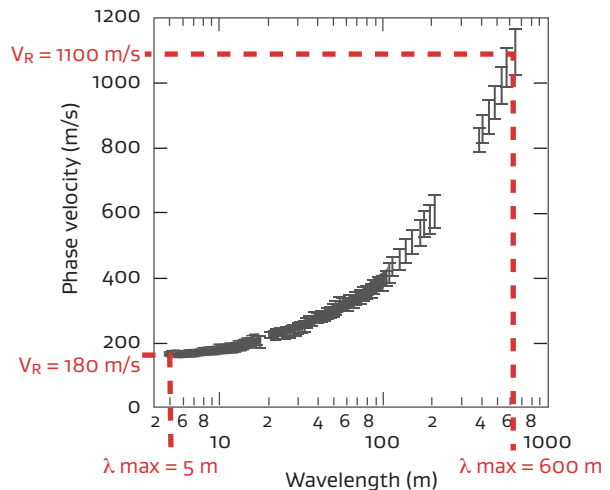

Inversion to estimate shear wave velocity profile

As with processing to obtain the experimental dispersion curve, the following discussion on inversion is generally applicable to both active and passive source methods. The aim of inversion is to develop a model of the layers of the subsurface soil profile that has a theoretical dispersion curve that matches well with the experimental dispersion curve data discussed above. An example of this is shown in Figure 3.25a, which compares an experimental dispersion dataset with a number of theoretical dispersion curves. To perform the inversion, the subsurface is modelled as an assumed number of linear elastic layers over a half space. Each layer is assigned a thickness, density, V_S and V_P . A theoretical dispersion curve is then calculated for the model and compared to the experimental dispersion curve to assess the fit, typically in form of a misfit function. The properties of the system are then iteratively revised until a satisfactory fit is achieved.

Comment

A number of different inversion approaches are possible, and the key issues are:

- › The relationship between the experimental data space and the model space is nonlinear.
- › Four model parameters are recovered indirectly from two experimental data parameters.
- › The model solution for deeper layers is dependent on the solution for shallower layers.

As a result, there will be a large number of models that will fit the experimental data equally well. Therefore, rather than providing a single, deterministic V_S profile for a site, the inversion process should provide a suite of theoretical profiles that fit the experimental data well and allow for a measure of the epistemic (ie 'knowledge') uncertainty to be reported. Hundreds of thousands of possible profiles should typically be considered in each inversion, and any of the models with a sufficiently good match (ie low misfit) to the experimental data may be representative of the velocity structure at the site.

The user-defined constraints for setting up the inversion (ie the 'parameterization') can have a significant impact on the V_S profiles that are extracted. Layer thickness and V_S are the parameters that have the greatest influence on the dispersion curve while V_P and density have a much smaller influence. If there is knowledge of subsurface layering characteristics from physical investigation data (eg CPT or borehole data), this should be used to help constrain the inversion and reduce the number of unknowns (ie the range of thicknesses of the layers and their properties).

The number of assumed layers must also be carefully selected in order to avoid over-parameterization (ie too many layers) which results in an unreliable final model because of a lack of available information to constrain the inversion (known as an over-determined inversion). Alternatively, the number of assumed model layers must be sufficient to adequately reproduce the variation of the profile with depth — particularly at shallow depths.

Comment

Ideally, the inversion should use a number of different trial parameterizations. There are no specific rules for parameterization, and the selection is up to the analyst. The variability of the results of the inversion as a result of different layer-model choices is a typical example of the epistemic uncertainty associated with surface wave investigation.

If there is no knowledge of the subsurface layering and associated soil properties, the parameterization should be set up to reduce the range of possible solutions, and also avoid over-constraint of the inversion. Cox & Teague (2016) provide guidance on systematically selecting trial parameterizations when performing inversions without the benefit of a-priori information to inform the choice of subsurface layering.

It is not uncommon for parameterizations to be set up that result in equal layer thicknesses throughout the soil profile. This is not good practice as it can over-constrain the inversion resulting in unrealistic velocity profiles.

An example of the effect of the parameterization is shown in Figure 3.25. For illustration purposes, only a single V_S profile and theoretical dispersion curve is shown. The true solution used to develop the mean dispersion curve data is also shown. Four models with different numbers of layers were defined to illustrate how well they could match the true solution. Figure 3.25a shows that based on a visual assessment, the match between the experimental dispersion curve and the theoretical curves for all four models are quite similar. However, a comparison of the resulting V_S profiles (Figure 3.25b) shows a distinct variation in characteristics. For the three models with 9 layers or less, the match with the true solution is reasonably good; noting that a poorer match is achieved for the 3- and 5-layer models between a depth of 9 and 17 m. The clear outlier is the 20-layer solution. The key observation is that even though more layers might suggest

better resolution, the match with the true solution is poor throughout the entire profile. In this case, the inversion has tried to get the best fit with the experimental data, but because so many layers have been defined, each change in slope in the dispersion curve has been captured resulting in over-constraining the data.

Clearly this type of situation should be avoided when running an inversion, because even though the results fit well with the experimental data, the resulting V_S profile does not reflect the actual site V_S profile. Therefore, an assessment of the quality of the inversion should consider the fit of the theoretical data to the experimental, but also include a check that the V_S profile is generally consistent with any known geologic or geotechnical information for the site. This would of course require that such a-priori information is available.

Figure 3.25 (Wotherspoon et al. in press):

a) Experimental dispersion curve data with error bounds and the fit of four theoretical dispersion curves from the V_S profiles in (b)

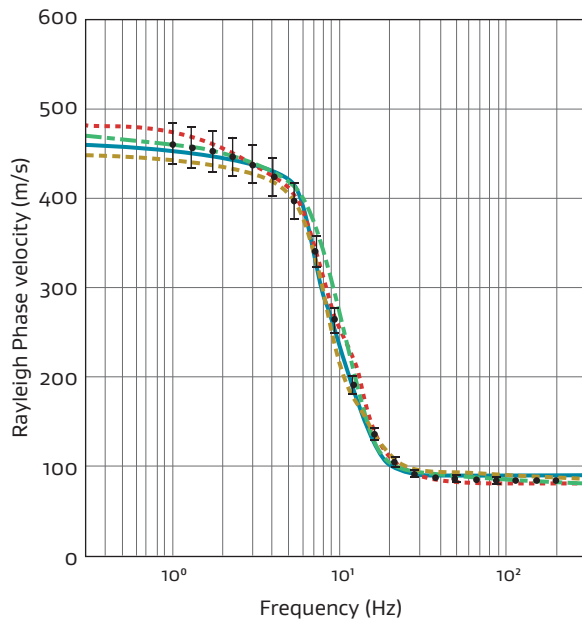

b) range of possible V_S profiles with different numbers of layers

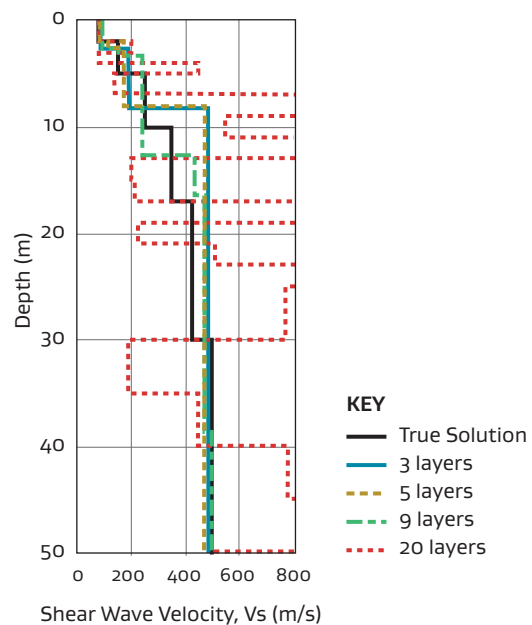

Comment

For MASW testing, the processing and inversion steps described above are required in order to extract a single suite of V_S profiles that are representative of the soils beneath a single geophone array (ie 1D profiles). 2D MASW is used to develop surface plots of the variation of V_S with depth along a section. This is done by combining the 1D profiles extracted from two or more different array locations. To develop the surface plots that represent the variability in V_S along the section, the 1D V_S profiles from each array are interpolated between the mid-point of each array location. The resolution of these 2D profiles is therefore dependant on the spacing between each array and the effect of averaging of the properties between each array length (typically 46 m). As such, interpretation of the variation in V_S along the section needs to take these factors into account.

The sources of uncertainty associated with the development of the 1D V_S profiles should be taken into account and incorporated into the 2D interpolation; however, this is seldom done. This is done by incorporating good practice procedures during the development of the 1D profiles. This includes using multiple source offsets and signal stacking during data acquisition, including uncertainty in dispersion curve estimates, and developing a range of potential V_S profiles with different numbers of layers for each array location.

Neglecting to maintain these good practice techniques can result in surface plots of V_S along a section that are not representative of the ground conditions.

Horizontal-to-Vertical Spectral Ratio Method

Horizontal-to-vertical spectral ratio testing (H/V — also referred to as the ‘the Nakamura method’) is often used to estimate the fundamental period of soil deposits (ie the site period, T_0), and is specified as a method for determining the Site Subsoil Class in NZS 1170.5:2004. It is also sometimes used to obtain additional experimental data that can be added to the dispersion curve in the inversion process. It makes use of low-frequency information not available in dispersion curves which helps improve the resolution at depth, especially for identifying deep interfaces.

The method uses 3D single-station measurements of ambient vibrations at the ground surface using a 3-component geophone or seismometer, from which average spectral ratios of horizontal (H) and vertical (V) ground motion components are computed. Due to its low-cost both for the survey and analysis, the H/V method has been frequently adopted in seismic microzonation and local site response investigations. However, the H/V method alone is not sufficient to characterise the complexity of site effects, and in particular the absolute values of seismic amplification. An important requirement for the application of the H/V method is a good knowledge of engineering seismology combined with background information on local geological conditions supported by geophysical and geotechnical data.

Detailed information on H/V measurements, processing and interpretation can be found in Molnar et al. (2018).

Seismic Refraction Method

Seismic refraction (SR) involves a mapping of S-wave or P-wave arrivals using a linear array of seismic sources and geophones across the site, as illustrated in Figure 3.26. An elastic wavefront will be refracted according to Snell’s Law when it impinges on a boundary between two materials with a seismic impedance ($Z = \text{density} \times \text{velocity}$) contrast. At the critical angle of incidence, a non-planar wavefront (eg radiating from a point source) refracts along the boundary and radiates sufficient energy back to the surface yielding so-called ‘head-wave’ refractions. The velocity of, and depth to, the refracting surface can be calculated by measuring the travel time of the seismic waves between the source and the receivers.

Standard seismic refraction methodology for near-surface materials was developed over 50 years ago and has been routinely used around the world. The ASTM D 5777 (2018) test standard describes the equipment and methodology of the refraction technique. Most early refraction applications used P-wave technology with vertical impact weight-drop or explosive sources and vertically-polarized geophones. Similar procedures are employed for S-wave refraction, using polarized shear wave radiation from horizontal sources and horizontal geophones (Hunter et al., 1992, 1998, and 2002). This methodology is similar to that described in ASTM D 5777 for P-waves.

Figure 3.26: Schematic of Seismic Refraction Array and S-Wave Travel Paths

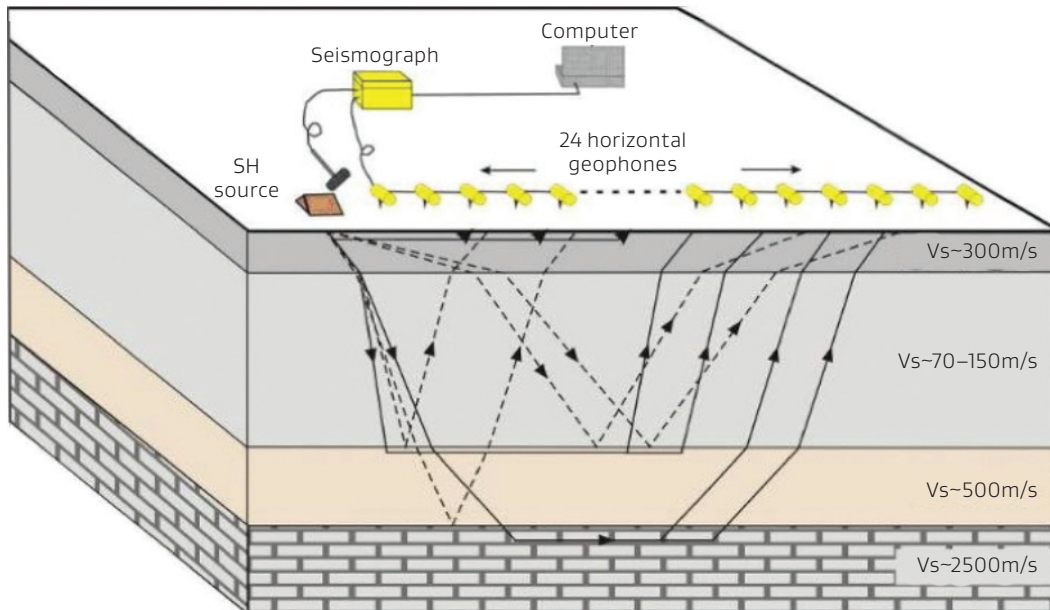

The SR method requires that S- and P-wave velocities increase with depth. Therefore, an important limitation of the approach is the inability to detect velocity reversals. In such an environment, other techniques (MASW, Downhole) may be more appropriate. In addition, if V_S increases in step-wise fashion with depth, a velocity layer must have a minimum thickness to be detected. This phenomenon is often referred to as the 'hidden layer' or 'blind zone' problem and the potential scale of this limitation can be significant. Refractions are low amplitude events, and in field environments where signal-to-noise ratios (S/N) are low, such events may be very difficult to observe. As well, significant velocity discontinuity layering may be dipping, and the down-dip or up-dip apparent velocities may vary considerably for relatively low angles. Therefore, good practice requires the collection of records for forward and reverse shot positions for a given geophone array. The measured up and down dip velocities can be averaged arithmetically to estimate refractor velocities for small dip angles (usually less than 20 degrees for common overburden-bedrock velocity contrasts).

Good practice involves positioning one or more sources within the geophone array, plus one at each of the array and one or more off-set from each end of the array. Clear delineation of target layers across a site is achieved by moving the array and repeating the procedure.

In general, geophone array length to refractor depth ratios must be quite large (~5 or more) in order for the refraction event from a high-velocity layer to be observable as a first arrival. Shorter arrays can be used where impedance contrasts between the layers are large ($Z > 20$, ie soft soil over hard bedrock). However, there is an increased possibility of hidden layer error.

In using SR it is typically assumed that the subsurface profile comprises a series of discrete layers within which V_S is constant or varies in a simple manner. SR provides lower resolution of the subsurface velocity profile than MASW, however the simpler data acquisition and processing involved mean that the SR method typically costs less. The SR method is often used to determine the depth to bedrock at a site. It can also be useful to determine the degree of rippability of different rock materials (Caterpillar Equipment publishes rippability charts based on shear wave velocity for some of their bulldozers).

3-7-4 INVASIVE METHODS

This section is intended to provide a general overview of the more common invasive seismic test methods and highlight some of the more important issues that should be considered by both contractors and end-users. More details on invasive seismic testing are provided in Wentz (2019).

Downhole Methods

Downhole methods use a source located at the ground surface and receivers that are advanced to a range of different measurement depths using a single borehole/probe. Methods typically used in New Zealand are the borehole-based downhole (DH), the seismic CPT (sCPT) and the seismic DMT (sDMT). The principles and procedures associated with downhole (DH) seismic testing, whether using a borehole or direct push method (ie sCPT or sDMT), are similar. Therefore, the following discussion does not differentiate between borehole and direct push methods unless there is a need to clarify a particular aspect of a method.

Acquisition of Downhole Data

Downhole seismic testing is conducted by generating seismic waves (S-waves or P-waves) at the ground surface and measuring the wave arrival times at a receiver lowered (borehole method) or pushed (direct push method) into the ground. The wave travel path is typically assumed as the straight-line/slant distance from the source to the receiver. However, this assumption is not always valid and the actual wave travel path is unknown; particularly over the top several metres of the

subsurface (note: the assumption is reasonable at greater depths). The general equipment and procedures for conducting the downhole method are outlined in the ASTM test standard D7400 (2017). A schematic of the field setup for downhole methods is shown in Figure 3.27.

DH methods use a source offset (X) a short distance from the location of the borehole/probe at the ground surface (1-3 m is typically recommended), and receiver(s) at depth. For V_S testing, impacts on the ends of a shear plank oriented perpendicular to the offset dimension from the borehole/probe should be used. This creates downward propagating, horizontally polarised shear waves (S_{VH} waves). Figure 3.27 illustrates one possible ray path for each receiver location, which represents the direct wave from source to receiver. The impact on the shear plank triggers the start of the data acquisition system (DAQ), and this is recorded by receiver(s) orientated horizontally to record the horizontal particle motion. To develop a V_S profile this setup is repeated with the receiver(s) located at a range of different depths.

For all DH methods, achieving good coupling between the ground and the borehole/probe is important. Because the probe is pushed directly into the ground using sCPT and sDMT, coupling is usually good. The success of borehole methods relies on achieving a continuous solid grout contact between the borehole casing and surrounding soil/rock, otherwise wave propagation will be poor. This is a key aspect of the field work and care should be taken to ensure a good grouting methodology.

Figure 3.27: Schematic of the setup for downhole (sCPT) test, with a single receiver shown for two different test depths. Lines L_1 and L_2 represent assumed straight-line travel paths of seismic waves from the shear beam to the receivers located at depths D_1 and D_2

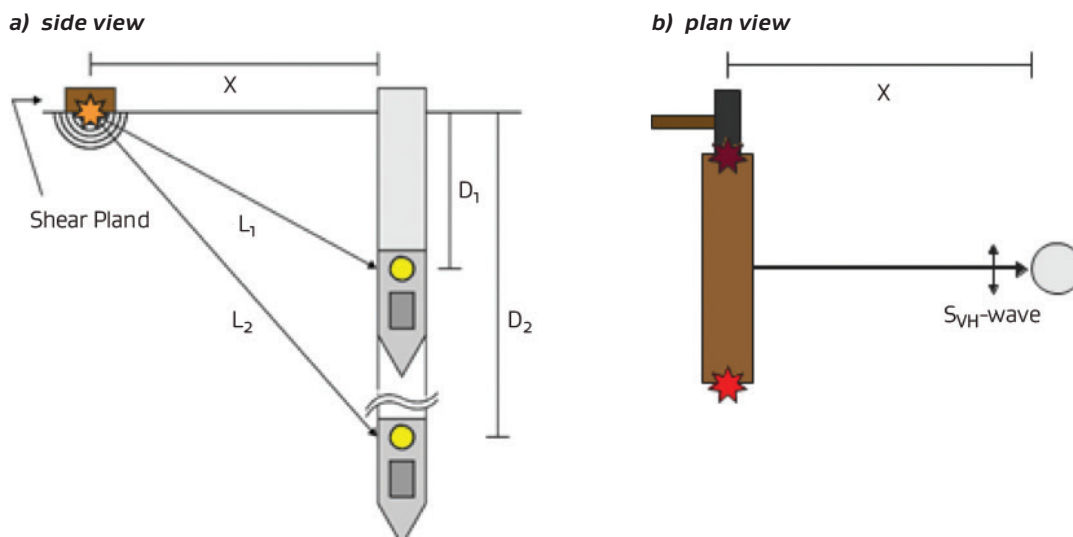

It is critical that at each test depth, the orientation of the receiver(s) and the initial polarity of the shear wave that is being generated is known. The initial polarity is the initial voltage departure, either positive or negative, recorded by the DAQ for a given impact direction on the shear plank. By striking each end of the plank, reversed polarity waves can be generated at each test depth. The resulting reversed polarity waveforms, when plotted together, should diverge (ie 'butterfly') at the arrival of the S-wave to approximately mirror each other. An example of a butterflyed waveform pair is shown in Figure 3.28.

Multiple beam impacts should also be used at each test depth and the recorded waveforms superimposed ('stacked') in order to develop a consistent clear waveform. These procedures will greatly simplify the data interpretation as discussed in the next section.

In a New Zealand context, the majority of sCPT use a single receiver configuration with a single receiver package located above the cone tip. This setup is used to record wave arrivals at the receiver location at each test depth using a separate source impact, and the difference in wave arrivals from one depth to the next is used to calculate a V_S for that test depth interval. This is referred to as the 'pseudo-interval' (PI) method, and in Figure 3.27a D_1 and D_2 would be two separate test setups.

Comment

As triggering of the DAQ can be inconsistent, particularly in lower quality systems, timing errors can be introduced into the PI method as the time zero for each separate test depth record can shift, meaning the wave arrival times are not a true representation of the propagation. A good practice is to record the trigger as part of the data acquisition, so this effect can be removed. However, this is not routinely done in practice.

All sDMT setups and a small number of sCPT use a dual receiver setup, with two receiver packages located a fixed vertical distance (0.5 to 1.0 m) apart from each other above the cone tip. This configuration records wave arrivals at two receiver locations (ie D_1 and D_2 in Figure 3.27a) for each test depth simultaneously using a single source impact. This test configuration is referred to as the 'true-interval' (TI) method. With a dual receiver system, as the wave arrivals at two locations for the same source are recorded, the triggering of the DAQ system — and therefore the zero time — is the same for both records. As a result, the issues related to inconsistent triggering are removed.

Figure 3.28: Example of butterflyed S_{VH} -waves (Cox, 2018):

a) waveform from first beam strike — initial positive voltage departure

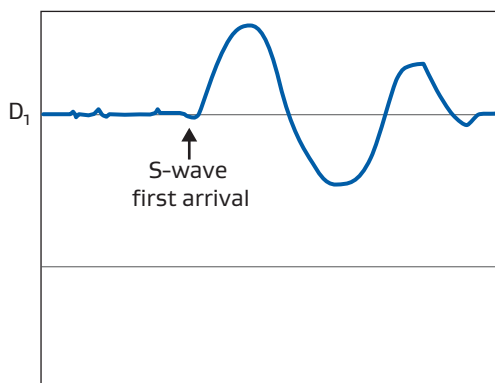

b) A hammer strike on the opposite end of the beam results in an initial negative voltage departure — shown in red

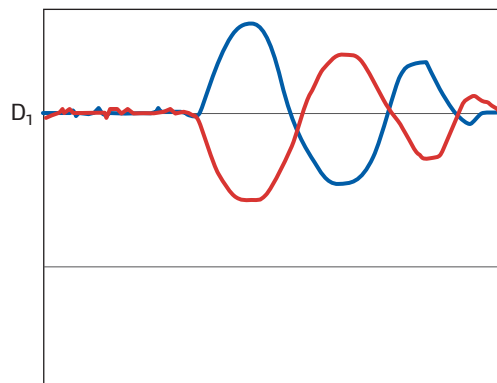

Processing and Uncertainty of Downhole Data

Processing of DH data begins with the picking of the travel times of the seismic waves, which could be the total travel time from source-to-receiver, or the relative travel time between two receiver locations (ie the interval travel time). The waveform of interest is the first major departure with the correct polarity, typically associated with an increase in amplitude and change in frequency content. This waveform can be picked using various approaches which are summarised in Figure 3.29.

The first arrival (FA) pick is the initial arrival of the shear wave, which can sometimes be difficult to identify and requires subjective judgement. The first peak/trough (PT) is the first peak after the FA for one source direction and the first trough for the other source direction. The first crossover (CO) is the first point after the FA where both waveforms cross each other. When the interval travel time is required, differences in the picked arrivals at subsequent depths for a particular method are used. A final approach makes use of the peak response of the cross-correlation (CC) function between pairs of waveforms from subsequent measurement depths to define the interval travel time. Using the CC function eliminates the subjectivity associated with manual arrival picks, and uses the full waveform rather than discrete points (Baziw, 1993).

Comment

An advantage of picking first PT and CO times is that the process can be semi-automated by searching for local maxima/minima or minimum differences, respectively, between the amplitude of the two reversed waveforms. In any case, the investigation report should clearly indicate what approach has been used, and the picks shown to enable a visual inspection of their quality.

Once travel times have been picked, there are multiple methods to process DH data to develop V_S profiles with depth. The first two are the pseudo-interval (PI) and true interval (TI) velocity methods (ASTM 2017) which uses the interval travel time between two receiver depths, and the difference in the travel path length from source to each receiver, to define the V_S of the deposits between the receiver depths. As mentioned above, triggering issues can introduce errors when using PI data. This manifests as fluctuations in the V_S profile that are often not representative of the true velocity profile.

Figure 3.29: Examples of interval travel times calculated using (Stolte & Cox 2020)

a) different picks from two depths using butterflyed waveforms

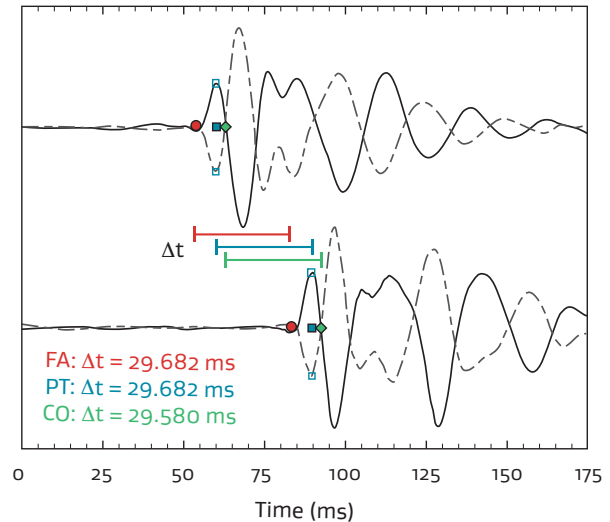

b) cross-correlation function between the positive polarity waveforms from (a)

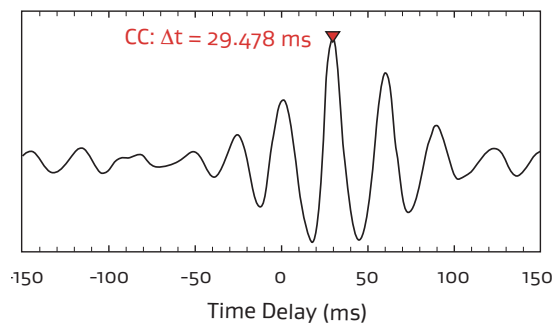

The third method is the corrected vertical travel time slope-based method (Patel 1981, Kim et al. 2004, Redpath 2007, Boore and Thompson 2007), also referred to as the slope method or direct method, that converts the total travel time to an equivalent vertical travel time and plots this against depth. Linear trends are then fit to groups of points to define velocities for different layers within the profile, constrained using clear changes in the slope or soil layer boundaries identified by CPT data. As a result, this approach is able to average out some the effects of triggering issues.

Comment

Both the TI and PI velocity analysis methods typically assume a straight-line ray path from the source to the receiver(s), as shown in Figure 3.27 above. The assumption of a straight-line travel path is not valid within about 3 to 5 m of the ground surface due to the potential for refraction of travel paths. Refraction of travel paths may also occur across layer boundaries with significant stiffness contrasts. Some experienced practitioners suggest disregarding the upper 3 to 5 m of a DH profile due to the potential effects of travel path refraction. As a rule of thumb, the depth at which the recorded shear wave velocities can be assumed to be reasonably unaffected by refraction (in the absence of high stiffness contrast layers) can be taken as 1.5 times the offset distance X (Cox, 2018). More information on the potential difficulties associated with accurately determining shear wave velocities at shallow depth can be found in Stolte and Cox (2020).

The true-interval (TI) and pseudo-interval (PI) processing methods show the largest differences across the four arrival time picking methods, while processing with the slope method (SM) results in noticeably more consistent profiles across the picking methods. The peak/trough (PT) and first crossover (CO) picking approaches provide quite consistent V_S estimates, while the first arrival (FA) and cross-correlation (CC) methods show greater variability.

Comment

As can be seen, different methods of picking arrival times and computing velocities may (and typically do) result in different V_S profiles. It is therefore important for both contractors and end-users to acknowledge that this uncertainty is present, and to take steps to demonstrate or quantify it. This can be quite easily achieved — for example by processing the data using at least two different methods and presenting the results. It is important that the end-user recognise that the V_S profile(s) that they are provided may vary — possibly substantially in parts — from the actual profile(s). Therefore, it is important that the end-user has an appreciation of the potential effects that this might have on their analysis.

Given that there is a range of approaches that can be taken to process a DH dataset, there is an opportunity to assess the epistemic uncertainty associated with a given V_S profile. Figure 3.30 shows a range of V_S profiles developed from a single dataset that was processed using four travel time picking methods and three processing methods.

Figure 3.30: Comparisons of V_S profiles developed using different travel time pick and processing methods (after Stolte & Cox 2020)

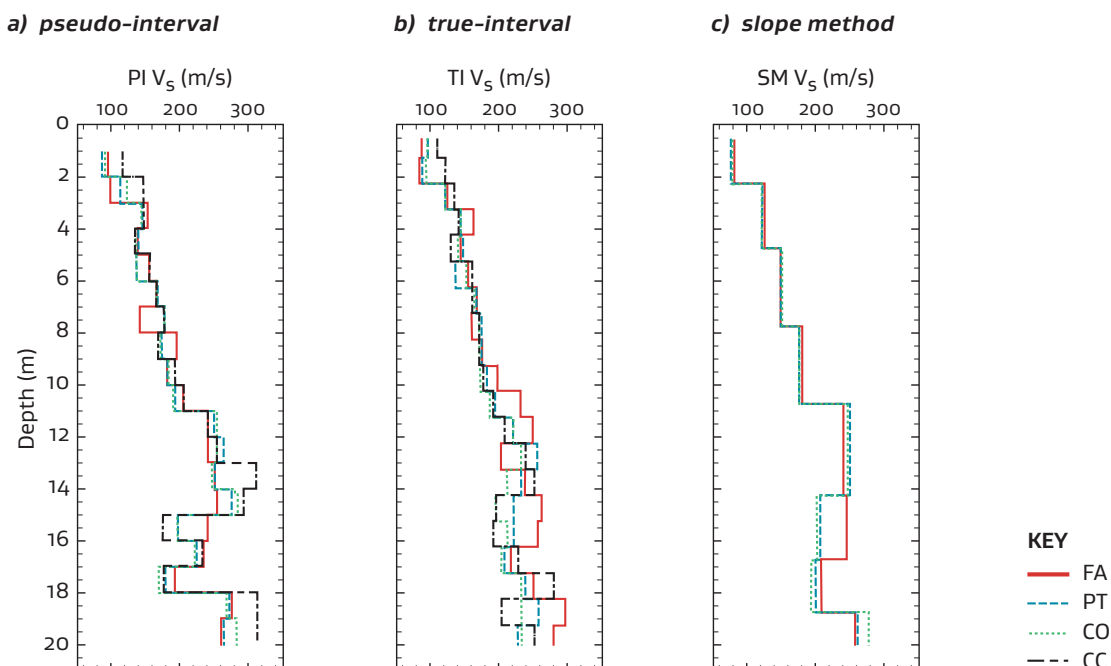

Crosshole Methods

Crosshole methods uses a source and receiver in separate boreholes/probes located at a common measurement depth, which are then advanced to a range of different depths. Compared to downhole testing, crosshole testing requires more boreholes, more equipment, and more time to complete, hence it is generally more expensive to perform than downhole testing. Crosshole methods typically used in New Zealand are the borehole-based crosshole (CH) and the direct push crosshole (DPCH). Because the travel time measurement between the source and the receiver is not subject to the depth effects associated with downhole testing, the results of cross hole testing are generally considered to be more representative than those obtained from downhole testing. Cox et al (2019) discuss the technical advantages of crosshole testing relative to downhole testing in detail.

Comment

V_s testing has been recommended as a potential method for assessing the effectiveness of shallow ground improvement to mitigate liquefaction (refer to Section 15.3 of the MBIE repair guidance for Canterbury as well as NZGS Module 5 on ground improvement). The crosshole method is considered a good technique for V_s measurement for this purpose relative to downhole methods because there are no potential difficulties associated with understanding wave travel paths along the edge of vertical ground improvement inclusions. However, the high cost of DPCH testing has generally discouraged its use.

The use of DPCH testing in New Zealand has evolved considerably over the past few years, and there is now a recommended test procedure and the method is commercially available, albeit on a limited basis. As discussed above, the cost of DPCH testing is less than borehole-based methods due to the elimination of borehole installation. Because of the reduced cost of DPCH, along with greater resolution with depth and generally less uncertainty of the velocity profile relative to downhole testing, the geo-professional is encouraged to consider this method for quality assurance testing of ground improvement. A good summary of the principles and application of the DPCH method is presented in Cox et al. 2019).

Acquisition of Cross Hole Data

Crosshole seismic testing is performed by lowering a source for generating seismic waves (P-waves or S-waves) and one or two receivers incrementally down separate, in-line and cased boreholes spaced 1.5 to 5 m apart (Stokoe and Woods 1972, Sincennes 2012, Cox et al. 2019). The source and receiver(s) are located at a common measurement depth, and tests are typically conducted at vertical increments of 0.5 to 3 m. The waves traveling along a predominately horizontal path arrive at the receiver borehole(s) and are recorded using properly oriented transducers (geophones or accelerometers). The general equipment and procedures for conducting crosshole seismic testing are outlined in the ASTM test standard D4428/4428M (2014).

The DPCH method is based on the same principles but uses a pair of instrumented seismic cones located 1.5 to 2.5 m apart and pushed directly into the ground, hence eliminating the need for machine-drilled boreholes and installation of fully grouted casings.

Directly pushing the cones into the ground provides excellent coupling between the source/receiver(s) and the surrounding soil. It also allows the testing to be conducted at vertical intervals in the order of 0.2 to 0.5 m with little additional effort, thus providing greater resolution of the shear wave profile with depth. A schematic of a single receiver (ie S_r/R_1 configuration) DPCH test setup is shown in Figure 3.31.

Figure 3.31: Schematic of direct-push crosshole (DPCH) test. (Cox, et al. 2019)

a) Cross sectional view

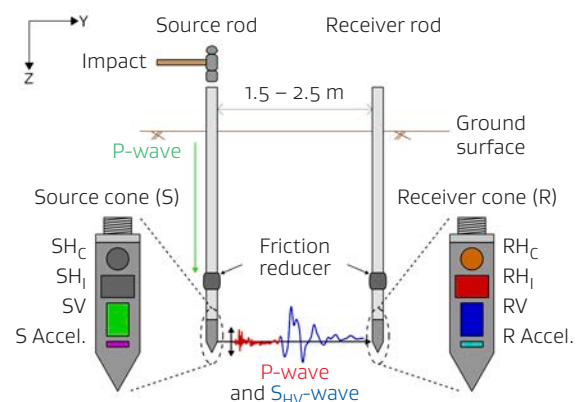

b) Plan view



Seismic waves for crosshole borehole testing are typically generated by dropping a metal slide hammer on an anvil firmly locked in the source borehole at the target test elevation to generate P-waves, horizontally propagating, vertically polarised shear waves (S_{HV} -waves), and/or horizontally propagating, horizontally polarized shear waves (S_{HH} -waves). A reversible polarity solenoid source can also be used to generate both P- and S-waves. Seismic waves for DPCH testing are generated by vertically tapping the top of the source cone push rod to generate a P-wave which travels down the push rod to the source cone where the energy is transferred into the soil as radially propagating P- and S-waves. As for downhole testing, multiple source impacts should be used at each test depth and the recorded waveforms 'stacked' in order to develop a consistent clear waveform.

Calibration of the source trigger time is also required for crosshole testing when using a source and a single receiver setup (ie two boreholes or two cones).

Comment

In order to accurately calculate the distance between the source and receiver at a given test location, the vertical alignment of the borehole or cone rod must be measured. This requires conducting a borehole deviation survey, or in the case of DPCH, measurement of the cone tilt during testing. Also prior to the start of testing, it is important to orient the horizontal receivers in the same direction. For CH testing, a magnetometer can be used to orient one of the horizontal components to magnetic north. For DPCH testing, the cones are rotated to align at the ground surface using markings on the cone casings.

Processing of Crosshole Data

Pre-processing of raw data and evaluation of wave travel times from crosshole seismic testing is non-trivial and is beyond the scope of this document. A detailed description of wave travel time evaluation can be found in Cox et al (2019), and a summary of the main steps required in the evaluation is provided in Wentz (2019). Calculation of the straight-line distance (l) between the source and receiver(s) is trivial, but first requires establishing their positions in 3D. For borehole-based testing, the results of the borehole deviation survey are used as described in ASTM D4428/4428M (2014). The determination of the positions of the source and receiver cones in the DPCH method is described in Cox et al. (2019).

The values of V_P and V_S at each test depth increment (i) are determined from the corrected travel times ($t_{cor,i}$) and direct travel path distances (L_i) using the equation $V_i = L_i/t_{cor,i}$. Note: t_{cor} , l will be different for P- and S-waves.

Limitations of Crosshole Testing

At sites with interlayered soil deposits where stiff layers are overlying very soft and thin layers (as indicated by CPT and/or borehole data), it can be difficult to resolve the correct V_S of the underlying soft, thin layers with crosshole testing. Depending on the thickness and the stiffness contrast of these soft materials, the waveforms can be complicated/contaminated by indirect wave arrivals, which may arrive faster than the waves traveling directly between the source and receiver(s). Potential causes of the early wave arrivals include:

- › waves refracted along stiff layer boundaries
- › waves converting modes (ie S_{HV} -waves converting to P-waves); and
- › for DPCH testing only — transmission of energy between the cone push rods through the overlying stiff material.

Cox et al. (2019) provide a comprehensive discussion of how to identify and address potential problems with non-direct wave paths and complicated wave paths in interlayered soils.

Correct trigger calibration, recording and processing of the source trigger times must be performed in order to obtain representative shear wave velocities, and while they are not particularly difficult, some time and effort is required. If monitoring of trigger times is not done or not done properly, the resulting seismic wave velocities may not be representative of the actual conditions (particularly the P-wave velocity).

3.7.5 MINIMUM REPORTING REQUIREMENTS FOR IN SITU SEISMIC TESTING

Most seismic testing reports contain routine information such as a summary of test method and procedures, a description of test equipment, the test locations and a summary of results — often presented as velocity profiles. While this information is necessary, enough information should be provided in testing reports so that the end user can independently assess the quality of the data or perform independent processing of the data.

All non-invasive (surface wave) reports should contain:

- › Details of the array geometry, source type, and source locations that were used.
- › Processing methods and software used.
- › Plots of the experimental dispersion data and theoretical fits on the same figure.
- › Plots and tables of V_S profiles with a clear indication of near-surface and maximum depth resolution limits relative to dispersion wavelengths and array dimensions.

If layer boundaries defined from other subsurface investigation data have been used to constrain interpretation, this should also be indicated in any reporting. This helps to reduce any uncertainty in the interpretation of seismic methods, and if this data is available, this should be provided to whoever is interpreting the seismic results.

All invasive method test reports should include:

- › travel time picking method
- › velocity analysis method
- › expected waveform voltage polarities for shear waves
- › waveform plots with travel time picks identified
- › tabulated travel times
- › tabulated velocity profiles.

In addition to this, DH/sCPT reports should contain the source offset used during the test, while all CH/DPCH reports should contain tabulated distances between source and receiver(s) as a function of depth. As for non-invasive test reports, any other subsurface investigation data used to constrain interpretation should also be included in the report.

3.7.6 OTHER GEOPHYSICAL TESTS

A number of other geophysical methods are available for site investigations. One such method is ground penetrating radar (GPR), which makes use of high frequency electromagnetic waves transmitted into the ground. GPR can be used for crudely defining stratigraphy in some situations, and is useful for location buried services and structures (underground tanks and the like).

Electrical Resistivity Survey (ER) can be used to evaluate soil types, as well as variations in pore fluid. Electrodes are embedded in the ground to enable a site-wide resistivity survey. This method can be used for determining, eg the distribution of clay soils across a site. It has also been used to map faults, karstic feature and contamination plumes.

3.8 Groundwater Measurement

3.8.1 GENERAL

An important part of any geotechnical site investigation is identification of the ground water level and any zones of artesian pressure. Measurements of water entry during drilling and measurements of the groundwater level at least once following drilling should be considered a minimum effort to obtain water level data, unless alternate methods, such as installation of observation wells, are defined by the geotechnical professional. Variation of groundwater level or pressure during construction and over the service life of any proposed works should also be evaluated.

Changes to groundwater conditions from construction activities have the potential to affect groundwater levels and quality to a considerable distance from the site. This zone of potential influence can be much wider than that for other more immediate or obvious issues such as movement of ground due to excavation. In addition, groundwater effects may take a considerable time to develop or may only become apparent during extreme conditions such as during flooding or high rainfall events.

Depending on the nature of the project and geotechnical issues involved, it can be beneficial to gain an understanding of the variability in groundwater conditions by monitoring ground water levels over several seasons, or rainfall events, or tidal conditions.

Determination of groundwater levels and pressures includes:

- › measurements of the elevation of the groundwater surface or water table and its variation with the season of the year
- › the location of perched water tables
- › the location of aquifers
- › the presence of artesian pressures.

Water levels and pressures may be measured in existing wells, in boreholes and in specially-installed observation wells. Piezometers are typically used where the measurement of the ground water pressures are specifically required (ie to determine excess hydrostatic pressures or the progress of primary consolidation).

3.8.2 EXISTING WELL INFORMATION

Many district or regional councils require the drillers of water wells to provide logs of wells they install, and these are normally made available to the public. Such records are often good sources of information of both the soil or rock materials encountered, as well as water levels recorded during well installation (although often these wells are sampling a confined aquifer in which case they may be artesian and hence will not be a reflection of surface groundwater levels). The well owners, both public and private, may have records of the water levels after installation which can provide extensive information on fluctuations of the water level.

3.8.3 OPEN BOREHOLES

The water level in open boreholes should be measured after any prolonged interruption in drilling and at the completion of each borehole. During multi-day investigations, it is preferable to perform additional measurements at least 12 hours (preferably 24 hours) after completion of drilling. The date and time of each observation should be recorded on the borehole log.

If the borehole has caved, the depth to the collapsed zone should be recorded and reported on the log as this may have been caused by groundwater conditions. For example, the elevations of the caved zones of particular boreholes may be consistent with groundwater table elevations at the site, and this may become apparent once the subsurface profile is developed.

Drilling mud will affect observations of the groundwater level due to filter cake action and the higher specific gravity of the drilling mud compared to that of the water. If drilling fluids are used to advance the borehole, the hole should be bailed prior to making groundwater observations.

3.8.4 CONE PENETRATION TEST

In general, CPT pore pressure readings should not be relied upon solely to determine an accurate groundwater depth. At test depths above the groundwater table, porewater pressure readings vary with capillarity, moisture, degree of saturation and other factors and should therefore be considered tentative. Below the water table, for the standard shoulder element in clean saturated sands, measured penetration porewater pressures are often near hydrostatic ($u_2 \sim u_0$), whereas intact clays exhibit values considerably higher than hydrostatic ($u_2 > u_0$).

During a CPT, pore pressure dissipation tests (PPDTs) can be used to measure hydrostatic pore pressure and hence help establish the hydrostatic conditions and the depth to groundwater. This works best in clean sands where the dissipation of excess pore pressure is almost immediate. In low permeability soils, the dissipation time can be very slow. Dissipation tests can also be used to estimate soil permeabilities.

Comment

It is useful when conducting CPT to measure the depth to groundwater immediately upon retraction of the cone from the ground. The measurements are best conducted with an electric water-level indicator. If the groundwater depth is relatively shallow (eg <5 m), the hole is stable (ie remains open without collapse), and there are no 'complications' such as a confined aquifer, the measurements can be considered reasonably representative at the time of measurement. In any event, such data can be utilised to compare with other site or nearby data.

Figure 3.32: Typical Details of Observation Well Installations

a) Stand-Pipe Piezometer

b) Driven Well Point

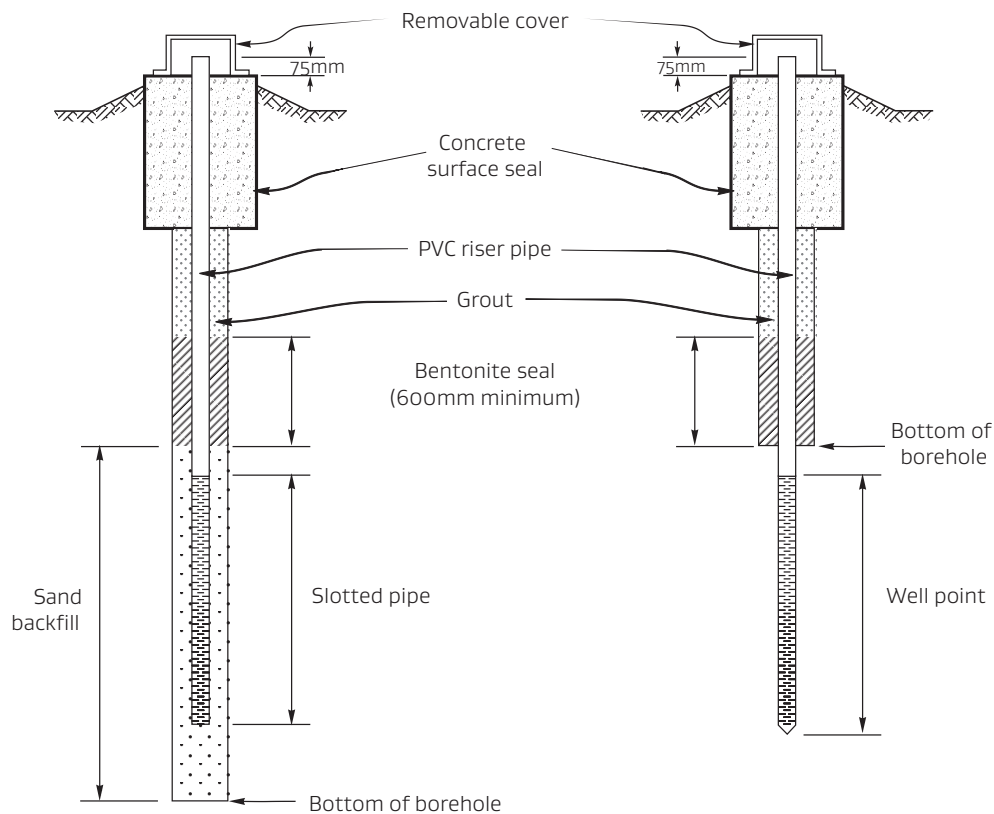

3.8.5 OBSERVATION WELLS AND PIEZOMETERS

The observation well, also referred to as a standpipe piezometer, is a routine method of measuring water head in an aquifer and for assessing the performance of dewatering systems. In theory, a 'piezometer' measures the pressure in a confined aquifer or at a specific horizon of the geologic profile, while an 'observation well' measures the level in a water table aquifer (Powers, 1992). In practice, however, the two terms are at times used interchangeably to describe any device for determining water head.

The term 'observation well' or 'standpipe' is applied to any well or drilled hole used for the purpose of long-term studies of groundwater levels and pressures. Details of typical observation well installations are shown in Figure 3.32.

The simplest type of observation well is formed by a small-diameter PVC pipe set in an open hole. The bottom of the pipe is slotted and capped, and the annular space around the slotted pipe is backfilled with clean sand. The area above the sand is sealed with bentonite, and the remaining annulus is filled with grout, concrete, or soil cuttings. A surface seal, which is sloped away from the pipe, can be formed with concrete to prevent the entrance of surface water. The top of the pipe should also be capped to prevent the entrance of foreign material, and a small vent hole should be placed in the top cap. In some localities, regulatory agencies may stipulate the manner for installation and closure of observation wells.

Driven or pushed-in well points are another common type for use in granular soil formations and very soft clay. The well is typically formed by a stainless steel or brass well point threaded to a galvanized steel pipe. In granular soils, an open boring or rotary wash boring is advanced to a point several centimetres above the measurement depth and the well point is driven to the desired depth. A seal is commonly required in the boring above the well point with a surface seal at the ground surface.

Note: observation wells may require development (refer to ASTM D 5092 test standard) to minimize the effects of installation, drilling fluids, etc. The diameter of the pipe should allow introduction of a bailer or other pumping apparatus to remove fine-grained particles in the well and improve the response time.

3.8.6 WATER LEVEL MEASUREMENTS

A number of devices have been developed for sensing or measuring the water level in observation wells. Following is a brief discussion of the three common methods that are used to measure the depth to groundwater. In general, common practice is to measure the depth to the water surface using the top of the casing as a reference.

3.8.6.1 Tape

In this method, a cloth measuring tape with a weight attached is inserted into the borehole and the operator listens for a splashing sound as the tape is 'bounced' up and down. An estimate is then made of where the water level surface is, and the depth from the top of the well or borehole casing is noted. The accuracy of this method can reduce as the depth to groundwater increases.

A more accurate method is to chalk a short section at the lower end of a metal tape with a weight attached. The tape is then lowered until the chalked section has passed slightly below the water surface. The depth to the water is determined by subtracting the depth of penetration of the line into water (as measured by the water line in the chalked section) from the total depth from the top of casing. This method is cumbersome when taking a series of rapid readings, since the tape must be fully removed each time. An enamelled tape is not suitable unless it is roughened with sandpaper so it will accept chalk. The weight on the end of the tape should be small in volume so it does not displace enough water to create an error.

3.8.6.2 Electric Water-Level Indicator

This indicator is battery operated and is comprised of a weighted electric probe attached to the lower end of a length of electrical cable that is marked at intervals to indicate the depth. When the probe reaches the water a circuit is completed and this is registered by a meter mounted on the cable reel. Better models use the cable itself as a measuring tape. The signalling device denoting circuit closure is typically a neon lamp, beeper or ammeter. The electric indicator has the advantage that it may be used in extremely small holes.

When the water is highly conductive, erratic readings can develop in humid air above the actual water level. Sometimes careful attention to the intensity of the neon lamp or the pitch of the beeper will enable the reader to distinguish the true level. A sensitivity adjustment on the instrument can be useful. Accumulations of sludge from iron, oil, etc present in the observation well may result in the electric probe giving unreliable readings.

3.8.6.3 Data Loggers

When timed and frequent water level measurements are required, as for a pump test or slug test, or for continuous monitoring on a periodic interval, data loggers are very useful (eg checking seasonal variations, which in some locations can be significant).

Loggers are in the form of an electric transducer near the bottom of the well, which senses changes in water level as changes in pressure. A data

acquisition system is used to acquire and store the readings. A data logger can eliminate the need for on-site technicians during an extended monitoring period. A further significant saving is in the technician's time back in the office.

The better data logger models not only record water level readings but permit the data to be downloaded into a computer and, with appropriate software, to be quickly reduced and plotted. These devices are also extremely useful for cases where measurement of artesian pressures is required or where data for tidal corrections are necessary.

3.8.6.4 Compression Wave Velocity (V_p)

As discussed in Section 3.7, because water has a compression wave velocity of about 1500 m/s, V_p measurement can be used to help determine the depth to fully saturated or near-saturated soil conditions — noting that this may not be the same as the depth to free groundwater.

4 Laboratory Testing of Soil Samples

4.1 General

Laboratory testing of soils is generally a fundamental element of all geotechnical engineering.

This section focusses on a select number of laboratory tests that would typically be performed as part of an investigation to assess liquefaction; cyclic softening of cohesive soils; settlements; and shear strength for bearing capacity, slope stability and retaining wall design.

The types of testing required for a particular project may range from a simple moisture content and index property determination, to specialised cyclic/post-cyclic strength testing. The geotechnical

professional should assess the field investigation data prior to developing the test programme, in order to carefully identify target sampling depths.

The goal of a well-designed laboratory testing programme should be to adequately characterise:

- 1 those properties that are representative of site soils in general
- 2 the properties of critical layers or zones that may significantly impact site or structure behaviour.

Comment

Due primarily to cost and time considerations, a decision is often made to forgo or minimise laboratory testing of soils for routine projects, but often also for even larger more complex projects. The presumption is that the cost of testing outweighs the potential benefits derived from a refined design. However, in situations where ground conditions are complex, empirical correlations are inconclusive, or soils are near a boundary for behaviour change, the geotechnical professional should perform laboratory testing as appropriate to reduce the potential for incorrect design assumptions being made.

For example, testing to determine plasticity and fines content is relatively inexpensive, and can be used for site-specific calibration of CPT soil behaviour interpretation. For silty sand/low-plasticity silt soils in particular, the calibration may significantly reduce over-prediction of liquefaction triggering using the CPT-based simplified method. Such over-prediction can result in unnecessarily expensive foundation designs, and the cost savings in such a case likely far outweigh the cost of laboratory testing.

For large or complex projects located on significant deposits of soils potentially susceptible to liquefaction/cyclic softening, the cost of specialised testing to better characterise their cyclic/post-cyclic behaviour may well be justified if there is the potential to gain significant savings in foundation costs.



4.1.1 SELECTION AND ASSIGNMENT OF TESTS

Certain considerations regarding laboratory testing, such as when testing might be warranted and the quantities and types of tests to be carried out, should be decided by an experienced geotechnical engineer.

At a minimum, the following criteria should be considered while determining the scope of the laboratory testing programme:

- › project type
- › project size/importance/complexity
- › loads to be imposed on the foundation soils
- › types of loads (ie static, dynamic)
- › critical tolerances for the project (eg settlement limitations)
- › vertical and horizontal variations in the soil profile as determined from CPT/borehole logs and visual identification of soil types in the laboratory

- › known or suspected peculiarities of the site soils (ie liquefaction potential, soft soils, swelling soils, collapsible soils, organics, etc.).

The selection of tests should be made in the context of developing a reliable soil profile and providing the primary soil parameters required for design.

Table 4.1 presents a summary list of the NZS/BS EN ISO standards commonly used for laboratory testing of soils, as well as specialised cyclic shear strength tests that are specifically applicable to earthquake engineering. Also included are ASTM standards which may be specifically applicable to earthquake geotechnical engineering. It is recognised that Australian Standards may also be applicable for certain types of testing.

Following this subsection are brief commentaries on typical soil properties, and both common and specialised tests used to determine them.

Table 4.1: NZS, BS and ASTM Standards for Select Geotechnical Laboratory Tests^{1,2}

TEST CATEGORY	NAME OF TEST	TEST DESIGNATION		
		NZS 4402	BS EN ISO 17892	ASTM
Visual identification	Field description of soil and rock — New Zealand Geotechnical Society Guidelines	–	–	–
Index properties	Determination of water content	Test 2.1	Part 1	ASTM D2216
	Determination of particle-size distribution	Test 2.8	Part 3	ASTM D 422
	Test method for amount of material in soils finer than the No. 200 (75 µm) Sieve	–	Part 4	ASTM D 1140
	Determination of liquid limit	Test 2.2	Part 12	ASTM D4318
	Determination of plastic limit	Test 2.3	Part 12	ASTM D4318
	Determination of plasticity index	Test 2.4	Part 12	ASTM D 4318
Strength properties	Unconsolidated undrained triaxial shear strength	Test 6.2	Part 8	ASTM D2850
	Consolidated undrained triaxial shear strength	–	Part 9	ASTM D4767
	Direct shear/Shear box	–	Part 10	ASTM D3080
	Cyclic triaxial test of saturated soils — load controlled	–	–	ASTM D5311
	Consolidated Undrained Cyclic Direct Simple Shear Test — constant volume	–	–	ASTM D8296
Permeability			Part 11	ASTM D2434/ D5084
Consolidation	One-dimensional consolidation properties	7.1	Part 5	ASTM D2435/ D4186

1 This table is for information only. The Geotechnical Professional should select the most appropriate standard to follow. Other standards other than those listed here may be appropriate (eg Japanese standards).

2 For testing where advanced techniques or new technologies are being used, specialist laboratory knowledge may result in test procedures that are quite different to those contained in published testing standards. Commissioning of cyclic testing by a university laboratory for liquefaction assessment would be a typical example of this situation.

4.2 Visual Identification of Soils

Prior to assigning laboratory tests, all soil samples selected for laboratory testing should undergo visual examination and identification. It is recommended that the geotechnical professional or their qualified representative be present during the opening of samples for visual inspection. They should remain in communication with the laboratory testing technician to confirm that the testing is proceeding as anticipated and to provide additional technical input if necessary.

The purpose of the visual identification exercise is to:

- 1 Verify the field description of soil type and colour and revise the descriptions to be included in borehole logs or graphically presented subsurface profiles if necessary.
- 2 Select representative samples for routine testing.
- 3 Select samples for specialised tests (ie triaxial/cyclic triaxial testing) to help assess the effects of soil macro structure on the overall soil properties.
- 4 Identify changes, intrusions or disturbances within a sample which may have a material effect on the test results.

The guidelines for visual identification of soils listed in Table 4.1 can be used in field as well as laboratory investigations.

4.2.1 DISTURBED SAMPLES

As discussed previously, disturbed samples are normally bulk samples of various sizes. Visual examinations of these samples are limited to the colour, composition (ie gravel, sand, silt, clay, concretions, etc.) and consistency; as determined by handling a small, representative piece of the sample.

The colour of the soil should be determined by examining the samples where the moisture content is preserved near or at its natural condition.

If more than one sample is obtained from the same deposit, the uniformity (or lack thereof) of the samples should be assessed at this stage. This assessment is used to decide on the proper mixing and quartering of disturbed samples to obtain representative specimens.

4.2.2 HIGH QUALITY OR 'UNDISTURBED' SAMPLES

Samples should be placed on their side on a clean table top. If samples are soft, they should be supported in a sample cradle of appropriate size; they should not be examined on a flat table top.

Samples should be examined in a humid room where possible, or in rooms where the temperature is neither excessively warm nor cold. Once the samples are unwrapped, the technician or geotechnical professional examining the sample should identify its colour, soil type, variations and discontinuities discernible from surface features such as silt and sand seams, trace of organics, fissures, shells, ash/pumiceous materials, mica, other minerals, and other potentially relevant features.

The apparent relative strength, as determined by a hand-held penetrometer or shear vane, is often noted during this process. Samples should be handled very gently to avoid disturbing the material. The examination should be done quickly, before changes in the natural moisture content occur.

4.3 Index Properties

Index properties are used to characterise soils and determine their basic properties such as moisture content, specific gravity, particle-size distribution, and consistency and moisture-density relationships.

4.3.1 MOISTURE CONTENT

The purpose of this test is to determine the amount of water present in a quantity of soil in terms of its dry weight, from which general correlations with strength, settlement, workability and other properties can be made.

Determination of the moisture content of soils is a common laboratory procedure. The moisture content of soils, when combined with data obtained from other tests, provides significant information about the characteristics of the soil. For example, knowing the water content to liquid limit ratio (w_c/LL) is an important part of the assessment of liquefaction of fine-grained soils.

As this test involves drying out soil samples in an oven at 105 to 110° C, serious errors in determination of the moisture content may be introduced if the soil contains other components, such as petroleum products or easily ignitable solids. When the soils contain fibrous organic matter, absorbed water may be present in the organic fibres as well as in void spaces. If the reference test procedure does not differentiate between pore water and absorbed water in organic fibres, the moisture content measured will be the total moisture lost rather than free moisture lost (from void spaces). As discussed later, this may introduce serious errors in the determination of Atterberg limits.

4.3.2 PARTICLE-SIZE DISTRIBUTION

The purpose of the test is to determine the percentage of the various grain sizes comprising the soil. This is carried out using a series of finer and finer sieves, using either a 'wet sieving' or 'dry sieving' procedure. For the fraction of the soil containing very fine particles (ie finer than 63 microns) a hydrometer is used instead. The particle-size distribution (PSD) is used to determine the textural classification of soils (ie gravel, sand, silt, clay, etc.) which in turn is used to assess the engineering characteristics such as permeability and strength.

While knowledge of the PSD of the soil is useful for assessing soil behaviour, it is not necessarily required for assessment of liquefaction triggering potential. The primary behaviour characteristics of a soil (ie whether it is cohesionless or cohesive material) can often be determined directly from viewing borehole samples or CPT data. In this case, only the fines content (F_c) is necessary for the liquefaction analysis.

Laboratory F_c data can be used to develop a site-specific CPT- C_{FC} correlation when using the Boulanger and Idriss (2014) CPT-based liquefaction triggering method. In the case of silty soils (ie silty sands/sandy silts) in particular, the use of site-specific F_c data can potentially reduce over-prediction of liquefaction triggering that sometimes occur when using a CPT-based simplified triggering method.

Comment

In NZS 4402:1986, test 2.8, the fines content is defined as the percentage of material by weight passing the 63 μ sieve. However, many of the case histories used to develop and refine the commonly used simplified liquefaction triggering methodologies define the fines content as the percent passing the 75 μ sieve.

In the aftermath of the 2010–2011 Canterbury earthquakes, many geotechnical professionals use the 75 μ sieve for determining the fines content for liquefaction assessment to be consistent with the simplified triggering method. As result, many commercial laboratories have the ability to determine the fines content based on the larger sieve size. (It should be noted that liquefaction assessments that have used the 63 μ sieve are, in theory, conservative as the soil is treated as having a lower fines content than if the 75 μ sieve had been used.)

Obtaining a representative size sample is an important aspect of the PSD test; particularly for soils containing larger particle sizes (eg gravel and cobble). For testing of soils containing a significant amount of larger particles, the necessary sample size may be tens, or even one hundred or more, kilograms.

In laboratory sieves, the openings of fine (63 or 75 μ) mesh or fabric are easily distorted as a result of normal handling and use, and hence may require replacement on a regular basis if used often. A simple way to determine whether sieves should be replaced is the periodic examination of the stretch of the sieve fabric on the frame. The fabric should remain taut; if it sags, it has been distorted and should be replaced. Another common cause of serious errors is the use of 'dirty' sieves — ie sieves with numerous openings blocked with lodged soil particles.

4.3.3 ATTERBERG LIMITS

This test is used to describe the consistency and plasticity of fine-grained soils with varying degrees of moisture. The Atterberg limits provide general indices of moisture content relative to the consistency and behaviour of soils in terms of the liquid limit (LL) which defines a liquid/semi-solid change, and the plastic limit (PL), which is a solids boundary. The difference between the LL and the PL is termed the plasticity index ($PI = LL - PL$).

The PI is an important parameter for assessing the liquefaction triggering potential of soils containing a significant percentage of fines; specifically it is used to help assess whether the soil exhibits predominantly 'sand-like' or 'clay-like' behaviour.

Knowing the PI of low plasticity silts or sandy silts can help determine whether such materials are susceptible to liquefaction triggering. The PI value of a low plasticity clay is used to help assess whether it is susceptible to cyclic softening.

Atterberg limits are also used to assess the stress history of a soil. The liquidity index (LI) is defined as $LI = (w_c - PL)/PI$. For a normally consolidated (NC) soil, $LI \approx 1$ and for over-consolidated (OC) soils, $LI \approx 0$.

Comment

The PI values of fine-grained soils in the majority of the case histories in the international liquefaction case history database were determined using the ASTM D 4318 test method. This method specifies a greater hardness for the rubber base beneath the LL device (Casagrande cup) than the NZS method, and the ASTM specimen preparation for determining the PL results in a 'wetter' soil thread. The harder cup may result in greater energy being imparted to the LL cup which in turn can result in a lower LL value than would be determined with the NZS LL device (ie a lower number of cup drops is required to close the groove in the sample at a particular w_c). The ASTM 'wet' preparation method for determining the PL can result in the sample having a higher PL value than would be obtained with the NZS method.

During the 2011 Canterbury EQC residential field investigations, the difference in results between the ASTM and NZS methods showed that, for low plasticity soils (in the range important for assessing liquefaction susceptibility), the NZS method often, but not always yielded a lower PI value relative to the ASTM method.

As an alternative to using the Casagrande cup method for determining LL, sometimes a Cone Penetration method (or 'Fall Cone Test') is used. Care should be taken when using this method for high plasticity soils, where the Cone Penetration method can significantly underestimate the LL.

As for the fines content determination discussed in Section 4.3.2, it is recommended that the ASTM test method be used for determining Atterberg limits for assessing liquefaction and cyclic softening susceptibility. However, all else being equal, it is noted that the determination of a lower PI value will be conservative if using the NZS method.

Considering the need for a very consistent application technique and the required use of judgement of the Atterberg limits test procedures, the testing should only be performed by experienced technicians. Lack of experience and/or careful execution will most likely introduce serious errors in the test results.

4.4 Shear Strength and Cyclic Testing

Following are brief descriptions of laboratory shear strength tests that can be used to assess soil strength parameters under both static and dynamic conditions. Laboratory shear testing, particularly cyclic testing, requires specialist knowledge and adequate experience to obtain accurate results.

The following information is intended to give some general guidance regarding the types of testing routinely used for earthquake engineering projects.

Most of the static tests are quite accessible and routinely performed in New Zealand. Cyclic testing is not commonly performed in New Zealand although this is now changing. The equipment and expertise required for cyclic testing is mainly confined to New Zealand university geotechnical testing laboratories at present. However, over time it is anticipated that cyclic testing will become more widely available on a commercial basis.

4.4.1 CONSOLIDATED UNDRAINED TRIAXIAL STRENGTH (CU TEST)

The CU test is used to determine the strength characteristics of soils including detailed information on the effects of lateral confinement, porewater pressure, drainage and consolidation. The stiffness (modulus) at intermediate to large strains can also be assessed.

Test samples are typically 35 to 75 mm in diameter and have a height to length ratio between 2 and 2.5. The sample is encased by a thin rubber membrane and placed inside a plastic cylindrical chamber that is usually filled with water. The sample is subjected to a total confining pressure (σ_3) by compression of the fluid in the chamber acting on the membrane. A backpressure (u_0) is applied directly to the specimen through a port in the bottom pedestal upon which the specimen sits. Thus, the sample is initially consolidated with an effective confining stress: $\sigma_3' = (\sigma_3 - u_0)$. To cause shear failure in the sample, axial stress (ie deviator stress = $\sigma_1 - \sigma_3$) is applied through a vertical loading ram. Axial stress may be applied at a constant rate (strain controlled) or by means of a hydraulic press or dead weight increments or hydraulic pressure (stress controlled) until the sample fails.

The CU test is most useful when conducted with pore pressure measurements as it provides direct measurement of total stress (c and ϕ) as well as effective stress strength parameters (c' and ϕ'). Triaxial shear strength parameters are often used in slope stability analysis where the orientation of the triaxial shear plane better approximates the field

shear conditions for the sub-vertical portion of the slide surface. This is also true for bearing capacity failure surfaces.

Careful specimen preparation and set-up is critical for obtaining accurate test results. Proper back-pressure saturation of the sample (b-value of 0.96 or higher) is particularly important.

The results can be presented in terms of Mohr Circles of stress to obtain strength parameters for the specimen. However, if more than two or three tests are conducted, the results are more conveniently plotted in p-q space, where $p = \frac{1}{2}(\sigma_1' + \sigma_3')$ kPa and $q = \frac{1}{2}(\sigma_1' - \sigma_3')$ kPa, and the entire stress path can be plotted from start to finish.

4.4.2 DIRECT SHEAR (SHEAR BOX) TEST

The direct shear (DS) test determines the shear strength of the soil along a pre-defined horizontal planar surface. While the DS test is relatively simple to perform, it has some inherent shortcomings:

- › The failure plane is predefined and horizontal, and may not be the critical plane.
- › Relative to the triaxial test there is little control over the drainage of the soil.
- › The distribution of normal and shear stresses over the sliding surface is not uniform — typically the edges of the test specimen experience greater stress than the centre. Therefore, there is progressive failure of the specimen, ie the entire strength of the soil is not mobilised simultaneously.
- › The test sample is not fully saturated, but often only partially drained. Care must be taken to shear the sample slowly enough to allow full drainage, and this can be difficult to do in fine-grained samples. If sheared too rapidly, unrealistically high values of effective cohesion may be obtained.

In spite of these limitations, the DS test is commonly used because it is simple and easy to perform, and provides reasonably reliable values for effective strength parameters provided that sufficiently slow rates of shear are used. The device also uses much less soil than a standard triaxial device, therefore consolidation times are shorter.

The DS test is particularly applicable where it is necessary to determine the angle of friction between the soil and the material of which the foundation is constructed, eg the interface friction between the base of a concrete footing and supporting soil. In such cases, the lower box is filled with soil and the upper box contains the foundation material.

4.4.3 CYCLIC TRIAXIAL TEST (CTX)

In cyclic triaxial testing, soil specimens are subjected to repeated (cyclic) application of shear stresses. Commonly, uniform amplitude of cyclic stresses are applied and soil response is recorded in terms of evolution of axial (a proxy for shear) strain and excess pore water pressures during the cyclic loading. Cyclic tests are typically used to evaluate cyclic response of soils subjected to earthquake loading or vibrations from other sources (machine, traffic, etc). Key objectives in the test are to evaluate how the stiffness and strength of soil change (degrade) under cyclic loading and what are the consequent cyclic strains and residual deformations. The test is applied to liquefiable soils (often referred to as 'liquefaction test'), clay-like soils, and intermediate soils with poorly understood stress-strain behaviour. Both high quality ('undisturbed'), and reconstituted specimens can be used in these tests. Cyclic tests in the laboratory could be used to investigate soils that are not adequately addressed in field empirical procedures, but also to supplement and interrogate empirical procedures for a wide range of soils.

High-quality samples of low-plasticity silts, sandy silts and silty sands for testing can be obtained using Dames and Moore or Gel Push samplers as discussed in Section 3.2.4. Recovering high quality samples is the preferred method, however, reconstituted specimens could be appropriate to use in cases when reconstitution procedures provide representative specimens for testing. In such cases, an adequate specimen preparation procedure is essential to achieve fabric and density of specimens that are representative of in situ soils.

Obtaining truly undisturbed samples of clean sands is a challenging task that requires the use of specialised skills and sampling equipment, such as the piston sampler or gel-push sampler (refer to Section 3.2.4). The test specimens are prepared generally as for a static TX test, then back-pressure saturated and consolidated to the desired effective confining stress. The consolidation could be performed either under isotropic or anisotropic conditions. After consolidation, it is possible (and preferred) to perform V_s measurement of

the soil specimen, which allows a comparison of the initial stiffness of the soil specimen to that in situ. This approach is used to confirm the quality of undisturbed specimens and how representative the laboratory specimen is of the in situ soil.

Stress-controlled cyclic testing is performed for liquefaction evaluation. The test is performed under undrained conditions, by applying a uniform amplitude of cyclic shear stresses (measured as a cyclic stress ratio — CSR). The loading is usually a sinusoidal load or similar, with a loading frequency typically in the order of 0.1 to 1 Hz. The frequency of loading is not critical for sands, but could be an important factor to consider when testing soils with lower permeability. The excess pore pressure and axial strains are monitored during the cyclic loading until the onset of liquefaction and subsequent development of large strains. The specimens are typically tested at different CSR values and the test results are plotted against the number of load cycles to liquefaction. If several specimens are tested under similar conditions (eg the same density and consolidation stress), a curve in the CSR-Nc plot, referred to as the liquefaction resistance curve, is defined. Strain criteria are used to determine the occurrence of liquefaction in these tests. Most commonly 5 percent double-amplitude axial strain is used, or alternatively 3 percent single-amplitude axial strain could be employed. These strain criteria could be relaxed in case of stiff soils that do not develop large strains during cyclic loading, and also are often accompanied by excess pore water pressure (EPWP) considerations, as 100 percent EPWP implies a complete loss of effective stress, and hence, state of liquefaction.

In addition to the liquefaction resistance curve, it is important to present the effective stress path, shear stress-shear strain relationship, and excess pore water pressure development during the test, as they provide important information on soil behaviour and characteristic stress-strain response (eg exhibiting cyclic mobility, strain-softening, rate of strain development, etc).

A similar type of test can be performed on clay-like soils to evaluate their characteristic cyclic response. The procedures are similar as for liquefiable soils, but usually require longer testing time because of slower saturation and consolidation processes. In these tests, the frequency of loading could be reduced to allow for equalization of excess pore water pressures. Effective stress path, shear stress-shear strain relationship, and excess pore water pressure development are also reported from these

tests. The focus in these tests on clay-like soils is on effects of cyclic loading on strength, cyclic softening and consequent strain development with reference to EPWP build-up.

Figure 4.1: Typical plots of

a) excess pore pressure with number of cyclic load cycles

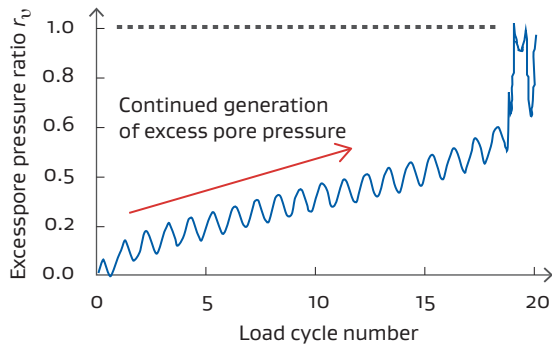

Generation of excess pore pressure and double amplitude shear strain are illustrated in Figures 4.1 below:

b) deviator stress with double-amplitude shear strain

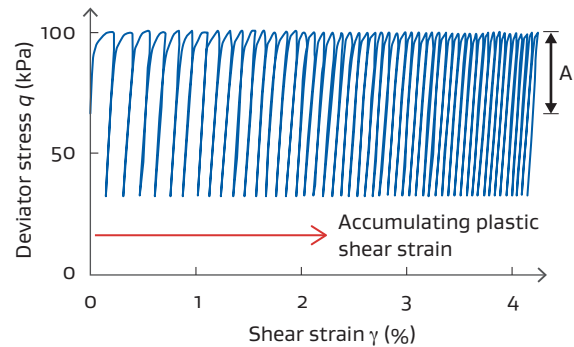

4.5 One-Dimensional Consolidation Test

The one-dimensional consolidation test (or oedometer test) provides one of the most useful and reliable laboratory measurements for soil behaviour.

The test determines:

- › the compressibility parameters (C_c , C_s , C_r)
- › stiffness in terms of constrained modulus ($M' = 1/m_v$)
- › pre-consolidation stress (σ_p')
- › rate of consolidation (c_v)
- › creep rate (C_α)
- › approximate value of permeability (k).

The one-dimensional test method assumes that dimensional change due to consolidation occurs in the vertical direction. This assumption is generally valid for medium stiff to stiff confined cohesive soils, but it is not true for soft soils or for soils that are not confined (ie bridge approaches).

Although consolidation tests can also be carried out in a triaxial test, it is more normally done in the oedometer. Care must be taken to apply appropriate test pressures, and to carry out a rebound stage. The normal test duration for each

loading increment is 24 hours, and if secondary consolidation (creep rate) is required then the test duration should not be shortened. The 24-hour consolidation period at each load increment specified in NZS4402 Test 7.1 may need to be emphasised by the geotechnical professional as there is some ambiguity regarding this in the Standard.

Importantly, the consolidation test provides the magnitude of the pre-consolidation stress ($\sigma_{vmax}' = p_c'$) of the natural deposit. The effective pre-consolidation represents the past stress history of the soil that may have undergone erosion, desiccation, seismic events, groundwater fluctuations or other processes resulting in overconsolidation. For clayey or silty soils that are suspected of being potentially susceptible to cyclic softening, based on index properties, knowledge of the pre-consolidation stress can be used to help confirm susceptibility.

4.6 Quality Assurance

Maintaining the quality of samples for laboratory testing is largely dependent on the quality assurance program followed by the field and laboratory staff. Significant changes in the material properties may be caused by improper storage, transportation and handling of samples. Such changes may result in misleading test results and therefore impact the project design.

4.6.1 SAMPLE STORAGE

Undisturbed soil samples should be transported and stored, such that their structure and their moisture content are maintained as close to their natural conditions as practicable (refer to ASTM standards D 4220 and D 5079 for further information).

Samples should not be placed, even temporarily, in direct sunlight.

Undisturbed soil samples should be stored in an upright position with the top side up.

Long term storage of soil samples should be in temperature-controlled environments with the temperature consistent with the environment of the parent formation. The relative humidity for soil storage normally should be maintained at 90 percent or higher.

Long term storage of soil samples in sampling tubes is not recommended because the interior of the tubes may corrode. This, in combination with the adhesion of the soil to the tube, may create high enough resistance to extrusion that some soils may experience internal failures during the extrusion. Often these failures cannot be seen by the naked eye and, if these samples are tested as undisturbed specimens, the results may be misleading.

Long term storage of samples, even under the best conditions, may cause changes in the characteristics of the samples. Research has shown that soil samples stored for longer than fifteen days may undergo substantial changes in strength characteristics. Soil samples stored for long periods of time may experience stress relaxation, temperature changes and prolonged exposure to the storage environment that may significantly impact the sample characteristics.

4.6.2 SAMPLE HANDLING

Careless handling of undisturbed soil samples may cause significant disturbances, with the potential for serious design and construction consequences as a result of using erroneous strength properties. Samples should be handled such that, during preparation, the sample maintains its structural integrity and its moisture condition.

Saws and knives used to trim soils should be clean and sharp. Preparation time should be kept to a minimum, especially where the maintenance of the natural moisture content is critical.

If samples are dropped, in or out of containers, it is reasonable to expect that they will be disturbed, and therefore should not be used for critical tests requiring undisturbed specimens.

4.6.3 SPECIMEN SELECTION

The selection of representative testing specimens is one of the most important aspects of sampling and testing procedures. Selected specimens should be representative of the formation being investigated. Uniform homogeneous deposits or formations are rare.

The senior laboratory technician, the geologist and/or the geotechnical engineer should study the borehole and CPT logs, have a good understanding of the site geology, and visually examine the field samples before selecting the test specimens.

Samples should be selected:

- › on the basis of their colour, physical appearance and structural features
- › to represent the types of materials most likely to influence overall or critical site/structure performance; not just the least or the best case.

For example, samples with discontinuities or intrusions may cause premature failures in the laboratory; however, they would not necessarily cause such failures in situ.

There is no single set of rules that can be applied to all specimen selection. In selecting the proper specimens, the geotechnical engineer, the geologist, and senior laboratory technician should apply their knowledge and experience with the geologic setting, materials and project requirements.

4.6.4 EQUIPMENT CALIBRATION

All laboratory equipment should be periodically checked to verify that they meet the tolerances as established by the relevant test procedures.

Sieves, ovens, compaction moulds, triaxial and permeability cells should be periodically examined to assure that they meet the specified opening size, temperature and volumetric tolerances.

Compression or tension testing equipment, including proving rings and transducers should be checked quarterly and calibrated at least once a year, using appropriately certified equipment.

Scales, particularly electronic or reflecting mirror types, should be checked at least once every day to assure they are levelled and in proper adjustment. Electronic equipment and software should also be checked at least quarterly to assure that they are working as intended.

4.6.5 TESTING STANDARDS

As discussed in Section 2.5, the liquefaction triggering methods commonly used in New Zealand are based on material index properties which to a large degree, were collected using ASTM testing procedures. For some tests there may not be a New Zealand standard, but they may have historically been performed using a British or Australian standard. Also refer to Table 4.1.

There may also be some specialised tests, such as cyclic triaxial shear for which there is an ASTM or other standard, however experienced university researchers may have modified certain procedures in order to obtain better test results.

For laboratory testing for earthquake geotechnical engineering, it is recommended that the geotechnical professional use judgement to select the most suitable testing standard/procedures. In the absence of an appropriate New Zealand standard, the use of an ASTM standard is generally recommended for tests used to determine soil properties for earthquake engineering.

4.6.6 COMMON TESTING PITFALLS

Sampling and testing of soils are important and fundamental steps in the design and construction of all types of structures. Omissions or errors introduced in these steps, if not detected, will be carried through the process of design and construction, and may result in costly or possibly unsafe facilities. Table 4.2 lists several items that the US Federal Highway Administration (FHWA) recommends be considered for proper sample handling, sample preparation and laboratory test procedures. Table 4.2 should not be considered a complete list of potential issues, but some of the more common ones.

Table 4.2: Common Sense Guidelines for Laboratory Testing of Soils

1	Protect samples to prevent moisture loss and structural disturbance.
2	Carefully handle samples during extrusion of samples; samples must be extruded properly and supported upon their exit from the tube.
3	Avoid long term storage of soil samples in Shelby tubes.
4	Properly number and identify samples.
5	Store samples in properly controlled environments.
6	Visually examine and identify soil samples after removal of smear from the sample surface.
7	Use pocket penetrometer or miniature vane only for an indication of strength.
8	Carefully select 'representative' specimens for testing.
9	Have a sufficient number of samples to select from.
10	Always consult the field logs for proper selection of specimens.
11	Recognize disturbances caused by sampling, the presence of cuttings, drilling mud or other foreign matter, and avoid during selection of specimens.
12	Do not depend solely on the visual identification of soils for classification.
13	Always perform organic content tests when classifying soils as peat or organic. Visual classifications of organic soils may be very misleading.
14	Do not dry soils in overheated or underheated ovens.
15	Discard old worn-out equipment; old screens for example, particularly fine (<No. 40) mesh ones need to be inspected and replaced often, worn compaction mold or compaction hammers (an error in the volume of a compaction mold is amplified 30x when translated to unit volume) should be checked and replaced if needed.
16	Performance of Atterberg Limits requires carefully adjusted drop height of the Liquid Limit machine and proper rolling of Plastic Limit specimens.
17	Do not use of tap water for tests where distilled water is specified.
18	Properly cure stabilisation test specimens.
19	Never assume that all samples are saturated as received.
20	Saturation must be performed using properly staged back pressures.
21	Use properly fitted o-rings, membranes etc. in triaxial or permeability tests.
22	Evenly trim the ends and sides of undisturbed samples.
23	Be careful to identify slickensides and natural fissures. Report slickensides and natural fissures.
24	Also do not mistakenly identify failures due to slickensides as shear failures.
25	Do not use unconfined compression test results (stress-strain curves) to determine elastic moduli.
26	Incremental loading of consolidation tests should only be performed after the completion of each primary stage.
27	Use proper loading rate for strength tests.
28	Do not guesstimate e-log p curves from accelerated, incomplete consolidation tests.
29	Avoid 'Reconstructing' soil specimens, disturbed by sampling or handling, for undisturbed testing.
30	Correctly label laboratory test specimens.
31	Do not take shortcuts: using non-standard equipment or non-standard test procedures.
32	Periodically calibrate all testing equipment and maintain calibration records.
33	Always test a sufficient number of samples to obtain representative results in variable material.

5 Geotechnical Reports

A geotechnical report (or series of reports) presents all of the relevant geotechnical information which has been obtained from an investigation program.

The type and format of a report will vary from project to project, depending on the purpose and type of investigation, specific client requirements, and regulatory authority requirements.

The report(s) content may include:

- › factual information and observations
- › interpretations
- › professional opinions, recommendations or advice.

The factual information from an investigation is sometimes presented in a separate report or volume from interpreted information.

Depending on the scope of the project, the following information is commonly found in a geotechnical site investigation report:

- › project description and scope, purpose of the investigation
- › site description, site conditions and topographical information
- › investigation and testing programme
- › existing available information
- › geological setting, site and regional geomorphology

- › seismic setting
- › ground conditions, groundwater profile and subsurface profiles/geotechnical model revealed by the investigation
- › interpreted data and lab data as appropriate to the project — soil properties, soil stiffness profiles, liquefaction potential, bearing capacities, settlements, pile capacities, soil strengths, permeability, geophysical data etc.
- › recommendations — siting of buildings, suitable bearing layers, appropriate foundation types, stability, earthworks, drainage, temporary batters, soil retention etc.
- › summary and conclusions
- › limitations
- › references
- › appendices
 - 1 site plans
 - 2 cross-sections
 - 3 borehole logs/CPT profiles
 - 4 lab data
 - 5 analysis outputs
 - 6 foundation design charts.

5.1 Data Presentation

5.1.1 SITE INVESTIGATION LOGS

There are numerous commercial software applications for the production of borehole logs, with the main ones used in New Zealand being gINT and Core-GS. This is leading to more standardisation in data presentation.

Given that all borelogs and CPT data (as well as lab data) need to be uploaded to the New Zealand Geotechnical Database in AGS4 NZ⁴ format, it is recommended that geotechnical records and software outputs are transcribed and stored

in accordance with the procedures outlined in the NZGS AGS4 guidance document 'Electronic transfer of geotechnical and geo-environmental data, AGS4 NZ v1.0.1 (AGS⁵ edition 4.0.4 — New Zealand Localisation)' (NZGS 2017).

4 New Zealand version of the UK AGS format, which enables geotechnical data to be shared and used across numerous software applications
 5 The Association of Geotechnical and Geoenvironmental Specialists (AGS) is a UK based non-profit trade association responsible for creation of the AGS geotechnical data format

CPT data and logs

As noted above, CPT data needs to be uploaded to the New Zealand Geotechnical Database in AGS4 format. The presentation of CPT data in a geotechnical report should show the following information:

- › project information
- › borehole identifier
- › date of test
- › CPT contractor
- › CPT equipment type
- › ground level RL (if applicable)
- › location (coordinates and grid system being used)
- › CPT data as relevant to the investigation:
 - 1 cone resistance
 - 2 sleeve friction and/or friction ratio
 - 3 porewater pressure
 - 4 interpreted soil type (if appropriate).

It is important to note on the log the units used, as these can vary between CPT contractors. The raw data should also indicate if the sleeve friction data has been presented with or without the depth offset to the cone resistance data.

Borehole data and logs

The amount of information that appears on a log will vary, depending on whether it is a soil borelog, rock core log, testpit log or a basic hand auger log — however all soil and rock descriptions should be in accordance with the NZGS document 'Field Description of Soil and Rock'. Basic data that should be included on a typical borelog includes:

- › project information
- › borehole identifier
- › borehole location (coordinates)
- › date of drilling (start and end)
- › drilling contractor
- › drilling equipment type
- › ground level R.L. (if applicable)
- › sampler type and recovery interval (if applicable)
- › depths and descriptions of the various soil or rock types encountered
- › recovery percentage
- › drilling resistance
- › fluid losses

- › water level observations
- › strength test depths and results (eg SPT)
- › other relevant data such as location of soils that were lab tested, RQD etc. for rock core logs.
- › borehole closure method used.

Testpit logs and basic hand auger logs will contain less data than listed above.

5.1.2 TEST INVESTIGATION LOCATIONS

The site plan should show the location of all test investigations, ideally in relation to the proposed project features (if appropriate) or in relation to existing site features. The site plan might use a site aerial photograph as a background, or a topographical plan, or a building location plan. There should be a graphical scale bar, or at least a scale stated on the plan (referenced to the drawing size), a north arrow, and a legend (where more than one type of investigation has been carried out).

5.1.3 SUBSURFACE PROFILES AND GEOTECHNICAL MODELS

A subsurface profile (sometimes referred to as a 'geotechnical model') can help in visualising and communicating a site's subsurface conditions. It can define the physical context and geological development of the project area, the stratigraphical profile with depth and lateral extent, the groundwater conditions and engineering properties of the strata. A geotechnical model can be descriptive, or graphical.

Where appropriate to both the scale of the project, and the homogeneity of the strata, a graphical cross section or '2D model' (or in some rare cases a 3D model) may be usefully developed to show the relationship between the proposed development and the underlying soil, rock, and groundwater regimes. (Care must be taken to communicate that a graphical representation of the model should not be used, extrapolated, or interpolated for inappropriate purposes.)

5.1.4 GEOTECHNICAL MODEL DEVELOPMENT PROCESS

The detail included in a geotechnical model will depend on the magnitude and complexity of the project, the inferred ground conditions and the stage of the model development.

A development process for a geotechnical model for a relatively large project is summarised below.

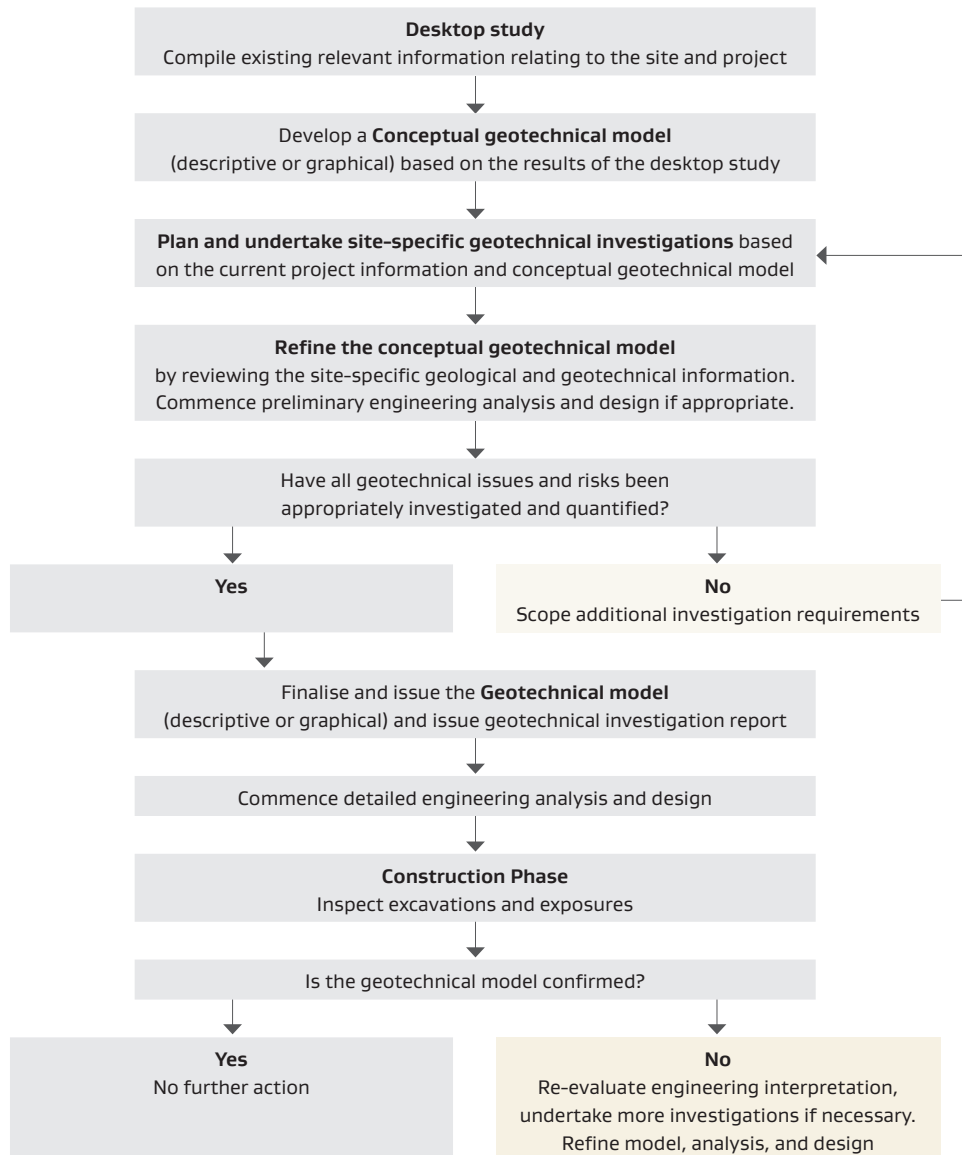
Figure 5.1: The Geotechnical Investigation Process**5.1.5 LIMITATIONS**

Although geotechnical professionals will be familiar with the inherent uncertainties associated with subsurface investigations, other users of geotechnical data or reports are often not. It is therefore important to inform such users of these uncertainties and the associated risks.

In any geotechnical report a suitable limitation should be included which states that any recommendations or judgements within the report are based on a limited amount of data, and that conditions between investigation locations may vary from what has been inferred.

The statement should also advise that any variations from the information presented in the report, encountered during subsequent excavations, should be communicated back to the report author. That way, any effects on the recommendations or advice in the report can be evaluated.

It is prudent to tie the report to the scope of development that it was originally produced for, and to point out that any liability is only to the original commissioner of the report, not to subsequent users.

6 References

- Aki, K. and Richards, P.G. (2002). *Quantitative seismology*. University Science Books, California, 704p., 2nd edition.
- Allen, F.N., Richart, F.E. Jr. & Woods, R.D. (1980). *Fluid wave propagation in saturated and nearly saturated sands*. Journal of Geotechnical Engineering Division, ASCE, 106, GT3, 235-254.
- Andrus, R.D., and Stokoe, K.H., (2000). *Liquefaction Resistance of Soils from Shear-Wave Velocity*. Journal of Geotechnical and Geoenvironmental Engineering, ASCE, 126(11), pp. 1015-1025.
- Asadi, M.B., Orense, R.P., Asadi, M.S. and Pender, M.J. (2019). *Liquefaction assessment of pumiceous sand with shear wave velocity approach*. Earthquake Geotechnical Engineering for Protection and Development of Environment and Constructions. Silvestri & Moraci (Eds), Associazione Geotecnica Italiana, Rome, Italy.
- ASTM D1190 (1994). *Standard Test Method for Bearing Capacity of Soil for Static Load and Spread Footings (withdrawn 2003)*. ASTM International.
- ASTM D1586 (2011). *Standard Test Method for Standard Penetration Test (SPT) and Split-Barrel Sampling of Soils*. ASTM International.
- ASTM D1587 (2015). *Standard Practice for Thin-Walled Tube Sampling of Fine-Grained Soils for Geotechnical Purposes*. ASTM International.
- ASTM D4318 (2010). *Standard Test Methods for Liquid Limit, Plastic Limit, and Plasticity Index of Soils*. ASTM International.
- ASTM D4428/D4428M (2014). *Standard Test Methods for crosshole seismic testing*, ASTM International.
- ASTM D4633 (2010). *Standard Test Method for Energy Measurement for Dynamic Penetrometers*. ASTM International.
- ASTM D5777 (2018). *Standard Guide for Using the Seismic Refraction Method for Subsurface Investigation*. ASTM International.
- ASTM D5778 (2020). *Standard Test Method for Performing Electronic Friction Cone and Piezocone Penetration Testing of Soils*. ASTM International.
- ASTM D6066 (2011). *Standard Test Method for the Normalized Penetration Resistance of Sands for Evaluation of Liquefaction Potential*. ASTM International.
- ASTM 7400 (2017). *Standard Test Methods for Downhole Seismic Testing*. ASTM International.
- Auckland Council (2017). *New Zealand Ground Investigation Specification*. Volumes 0-3, Revision 0. April 2017.
- Bard, P-Y, Acerra, C. et al. (2008). *Guidelines for the implementation of the H/V spectral ratio technique on ambient vibrations measurements, processing and interpretation*. Bulletin of Earthquake Engineering. 6. 1-2.
- Baziw, E. (1993). *Digital filtering techniques for interpreting seismic cone data*. Journal of Geotechnical Engineering, ASCE, 119(6), pp. 998-1018.
- Bray, J.D., Beyzaei, C.Z., Cubrinovski, M., Riemer, M., Markham, C., Stringer, M.E., Jacka, M., Wentz, F.J., and Haycock, I. (2016). *Recommendations for High-Quality Field Sampling Procedures: Using the Dames and Moore (DM) Hydraulic Fixed-Piston Thin-Walled Tube Sampler*.
- Boulanger, R.W. and DeJong, J.T. (2018). *Inverse filtering procedure to correct cone penetration data for thin-layer and transition effects*. Proceedings of the 4th International Symposium on Cone Penetration Testing (CPT'18), Delft University of Technology, The Netherlands, 21-22 June 2018. Edited by M.A. Hicks, F. Pisano, and J. Peuchen. pp. 25-44.
- Boulanger, R.W. and Idriss, I.M. (2014). *CPT and SPT based liquefaction triggering procedures*. UCD Report UCD/CGM-14/01
- Campanella, R.G. and Howie, J.A. (2005). *Guidelines for the use, Interpretation and Application of Seismic Piezocone Test Data - A Manual on Interpretation of Seismic Piezocone Test Data for Geotechnical Design*. Geotechnical Research Group, Department of Civil Engineering, The University of British Columbia, June (revised 2008).
- Campanella, R.G., and Robertson, P.K. (1988). *Current status of the piezocone test*. Proceedings of First International Conference on Penetration Testing, ISOPT-1. Invited Lecture. Disney World. March 1988. A.A. Balkema, pp. 93-116.
- Chen, B.S.-Y, and Mayne, P.W. (1994). *Profiling the Overconsolidation Ratio of Clays by Piezocone Tests*, Report No. GIT-CEEGEO-94-1 to National Science Foundation by Geosystems Engineering Group, Georgia Institute of Technology, Atlanta, 280 p.

- Cox, B.R. and Beekman, A.N. (2010). *Intramethod Variability in ReMi Dispersion Measurements and V_S Estimates at Shallow Bedrock Sites*. Journal of Geotechnical and Geoenvironmental Engineering, ASCE, 137(4), pp. 354–362.
- Cox, B.R. and Teague, D. (2016) *Layering Ratios: A Systematic Approach to the Inversion of Surface Wave Data in the Absence of A-priori Information*, Geophysical Journal International 207: 422–438.
- Cox, B.R. (2018). *In-situ seismic testing: What engineers should know about quality and uncertainty — invasive seismic testing methods*. ASCE Geo-Institute short course, fifth decennial Geotechnical Earthquake Engineering and Soil Dynamics Conference (GEESD V), Austin, Texas.
- Cox, B.R. and Wotherspoon, L.M. (2018). *In-situ Seismic Testing: Methods, Quality and Uncertainty*. New Zealand Geotechnical Society Short Course, November and December 2018.
- Cox, B. R., Stolte, A. C., Stokoe, K. H., II, & Wotherspoon, L. M. (2019). *A direct push crosshole (DPCH) test method for the in-situ evaluation of high-resolution P- and S-wave velocities*. Geotechnical Testing Journal, 42(5) pp. 1101-1132.
- De Pascale, G.P., Cresswell, J., Cheng, C., May, E., Borella, J., Twiss, A., Holtrigter, M., Thorp, A., Scott, J., Fairclough, T., and Ashfield, D. (2015). *Common problems with Cone Penetration Test (CPT) data — a reference guide for CPT Practitioners and Geotechnical Designers*. NZ Geomechanics News: Bulletin of the New Zealand Geotechnical Society Inc. 1. 89, pp.124–133.
- EN ISO 22476-1:2012 *Geotechnical investigation and testing — Field testing — Part 1: Electrical cone and piezocone penetration test*
- EQC (2012) *Geotechnical Investigations in TC3* www.eqc.govt.nz/canterburyearthquakes/geotech-tc3
- EQC (in press). *Shallow Ground Improvement Trials report*.
- Foti, S., Hollender, F., Garofalo, F., et al. (2017). *Guidelines for the good practice of surface wave analysis: a product of the InterPACIFIC project*. Bulletin of Earthquake Engineering 16. pp. 2367–2420.
- Garofalo, F., Foti, S., Hollender, F., et al. (2016). *InterPACIFIC project: Comparison of invasive and non-invasive methods for seismic site characterization. Part I: Intra-comparison of surface wave methods*. Soil Dynamics and Earthquake Engineering 82. pp. 222–240.
- Geological Survey of Canada (2012). *Shear Wave Velocity Measurement Guidelines for Canadian Seismic Site Characterization in Soil and Rock*. Open File 7078, J.A. Hunter and H.L. Crow (Editors), 227 p., doi: 10.4095/291753.
- Hunter, J.A., Luternauer, J.L., Neave, K.G., Pullan, S.E., Good, R.L., Burns, R.A. and Douma, M., (1992). *Shallow Shear Wave Velocity-Depth Data in the Fraser Delta From Surface Refraction Measurements*. 1989, 1990, 1991; Geological Survey of Canada, Open File 2504, 271p.
- Hunter, J.A., Burns, R.A., Good, R.L. and Pelletier, C.F., (1998). *A compilation of shear wave velocities and borehole geophysics logs in unconsolidated sediments of the Fraser River Delta, British Columbia*. Geological Survey of Canada, Open File 3622, 1 CD-ROM.
- Hunter, J.A., Benjumea, B., Harris, J.B., Miller, R.D., Pullan, S.E., Burns, R.A. and Good, R.L., (2002). *Surface and downhole shear wave seismic methods for thick soil site investigations*. Soil Dynamics and Earthquake Engineering, vol. 22, pp.931–941.
- Hvorslev, M.J. (1949). *Subsurface Exploration and Sampling of Soils for Civil Engineering Purposes*, U.S. Army Corps of Engineers, Waterways Experiment Station, Vicksburg, MS.
- IRTP (1999). *International Reference Test Procedure for Cone Penetration Test (CPT)*. Report of the ISSMFE Technical Committee on Penetration Testing of Soils, TC 16, Swedish Geotechnical Institute, Linköping, Information, 7, 6–16.
- Idriss, I.M. & Boulanger, R.W. (2008) *Soil liquefaction during earthquakes*. Earthquake Engineering Research Institute Monograph MNO12
- Kayen, R., Moss, R., Thompson, E., Seed, R., Cetin, K., Kiureghian, A., Tanaka, Y., and Tokimatsu, K. (2013). *Shear-Wave Velocity-Based Probabilistic and Deterministic Assessment of Seismic Soil Liquefaction Potential*. Journal of Geotechnical and Geoenvironmental Engineering, ASCE, 139(03), pp. 407–419.
- Kovacs, W.D., Salomone, L.A., and Yokel, F.Y. (1983). *Energy Measurements in the Standard Penetration Test*. Building Science Series 135, National Bureau of Standards, Washington, 73.
- Kulhawy, F.H., and Mayne, P.W. (1990). *Manual on Estimating Soil Properties for Foundation Design*. Report EPRI-EL 6800, Electric Power Research Institute, Palo Alto, 306 p.
- Lunne, T., Robertson, P.K., Powell, J.J.M. (1997). *Cone Penetration Testing in Geotechnical Practice*. Blackie Academic/Chapman-Hall Publishers, U.K., 312 pages.

- Lunne, T., Eidsmoen, T., Gillespie, D., and Howland, J.D. (1986). *Laboratory and Field Evaluation of Cone Penetrometers*, Use of In-Situ Tests in Geotechnical Engineering, (GSP 6), American Society of Civil Engineers, Reston, Va., 1986, pp. 714–729.
- Mayne, P.W., Christopher, B.R., and DeJong, J. (2001). *Manual on Subsurface Investigations*. National Highway Institute. Rep. No. FHWA-NHI-01-031. Federal Highway Administration. Washington D.C., U.S.A.
- Mayne, P. (2007). *NCHRP Synthesis 368: Cone Penetration Testing — A Synthesis of Highway Practice*. Transportation Research Board, Washington DC., 118 pp.
- Mohtar, C.S. (2009). *Evaluation of the 5% double amplitude strain criterion*. Proceedings of the 17th International Conference on Soil Mechanics and Geotechnical Engineering: The Academia and Practice of Geotechnical Engineering. Vol. 1, pp. 80–83.
- Molnar, S., Cassidy, J.F., Castellaro, S., et al. (2018). *Application of Microtremor Horizontal-to-Vertical Spectral Ratio (MHVSR) Analysis for Site Characterization: State of the Art*. Surveys in Geophysics, 39, pp. 613–631.
- Mulabdic, M., Eskilson, S., and Larsson, R. (1990). *Calibration of Piezocones for Investigations in Soft Soils and Demands for Accuracy of the Equipment*, Report Varia 270, Swedish Geotechnical Institute, Linköping, Sweden, 1990, 62 pp.
- Murashev, A., Kirkcaldie, D., Keepa, C., Cubrinovski, M., and Orense, R. (2014). *The development of design guidance for bridges in New Zealand for liquefaction and lateral spreading effects*. NZ Transport Agency research report 553. 142pp.
- New Zealand Geotechnical Society (2005). *Field Description of Soil and Rock, Guideline for the Field Classification and Description of Soil and Rock for Engineering Purposes*, NZ Geotechnical Society Inc, December.
- New Zealand Geotechnical Society (2017). Electronic transfer of geotechnical and geoenvironmental data. AGS4 NZ — New Zealand Localisation, October 2017.
- Oh, W. T., and Vanapalli S. K. (2014). *Scale Effect of Plate Load Tests in Unsaturated Soils*. Int. J. of GEOMATE, June, 2013, Vol. 4, No. 2 (SI. No. 8), pp. 585–594
- Orense, R.P. (2020). *Evaluating Liquefaction Potential of Pumiceous Deposits through Field Testing: Case Study of the 1987 Edgecumbe Earthquake*. Bulletin of the New Zealand Society for Earthquake Engineering, 53(2), pp. 101–110.
- Orense, R.P., Pender, M.J. (2013). *Liquefaction characteristics of crushable pumice sand*. Proceedings of the 18th International Conference on Soil Mechanics and Geotechnical Engineering, Paris.
- Orense, R.P., Pender, M.J. (2015). *From micro to macro: An investigation of the geomechanical behaviour of pumice sand*. Keynote Lecture, Int. Workshop on Volcanic Rocks & Soils, Isles of Ischia, Ital, 45–62.
- Paige-Green, P., du Plessis, L. (2009). *The use and Interpretation of the Dynamic Cone Penetrometer (DCP) Test*. CSIR Built Environment Pretoria, Version 2, September.
- Park, C.B., Miller, R.D. and Xia, J. (1998). *Imaging dispersion curves of surface waves on multichannel record*. Proceedings, Technical Program with biographies, 68th Annual Meeting of the Society of Exploration Geophysicists (SEG), New Orleans, Louisiana, pp. 1377–1380.
- Park, C.B., Miller, R.D. and Xia, J., (1999). *Multichannel analysis of surface waves*, Geophysics, v. 64, p. 800–808.
- Powers, J.P. (1992). *Construction Dewatering*. John Wiley & Son, Inc, New York.
- Richart, F. E. Jr., Hall, J. R., & Woods, R. D. (1970). *Vibrations of Soils and Foundations*, Prentice Hall, Inc., Englewood Cliffs, New Jersey.
- Robertson, P.K. (1990). *Soil Classification Using the Cone Penetration Test*. Canadian Geotechnical Journal, Vol. 27, No. 1, 1990, pp. 151–158.
- Robertson, P.K., and Wride, C.E. (1998). *Evaluating Cyclic Liquefaction Potential Using the Cone Penetration Test*, Canadian Geotechnical Journal, Vol. 35, No. 3, 1998, pp. 442–459.
- Robertson, P.K. (2013). *The James K. Mitchell Lecture: Interpretation of in-situ tests—some insights*, Geotechnical and Geophysical Site Characterization 4, Coutinho & Mayne (eds), Taylor & Francis Group, London, ISBN 978-0-415-62136-6.
- Roberston, P.K., Cabal, K.L. (2015). *Guide to Cone Penetration Testing for Geotechnical Engineering*, 6th edition, Gregg Drilling & Testing, Inc.
- Scala, A. J., (1956). *Simple Methods of Flexible Pavement Design Using Cone Penetrometers*, Proceedings of the Second Australian Soil Mechanics Conference, Christchurch, New Zealand, New Zealand Engineer, 11(2), pp. 34–44.
- Seed, H.B., and Lee, K.L., (1966). *Liquefaction of Saturated Sands During Cyclic Loading*. Journal of the Soil Mechanics and Foundations Division, ASCE 92, pp. 105–134.

Skempton, A.W. (1986) 3.2.4.3.1 *SPT Procedures and the Effect in Sands of Overburden Pressure, Relative Density, Particle Size, Ageing, and Overconsolidation*. Geotechnique Vol 36, No 3, 425–447.

Stokoe, K.H., Cox, B.R., Lin, Y.-C., Jung, M.J., Menq, F.-Y., Bay, J.A., Rosenblad, B. and Wong, I., (2006). *Use of Intermediate to Large Vibrators as Surface Wave Sources to Evaluate V_s Profiles for Earthquake Studies*. Proceedings, 19th Symposium on the Application of Geophysics to Engineering and Environmental Problems (SAGEEP), Seattle, WA, pp. 1241–1258.

Stokoe, K.H., and Nazaraian S, (1985) *Use of Rayleigh waves in liquefaction studies*. Measurement and Use of Shear Wave Velocity for Evaluating Dynamic Soil Properties, (ed.) R.D. Woods; ASCE, New York, pp. 1–17.

Stolte, A.C. and Cox, B.R., (2020). *Towards consideration of epistemic uncertainty in shear wave velocity measurements obtained via SCPT*. Canadian Geotechnical Journal 57(1): 48–60.

Stringer, M., Cubrinovski, M., Bray, J.D., Haycock, I, Beyzaei, C.Z., Jacka, M., Wentz, F.J. (2016). *Recommendations for High Quality Field Sampling using the Gel-Push Type S Sampler*.

Strobbia, C., and Cassiani, G. (2011). *Refraction microtremors: Data analysis and diagnostics of deq hypotheses*. Geophysics. 76(3): MA11–20.

Tani, K. and Kaneko, S. (2006). *Undisturbed sampling method using thick water soluble polymer solution*. Tsuchi-to-Kiso, Journal of the Japanese Geotechnical Society [In Japanese], 54(4), pp. 145–148.

Wentz, F., (2019). *Invasive Seismic Testing: A Summary of Good Practice*. Quake Centre Report, Christchurch, NZ.

Wentz, F.J. and Dickenson, S.E. (2013). *Pore Pressure Response during High Frequency Sonic Drilling and SPT Sampling in Liquefiable Sand*. Proceedings of the 19th NZGS Geotechnical Symposium, Queenstown, New Zealand.

Woods, R.D., (1978). *Measurement of Soil Properties — State of the Art Report*. Proceedings, Earthquake Engineering and Soil Dynamics, Vol. I, ASCE, Pasadena, CA, pp. 91–178.

Wotherspoon, L.M., Wentz, R., Cox, B.R. and Stolte, A.C. (in press). *Assessing the quality and uncertainty of in-situ seismic investigation methods.*, Proceedings of the 20th NZGS Geotechnical Symposium, Dunedin, New Zealand

Appendix A. CPT Accuracy and Resolution

Accuracy is the degree to which the result of a measurement or specification conforms to the correct value or a standard. Precision refers to the closeness of two or more measurements to each other, and is synonymous with repeatability. The resolution of a measuring system is the minimum size of the change in the value of a quantity that it can detect. It will influence the accuracy and precision of a measurement.

All else being equal, the accuracy of a CPT sounding can be improved by careful instrument preparation, calibration and testing. Data quality can be considered an umbrella term incorporating a number of key components which include data accuracy, data completeness and data acquisition in accordance with an appropriate test standard. Data accuracy for CPT is not an absolute. It is possible (with certain equipment and techniques, and in certain soils) to aim for a required degree of minimum accuracy for a given application.

The accuracy of the measured parameters may be influenced by the operational tolerance of the load cell/transducer (which is generally 0.1 to 0.5 percent of the full scale output), and by third party factors such as soil conditions and cone preparation. Little information concerning the accuracy of various cone designs has been published. In general, however, strain gauge load cells have proven to provide better precision than vibrating wire and pressure transducer load cells. With careful design and maintenance, strain gauge load cells can have calibration errors less than 0.4 percent of full scale output (Campenella and Howie, 2005). A study, Lunne et al. (1986), showed that high capacity load cell cones can give results as repeatable and accurate as cones with lower load ranges. This is possible provided the load cells are of a high quality, are carefully calibrated in various operating ranges and that attention is given to thermal zero shifts.

The ASTM D 5778 testing standard is probably the most commonly used in New Zealand for CPT investigations. This standard addresses accuracy and precision in terms of cone penetrometer full scale output. Whilst the ASTM accuracy in terms of full scale output is considered acceptable for liquefaction assessment of sandy soils, other accuracy standards may be more appropriate for situations where higher resolution and accuracy is required (eg very soft soils).

The International Reference Test Procedure (ISSMGE, 1999) provides a series of Accuracy Classes for cone penetrometers as shown in Table A.1.

Table A.1: ISSMGE Accuracy Class

TEST CLASS	MEASURED PARAMETER	ALLOWABLE MINIMUM ACCURACY
1	Cone resistance, q_c	50 kPa or 3%
	Sleeve Friction, f_s	10 kPa or 10%
	Pore pressure, u	5 kPa or 2%
	Inclination, i	2°
	Penetration depth, z	0.1m or 1%
2	Cone resistance, q_c	200 kPa or 3%
	Sleeve Friction, f_s	25 kPa or 15%
	Pore pressure, u	25 kPa or 3%
	Inclination, i	2°
	Penetration depth, z	0.2m or 2%
3	Cone resistance, q_c	400 kPa or 5%
	Sleeve Friction, f_s	50 kPa or 15%
	Pore pressure, u	50 kPa or 5%
	Inclination, i	5°
	Penetration depth, z	0.2m or 2%
4	Cone resistance, q_c	500 kPa or 3%
	Sleeve Friction, f_s	50 kPa or 10%
	Penetration depth, z	0.1m or 1%

Note: The allowable minimum accuracy of the measured parameter is the larger value of the two quoted.

The relative or % accuracy applies to the measurement rather than the measuring range of capacity.

The allowable minimum accuracy for the measured parameter (when all possible sources of error are added) is the larger of the two listed in the accuracy class table. Lower limits apply where the measured parameter does not exceed the limit for the whole sounding, otherwise the higher/percentage limit is applied. Zero baseline tests are then used to assess whether the sounding has met the desired accuracy class.

Another recent and complete set of accuracy classes for cone penetrometers is defined in the CPT testing standard EN ISO 22476-1. These classes are shown in Table A.2. Further information can be found in De Pascale et al (2015).

Table A.2: EN ISO 22476-1 Accuracy Class

APPLICATION CLASS	TEST TYPE	MEASURED PARAMETER	ALLOWABLE MINIMUM ACCURACY	MAXIMUM MEASUREMENT INTERVAL	USE	
					SOIL TYPE	INTERPRETATION
1	TE2	Cone resistance	35 kPa or 5%	20 mm	A	G, H
		Sleeve friction	5 kPa or 10%			
		Pore Pressure	10 kPa or 2%			
		Inclination	2°			
		Penetration Length	0.1 m or 1%			
2	TE1	Cone resistance	100 kPa	20 mm	A	G, H*
	TE2	Sleeve friction	15 kPa or 15%		B	G, H
		Pore Pressure	25 kPa or 3%		C	G, H
		Inclination	2°		D	G, H
		Penetration Length	0.1 m or 1%			
3	TE1	Cone resistance	200 kPa or 5%	50 mm	A	G
	TE2	Sleeve friction	25 kPa or 5%		B	G, H*
		Pore Pressure	50 kPa or 5%		C	G, H
		Inclination	5°		D	G, H
		Penetration Length	0.2 m or 2%			
4	TE1	Cone resistance	500 kPa or 5%	50 mm	A	G*
		Sleeve friction	50 kPa or 20%		B	G*
		Penetration Length	0.2 m or 1%		C	G*
					D	G*

Soil Type:

- A Homogeneously bedded soils with very soft to stiff clays and silts ($q_c < 3$ MPa)
- B Mixed bedded soils with very soft to stiff clays ($1.5 \text{ MPa} < q_c < 3 \text{ MPa}$) and medium dense sands ($5 \text{ MPa} < q_c < 10 \text{ MPa}$)
- C Mixed bedded soils with stiff clays ($q_c < 3 \text{ MPa}$) and very dense sands ($q_c > 10 \text{ MPa}$)
- D Very stiff to hard clays ($q_c < 3 \text{ MPa}$) and very dense coarse soils ($q_c > 20 \text{ MPa}$)

Use:

- G Profiling and material identification with low uncertainty level
- G* Indicative profiling and material identification with high uncertainty level
- H Interpretation in terms of design with low uncertainty level
- H* Indicative interpretation in terms of design with high uncertainty level

Appendix B. Examples of Common CPT Output Errors and Anomalies

Following are examples of some of the common CPT errors/issues identified during the EQC investigations in TC3 (EQC 2012) which comprised several thousand CPT soundings. These are provided to assist CPT operators and geotechnical professionals with identifying potential quality control issues when assessing CPT data.

Baseline Data Drift

Table B.1 shows real zero baseline data collected for a series of CPT soundings. The pre-sounding baselines are sequential which clearly show the change. The post-sounding readings highlighted by broken red lines clearly indicate a problem

which was eventually traced to a cone malfunction. It is also possible to generate unacceptably high drifts in baseline readings if the baseline tests are conducted in the hole, whilst a load remains on the cone.

Table B.1: Malfunctioning cone, shown by zero drift

TEST/ CONE (50 MPa Cone)	PRE-SOUNDING ZERO BASELINE READING			POST-SOUNDING CALCULATED ZERO DRIFT			NET AREA RATIO	
	Q _c [MPa]	F _s [MPa]	U [MPa]	Q _c [MPa]	F _s [MPa]	U [MPa]	CONE TIP α	FRICTION SLEEVE β
A/123	0.154	-0.010	-0.002	11.825	0.694	0.032	0.750	0.00000
B/123	0.150	-0.001	-0.002	6.738	0.237	0.162	0.750	0.00000
C/123	0.141	0.002	-0.004	38.154	1.075	0.003	0.750	0.00000
D/123	0.138	-0.001	-0.005	48.814	0.204	0.002	0.750	0.00000
E/123	6.799	-0.023	-0.003	36.140	0.214	0.005	0.750	0.00000

Negative Tip Resistance (q_c)

Sustained negative measured tip resistance may occur as a result one or more of the following:

- › incorrect zero baseline calibration
- › incorrect processing/software setup
- › damage to the CPT cone
- › poorly assembled CPT cone.

It is also common to obtain small profile intervals of negative q_c when ‘feathering’ the cone through coarse soils or when passing from a very stiff/dense material into a very soft/loose material.

Figure B.1 shows an example of recorded negative measured resistance in organic soil. The data shown between depths of 2 and 6 meters contains over 100 readings where q_c is between -0.01 and -0.05 MPa.

If negative cone readings are identified, the zero load baseline calibration data for the test should be checked to ensure the cone was operating correctly.

In the particular scenario given for Figure B.1, zero drift can be unavoidable. In general, organic and soft/sensitive soils have very low q_c readings, thus even if the measurement drift is within specification, it can still result in negative readings in these soils. Negative values need to be critically evaluated in any case as automated simplified liquefaction analysis methods can incorrectly assesses triggering in non-liquefiable soils under such circumstances.

Figure B.1: Example Sustained Negative Measured Tip Resistance

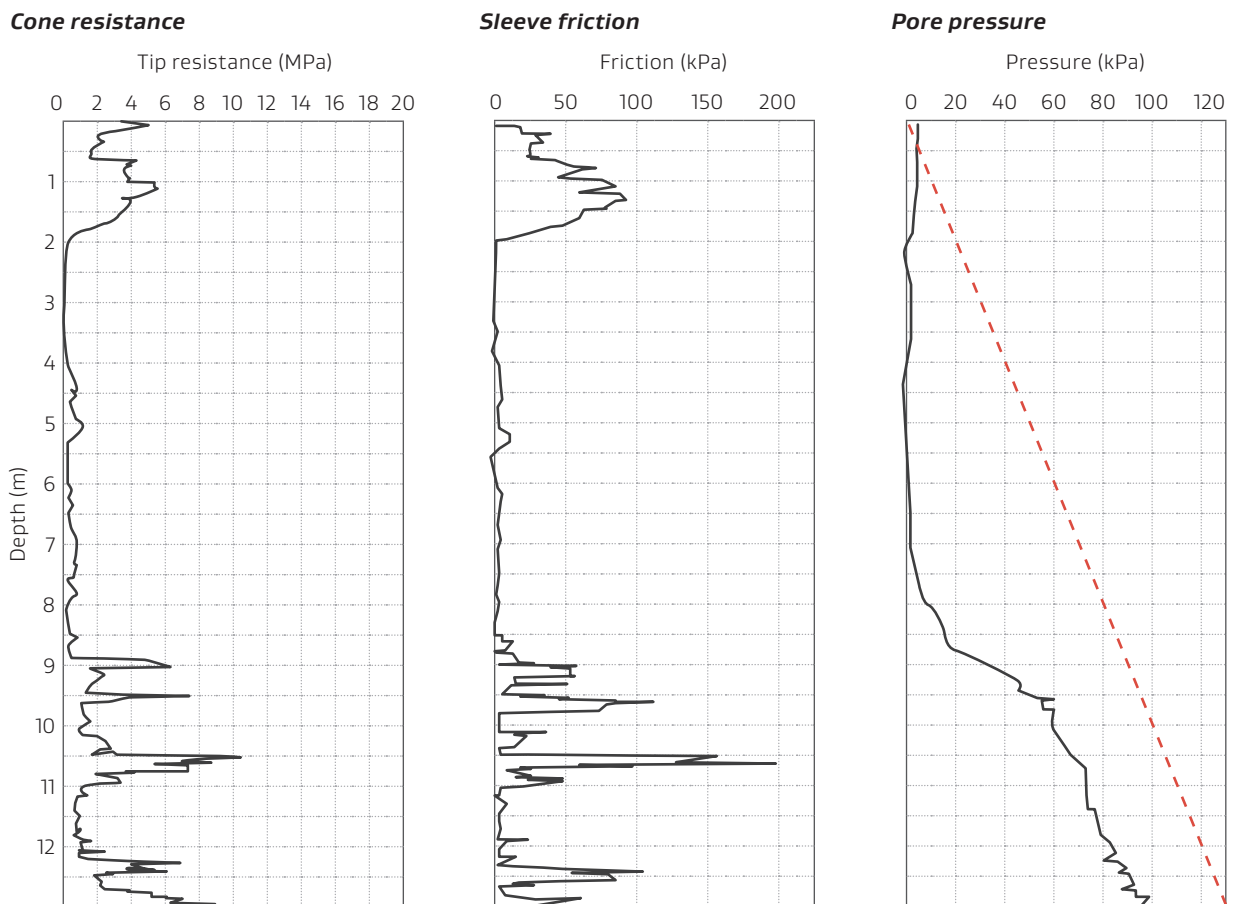
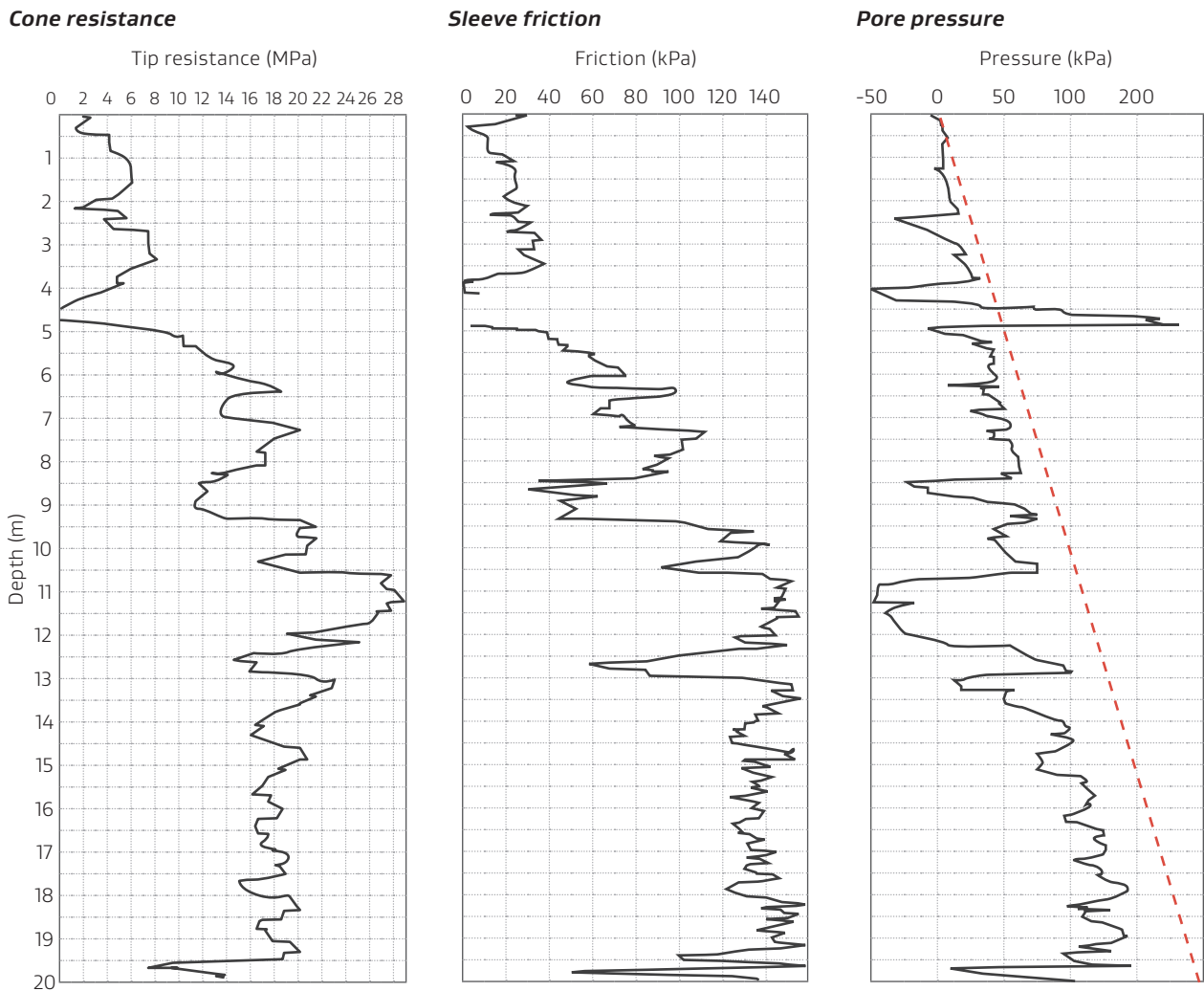

Figure B.2 shows another example of sustained negative q_c between depths of 4.3 and 4.9 metres. Unlike the previous example, the cause may not have been drift within the limits of tolerance. In this instance, the geotechnical professional should discuss the test with the CPT operator

to clarify what happened during the sounding whilst pushing the cone through the depth range in question. If the cause of the negative readings cannot be justified in the mind of the geotechnical professional, the test should be repeated using a different cone/instrument.

Figure B.2: Example Sustained Negative Measured Tip Resistance between 4.3 and 4.9 m bgl



Negative Friction Sleeve Readings (f_s)

Negative sleeve friction readings can occur due to the following:

- › damage to the CPT cone
- › 'roll back' of gravels along the friction sleeve or 'edge clipping'
- › incorrect cone assembly procedure
- › incorrect friction sleeve manufacture
- › jammed sleeve due to soil/water ingress/faulty ring seals.

Figure B.3 shows an example where the friction readings between depths of 2.5 and 3.5 m are zero or negative.

Depending on the cone design there can be problems caused by the cone not being assembled correctly, causing inaccuracies with sleeve friction readings. There have also been instances where the friction sleeve was slightly longer than the specified tolerance, which caused the penetrometer tip to push on the sleeve causing falsely high friction readings.

Figure B.3: Negative Sleeve Friction — sensor error

Cone resistance

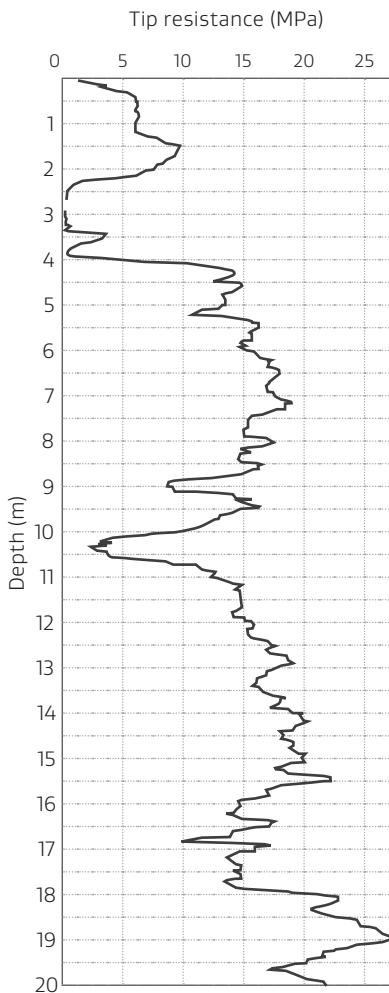

Sleeve friction

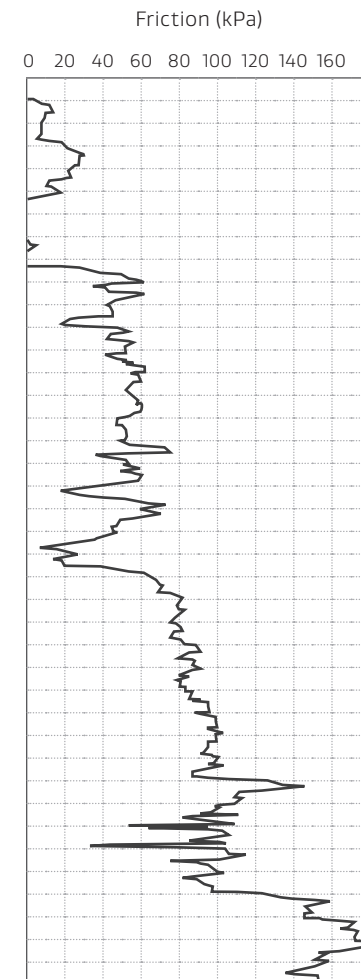
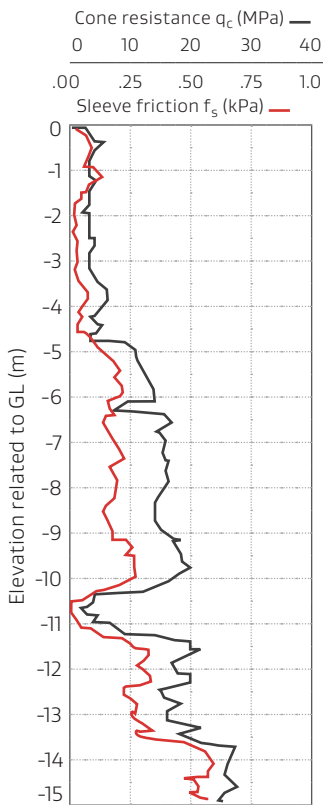

Figure B.4 shows two CPT soundings conducted 2 m apart, but where the first sounding was done with a cone friction sleeve that was found to have been assembled incorrectly.

Ideally the CPT operator or geotechnical professional's representative will identify most of these errors in the field before the need to retest arises.

Figure B.4: Negative/Incorrect Sleeve Friction — Two CPT soundings conducted 2 m apart

Sounding a) was performed with the cone sleeve assembled incorrectly



b) was performed with the same cone after the sleeve had been cleaned reassembled correctly

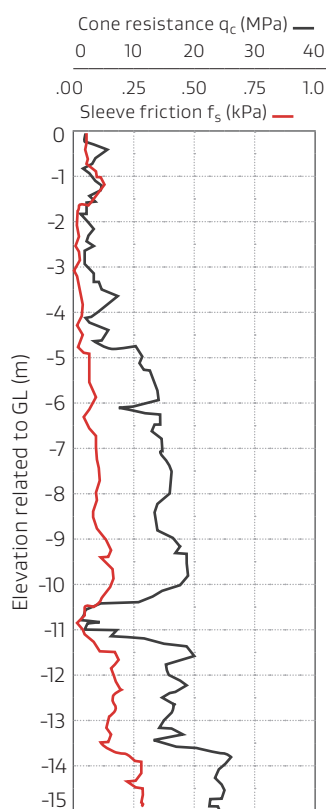

Rod Changes

A common data processing oversight is the inclusion of anomalous readings caused by adding push rods. The rod change locations are readily identifiable as sharp horizontal breaks on or just below whole metre intervals (because push rods are typically 1 m in length). Figure B.5 shows an example of reoccurring rod change spikes.

Rod break spikes in the data should be removed during processing by the CPT contractor (or geotechnical professional) prior to the data being used for analysis.

Figure B.5: multiple instances of rod changes in a CPT profile

Cone resistance

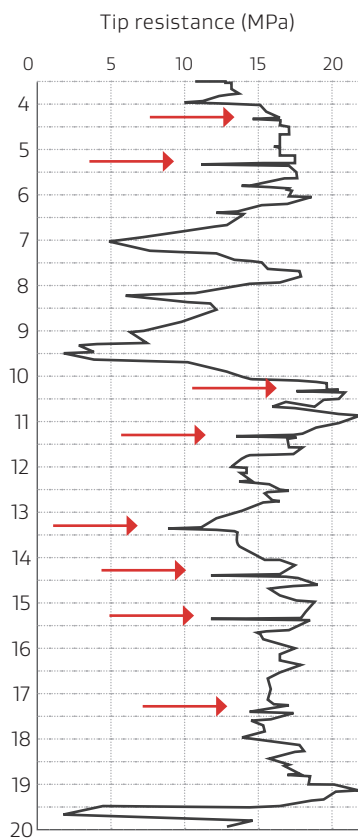

Sleeve friction

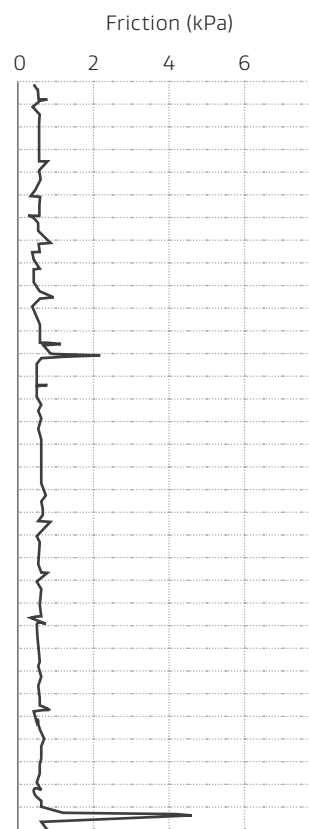

Recorded Sounding Depth

A CPT sounding normally starts at ground level, however sometimes the actual test may start below ground level due to predrilling through dense, impenetrable soils or rubble. Figure B.6 illustrates an example of a CPT sounding in a hole that was predrilled to a depth of about 0.3 m. Whilst the cone tip is measuring resistance from the ground surface, this is a result of the cone brushing the side of the predrilled hole, and the actual readings start at 0.34 m bgl. This is identified by noting that no change in readings for tip resistance, sleeve friction (and pore pressure in this case) is registered between 0 to 0.34 m.

The CPT operator should always note the depth of any pre-drill on the CPT data sheet. If there is a question as to whether the sounding location was pre-drilled, this should be verified by the geotechnical professional to ensure data integrity. This is particularly important for soundings conducted in deep pre-drilled holes which can extend to 5 m or more, and may have been backfilled with sand. In such cases, the measure tip friction and sleeve resistance can appear 'normal,' even though it is obviously not the target test soil.

Units of Measurement not Specified in Digital CPT Data

There are many different CPT systems and they record data in a variety of units of measurement, including MPa, kPa and millivoltages. If it is not clear what units the data has been recorded in, gross interpretation errors can result. The units of measurement that the data is recorded in should always be supplied by the CPT contractor; both in the digital data record and on hard copies of the CPT profiles. The geotechnical professional should check that the supplied data units are compatible with analysis methods being used, especially when using data from a new or unfamiliar CPT contractor.

Figure B.6: Incorrect start depth

DEPTH	CONE RESISTANCE	SLEEVE FRICTION RESISTANCE	u_2 (MPa)	SLOPE INDICATOR
0	0	0	0	0
0.02	0.717	0	0	1.1
0.04	0.813	0	0	1.3
0.06	0.813	0	0	1.3
0.08	0.813	0	0	1.3
0.1	0.813	0	0	1.3
0.12	0.813	0	0	1.3
0.14	0.813	0	0	1.3
0.16	0.813	0	0	1.3
0.18	0.813	0	0	1.3
0.2	0.813	0	0	1.3
0.22	0.813	0	0	1.3
0.24	0.813	0	0	1.3
0.26	0.813	0	0	1.3
0.28	0.813	0	0	1.3
0.3	0.813	0	0	1.3
0.32	0.813	0	0	1.3
0.34	8.404	9	0	1.3
0.36	9.102	16	0.001	1.3
0.38	9.702	23	0.001	1.3

Sensor Signal Loss/Jammed Sensors

Sustained repeated readings may be due to malfunctioning cone data transmission systems (in the case of wireless data transmission particularly) or jamming of sensors. These may appear in cone traces as ‘flatlines’ — ie perfectly straight vertical lines indicating that, whilst data continues to be recorded, the cone sensors are not registering changes in the soil with depth or the recorded data is not received by the computer.

Signal loss can be readily identified from the raw output data as shown in Figure B.7.

Any dataset containing ‘flatlines’ should be closely scrutinised. In the case of data signal loss

with wireless systems, the cause is often hard to pinpoint because the loss may be intermittent and very brief. Possible causes include low battery power, poor fitting/dirty rod threads (for acoustic transmission), rusted/faulty battery terminal springs and damaged receivers at surface.

It is possible to recover data lost to signal loss if the cone unit has an internal memory storage. The CPT operator should synchronise the cone prior to every sounding and review the data carefully in the field to identify signal loss early before the internal memory is overwritten.

Figure B.7: Sensor/Data transmission malfunction examples — jammed cone/Data Signal loss

H (m)	Q _c (MPa)	F _s (MPa)	U ₂ (MPa)	TA (DEGREES)
1.38	8.987	0.052	0.0002	0.79
1.4	8.987	0.052	0.0002	0.79
1.42	8.987	0.052	0.0002	0.79
1.44	8.987	0.052	0.0002	0.79
1.46	8.987	0.052	0.0002	0.79
1.48	8.987	0.052	0.0002	0.79
1.5	8.987	0.052	0.0002	0.79
1.52	8.987	0.052	0.0002	0.79
1.54	8.987	0.052	0.0002	0.79
1.56	8.987	0.052	0.0002	0.79
1.58	8.987	0.052	0.0002	0.79
1.6	8.987	0.052	0.0002	0.79
1.62	8.987	0.052	0.0002	0.79
1.64	8.987	0.052	0.0002	0.79
1.66	8.987	0.052	0.0002	0.79
1.68	8.987	0.052	0.0002	0.79
1.7	8.987	0.052	0.0002	0.79
1.72	9.113	0.052	0.0002	0.79
1.74	9.113	0.051	0.0002	0.79
1.76	9.113	0.051	0.0002	0.79
1.78	9.113	0.051	0.0002	0.79
1.8	9.113	0.051	0.0002	0.79
1.82	9.113	0.051	0.0002	0.79
1.84	9.113	0.051	0.0002	0.79
1.86	9.113	0.051	0.0002	0.79
1.88	9.113	0.051	0.0002	0.79
1.9	9.113	0.052	-0.0002	0.85
1.92	9.113	0.048	0.0001	0.89
1.94	9.348	0.047	-0.0002	0.86
1.96	9.282	0.049	-0.0007	0.85
1.98	9.086	0.051	-0.0001	0.84

H (M)	Q _c (MPa)	F _s (MPa)	U ₂ (MPa)	TA (DEGREES)
0.12	0.979	0.014	-0.0007	2.84
0.14	0.997	0.013	-0.0009	2.91
0.16	1.022	0.013	-0.0008	2.93
0.18	1.026	0.013	0	3.03
0.2	1.026	0.013	0	3.03
0.22	1.026	0.013	0	3.03
0.24	1.026	0.013	0	3.03
0.26	1.026	0.013	0	3.03
0.28	1.026	0.013	0	3.03
0.3	1.026	0.013	0	3.03
0.32	1.026	0.013	0	3.03
0.34	1.026	0.013	0	3.03
0.36	1.026	0.013	0	3.03
0.38	1.026	0.013	0	3.03
0.4	1.026	0.013	0	3.03
0.42	1.026	0.013	0	3.03
0.44	1.026	0.013	0	3.03
0.46	1.026	0.013	0	3.03
0.48	1.026	0.013	0	3.03
0.5	1.026	0.013	0	3.03
0.52	1.026	0.013	0	3.03
0.54	1.026	0.013	0	3.03
0.56	1.026	0.013	0	3.03
0.58	1.026	0.013	0	3.03
0.6	1.026	0.013	0	3.03
0.62	1.026	0.013	0	3.03
0.64	1.026	0.013	0	3.03

Appendix C. CPT Fieldwork Checklists

CONE PENETROMETER

- › Check that the cone is in calibration. This should require a combination of checking the date of the last calibration, the meterage pushed since last calibration and that the cone is operating correctly over the course of a calibration period (using zero baseline calibration records).
- › Cone tips and friction sleeves need to meet the appropriate tolerances. Daily measurements should be made using a micrometre. Measurement records should be provided to the geotechnical professional upon request.
- › Surface damage and scouring, particularly to friction sleeves, may occur when testing in coarse soils. Cone components should be replaced as necessary at the discretion of the operator and the geotechnical professional. Surface condition of the friction sleeve should be considered in particular, when testing in soft/sensitive soils and at high accuracy classes.
- › Ensure that a new, fully saturated pore pressure filter element is fitted for every test and that the cone is assembled correctly. For u_1 and u_2 positioned filters, use of a funnel apparatus of sufficient size allows the cone tip and filter to be manoeuvred and assembled beneath a head of the saturation medium. This minimises trapped air during assembly.
- › Check that prepared pore pressure filters are stored in a container which allows air to be pumped out.
- › Check that the cone is wrapped in plastic/latex during the time interval between when the cone is assembled and testing begins. Note: for high accuracy class soundings the cover must be removed prior to zero baseline testing.

RODS AND CABLES/SENSORS/DATA ACQUISITION SYSTEM

- › If a friction reducer is fitted, ensure that it is located a suitable distance from the cone tip as specified.
- › Ensure that the CPT computer software operates without error messages.
- › If a sensor system is used, record any loss of signal which may occur.

- › If a cable system is used, ensure cables are in good repair.
- › Ensure all rods are in good repair and that threads remain clean, particularly when using acoustic data transmission systems.
- › Cones with backup memory (wireless), should be synchronised at least at the start of each shift. For important soundings which may be difficult to repeat, consider synchronising before every test.
- › Where data signal loss is identified in the field it is important to recover the data from the backup memory as soon as possible, before the internal memory is overwritten. This is particularly important when using wireless data acquisition systems.

CPT SOUNDING

- › Ensure that the cone is immersed in a freshly drawn bucket of unheated tap water for at least 15 minutes at the start of each shift and between every sounding as appropriate to reduce the potential for sensor error due to thermal drift.
- › Ensure all equipment is checked pre- and post-sounding.
- › Ensure zero baseline checks are carried out pre and post sounding. The measurements do not necessarily mean that the correct operation of the cone has been checked or that the data meets a particular accuracy class. Further calculation may be required and should be confirmed by the Geotechnical professional or CPT operator.
- › Ensure CPT push rate remains consistent between 15 and 25 mm per second or as required by the specified test standard and accuracy class.
- › Check that no bending of rods takes place during testing and that deviation from vertical does not exceed tolerance. When testing in coarse soils the cone may deflect briefly creating errors, however, inclination may be largely unaffected and engineering judgement may need to be applied.

Appendix D. SPT Drilling and Sampling Procedures for Liquefaction Assessment

PREPARATION

- › Use a drilling method compatible with SPT testing — including forming the correct borehole diameter. Percussion methods such as cable tool drilling should be avoided. In soils where rotary wash drilling is not practical, high-frequency sonic drilling may be used if borehole stability (particularly bottom disturbance) is adequately controlled — refer to Section 3.2.3 of report for further discussion. Note: this drilling method is considered vibratory and hence theoretically excluded if strictly following ASTM D 6066.
- › As discussed in Section 3.2.5, it is very important that the SPT hammer system is properly calibrated. The SPT hammer should have an energy calibration certificate less than 12 months old (for routine projects) or as otherwise specified for the project. Ensure that withdrawal of any tool or rod prior to carrying out the SPT test is done at a very slow rate, to avoid creating low pressures (or suction) within the drilling fluid that might lead to base heave or disturbance.
- › Ensure that drilling fluid within the borehole is kept topped up at all times, again to reduce the risk of base heave.
- › Use a split-spoon SPT sampler with the correct dimensions. Avoid using a solid cone — including in gravels if the blow counts are to be used for liquefaction analysis.
- › Confirm that the sample hammer drop is 760 mm.
- › Note and record whether the sampler is designed to be used with interior brass sample liners, and if so, whether the liners are fitted. A sampler designed for liners can be used without them for liquefaction assessment, but this must be noted so that the proper correction factor to the blow counts can be made. Ideally, samplers designed for liners should actually contain them, to eliminate the need for this correction.

- › ‘Sound’ or measure the depth of the borehole immediately prior to lowering the SPT sampler rod string to confirm that no slough or base heave has occurred. ASTM D 6066 contains a useful discussion on how much slough is allowed for a test as well as procedures for addressing slough/base disturbance.
- › Lower, not drop, the sampler into position.
- › Confirm and record the length of the assembled SPT rod string and the length of rod showing above ground surface (rod ‘stick-up’).

TEST PERFORMANCE

- › Mark the drill rod just above the top of the hole/casing with six 75 mm increments.
- › Apply blows from the hammer (maintaining the rods in a vertical position), and record the number of blows (‘blow count’) taken to drive the sampler each 75 mm increment as in the example below. Record the ‘N’ value as the sum of the last four 75 mm increments (eg the last 300 mm of the sampler drive).

Note:

- 1 the first two increment values are known as the ‘seating drive’ and are not added to the values for the last four increments.
 $5/3/2/5/4/6 \quad N = 17$
- 2 As an alternative, the seating drive increments can be carried out prior to marking the final four ‘blow count’ increments.

- › In gravel soils, record blow counts for penetration in 25 mm increments, for example:
 $(5/3/2)/(3/3/4)/(4/1/1)/(1/3/4)/(1/1/1)/(1/0/1) \quad N = 19$

Gravel particles tend to increase SPT blow counts due to blockage of the sampler shoe or the sampler pushing the particles through the soil. To account for this effect, field SPT blow counts recorded as above can be individually corrected to account for the presence of gravel as illustrated in Figure D.1.

Figure D.1: Example of Gravel Correction for Field SPT Blow Counts

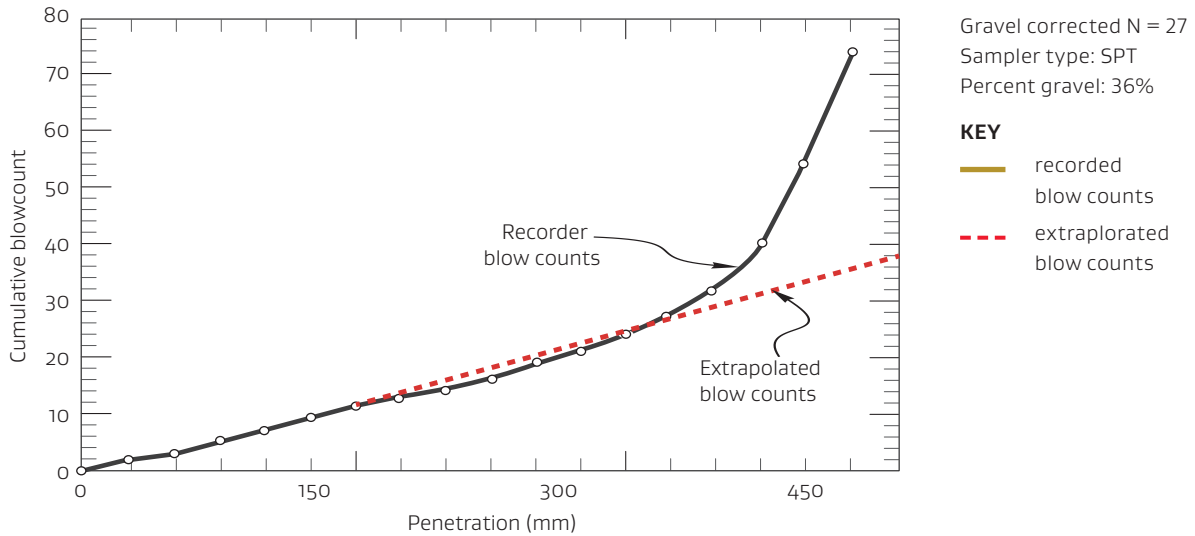

- › After the sampler rod string is initially lowered into the borehole, record any self-weight penetration (in mm) of the string, and when the hammer is added to the rod string, or both.
- › If the string sinks less than 450 mm, continue the test and record the blow count as shown in the following example:
200 mm SW/2/5/4/5
N = 16, SW refers to 'self-weight'
- › If the rod string sinks 450 mm or more, cancel the test and progress the borehole at least 500 mm before attempting another test.

DETERMINING THE END OF THE TEST

- › A total of 50 blows have been applied during any two 75 mm increments (refusal).
- › A sum total of 100 blows has been applied (refusal).
- › There is no observed advance of the sampler for 10 successive blows of the hammer (refusal).
- › The sampler has advanced for six 75 mm increments without reaching one of the limiting blow count cases given above (completion).

RECORDING REFUSAL PENETRATION

In instances where refusal occurs, record the penetration in mm for the portion of the increment successfully driven as illustrated in Figure D.2.

In this example, the blow count would be recorded as:

5/10/15/25 for 35 mm, N = 50+

SAMPLES

Recovered SPT split-spoon samples can be logged separately to recovered core. It is good practice to measure the length of sample recovered, photograph the sample and record the percentage of recovery.

Samples should be sealed immediately in double bags ('Ziplock' bags are very useful for this purpose and labelled).

Figure D.2: Refusal penetration records

