



**Boise Cascade**  
*Engineered Wood Products*

# EASTERN SPECIFIER GUIDE

for products manufactured in Alexandria [Lena], Louisiana



# The SIMPLE FRAMING SYSTEM<sup>®</sup> Makes Designing Homes Easier

Architects, engineers, and designers trust Boise Cascade's engineered wood products to provide a better system for framing floors and roofs.

It's the SIMPLE FRAMING SYSTEM<sup>®</sup>, featuring beams, joists and rim boards that work together as a system, so you spend less time cutting and fitting. In fact, the SIMPLE FRAMING SYSTEM<sup>®</sup> uses fewer pieces and longer lengths than conventional framing, so you'll complete jobs in less time.

## You'll Build Better Homes with the SIMPLE FRAMING SYSTEM<sup>®</sup>

Now it's easier than ever to design and build better floor systems. When you specify the SIMPLE FRAMING SYSTEM<sup>®</sup>, your clients will have fewer problems with squeaky floors and ceiling gypsum board cracks. The SIMPLE FRAMING SYSTEM<sup>®</sup> also means overall better floor and roof framing than dimension lumber allows.

## Better Framing Doesn't Have to Cost More

Boise Cascade Engineered Wood Products' SIMPLE FRAMING SYSTEM<sup>®</sup> often costs less than conventional framing

methods when the resulting reduced labor and materials waste are considered. There's less sorting and cost associated with disposing of waste because you order only what you need. Although our longer lengths help your clients get the job done faster, they cost no more.

## Environmentally Sound

As an added bonus, floor and roof systems built with BCI<sup>®</sup> Joists require about half the number of trees as those built with dimension lumber. This helps you design a home both you and future generations will be proud to own.

## What Makes the SIMPLE FRAMING SYSTEM<sup>®</sup> So Simple?

### ✓ Floor and Roof Framing with BCI<sup>®</sup> Joists

Light in weight, but heavy-duty, BCI<sup>®</sup> Joists have a better strength / weight ratio than dimension lumber. Knockouts can be removed for cross-ventilation and wiring.

### ✓ Ceilings Framed with BCI<sup>®</sup> Joists

The consistent size of BCI<sup>®</sup> Joists helps keep gypsum board flat and free of unsightly nail pops and ugly shadows, while keeping finish work to a minimum.

### ✓ VERSA-LAM<sup>®</sup> Beams for Floor and Roof Framing

These highly-stable beams are free of the large-scale defects that plague dimension beams. The result is quieter, flatter floors (no camber) and no shrinkage-related call-backs.

### ✓ Boise Cascade Rimboard

Boise Cascade Engineered Wood Products offer several engineered rimboard products regionally, including BC RIM BOARD<sup>®</sup> OSB, BC RIM BOARD<sup>®</sup> and VERSA-RIM<sup>®</sup> (check supplier or Boise Cascade EWP representative for availability). These products work with BCI<sup>®</sup> Joists to provide a solid connection at the critical floor/wall intersection.

Product Profiles, BCI <sup>®</sup> Architectural Specifications	3
About Floor Performance, BCI <sup>®</sup> Residential Floor Span Tables, One Hour Floor/Ceiling Assembly	4
BCI <sup>®</sup> Floor Framing Details	5 - 6
BCI <sup>®</sup> Joist Hole Location & Sizing, Large Rectangular Holes	7
BCI <sup>®</sup> Cantilever Details, Web Stiffener Requirements	8 - 9
BCI <sup>®</sup> Floor Load Tables	10 - 12
BCI <sup>®</sup> Roof Framing Details	13 - 14
BCI <sup>®</sup> Roof Span Tables	15 - 18
BCI <sup>®</sup> Roof Load Tables	19 - 23
BCI <sup>®</sup> Design Properties, BCI <sup>®</sup> Allowable Nail Spacing	24
Boise Cascade Rimboard Products/Properties	25

VERSA-LAM <sup>®</sup> Products, Specifications, Allowable Holes	26
VERSA-LAM <sup>®</sup> Details, Multiple Member Connectors	27
VERSA-LAM <sup>®</sup> Floor Load Tables (100% Load Duration)	28
VERSA-LAM <sup>®</sup> Snow Roof Load Tables (115% Load Duration)	29
VERSA-LAM <sup>®</sup> Non-Snow Roof Load Tables (125% Load Duration)	30
VERSA-LAM <sup>®</sup> Closest Allowable Nail Spacing	31
VERSA-LAM <sup>®</sup> Design Values	31
VERSA-LAM <sup>®</sup> 1.8 2750 Columns, VERSA-STUD <sup>®</sup> 1.7 2650	32
Computer Software: BC FRAMER <sup>®</sup> , BC CALC <sup>®</sup>	33
Framing Connectors: Simpson, USP	34 - 35
Lifetime Guarantee	Back Cover

## BCI® Joists

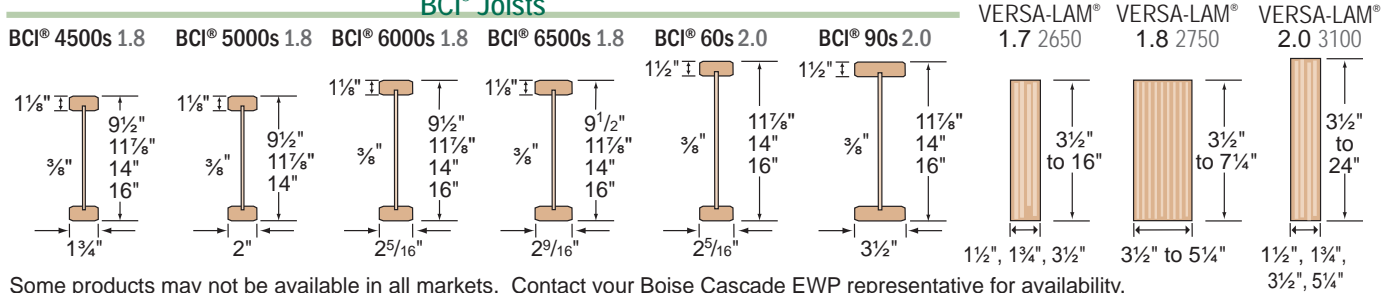

Some products may not be available in all markets. Contact your Boise Cascade EWP representative for availability.  
**BCI® and VERSA-LAM® products shall be installed in dry-use applications only, per their respective ICC ESR evaluation reports.**



## BCI® Joist Architectural Specifications

**Scope:** This work includes the complete furnishing and installation of all BCI® Joists as shown on the drawings, herein specified and necessary to complete the work.

**Materials:** BCI® Joists shall be manufactured by Boise Cascade Engineered Wood Products with oriented strand board webs, VERSA-LAM® laminated veneer lumber flanges and waterproof, structural adhesives.

Joist webs shall be graded Structural I Exposure 1 by an agency listed by a model code evaluation service. Strands on the face layers of the web panels shall be oriented vertically in the joist. The web panels shall be glued together to form a continuous web member. The web panels shall be machined to fit into a groove in the center of the wide face of the flange members so as to form a pressed glue joint at that junction.

**Design:** The BCI® Joists shall be sized and detailed to fit the dimensions and loads indicated on the plans. All designs shall be in accordance with allowable values and section properties developed in accordance with ASTM D5055 and listed in the governing code evaluation service's report.

**Drawing:** Additional drawings showing layout and detail necessary for determining fit and placement in the building are (are not) to be provided by the supplier.

**Fabrication:** The BCI® Joists and section properties shall be manufactured in a plant evaluated for fabrication by the governing code evaluation service and under the supervision of a third-party inspection agency listed by the corresponding evaluation service.

**Storage and Installation:** The BCI® Joists, if stored prior to erection, shall be stored in a vertical and level position and protected from the weather. They shall be handled with care so they are not damaged.

The BCI® Joists are to be installed in accordance with the plans and the Boise Cascade Engineered Wood Products Installation Guide. Temporary construction loads which cause stresses beyond design limits are not permitted. Erection bracing shall be provided to keep the BCI® Joists straight and plumb as required and to assure adequate lateral support for the individual BCI® Joists and the entire system until the sheathing material has been applied.

**Codes:** The BCI® Joists shall be evaluated by a model code evaluation service.

# Residential Floor Span Tables

## About Floor Performance

Homeowner's expectations and opinions vary greatly due to the subjective nature of rating a new floor. Communication with the ultimate end user to determine their expectation is critical. **Vibration** is usually the cause of most complaints. Installing lateral bridging may help; however, squeaks may occur if not installed properly. Spacing the joists closer together does little to affect the perception of the floor's performance. The most common methods used to increase the performance and reduce vibration of wood floor systems is to

**increase the joist depth, limit joist deflections, glue and screw a thicker, tongue-and-groove subfloor, install the joists vertically plumb with level-bearing supports, and install a direct-attached ceiling to the bottom flanges of the joists.**

The floor span tables listed below offer three very different performance options, based on performance requirements of the homeowner.

Joist Depth	BCI® Joist Series	★★★ THREE STAR ★★★					★★★★ FOUR STAR ★★★★★					CAUTION	★ MINIMUM STIFFNESS ALLOWED BY CODE ★					CAUTION
		<b>Live Load deflection limited to L/480:</b> The common industry and design community standard for residential floor joists, <b>33% stiffer than L/360 code minimum.</b> However, floor performance may still be an issue in certain applications, especially with 9½" and 11⅝" deep joists without a direct-attached ceiling.																
		12" o.c.	16" o.c.	19.2" o.c.	24" o.c.	32" o.c.	12" o.c.	16" o.c.	19.2" o.c.	24" o.c.	32" o.c.	12" o.c.	16" o.c.	19.2" o.c.	24" o.c.	32" o.c.		
9½"	4500s 1.8	16'-11"	15'-6"	14'-8"	13'-7"	11'-9"	11'-6"	11'-6"	10'-0"	10'-0"	9'-7"	18'-9"	16'-8"	15'-3"	13'-7"	11'-9"		
	5000s 1.8	17'-6"	16'-0"	15'-2"	14'-1"	12'-5"	11'-6"	11'-6"	10'-0"	10'-0"	9'-11"	19'-4"	17'-9"	16'-4"	14'-7"	12'-5"		
	6000s 1.8	18'-2"	16'-8"	15'-8"	14'-8"	13'-4"	11'-6"	11'-6"	10'-0"	10'-0"	10'-0"	20'-2"	18'-5"	17'-5"	15'-9"	13'-8"		
	6500s 1.8	18'-8"	17'-1"	16'-1"	15'-0"	13'-8"	11'-6"	11'-6"	10'-0"	10'-0"	10'-0"	20'-8"	18'-11"	17'-10"	16'-7"	14'-3"		
11⅝"	4500s 1.8	20'-0"	18'-4"	17'-3"	15'-5"	13'-4"	15'-6"	14'-3"	13'-5"	12'-6"	11'-4"	21'-10"	18'-11"	17'-3"	15'-5"	13'-4"		
	5000s 1.8	20'-9"	19'-0"	17'-11"	16'-7"	13'-4"	15'-6"	14'-9"	13'-11"	12'-11"	11'-9"	23'-0"	20'-4"	18'-6"	16'-7"	13'-4"		
	6000s 1.8	21'-7"	19'-8"	18'-7"	17'-4"	14'-10"	15'-6"	15'-4"	14'-5"	13'-5"	12'-1"	23'-10"	21'-10"	20'-0"	17'-11"	14'-10"		
	6500s 1.8	22'-2"	20'-3"	19'-2"	17'-10"	14'-10"	16'-0"	15'-10"	14'-11"	13'-10"	12'-7"	24'-6"	22'-5"	21'-1"	18'-10"	14'-10"		
	60s 2.0	23'-7"	21'-6"	20'-4"	18'-11"	16'-4"	18'-0"	16'-9"	15'-9"	14'-8"	13'-3"	26'-1"	23'-10"	22'-6"	21'-0"	16'-4"		
	90s 2.0	26'-7"	24'-3"	22'-10"	21'-3"	19'-4"	19'-0"	18'-10"	17'-8"	16'-5"	14'-10"	29'-5"	26'-10"	25'-3"	23'-6"	19'-4"		
14"	4500s 1.8	22'-9"	20'-7"	18'-9"	16'-9"	13'-11"	17'-10"	16'-3"	15'-4"	14'-3"	13'-0"	23'-10"	20'-7"	18'-9"	16'-9"	13'-11"		
	5000s 1.8	23'-7"	21'-7"	20'-2"	18'-0"	13'-11"	18'-6"	16'-10"	15'-11"	14'-9"	13'-5"	25'-7"	22'-1"	20'-2"	18'-0"	13'-11"		
	6000s 1.8	24'-6"	22'-5"	21'-2"	19'-6"	15'-5"	19'-2"	17'-6"	16'-6"	15'-4"	13'-11"	27'-1"	23'-11"	21'-10"	19'-6"	15'-5"		
	6500s 1.8	25'-2"	23'-0"	21'-8"	20'-2"	15'-5"	19'-8"	17'-11"	16'-11"	15'-8"	14'-3"	27'-9"	25'-2"	22'-11"	20'-6"	15'-5"		
	60s 2.0	26'-9"	24'-5"	23'-0"	21'-5"	16'-4"	20'-11"	19'-0"	17'-11"	16'-7"	15'-1"	29'-7"	27'-0"	25'-6"	21'-10"	16'-4"		
	90s 2.0	30'-1"	27'-5"	25'-10"	24'-0"	19'-6"	23'-6"	21'-4"	20'-0"	18'-6"	16'-9"	33'-3"	30'-4"	28'-7"	26'-0"	19'-6"		
16"	4500s 1.8	25'-2"	22'-0"	20'-1"	17'-11"	14'-1"	19'-9"	18'-0"	17'-0"	15'-10"	14'-1"	25'-5"	22'-0"	20'-1"	17'-11"	14'-1"		
	6000s 1.8	27'-0"	24'-9"	23'-4"	20'-10"	15'-9"	21'-2"	19'-4"	18'-2"	16'-11"	15'-4"	29'-6"	25'-6"	23'-4"	20'-10"	15'-9"		
	6500s 1.8	27'-9"	25'-4"	23'-11"	21'-1"	15'-9"	21'-9"	19'-9"	18'-8"	17'-4"	15'-8"	30'-8"	26'-11"	24'-6"	21'-1"	15'-9"		
	60s 2.0	29'-7"	27'-0"	25'-6"	21'-10"	16'-4"	23'-2"	21'-1"	19'-10"	18'-5"	16'-4"	32'-8"	29'-10"	27'-4"	21'-10"	16'-4"		
	90s 2.0	33'-4"	30'-4"	28'-7"	26'-2"	19'-7"	26'-0"	23'-7"	22'-2"	20'-6"	18'-7"	36'-10"	33'-7"	31'-8"	26'-2"	19'-7"		

- Span table is based on a residential floor load of 40 psf live load and 10 psf dead load (12 psf dead load for 90s 2.0 joists).
- Span values assume 23/32" minimum plywood/OSB rated sheathing is glued and nailed to joists for composite action (joists spaced at 32" o.c. require sheathing rated for such spacing - 7/8" plywood/OSB).
- Span values represent the most restrictive of simple or multiple span applications. Analyze multiple span joists with BC CALC® sizing software if the length of any span is less than half the length of an adjacent span.
- Span values are the maximum allowable clear distance between supports.

- Table values assume minimum bearing lengths without web stiffeners for joist depths of 16" inches and less.
- Floor tile will increase dead load and may require specific deflection limits, contact Boise Cascade EWP Engineering for further information.
- This table was designed to apply to a broad range of applications. It may be possible to exceed the limitations of this table by analyzing a specific application with the BC CALC® sizing software.

*(Shaded values do not satisfy the requirements of the North Carolina State Building Code. Refer to the THREE STAR table when spans exceed 20 feet.)*

## One-Hour Fire Resistive Assembly

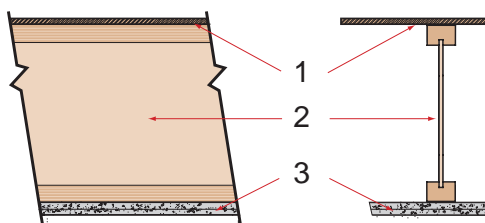

### ICC ESR 1336

#### FIRE ASSEMBLY COMPONENTS

- Min. 23/32" thick tongue and groove sheathing (exterior glue), installed with long edge perpendicular to joist length, staggered one joist spacing with adjacent sheets, and glued to joists with construction adhesive.
- BCI® Joists at 24" o.c. or less.
- Two layers 5/8" Type X or two layers 1/2" Type C gypsum board, installed per Figures 2 or 3 of ICC ESR 1336.

#### SOUND ASSEMBLY COMPONENTS When constructed with resilient channels

- Add carpet & pad to fire assembly;
- Add 3½" glass fiber insulation to fire assembly;
- Add an additional layer of minimum 5/8" sheathing and 9½" glass fiber insulation to fire assembly;

STC=54	IIC=68	or
STC=55	IIC=46	or
STC=61	IIC=50	

See the US version of the Boise Cascade Fire Design & Installation Guide for specific assembly information and other fire resistive options or contact your local Boise Cascade representative.

**NOTE**

The illustration below is showing several suggested applications for the Boise Cascade EWP products. It is not intended to show an actual house under construction.

**NO MIDSPAN BRIDGING IS REQUIRED FOR BCI® JOISTS**

**FOR INSTALLATION STABILITY, Temporary strut lines (1x4 min.) 8' on center max. Fasten at each joist with 2-8d nails minimum.**

**Dimension lumber is not suitable for use as a rim board in BCI® floor systems.**

**F01 F02**

**BCI® rim joist. See page 6.**

**F07**

**BOISE CASCADE® Rimboard. See pages 6 and 25.**

For load bearing cantilever details, see page 9.

**F06 F09**

**BCI® blocking or 2x4 "squash" block on each side required when supporting a load-bearing wall above.**

**When installing Boise Cascade EWP products with treated wood, use only connectors/fasteners that are approved for use with the corresponding wood treatment.**

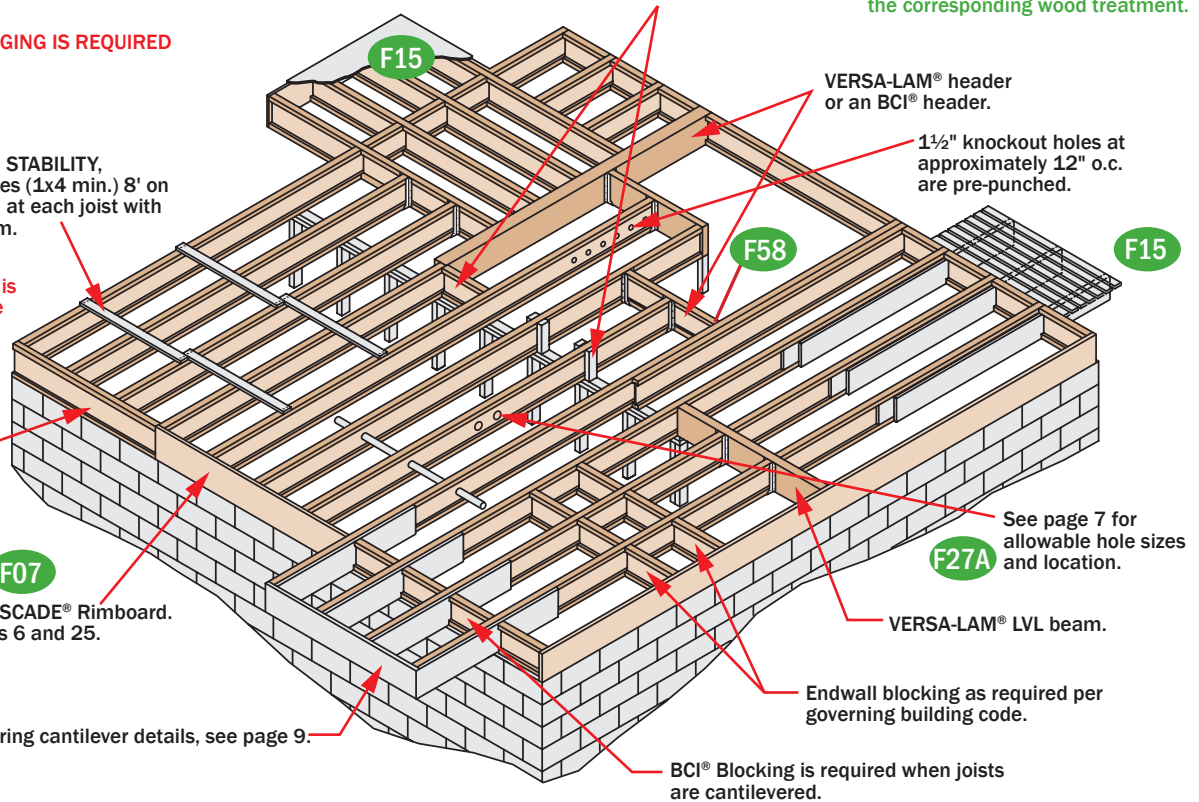

**VERSA-LAM® header or an BCI® header.**

**1 1/2" knockout holes at approximately 12" o.c. are pre-punched.**

**F58**

**F15**

**See page 7 for allowable hole sizes and location.**

**F27A**

**VERSA-LAM® LVL beam.**

**Endwall blocking as required per governing building code.**

**BCI® Blocking is required when joists are cantilevered.**

BCI® Joists, VERSA-LAM® and ALLJOIST® must be stored, installed and used in accordance with the Boise Cascade EWP Installation Guide, building codes, and to the extent not inconsistent with the Boise Cascade EWP Installation Guide, usual and customary building practices and standards. VERSA-LAM®, ALLJOIST®, and BCI® Joists must be wrapped, covered, and stored off of the ground on stickers at all times prior to installation. VERSA-LAM®, ALLJOIST® and BCI® Joists are intended only for applications

that assure no exposure to weather or the elements and an environment that is free from moisture from any source, or any pest, organism or substance which degrades or damages wood or glue bonds. Failure to correctly store, use or install VERSA-LAM®, ALLJOIST®, and BCI® Joist in accordance with the Boise Cascade EWP Installation Guide will void the limited warranty.

**SAFETY WARNING**

**DO NOT ALLOW WORKERS ON BCI® JOISTS UNTIL ALL HANGERS, BCI® RIM JOISTS, RIM BOARDS, BCI® BLOCKING PANELS, X-BRACING AND TEMPORARY 1x4 STRUT LINES ARE INSTALLED AS SPECIFIED BELOW. SERIOUS ACCIDENTS CAN RESULT FROM INSUFFICIENT ATTENTION TO PROPER BRACING DURING CONSTRUCTION. ACCIDENTS CAN BE AVOIDED UNDER NORMAL CONDITIONS BY FOLLOWING THESE GUIDELINES:**

- Build a braced end wall at the end of the bay, or permanently install the first eight feet of BCI® Joists and the first course of sheathing. As an alternate, temporary sheathing may be nailed to the first four feet of BCI® Joists at the end of the bay.
- All hangers, BCI® rim joists, rim boards, BCI® blocking panels, and x-bracing must be completely installed and properly nailed as each BCI® Joist is set.
- Install temporary 1x4 strut lines at no more than eight feet on center as additional BCI® Joists are set. Nail the strut lines to the sheathed area, or braced end wall, and to each BCI® Joist with two 8d nails.
- The ends of cantilevers must be temporarily secured by strut lines on both the top and bottom flanges.
- Straighten the BCI® Joists to within 1/2 inch of true alignment before attaching strut lines and sheathing.
- Remove the temporary strut lines only as required to install the permanent sheathing.
- Failure to install temporary bracing may result in sideways buckling or roll-over under light construction loads.
- Do not stack construction materials (sheathing, drywall, etc) in the middle of BCI® Joist spans, contact Boise Cascade EWP Engineering for proper storage and shoring information.

**PRODUCT HANDLING TO AND AT JOB SITES**

There are some differences between engineered wood products and traditional lumber products in terms of product handling: Avoid handling and storing BCI® joists in the flat direction. VERSA-LAM® is denser and due to the coating applied to the surface, can be more apt to sliding. Please consider these differences when transporting and handling engineered wood products.



Additional floor framing details available with BC FRAMER® software

## END BEARING DETAILS

**F07**

Nail BOISE CASCADE® Rimboard to BCI® Joists with 8d nail into each flange. Dimension lumber is not suitable for use as rim board with BCI® Joists.

**F07A**

Dimension lumber is not suitable for use as rimboard with BCI® Joists. Blocking may be required perpendicular to wall, consult design professional of record and/or local building official.

**F02**

BCI® rim joist. Use of BCI® rimjoist requires 2x6 wall for minimum joist bearing.

**F01**

BCI® Joist blocking.

**F27A**

Top Flange or Face Mount Joist Hanger. VERSA-LAM®.

**F52**

One 8d nail each side at bearing. 1½" minimum bearing length (1¾" required for 18" and deeper joists). To limit splitting flange, start nails at least 1½" from end. Nails may need to be driven at an angle to limit splitting of bearing plate.

**F08**

Solid block all posts from above to bearing below.

**F03**

BOISE CASCADE® Rimboard. Note: BCI® floor joist must be designed to carry wall above when not stacked over wall below. Blocking required underneath braced wall panels and shear walls, consult design professional of record.

## INTERMEDIATE BEARING DETAILS

**F06**

For load bearing wall above (stacked over wall below). BCI® Joist blocking.

**F09**

Blocking may be required at intermediate bearings for floor diaphragm per IRC in high seismic areas, consult local building official. Load bearing wall above (stacked over wall below). 2x block. 1/16" gap.

**F14**

BCI® Joist Slope Cut Reinforcement. Detail below restores original allowable shear/reaction value to cut end of BCI® joist. BCI® Joist shall not be used as a collar or rafter tension tie. 2 x 6 min. rafter. Rafter shall be supported by ridge beam or other upper bearing support. Heel Depth (see table below). 6 min. 12. 16" max. BCI depth. 24".

**F10**

Backer block (minimum 12" wide). Nail with 10-10d nails. Joist Hanger. Filler block. Nail with 10-10d nails. Backer block required where top flange joist hanger load exceeds 250 lbs. Install tight to top flange.

**F58**

Double BCI® Joist Connection. Filler Block (see chart below). Web-Filler Nailing 12" on-center. Connection valid for all applications. Contact Boise Cascade EWP Engineering for specific conditions.

**F05**

Sheathing or rimboard closure. BCI® Joist blocking required for cantilever. For load bearing cantilever, see pages 8 and 9. Uplift on backspan shall be considered in all cantilever designs.

**Table: Double Squash Block Vertical Load [lb/ft]**

Size	Joist Spacing [in]		
	12	16	24
2x4	4463	3347	2789
2x6	7013	5259	4383

1. Squash blocks are to be in full contact with upper floor and lower wall plate.  
2. Capacities shown are for a double squash blocks at each joist, SPF or better.

### LATERAL SUPPORT

- BCI® Joists shall be laterally supported at the ends with hangers, rimboard, BCI® rim joist or blocking panels. BCI® blocking panels or rimboard are required at cantilever supports.
- Blocking may be required at intermediate bearings for floor diaphragm per IRC in high seismic areas, consult local building official.

### MINIMUM BEARING LENGTH FOR BCI® JOISTS

- Minimum end bearing: 1½" for all BCI® Joists. 3½" is required at cantilever and intermediate supports.
- Longer bearing lengths allow higher reaction values. Refer to the building code evaluation report or the BC CALC® software.

### NAILING REQUIREMENTS

- BCI® rim joist, rim board or closure panel to BCI® joist:
  - Rims or closure panel 1¼ inches thick and less: 2-8d nails, one each in the top and bottom flange.
  - BCI® 4500s/5000s rim joist: 2-10d box nails, one each in the top and bottom flange.
  - BCI® 6000s/60s rim joist: 2-16d box nails, one each in the top and bottom flange.
  - BCI® 6500s/90s rim joist: Toe-nail top flange to rim joist with 2-10d box nails, one each side of flange.
- BCI® rim joist, rim board or BCI® blocking panel to support:
  - Min. 8d nails @ 6" o.c. per IRC.
  - Connection per design professional of record's specification for shear transfer.
- BCI® joist to support:
  - 2-8d nails, one on each side of the web, placed 1½ inches minimum from the end of the BCI® Joist to limit splitting.

- Sheathing to BCI® joist:
  - Prescriptive residential floor sheathing nailing requires 8d common nails @ 6" o.c. on edges and @ 12" o.c. in the field (IRC Table R602.3(1)).
  - See closest allowable nail spacing limits on page 24 for floor diaphragm nailing specified at closer spacing than IRC.
  - Maximum bracing spacing for full lateral stability: 18" for BCI® 4500s & 5000s, 24" for larger BCI® joist series.
  - 14 gauge staples may be substituted for 8d nails if the staples penetrate at least 1 inch into the joist.
  - Wood screws may be acceptable, contact local building official and/or Boise Cascade EWP Engineering for further information.

### BACKER AND FILLER BLOCK DIMENSIONS

Series	Backer Block Thickness	Filler Block Thickness
4500s 1.8	5/8" or 3/4" wood panels	Two 5/8" wood panels or 2 x _
5000s 1.8	3/4" or 7/8" wood panels	Two 3/4" wood panels or 2 x _
6000s 1.8	1 1/8" or two 1/2" wood panels	2 x _ + 1/16" or 1/2" wood panel
6500s 1.8	1 1/8" or two 5/8" wood panels	2 x _ + 5/8" or 3/4" wood panel
60s 2.0	1 1/8" or two 1/2" wood panels	2 x _ + 1/16" or 1/2" wood panel
90s 2.0	2 x _ lumber	Double 2 x _ lumber

- Cut backer and filler blocks to a maximum depth equal to the web depth minus ¼" to avoid a forced fit.

### WEB STIFFENER REQUIREMENTS

- See Web Stiffener Requirements on page 9.
- PROTECT BCI® JOISTS FROM THE WEATHER**
  - BCI® Joists are intended only for applications that provide permanent protection from the weather. Bundles of product should be covered and stored off of the ground on stickers.

### BCI® RIM JOISTS AND BLOCKING

Depth [in]	Series	Vertical Load Capacity (plf)	
		No W.S. (1)	W.S. (2)
9½"	4500s 1.8, 5000s 1.8, 6000s 1.8, 6500s 1.8	2300	N/A
	4500s 1.8, 5000s 1.8, 6000s 1.8, 6500s 1.8		
11 7/8"	4500s 1.8, 5000s 1.8, 6000s 1.8, 6500s 1.8	2150	N/A
	60s 2.0, 90s 2.0		
14"	4500s 1.8, 5000s 1.8, 6000s 1.8, 6500s 1.8	2000	N/A
	60s 2.0, 90s 2.0		
16"	4500s 1.8, 6000s 1.8, 6500s 1.8	1900	2500
	60s 2.0, 90s 2.0		

- (1) No web stiffeners required.  
 (2) Web stiffeners required at each end of blocking, values not applicable for rim joists.  
 N/A: Not applicable

BCI® Joists are manufactured with 1½" round perforated knockouts in the web at approximately 12" on center

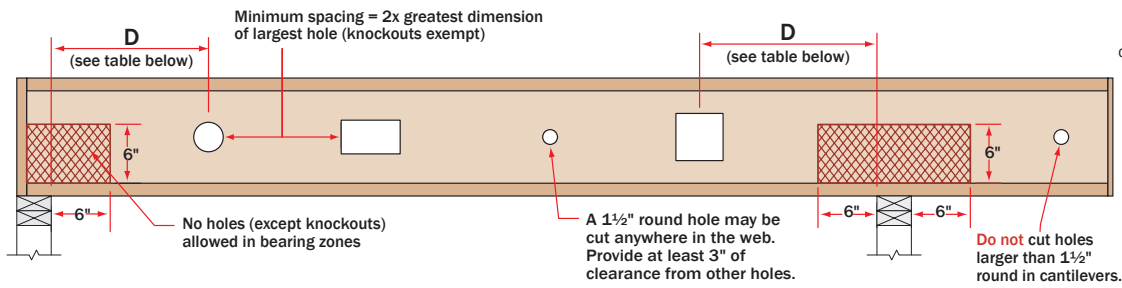

Minimum distance from support, listed in table below, is required for all holes greater than 1½"

MINIMUM DISTANCE (D) FROM ANY SUPPORT TO THE CENTERLINE OF THE HOLE																
Round Hole Diameter [in]		2	3	4	5	6	6½	7	8	8¾	9	10	11	12	13	
Rectangular Hole Side [in]		-	-	-	3	5	6	7	-	-	-	-	-	-	-	
Any 9½" Joist	Span [ft]	8	1'-0"	1'-1"	1'-5"	2'-1"	2'-9"	3'-1"	3'-5"							
		12	1'-0"	1'-2"	2'-2"	3'-2"	4'-2"	4'-8"	5'-2"							
		16	1'-0"	1'-7"	2'-11"	4'-3"	5'-7"	6'-3"	6'-11"							
Round Hole Diameter [in]		2	3	4	5	6	6½	7	8	8¾	9	10	11	12	13	
Rectangular Hole Side [in]		-	-	-	2	3	4	5	7	8	-	-	-	-	-	
Any 11¼" Joist	Span [ft]	8	1'-0"	1'-1"	1'-5"	1'-10"	2'-4"	2'-7"	2'-10"	3'-4"	3'-9"					
		12	1'-0"	1'-4"	2'-1"	2'-10"	3'-7"	3'-11"	4'-3"	5'-0"	5'-8"					
		16	1'-0"	1'-10"	2'-10"	3'-9"	4'-9"	5'-3"	5'-9"	6'-9"	7'-7"					
		20	1'-1"	2'-3"	3'-6"	4'-9"	5'-11"	6'-7"	7'-2"	8'-5"	9'-6"					
Round Hole Diameter [in]		2	3	4	5	6	6½	7	8	8¾	9	10	11	12	13	
Rectangular Hole Side [in]		-	-	-	-	2	3	3	5	6	6	8	9	-	-	
Any 14" Joist	Span [ft]	8	1'-0"	1'-1"	1'-2"	1'-3"	1'-8"	1'-10"	2'-1"	2'-6"	2'-10"	2'-11"	3'-4"	3'-8"		
		12	1'-0"	1'-1"	1'-3"	1'-10"	2'-6"	2'-10"	3'-1"	3'-9"	4'-3"	4'-4"	5'-0"	5'-7"		
		16	1'-0"	1'-1"	1'-8"	2'-6"	3'-4"	3'-9"	4'-2"	5'-0"	5'-8"	5'-10"	6'-8"	7'-5"		
		20	1'-0"	1'-1"	2'-1"	3'-2"	4'-2"	4'-8"	5'-2"	6'-3"	7'-2"	7'-3"	8'-4"	9'-4"		
		24	1'-0"	1'-4"	2'-6"	3'-9"	5'-0"	5'-8"	6'-3"	7'-6"	8'-7"	8'-9"	10'-0"	11'-2"		
Round Hole Diameter [in]		2	3	4	5	6	6½	7	8	8¾	9	10	11	12	13	
Rectangular Hole Side [in]		-	-	-	-	-	-	2	3	5	5	6	8	9	10	
Any 16" Joist	Span [ft]	8	1'-0"	1'-1"	1'-2"	1'-2"	1'-3"	1'-3"	1'-3"	1'-7"	1'-11"	2'-0"	2'-5"	2'-9"	3'-2"	3'-7"
		12	1'-0"	1'-1"	1'-2"	1'-2"	1'-3"	1'-6"	1'-10"	2'-5"	2'-11"	3'-0"	3'-7"	4'-2"	4'-9"	5'-4"
		16	1'-0"	1'-1"	1'-2"	1'-2"	1'-8"	2'-1"	2'-6"	3'-3"	3'-11"	4'-0"	4'-10"	5'-7"	6'-4"	7'-2"
		20	1'-0"	1'-1"	1'-2"	1'-2"	2'-1"	2'-7"	3'-1"	4'-1"	4'-11"	5'-1"	6'-0"	7'-0"	8'-0"	8'-11"
		24	1'-0"	1'-1"	1'-2"	1'-4"	2'-6"	3'-1"	3'-9"	4'-11"	5'-11"	6'-1"	7'-3"	8'-5"	9'-7"	10'-9"

- Select a table row based on joist depth and the actual joist span rounded up to the nearest table span. Scan across the row to the column headed by the appropriate round hole diameter or rectangular hole side. Use the longest side of a rectangular hole. The table value is the closest that the centerline of the hole may be to the centerline of the nearest support.
- The entire web may be cut out. **DO NOT** cut the flanges. Holes apply to either single or multiple joists in repetitive member conditions.
- For multiple holes, the amount of uncut web between holes must equal at least twice the diameter (or longest side) of the largest hole.
- 1½" round knockouts in the web may be removed by using a short piece of metal pipe and hammer.
- Holes may be positioned vertically anywhere in the web. The joist may be set with the 1½" knockout holes turned either up or down.
- This table was designed to apply to the design conditions covered by tables elsewhere in this publication (maximum uniform PLF load). Use the BC CALC® software to check other hole sizes or holes under other design conditions. It may be possible to exceed the limitations of this table by analyzing a specific application with the BC CALC® software.

## Large Rectangular Holes in BCI® Joists

Hole size table based on maximum uniform load of 40 psf live load and 10 psf dead load, at maximum spacing of 24" on-center.

### Single Span Joist

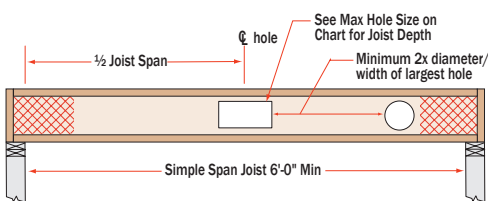

**Notes:**

Additional holes may be cut in the web provided they meet the specifications as shown in the hole distance chart shown above or as allowed using BC CALC® sizing software.

Joist Depth	Maximum Hole Size	
	Simple Span	Multiple Span
9½"	6" x 14"	6" x 12"
11½"	7" x 16" 8" x 15"	8" x 12"
14"	9" x 16" 10" x 15"	8" x 15"
16"	9" x 18" 11" x 16"	10" x 14"

### Multiple Span Joist

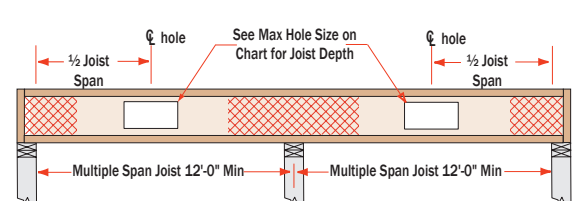

Larger holes may be possible for either Single or Multiple span joists; use BC CALC® sizing software for specific analysis.

# Reinforced Load Bearing Cantilever Table

## BCI® Joists

Joist Depth [in]	Joist Series	Roof Truss Span [ft]	Roof Total Load [psf]																																
			35			45			55																										
			Joist Spacing [in]																																
			16	19.2	24	16	19.2	24	16	19.2	24																								
9 1/2"	4500s 1.8	24	0	0	0	0	0	X	0	X	X	11 7/8"	4500s 1.8	24	0	0	0	0	0	0	0	0	1	14"	60s 2.0	24	0	0	0	0	0	0	0	0	WS
		26	0	0	0	0	0	X	0	X	X			26	0	0	0	0	0	0	0	0	0			WS									
		28	0	0	X	0	X	X	X	X	X			28	0	0	0	0	0	0	0	0	0			WS									
		30	0	0	X	0	X	X	X	X	X			30	0	0	0	0	0	0	0	0	0			WS									
	5000s 1.8	32	0	0	X	0	X	X	X	X	32		0	0	0	0	0	1	0	0	0	WS	90s 2.0		24	0	0	0	0	0	0	0	0	0	0
		34	0	0	X	0	X	X	X	X	26		0	0	0	0	0	0	0	0	0	0													
		36	0	0	X	0	X	X	X	X	28		0	0	0	0	0	0	0	0	0	0													
		38	0	0	X	0	X	X	X	X	30		0	0	0	0	0	1	0	0	0	0													
	6000s 1.8	40	0	0	X	0	X	X	X	X	32		0	0	0	0	0	1	0	0	0	X	4500s 1.8		24	0	0	0	0	0	0	0	0	0	0
		24	0	0	0	0	0	0	0	0	X		X	26	0	0	0	0	0	0	0	0			0	WS									
		26	0	0	0	0	0	0	X	X	X		28	0	0	0	0	0	0	0	0	0			WS										
		28	0	0	0	0	0	X	X	X	30		0	0	0	0	0	0	0	0	0	WS													
6500s 1.8	30	0	0	0	0	0	X	X	X	32	0	0	0	0	0	1	0	0	0	WS	6000s 1.8	24	0	0	0	0	0	0	0	0	0	WS			
	32	0	0	0	0	0	X	X	X	26	0	0	0	0	0	0	0	0	0	WS															
	34	0	0	X	0	X	X	X	X	28	0	0	0	0	0	0	0	0	0	WS															
	36	0	0	X	0	X	X	X	X	30	0	0	0	0	0	0	0	0	0	WS															
14"	4500s 1.8	38	0	0	X	0	X	X	X	38	0	0	1	0	0	X	0	1	X	16"	6000s 1.8	24	0	0	0	0	0	0	0	0	0	WS			
		40	0	0	X	0	X	X	X	40	0	0	1	0	1	X	1	X	X			26	0	0	0	0	0	0	0	0	0	WS			
		24	0	0	0	0	0	0	0	0	0	WS	5000s 1.8	28	0	0	0	0	0			0	0	0	0	WS									
		26	0	0	0	0	0	0	0	0	X	X		30	0	0	WS	28	0			0	0	0	0	WS									
	28	0	0	0	0	0	0	0	0	X	X	32		0	0	WS	30	0	0		0	0	0	WS											
	30	0	0	0	0	0	0	0	0	X	X	34		0	0	WS	32	0	0		0	0	0	WS											
	5000s 1.8	32	0	0	0	0	0	0	0	X	X	36	0	0	WS	34	0	0	WS		34	0	0	0	0	0	WS								
		34	0	0	0	0	0	X	X	X	38	0	0	WS	36	0	0	WS	36		0	0	0	0	0	WS									
		36	0	0	X	0	X	X	X	X	40	0	0	WS	38	0	0	WS	38		0	0	0	0	0	WS									
		38	0	0	X	0	X	X	X	X	42	0	0	WS	40	0	0	WS	40		0	0	0	0	0	WS									
	6000s 1.8	40	0	0	X	0	X	X	X	24	0	0	0	0	0	0	0	0	0		WS	6500s 1.8	24	0	0	0	0	0	0	0	0	0	WS		
		24	0	0	0	0	0	0	0	0	0	WS	26	0	0	0	0	0	0		0		0	0	WS										
26		0	0	0	0	0	0	0	0	0	WS	28	0	0	0	0	0	0	0	0	0		WS												
28		0	0	0	0	0	0	0	0	0	WS	30	0	0	0	0	0	0	0	0	0		WS												
6500s 1.8	30	0	0	WS	0	0	1	0	0	X	32	0	0	WS	32	0	0	0	0	0	WS														
	32	0	0	WS	0	0	1	0	1	X	34	0	0	WS	34	0	0	0	0	0	WS														
	34	0	0	WS	0	WS	X	0	X	X	36	0	0	WS	36	0	0	0	0	0	WS														
	36	0	0	WS	0	WS	X	X	X	X	38	0	0	WS	38	0	0	0	0	0	WS														
16"	4500s 1.8	40	0	0	1	0	1	X	X	X	40	0	0	WS	40	0	0	WS	40	0	0	0	0	0	WS										
		24	0	0	0	0	0	0	0	0	WS	24	0	0	0	0	0	0	0	0	0	WS													
		26	0	0	0	0	0	0	0	0	0	WS	26	0	0	0	0	0	0	0	0	0	WS												
		28	0	0	0	0	0	0	0	0	0	WS	28	0	0	0	0	0	0	0	0	0	WS												
	5000s 1.8	30	0	0	0	0	0	0	0	0	WS	30	0	0	0	0	0	0	0	0	0	WS													
		32	0	0	0	0	0	0	0	0	WS	32	0	0	0	0	0	0	0	0	0	WS													
		34	0	0	0	0	0	0	0	0	WS	34	0	0	0	0	0	0	0	0	0	WS													
		36	0	0	0	0	0	0	0	0	WS	36	0	0	0	0	0	0	0	0	0	WS													
	6000s 1.8	38	0	0	0	0	0	0	0	0	WS	38	0	0	0	0	0	0	0	0	0	WS													
		40	0	0	0	0	0	0	0	0	WS	40	0	0	0	0	0	0	0	0	0	WS													
		24	0	0	0	0	0	0	0	0	WS	24	0	0	0	0	0	0	0	0	0	WS													
		26	0	0	0	0	0	0	0	0	WS	26	0	0	0	0	0	0	0	0	0	WS													
6500s 1.8	28	0	0	0	0	0	0	0	0	WS	28	0	0	0	0	0	0	0	0	0	WS														
	30	0	0	0	0	0	0	0	0	WS	30	0	0	0	0	0	0	0	0	0	WS														
	32	0	0	0	0	0	0	0	0	WS	32	0	0	0	0	0	0	0	0	0	WS														
	34	0	0	0	0	0	0	0	0	WS	34	0	0	0	0	0	0	0	0	0	WS														

- Cut 48" long reinforcers to match the joist depth. Use min. 23/32" plywood/OSB-rated sheathing, exposure 1, 48/24 span rated. The face grain must be horizontal (measure the 48" dimension along the long edge of the panel).
- Fasten the reinfocer to the joist flanges with 8d nails at 6" o.c. When reinforcing both sides, stagger the nails to limit splitting the joist flanges.
- Attach web stiffeners per intermediate Web Stiffener Nailing Schedule on page 9.
- Use the BC CALC® software to analyze conditions that are not covered by this table. It may be possible to exceed the limitations of this table by analyzing a specific application with BC CALC® software.

**KEY TO TABLE**  
**0** . . . . No Reinforcement Required  
**WS** . . . . Web Stiffeners at Support  
**1** . . . . Web Stiffeners Plus One Reinforcer  
**2** . . . . Web Stiffeners Plus Two Reinforcers  
**X** . . . . Use Deeper Joists or Closer Spacing



# Reinforced Load Bearing Cantilever Detail

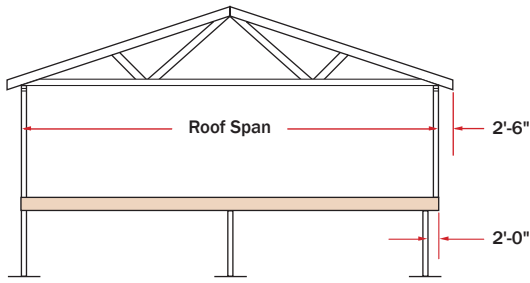

The tables and details on pages 8 and 9 indicate the type of reinforcements, if any, that are required for load-bearing cantilevers up to a maximum length of 2'-0". Cantilevers longer than 2'-0" cannot be reinforced. **However, longer cantilevers with lower loads may be allowable without reinforcement. Analyze specific applications with the BC CALC® software.**

## PLYWOOD / OSB REINFORCEMENT (If Required per Table on page 8)

- <sup>23</sup>/<sub>32</sub>" Min. x 48" long plywood / OSB rated sheathing must match the full depth of the BCI® Joist. Nail to the BCI® Joist with 8d nails at 6" o.c. and nail with 4-8d nails into backer block. When reinforcing both sides, stagger nails to limit splitting. Install with horizontal face grain.
- The tables on page 8 assume a wall weight of 100 plf, in addition to the roof loading shown. Applications with loading that exceeds the loads shown shall be analyzed with BC CALC® software.
- These requirements assume a 100 PLF wall load. Additional support may be required for other loadings, see BC CALC® software.

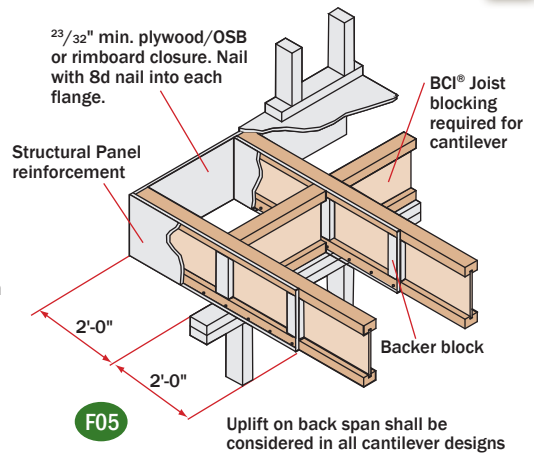

# Non-Load Bearing Wall Cantilever Details

BCI® Joists are intended only for applications that provide permanent protection from the weather.

Fasten the 2x8 minimum to the BCI® Joist by nailing through the backer block and joist web with 2 rows of 10d nails at 6" on center. Use 16d nails with BCI® 90s 2.0 joists. Clinch all nails.

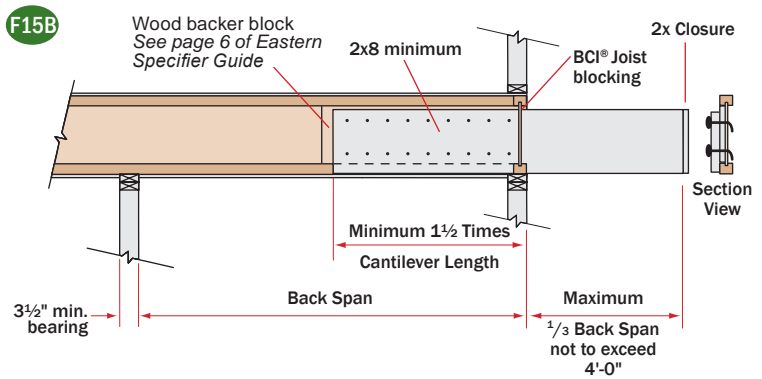
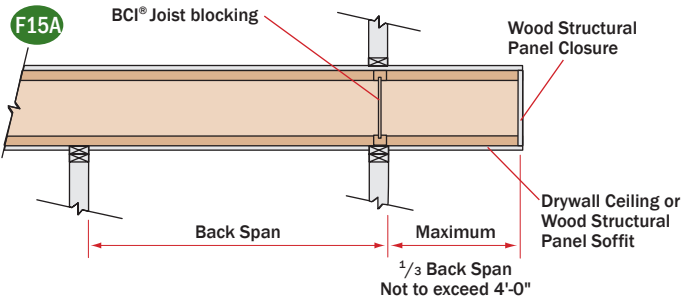

- These details apply to cantilevers with uniform loads only.
- It may be possible to exceed the limitations of these details by analyzing a specific application with the BC CALC® software.

# Web Stiffener Requirements

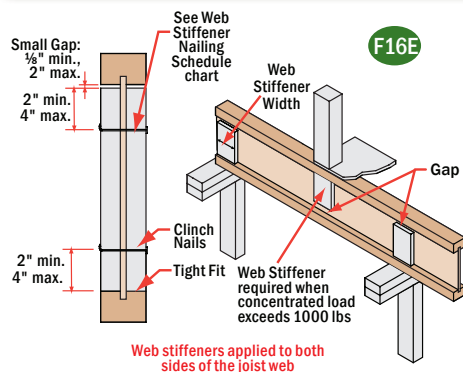

## NOTES

- Web stiffeners are optional except as noted below.
- Web stiffeners are always required in hangers that do not extend up to support the top flange of the BCI® Joist. Web stiffeners may be required with certain sloped or skewed hangers or to achieve uplift values. Refer to the hanger manufacturer's installation requirements.
- Web stiffeners are always required in certain roof applications. See Roof Framing Details on page 14.
- Web stiffeners are always required under concentrated loads that exceed 1000 pounds. Install the web stiffeners snug to the top flange in this situation. Follow the nailing schedule for intermediate bearings.
- Web stiffeners may be cut from structural rated wood panels, engineered rimboard or 2x lumber (BCI® 90s only).
- For Structural Capacity: Web stiffeners needed to increase the BCI® Joist's reaction capacity at a specific bearing location.
- Lateral Restraint in Hanger: Web stiffeners required when hanger does not laterally support the top flange (e.g., adjustable height hangers). Web stiffeners may be of multiple thickness (e.g., BCI® 6500s, double 1/2" panel OK).
- Web stiffeners may be used to increase allowable reaction values. See BCI® Design Properties on page 24 or the BC CALC® software.

Web Stiffener Specifications			
BCI® Joist Series	For Structural Capacity (Min. Thick)	Lateral Restraint in Hanger	Minimum Width
4500s 1.8	5/8"	5/8"	2 <sup>5</sup> / <sub>16</sub> "
5000s 1.8	5/8"	3/4"	2 <sup>5</sup> / <sub>16</sub> "
6000s 1.8	3/4"	7/8"	2 <sup>5</sup> / <sub>16</sub> "
6500s 1.8	3/4"	1" or 1 <sup>1</sup> / <sub>8</sub> "	2 <sup>5</sup> / <sub>16</sub> "
60s 2.0	3/4"	7/8"	2 <sup>5</sup> / <sub>16</sub> "
90s 2.0	2x4 lumber (vertical)		

Web Stiffener Nailing Schedule			
BCI® Joist Series	Joist Depth	Bearing Location	
		End	Intermediate
4500s 1.8	9 <sup>1</sup> / <sub>2</sub> "	2-8d	2-8d
	11 <sup>7</sup> / <sub>8</sub> "	2-8d	3-8d
	14"	2-8d	5-8d
	16"	2-8d	6-8d
5000s 1.8	9 <sup>1</sup> / <sub>2</sub> "	2-8d	2-8d
	11 <sup>7</sup> / <sub>8</sub> "	2-8d	3-8d
	14"	2-8d	5-8d
6000s 1.8	9 <sup>1</sup> / <sub>2</sub> "	2-8d	2-8d
	11 <sup>7</sup> / <sub>8</sub> "	2-8d	3-8d
	14"	2-8d	5-8d
6500s 1.8	9 <sup>1</sup> / <sub>2</sub> "	2-8d	2-8d
	11 <sup>7</sup> / <sub>8</sub> "	2-8d	3-8d
	14"	2-8d	5-8d
60s 2.0	11 <sup>7</sup> / <sub>8</sub> "	2-8d	3-8d
	14"	2-8d	5-8d
	16"	2-8d	6-8d
90s 2.0	11 <sup>7</sup> / <sub>8</sub> "	3-16d	3-16d
	14"	5-16d	5-16d
	16"	6-16d	6-16d

# Floor Load Tables

## Allowable Uniform Floor Load (in pounds per lineal foot [PLF])

### 100% Load Duration

Span Length	BCI® 4500s 1.8 Series 1¾" Flange Width								BCI® 5000s 1.8 Series 2" Flange Width					
	9½" BCI® 4500s 1.8		11⅞" BCI® 4500s 1.8		14" BCI® 4500s 1.8		16" BCI® 4500s 1.8		9½" BCI® 5000s 1.8		11⅞" BCI® 5000s 1.8		14" BCI® 5000s 1.8	
	Live Load	Total Load	Live Load	Total Load	Live Load	Total Load	Live Load	Total Load	Live Load	Total Load	Live Load	Total Load	Live Load	Total Load
6	-	280	-	300	-	313	-	316	-	280	-	300	-	313
7	-	240	-	257	-	268	-	271	-	240	-	257	-	268
8	-	210	-	225	-	235	-	237	-	210	-	225	-	235
9	-	186	-	200	-	208	-	211	-	186	-	200	-	208
10	147	168	-	180	-	188	-	190	163	168	-	180	-	188
11	113	152	-	163	-	170	-	172	126	152	-	163	-	170
12	89	131	144	150	-	156	-	158	99	140	-	150	-	156
13	71	111	115	138	-	144	-	146	79	128	129	138	-	144
14	57	96	94	123	-	134	-	135	64	111	105	128	-	134
15	47	83	77	107	112	125	-	126	53	96	86	120	-	125
16			64	94	93	112	-	118	44	85	72	108	104	117
17			54	83	79	99	105	111			61	96	88	110
18			46	74	67	88	89	100			51	86	75	101
19					57	79	76	90			44	77	64	91
20					49	71	66	81					55	82
21					43	65	57	74					48	74
22							50	67					42	68
23							44	61						
24														
25														

- Total Load values are limited by shear, moment, or deflection equal to L/240.
- Live Load values are limited by deflection equal to L/480. For deflection limits of L/360 and L/960, multiply the Live Load values by 1.33 and 0.50 respectively.
- Both the Total Load and Live Load columns must be checked. Where a Live Load value is not shown, the Total Load value will control.
- Table values apply to either simple or multiple span joists. Span is measured center to center of the minimum required bearing length. Analyze multiple span joists with the BC CALC® software if the length of any span is less than half the length of an adjacent span.
- Table values do not consider composite action from gluing and nailing floor sheathing (composite action is considered in floor span tables on page 4).
- Total Load values assume minimum bearing lengths without web stiffeners for joist depths of 16 inches and less.
- For assistance with floor design, consult the section *About Floor Performance* on page 4.
- This table was designed to apply to a broad range of applications. It may be possible to exceed the limitations of this table by analyzing a specific application with the BC CALC® software.

## Allowable Uniform Floor Load (in pounds per lineal foot [PLF])

### 100% Load Duration

Span Length	BCI® 6000s 1.8 Series 2 <sup>5</sup> / <sub>16</sub> " Flange Width								BCI® 6500s 1.8 Series 2 <sup>9</sup> / <sub>16</sub> " Flange Width							
	9½" BCI® 6000s 1.8		11⅞" BCI® 6000s 1.8		14" BCI® 6000s 1.8		16" BCI® 6000s 1.8		9½" BCI® 6500s 1.8		11⅞" BCI® 6500s 1.8		14" BCI® 6500s 1.8		16" BCI® 6500s 1.8	
	Live Load	Total Load	Live Load	Total Load	Live Load	Total Load	Live Load	Total Load	Live Load	Total Load	Live Load	Total Load	Live Load	Total Load	Live Load	Total Load
6	-	320	-	333	-	346	-	353	-	320	-	333	-	346	-	353
7	-	274	-	285	-	297	-	302	-	274	-	285	-	297	-	302
8	-	240	-	250	-	260	-	265	-	240	-	250	-	260	-	265
9	-	213	-	222	-	231	-	235	-	213	-	222	-	231	-	235
10	183	192	-	200	-	208	-	212	-	192	-	200	-	208	-	212
11	141	174	-	181	-	189	-	192	153	174	-	181	-	189	-	192
12	112	160	-	166	-	173	-	176	121	160	-	166	-	173	-	176
13	89	147	144	153	-	160	-	163	97	147	-	153	-	160	-	163
14	73	129	117	142	-	148	-	151	79	137	129	142	-	148	-	151
15	60	112	97	133	-	138	-	141	65	124	106	133	-	138	-	141
16	50	98	81	125	117	130	-	132	54	109	89	125	127	130	-	132
17	42	84	68	112	99	122	-	124	46	92	75	117	107	122	-	124
18			58	100	84	115	112	117			64	110	91	115	-	117
19			50	89	72	106	96	111			54	99	78	109	104	111
20			43	81	62	96	83	106			47	89	68	104	90	106
21					54	87	72	99			41	81	59	96	78	100
22					47	79	63	90					51	88	69	96
23					42	72	56	83					45	80	60	92
24							49	76					40	74	53	84
25							44	70							47	77
26															42	72
27																
28																
29																
30																



# Floor Load Tables

## Allowable Uniform Floor Load (in pounds per lineal foot [PLF])

### 100% Load Duration

Span Length	BCI® 60s 2.0 Series 2 <sup>5</sup> / <sub>16</sub> " Flange Width						BCI® 90s 2.0 Series 3 <sup>1</sup> / <sub>2</sub> " Flange Width					
	11 <sup>7</sup> / <sub>8</sub> " BCI® 60s 2.0		14" BCI® 60s 2.0		16" BCI® 60s 2.0		11 <sup>7</sup> / <sub>8</sub> " BCI® 90s 2.0		14" BCI® 90s 2.0		16" BCI® 90s 2.0	
	Live Load	Total Load	Live Load	Total Load	Live Load	Total Load	Live Load	Total Load	Live Load	Total Load	Live Load	Total Load
6	-	366	-	366	-	366	-	450	-	453	-	456
7	-	314	-	314	-	314	-	385	-	388	-	391
8	-	275	-	275	-	275	-	337	-	340	-	342
9	-	244	-	244	-	244	-	300	-	302	-	304
10	-	220	-	220	-	220	-	270	-	272	-	274
11	-	200	-	200	-	200	-	245	-	247	-	249
12	-	183	-	183	-	183	-	225	-	226	-	228
13	-	169	-	169	-	169	-	207	-	209	-	210
14	155	157	-	157	-	157	-	192	-	194	-	195
15	128	146	-	146	-	146	-	180	-	181	-	182
16	107	137	-	137	-	137	152	168	-	170	-	171
17	90	129	-	129	-	129	129	158	-	160	-	161
18	77	122	110	122	-	122	110	150	-	151	-	152
19	66	115	95	115	-	115	95	142	134	143	-	144
20	57	110	82	110	109	110	83	135	117	136	-	137
21	50	100	72	104	95	104	72	128	102	129	-	130
22	43	87	63	100	84	100	63	122	90	123	119	124
23			55	95	74	95	56	112	79	118	105	119
24			49	91	65	91	49	99	70	113	94	114
25			43	87	58	88	44	88	63	108	83	109
26					52	84			56	104	75	105
27					47	81			50	100	67	101
28					42	78			45	91	61	97
29									41	82	55	94
30											50	91

- Total Load values are limited by shear, moment, or deflection equal to L/240.
- Live Load values are limited by deflection equal to L/480. For deflection limits of L/360 and L/960, multiply the Live Load values by 1.33 and 0.50 respectively.
- Both the Total Load and Live Load columns must be checked. Where a Live Load value is not shown, the Total Load value will control.
- Table values apply to either simple or multiple span joists. Span is measured center to center of the minimum required bearing length. Analyze multiple span joists with the BC CALC® software if the length of any span is less than half the length of an adjacent span.
- Table values do not consider composite action from gluing and nailing floor sheathing (composite action is considered in floor span tables on page 4).
- Total Load values assume minimum bearing lengths without web stiffeners for joist depths of 16 inches and less.
- For assistance with floor design, consult the section *About Floor Performance* on page 4.
- This table was designed to apply to a broad range of applications. It may be possible to exceed the limitations of this table by analyzing a specific application with the BC CALC® software.

## BCI® Rafters

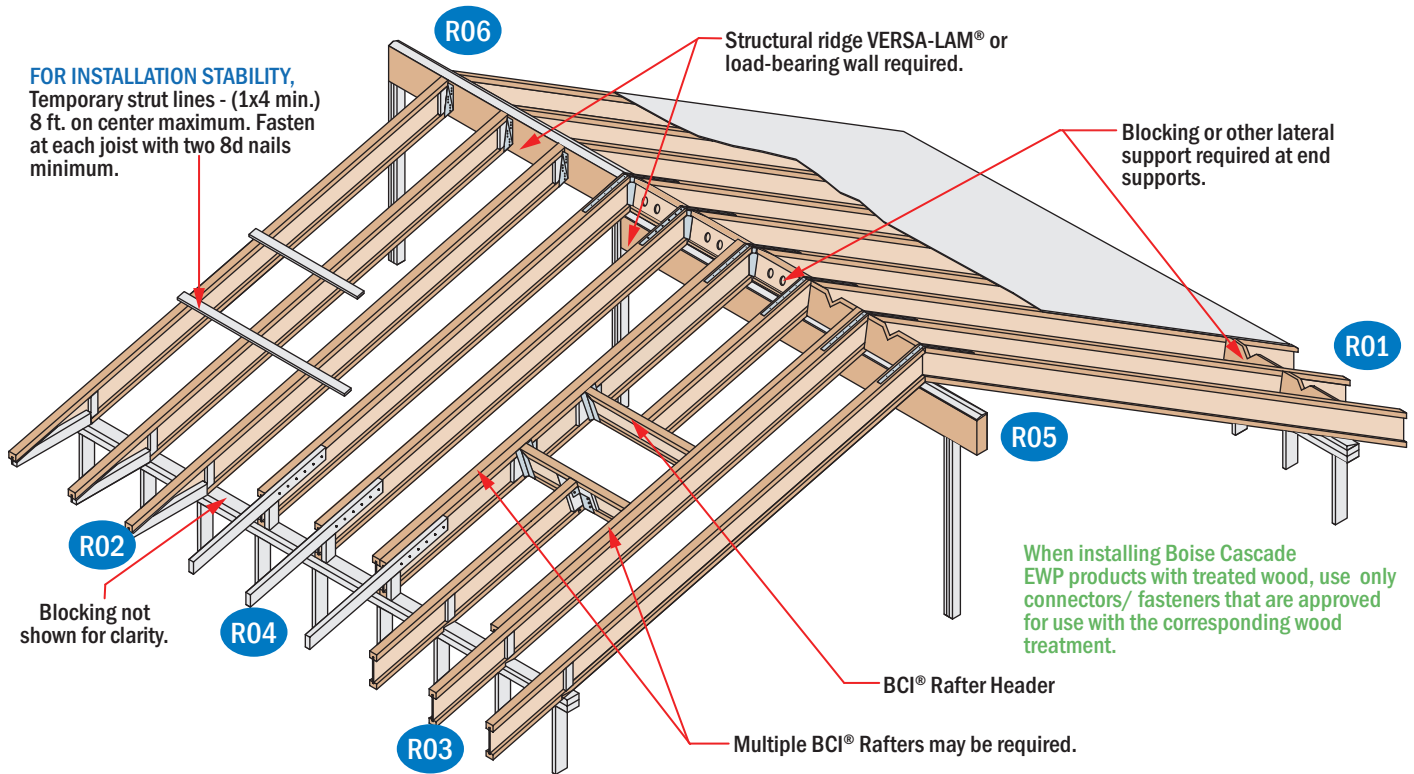

### SAFETY WARNING

**DO NOT ALLOW WORKERS ON BCI® JOISTS UNTIL ALL HANGERS, BCI® RIM JOISTS, RIM BOARDS, BCI® BLOCKING PANELS, X-BRACING AND TEMPORARY 1x4 STRUT LINES ARE INSTALLED AS SPECIFIED BELOW.**

**SERIOUS ACCIDENTS CAN RESULT FROM INSUFFICIENT ATTENTION TO PROPER BRACING DURING CONSTRUCTION. ACCIDENTS CAN BE AVOIDED UNDER NORMAL CONDITIONS BY FOLLOWING THESE GUIDELINES:**

- Build a braced end wall at the end of the bay, or permanently install the first eight feet of BCI® Joists and the first course of sheathing. As an alternate, temporary sheathing may be nailed to the first four feet of BCI® Joists at the end of the bay.
- All hangers, BCI® rim joists, rim boards, BCI® blocking panels, and x-bracing must be completely installed and properly nailed as each BCI® Joist is set.
- Install temporary 1x4 strut lines at no more than eight feet on center as additional BCI® Joists are set. Nail the strut lines to the sheathed area, or braced end wall, and to each BCI® Joist with two 8d nails.
- The ends of cantilevers must be temporarily secured by strut lines on both the top and bottom flanges.
- Straighten the BCI® Joists to within ½ inch of true alignment before attaching strut lines and sheathing.
- Remove the temporary strut lines only as required to install the permanent sheathing.
- Failure to install temporary bracing may result in sideways buckling or roll-over under light construction loads.

### BCI® Ceiling Joist with Bevel End Cut (For Limited-Access Attics Only)

**BCI® Joist shall not be used as collar/tension tie. Roof rafter shall be supported by ridge beam or other upper bearing support.**

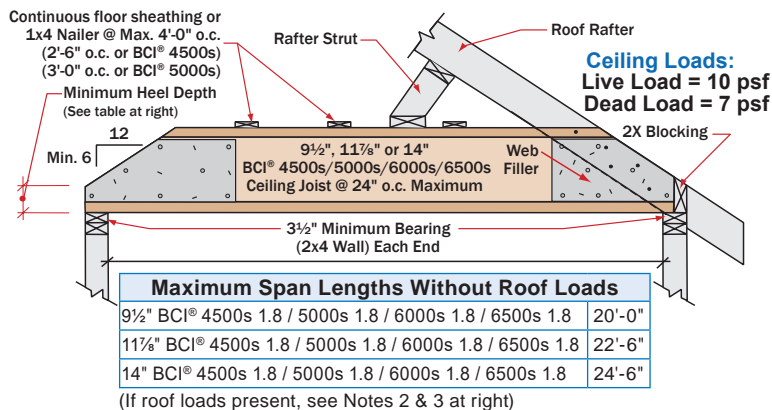

Minimum Heel Depths	Joist Depth	End Wall	
		2 x 4	2 x 6
9 1/2"	9 1/2"	2 1/2"	1 1/2"
11 7/8"	11 7/8"	3 1/2"	2 1/2"
14"	14"	4 1/2"	3 1/2"

#### Notes:

- 1) Detail is to be used only for ceiling joists with no access to attic space.
- 2) Ceiling joist must be designed to carry all roof load transferred through rafter struts as shown.
- 3) BCI® ceiling joist end reaction may not exceed 550 pounds.
- 4) Minimum roof slope is 6/12.
- 5) Nail roof rafter to BCI® top flange with 1 - 10d (3" long) box or larger nail.
- 6) 1x4 nailers must be continuous and nailed to a braced end wall.
- 7) Install a web filler on each side of BCI® Joist at beveled ends. Nail roof rafter to BCI® Joist per building code requirements for ceiling joist to roof rafter connection.

## Additional roof framing details available with BC FRAMER® software

**R01**

2x beveled plate for slope greater than 1/4/12.

Simpson VPA or USP TMP connectors or equal can be used in lieu of beveled plate for slopes from 3/12 to 12/12.

**R02**

Rimboard / VERSA-LAM® blocking. Ventilation "V" cut: 1/3 of length, 1/2 of depth

2x4 blocking for soffit support. 2'-6" max.

Flange of BCI® Joists may be birdsmouth cut only at the low end of the joist. Birds-mouth cut BCI® Joist flange must bear fully on plate, web stiffener required each side. Bottom flange shall be fully supported.

**R03**

Rimboard / VERSA-LAM® blocking. Ventilation "V" cut: 1/3 of length, 1/2 of depth

Tight fit for lateral stability. 2'-6" max.

Flange of BCI® Joists may be birdsmouth cut only at the low end of the joist. Birds-mouth cut BCI® Joist flange must bear fully on plate, web stiffener required each side.

**R04**

10d nails at 6" o.c. 2x4 one side for 135 PLF max. 2x6 one side for 240 PLF max.

Backer block. Thickness per corresponding BCI® series. 4'-0" horiz. 2'-6" horiz. 2x block. BCI® blocking. Holes cut for ventilation.

**R05**

Simpson or USP LSTA24 strap, nailing per governing building code.

VERSA-LAM® LVL support beam. BCI® blocking. Holes cut for ventilation. Double-beveled wood plate.

Blocking on both sides of ridge may be required for shear transfer per design professional of record.

**R06**

Simpson or USP LSTA24 strap where slope exceeds 7/12 (straps may be required for lower slopes in high-wind areas). Nailing per governing building code.

VERSA-LAM® LVL support beam. Beveled web stiffener on each side. Simpson LSSUI or USP TMU hanger.

**R07**

Joist Hanger. Backer block (minimum 12" wide). Nail with 10-10d nails. Filler block. Nail with 10-10d nails.

Backer block required where top flange joist hanger load exceeds 250 lbs. Install tight to top flange.

**R11**

Double joist may be required when L exceeds rafter spacing. Blocking as required. Nail outrigger through BCI® web. 2" x \_ outrigger notched around BCI® top flange. Outrigger spacing no greater than 24" on-center. End Wall. L (2'-0" max.)

**DN05**

**DO NOT** bevel-cut joist beyond inside face of wall, except for specific conditions in details shown on pages 6 and 13 of the Eastern Specifier Guide.

### LATERAL SUPPORT

- BCI® Joists must be laterally supported at end supports (including supports adjacent to overhangs) with hangers, rimboard, or blocking (VERSA-LAM®, BOISE CASCADE® Rimboard or BCI® Joist). Metal cross bracing or other x-bracing provides adequate lateral support for BCI® Joists, consult governing building code for roof diaphragm connection provisions.

### MINIMUM BEARING LENGTH FOR BCI® JOISTS

- Minimum end bearing: 1½" for all BCI® Joists. 3½" is required at cantilever and intermediate supports.
- Longer bearing lengths allow higher reaction values. Refer to the building code evaluation report or the BC CALC® software.

### NAILING REQUIREMENTS

- BCI® rim joist, rim board or closure panel to BCI® joist:
  - Rims or closure panel 1½ inches thick and less: 2-8d nails, one each in the top and bottom flange.
  - BCI® 4500s/5000s rim joist: 2-10d box nails, one each in the top and bottom flange.
  - BCI® 6000s/60s rim joist: 2-16d box nails, one each in the top and bottom flange.
  - BCI® 6500s/90s rim joist: Toe-nail top flange to rim joist with 2-10d box nails, one each side of flange.
- BCI® rim joist, rim board or BCI® blocking panel to support:
  - Min. 8d nails @ 6" o.c. per IRC.
  - Connection per design professional of record's specification for shear transfer.
- BCI® joist to support:
  - 2-8d nails, one on each side of the web, placed 1½ inches minimum from the end of the BCI® Joist to limit splitting.

- Sheathing to BCI® joist:

- Prescriptive residential floor sheathing nailing requires 8d common nails @ 6" o.c. on edges and @ 12" o.c. in the field (IRC Table R602.3(1)).
- See closest allowable nail spacing limits on page 24 for floor diaphragm nailing specified at closer spacing than IRC.
- Maximum nail spacing for minimum lateral stability: 18" for BCI® 4500s and 5000s, 24" for larger BCI® joist series.
- 14 gauge staples may be substituted for 8d nails if the staples penetrate at least 1 inch into the joist.
- Wood screws may be acceptable, contact local building official and/or Boise Cascade EWP Engineering for further information.

### BACKER AND FILLER BLOCK DIMENSIONS

Series	Backer Block Thickness	Filler Block Thickness
4500s 1.8	5/8" or 3/4" wood panels	Two 5/8" wood panels or 2 x _
5000s 1.8	3/4" or 7/8" wood panels	Two 3/4" wood panels or 2 x _
6000s 1.8	1 1/8" or two 1/2" wood panels	2 x _ + 7/16" or 1/2" wood panel
6500s 1.8	1 1/8" or two 5/8" wood panels	2 x _ + 5/8" or 3/4" wood panel
60s 2.0	1 1/8" or two 1/2" wood panels	2 x _ + 7/16" or 1/2" wood panel
90s 2.0	2 x _ lumber	Double 2 x _ lumber

- Cut backer and filler blocks to a maximum depth equal to the web depth minus ¼" to avoid a forced fit.

### WEB STIFFENER REQUIREMENTS

- See *Web Stiffener Requirements* on page 9.

### PROTECT BCI® JOISTS FROM THE WEATHER

- BCI® Joists are intended only for applications that provide permanent protection from the weather. Bundles of BCI® Joists should be covered and stored off of the ground on stickers.

### MAXIMUM SLOPE

- Unless otherwise noted, all roof details are valid for slopes of 12 in 12 or less.

### VENTILATION

- The 1½ inch, pre-stamped knock-out holes spaced at 12 inches on center along the BCI® Joist may all be knocked out and used for cross ventilation. Deeper joists that what is structurally needed may be advantageous in ventilation design. Consult local building official and/or ventilation specialist for specific ventilation requirements.

### BIRDSMOUTH CUTS

- BCI® Joists may be birdsmouth cut only at the low end support. BCI® Joists with birdsmouth cuts may cantilever up to 2'-6" past the low end support. The bottom flange must sit fully on the support and may not overhang the inside face of the support. High end supports and intermediate supports may not be birdsmouth cut.

# Roof Span Tables

Maximum clear span in feet and inches, based on horizontal spans.

115% and 125% Load Duration																								
Live Load [psf]		Dead Load [psf]		BCI® 4500s 1.8 Series 1¾" Flange Width												BCI® 5000s 1.8 Series 2" Flange Width								
				9½" BCI® 4500s 1.8			11⅞" BCI® 4500s 1.8			14" BCI® 4500s 1.8			16" BCI® 4500s 1.8			9½" BCI® 5000s 1.8			11⅞" BCI® 5000s 1.8			14" BCI® 5000s 1.8		
				4/12 or Less	4/12 to 8/12	8/12 to 12/12	4/12 or Less	4/12 to 8/12	8/12 to 12/12	4/12 or Less	4/12 to 8/12	8/12 to 12/12	4/12 or Less	4/12 to 8/12	8/12 to 12/12	4/12 or Less	4/12 to 8/12	8/12 to 12/12	4/12 or Less	4/12 to 8/12	8/12 to 12/12	4/12 or Less	4/12 to 8/12	8/12 to 12/12
12" o.c.	Non-Snow 125%	20	10	23'-10"	22'-6"	20'-10"	28'-5"	26'-9"	24'-10"	32'-3"	30'-5"	28'-3"	35'-9"	33'-8"	31'-3"	24'-10"	23'-5"	21'-9"	29'-7"	27'-11"	25'-11"	33'-8"	31'-9"	29'-5"
		20	15	122'-7"	21'-3"	19'-7"	26'-11"	25'-3"	23'-4"	30'-7"	28'-9"	26'-6"	33'-6"	31'-10"	29'-4"	23'-6"	22'-1"	20'-5"	28'-0"	26'-4"	24'-4"	31'-10"	29'-11"	27'-7"
		20	20	21'-7"	20'-2"	18'-7"	25'-8"	24'-0"	22'-1"	29'-2"	27'-4"	25'-1"	31'-4"	30'-3"	27'-10"	22'-5"	21'-0"	19'-4"	26'-9"	25'-0"	23'-0"	30'-5"	28'-5"	26'-2"
	Snow 115%	25	10	22'-8"	21'-5"	19'-11"	26'-11"	25'-6"	23'-8"	30'-2"	29'-0"	26'-11"	32'-3"	31'-7"	29'-10"	23'-7"	22'-4"	20'-9"	28'-1"	26'-7"	24'-9"	31'-11"	30'-2"	28'-1"
		25	15	21'-7"	20'-4"	18'-10"	25'-9"	24'-2"	22'-5"	28'-2"	27'-5"	25'-6"	30'-1"	29'-4"	28'-3"	22'-6"	21'-2"	19'-7"	26'-10"	25'-3"	23'-4"	30'-3"	28'-8"	26'-7"
		30	10	21'-8"	20'-6"	19'-1"	25'-9"	24'-5"	22'-9"	28'-3"	27'-9"	25'-11"	30'-2"	29'-8"	28'-8"	22'-7"	21'-4"	19'-11"	26'-10"	25'-5"	23'-9"	30'-4"	28'-11"	27'-0"
		30	15	20'-9"	19'-7"	18'-2"	24'-5"	23'-4"	21'-8"	26'-7"	25'-11"	24'-7"	28'-5"	27'-9"	26'-10"	21'-7"	20'-5"	18'-11"	25'-9"	24'-4"	22'-7"	28'-6"	27'-8"	25'-8"
		40	10	19'-8"	18'-11"	17'-10"	23'-2"	22'-6"	21'-3"	25'-3"	24'-11"	24'-2"	27'-0"	26'-8"	26'-1"	20'-6"	19'-8"	18'-7"	24'-5"	23'-5"	22'-2"	27'-2"	26'-8"	25'-2"
		40	15	19'-5"	18'-4"	17'-1"	22'-1"	21'-8"	20'-4"	24'-1"	23'-7"	22'-11"	25'-8"	25'-2"	24'-6"	20'-2"	19'-1"	17'-10"	23'-8"	22'-9"	21'-3"	25'-10"	25'-4"	24'-1"
		50	10	18'-3"	17'-6"	16'-7"	21'-2"	20'-10"	19'-9"	23'-1"	22'-10"	22'-5"	24'-8"	24'-4"	24'-0"	19'-0"	18'-3"	17'-3"	22'-8"	21'-9"	20'-7"	24'-10"	24'-6"	23'-5"
50	15	17'-11"	17'-4"	16'-3"	20'-4"	20'-0"	19'-4"	22'-2"	21'-9"	21'-3"	23'-8"	23'-3"	22'-9"	19'-0"	18'-1"	16'-11"	21'-10"	21'-5"	20'-2"	23'-9"	23'-4"	22'-10"		
16" o.c.	Non-Snow 125%	20	10	21'-7"	20'-5"	18'-11"	25'-9"	24'-3"	22'-6"	29'-3"	27'-7"	25'-7"	31'-5"	30'-7"	28'-4"	22'-6"	21'-3"	19'-8"	26'-10"	25'-4"	23'-6"	30'-6"	28'-9"	26'-8"
		20	15	20'-6"	19'-3"	17'-9"	24'-4"	22'-11"	21'-1"	27'-2"	26'-0"	24'-0"	29'-0"	28'-2"	26'-7"	21'-4"	20'-0"	18'-6"	25'-5"	23'-10"	22'-0"	28'-11"	27'-1"	25'-0"
		20	20	19'-6"	18'-3"	16'-10"	23'-3"	21'-9"	20'-0"	25'-4"	24'-5"	22'-9"	27'-1"	26'-2"	24'-11"	20'-4"	19'-0"	17'-6"	24'-3"	22'-8"	20'-10"	27'-2"	25'-10"	23'-9"
	Snow 115%	25	10	20'-6"	19'-5"	18'-1"	24'-0"	23'-1"	21'-6"	26'-1"	25'-7"	24'-5"	27'-11"	27'-4"	26'-7"	21'-4"	20'-2"	18'-10"	25'-6"	24'-1"	22'-5"	28'-1"	27'-4"	25'-6"
		25	15	19'-7"	18'-5"	17'-1"	22'-4"	21'-9"	20'-4"	24'-4"	23'-9"	22'-11"	26'-0"	25'-4"	24'-5"	20'-5"	19'-2"	17'-9"	24'-0"	22'-10"	21'-2"	26'-2"	25'-6"	24'-1"
		30	10	19'-7"	18'-7"	17'-4"	22'-5"	22'-0"	20'-7"	24'-5"	24'-0"	23'-5"	26'-1"	25'-8"	25'-0"	20'-5"	19'-4"	18'-1"	24'-1"	23'-1"	21'-6"	26'-3"	25'-9"	24'-5"
		30	15	18'-7"	17'-9"	16'-6"	21'-1"	20'-7"	19'-7"	23'-0"	22'-5"	21'-9"	24'-7"	24'-0"	23'-3"	19'-7"	18'-6"	17'-2"	22'-8"	22'-0"	20'-5"	24'-8"	24'-1"	23'-3"
		40	10	17'-8"	17'-1"	16'-2"	20'-1"	19'-9"	19'-3"	21'-10"	21'-7"	21'-1"	23'-4"	23'-0"	22'-7"	18'-7"	17'-10"	16'-10"	21'-7"	21'-3"	20'-1"	23'-6"	23'-2"	22'-8"
		40	15	16'-10"	16'-6"	15'-6"	19'-1"	18'-8"	18'-2"	20'-10"	20'-5"	19'-10"	22'-3"	21'-10"	21'-3"	18'-1"	17'-4"	16'-1"	20'-6"	20'-1"	19'-3"	22'-4"	21'-11"	21'-4"
		50	10	16'-2"	15'-10"	15'-0"	18'-4"	18'-1"	17'-9"	19'-11"	19'-9"	19'-5"	21'-4"	21'-1"	20'-9"	17'-2"	16'-6"	15'-8"	19'-8"	19'-5"	18'-8"	21'-5"	21'-2"	20'-10"
50	15	15'-6"	15'-3"	14'-8"	17'-7"	17'-3"	16'-10"	19'-2"	18'-10"	18'-5"	20'-5"	20'-1"	19'-8"	16'-8"	16'-4"	15'-4"	18'-10"	18'-6"	18'-1"	20'-7"	20'-2"	19'-9"		
19.2" o.c.	Non-Snow 125%	20	10	20'-4"	19'-2"	17'-9"	24'-2"	22'-10"	21'-2"	26'-10"	25'-11"	24'-1"	28'-8"	28'-0"	26'-8"	21'-2"	19'-11"	18'-6"	25'-2"	23'-9"	22'-1"	28'-8"	27'-0"	25'-1"
		20	15	19'-3"	18'-1"	16'-8"	22'-9"	21'-6"	19'-10"	24'-9"	24'-0"	22'-7"	26'-5"	25'-8"	24'-8"	20'-0"	18'-10"	17'-4"	23'-10"	22'-5"	20'-8"	26'-7"	25'-6"	23'-6"
		20	20	18'-4"	17'-2"	15'-9"	21'-2"	20'-5"	18'-9"	23'-1"	22'-4"	21'-3"	24'-8"	23'-10"	22'-9"	19'-1"	17'-10"	16'-5"	22'-9"	21'-4"	19'-7"	24'-10"	23'-11"	22'-3"
	Snow 115%	25	10	19'-3"	18'-3"	17'-0"	21'-10"	21'-5"	20'-2"	23'-10"	23'-4"	22'-8"	25'-6"	24'-11"	24'-3"	20'-1"	19'-0"	17'-8"	23'-6"	22'-7"	21'-1"	25'-7"	25'-1"	23'-11"
		25	15	18'-0"	17'-4"	16'-0"	20'-5"	19'-10"	19'-1"	22'-3"	21'-8"	20'-10"	23'-9"	23'-1"	22'-4"	19'-2"	18'-0"	16'-8"	21'-11"	21'-4"	19'-11"	23'-10"	23'-3"	22'-5"
		30	10	18'-0"	17'-5"	16'-3"	20'-5"	20'-1"	19'-5"	22'-3"	21'-11"	21'-4"	23'-10"	23'-5"	22'-10"	19'-2"	18'-2"	16'-11"	22'-0"	21'-7"	20'-2"	23'-11"	23'-6"	22'-11"
		30	15	16'-11"	16'-7"	15'-6"	19'-3"	18'-9"	18'-2"	20'-11"	20'-5"	19'-10"	22'-5"	21'-10"	21'-2"	18'-3"	17'-4"	16'-1"	20'-8"	20'-2"	19'-2"	22'-6"	22'-0"	21'-3"
		40	10	16'-2"	15'-11"	15'-2"	18'-3"	18'-0"	17'-8"	19'-11"	19'-8"	19'-3"	21'-4"	21'-0"	20'-7"	17'-4"	16'-9"	15'-10"	19'-8"	19'-4"	18'-10"	21'-5"	21'-1"	20'-8"
		40	15	15'-4"	15'-0"	14'-6"	17'-5"	17'-1"	16'-7"	18'-11"	18'-7"	18'-1"	20'-3"	19'-10"	19'-4"	16'-6"	16'-2"	15'-2"	18'-8"	18'-4"	17'-10"	20'-4"	20'-0"	19'-5"
		50	10	14'-9"	14'-6"	14'-1"	16'-8"	16'-6"	16'-2"	18'-2"	18'-0"	17'-8"	19'-5"	19'-3"	18'-11"	15'-10"	15'-6"	14'-8"	17'-11"	17'-9"	17'-5"	19'-7"	19'-4"	19'-0"
50	15	14'-1"	13'-10"	13'-7"	16'-0"	15'-9"	15'-4"	17'-5"	17'-2"	16'-9"	18'-8"	18'-4"	17'-11"	15'-2"	14'-11"	14'-4"	17'-2"	16'-11"	16'-6"	18'-9"	18'-5"	18'-0"		
24" o.c.	Non-Snow 125%	20	10	18'-10"	17'-9"	16'-6"	22'-0"	21'-1"	19'-7"	24'-0"	23'-5"	22'-4"	25'-7"	25'-0"	24'-3"	19'-7"	18'-6"	17'-2"	23'-4"	22'-0"	20'-5"	25'-9"	25'-0"	23'-3"
		20	15	17'-10"	16'-9"	15'-5"	20'-3"	19'-8"	18'-4"	22'-1"	21'-5"	20'-7"	23'-8"	22'-11"	22'-0"	18'-6"	17'-5"	16'-1"	21'-10"	20'-9"	19'-2"	23'-9"	23'-1"	21'-9"
		20	20	16'-8"	15'-11"	14'-7"	18'-11"	18'-3"	17'-5"	20'-8"	19'-11"	19'-0"	22'-1"	21'-3"	20'-4"	17'-8"	16'-7"	15'-3"	20'-4"	19'-8"	18'-2"	22'-2"	21'-5"	20'-5"
	Snow 115%	25	10	17'-3"	16'-10"	15'-9"	19'-6"	19'-2"	18'-7"	21'-3"	20'-10"	20'-3"	22'-9"	22'-3"	21'-8"	18'-6"	17'-7"	16'-4"	21'-0"	20'-7"	19'-6"	22'-10"	22'-5"	21'-9"
		25	15	16'-1"	15'-7"	14'-10"	18'-2"	17'-9"	17'-1"	19'-10"	19'-4"	18'-8"	21'-3"	20'-8"	19'-11"	17'-3"	16'-8"	15'-5"	19'-7"	19'-1"	18'-4"	21'-4"	20'-9"	20'-0"
		30	10	16'-1"	15'-10"	15'-1"	18'-3"	17'-11"	17'-6"	19'-11"	19'-7"	19'-1"	21'-3"	20'-11"	20'-5"	17'-4"	16'-10"	15'-8"	19'-7"	19'-3"	18'-9"	21'-5"	21'-0"	20'-6"
		30	15	15'-2"	14'-9"	14'-4"	17'-2"	16'-9"	16'-3"	18'-9"	18'-3"	17'-8"	20'-0"	19'-6"	18'-11"	16'-3"	15'-11"	14'-11"	18'-5"	18'-0"	17'-5"	20'-1"	19'-8"	19'-0"
		40	10	14'-5"	14'-2"	13'-11"	16'-4"	16'-1"	15'-9"	17'-10"	17'-7"	17'-2"	19'-0"	18'-9"	18'-5"	15'-6"	15'-3"	14'-7"	17'-7"	17'-4"	16'-11"	19'-2"	18'-10"	18'-6"
		40	15	13'-8"	13'-5"	13'-1"	15'-6"	15'-3"	14'-10"	16'-11"	16'-7"	16'-2"	18'-1"	17'-9"	17'-3"	14'-9"	14'-5"	14'-0"	16'-8"	16'-4"	15'-11"	18'-2"	17'-10"	17'-4"
		50	10	13'-2"	13'-0"	12'-9"	14'-11"	14'-9"	14'-6"	16'-3"	16'-1"	15'-9"	17'-4"	17'-2"	16'-10"	14'-2"	13'-11"	13'-7"	16'-0"	15'-10"	15'-7"	17'-5"	17'-2"	16'-7"
50	15	12'-7"	12'-4"	12'-1"	14'-3"	14'-0"	13'-9"	15'-7"	15'-4"	14'-11"	16'-6"	16'-0"	15'-3"	13'-6"	13'-4"	13'-0"	15'-4"	14'-11"	14'-3"	16'-2"	15'-8"	14'-11"		

- Table values are limited by shear, moment, total load deflection equal to L/180 and live load deflection equal to L/240. Check the local building code for other deflection limits that may apply.
- Table values represent the most restrictive of simple or multiple span applications. Analyze multiple span joists with the BC CALC® software if the length of any span is less than half the length of an adjacent span.
- Table values assume minimum bearing lengths without web stiffeners for joist depths of 16 inches and less.
- This table was designed to apply to a broad range of applications. It may be possible to exceed the limitations of this table by analyzing a specific application with the BC CALC® software.
- Slope roof joists at least ¼" over 12" to minimize ponding.
- Allowable spans and loads shall be adjusted and checked for wind load as required by local building code.

# Roof Span Tables

Maximum clear span in feet and inches, based on horizontal spans.

## 115% and 125% Load Duration

			BCI® 6000s 1.8 Series 2 <sup>5</sup> / <sub>16</sub> " Flange Width												
			9 <sup>1</sup> / <sub>2</sub> " BCI® 6000s 1.8			11 <sup>7</sup> / <sub>8</sub> " BCI® 6000s 1.8			14" BCI® 6000s 1.8			16" BCI® 6000s 1.8			
	Live Load [psf]	Dead Load [psf]	4/12 or Less	4/12 to 8/12	8/12 to 12/12	4/12 or Less	4/12 to 8/12	8/12 to 12/12	4/12 or Less	4/12 to 8/12	8/12 to 12/12	4/12 or Less	4/12 to 8/12	8/12 to 12/12	
12" o.c.	Non-Snow 125%	20	10	26'-0"	24'-6"	22'-9"	30'-11"	29'-2"	27'-0"	35'-2"	33'-2"	30'-9"	38'-10"	36'-7"	34'-0"
		20	15	24'-7"	23'-1"	21'-4"	29'-3"	27'-6"	25'-4"	33'-3"	31'-3"	28'-10"	36'-9"	34'-6"	31'-10"
		20	20	23'-6"	22'-0"	20'-2"	27'-11"	26'-1"	24'-0"	31'-9"	29'-9"	27'-4"	35'-1"	32'-10"	30'-2"
	Snow 115%	25	10	24'-8"	23'-4"	21'-8"	29'-4"	27'-9"	25'-10"	33'-4"	31'-6"	29'-4"	36'-10"	34'-10"	32'-5"
		25	15	23'-6"	22'-2"	20'-6"	28'-0"	26'-4"	24'-5"	31'-10"	29'-11"	27'-9"	34'-11"	33'-1"	30'-8"
		30	10	23'-7"	22'-4"	20'-10"	28'-0"	26'-7"	24'-9"	31'-11"	30'-2"	28'-2"	35'-1"	33'-5"	31'-2"
		30	15	22'-7"	21'-4"	19'-9"	26'-11"	25'-4"	23'-6"	30'-7"	28'-10"	26'-9"	33'-0"	31'-11"	29'-7"
		40	10	21'-5"	20'-7"	19'-5"	25'-6"	24'-6"	23'-1"	29'-0"	27'-10"	26'-3"	31'-4"	30'-9"	29'-0"
		40	15	21'-1"	20'-0"	18'-7"	25'-1"	23'-9"	22'-2"	27'-11"	27'-1"	25'-2"	29'-10"	29'-3"	27'-10"
		50	10	19'-10"	19'-1"	18'-1"	23'-7"	22'-8"	21'-6"	26'-9"	25'-9"	24'-6"	28'-8"	28'-3"	27'-1"
50	15	19'-10"	18'-11"	17'-8"	23'-7"	22'-6"	21'-0"	25'-8"	25'-3"	23'-11"	27'-5"	27'-0"	26'-5"		
16" o.c.	Non-Snow 125%	20	10	23'-6"	22'-2"	20'-7"	28'-0"	26'-5"	24'-6"	31'-10"	30'-0"	27'-10"	35'-2"	33'-2"	30'-10"
		20	15	22'-3"	20'-11"	19'-4"	26'-6"	24'-11"	23'-0"	30'-2"	28'-4"	26'-2"	33'-4"	31'-4"	28'-11"
		20	20	21'-3"	19'-11"	18'-4"	25'-3"	23'-8"	21'-9"	28'-9"	26'-11"	24'-9"	31'-5"	29'-9"	27'-5"
	Snow 115%	25	10	22'-4"	21'-1"	19'-8"	26'-7"	25'-1"	23'-5"	30'-3"	28'-7"	26'-7"	32'-5"	31'-7"	29'-5"
		25	15	21'-4"	20'-1"	18'-7"	25'-4"	23'-10"	22'-1"	28'-3"	27'-2"	25'-2"	30'-3"	29'-5"	27'-9"
		30	10	21'-4"	20'-3"	18'-10"	25'-5"	24'-1"	22'-5"	28'-4"	27'-4"	25'-6"	30'-4"	29'-9"	28'-3"
		30	15	20'-6"	19'-4"	17'-11"	24'-4"	23'-0"	21'-4"	26'-8"	26'-0"	24'-3"	28'-6"	27'-10"	26'-10"
		40	10	19'-5"	18'-7"	17'-7"	23'-1"	22'-2"	20'-11"	25'-5"	25'-0"	23'-10"	27'-2"	26'-9"	26'-2"
		40	15	19'-1"	18'-1"	16'-10"	22'-2"	21'-6"	20'-1"	24'-2"	23'-8"	22'-10"	25'-10"	25'-4"	24'-8"
		50	10	18'-0"	17'-3"	16'-4"	21'-3"	20'-6"	19'-6"	23'-2"	22'-11"	22'-2"	24'-9"	24'-6"	24'-1"
50	15	17'-11"	17'-1"	16'-0"	20'-4"	20'-0"	19'-0"	22'-2"	21'-10"	21'-4"	23'-9"	23'-4"	22'-10"		
19.2" o.c.	Non-Snow 125%	20	10	22'-1"	20'-10"	19'-4"	26'-3"	24'-10"	23'-0"	29'-11"	28'-3"	26'-2"	33'-1"	31'-2"	28'-11"
		20	15	20'-11"	19'-8"	18'-2"	24'-11"	23'-5"	21'-7"	28'-4"	26'-7"	24'-7"	30'-8"	29'-5"	27'-2"
		20	20	19'-11"	18'-8"	17'-2"	23'-9"	22'-3"	20'-5"	26'-10"	25'-4"	23'-3"	28'-8"	27'-8"	25'-9"
	Snow 115%	25	10	21'-0"	19'-10"	18'-6"	24'-11"	23'-7"	22'-0"	27'-8"	26'-10"	25'-0"	29'-7"	28'-11"	27'-8"
		25	15	20'-0"	18'-10"	17'-5"	23'-8"	22'-5"	20'-9"	25'-9"	25'-1"	23'-7"	27'-7"	26'-10"	25'-11"
		30	10	20'-1"	19'-0"	17'-9"	23'-9"	22'-7"	21'-1"	25'-10"	25'-5"	24'-0"	27'-8"	27'-2"	26'-6"
		30	15	19'-3"	18'-2"	16'-10"	22'-4"	21'-7"	20'-0"	24'-4"	23'-9"	22'-10"	26'-0"	25'-5"	24'-7"
		40	10	18'-3"	17'-6"	16'-6"	21'-3"	20'-10"	19'-8"	23'-2"	22'-10"	22'-4"	24'-9"	24'-5"	23'-11"
		40	15	17'-10"	17'-0"	15'-10"	20'-2"	19'-10"	18'-10"	22'-0"	21'-7"	21'-0"	23'-6"	23'-1"	22'-6"
		50	10	16'-10"	16'-2"	15'-4"	19'-5"	19'-2"	18'-3"	21'-1"	20'-10"	20'-6"	22'-7"	22'-4"	21'-11"
50	15	16'-4"	16'-1"	15'-0"	18'-7"	18'-3"	17'-10"	20'-3"	19'-11"	19'-5"	21'-8"	21'-3"	20'-10"		
24" o.c.	Non-Snow 125%	20	10	20'-6"	19'-4"	17'-11"	24'-4"	23'-0"	21'-4"	27'-9"	26'-2"	24'-3"	29'-9"	28'-11"	26'-10"
		20	15	19'-4"	18'-2"	16'-10"	23'-0"	21'-8"	20'-0"	25'-8"	24'-8"	22'-9"	27'-5"	26'-7"	25'-2"
		20	20	18'-6"	17'-3"	15'-11"	22'-0"	20'-7"	18'-11"	23'-11"	23'-1"	21'-7"	25'-7"	24'-9"	23'-7"
	Snow 115%	25	10	19'-5"	18'-4"	17'-1"	22'-8"	21'-10"	20'-4"	24'-8"	24'-2"	23'-2"	26'-5"	25'-10"	25'-2"
		25	15	18'-6"	17'-5"	16'-2"	21'-2"	20'-7"	19'-3"	23'-0"	22'-5"	21'-8"	24'-8"	24'-0"	23'-2"
		30	10	18'-7"	17'-7"	16'-5"	21'-2"	20'-10"	19'-6"	23'-1"	22'-8"	22'-2"	24'-9"	24'-3"	23'-8"
		30	15	17'-7"	16'-9"	15'-7"	19'-11"	19'-6"	18'-7"	21'-9"	21'-3"	20'-6"	23'-3"	22'-8"	21'-11"
		40	10	16'-9"	16'-2"	15'-3"	19'-0"	18'-8"	18'-2"	20'-8"	20'-4"	20'-0"	22'-1"	21'-9"	21'-4"
		40	15	15'-11"	15'-7"	14'-8"	18'-0"	17'-8"	17'-2"	19'-8"	19'-3"	18'-9"	21'-0"	20'-7"	19'-8"
		50	10	15'-3"	14'-11"	14'-3"	17'-4"	17'-1"	16'-10"	18'-10"	18'-8"	18'-4"	19'-10"	19'-5"	18'-9"
50	15	14'-7"	14'-4"	13'-11"	16'-7"	16'-4"	15'-11"	17'-11"	17'-4"	16'-6"	18'-3"	17'-8"	16'-10"		





Maximum clear span in feet and inches, based on horizontal spans.

		115% and 125% Load Duration														
		BCI® 6500s 1.8 Series 2 <sup>9</sup> / <sub>16</sub> " Flange Width														
		Live Load [psf]	Dead Load [psf]	9½" BCI® 6500s 1.8			11⅞" BCI® 6500s 1.8			14" BCI® 6500s 1.8			16" BCI® 6500s 1.8			
4/12 or Less	4/12 to 8/12			8/12 to 12/12	4/12 or Less	4/12 to 8/12	8/12 to 12/12	4/12 or Less	4/12 to 8/12	8/12 to 12/12	4/12 or Less	4/12 to 8/12	8/12 to 12/12			
12" o.c.	Non-Snow 125%	20	10	26'-10"	25'-3"	23'-6"	31'-10"	30'-0"	27'-10"	36'-2"	34'-1"	31'-8"	40'-0"	37'-8"	35'-0"	
		20	15	25'-5"	23'-10"	22'-0"	30'-2"	28'-4"	26'-1"	34'-3"	32'-2"	29'-8"	37'-10"	35'-7"	32'-10"	
		20	20	24'-3"	22'-8"	20'-10"	28'-9"	26'-11"	24'-9"	32'-8"	30'-7"	28'-2"	36'-1"	33'-10"	31'-1"	
	Snow 115%	25	10	25'-5"	24'-1"	22'-5"	30'-3"	28'-7"	26'-7"	34'-4"	32'-6"	30'-3"	37'-11"	35'-10"	33'-5"	
		25	15	24'-3"	22'-10"	21'-2"	28'-10"	27'-2"	25'-1"	32'-9"	30'-10"	28'-7"	36'-2"	34'-1"	31'-7"	
		30	10	24'-4"	23'-0"	21'-6"	28'-11"	27'-4"	25'-6"	32'-10"	31'-1"	29'-0"	36'-3"	34'-4"	32'-1"	
		30	15	23'-4"	22'-0"	20'-5"	27'-8"	26'-2"	24'-3"	31'-6"	29'-9"	27'-7"	34'-8"	32'-10"	30'-6"	
		40	10	22'-2"	21'-3"	20'-0"	26'-4"	25'-3"	23'-10"	29'-11"	28'-8"	27'-1"	33'-0"	31'-8"	29'-11"	
		40	15	21'-9"	20'-7"	19'-3"	25'-11"	24'-6"	22'-10"	29'-5"	27'-10"	25'-11"	31'-5"	30'-9"	28'-8"	
		50	10	20'-6"	19'-8"	18'-8"	24'-4"	23'-4"	22'-2"	27'-8"	26'-7"	25'-2"	30'-2"	29'-4"	27'-10"	
	50	15	20'-6"	19'-6"	18'-3"	24'-4"	23'-2"	21'-8"	27'-0"	26'-4"	24'-8"	28'-11"	28'-5"	27'-3"		
	16" o.c.	Non-Snow 125%	20	10	24'-4"	22'-11"	21'-3"	28'-10"	27'-2"	25'-3"	32'-10"	30'-11"	28'-8"	36'-3"	34'-2"	31'-9"
20			15	23'-0"	21'-7"	19'-11"	27'-4"	25'-8"	23'-8"	31'-1"	29'-2"	26'-11"	34'-4"	32'-3"	29'-9"	
20			20	21'-11"	20'-6"	18'-11"	26'-1"	24'-5"	22'-5"	29'-8"	27'-9"	25'-6"	32'-9"	30'-8"	28'-2"	
Snow 115%		25	10	23'-1"	21'-10"	20'-4"	27'-5"	25'-11"	24'-1"	31'-2"	29'-5"	27'-5"	34'-1"	32'-6"	30'-3"	
		25	15	22'-0"	20'-8"	19'-2"	26'-1"	24'-7"	22'-9"	29'-8"	27'-11"	25'-11"	31'-10"	30'-11"	28'-7"	
		30	10	22'-0"	20'-10"	19'-6"	26'-2"	24'-9"	23'-1"	29'-9"	28'-2"	26'-4"	31'-11"	31'-2"	29'-1"	
		30	15	21'-1"	19'-11"	18'-6"	25'-1"	23'-8"	22'-0"	28'-1"	26'-11"	25'-0"	30'-0"	29'-4"	27'-7"	
		40	10	20'-0"	19'-3"	18'-2"	23'-10"	22'-10"	21'-7"	26'-9"	26'-0"	24'-6"	28'-7"	28'-2"	27'-1"	
		40	15	19'-9"	18'-8"	17'-5"	23'-4"	22'-2"	20'-8"	25'-5"	24'-11"	23'-6"	27'-2"	26'-8"	25'-11"	
		50	10	18'-6"	17'-9"	16'-11"	22'-1"	21'-2"	20'-1"	24'-5"	24'-1"	22'-10"	26'-1"	25'-9"	25'-3"	
50		15	18'-6"	17'-8"	16'-6"	21'-5"	21'-0"	19'-8"	23'-5"	23'-0"	22'-4"	25'-0"	24'-7"	24'-0"		
19.2" o.c.		Non-Snow 125%	20	10	22'-10"	21'-6"	20'-0"	27'-1"	25'-7"	23'-9"	30'-10"	29'-1"	27'-0"	34'-0"	32'-1"	29'-10"
	20		15	21'-7"	20'-3"	18'-9"	25'-8"	24'-1"	22'-3"	29'-2"	27'-5"	25'-4"	32'-3"	30'-3"	27'-11"	
	20		20	20'-7"	19'-3"	17'-9"	24'-6"	22'-11"	21'-1"	27'-10"	26'-1"	24'-0"	30'-2"	28'-9"	26'-6"	
	Snow 115%	25	10	21'-8"	20'-6"	19'-1"	25'-9"	24'-4"	22'-8"	29'-1"	27'-8"	25'-9"	31'-1"	30'-6"	28'-5"	
		25	15	20'-8"	19'-5"	18'-0"	24'-6"	23'-1"	21'-5"	27'-2"	26'-3"	24'-4"	29'-0"	28'-3"	26'-11"	
		30	10	20'-8"	19'-7"	18'-3"	24'-7"	23'-3"	21'-9"	27'-3"	26'-6"	24'-8"	29'-1"	28'-7"	27'-4"	
		30	15	19'-10"	18'-9"	17'-5"	23'-6"	22'-3"	20'-8"	25'-7"	25'-0"	23'-6"	27'-5"	26'-9"	25'-11"	
		40	10	18'-10"	18'-1"	17'-1"	22'-4"	21'-5"	20'-3"	24'-4"	24'-0"	23'-0"	26'-1"	25'-8"	25'-2"	
		40	15	18'-6"	17'-6"	16'-4"	21'-3"	20'-10"	19'-5"	23'-2"	22'-9"	22'-1"	24'-9"	24'-4"	23'-8"	
		50	10	17'-5"	16'-8"	15'-10"	20'-5"	19'-10"	18'-10"	22'-3"	22'-0"	21'-5"	23'-9"	23'-6"	23'-1"	
	50	15	17'-3"	16'-7"	15'-6"	19'-7"	19'-3"	18'-5"	21'-4"	21'-0"	20'-6"	22'-10"	22'-2"	21'-2"		
	24" o.c.	Non-Snow 125%	20	10	21'-1"	19'-11"	18'-6"	25'-1"	23'-8"	22'-0"	28'-6"	26'-11"	25'-0"	31'-4"	29'-9"	27'-7"
20			15	20'-0"	18'-9"	17'-4"	23'-9"	22'-4"	20'-7"	27'-0"	25'-5"	23'-5"	28'-11"	28'-0"	25'-11"	
20			20	19'-1"	17'-10"	16'-5"	22'-8"	21'-3"	19'-6"	25'-3"	24'-2"	22'-2"	26'-11"	26'-0"	24'-6"	
Snow 115%		25	10	20'-0"	18'-11"	17'-8"	23'-10"	22'-6"	21'-0"	26'-0"	25'-6"	23'-10"	27'-10"	27'-3"	26'-4"	
		25	15	19'-1"	18'-0"	16'-8"	22'-3"	21'-5"	19'-10"	24'-3"	23'-7"	22'-6"	25'-11"	25'-3"	24'-4"	
		30	10	19'-2"	18'-2"	16'-11"	22'-4"	21'-7"	20'-1"	24'-4"	23'-11"	22'-11"	26'-0"	25'-7"	24'-11"	
		30	15	18'-4"	17'-4"	16'-1"	21'-0"	20'-6"	19'-1"	22'-10"	22'-4"	21'-7"	24'-5"	23'-11"	23'-1"	
		40	10	17'-5"	16'-8"	15'-9"	20'-0"	19'-8"	18'-9"	21'-9"	21'-5"	21'-0"	23'-3"	22'-11"	22'-3"	
		40	15	16'-9"	16'-2"	15'-1"	19'-0"	18'-7"	18'-0"	20'-8"	20'-4"	19'-3"	21'-7"	20'-9"	19'-8"	
		50	10	16'-1"	15'-5"	14'-8"	18'-3"	18'-0"	17'-5"	19'-6"	19'-0"	18'-5"	19'-10"	19'-5"	18'-9"	
50		15	15'-5"	15'-2"	14'-4"	17'-3"	16'-8"	15'-11"	17'-11"	17'-4"	16'-6"	18'-3"	17'-8"	16'-10"		

- Table values are limited by shear, moment, total load deflection equal to L/180 and live load deflection equal to L/240. Check the local building code for other deflection limits that may apply.
- Table values represent the most restrictive of simple or multiple span applications. Analyze multiple span joists with the BC CALC® software if the length of any span is less than half the length of an adjacent span.
- Table values assume minimum bearing lengths without web stiffeners for joist depths of 16 inches and less.
- This table was designed to apply to a broad range of applications. It may be possible to exceed the limitations of this table by analyzing a specific application with the BC CALC® software.
- Slope roof joists at least ¼" over 12" to minimize ponding.
- Allowable spans and loads shall be adjusted and checked for wind load as required by local building code.

# Roof Span Tables

Maximum clear span in feet and inches, based on horizontal spans.

## 115% and 125% Load Duration

			BCI® 60s 2.0 Series 2 <sup>5</sup> / <sub>16</sub> " Flange Width									BCI® 90s 2.0 Series 3 <sup>1</sup> / <sub>2</sub> " Flange Width									
			11 <sup>7</sup> / <sub>8</sub> " BCI® 60s 2.0			14" BCI® 60s 2.0			16" BCI® 60s 2.0			11 <sup>7</sup> / <sub>8</sub> " BCI® 90s 2.0			14" BCI® 90s 2.0			16" BCI® 90s 2.0			
			4/12 or Less	4/12 to 8/12	8/12 to 12/12	4/12 or Less	4/12 to 8/12	8/12 to 12/12	4/12 or Less	4/12 to 8/12	8/12 to 12/12	4/12 or Less	4/12 to 8/12	8/12 to 12/12	4/12 or Less	4/12 to 8/12	8/12 to 12/12	4/12 or Less	4/12 to 8/12	8/12 to 12/12	
12" o.c.	Non-Snow 125%	20	10	34'-1"	32'-2"	29'-10"	38'-9"	36'-7"	33'-11"	42'-11"	40'-6"	37'-7"	39'-0"	36'-10"	34'-2"	44'-3"	41'-9"	38'-9"	49'-0"	46'-3"	42'-11"
		20	15	32'-4"	30'-4"	28'-0"	36'-9"	34'-6"	31'-10"	40'-8"	38'-3"	35'-3"	37'-0"	34'-9"	32'-1"	41'-11"	39'-4"	36'-4"	46'-5"	43'-7"	40'-3"
		20	20	30'-10"	28'-10"	26'-6"	35'-1"	32'-10"	30'-2"	38'-10"	36'-4"	33'-5"	35'-3"	33'-0"	30'-4"	39'-11"	37'-5"	34'-5"	44'-3"	41'-5"	38'-1"
	Snow 115%	25	10	32'-5"	30'-7"	28'-6"	36'-10"	34'-10"	32'-5"	40'-10"	38'-7"	35'-11"	37'-1"	35'-0"	32'-7"	42'-0"	39'-8"	36'-11"	46'-6"	44'-0"	40'-11"
		25	15	30'-11"	29'-1"	26'-11"	35'-2"	33'-1"	30'-7"	38'-11"	36'-8"	33'-11"	35'-4"	33'-3"	30'-10"	40'-1"	37'-9"	34'-11"	44'-4"	41'-9"	38'-8"
		30	10	31'-0"	29'-4"	27'-4"	35'-3"	33'-4"	31'-1"	39'-0"	36'-11"	34'-5"	33'-7"	31'-4"	40'-2"	38'-0"	35'-6"	44'-6"	42'-1"	39'-4"	38'-4"
		30	15	29'-8"	28'-0"	26'-0"	33'-9"	31'-10"	29'-7"	37'-5"	35'-3"	32'-9"	34'-0"	32'-1"	29'-9"	38'-6"	36'-4"	33'-9"	42'-8"	40'-3"	37'-4"
		40	10	28'-2"	27'-0"	25'-6"	32'-1"	30'-9"	29'-0"	35'-6"	34'-1"	32'-2"	32'-3"	30'-11"	29'-2"	36'-6"	35'-0"	33'-1"	40'-6"	38'-10"	36'-8"
		40	15	27'-9"	26'-3"	24'-6"	31'-7"	29'-10"	27'-10"	34'-11"	33'-1"	30'-10"	31'-9"	30'-0"	28'-0"	36'-0"	34'-0"	31'-9"	39'-10"	37'-9"	35'-2"
		50	10	26'-1"	25'-0"	23'-9"	29'-8"	28'-6"	27'-0"	32'-11"	31'-6"	29'-11"	29'-10"	28'-8"	27'-2"	33'-10"	32'-5"	30'-10"	37'-6"	35'-11"	34'-2"
	50	15	26'-1"	24'-10"	23'-3"	29'-8"	28'-3"	26'-5"	32'-11"	31'-4"	29'-3"	29'-10"	28'-5"	26'-7"	33'-10"	32'-3"	30'-1"	37'-6"	35'-8"	33'-5"	
	16" o.c.	Non-Snow 125%	20	10	30'-11"	29'-2"	27'-1"	35'-2"	33'-2"	30'-9"	38'-11"	36'-8"	34'-1"	35'-4"	33'-4"	31'-0"	40'-1"	37'-10"	35'-1"	44'-5"	41'-11"
20			15	29'-3"	27'-6"	25'-5"	33'-4"	31'-3"	28'-10"	36'-11"	34'-8"	32'-0"	33'-6"	31'-6"	29'-1"	37'-11"	35'-8"	32'-11"	42'-0"	39'-6"	36'-6"
20			20	27'-11"	26'-2"	24'-1"	31'-9"	29'-9"	27'-4"	35'-2"	32'-11"	30'-4"	31'-11"	29'-11"	27'-6"	36'-2"	33'-11"	31'-2"	40'-1"	37'-7"	34'-7"
Snow 115%		25	10	29'-4"	27'-9"	25'-10"	33'-5"	31'-7"	29'-5"	37'-0"	34'-11"	32'-7"	33'-7"	31'-9"	29'-7"	38'-1"	36'-0"	33'-6"	42'-2"	39'-10"	37'-1"
		25	15	28'-0"	26'-4"	24'-5"	31'-10"	30'-0"	27'-9"	35'-3"	33'-2"	30'-9"	32'-0"	30'-2"	27'-11"	36'-3"	34'-2"	31'-8"	40'-2"	37'-10"	35'-8"
		30	10	28'-1"	26'-7"	24'-10"	31'-11"	30'-3"	28'-2"	35'-4"	33'-6"	31'-3"	32'-1"	30'-5"	28'-4"	36'-4"	34'-5"	32'-2"	40'-3"	38'-2"	35'-8"
		30	15	26'-11"	25'-5"	23'-7"	30'-7"	28'-10"	26'-10"	33'-11"	32'-0"	29'-8"	30'-9"	29'-0"	27'-0"	34'-10"	32'-11"	30'-7"	38'-7"	36'-5"	33'-10"
		40	10	25'-6"	24'-6"	23'-1"	29'-0"	27'-10"	26'-4"	32'-2"	30'-10"	29'-2"	29'-2"	28'-0"	26'-5"	33'-1"	31'-9"	30'-0"	36'-8"	35'-2"	33'-3"
		40	15	25'-1"	23'-9"	22'-2"	28'-7"	27'-1"	25'-3"	31'-8"	30'-0"	27'-11"	28'-9"	27'-2"	25'-4"	32'-7"	30'-10"	28'-9"	36'-1"	34'-2"	31'-10"
		50	10	23'-7"	22'-8"	21'-6"	26'-10"	25'-9"	24'-6"	29'-9"	28'-7"	27'-1"	27'-0"	25'-11"	24'-7"	30'-7"	29'-5"	27'-11"	33'-11"	32'-7"	30'-11"
50		15	23'-7"	22'-6"	21'-0"	26'-10"	25'-7"	23'-11"	28'-7"	27'-8"	26'-5"	27'-0"	25'-9"	24'-1"	30'-7"	29'-2"	27'-3"	33'-11"	32'-4"	30'-3"	
19.2" o.c.		Non-Snow 125%	20	10	29'-1"	27'-5"	25'-5"	33'-0"	31'-2"	28'-11"	36'-7"	34'-6"	32'-0"	33'-3"	31'-4"	29'-1"	37'-8"	35'-6"	33'-0"	41'-8"	39'-4"
	20		15	27'-6"	25'-10"	23'-10"	31'-3"	29'-5"	27'-1"	34'-8"	32'-7"	30'-1"	31'-5"	29'-7"	27'-3"	35'-8"	33'-6"	30'-11"	39'-6"	37'-1"	34'-3"
	20		20	26'-3"	24'-7"	22'-7"	29'-10"	27'-11"	25'-8"	33'-0"	30'-11"	28'-6"	30'-0"	28'-1"	25'-10"	34'-0"	31'-10"	29'-3"	37'-8"	35'-3"	32'-5"
	Snow 115%	25	10	27'-7"	26'-1"	24'-3"	31'-4"	29'-8"	27'-7"	34'-9"	32'-10"	30'-7"	31'-6"	29'-10"	27'-9"	35'-9"	33'-10"	31'-6"	39'-7"	37'-5"	34'-11"
		25	15	26'-3"	24'-9"	22'-11"	29'-11"	28'-2"	26'-1"	33'-11"	31'-2"	28'-11"	30'-1"	28'-4"	26'-3"	34'-1"	32'-1"	29'-9"	37'-9"	35'-7"	32'-11"
		30	10	26'-4"	25'-0"	23'-4"	30'-0"	28'-5"	26'-6"	33'-2"	31'-5"	29'-4"	30'-1"	28'-7"	26'-8"	34'-2"	32'-4"	30'-2"	37'-10"	35'-10"	33'-6"
		30	15	25'-3"	23'-10"	22'-2"	28'-9"	27'-1"	25'-2"	31'-10"	30'-0"	27'-11"	28'-10"	27'-3"	25'-4"	32'-9"	30'-11"	28'-8"	36'-3"	34'-3"	31'-10"
		40	10	24'-0"	23'-0"	21'-9"	27'-3"	26'-2"	24'-8"	30'-2"	29'-0"	27'-4"	27'-5"	26'-3"	24'-10"	31'-0"	29'-10"	28'-2"	34'-5"	33'-0"	31'-2"
		40	15	23'-7"	22'-4"	20'-10"	26'-10"	25'-5"	23'-8"	28'-1"	27'-0"	25'-7"	26'-11"	25'-6"	23'-10"	30'-7"	28'-11"	27'-0"	33'-10"	32'-1"	29'-11"
		50	10	22'-2"	21'-3"	20'-3"	25'-3"	24'-2"	23'-0"	25'-10"	25'-3"	24'-5"	25'-4"	24'-4"	23'-1"	28'-8"	27'-7"	26'-2"	31'-10"	30'-7"	29'-11"
	50	15	22'-2"	21'-2"	19'-9"	23'-9"	23'-0"	21'-11"	23'-9"	23'-0"	21'-11"	25'-4"	24'-2"	22'-7"	28'-8"	27'-5"	25'-7"	29'-8"	28'-8"	27'-5"	
	24" o.c.	Non-Snow 125%	20	10	26'-11"	25'-5"	23'-7"	30'-7"	28'-10"	26'-10"	33'-11"	32'-0"	29'-8"	30'-9"	29'-0"	27'-0"	34'-10"	32'-11"	30'-7"	38'-7"	36'-5"
20			15	25'-6"	23'-11"	22'-1"	28'-11"	27'-2"	25'-2"	32'-1"	30'-2"	27'-10"	29'-1"	27'-4"	25'-3"	33'-0"	31'-0"	28'-8"	36'-7"	34'-4"	31'-9"
20			20	24'-3"	22'-9"	20'-11"	27'-7"	25'-10"	23'-10"	30'-7"	28'-8"	26'-4"	27'-9"	26'-0"	23'-11"	31'-5"	29'-6"	27'-1"	34'-10"	32'-8"	30'-1"
Snow 115%		25	10	25'-6"	24'-2"	22'-6"	29'-0"	27'-6"	25'-7"	32'-2"	30'-5"	28'-4"	29'-2"	27'-7"	25'-9"	33'-1"	31'-4"	29'-2"	36'-8"	34'-8"	32'-4"
		25	15	24'-4"	22'-11"	21'-3"	27'-8"	26'-1"	24'-2"	30'-8"	28'-11"	26'-9"	27'-10"	26'-3"	24'-4"	31'-6"	29'-9"	27'-6"	34'-11"	32'-11"	30'-6"
		30	10	24'-5"	23'-1"	21'-7"	27'-9"	26'-3"	24'-6"	30'-9"	29'-1"	27'-2"	27'-11"	26'-5"	24'-8"	31'-7"	29'-11"	28'-0"	35'-0"	33'-2"	31'-0"
		30	15	23'-4"	22'-1"	20'-6"	26'-7"	25'-1"	23'-4"	27'-4"	26'-1"	24'-5"	26'-9"	25'-3"	23'-5"	30'-3"	28'-7"	26'-7"	33'-7"	31'-8"	29'-5"
		40	10	22'-2"	21'-3"	20'-1"	24'-9"	24'-1"	22'-10"	24'-9"	24'-1"	23'-1"	25'-4"	24'-4"	23'-0"	28'-8"	27'-7"	26'-1"	30'-11"	30'-0"	28'-10"
		40	15	21'-10"	20'-8"	19'-3"	22'-5"	21'-6"	20'-5"	22'-5"	21'-6"	20'-5"	24'-11"	23'-7"	22'-0"	27'-9"	26'-8"	25'-0"	28'-0"	26'-11"	25'-6"
		50	10	20'-6"	19'-8"	18'-9"	20'-8"	20'-2"	19'-6"	20'-8"	20'-2"	19'-6"	23'-5"	22'-6"	21'-5"	25'-7"	24'-11"	24'-1"	25'-9"	25'-2"	24'-4"
50		15	19'-0"	18'-4"	17'-6"	19'-0"	18'-4"	17'-6"	19'-0"	18'-4"	17'-6"	23'-4"	22'-4"	20'-11"	23'-6"	22'-9"	21'-8"	23'-8"	22'-11"	21'-10"	

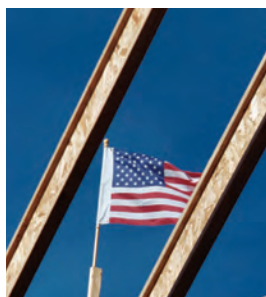

## Allowable Uniform Roof Load (in pounds per lineal foot [PLF])

### 115% and 125% Load Duration

Use of these tables should be limited to roof slopes of 3½" per foot or less.  
For steeper slopes, see pages 15-18.

Span Length	BCI® 4500s 1.8 Series 1¾" Flange Width											
	9½" BCI® 4500s 1.8			11⅞" BCI® 4500s 1.8			14" BCI® 4500s 1.8			16" BCI® 4500s 1.8		
	Total Load		Deflect.	Total Load		Deflect.	Total Load		Deflect.	Total Load		Deflect.
	Snow (115%)	Non-Snow (125%)	L/240	Snow (115%)	Non-Snow (125%)	L/240	Snow (115%)	Non-Snow (125%)	L/240	Snow (115%)	Non-Snow (125%)	L/240
6	315	343	-	338	367	-	353	383	-	356	387	-
7	270	294	-	289	315	-	302	329	-	305	332	-
8	236	257	-	253	275	-	264	287	-	267	290	-
9	210	228	-	225	245	-	235	255	-	237	258	-
10	189	205	-	202	220	-	211	230	-	214	232	-
11	172	187	-	184	200	-	192	209	-	194	211	-
12	147	160	-	169	183	-	176	191	-	178	193	-
13	125	136	-	156	169	-	162	177	-	164	179	-
14	108	118	107	139	151	-	151	164	-	152	166	-
15	94	102	88	121	131	-	141	153	-	142	155	-
16	83	90	73	106	115	-	126	137	-	133	145	-
17	73	80	61	94	102	-	111	121	-	125	136	-
18	65	67	51	84	91	-	99	108	-	113	123	-
19	58	58	44	75	82	73	89	97	-	102	111	-
20	49	49	38	68	74	63	80	87	-	92	100	-
21	43	43	33	61	67	54	73	79	-	83	90	-
22				56	61	47	66	72	-	76	82	-
23				51	54	42	61	66	-	69	75	-
24				47	48	37	56	60	54	64	69	-
25				43	43	32	51	56	48	59	64	-
26							47	51	42	54	59	-
27							44	48	38	50	54	-
28							41	44	34	47	51	46
29										43	47	41
30										40	44	37

- Total Load values are limited by shear, moment, or deflection equal to L/180.
- Deflection values (Deflect.) are limited by live load deflection equal to L/240. Check the local building code for other deflection limits that may apply.
- Both the Total Load and Deflection columns must be checked. Where a Deflection value is not shown, the Total Load value will control.
- Table values apply to either simple or multiple span joists. Span is measured center to center of the minimum required bearing length. Analyze multiple span joists with the BC CALC® software if the length of any span is less than half the length of an adjacent span.
- Slope roof joists at least ¼ inch over 12 inches to minimize ponding.
- Table values assume minimum bearing lengths without web stiffeners for joist depths of 16 inches and less.
- This table was designed to apply to a broad range of applications. It may be possible to exceed the limitations of this table by analyzing a specific application with the BC CALC® software.
- Allowable spans and loads shall be adjusted and checked for wind load as required by local building code.

# Roof Load Tables

## Allowable Uniform Roof Load (in pounds per lineal foot [PLF])

### 115% and 125% Load Duration

Use of these tables should be limited to roof slopes of 3½" per foot or less.  
For steeper slopes, see pages 15-18.

Span Length	BCI® 5000s 1.8 Series 2" Flange Width								
	9½" BCI® 5000s 1.8			11⅞" BCI® 5000s 1.8			14" BCI® 5000s 1.8		
	Total Load		Deflect.	Total Load		Deflect.	Total Load		Deflect.
	Snow (115%)	Non-Snow (125%)	L/240	Snow (115%)	Non-Snow (125%)	L/240	Snow (115%)	Non-Snow (125%)	L/240
6	315	343	-	338	367	-	353	383	-
7	270	294	-	289	315	-	302	329	-
8	236	257	-	253	275	-	264	287	-
9	210	228	-	225	245	-	235	255	-
10	189	205	-	202	220	-	211	230	-
11	172	187	-	184	200	-	192	209	-
12	157	171	-	169	183	-	176	191	-
13	145	158	-	156	169	-	162	177	-
14	125	136	120	144	157	-	151	164	-
15	109	118	98	135	147	-	141	153	-
16	95	104	81	122	133	-	132	143	-
17	85	89	68	108	118	-	124	135	-
18	75	76	58	96	105	-	114	124	-
19	65	65	49	87	94	82	103	112	-
20	56	56	42	78	85	71	93	101	-
21	48	48	37	71	77	61	84	91	-
22	42	42	32	64	70	54	76	83	-
23				59	62	47	70	76	68
24				54	54	41	64	70	60
25				48	48	37	59	64	54
26				43	43	33	55	59	48
27							51	55	43
28							47	50	38



## Allowable Uniform Roof Load (in pounds per lineal foot [PLF])

### 115% and 125% Load Duration

Use of these tables should be limited to roof slopes of 3½" per foot or less.  
For steeper slopes, see pages 15-18.

Span Length	BCI® 6000s 1.8 Series 2 <sup>5</sup> / <sub>16</sub> " Flange Width											
	9½" BCI® 6000s 1.8			11⅞" BCI® 6000s 1.8			14" BCI® 6000s 1.8			16" BCI® 6000s 1.8		
	Total Load		Deflect.	Total Load		Deflect.	Total Load		Deflect.	Total Load		Deflect.
	Snow (115%)	Non-Snow (125%)	L/240	Snow (115%)	Non-Snow (125%)	L/240	Snow (115%)	Non-Snow (125%)	L/240	Snow (115%)	Non-Snow (125%)	L/240
6	360	392	-	375	408	-	390	424	-	398	432	-
7	309	336	-	322	350	-	334	364	-	341	371	-
8	270	294	-	281	306	-	293	318	-	298	324	-
9	240	261	-	250	272	-	260	283	-	265	288	-
10	216	235	-	225	245	-	234	254	-	238	259	-
11	196	213	-	204	222	-	213	231	-	217	236	-
12	180	196	-	187	204	-	195	212	-	199	216	-
13	166	180	-	173	188	-	180	196	-	183	199	-
14	145	158	135	161	175	-	167	182	-	170	185	-
15	126	137	111	150	163	-	156	169	-	159	173	-
16	111	121	92	140	153	-	146	159	-	149	162	-
17	98	101	78	126	137	-	137	149	-	140	152	-
18	86	86	66	112	122	108	130	141	-	132	144	-
19	74	74	56	101	110	92	120	130	-	125	136	-
20	63	63	48	91	99	80	108	117	-	119	129	-
21	55	55	42	83	90	69	98	107	-	112	122	-
22	48	48	36	75	79	60	89	97	88	102	111	-
23	42	42	32	69	70	53	82	89	78	93	101	-
24				61	61	47	75	81	68	86	93	-
25				54	54	42	69	75	61	79	86	-
26				49	49	37	64	69	54	73	79	-
27				43	43	33	59	63	48	67	73	65
28							55	57	44	63	68	58

- Total Load values are limited by shear, moment, or deflection equal to L/180.
- Deflection values (Deflect.) are limited by live load deflection equal to L/240. Check the local building code for other deflection limits that may apply.
- Both the Total Load and Deflection columns must be checked. Where a Deflection value is not shown, the Total Load value will control.
- Table values apply to either simple or multiple span joists. Span is measured center to center of the minimum required bearing length. Analyze multiple span joists with the BC CALC® software if the length of any span is less than half the length of an adjacent span.
- Slope roof joists at least ¼ inch over 12 inches to minimize ponding.
- Table values assume minimum bearing lengths without web stiffeners for joist depths of 16 inches and less.
- This table was designed to apply to a broad range of applications. It may be possible to exceed the limitations of this table by analyzing a specific application with the BC CALC® software.
- Allowable spans and loads shall be adjusted and checked for wind load as required by local building code.

## Allowable Uniform Roof Load (in pounds per lineal foot [PLF])

### 115% and 125% Load Duration

Use of these tables should be limited to roof slopes of 3½" per foot or less.  
For steeper slopes, see pages 15-18.

BCI® 6500s 1.8 Series 2 <sup>9</sup> / <sub>16</sub> " Flange Width												
Span Length	9½" BCI® 6500s 1.8			11⅞" BCI® 6500s 1.8			14" BCI® 6500s 1.8			16" BCI® 6500s 1.8		
	Total Load		Deflect.	Total Load		Deflect.	Total Load		Deflect.	Total Load		Deflect.
	Snow (115%)	Non-Snow (125%)	L/240	Snow (115%)	Non-Snow (125%)	L/240	Snow (115%)	Non-Snow (125%)	L/240	Snow (115%)	Non-Snow (125%)	L/240
	6	360	392	-	375	408	-	390	424	-	398	432
7	309	336	-	322	350	-	334	364	-	341	371	-
8	270	294	-	281	306	-	293	318	-	298	324	-
9	240	261	-	250	272	-	260	283	-	265	288	-
10	216	235	-	225	245	-	234	254	-	238	259	-
11	196	213	-	204	222	-	213	231	-	217	236	-
12	180	196	-	187	204	-	195	212	-	199	216	-
13	166	180	-	173	188	-	180	196	-	183	199	-
14	154	168	147	161	175	-	167	182	-	170	185	-
15	140	152	121	150	163	-	156	169	-	159	173	-
16	123	132	101	140	153	-	146	159	-	149	162	-
17	109	111	85	132	144	-	137	149	-	140	152	-
18	94	94	72	125	135	118	130	141	-	132	144	-
19	80	80	61	112	122	101	123	134	-	125	136	-
20	69	69	53	101	110	87	117	127	-	119	129	-
21	60	60	46	91	99	76	108	118	-	113	123	-
22	52	52	40	83	87	66	99	107	96	108	118	-
23	46	46	35	76	76	58	90	98	84	103	112	-
24	41	41	31	67	67	51	83	90	74	95	103	-
25				60	60	45	76	83	66	87	95	-
26				53	53	40	71	77	59	81	88	79
27				47	47	36	65	69	53	75	81	71
28				43	43	32	61	62	47	69	76	63
29							56	56	43	65	70	57
30							51	51	39	60	66	52
31							46	46	35	57	62	47
32							42	42	32	53	56	43
33										50	51	39
34										47	47	36
35										43	43	33



## Allowable Uniform Roof Load (in pounds per lineal foot [PLF])

### 115% and 125% Load Duration

Use of these tables should be limited to roof slopes of 3½" per foot or less.  
For steeper slopes, see pages 15-18.

Span Length	BCI® 60s 2.0 Series 2 <sup>5</sup> / <sub>16</sub> " Flange Width									BCI® 90s 2.0 Series 3½" Flange Width								
	11⅞" BCI® 60s 2.0			14" BCI® 60s 2.0			16" BCI® 60s 2.0			11⅞" BCI® 90s 2.0			14" BCI® 90s 2.0			16" BCI® 90s 2.0		
	Total Load		Deflect.	Total Load		Deflect.	Total Load		Deflect.	Total Load		Deflect.	Total Load		Deflect.	Total Load		Deflect.
	Snow (115%)	Non-Snow (125%)	L/240	Snow (115%)	Non-Snow (125%)	L/240	Snow (115%)	Non-Snow (125%)	L/240	Snow (115%)	Non-Snow (125%)	L/240	Snow (115%)	Non-Snow (125%)	L/240	Snow (115%)	Non-Snow (125%)	L/240
6	413	449	-	413	449	-	413	449	-	507	551	-	510	555	-	514	559	-
7	354	385	-	354	385	-	354	385	-	434	472	-	437	476	-	441	479	-
8	309	336	-	309	336	-	309	336	-	380	413	-	383	416	-	385	419	-
9	275	299	-	275	299	-	275	299	-	338	367	-	340	370	-	343	372	-
10	247	269	-	247	269	-	247	269	-	304	330	-	306	333	-	308	335	-
11	225	245	-	225	245	-	225	245	-	276	300	-	278	302	-	280	305	-
12	206	224	-	206	224	-	206	224	-	253	275	-	255	277	-	257	279	-
13	190	207	-	190	207	-	190	207	-	234	254	-	235	256	-	237	258	-
14	177	192	-	177	192	-	177	192	-	217	236	-	218	238	-	220	239	-
15	165	179	-	165	179	-	165	179	-	202	220	-	204	222	-	205	223	-
16	154	168	-	154	168	-	154	168	-	190	206	-	191	208	-	192	209	-
17	145	158	-	145	158	-	145	158	-	178	194	-	180	196	-	181	197	-
18	137	149	-	137	149	-	137	149	-	169	183	-	170	185	-	171	186	-
19	130	141	123	130	141	-	130	141	-	160	174	-	161	175	-	162	176	-
20	123	134	106	123	134	-	123	134	-	152	165	-	153	166	-	154	167	-
21	118	121	92	118	128	-	118	128	-	144	157	134	145	158	-	147	159	-
22	106	106	81	112	122	-	112	122	-	138	150	118	139	151	-	140	152	-
23	93	93	71	107	117	103	107	117	-	132	136	104	133	144	-	134	145	-
24	82	82	63	103	112	91	103	112	-	120	120	92	127	138	-	128	139	-
25	73	73	56	99	106	81	99	107	-	107	107	82	122	133	117	123	134	-
26	65	65	50	94	94	72	95	103	-	96	96	73	117	128	104	118	129	-
27	58	58	44	85	85	65	91	99	87	86	86	65	113	123	94	114	124	-
28	52	52	40	76	76	58	88	96	78	77	77	59	109	110	84	110	119	-
29	47	47	36	69	69	52	85	92	71	70	70	53	100	100	76	106	115	102
30	43	43	32	62	62	47	82	84	64	63	63	48	91	91	69	102	111	93
31				56	56	43	76	76	58	57	57	44	82	82	63	99	108	85
32				51	51	39	69	69	53	52	52	40	75	75	57	96	101	77
33				47	47	36	63	63	48	48	48	36	69	69	52	92	92	71
34				43	43	33	58	58	44	44	44	33	63	63	48	85	85	65
35							53	53	41	40	40	31	58	58	44	78	78	59

- Total Load values are limited by shear, moment, or deflection equal to L/180.
- Deflection values (Deflect.) are limited by live load deflection equal to L/240. Check the local building code for other deflection limits that may apply.
- Both the Total Load and Deflection columns must be checked. Where a Deflection value is not shown, the Total Load value will control.
- Table values apply to either simple or multiple span joists. Span is measured center to center of the minimum required bearing length. Analyze multiple span joists with the BC CALC® software if the length of any span is less than half the length of an adjacent span.
- Slope roof joists at least ¼ inch over 12 inches to minimize ponding.
- Table values assume minimum bearing lengths without web stiffeners for joist depths of 16 inches and less.
- This table was designed to apply to a broad range of applications. It may be possible to exceed the limitations of this table by analyzing a specific application with the BC CALC® software.
- Allowable spans and loads shall be adjusted and checked for wind load as required by local building code.

BCI® Joist Series	Depth [inches]	Weight [plf]	Moment [ft-lbs]	EI x 10 <sup>6</sup> [lb-in <sup>2</sup> ]	K x 10 <sup>6</sup> [lbs]	Shear [lbs]	End Reaction [lbs]				Intermediate Reaction [lbs]			
							1½" Bearing		3½" Bearing		3½" Bearing		5¼" Bearing	
							No WS <sup>(1)</sup>	WS <sup>(2)</sup>	No WS <sup>(1)</sup>	WS <sup>(2)</sup>	No WS <sup>(1)</sup>	WS <sup>(2)</sup>	No WS <sup>(1)</sup>	WS <sup>(2)</sup>
4500s 1.8	9½	2.1	2360	155	5	1475	950	1125	1125	1275	2100	2350	2525	2750
	11⅝	2.4	3025	260	6	1625	950	1425	1425	1475	2250	2850	2525	3000
	14	2.7	3585	380	8	1825	950	1525	1450	1725	2350	3050	2525	3200
	16	3.0	4090	515	9	1975	950	1625	1475	1975	2400	3200	2525	3350
5000s 1.8	9½	2.3	2725	175	5	1475	950	1125	1125	1275	2100	2350	2525	2750
	11⅝	2.6	3485	295	6	1625	950	1425	1425	1475	2250	2850	2525	3000
	14	2.9	4130	430	8	1825	950	1525	1475	1725	2350	3050	2525	3200
	16	3.1	4715	580	9	1975	950	1625	1500	1975	2400	3200	2525	3350
6000s 1.8	9½	2.5	3165	200	5	1575	1175	1375	1375	1425	2400	2650	2700	2750
	11⅝	2.8	4060	335	6	1675	1175	1425	1425	1475	2500	2850	2900	3000
	14	3.1	4815	490	8	1925	1175	1525	1525	1725	2600	3150	2925	3200
	16	3.3	5495	660	9	2175	1175	1625	1550	1975	2650	3350	2950	3350
6500s 1.8	9½	2.7	3505	220	5	1575	1175	1375	1375	1425	2400	2650	2700	2750
	11⅝	3.0	4495	365	7	1675	1175	1425	1425	1475	2500	2850	2900	3000
	14	3.3	5330	535	8	1925	1175	1525	1525	1725	2600	3150	2925	3200
	16	3.5	6085	720	9	2175	1175	1625	1550	1975	2650	3350	2950	3350
60s 2.0	11⅝	3.2	6235	450	7	1675	1175	1425	1425	1475	2750	2850	3200	3250
	14	3.5	7440	660	8	1925	1175	1525	1525	1725	2750	3450	3200	3650
	16	3.8	8520	895	9	2175	1175	1625	1550	1975	2750	3650	3200	3750
90s 2.0	11⅝	4.3	9550	675	7	2150	1425	1850	1800	1950	3375	3700	4000	4350
	14	4.6	11390	980	8	2350	1450	1950	1850	2150	3400	3850	4100	4450
	16	4.9	13050	1330	9	2550	1475	2150	1900	2350	3425	4000	4200	4650

**NOTES:**

- (1) No web stiffeners required.
- (2) Web stiffeners required.
- Moment, shear and reaction values based upon a load duration of 100% and may be adjusted for other load durations.
- Design values listed are applicable for Allowable Stress Design (ASD).
- No additional repetitive member increase allowed.

$$\Delta = \frac{5wl^4}{384EI} + \frac{wl^2}{K}$$

$\Delta$  = deflection [in]  
 $w$  = uniform load [lb/in]  
 $l$  = clear span [in]  
 $EI$  = bending stiffness [lb-in<sup>2</sup>]  
 $K$  = shear deformation coefficient [lb]

**BUILDING CODE EVALUATION REPORT**

- ICC ESR 1336 (IBC, IRC)

## BCI® Closest Allowable Nail Spacing

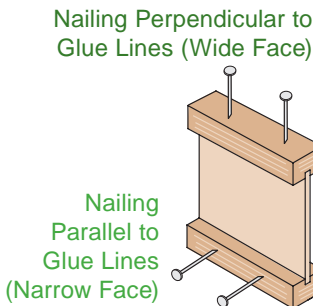

Nail Size	All BCI® Joists			
	Nailing Perpendicular to Glue Line (Wide Face)		Nailing Parallel to Glue Line (Narrow Face)	
	O.C. Spacing [inches]	End of Joist [inches]	O.C. Spacing [inches]	End of Joist [inches]
8d Box (0.113"ø x 2.5")	2	1½	4	1½
8d Common (0.131"ø x 2.5")	2	1½	4	3
10d & 12d Box (0.128"ø x 3", 3.25")	2	1½	4	3
16d Box (0.135"ø x 3.5")	2	1½	4	3
10d & 12d Common & 16d Sinker (0.148"ø x 3", 3.25")	3	2	6	4
16d Common (0.162"ø x 3.5")	3	2	6	4

- If more than one row of nails is used, the rows must be offset at least ½ inch.
- Simpson Strong-Tie A35 connectors may be attached to the side of BCI® 60s & 90s joist flanges only. Use nails as specified by Simpson Strong-Tie; do not attach connectors on both sides of a flange at the same location.

**BCI® Diaphragm Table (1)**

BCI® Series	Diaphragm Capacity <sup>(2) (3)</sup> [lb/ft]	
	Unblocked	Blocked
4500s, 5000s	As permitted for 2x framing in building code	320 lb/ft for 6" o.c. nailing @ panel edges 425 lb/ft for 4" o.c. nailing, staggered, @ panel edges
6000s, 6500s	As permitted for 3x framing in building code	360 lb/ft for 6" o.c. nailing @ panel edges 480 lb/ft for 4" o.c. nailing, staggered @ panel edges
60s, 90s	As permitted for 3x framing in building code	As permitted for 3x framing in building code with nail spacing no closer than 3" o.c.

**NOTES:**

- (1) See table 6 of ICC ESR 1336.
- (2) BCI joists may be substituted for solid sawn framing in horizontal wood diaphragms as shown in Table 2306.3.1 of the IBC or Table 23-II-H of the UBC.
- (3) Diaphragm nailing shall not exceed BCI closest allowable nail spacing limits.



## Boise Cascade Rimboard Product Profiles

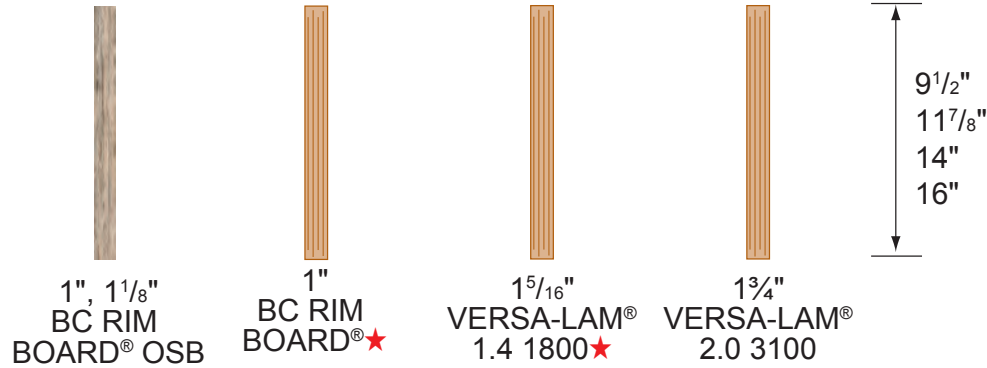

★Product may not be available. Check with supplier or Boise Cascade representative for availability.

**F07 Perpendicular**

See chart for vertical load capacity.

Min. 8d nails at 6" o.c. per IRC. Connection per design professional of record's specification for shear transfer.

**F07A Parallel**

See chart for vertical load capacity.

Min. 8d nails at 6" o.c. per IRC. Connection per design professional of record's specification for shear transfer.

**F56**

Exterior Wall Sheathing Max. 1 5/32" thickness

BCI®/AJS® Joists Perpendicular or parallel to rim

BOISE CASCADE® Rimboard

Deck Joist Length	Connection
12'-0" & less	2 rows 1/2" bolt or lag screw, 24" o.c. (300 plf max.)
12'-1" – 18'-0"	2 rows 1/2" bolt or lag screw, 16" o.c. (450 plf max.)

**Note:** For snow loads greater than 40 psf, and/or dead loads greater than 10 psf, size connection per max plf values shown above.

**Treated Ledger -** Use only fasteners that are approved for use with corresponding wood treatment.

**Notes:**

- Design of moisture control by others (only structural components shown above).
- For information on deck lateral load connections to meet the 2009/2012 IRC, contact Boise Cascade EWP Engineering.
- For use of proprietary screws to attach ledger, consult screw manufacturer literature.
- For further information on residential deck design, see AWC DCA 6, *Prescriptive Residential Wood Deck Construction Guide*.

## Boise Cascade Rimboard Properties

Product	Vertical Load Capacity		Maximum Floor Diaphragm Lateral Capacity [lb/ft]	Allowable Design Values			
	Uniform [plf]	Point [lb]		Flexural Stress [lb/in <sup>2</sup> ]	Modulus of Elasticity [lb/in <sup>2</sup> ]	Horizontal Shear [lb/in <sup>2</sup> ]	Compression Perpendicular to Grain [lb/in <sup>2</sup> ]
1" BC RIM BOARD® (2) 1" BC RIM BOARD® OSB (2)	3300	3500	180	Limited span capabilities, see note 2			
1 1/8" BC RIM BOARD® OSB (2)	4400	3500	180	Limited span capabilities, see note 2			
1 5/16" VERSA-LAM® 1.4 1800 (1)	6000	4450	Permitted per building code for all nominal 2" thick framing floor diaphragms	1800	1,400,000	225	525
1 3/4" VERSA-LAM® 2.0 3100 (1)	5700	4300	Permitted per building code for all nominal 2" thick framing floor diaphragms	3100	2,000,000	285	750

Closest Allowable Nail Spacing - Narrow Face [in]	Product			
	1" BC RIM BOARD® (2) 1" BC RIM BOARD® OSB (2)	1 1/8" BC RIM BOARD® OSB (2)	1 5/16" VERSA-LAM® 1.4 1800 (1)	1 3/4" VERSA-LAM® 2.0 3100 (1)
8d Box (0.113"Ø x 2.5")	3	3	3	3
8d Common (0.131"Ø x 2.5")	3	3	3	3
10d & 12d Box (0.128"Ø x 3", 3.25")	See publication in note 2 for further nailing information.		3	3
16d Box (0.135"Ø x 3.5")			3	3
10d & 12d Common & 16d Sinker (0.148"Ø x 3", 3.25")			4	4
16d Common (0.162"Ø x 3.5")			6	6

- Notes**
- See ICC ESR 1040 for further product information.
  - See *Performance Rated Rim Boards, APA EWS #W345K* for further product information.

## An Introduction to VERSA-LAM® Products



When you specify VERSA-LAM® laminated veneer headers/beams, you are building quality into your design. They are excellent as floor and roof framing supports or as headers for doors, windows and garage doors and columns.

Because they have no camber, VERSA-LAM® LVL products provide flatter, quieter floors, and consequently, the builder can expect happier customers with significantly fewer call backs.

## VERSA-LAM® Beam Architectural Specifications

**Scope:** This work includes the complete furnishing and installation of all VERSA-LAM® beams as shown on the drawings, herein specified and necessary to complete the work.

**Materials:** Southern Pine or Douglas fir veneers, laminated in a press with all grain parallel with the length of the member. Glues used in lamination are phenol formaldehyde and isocyanate exterior-type adhesives which comply with ASTM D2559.

**Design:** VERSA-LAM® beams shall be sized and detailed to fit the dimensions and loads indicated on the plans. All designs shall be in accordance with allowable values developed in accordance with ASTM D5456 and listed in the governing

code evaluation service's report and section properties based upon standard engineering principles. Verification of design of the VERSA-LAM® beams by complete calculations shall be available upon request.

**Drawings:** Additional drawings showing layout and detail necessary for determining fit and placement in the buildings are (are not) to be provided by the supplier.

**Fabrication:** VERSA-LAM® beams shall be manufactured in a plant evaluated for fabrication by the governing code evaluation service and under the supervision of a third-party inspection agency listed by the corresponding evaluation service.

**Storage and Installation:** VERSA-LAM® beams, if stored prior to erection, shall be stored on stickers spaced a maximum of 15 ft. apart. Beams shall be stored on a dry, level surface and protected from the weather. They shall be handled with care so they are not damaged.

VERSA-LAM® beams are to be installed in accordance with the plans and Boise Cascade EWP's Installation Guide. Temporary construction loads which cause stresses beyond design limits are not permitted. Erection bracing shall be provided to assure adequate lateral support for the individual beams and the entire system until the sheathing material has been applied.

**Codes:** VERSA-LAM® beams shall be evaluated by a model code evaluation service.

## Allowable Holes in VERSA-LAM® Beams

### Notes

1. Square and rectangular holes are not permitted.
2. Round holes may be drilled or cut with a hole saw anywhere within the shaded area of the beam.
3. The horizontal distance between adjacent holes must be at least two times the size of the larger hole.
4. Do not drill more than three access holes in any four foot long section of beam.
5. The maximum round hole diameter permitted is:

Beam Depth	Max. Hole Diameter
5½"	¾"
7¼"	1"
9¼" and greater	2"

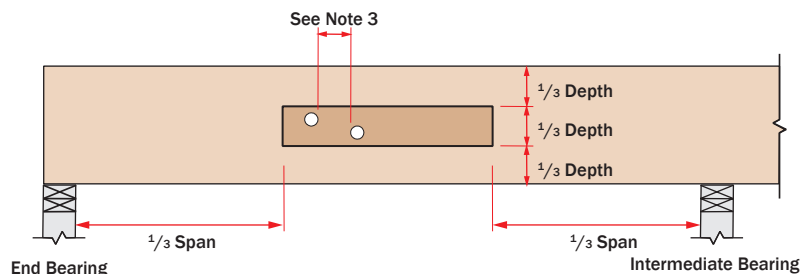

6. These limitations apply to holes drilled for plumbing or wiring access only. The size and location of holes drilled for fasteners are governed by the provisions of the *National Design Specification® for Wood Construction*.
7. Beams deflect under load. Size holes to provide clearance where required.
8. This hole chart is valid for beams supporting uniform load only. For beams supporting concentrated loads or for beams with larger holes, contact Boise Cascade EWP Engineering.

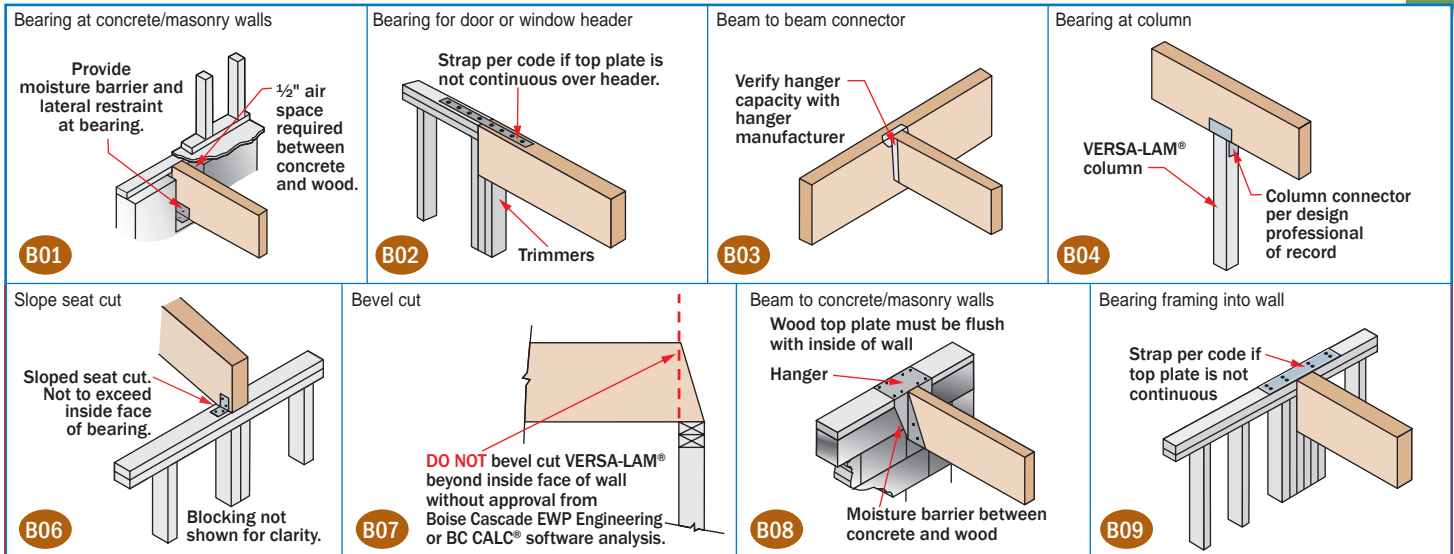

### VERSA-LAM® Installation Notes

- Minimum of 1/2" air space between beam and wall pocket or adequate barrier must be provided between beam and concrete/masonry.
- Adequate bearing shall be provided. If not shown on plans, please refer to load tables in your region's Specifier Guide.
- VERSA-LAM® beams are intended for interior applications only and should be kept as dry as possible during construction.
- Continuous lateral support of top of beam shall be provided (side or top bearing framing).

## Multiple Member Connectors

Side-Loaded Applications									
Number of Members	Maximum Uniform Side Load [plf]								
	Nailed (1)		1/2" Dia. Through Bolt (1)			3/4" Dia. Through Bolt (1)			
	2 rows 16d Sinkers @ 12" o.c.	3 rows 16d Sinkers @ 12" o.c.	2 rows @ 24" o.c. staggered	2 rows @ 12" o.c. staggered	2 rows @ 6" o.c. staggered	2 rows @ 24" o.c. staggered	2 rows @ 12" o.c. staggered	2 rows @ 6" o.c. staggered	2 rows @ 6" o.c. staggered
1 3/4" VERSA-LAM® (Depths of 18" and less)									
2	470	705	505	1010	2020	560	1120	2245	
3 (2)	350	525	375	755	1515	420	840	1685	
4 (3)	use bolt schedule		335	670	1345	370	745	1495	
3 1/2" VERSA-LAM®									
2 (3)	use bolt schedule		855	1715	N/A	1125	2250	N/A	
1 3/4" VERSA-LAM® (Depths of 24")									
Number of Members	Nailed (1)		1/2" Dia. Through Bolt (1)			3/4" Dia. Through Bolt (1)			
	3 rows 16d Sinkers @ 12" o.c.	4 rows 16d Sinkers @ 12" o.c.	3 rows @ 24" o.c. staggered	3 rows @ 18" o.c. 8" staggered	3 rows @ 12" o.c. 6" staggered	3 rows @ 24" o.c. staggered	3 rows @ 18" o.c. 6" staggered	3 rows @ 12" o.c. 4" staggered	3 rows @ 12" o.c. 4" staggered
	2	705	940	755	1010	1515	840	1120	1685
3 (2)	525	705	565	755	1135	630	840	1260	
4 (4)	use bolt schedule		505	670	1010	560	745	1120	

1. Design values apply to common bolts that conform to ANSI/ASME standard B18.21-1981 (ASTM A307 Grades A&B, SAE J429 Grades 1 or 2, or higher). A washer not less than a standard cut washer shall be between the wood and the bolt head and between the wood and the nut.
2. The distance from the edge of the beam to the bolt holes must be at least 2" for 1/2" bolts and 2 1/2" for 3/4" bolts. Bolt holes shall be the same diameter as the bolt.
3. 16d box nails = 0.135" diameter x 3.5" length, 16d sinker nails = 0.148" diameter x 3.25" length.
4. 7" wide beams must be top-loaded or loaded from both sides (lesser side shall be no less than 25% of opposite side).

Top-Loaded Applications			
For top-loaded beams and beams with side loads with less than those shown:			
Plies	Depth	Nailing (2)	Maximum Uniform Load From One Side
(2) 1 1/4" plies	Depths 11 1/8" & less	2 rows 16d box/sinker nails @ 12" o.c.	400 plf
	Depths 14" - 18"	3 rows 16d box/sinker nails @ 12" o.c.	600 plf
	Depth = 24"	4 rows 16d box/sinker nails @ 12" o.c.	800 plf
(3) 1 1/2" plies (1)	Depths 11 1/8" & less	2 rows 16d box/sinker nails @ 12" o.c.	300 plf
	Depths 14" - 18"	3 rows 16d box/sinker nails @ 12" o.c.	450 plf
	Depth = 24"	4 rows 16d box/sinker nails @ 12" o.c.	600 plf
(4) 1 3/4" plies	Depths 18" & less	2 rows 1/2" bolts @ 24" o.c., staggered	335 plf
	Depth = 24"	3 rows 1/2" bolts @ 24" o.c., staggered every 8"	505 plf
(2) 3 1/2" plies	Depths 18" & less	2 rows 1/2" bolts @ 24" o.c., staggered	855 plf
	Depth 20" - 24"	3 rows 1/2" bolts @ 24" o.c., staggered every 8"	1285 plf

1. The nail schedules shown apply to both sides of a 3-member beam.
2. 16d box nails = 0.135" diameter x 3.5" length, 16d sinker nails = 0.148" diameter x 3.25" length.
3. Beams wider than 7" must be designed by the engineer of record.
4. All values in these tables may be increased by 15% for snow-load roofs and by 25% for non-snow load roofs where the building code allows.
5. Use allowable load tables or BC CALC® software to size beams.
6. An equivalent specific gravity of 0.5 may be used when designing specific connections with VERSA-LAM®.
7. Connection values are based upon the 2012 NDS.
8. **FastenMaster TrussLok, Simpson Strong-Tie SDW or SDS, and USP WS screws may also be used to connect multiple member VERSA-LAM® beams, contact Boise Cascade EWP Engineering for further information.**

### Designing Connections for Multiple VERSA-LAM® Members

When using multiple ply VERSA-LAM® beams to create a wider member, the connection of the plies is as critical as determining the beam size. When side loaded beams are not connected properly, the inside plies do not support their share of the load and thus the load-carrying capacity of the full member decreases significantly. The following is an example of how to size and connect a multiple-ply VERSA-LAM® floor beam.

Given: Beam shown below is supporting residential floor load (40 psf live load, 10 psf dead load) and is spanning 16'-0". Beam depth is limited to 14".

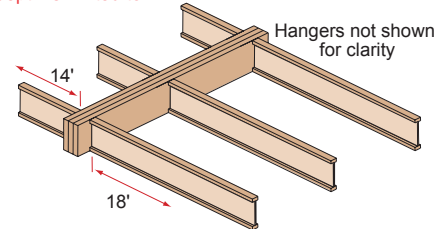

Find: A multiple 1 1/4" ply VERSA-LAM® that is adequate to support the design loads and the member's proper connection schedule.

1. Calculate the tributary width that beam is supporting:  
 $14' / 2 + 18' / 2 = 16'$
2. Use PLF tables on pages 28-30 of ESG or BC CALC® to size beam.  
A Triple VERSA-LAM® 2.0 3100 1 1/4" x 14" is found to adequately support the design loads
3. Calculate the maximum plf load from one side (the right side in this case).  
Max. Side Load =  $(18' / 2) \times (40 + 10 \text{ psf}) = 450 \text{ plf}$
4. Go to the Multiple Member Connection Table, Side-Loaded Applications, 1 1/4" VERSA-LAM®, 3 members.
5. The proper connection schedule must have a capacity greater than the max. side load:  
Nailed: 3 rows 16d sinkers @ 12" o.c.:  
525 plf is greater than 450 plf OK  
Bolts: 1/2" diameter 2 rows @ 12" staggered:  
755 plf is greater than 450 plf OK

# VERSA-LAM® Floor Load Tables

## VERSA-LAM® 2.0 3100 (100% Load Duration)

KEY TO TABLE	Top Figure	- Allowable Total Load [plf]
	Middle Figure	- Allowable Live Load [plf]
	Bottom Figures	- Minimum Required Bearing Length at End / Intermediate Supports [inches]

Span [ft]	1¾" VERSA-LAM® 2.0 3100				Double Ply 1¾" VERSA-LAM® 2.0 3100 or 3½" VERSA-LAM 2.0 3100								Triple Ply 1¾" VERSA-LAM® 2.0 3100 or 5¼" VERSA-LAM 2.0 3100								Quadruple Ply 1¾" VERSA-LAM® 2.0 3100 or 7" VERSA-LAM 2.0 3100					
	7¼"	9½"	11½"	14"	7¼"	9½"	11½"	14"	16"	18"	24"	9½"	11½"	14"	16"	18"	20"	24"	11½"	14"	16"	18"	20"	24"		
6	763	1063	1424	1795	1525	2126	2849	3590	4387	5232	5226	3189	4273	5384	6580	7848	7845	7838	5697	7179	8773	10463	10459	10451		
	762	-	-	-	1525	-	-	-	-	-	-	-	-	-	-	-	-	-	-	-	-	-	-	-		
8	1.8/4.4	2.4/6.1	3.3/8.2	4.1/10.3	1.8/4.4	2.4/6.1	3.3/8.2	4.1/10.3	5/12.6	6/15	6/15	2.4/6.1	3.3/8.2	4.1/10.3	5/12.6	6/15	6/15	6/15	3.3/8.2	4.1/10.3	5/12.6	6/15	6/15	6/15		
	479	746	979	1207	957	1492	1957	2414	2886	3402	3913	2237	2936	3622	4328	5103	5876	5870	3914	4829	5771	6803	7834	7826		
10	322	724	-	-	643	1447	-	-	-	-	-	2171	-	-	-	-	-	-	-	-	-	-	-	-		
	1.5/3.7	2.3/5.7	3/7.5	3.7/9.3	1.5/3.7	2.3/5.7	3/7.5	3.7/9.3	4.4/11.1	5.2/13	6/15	2.3/5.7	3/7.5	3.7/9.3	4.4/11.1	5.2/13	6/15	6/15	3/7.5	3.7/9.3	4.4/11.1	5.2/13	6/15	6/15		
11	243	551	745	909	487	1102	1489	1817	2148	2502	3126	1653	2234	2726	3222	3753	4322	4688	2978	3635	4296	5003	5763	6251		
	165	370	724	-	329	741	1447	-	-	-	-	1111	2171	-	-	-	-	-	2894	-	-	-	-	-		
12	1.5/3	2.1/5.3	2.9/7.1	3.5/8.7	1.5/3	2.1/5.3	2.9/7.1	3.5/8.7	4.1/10.3	4.8/12	6/15	2.1/5.3	2.9/7.1	3.5/8.7	4.1/10.3	4.8/12	5.5/13.8	6/15	2.9/7.1	3.5/8.7	4.1/10.3	4.8/12	5.5/13.8	6/15		
	182	413	665	808	364	825	1330	1617	1904	2209	2839	1238	1995	2425	2856	3313	3800	4259	2659	3233	3807	4417	5067	5679		
13	124	278	544	-	247	557	1087	-	-	-	-	835	1631	-	-	-	-	-	2175	-	-	-	-	-		
	1.5/3	1.7/4.4	2.8/7	3.4/8.5	1.5/3	1.7/4.4	2.8/7	3.4/8.5	4/10.1	4.7/11.7	6/15	1.7/4.4	2.8/7	3.4/8.5	4/10.1	4.7/11.7	5.4/13.4	6/15	2.8/7	3.4/8.5	4/10.1	4.7/11.7	5.4/13.4	6/15		
14	139	317	585	728	279	634	1170	1456	1709	1977	2601	950	1755	2184	2564	2965	3390	3901	2340	2912	3418	3953	4519	5201		
	95	214	419	686	191	429	837	1372	-	-	-	643	1256	2058	-	-	-	-	1675	2745	-	-	-	-		
15	1.5/3	1.5/3.7	2.7/6.8	3.4/8.4	1.5/3	1.5/3.7	2.7/6.8	3.4/8.4	3.9/9.9	4.6/11.4	6/15	1.5/3.7	2.7/6.8	3.4/8.4	3.9/9.9	4.6/11.4	5.2/13	6/15	2.7/6.8	3.4/8.4	3.9/9.9	4.6/11.4	5.2/13	6/15		
	109	248	488	662	217	496	976	1324	1550	1789	2399	744	1464	1986	2326	2683	3059	3598	1952	2647	3101	3577	4078	4797		
16	75	169	329	540	150	337	659	1079	-	-	-	506	988	1619	-	-	-	-	1317	2159	-	-	-	-		
	1.5/3	1.5/3.1	2.4/6.1	3.3/8.3	1.5/3	1.5/3.1	2.4/6.1	3.3/8.3	3.9/9.7	4.5/11.2	6/15	1.5/3.1	2.4/6.1	3.3/8.3	3.9/9.7	4.5/11.2	5.1/12.7	6/15	2.4/6.1	3.3/8.3	3.9/9.7	4.5/11.2	5.1/12.7	6/15		
17	86	198	390	585	173	395	779	1171	1418	1633	2226	593	1169	1756	2128	2449	2786	3338	1558	2342	2837	3265	3715	4451		
	60	135	264	432	120	270	527	864	1290	-	-	405	791	1296	1935	-	-	-	1055	1728	2580	-	-	-		
18	1.5/3	1.5/3	2.1/5.3	3.2/7.9	1.5/3	1.5/3	2.1/5.3	3.2/7.9	3.8/9.6	4.4/11	6/15	1.5/3	2.1/5.3	3.2/7.9	3.8/9.6	4.4/11	5/12.5	6/15	2.1/5.3	3.2/7.9	3.8/9.6	4.4/11	5/12.5	6/15		
	70	160	316	509	139	320	631	1018	1307	1502	2076	479	947	1527	1960	2253	2558	3113	1262	2036	2614	3003	3410	4151		
19	49	110	214	351	98	220	429	703	1049	1493	-	329	643	1054	1573	2240	-	-	858	1405	2098	2987	-	-		
	1.5/3	1.5/3	1.8/4.6	2.9/7.4	1.5/3	1.5/3	1.8/4.6	2.9/7.4	3.8/9.5	4.3/10.9	6/15	1.5/3	1.8/4.6	2.9/7.4	3.8/9.5	4.3/10.9	4.9/12.3	6/15	1.8/4.6	2.9/7.4	3.8/9.5	4.3/10.9	4.9/12.3	6/15		
20	57	131	259	427	113	262	518	854	1151	1390	1944	393	777	1281	1727	2085	2364	2917	1036	1708	2303	2780	3151	3889		
	40	90	177	289	80	181	353	579	864	1230	-	271	530	868	1296	1846	-	-	707	1158	1728	2461	-	-		
21	1.5/3	1.5/3	1.6/4	2.6/6.6	1.5/3	1.5/3	1.6/4	2.6/6.6	3.6/8.9	4.3/10.7	6/15	1.5/3	1.6/4	2.6/6.6	3.6/8.9	4.3/10.7	4.9/12.2	6/15	1.6/4	2.6/6.6	3.6/8.9	4.3/10.7	4.9/12.2	6/15		
	108	215	355	593	93	217	430	710	1018	1274	1826	325	645	1065	1527	1911	2196	2739	860	1420	2036	2547	2929	3652		
22	75	147	241	371	67	151	295	483	720	1026	-	226	442	724	1081	1539	2111	-	589	965	1441	2052	2814	-		
	1.5/3	1.5/3.6	2.3/5.9	3.3/8.4	1.5/3	1.5/3.6	2.3/5.9	3.3/8.4	4.2/10.5	6/15	1.5/3	1.5/3.6	2.3/5.9	3.3/8.4	4.2/10.5	4.8/12	6/15	6/15	1.5/3.6	2.3/5.9	3.3/8.4	4.2/10.5	4.8/12	6/15		
23	90	180	298	477	77	181	360	596	894	1134	1701	271	540	894	1341	1701	2051	2552	720	1191	1788	2268	2735	3402		
	64	124	203	356	56	127	248	407	607	864	-	191	372	610	910	1296	1778	-	496	813	1214	1728	2371	-		
24	1.5/3	1.5/3.2	2.1/5.2	3.1/7.8	1.5/3	1.5/3.2	2.1/5.2	3.1/7.8	4/9.9	5.9/14.8	6/15	1.5/3	1.5/3.2	2.1/5.2	3.1/7.8	4/9.9	4.8/11.95	9/14.8	1.5/3.2	2.1/5.2	3.1/7.8	4/9.9	4.8/11.95	9/14.8		
	76	152	252	405	65	152	304	504	758	1016	1592	229	457	757	1137	1524	1863	2388	609	1009	1516	2032	2484	3184		
25	54	105	173	281	48	108	211	346	516	735	-	162	316	519	774	1102	1512	-	422	691	1032	1470	2016	-		
	1.5/3	1.5/3	1.9/4.7	2.8/7	1.5/3	1.5/3	1.9/4.7	2.8/7	3.7/9.4	5.8/14.6	6/15	1.5/3	1.5/3	1.9/4.7	2.8/7	3.7/9.4	4.6/11.45	8/14.6	1.5/3	1.9/4.7	2.8/7	3.7/9.4	4.6/11.45	8/14.6		
26	65	130	215	354	54	129	259	430	647	915	1496	194	389	646	971	1373	1678	2243	519	861	1295	1830	2237	2991		
	46	90	148	241	41	93	181	296	442	630	1493	139	271	445	664	945	1296	2240	362	593	885	1260	1728	2987		
27	1.5/3	1.5/3	1.7/4.2	2.5/6.3	1.5/3	1.5/3	1.7/4.2	2.5/6.3	3.6/8.9	5.8/14.5	6/15	1.5/3	1.5/3	1.7/4.2	2.5/6.3	3.6/8.9	4.3/10.85	8/14.5	1.5/3	1.7/4.2	2.5/6.3	3.6/8.9	4.3/10.85	8/14.5		
	96	160	260	415	95	192	320	482	692	1034	1592	142	288	480	724	1038	1382	1956	384	640	965	1383	1842	2608		
28	68	111	181	296	70	136	223	332	473	673	1122	104	204	334	499	710	974	1683	272	445	665	947	1299	2244		
	1.5/3	1.5/3.5	2.1/5.2	3.1/7.8	1.5/3	1.5/3.5	2.1/5.2	3.1/7.8	4/9.9	5.9/14.8	6/15	1.5/3	1.5/3.5	2.1/5.2	3.1/7.8	4/9.9	5.9/14.8	6/15	1.5/3.5	2.1/5.2	3.1/7.8	4/9.9	5.9/14.8	6/15		
29	72	122	201	321	71	145	243	368	529	792	1092	106	217	365	552	793	1095	1638	290	486	736	1074	1460	2184		
	52	86	141	226	54	105	172	256	365	516	735	80	157	257	384	547	750	1296	209	343	512	729	1000	1728		
30	1.5/3	1.5/3	1.8/4.4	2.5/6.3	1.5/3	1.5/3	1.8/4.4	2.5/6.3	3.4/8.6	5.1/12.8	6/15	1.5/3	1.5/3	1.8/4.4	2.5/6.3	3.4/8.6	5.1/12.8	6/15	1.5/3	1.5/3	1.8/4.4	2.5/6.3	3.4/8.6	5.1/12.8		
	56	94	154	251	54	111	188	286	412	603	827	80	167	282	429	618	855	1390	223	376	572	824	1139	1853		
31	41	67	111	181	42	82	135	201																		

# VERSA-LAM® Roof Load Tables

## VERSA-LAM® 2.0 3100 (115% Load Duration)

KEY TO TABLE	Top Figure	- Allowable Total Load [plf]
	Middle Figure	- Allowable Live Load [plf]
	Bottom Figures	- Minimum Required Bearing Length at End / Intermediate Supports [inches]

Span [ft]	1¾" VERSA-LAM® 2.0 3100				Double Ply 1¾" VERSA-LAM® 2.0 3100 or 3½" VERSA-LAM 2.0 3100								Triple Ply 1¾" VERSA-LAM® 2.0 3100 or 5¼" VERSA-LAM 2.0 3100						Quadruple Ply 1¾" VERSA-LAM® 2.0 3100 or 7" VERSA-LAM 2.0 3100					
	7¼"	9½"	11½"	14"	7¼"	9½"	11½"	14"	16"	18"	24"	9½"	11½"	14"	16"	18"	20"	24"	11½"	14"	16"	18"	20"	24"
6	878	1223	1639	2065	1755	2446	3278	4130	5047	5232	5226	3669	4917	6195	7570	7848	7845	7838	6556	8260	10094	10463	10459	10451
	-	-	-	-	-	-	-	-	-	-	-	-	-	-	-	-	-	-	-	-	-	-	-	-
8	598	858	1126	1389	1197	1717	2252	2779	3321	3915	3913	2575	3379	4168	4981	5872	5876	5870	4505	5558	6642	7829	7834	7826
	482	-	-	-	965	-	-	-	-	-	-	-	-	-	-	-	-	-	-	-	-	-	-	-
10	326	637	857	1046	651	1274	1714	2092	2472	2880	3126	1912	2571	3138	3709	4320	4695	4688	3429	4184	4945	5759	6259	6251
	247	556	-	-	494	1111	-	-	-	-	-	1667	-	-	-	-	-	-	-	-	-	-	-	-
11	244	526	765	931	487	1052	1531	1861	2192	2543	2839	1577	2296	2792	3288	3814	4265	4259	3062	3723	4383	5085	5687	5679
	186	418	-	-	371	835	-	-	-	-	-	1253	-	-	-	-	-	-	-	-	-	-	-	-
12	187	424	674	838	374	848	1347	1676	1968	2276	2601	1272	2021	2514	2952	3414	3903	3901	2694	3353	3936	4552	5203	5201
	143	322	628	-	286	643	1256	-	-	-	-	965	1884	-	-	-	-	-	2512	-	-	-	-	-
13	146	332	573	762	292	665	1146	1524	1785	2060	2399	997	1719	2287	2678	3089	3522	3598	2292	3049	3571	4119	4696	4797
	112	253	494	-	225	506	988	-	-	-	-	759	1482	-	-	-	-	-	1976	-	-	-	-	-
14	116	265	493	674	233	530	987	1349	1634	1880	2226	796	1480	2023	2450	2821	3208	3338	1973	2697	3267	3761	4278	4451
	90	203	396	648	180	405	791	1296	-	-	-	608	1187	1944	-	-	-	-	1582	2593	-	-	-	-
15	94	215	423	586	188	429	846	1173	1505	1730	2076	644	1268	1759	2258	2595	2946	3113	1691	2346	3011	3459	3928	4151
	73	165	322	527	146	329	643	1054	-	-	-	494	965	1581	-	-	-	-	1286	2108	-	-	-	-
16	77	176	347	515	153	352	695	1029	1327	1601	1944	528	1042	1544	1990	2402	2723	2917	1389	2058	2653	3202	3630	3889
	60	136	265	434	121	271	530	868	1296	-	-	407	795	1303	1944	-	-	-	1060	1737	2593	-	-	-
17	63	146	289	455	127	292	577	910	1173	1468	1829	438	866	1365	1760	2201	2531	2743	1154	1820	2346	2935	3374	3657
	50	113	221	362	101	226	442	724	1081	-	-	339	663	1086	1621	-	-	-	884	1448	2161	-	-	-
18	53	122	242	399	106	244	484	799	1045	1307	1726	367	726	1198	1567	1961	2364	2588	968	1598	2089	2614	3151	3451
	42	95	186	305	85	191	372	610	910	1296	-	286	558	915	1366	1944	-	-	744	1220	1821	2593	-	-
19	103	205	339	89	206	410	677	936	1171	1634	310	615	1016	1404	1757	2147	2450	820	1354	1872	2342	2862	3267	
	81	158	259	72	162	316	519	774	1102	-	243	475	778	1161	1653	-	-	-	633	1037	1548	2204	-	-
20	68	175	289	75	176	350	579	843	1055	1551	263	525	868	1265	1583	1934	2326	699	1157	1686	2110	2579	3101	
	89	136	222	62	139	271	445	664	945	-	208	407	667	996	1418	-	-	-	543	889	1327	1890	-	-
22	65	130	216	54	130	260	431	649	869	1407	194	390	647	973	1303	1593	2111	520	862	1297	1738	2124	2815	
	52	102	167	46	104	204	334	499	710	-	157	306	501	748	1065	1461	-	408	668	997	1420	1948	-	
24	99	164	-	-	98	197	329	496	711	1259	146	296	493	744	1066	1334	1889	395	658	992	1422	1779	2518	
	79	129	-	-	80	157	257	384	547	-	121	236	386	576	820	1125	-	314	515	768	1094	1500	-	
26	76	128	-	-	75	153	256	387	555	1069	112	229	383	580	833	1132	1604	305	511	773	1110	1510	2139	
	62	101	-	-	63	124	202	302	430	1020	95	185	304	453	645	885	1529	247	405	604	860	1180	2039	
28	60	101	-	-	58	120	202	306	441	919	87	180	303	459	661	914	1378	240	404	612	882	1219	1837	
	49	81	-	-	51	99	162	242	344	816	76	148	243	363	517	709	1224	198	324	484	689	945	1633	
30	81	-	-	-	95	161	246	355	797	68	143	242	369	533	738	1196	190	323	492	710	984	1594		
	66	-	-	-	80	132	197	280	664	62	121	198	295	420	576	996	161	263	393	560	768	1327		

- Total Load values are limited by shear, moment or deflection equal to L/180. Total Load values are the capacity of the beam in addition to its own weight.
- Live Load values are limited by deflection equal to L/240. Check the local building code for other deflection limits that may apply.
- Where a Live Load value is not shown, the Total Load value will control.
- Table values represent the most restrictive of simple or multiple span applications. Span is measured center to center of the supports. Analyze multiple span beams with the BC CALC® software if the length of any span is less than half the length of an adjacent span.
- Table values assume that lateral support is provided at each support and continuously along the top edge and applicable compression edges of the beam.
- Table values for Minimum Required Bearing Lengths are based on the allowable compression design value perpendicular to grain for the beam and the Total Load value shown. Other design considerations, such as a weaker support material, may warrant longer bearing lengths. Table values assume that support is provided across the full width of the beam.
- For 2-ply, 3-ply or 4-ply beams; double, triple or quadruple Allowable Total Load and Allowable Live Load values. Minimum Required Bearing Lengths remain the same for any number of plies.
- 1½ inch members deeper than 14 inches are to be used as multiple-member beams only.
- This table was designed to apply to a broad range of applications. It may be possible to exceed the limitations of this table by analyzing a specific application with the BC CALC® software.

# VERSA-LAM® Roof Load Tables

## VERSA-LAM® 2.0 3100 (125% Load Duration)

KEY TO TABLE	Top Figure	-	Allowable Total Load [plf]
	Middle Figure	-	Allowable Live Load [plf]
	Bottom Figures	-	Minimum Required Bearing Length at End / Intermediate Supports [inches]

Span [ft]	1¾" VERSA-LAM® 2.0 3100				Double Ply 1¾" VERSA-LAM® 2.0 3100 or 3½" VERSA-LAM 2.0 3100								Triple Ply 1¾" VERSA-LAM® 2.0 3100 or 5¼" VERSA-LAM 2.0 3100								Quadruple Ply 1¾" VERSA-LAM® 2.0 3100 or 7" VERSA-LAM 2.0 3100					
	7¼"	9½"	11½"	14"	7¼"	9½"	11½"	14"	16"	18"	24"	9½"	11½"	14"	16"	18"	20"	24"	11½"	14"	16"	18"	20"	24"		
6	954	1330	1782	2245	1908	2660	3564	4491	5234	5232	5226	3990	5346	6736	7851	7848	7845	7838	7128	8981	10467	10463	10459	10451		
	-	-	-	-	-	-	-	-	-	-	-	-	-	-	-	-	-	-	-	-	-	-	-	-		
8	640	933	1225	1511	1279	1867	2449	3022	3611	3919	3913	2800	3674	4532	5417	5879	5876	5870	4899	6043	7222	7838	7834	7826		
	482	-	-	-	965	-	-	-	-	-	-	-	-	-	-	-	-	-	-	-	-	-	-	-		
10	2/4.9	2.9/7.1	3.8/9.4	4.6/11.6	2/4.9	2.9/7.1	3.8/9.4	4.6/11.6	5.5/13.8	6/15	6/15	2.9/7.1	3.8/9.4	4.6/11.6	5.5/13.8	6/15	6/15	6/15	3.8/9.4	4.6/11.6	5.5/13.8	6/15	6/15	6/15		
	326	693	932	1138	651	1386	1864	2275	2689	3132	3126	2079	2797	3413	4033	4698	4695	4688	3729	4550	5378	6263	6259	6251		
11	244	552	833	1012	487	1104	1665	2024	2384	2765	2839	1656	2498	3037	3576	4148	4265	4259	3330	4049	4767	5531	5687	5679		
	186	418	815	-	371	835	1631	-	-	-	-	1253	2446	-	-	-	-	-	3262	-	-	-	-	-		
12	187	424	733	912	374	848	1465	1823	2141	2475	2601	1272	2198	2735	3211	3713	3907	3901	2931	3647	4281	4951	5209	5201		
	143	322	628	-	286	643	1256	-	-	-	-	965	1884	-	-	-	-	-	2512	-	-	-	-	-		
13	146	332	623	829	292	665	1247	1658	1942	2240	2399	997	1870	2487	2913	3360	3604	3598	2494	3316	3884	4480	4806	4797		
	112	253	494	810	225	506	988	1619	-	-	-	759	1482	2429	-	-	-	-	1976	3238	-	-	-	-		
14	116	265	521	734	233	530	1043	1467	1777	2046	2226	796	1564	2201	2666	3068	3345	3338	2085	2934	3554	4091	4459	4451		
	90	203	396	648	180	405	791	1296	-	-	-	608	1187	1944	-	-	-	-	1582	2593	-	-	-	-		
15	94	215	423	638	188	429	846	1276	1638	1882	2076	644	1268	1914	2456	2823	3120	3113	1691	2552	3275	3763	4159	4151		
	73	165	322	527	146	329	643	1054	1573	-	-	494	965	1581	2360	-	-	-	1286	2108	3146	-	-	-		
16	77	176	347	560	153	352	695	1120	1443	1742	1944	528	1042	1680	2165	2613	2923	2917	1389	2240	2887	3484	3897	3889		
	60	136	265	434	121	271	530	868	1296	-	-	407	795	1303	1944	-	-	-	1060	1737	2593	-	-	-		
17	63	146	289	476	127	292	577	951	1277	1597	1829	438	866	1427	1915	2395	2749	2743	1154	1902	2553	3193	3665	3657		
	50	113	221	362	101	226	442	724	1081	1539	-	339	663	1086	1621	2308	-	-	884	1448	2161	3078	-	-		
18	53	122	242	399	106	244	484	799	1137	1422	1726	367	726	1198	1705	2133	2572	2588	968	1598	2274	2845	3429	3451		
	42	95	186	305	85	191	372	610	910	1296	-	286	558	915	1366	1944	-	-	744	1220	1821	2593	-	-		
19	103	205	339	89	206	410	677	1016	1275	1634	-	310	615	1016	1524	1912	2336	2450	820	1354	2032	2549	3115	3267		
	81	158	259	72	162	316	519	774	1102	-	-	243	475	778	1161	1653	2268	-	633	1037	1548	2204	3024	-		
20	88	175	289	75	176	350	579	869	1149	1551	-	263	525	868	1303	1723	2105	2326	699	1157	1737	2297	2807	3101		
	69	136	222	62	139	271	445	664	945	-	-	208	407	667	996	1418	1944	-	543	889	1327	1890	2593	-		
22	65	130	216	54	130	260	431	649	928	1407	-	194	390	647	973	1393	1735	2111	520	862	1297	1857	2313	2815		
	52	102	167	46	104	204	334	499	710	-	-	157	306	501	748	1065	1461	-	408	668	997	1420	1948	-		
24	99	164	-	-	98	197	329	496	711	1288	-	146	296	493	744	1066	1453	1932	395	658	992	1422	1937	2576		
	79	129	-	-	80	157	257	384	547	-	-	121	236	386	576	820	1125	-	314	515	768	1094	1500	-		
26	76	128	-	-	75	153	256	387	555	1164	-	112	229	383	580	833	1150	1747	305	511	773	1110	1533	2329		
	62	101	-	-	63	124	202	302	430	1020	-	95	185	304	453	645	885	1529	247	405	604	860	1180	2039		
28	60	101	-	-	58	120	202	306	441	1001	-	87	180	303	459	661	914	1501	240	404	612	882	1219	2001		
	49	81	-	-	51	99	162	242	344	816	-	76	148	243	363	517	709	1224	198	324	484	689	945	1633		
30	81	-	-	-	95	161	246	355	511	1288	-	68	143	242	369	533	738	1291	190	323	492	710	984	1721		
	66	-	-	-	80	132	197	280	402	1020	-	62	121	198	295	420	576	996	161	263	393	560	768	1327		
	1.5/3	-	-	-	1.5/3	1.5/3	1.5/3	1.5/3	1.5/3	1.5/3	1.5/3	1.5/3	1.5/3	1.5/3	1.5/3	1.5/3	1.5/3	1.5/3	1.5/3	1.5/3	1.5/3	1.5/3	1.5/3	1.5/3		

- Total Load values are limited by shear, moment or deflection equal to L/180. Total Load values are the capacity of the beam in addition to its own weight.
- Live Load values are limited by deflection equal to L/240. Check the local building code for other deflection limits that may apply.
- Where a Live Load value is not shown, the Total Load value will control.
- Table values represent the most restrictive of simple or multiple span applications. Span is measured center to center of the supports. Analyze multiple span beams with the BC CALC® software if the length of any span is less than half the length of an adjacent span.
- Table values assume that lateral support is provided at each support and continuously along the top edge and applicable compression edges of the beam.
- Table values for Minimum Required Bearing Lengths are based on the allowable compression design value perpendicular to grain for the beam and the Total Load value shown. Other design considerations, such as a weaker support material, may warrant longer bearing lengths. Table values assume that support is provided across the full width of the beam.
- For 2-ply, 3-ply or 4-ply beams; double, triple or quadruple Allowable Total Load and Allowable Live Load values. Minimum Required Bearing Lengths remain the same for any number of plies.
- 1½ inch members deeper than 14 inches are to be used as multiple-member beams only.
- This table was designed to apply to a broad range of applications. It may be possible to exceed the limitations of this table by analyzing a specific application with the BC CALC® software.

## Closest Allowable Nail Spacing

VERSA-LAM® & VERSA-RIM® Products	Nail Size	Nailing Parallel to Glue Lines (Narrow Face) <sup>(1)</sup>						Nailing Perpendicular to Glue Lines (Wide Face)	
		VERSA-LAM® 1.4 1800 Rimboard 1 <sup>5</sup> / <sub>16</sub> "		VERSA-LAM® 1 <sup>3</sup> / <sub>4</sub> "		VERSA-LAM® 3 <sup>1</sup> / <sub>2</sub> " & Wider		All Products	
		O.C. [in]	End [in]	O.C. [in]	End [in]	O.C. [in]	End [in]	O.C. [in]	End [in]
8d Box (0.113"ø x 2.5")		3	1½	2	1	2	½	2	½
8d Common (0.131"ø x 2.5")		3	2	3	2	2	1	2	1
10d & 12d Box (0.128"ø x 3", 3.25")		3	2	3	2	2	1	2	1
16d Box (0.135"ø x 3.5")		3	2	3	2	2	1	2	1
10d & 12d Common & 16d Sinker (0.148"ø x 3", 3.25")		4	3	4	3	2	2	2	2
16d Common (0.162"ø x 3.5")		6	4	6	3	2	2	2	2

Nailing Parallel to Glue Lines (Narrow Face)

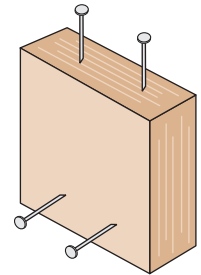

Nailing Perpendicular to Glue Lines (Wide Face)

**Nailing Notes**

- For 1½" thickness and greater, 2 rows of nails (such as for a metal strap) are allowed (use ½" minimum offset between rows and stagger nails).

- Offset and stagger nail rows from floor sheathing and wall sole plate.
- Simpson Strong-Tie A35 and LPT4 connectors may be attached to the side VERSA-LAM®/VERSA-RIM®. Use nails as specified by Simpson Strong-Tie.

## VERSA-LAM® Design Values

Grade	Width [in]	Depth [in]	Weight [lb/ft]	Allowable Shear [lb]	Allowable Moment [ft-lb]	Moment of Inertia [in <sup>4</sup> ]	Grade	Width [in]	Depth [in]	Weight [lb/ft]	Allowable Shear [lb]	Allowable Moment [ft-lb]	Moment of Inertia [in <sup>4</sup> ]
VERSA-STUD® 1.7 2650	1½	3½	1.5	998	776	5.4	VERSA-LAM® 2.0 3100	5¼	5¼	8.0	5237	6830	63.3
		5½	2.4	1568	1821	20.8			5½	8.4	5486	7457	72.8
		7¼	3.2	2066	3069	47.6			7¼	11.0	7232	12566	166.7
VERSA-LAM® 2.0 3100	1¾	3½	1.8	1164	1058	6.3			9¼	14.1	9227	19908	346.3
		5½	2.8	1829	2486	24.3			9½	14.5	9476	20937	375.1
		7¼	3.7	2411	4189	55.6			11¼	17.1	11222	28814	622.9
		9¼	4.7	3076	6636	115.4			11½	18.1	11845	31913	732.6
		9½	4.8	3159	6979	125.0			14	21.3	13965	43552	1200.5
		11¼	5.7	3741	9605	207.6			16	24.4	15960	56046	1792.0
		11½	6.0	3948	10638	244.2			18	27.4	17955	70011	2551.5
		14	7.1	4655	14517	400.2			20	30.4	19950	85428	3500.0
		16	8.1	5320	18682	597.3			24	36.5	23940	120549	6048.0
		18	9.1	5985	23337	850.5		7	9¼	16.6	12303	26544	461.7
		24	12.2	7980	40183	2016.0			9½	17.1	12635	27916	500.1
VERSA-LAM® 2.0 3100	3½	5½	5.6	3658	4971	48.5			11¼	20.2	14963	38419	830.6
		7¼	7.4	4821	8377	111.1			11½	21.4	15794	42550	976.8
		9¼	9.4	6151	13272	230.8			14	25.2	18620	58069	1600.7
		9½	9.6	6318	13958	250.1			16	28.8	21280	74728	2389.3
		11¼	11.4	7481	19210	415.3			18	32.4	23940	93348	3402.0
		11½	12.1	7897	21275	488.4			20	36.0	26600	113904	4666.7
		14	14.2	9310	29035	800.3		24	43.2	31920	160732	8064.0	
		16	16.2	10640	37364	1194.7							
18	18.3	11970	46674	1701.0									
20	20.3	13300	56952	2333.3									

Design Property	Grade	Modulus of Elasticity	Bending	Horizontal Shear	Tension Parallel to Grain	Compression Parallel to Grain	Compression Perpendicular to Grain	Equivalent Specific Gravity for Fastener Design (SG)
		E(x 10 <sup>6</sup> psi) <sup>(1)</sup>	F <sub>b</sub> (psi) <sup>(2)(3)</sup>	F <sub>v</sub> (psi) <sup>(2)(4)</sup>	F <sub>t</sub> (psi) <sup>(2)(5)</sup>	F <sub>c  </sub> (psi) <sup>(2)</sup>	F <sub>c⊥</sub> (psi) <sup>(1)(6)</sup>	
VERSA-LAM® Beams	2.0 3100	2.0	3100	285	2150	3000	750	0.5
VERSA-LAM® Studs	1.7 2650	1.7	2650	285	1650	3000	750	0.5
VERSA-LAM® Columns	1.8 2750	1.8	2750	285	1825	3000	750	0.5

- This value cannot be adjusted for load duration.
  - This value is based upon a load duration of 100% and may be adjusted for other load durations.
  - Fiber stress bending value shall be multiplied by the depth factor, (12/d)<sup>1/8</sup> where d = member depth [in].
  - Stress applied perpendicular to the glue lines.
  - Tension value shall be multiplied by a length factor, (4/L)<sup>1/8</sup> where L = member length [ft]. Use L = 4 for members less than four feet long.
  - Stress applied parallel to the glue lines.
- \* Design properties are limited to dry conditions of use where the maximum moisture content of the material will not exceed 16%.

# VERSA-LAM® 1.8 2750 Columns

Column Length [ft]	Allowable Axial Load (lb)														
	3 1/2" x 3 1/2"			3 1/2" x 4 3/8"			3 1/2" x 5 1/4"			3 1/2" x 5 1/2"			3 1/2" x 7"		
	100%	115%	125%	100%	115%	125%	100%	115%	125%	100%	115%	125%	100%	115%	125%
4	15,265	16,750	17,650	19,100	20,950	22,070	22,920	25,150	26,500	24,020	26,350	27,770	30,570	33,545	35,345
5	12,830	13,770	14,320	16,050	17,220	17,910	19,260	20,670	21,505	20,185	21,660	22,530	25,690	27,580	28,680
6	10,580	11,190	11,540	13,240	13,990	14,440	15,890	16,800	17,335	16,645	17,605	18,165	21,190	22,410	23,120
7	8,745	9,160	9,400	10,940	11,460	11,760	13,130	13,760	14,120	13,755	14,410	14,795	17,510	18,350	18,835
8	7,295	7,590	7,765	9,120	9,490	9,710	10,950	11,400	11,660	11,475	11,945	12,215	14,610	15,210	15,555
9	6,155	6,375	6,500	7,700	7,970	8,130	9,245	9,575	9,765	9,685	10,030	10,230	12,330	12,770	13,025
10	5,250	5,415	5,510	6,570	6,770	6,890	7,885	8,135	8,280	8,260	8,525	8,675	10,520	10,850	11,040
11	4,525	4,655	4,730	5,660	5,820	5,910	6,795	6,990	7,100	7,120	7,325	7,440	9,065	9,325	9,475
12	3,935	4,040	4,095	4,920	5,050	5,120	5,910	6,065	6,150	6,195	6,355	6,445	7,885	8,090	8,210
13	3,455	3,535	3,580	4,320	4,420	4,480	5,185	5,310	5,380	5,435	5,565	5,635	6,920	7,080	7,175
14	3,050	3,120	3,155	3,820	3,900	3,950	4,585	4,685	4,740	4,805	4,905	4,965	6,115	6,250	6,325
	3 1/2" x 7 1/4"			5 1/4" x 5 1/4"			5 1/4" x 5 1/2"			5 1/4" x 7"			5 1/4" x 7 1/4"		
	100%	115%	125%	100%	115%	125%	100%	115%	125%	100%	115%	125%	100%	115%	125%
4	31,670	34,750	36,625												
5	26,615	28,560	29,705												
6	21,950	23,215	23,950	34,355	37,695	39,715	36,010	39,495	41,610						
7	18,140	19,005	19,505	30,700	33,170	34,625	32,165	34,750	36,280						
8	15,135	15,755	16,110	27,095	28,910	29,975	28,390	30,295	31,405	36,160	38,590	40,000	37,450	39,960	41,420
9	12,770	13,225	13,490	23,815	25,180	25,980	24,950	26,385	27,220	31,770	33,600	34,670	32,910	34,800	35,910
10	10,895	11,240	11,440	20,950	22,005	22,620	21,950	23,060	23,700	27,950	29,360	30,190	28,960	30,420	31,260
11	9,390	9,660	9,810	18,500	19,340	19,820	19,385	20,260	20,770	24,690	25,810	26,450	25,570	26,720	27,400
12	8,170	8,380	8,500	16,420	17,085	17,475	17,200	17,910	18,305	21,910	22,800	23,320	22,690	23,620	24,150
13	7,165	7,335	7,430	14,640	15,185	15,500	15,340	15,910	16,240	19,540	20,270	20,680	20,230	20,990	21,430
14	6,335	6,470	6,550	13,120	13,570	13,830	13,750	14,220	14,490	17,510	18,110	18,460	18,140	18,760	19,110
15				11,820	12,195	12,405	12,385	12,775	13,000	15,770	16,270	16,560	16,330	16,850	17,150
16				10,690	11,005	11,185	11,200	11,530	11,720	14,270	14,690	14,930	14,780	15,210	15,460
17				9,715	9,980	10,135	10,180	10,460	10,620	12,960	13,320	13,520	13,420	13,790	14,010
18				8,860	9,090	9,220	9,285	9,525	9,660	11,820	12,130	12,300	12,250	12,560	12,740
19				8,110	8,310	8,420	8,500	8,705	8,825	10,820	11,090	11,240	11,210	11,480	11,640
20				7,455	7,625	7,720	7,810	7,990	8,090	9,950	10,170	10,300	10,300	10,540	10,670
21				6,870	7,020	7,105	7,195	7,355	7,445	9,170	9,370	9,480	9,490	9,700	9,820
22															

Allowable Design Stresses			Notes
Modulus of Elasticity: E = 1.8 x 10 <sup>6</sup> psi			
Bending:	Parallel to Gluelines (Beam):	F <sub>b</sub> = 2750*(12/d) <sup>1/9</sup> psi	
	Perp to Gluelines (Plank):	F <sub>b</sub> = 2500*(12/d) <sup>1/9</sup> psi	
Compression Parallel to Grain:		F <sub>c  </sub> = 3000 psi	
Compression Perpendicular to Grain:			
Parallel to Gluelines (Beam):		F <sub>c  </sub> = 750 psi	
Perp to Gluelines (Plank):		F <sub>c⊥</sub> = 450 psi	
Tension Parallel to Grain:		F <sub>t</sub> = 1650 psi	

# VERSA-STUD® 1.7 2650

## Allowable Design Values

Product	Bending F <sub>b</sub> [psi]	Compression Parallel to Grain F <sub>c</sub> [psi]	Modulus of Elasticity E [psi]	Horizontal Shear F <sub>v</sub> [psi]
<b>VERSA-STUD® 1.7 2650</b>	<b>2650</b>	<b>3000</b>	<b>1,700,000</b>	<b>285</b>
Spruce Pine Fir (North) # 1 / 2 Grade	875	1150	1,400,000	135
Hem-Fir # 2 Grade	850	1300	1,300,000	150
Western Woods # 2 Grade	675	900	1,000,000	135

**Notes:**

- Design values are for loads applied to the narrow face of the studs.
- Dimension lumber values taken from from 2012 NDS Supplement: Design Values for Wood Construction (per 2012 IBC/IRC).

- Repetitive member and size factors have not been applied.

For further design information, please see *VERSA-STUD 1.7 2650 Eastern Tall Wall Guide*.





New BC FRAMER® represents a huge technological leap to help you improve the efficiency and profitability of your engineered wood products business. Boise Cascade will provide you what we believe is now the industry's best design software, offering far greater productivity than even our current version of BC FRAMER®. This new software package will help your design department work faster and accomplish more. You don't get paid to do drawings, but at least now you can do them in less time, and better.

- Shrink design time with BC FRAMER® model sharing.
- Save time & prevent mistakes with best-in-industry file integration.
- Experience the efficiencies of BC FRAMER® whole house modeling.
- Draw floor and wall plans simultaneously with BC FRAMER®.
- Check the plan every possible way with BC FRAMER® full 3-D viewer.
- Create a master plan and multiple options that can be quickly selected and exported to a plot-specific file in a few minutes – a fraction of the time it could have taken in the past.

Information can also be obtained at 1-800-405-5969 or email us at [EWPSupport@BC.com](mailto:EWPSupport@BC.com).

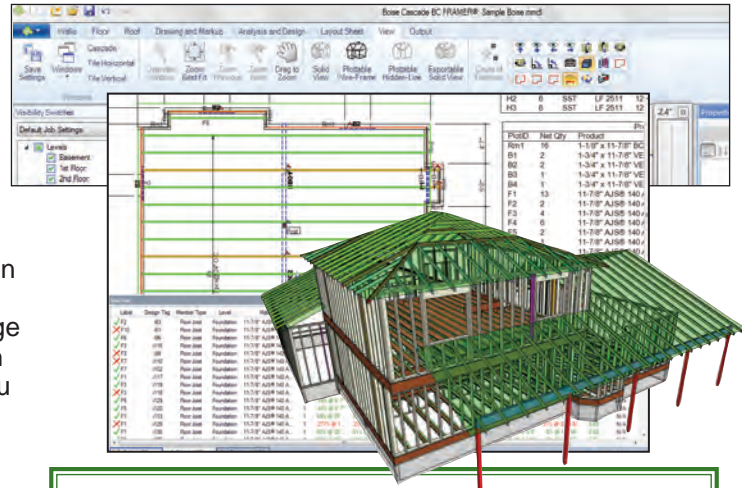

### RECOMMENDED HARDWARE

- **CPU:** Quad Core 64 bit Processor
- **L2 Cache:** 3MB/Core
- **RAM:** 8.0GB
- **Video:** Full support for DirectX 9; Single monitors, 1280x1024 512MB; Dual monitor, 1280x1024 1GB (Minimum 1024x768)
- **Operating Systems:** Windows® 7 or 8.1 (Professional Edition 64-bit)

Actual specifications vary by user and will be assessed prior to installation.

## BC CALC® Sizing Software

BC CALC® is simple to use, yet robust enough to analyze most all joist, beam, and column applications. Once an analysis is run, the user may print an easy-to-read design report that displays the span and load information with the analysis results.

BC COLUMN® has now been merged into BC CALC®, allowing the sizing of joists, beams, rafters, columns, and studs all in one convenient program.

In addition to BCI® & AJS® Joists, VERSA-LAM®, and BOISE GLULAM®, BC CALC® also offers the analysis of solid sawn lumber and timber members. Thus BC CALC® is the only program needed to analyze structural wood members.



Boise Cascade has provided BC CALC® free of charge to the design community since 1994.

### COMPUTER REQUIREMENTS

PC with any current version of MS Windows®, along with an internet connection. For questions regarding BC CALC®, call 1-800-405-5969 or email [EWPSupport@BC.com](mailto:EWPSupport@BC.com).

To Download BC CALC US, [www.bccalc.com](http://www.bccalc.com)

**SELECTED PRODUCT**  
5-1/8" x 6" BOISE GLULAM® Combination #3 DF

Construction	Loads	Products	Deflection	Project Notes
VL 1-3/4" SP 2.0 3100		5-1/8"		
VL 2-5/8" SP 2.0 3100		5-1/4"		
VL 3-1/2" SP 2.0 3100		5-1/2"		
VL 5-1/4" SP 2.0 3100				
3-1/8" VEROB® Glulam				
3-1/8" Combination #3 DF				
3-1/2" 30F-E4 DF FSP KING I		7-1/2"		
3-1/2" Combination #3 DF		5"		
5-1/8" 24F-VB/DF Glulam				

Reaction Summary (Down / Uplift) (lb)		Beam	Stair	Wind	Roof Live
Reactions	Line				
RU, C		4,125.0	7,044.0		
BU, 3-1/2"		4,115.0	7,026.0		

Load Summary		Load Type	Ref. Stat	End	100%	90%	105%	100%	105%	OC5
Tag	Description									
1	Standard Load	Upl. Area (Roof/2)	L	00-00-00	03-06-00	15	30			14-00-00

Control Summary		Value	% Allowable	Location	Discipline	
Pos. Moment		80,526.79-lb-ft	69.2%	115%	4	18-09-04
End Shear		16,537.0-lb	32.7%	110%	4	05-03-00
Total Load Defl.		0.208 (1.904")	66.5%	n/a	4	16-09-04
Live Load Defl.		0.330 (1.201")	72.8%	n/a	5	16-09-04
Span / Depth		19.9	n/a	n/a	0	00-00-00



  

**Bearing Supports**

Dir.	Lat. W/L	Value	% Allow	Member	Material	
BU	W/Plat	4" x 7"	11,160 lbs	99.5%	50.2%	Non-Fir
BU	W/Plat	3-1/2" x 7"	11,142 lbs	n/a	50.8%	Unspecified

**Notes:**  
Design meets Code minimum (L240) Total load deflection criteria.  
Design meets Code minimum (L240) Live load deflection criteria.  
Calculations assume members to be fully laterally braced.

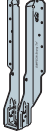
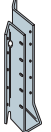
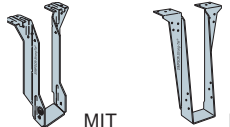

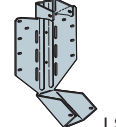
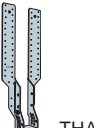
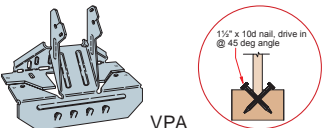

# Framing Connectors - Simpson Strong-Tie

Single Joist - Top Flange						Single Joist - Face Mount						Face Mount Skewed 45° Joist Hanger					
																	
Joist Depth	BCI®	Hanger	Capacity [lbs]	Nailing		Joist Depth	BCI®	Hanger	Capacity [lbs]	Nailing		Joist Depth	BCI®	Hanger	Capacity [lbs]	Nailing	
				Header	Joist					Header	Joist					Header	Joist
9 1/2"	4500s	ITS1.81/9.5	993	6-10d	-	9 1/2"	4500s	IUS1.81/9.5	950	8-10d	-	9 1/2"	4500s	SUR/L1.81/9	1081	12-16d	2-10dx1 1/2"
	5000s	ITS2.06/9.5	993	6-10d	-		5000s	IUS2.06/9.5	950	8-10d	-		5000s	SUR/L2.06/9	1097	14-16d	2-10dx1 1/2"
	6000s	ITS2.37/9.5	1225	6-10d	-		6000s	IUS2.37/9.5	950	8-10d	-		6000s	SUR/L2.37/9	1343	14-16d	2-10dx1 1/2"
	6500s	ITS2.56/9.5	1225	6-10d	-		6500s	IUS2.56/9.5	950	8-10d	-		6500s	SUR/L2.56/9	1343	14-16d	2-10dx1 1/2"
	90s	ITS3.56/11.88	1237	6-10d	-		90s	IUS3.56/11.88	1185	10-10d	-		90s	SUR/L2.37/11	1385	16-16d	2-10dx1 1/2"
11 1/2"	4500s	ITS1.81/11.88	1068	6-10d	-	11 1/2"	4500s	IUS1.81/11.88	1185	10-10d	-	11 1/2"	4500s	SUR/L1.81/11	1306	16-16d	2-10dx1 1/2"
	5000s	ITS2.06/11.88	1068	6-10d	-		5000s	IUS2.06/11.88	1185	10-10d	-		5000s	SUR/L2.06/11	1350	16-16d	2-10dx1 1/2"
	6000s	ITS2.37/11.88	1237	6-10d	-		6000s	IUS2.37/11.88	1185	10-10d	-		6000s	SUR/L2.37/11	1385	16-16d	2-10dx1 1/2"
	6500s	ITS2.56/11.88	1237	6-10d	-		6500s	IUS2.56/11.88	1185	10-10d	-		6500s	SUR/L2.56/11	1385	16-16d	2-10dx1 1/2"
	90s	ITS3.56/11.88	1518	6-10d	-		90s	IUS3.56/11.88	1420	12-10d	-		90s	SUR/L410	1906	14-16d	2-10dx1 1/2"
14"	4500s	ITS1.81/14	1075	6-10d	-	14"	4500s	IUS1.81/14	1420	12-10d	-	14"	4500s	SUR/L1.81/14	1675	20-16d	2-10dx1 1/2"
	5000s	ITS2.06/14	1081	6-10d	-		5000s	IUS2.06/14	1420	12-10d	-		5000s	SUR/L2.06/14	1693	18-16d	2-10dx1 1/2"
	6000s	ITS2.37/14	1262	6-10d	-		6000s	IUS2.37/14	1420	12-10d	-		6000s	SUR/L2.37/14	1693	18-16d	2-10dx1 1/2"
	6500s	ITS2.56/14	1262	6-10d	-		6500s	IUS2.56/14	1420	12-10d	-		6500s	SUR/L2.56/14	1693	18-16d	2-10dx1 1/2"
	90s	ITS3.56/14	1520	6-10d	-		90s	IUS3.56/14	1420	12-10d	-		90s	SUR/L414	2050	18-16d	2-10dx1 1/2"
16"	4500s	ITS1.81/16	1081	6-10d	-	16"	4500s	IUS1.81/16	1660	14-10d	-	16"	4500s	SUR/L1.81/16	1887	20-16d	2-10dx1 1/2"
	5000s	ITS2.06/16	1087	6-10d	-		5000s	IUS2.06/16	1660	14-10d	-		5000s	SUR/L2.06/16	1920	18-16d	2-10dx1 1/2"
	6000s	ITS2.37/16	1268	6-10d	-		6000s	IUS2.37/16	1660	14-10d	-		6000s	SUR/L2.37/16	1920	18-16d	2-10dx1 1/2"
	6500s	ITS2.56/16	1268	6-10d	-		6500s	IUS2.56/16	1660	14-10d	-		6500s	SUR/L2.56/16	1920	18-16d	2-10dx1 1/2"
	90s	ITS3.56/16	1520	6-10d	-		90s	IUS3.56/16	1425	14-10d	-		90s	SUR/L414	2250	18-16d	2-10dx1 1/2"
																	
Joist Depth	BCI®	Hanger	Capacity [lbs]	Nailing		Joist Depth	BCI®	Hanger	Capacity [lbs]	Nailing		Joist Depth	BCI®	Hanger	Capacity [lbs]	Nailing	
				Header	Joist					Header	Joist					Header	Joist
9 1/2"	4500s	MIT49.5	2305	8-16d	2-10dx1 1/2"	9 1/2"	4500s	MIU3.56/9	2305	16-16d	2-10dx1 1/2"	9 1/2"	4500s	LSSUI25	995	9-10d	7-10dx1 1/2"
	5000s	MIT4.12/9.5	2305	8-16d	2-10dx1 1/2"		5000s	MIU4.12/9	2305	16-16d	2-10dx1 1/2"		5000s	LSSU2.06	995	9-10d	7-10dx1 1/2"
	6000s	MIT359.5-2	2305	8-16d	2-10dx1 1/2"		6000s	MIU4.75/9	2305	16-16d	2-10dx1 1/2"		6000s	LSSUI35	995	9-10d	7-10dx1 1/2"
	6500s	MIT39.5-2	2305	8-16d	2-10dx1 1/2"		6500s	MIU5.12/9	2305	16-16d	2-10dx1 1/2"		6500s	LSSUH310	1425	14-10d	7-10dx1 1/2"
	90s	MIT11.88	2305	8-16d	2-10dx1 1/2"		90s	MIU5.56/11	2880	20-16d	2-10dx1 1/2"		90s	LSSUI25	995	9-10d	7-10dx1 1/2"
11 1/2"	4500s	MIT4.12/11.88	2305	8-16d	2-10dx1 1/2"	11 1/2"	4500s	MIU4.12/11	2880	20-16d	2-10dx1 1/2"	11 1/2"	4500s	LSSU2.06	995	9-10d	7-10dx1 1/2"
	5000s	MIT3511.88-2	2305	8-16d	2-10dx1 1/2"		5000s	MIU4.75/11	2880	20-16d	2-10dx1 1/2"		5000s	LSSUI35	995	9-10d	7-10dx1 1/2"
	6000s	MIT311.88-2	2305	8-16d	2-10dx1 1/2"		6000s	MIU5.12/11	2880	20-16d	2-10dx1 1/2"		6000s	LSSUH310	1475	14-10d	7-10dx1 1/2"
	6500s	MIT3511.88-2	2305	8-16d	2-10dx1 1/2"		6500s	MIU5.12/11	2880	20-16d	2-10dx1 1/2"		6500s	LSSUI35	995	9-10d	7-10dx1 1/2"
	90s	MIT3511.88-2	2305	8-16d	2-10dx1 1/2"		90s	MIU4.75/11	2600	20-16d	2-10dx1 1/2"		90s	LSSUI35	995	9-10d	7-10dx1 1/2"
14"	4500s	MIT414	2305	8-16d	2-10dx1 1/2"	14"	4500s	MIU3.56/14	3170	22-16d	2-10dx1 1/2"	14"	4500s	LSSU410	1625	14-10d	12-10dx1 1/2"
	5000s	MIT4.12/14	2305	8-16d	2-10dx1 1/2"		5000s	MIU4.12/14	3170	22-16d	2-10dx1 1/2"		4500s	LSSUI25	995	9-10d	7-10dx1 1/2"
	6000s	MIT3514-2	2305	8-16d	2-10dx1 1/2"		6000s	MIU4.75/14	3170	22-16d	2-10dx1 1/2"		5000s	LSSU2.06	995	9-10d	7-10dx1 1/2"
	6500s	MIT314-2	2305	8-16d	2-10dx1 1/2"		6500s	MIU5.12/14	3170	22-16d	2-10dx1 1/2"		6000s	LSSUI35	995	9-10d	7-10dx1 1/2"
	90s	MIT3514-2	2305	8-16d	2-10dx1 1/2"		90s	MIU4.75/14	2700	22-16d	2-10dx1 1/2"		6500s	LSSUH310	1600	14-10d	7-10dx1 1/2"
16"	4500s	MIT416	2305	8-16d	2-10dx1 1/2"	16"	4500s	MIU3.56/16	3455	24-16d	2-10dx1 1/2"	16"	60s	LSSUI35	995	9-10d	7-10dx1 1/2"
	5000s	LBV4.12/16	2460	10-16d	2-10dx1 1/2"		5000s	MIU4.12/16	3455	24-16d	2-10dx1 1/2"		90s	LSSU410	1625	14-10d	12-10dx1 1/2"
	6000s	MIT4.75/16	2305	8-16d	2-10dx1 1/2"		6000s	MIU4.75/16	3455	24-16d	2-10dx1 1/2"						
	6500s	MIT5.12/16	2305	8-16d	2-10dx1 1/2"		6500s	MIU5.12/16	3455	24-16d	2-10dx1 1/2"						
	90s	MIT4.75/16	2305	8-16d	2-10dx1 1/2"		90s	MIU4.75/16	2725	24-16d	2-10dx1 1/2"						
																	
Joist Depth	BCI®	Hanger	Capacity [lbs]	Nailing		Joist Depth	BCI®	Hanger	Capacity [lbs]	Ffasterener							
				Header	Joist					Top Plate	Rafter						
9 1/2"	4500s	THAI1.81/22	1181	6-10d	2-10dx1 1/2"	9 1/2"	4500s	LSSUI25	995	9-10d	7-10dx1 1/2"						
	5000s	THAI2.06/22	1181	6-10d	2-10dx1 1/2"		5000s	LSSU2.06	995	9-10d	7-10dx1 1/2"						
	6000s	THAI3522	1393	6-10d	2-10dx1 1/2"		6000s	LSSUI35	995	9-10d	7-10dx1 1/2"						
	6500s	THAI322	1393	6-10d	2-10dx1 1/2"		6500s	LSSUH310	1425	14-10d	7-10dx1 1/2"						
	90s	THAI1.81/22	1443	6-10d	2-10dx1 1/2"		90s	LSSUI25	995	9-10d	7-10dx1 1/2"						
11 1/2"	4500s	THAI2.06/22	1443	6-10d	2-10dx1 1/2"	11 1/2"	4500s	LSSU2.06	995	9-10d	7-10dx1 1/2"						
	5000s	THAI3522	1443	6-10d	2-10dx1 1/2"		5000s	LSSUI35	995	9-10d	7-10dx1 1/2"						
	6000s	THAI322	1443	6-10d	2-10dx1 1/2"		6000s	LSSUH310	1475	14-10d	7-10dx1 1/2"						
	6500s	THAI322	1443	6-10d	2-10dx1 1/2"		6500s	LSSUI35	995	9-10d	7-10dx1 1/2"						
	90s	THAI3522	1443	6-10d	2-10dx1 1/2"		90s	LSSU410	1625	14-10d	12-10dx1 1/2"						
14"	4500s	THAI1.81/22	1600	6-10d	2-10dx1 1/2"	14"	4500s	LSSUI25	995	9-10d	7-10dx1 1/2"						
	5000s	THAI2.06/22	1600	6-10d	2-10dx1 1/2"		5000s	LSSU2.06	995	9-10d	7-10dx1 1/2"						
	6000s	THAI3522	1600	6-10d	2-10dx1 1/2"		6000s	LSSUI35	995	9-10d	7-10dx1 1/2"						
	6500s	THAI322	1600	6-10d	2-10dx1 1/2"		6500s	LSSUH310	1600	14-10d	7-10dx1 1/2"						
	90s	THAI3522	1600	6-10d	2-10dx1 1/2"		90s	LSSUI35	995	9-10d	7-10dx1 1/2"						
16"	4500s	THAI1.81/22	1715	6-10d	2-10dx1 1/2"	16"	4500s	LSSU410	1625	14-10d	12-10dx1 1/2"						
	5000s	THAI2.06/22	1715	6-10d	2-10dx1 1/2"		5000s	LSSUI25	995	9-10d	7-10dx1 1/2"						
	6000s	THAI3522	1715	6-10d	2-10dx1 1/2"		6000s	LSSU2.06	995	9-10d	7-10dx1 1/2"						
	6500s	THAI322	1715	6-10d	2-10dx1 1/2"		6500s	LSSUI35	995	9-10d	7-10dx1 1/2"						
	90s	THAI422	1715	6-10d	2-10dx1 1/2"		90s	LSSUH310	1600	14-10d	7-10dx1 1/2"						

**SIMPSON**  
Strong-Tie®  
CONNECTORS

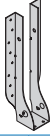
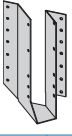
For more information, call Simpson Strong-Tie at 1-800-999-5099 or visit their website at [www.strongtie.com](http://www.strongtie.com)

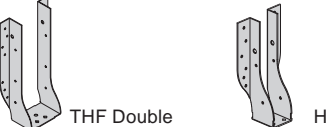
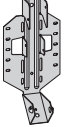
- General Notes**
- **Bold italic hangers require web stiffeners.**
  - Capacities will vary with different nailing criteria and/or support conditions; contact supplier or Simpson Strong-Tie for further information.
  - Capacity values shown are either hanger capacity values (see support requirements below) or BCI® Joist end reaction capacities — whichever is less.
  - All capacity values are downward loads at 100% load duration.
  - Use sloped seat hangers and beveled web stiffeners when BCI® Joist slope exceeds ¼" per foot.
  - Leave 1/16" clearance (1/8" maximum) between the end of the supported joist and the head of the hanger.
  - At max design capacity shown, hangers may exceed standard 1/8" deflection by 1/32".
  - For proper installation of the VPA, the 2-10dx1 1/2" joist nails through the bend tabs must be installed at approximately a 45-degree angle.
- Support Requirements**
- **Support material assumed to be Boise Cascade structural composite lumber or sawn lumber (Douglas fir or southern pine species).**
  - Minimum support width for single- and double-joist top mount hangers is 3".
  - Minimum support width for face mount hangers with 10d and 16d nails is 1 3/4" and 2", respectively.

Single Joist - Top Flange						Single Joist - Face Mount						Face Mount Skewed 45° Joist Hanger					
																	
Joist Depth	BCI®	Hanger	Capacity [lbs]	Nailing		Joist Depth	BCI®	Hanger	Capacity [lbs]	Nailing		Joist Depth	BCI®	Hanger	Capacity [lbs]	Nailing	
				Header	Joist					Header	Joist					Header	Joist
9 1/2"	4500s	THO17950	993	(6) 10d	(2) 10dx1 1/2"	9 1/2"	4500s	THF17925	910	(8) 10d	(2) 10dx1 1/2"	9 1/2"	4500s	SKH1720/L/R	1153	(14) 10d	(10) 10dx1 1/2"
	5000s	TFL2095	993	(6) 10d	(2) 10dx1 1/2"		5000s	THF20925	910	(8) 10d	(2) 10dx1 1/2"		5000s	SKH2020/L/R	1153	(14) 10d	(10) 10dx1 1/2"
	6000s	TFL2395	1225	(6) 10d	(2) 10dx1 1/2"		6000s	THF23925	1275	(12) 10d	(2) 10dx1 1/2"		6000s	SKH2320/L/R	1384	(14) 10d	(10) 10dx1 1/2"
	6500s	TFL2595	1225	(6) 10d	(2) 10dx1 1/2"		6500s	THF26925	1275	(12) 10d	(2) 10dx1 1/2"		6500s	SKH2520/L/R	1384	(14) 10d	(10) 10dx1 1/2"
	90s	THO35118	1589	(10) 10d	(2) 10dx1 1/2"		90s	THF35112	1612	(16) 10d	(2) 10dx1 1/2"		90s	SKH410L/R	1900	(16) 16d	(10) 16d
11 1/8"	4500s	THO17118	1068	(6) 10d	(2) 10dx1 1/2"	11 1/8"	4500s	THF17112	910	(8) 10d	(2) 10dx1 1/2"	11 1/8"	4500s	SKH1720/L/R	1434	(16) 10d	(10) 10dx1 1/2"
	5000s	TFL20118	1068	(6) 10d	(2) 10dx1 1/2"		5000s	THF20112	910	(8) 10d	(2) 10dx1 1/2"		5000s	SKH2020/L/R	1434	(16) 10d	(10) 10dx1 1/2"
	6000s	TFL23118	1237	(6) 10d	(2) 10dx1 1/2"		6000s	THF23118	1300	(14) 10d	(2) 10dx1 1/2"		6000s	SKH2320/L/R	1434	(16) 10d	(10) 10dx1 1/2"
	6500s	TFL25118	1237	(6) 10d	(2) 10dx1 1/2"		6500s	THF26112	1300	(14) 10d	(2) 10dx1 1/2"		6500s	SKH2520/L/R	1434	(16) 10d	(10) 10dx1 1/2"
	90s	THO35118	1589	(10) 10d	(2) 10dx1 1/2"		90s	THF35112	1612	(16) 10d	(2) 10dx1 1/2"		90s	SKH410L/R	1900	(16) 16d	(10) 16d
14"	4500s	TFL1714	1325	(6) 10d	(2) 10dx1 1/2"	14"	4500s	THF17140	1075	(12) 10d	(2) 10dx1 1/2"	14"	4500s	SKH1724/L/R	1562	(16) 10d	(10) 10dx1 1/2"
	5000s	TFL2014	1081	(6) 10d	(2) 10dx1 1/2"		5000s	THF20140	1081	(12) 10d	(2) 10dx1 1/2"		5000s	SKH2024/L/R	1562	(16) 10d	(10) 10dx1 1/2"
	6000s	TFL2314	1262	(6) 10d	(2) 10dx1 1/2"		6000s	THF23140	1350	(18) 10d	(2) 10dx1 1/2"		6000s	SKH2324/L/R	1562	(16) 10d	(10) 10dx1 1/2"
	6500s	TFL2514	1262	(6) 10d	(2) 10dx1 1/2"		6500s	THF26140	1350	(18) 10d	(2) 10dx1 1/2"		6500s	SKH2524/L/R	1562	(16) 10d	(10) 10dx1 1/2"
	90s	THO35140	1625	(12) 10d	(2) 10dx1 1/2"		90s	THF35140	1650	(20) 10d	(2) 10dx1 1/2"		90s	SKH414L/R	2050	(22) 16d	(10) 16d
16"	4500s	TFL1716	1081	(6) 10d	(2) 10dx1 1/2"	16"	4500s	THF17157	1475	(24) 10d	(2) 10dx1 1/2"	16"	4500s	SKH1724/L/R	1690	(16) 10d	(10) 10dx1 1/2"
	5000s	TFL2016	1087	(6) 10d	(2) 10dx1 1/2"		5000s	THF20157	1465	(24) 10d	(2) 10dx1 1/2"		5000s	SKH2024/L/R	1690	(16) 10d	(10) 10dx1 1/2"
	6000s	TFL2316	1268	(6) 10d	(2) 10dx1 1/2"		6000s	THF23160	1362	(22) 10d	(2) 10dx1 1/2"		6000s	SKH2324/L/R	1690	(16) 10d	(10) 10dx1 1/2"
	6500s	TFL2516	1268	(6) 10d	(2) 10dx1 1/2"		6500s	THF26160	1362	(22) 10d	(2) 10dx1 1/2"		6500s	SKH2524/L/R	1690	(16) 10d	(10) 10dx1 1/2"
	90s	THO35160	1660	(12) 10d	(2) 10dx1 1/2"		90s	THF35157	1687	(22) 10d	(2) 10dx1 1/2"		90s	SKH414L/R	2250	(22) 16d	(10) 16d
																	
Joist Depth	BCI®	Hanger	Capacity [lbs]	Nailing		Joist Depth	BCI®	Hanger	Capacity [lbs]	Nailing		Joist Depth	BCI®	Hanger	Capacity [lbs]	Nailing	
				Header	Joist					Header	Joist					Header	Joist
9 1/2"	4500s	THO35950	2050	(10) 10d	(2) 10dx1 1/2"	9 1/2"	4500s	THF35925	1370	(12) 10d	(2) 10dx1 1/2"	9 1/2"	4500s	LSSH179	1140	(10) 10d	(7) 10dx1 1/2"
	5000s	THO20950-2	2330	(10) 16d	(6) 10d		5000s	THF20925-2	1390	(12) 10d	(6) 10d		5000s	LSSH20	1140	(10) 10d	(7) 10dx1 1/2"
	6000s	THO23950-2	2825	(10) 16d	(6) 10d		6000s	THF23925-2	1625	(14) 10d	(6) 10d		6000s	LSSH23	1140	(10) 10d	(7) 10dx1 1/2"
	6500s	THO25950-2	2825	(10) 16d	(6) 10d		6500s	THF25925-2	1390	(12) 10d	(6) 10d		6500s	LSSH25	1412	(10) 10d	(7) 10dx1 1/2"
	90s	THO35118	2050	(10) 10d	(2) 10dx1 1/2"		90s	THF35112	1825	(16) 10d	(2) 10dx1 1/2"		90s	LSSH179	1140	(10) 10d	(7) 10dx1 1/2"
11 1/8"	4500s	THO20118-2	2330	(10) 16d	(6) 10d	11 1/8"	4500s	THF20112-2	1855	(16) 10d	(6) 10d	11 1/8"	4500s	LSSH20	1140	(10) 10d	(7) 10dx1 1/2"
	6000s	THO23118-2	2925	(10) 16d	(6) 10d		6000s	THF23118-2	1855	(16) 10d	(6) 10d		6000s	LSSH23	1140	(10) 10d	(7) 10dx1 1/2"
	6500s	THO25118-2	2925	(10) 16d	(6) 10d		6500s	THF25118-2	1855	(16) 10d	(6) 10d		6500s	LSSH25	1140	(10) 10d	(7) 10dx1 1/2"
	90s	THO35118	2050	(10) 10d	(2) 10dx1 1/2"		90s	THF35112	1825	(16) 10d	(2) 10dx1 1/2"		90s	LSSH179	1140	(10) 10d	(7) 10dx1 1/2"
	90s	BPH71118	3455	(10) 16d	(6) 10d		90s	HD7120	2255	(16) 16d	(6) 10d		90s	LSSH23	1140	(14) 16d	(12) 10dx1 1/2"
14"	4500s	THO35140	2315	(12) 10d	(2) 10dx1 1/2"	14"	4500s	THF35140	2320	(16) 10d	(2) 10dx1 1/2"	14"	4500s	LSSH23	1140	(10) 10d	(7) 10dx1 1/2"
	5000s	THO20140-2	2330	(10) 16d	(6) 10d		5000s	THF20140-2	2320	(20) 10d	(6) 10d		5000s	LSSH20	1140	(10) 10d	(7) 10dx1 1/2"
	6000s	THO23140-2	3350	(12) 16d	(6) 10d		6000s	THF23140-2	2540	(20) 10d	(6) 10d		6000s	LSSH23	1140	(10) 10d	(7) 10dx1 1/2"
	6500s	THO25140-2	3350	(12) 16d	(6) 10d		6500s	THF25140-2	2500	(20) 10d	(6) 10d		6500s	LSSH25	1675	(10) 10d	(7) 10dx1 1/2"
	90s	THO35140	2315	(12) 10d	(2) 10dx1 1/2"		90s	THF35140	2320	(16) 10d	(2) 10dx1 1/2"		90s	LSSH23	1140	(14) 16d	(12) 10dx1 1/2"
16"	4500s	THO35160	3455	(10) 16d	(6) 10d	16"	4500s	THF17157-2	2425	(22) 10d	(2) 10dx1 1/2"	16"	4500s	LSSH179	1140	(10) 10d	(7) 10dx1 1/2"
	5000s	THO20160-2	2330	(10) 16d	(6) 10d		5000s	THF20157-2	2425	(22) 10d	(2) 10dx1 1/2"		5000s	LSSH20	1140	(10) 10d	(7) 10dx1 1/2"
	6000s	THO23160-2	3137	(12) 16d	(6) 10d		6000s	THF23160-2	3050	(24) 10d	(6) 10d		6000s	LSSH23	1140	(10) 10d	(7) 10dx1 1/2"
	6500s	THO25160-2	3137	(12) 16d	(6) 10d		6500s	THF25160-2	3000	(24) 10d	(6) 10d		6500s	LSSH25	1825	(10) 10d	(7) 10dx1 1/2"
	90s	THO35160	3455	(12) 16d	(6) 10d		90s	THF35160	3050	(24) 10d	(6) 10d		90s	LSSH23	1140	(14) 16d	(12) 10dx1 1/2"
																	
Joist Depth	BCI®	Hanger	Capacity [lbs]	Nailing		Joist Depth	BCI®	Hanger	Capacity [lbs]	Fastener		Joist Depth	BCI®	Hanger	Capacity [lbs]	Fastener	
				Header	Joist					Top Plate	Rafter					Top Plate	Rafter
9 1/2"	4500s	---	-	-	-	9 1/2"	4500s	TMP175	1125	(6) 10d	(4) 10dx1 1/2"	9 1/2"	4500s	TMP175	1150	(6) 10d	(4) 10dx1 1/2"
	5000s	---	-	-	-		5000s	TMP21	1125	(6) 10d	(4) 10dx1 1/2"		5000s	TMP21	1290	(6) 10d	(4) 10dx1 1/2"
	6000s	---	-	-	-		6000s	TMP23	1375	(6) 10d	(4) 10dx1 1/2"		6000s	TMP23	1425	(6) 10d	(4) 10dx1 1/2"
	6500s	---	-	-	-		6500s	TMP25	1375	(6) 10d	(4) 10dx1 1/2"		6500s	TMP25	1425	(6) 10d	(4) 10dx1 1/2"
	90s	---	-	-	-		90s	TMP4	1800	(6) 10d	(4) 10dx1 1/2"		90s	TMP4	1850	(6) 10d	(4) 10dx1 1/2"
11 1/8"	4500s	---	-	-	-	11 1/8"	4500s	TMP175	1150	(6) 10d	(4) 10dx1 1/2"	11 1/8"	4500s	TMP175	1150	(6) 10d	(4) 10dx1 1/2"
	6000s	MSH2322	1431	(6) 10d	(4) 10dx1 1/2"		6000s	TMP23	1425	(6) 10d	(4) 10dx1 1/2"		6000s	TMP23	1425	(6) 10d	(4) 10dx1 1/2"
	6500s	MSH322	1431	(6) 10d	(4) 10dx1 1/2"		6500s	TMP25	1425	(6) 10d	(4) 10dx1 1/2"		6500s	TMP25	1425	(6) 10d	(4) 10dx1 1/2"
	90s	MSH422	1862	(6) 10d	(4) 10d		90s	TMP4	1800	(6) 10d	(4) 10dx1 1/2"		90s	TMP4	1850	(6) 10d	(4) 10dx1 1/2"
	90s	MSH1722	1550	(6) 10d	(4) 10dx1 1/2"		90s	TMP4	1850	(6) 10d	(4) 10dx1 1/2"		90s	TMP4	1900	(6) 10d	(4) 10dx1 1/2"
14"	4500s	---	-	-	-	14"	4500s	TMP175	1150	(6) 10d	(4) 10dx1 1/2"	14"	4500s	TMP175	1150	(6) 10d	(4) 10dx1 1/2"
	5000s	MSH2322	1550	(6) 10d	(4) 10dx1 1/2"		5000s	TMP21	1290	(6) 10d	(4) 10dx1 1/2"		5000s	TMP21	1290	(6) 10d	(4) 10dx1 1/2"
	6500s	MSH322	1550	(6) 10d	(4) 10dx1 1/2"		6500s	TMP23	1525	(6) 10d	(4) 10dx1 1/2"		6500s	TMP23	1525	(6) 10d	(4) 10dx1 1/2"
	6000s	MSH322	1550	(6) 10d	(4) 10dx1 1/2"		6000s	TMP25	1525	(6) 10d	(4) 10dx1 1/2"		6000s	TMP25	1550	(6) 10d	(4) 10dx1 1/2"
	90s	MSH322	1550	(6) 10d	(4) 10dx1 1/2"		90s	TMP4	1850	(6) 10d	(4) 10dx1 1/2"		90s	TMP4	1850	(6) 10d	(4) 10dx1 1/2"
16"	4500s	---	-	-	-	16"	4500s	TMP175	1150	(6) 10d	(4) 10dx1 1/2"	16"	4500s	TMP175	1150	(6) 10d	(4) 10dx1 1/2"
	5000s	---	-	-	-		5000s	TMP21	1290	(6) 10d	(4) 10dx1 1/2"		5000s				

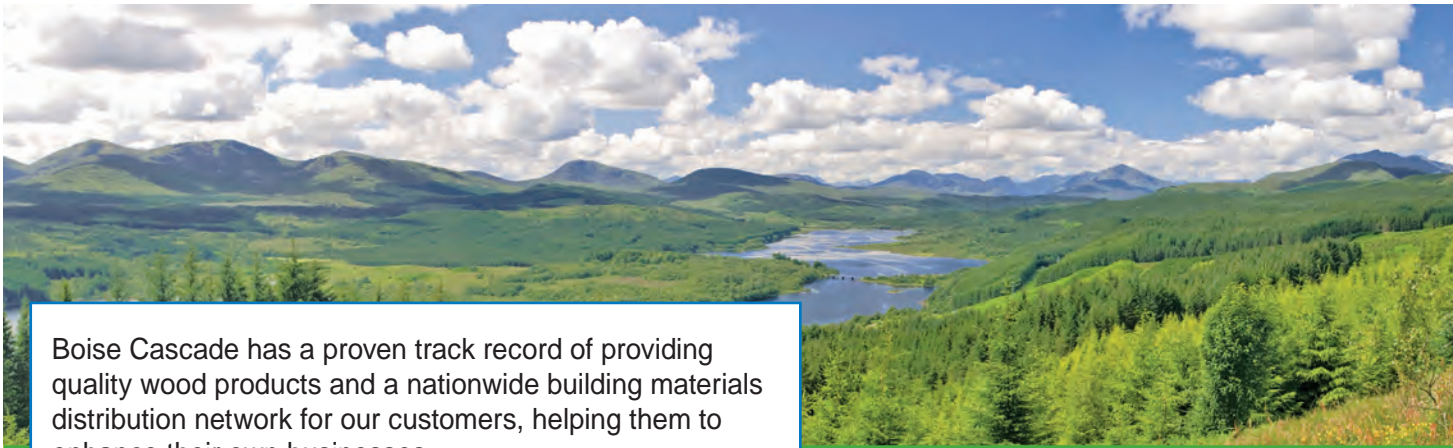

Boise Cascade has a proven track record of providing quality wood products and a nationwide building materials distribution network for our customers, helping them to enhance their own businesses.

Boise Cascade Engineered Wood Products build better homes with stronger, stiffer floors using only wood purchased in compliance with a number of green building programs. Take a moment to view our sustainability certification site at <http://www.bc.com/sustainability/certification-audits/> or view our green brochure at [www.bc.com/inst11](http://www.bc.com/inst11).

Boise Cascade Engineered Wood Products throughout North America can now be ordered FSC® Chain-of-Custody (COC) certified, enabling homebuilders to achieve LEED® points under U.S. Green Building Council® residential and commercial green building programs including LEED for Homes and LEED for New Construction. Boise Cascade Engineered Wood Products are available as PEFC® Chain-of-Custody certified, SFI® Chain-of-Custody certified and SFI Fiber-Sourcing certified, as well as NAHB Research Center Green Approved, enabling homebuilders to also obtain green building points through the National Green Building Standard.

### Lifetime Guaranteed Quality and Performance

Boise Cascade warrants its BCI® Joist, VERSA-LAM®, and ALLJOIST® products to comply with our specifications, to be free from defects in material and workmanship, and to meet or exceed our performance specifications for the normal and expected life of the structure when correctly stored, installed and used according to our Installation Guide.

If in doubt, ask!  
For the closest  
Boise Cascade EWP  
distributor/support center,  
call

★1-800-232-0788★



BOISE CASCADE, TREE-IN-A-CIRCLE, BCI, BC CALC, BC COLUMN, BC FRAMER, BOISE CASCADE RIM BOARD, BOISE GLULAM, SIMPLE FRAMING SYSTEM, VERSA-LAM, VERSA-RIM, VERSA-STRAND, and VERSA-STUD are trademarks of Boise Cascade Company or its affiliates.

For information about  
Boise Cascade Engineered Wood Products,  
including sales terms and conditions,  
warranties and disclaimers,  
visit our website at [www.BCewp.com](http://www.BCewp.com)

Your Dealer is:

If no dealer is listed, call 1-800-232-0788



**Boise Cascade**  
Engineered Wood Products

*Great products are only the beginning.®*