



EVERGREEN® Pro

Easy heat, Effortless comfort

DURABLE

Stainless steel fire tube
heat exchanger

FLEXIBLE

24-zone capacity
Floor standing/wall mount

EASY

Control presets
Accessible parts

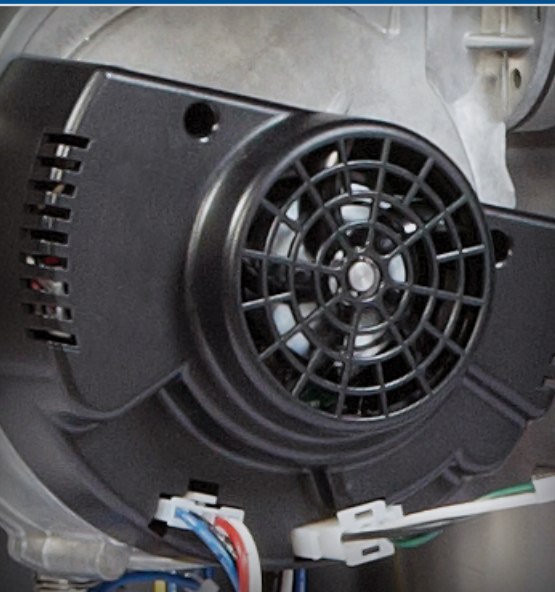
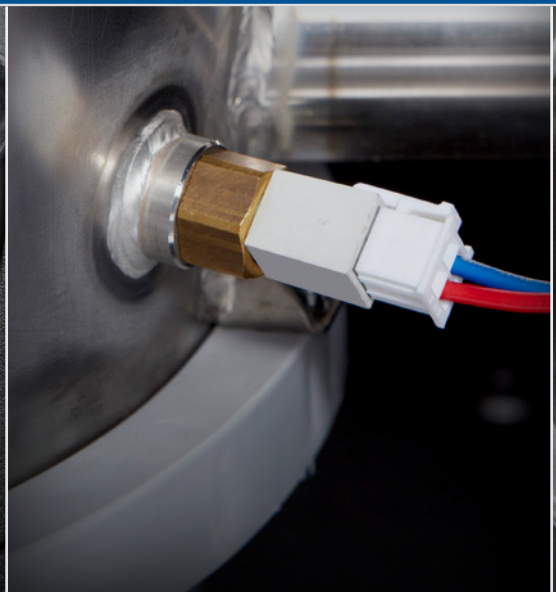

*Evergreen Pro 399 rating is combustion efficiency

The new Evergreen® Pro boiler extends comfort levels to every area of your property for the long run. The Evergreen Pro is perfect for light commercial applications, and single or multi-boiler installations.

APPEALS TO YOUR CUSTOMER, THE COMMERCIAL BUILDING OWNER

- Reduced ownership cost by being energy efficient, energy optimized and environmentally friendly
 - 96.5% combustion efficiency
 - SmartSequencing® – balanced energy load across all system boilers
 - Low NOx < 20PPM certified
 - Ease of maintenance means no high cost maintenance contract
 - Features a durable, commercial grade heat exchanger; reliable and long lasting
 - Qualifies for utility rebates
- Provides better comfort, with controls that provide exactly as much heat as is required
- Wall or floor mount saves space
- Sleek, visually pleasing design adds value to the property

PROVIDES A SOLUTION FOR SMALL TO MEDIUM SIZED COMMERCIAL PROJECTS

- Quick and easy installation keeps project costs low
 - Arrives completely built and factory tested, no jobsite assembly required
 - Compact size and shape makes it easy to maneuver into tight installations; eliminates need for extra rigging
 - Simple to use setup wizard with guided installation
- Available for quick delivery or emergency replacement
 - In stock for immediate shipment
- Innovative controls with ZoneStacking® up to 24 programmable zones without need for additional panel
- Durable design with a stainless steel heat exchanger and non-metallic condensate base



Stay *effortlessly comfortable* in any environment with the new Evergreen Pro boiler.

The quiet operation of the Evergreen Pro further enhances the sense of “invisible” heat, from pool heating to multiple zones.

- For the property manager who wants heating comfort while maintaining lower utility bills and reducing their carbon footprint, the Evergreen Pro 220 and 299 boilers are recognized as Most Efficient by Energy Star® standards with an AFUE rating of 95%. This could qualify the homeowner for available local utility rebates, if available. The Evergreen Pro provides a Low NOx of < 20 PPM, which adds to the greener environment sustainability.
- The high performance of the Evergreen Pro boiler works seamlessly with the efficient and durable AHRI Certified™ Weil-McLain Aqua Plus® Indirect Fired Water Heater, available in five sizes to meet demanding hot water applications.



*Local and regional utility rebates available in qualifying areas

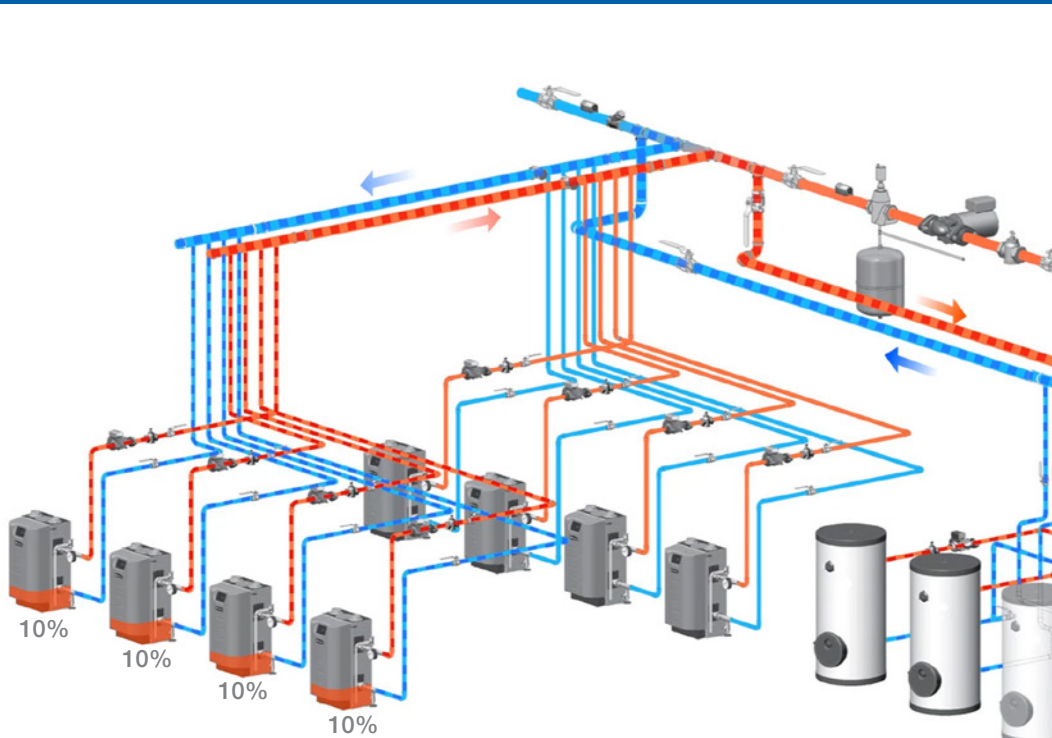

ZONESTACKING®

Enables all zone capabilities of each individual boiler when connected on a cascaded network of boilers. With the Evergreen Pro boiler, the number of programmable zones is three times the number of boilers on the network, up to eight boilers.

COMMERCIAL

Familiar interface - innovative technology

As our technology has advanced to create smoother, more efficient operations, we've kept the interface of the Evergreen Pro boiler familiar, simple to use and easy to learn.

- For the commercial customer who requires a multiple boiler setup, the Evergreen Pro provides **ZoneStacking** - 24 zone capability **without** an additional external 3rd party control.
- **ZoneStacking** reduces the installation costs and time while increasing reliability. With this advanced control feature, the Evergreen Pro boiler maintains optimal efficiency through lead-lag rotation and balanced heat loading.

EASE OF INSTALLATION

- Setup wizard efficiently guides the installer through a single or multiple boiler installation in minutes
- For the contractor, installer and/or service provider, the Evergreen Pro has an easy to understand graphical user Interface and makes programming and monitoring operations simple
- Wiring diagrams provided are clear and easily accessible

EASE OF USE

- Ability to control multiple boilers with lead-lag capability without an external device
- Interactive diagnostic capability
- Reliable operation
- Easy to understand and monitor controls
- Effortless heating and comfort in all zones

EASE OF MAINTENANCE

- Large, accessible panels for quick and easy maintenance checks
- Interactive diagnostic capability provides a snapshot of the past and current operation parameters
- Reliable operation of the complete heating system including radiant elements

MULTIPLE BOILER SEQUENCING

The flexibility of the Evergreen Pro boiler system reduces setup time and keeps costs down.

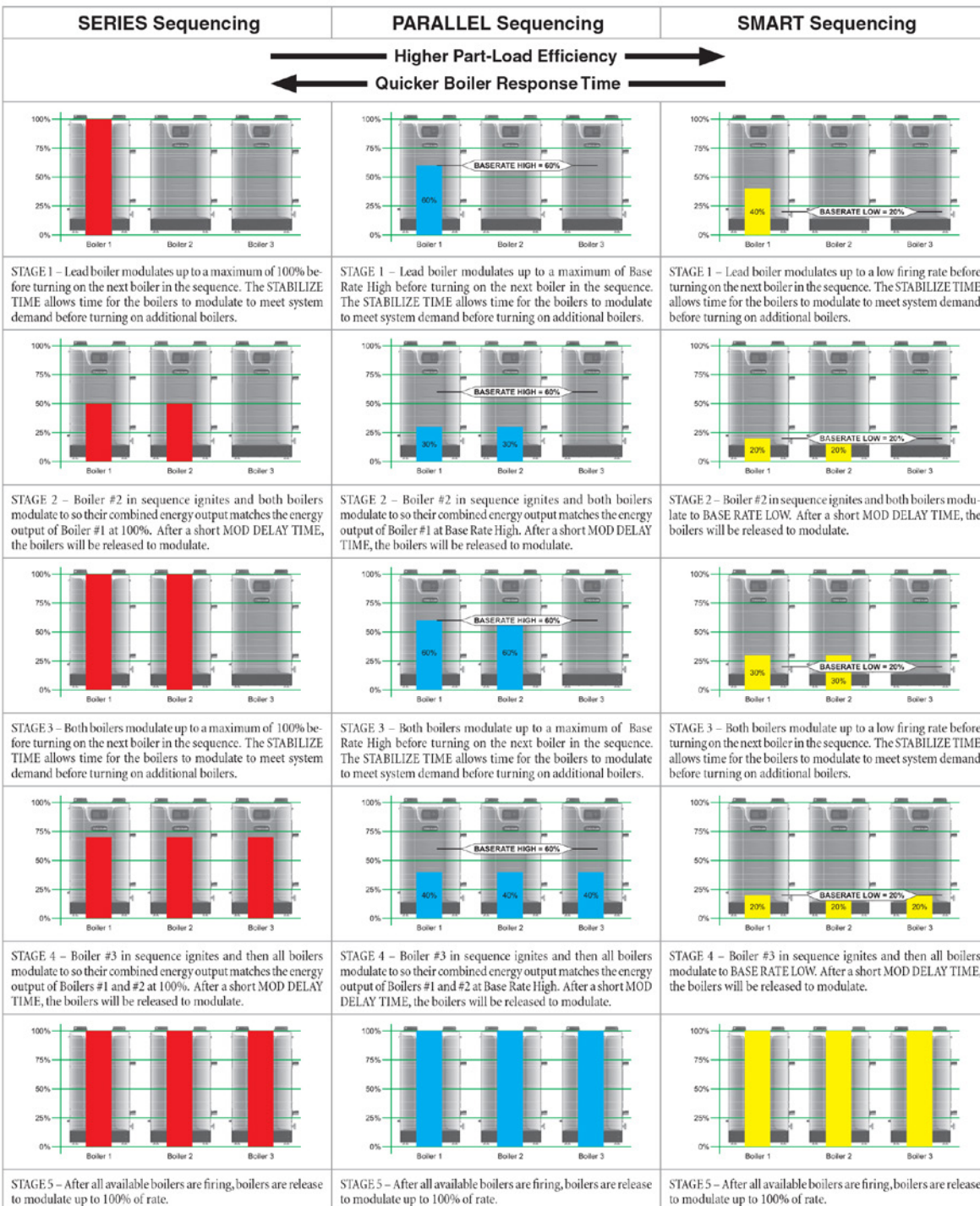

THREE SELECTABLE SEQUENCING MODES TO CHOOSE FROM

- Series Sequencing**
 Quickest- boiler goes to 100% before another boiler is turned on; output is achieved more quickly with less total burner hours
- Parallel Sequencing**
 Efficiency and speed-based on Base Rate High; Hybrid mode between Smart and Series modes; boilers will go to user-programmed base rate high before turning on the next boiler
- SmartSequencing®**
 Most efficient- maximizes part-load efficiency by turning on as many boilers as possible

PROGRAMMABLE PREFERENCES FOR MULTIPLE BOILER SETUPS

- Multiple Boiler Sequencing**
 User selects what point one boiler stops modulating before turning on another boiler
- Lead Lag Rotation**
 User selects which boiler turns on first and can choose based on burner hours, fixed rotation or no rotation
- Input/Output Options**
 Input and outputs can be used for every boiler with up to 24 capable input/output pairs
- Auxiliary Output Flexibility**
 Ability to control system circulators, combustion air dampers and/or other auxiliary system components

SIMPLE INTERFACE — COMPLEX CALCULATIONS

Straightforward, user-friendly design with advanced technology.

What's happening behind the scenes? Complex calculations of the required energy to meet system demands is distributed across all the boilers in the network.

System maximizes user's comfort by simultaneously meeting as many system demands as possible: When there are multiple requests on a cascaded boiler system, the control satisfies both local and network heating demands.

Setup is easy. The built-in wizard asks direct questions on setup, making customization easy and straightforward. Contextual help is also available on screen.



Visual Communication Screens

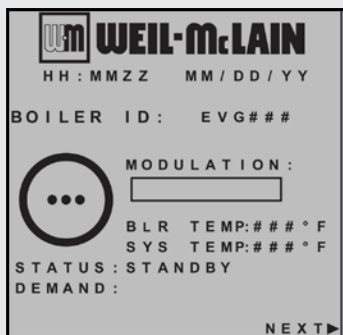

STANDBY

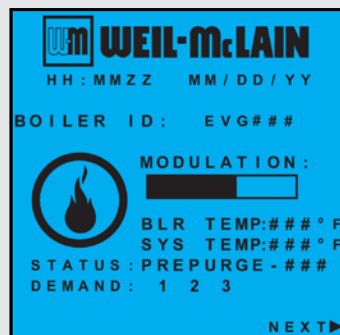

SPACE HEATING

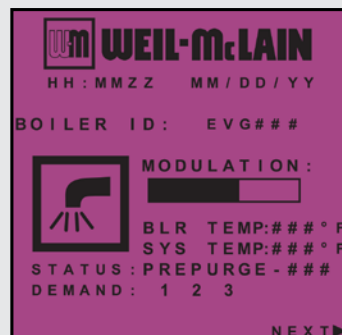

DHW HEATING

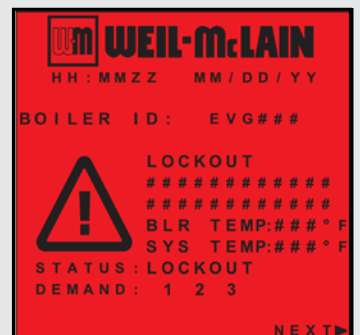

CHECK SYSTEM



*Model 220 and 299 only

FEATURES

BOILER

- Stainless steel fire-tube heat exchanger
- Non-metallic heat exchanger base
- Floor standing or wall-mount option with kit
- Natural or LP gas
- Negative regulated combustion
- 10:1 turndown ratio
- Boiler circulator
- Low water cut-off
- Low NOx < 20 PPM
- 30 PSI ASME relief valve

CONTROL FEATURES

- Easy installation with Setup Wizard
- Zone and/or priority based control
- Three thermostat Inputs
- Outdoor reset for each priority
- Rate adjustable per priority
- 0-10V input (modulation or setpoint)
- Four total outputs
 - 1 dedicated boiler circulator output
 - 3 additional outputs can be used with circulators, dampers, or system aux
- Aux inputs - flow switch or end switch
- Aux outputs - system pump or damper
- Modbus® connectivity
- Additional heat demand contact

BOILER CIRCULATORS

- 1-1/4" & 1-1/2" flanges (220/299) Taco 0014
- 1-1/4" & 1-1/2" flanges (399) Taco 0013

MULTIPLE BOILER FEATURES

- Up to 8 boilers, multiple system
- Series, Parallel, or SmartSequencing®
- Lead boiler rotation
- 2 network priorities for the system
- 2 local priorities per boiler
- 24 zone inputs and outputs with 8 total cascaded boilers
- Aux inputs - flow switch or end switch
- System aux outputs - system pump or damper

VENTING*

- Direct vent 100 ft. for intake and 100 ft. for vent
- Dual pressure zones (sidewall air intake, roof vent)
- Common combustion air
- Direct Exhaust

JACKET ASSEMBLY

- Easy maintenance with top access panel
- Fully removable jacket front door
- Adjustable boiler legs
- On/off power switch
- Line voltage service receptacle
- Mounting bracket ready for wall-mount kit
- Condensate trap

OPTIONAL EQUIPMENT

- Wall-mount kit
- Concentric vent kit
- Condensate neutralizer kit
- Sidewall vent/air termination kit
- Maintenance & parts kits
- 80 PSI ASME relief valve
- Propane conversion kit
- Sentinel X100 inhibitor and test kit
- Prefab manifold kit



220-399 MBH SPECIFICATIONS

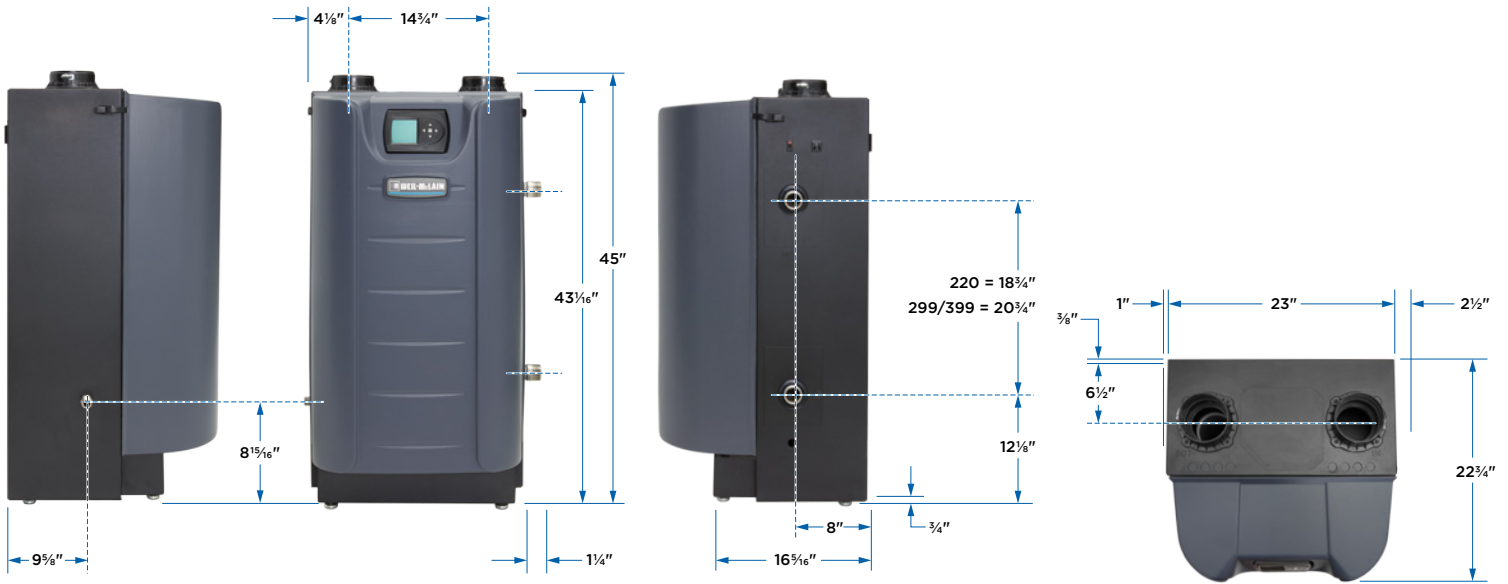

MODEL	CSA INPUT (MBH)	DOE HEATING CAPACITY (MBH)	NET A-HR1 (MBH)	DOE AFUE	VENT MATERIAL	VENT SIZE	COMBUSTION AIR SIZE	VENTING LENGTH	MIN. RECOMMENDED PIPE SIZE	SUPPLY/ RETURN TAPPING	GAS CONNECTION SIZE	APPROX. SHIP WEIGHT	WATER VOLUME
EVG 220	220	206	179	95.0%	PVC, CPVC, PP, SS (AL29-4C)	3" or 4"	3" or 4"	100'	1 1/4"	1 1/2"	3/4"	215 lbs.	4.6 Gal.
EVG 299	299	280	243	95.0%	PVC, CPVC, PP, SS (AL29-4C)	4"	4"	100'	1 1/2"	1 1/2"	3/4"	260 lbs.	7.0 Gal.
EVG 399	399	383*	333	96.5%*	PVC, CPVC, PP, SS (AL29-4C)	4"	4"	100'	1 1/2"	1 1/2"	3/4"	260 lbs.	6.7 Gal.

*Evergreen Pro 399 ratings are gross output and combustion efficiency



INNOVATIVE CONTROL SYSTEM FEATURES

- 3 programmable priorities for up to three heat inputs
- Text display for easy operation monitoring and diagnostics
- 0-10 VDC input modulation
- Additional heat demand contact for hybrid system
- Integrated low water protection
- Dual temperature sensors on boiler outlet and flue
- Blower speed modulation

Contact your local Weil-McLain sales office for more information.

NEW ENGLAND

250 Richmond Street
Raynham, MA 02767
TEL: 508-822-3939
FAX: 508-822-0553

CENTRAL AND WESTERN

999 McClintock Drive
Suite 200
Burr Ridge, IL 60527
TEL: 630-560-3738
FAX: 855-248-2777
Toll Free: 800-854-5482

ADMINISTRATIVE OFFICE

999 McClintock Drive
Suite 200
Burr Ridge, IL 60527
TEL: 630-560-3700
FAX: 630-560-3769

Weil-McLain® is a leading North American designer and manufacturer of hydronic comfort heating systems for residential, commercial and institutional buildings since 1881. Weil-McLain has manufacturing facilities in Michigan City, Indiana and Eden, North Carolina, along with regional sales offices throughout the United States and an administrative office in Burr Ridge, Illinois. Building on a reputation of quality and innovation, Weil-McLain is committed to creating Simplified Solutions for our Complex World.™

Architects, engineers, contractors, facility managers and homeowners alike rely on Weil-McLain for their comfort heating needs. Installed in homes, offices, schools, restaurants, hotels and other facilities throughout North America, the Weil-McLain brand is among the most respected and often used in the building industry.

Weil-McLain hydronic boilers and indirect-fired water heaters integrate the latest in advanced controls and materials including cast iron, stainless steel and aluminum heat exchanger technologies. The reliability and energy efficiency of our products has helped to make Weil-McLain industry leaders. Products are engineered with aesthetics, functionality, safety and structural tolerance in mind. By combining our expertise with the responsiveness of our support operations, we provide our customers with added value and peace of mind.



Weil-McLain.com