



*Powering Business Worldwide*

Maintenance Bypass Switches

6M1004Rev 7

Issue Date: 20/04/2010

# User and Installers Guide - Hardwired Maintenance Bypass Switches To Suit Eaton UPS

A decorative horizontal line with a wavy, undulating pattern, rendered in a light gray color with a subtle gradient and a slight shadow effect, spanning across the width of the page.

[www.eaton.com/powerquality](http://www.eaton.com/powerquality)

6M1004Rev7

## TABLE OF CONTENTS

1.0 Important Safety Notices .....	2
2.0 Introduction .....	2
3.0 Description of Operation .....	3
4.0 Installation .....	5
5.0 Inverter Interlock Types .....	7
6.0 Wiring Diagram Selection .....	7
7.0 Troubleshooting.....	9

## LIST OF FIGURES

Figure 1. MBS in “Off” position .....	3
Figure 2. MBS in “Normal” Position .....	3
Figure 3. MBS in “Test” Position.....	3
Figure 4. MBS in “Bypass” position .....	4
Figure 5. MBB Type MBS with Inverter Interlock .....	5
Figure 6: Identifying MBS Part number .....	7
Figure 7: Identifying UPS Part number .....	7

## LIST OF TABLES

Table 1: Inverter Interlock Contact types for various Eaton UPS models.....	7
Table 2: Wiring Diagram Selection Table.....	8

Congratulations on the purchase of your Eaton Maintenance Bypass Switch (MBS). This switch has been specifically designed to operate in conjunction with your Eaton UPS, ensuring seamless operation of your critical load during maintenance and testing, or during the unlikely event of a UPS failure.

Please take the time to read these instructions carefully, and ensure they are on hand at all times.

## **1.0 Important Safety Notices**



### **CAUTION**

UPS units are capable of supplying dangerous voltages even when turned off. Before attempting to install this MBS the UPS must be completely switched off and removed from supply, battery isolated (where appropriate), and mains supply isolated.

Eaton Maintenance Bypass Switches must be installed by qualified and trained electricians, strictly in accordance with Australian standards and these instructions.

**Failure to properly install and test the Maintenance Bypass Switch may result in severe damage to your UPS or load equipment.**

## **2.0 Introduction**

The purpose of a Maintenance Bypass Switch is to isolate all AC input and output supplies from a UPS to allow maintenance technicians to safely work on the UPS, while the critical load equipment continues to be powered from the input supply, normally raw mains.

DC supplies and batteries are not disconnected by the MBS as they are fitted with their own specialised isolators.

In addition to the normal bypass function described above, all Eaton MBS have a “Test” position which allows a Maintenance Technician to apply power to the UPS for test purposes without disturbing the critical load equipment, while it continues to be fed from raw mains. The MBS also has an “Off” position which provides the isolation function required by AS3000 Clause 4.8.4.3.1.

All Maintenance Bypass Switches feature an electrical/mechanical pushbutton interlock to prevent UPS damage due to improper switch operation.

### 3.0 Description of Operation

Eaton Maintenance Bypass Switches feature 4 positions, at the 10 O'clock, 12 O'clock, 2 O'clock, and 4 O'clock positions. The function of each position is described below.

**Note:** Figures 1-4 are for descriptive purposes only, for specific wiring, please refer to the relevant wiring diagram at the back of the manual.

**“Off.”**

In the “Off” position the AC Mains supply, UPS, and critical load equipment are all isolated from each other. In other words all equipment is off. (See Figure 1.)

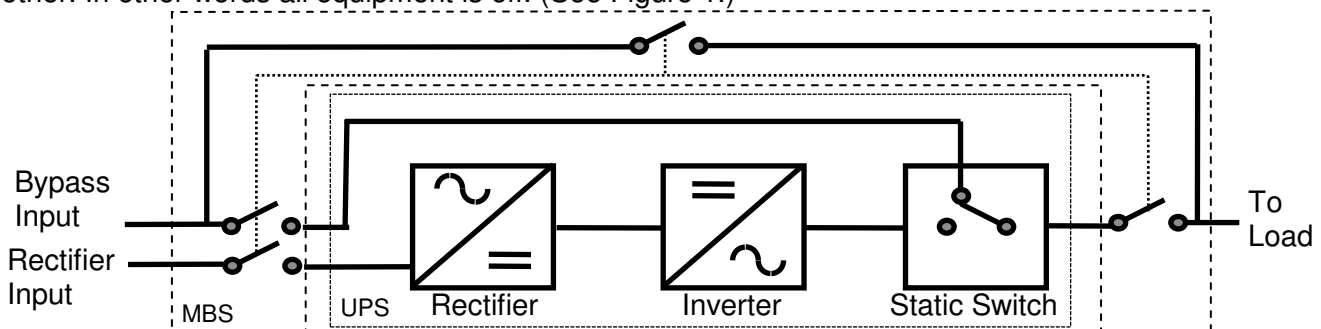

Figure 1. MBS in “Off” position

**“Normal”**

In the “Normal” position the UPS is fed from the AC Mains supply and the critical load equipment is fed from the output of the UPS. In this position the critical load is protected by the UPS (See Figure 2.)

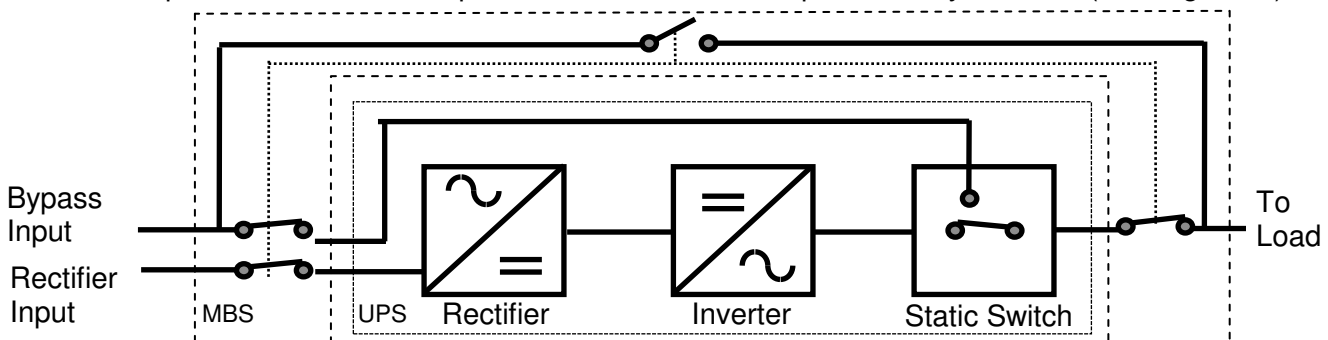

Figure 2. MBS in “Normal” Position

**“Test ”**

The “Test” position connects the load equipment directly to raw AC Mains supply. AC input power continues to be fed to the UPS to facilitate UPS testing. The output of the UPS is disconnected from the load equipment. The critical load is no longer protected by the UPS. (See Figure 3.)

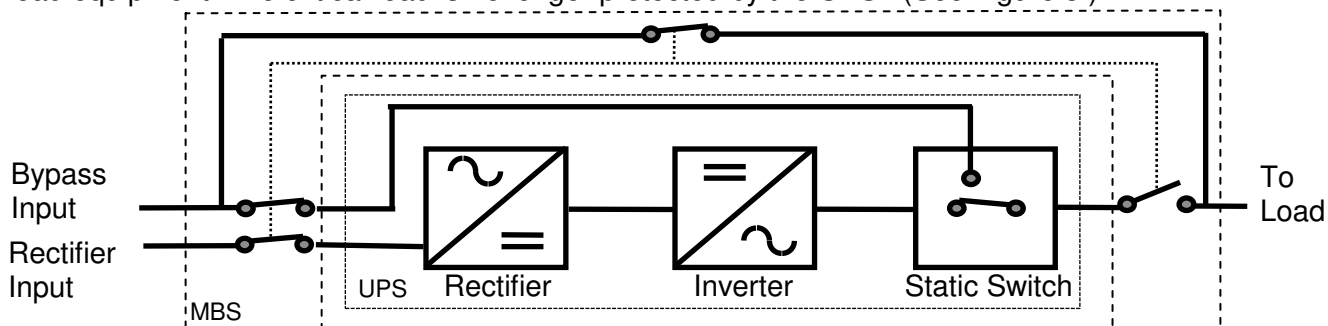

Figure 3. MBS in “Test” Position

### 3.0 Description of Operation (cont.)

#### “Bypass”

The “Bypass” position connects the load equipment directly to raw AC Mains supply. AC input power is disconnected from the UPS to facilitate maintenance or component replacement. The critical load is not protected by the UPS. In this position the entire UPS can be removed or replaced without disturbing the load equipment. (See Figure 4.)

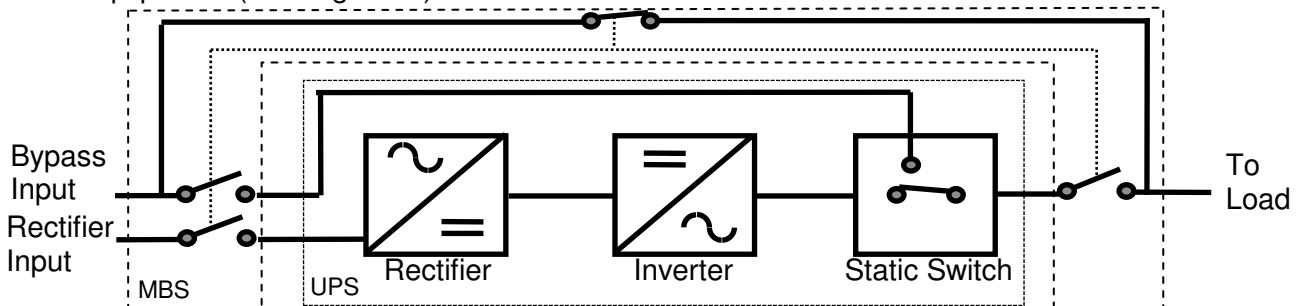

Figure 4. MBS in “Bypass” position



**Note:** Figures 1-4 show MBS with Separate Bypass Inputs. For MBS without Separate Bypass Inputs, the UPS Rectifier Input terminal is tied to the UPS Bypass Input terminal. For further clarification refer to the relevant wiring diagram in Appendix A.

Eaton Maintenance Bypass Switches are a **Make Before Break** type switch, or **MBB** for short.

This type of switch provides continuity of supply to the load when switching between all positions except “Off”. Load supply continuity is achieved by overlapping the opening and closing of input and output switch contacts when switching between positions. This means that the input supply voltage and output supply are connected together momentarily when switching between the adjacent “Normal” and “Test” positions. When used on a double conversion type UPS the inverter must be off and the load fed from the UPS bypass, or inverter damage is highly probable.

All Eaton MBS feature an interlock to ensure the inverter is turned off automatically before the MBS can be moved between positions. This interlock takes the form of a pushbutton integral to the switch assembly. Depending on which model UPS you have, either a normally open or closed contact on the rear of the pushbutton is connected to the inverter control circuits to allow normal operation while the pushbutton is in the released position (see Sec. 5: Table 1 for type of Inverter Interlock).

The red pushbutton is also mechanically interlocked to the MBS to prevent the switch being physically moved between positions accidentally. When it is desired to change the mode of the MBS the pushbutton must be depressed to release the mechanical interlock. Depressing the pushbutton causes the normally open/closed contact (see Sec. 5: Table 1) connected to the inverter control circuit to toggle positions, causing the inverter to turn off and the critical load to be fed from the UPS bypass.

A keylock can be substituted for the pushbutton interlock at the time of purchase. This option is specified by adding the suffix “KL” to the switch part number.

The different functional positions of the MBB type switches are shown in Figure 5 (see overleaf).

## 4.0 Installation

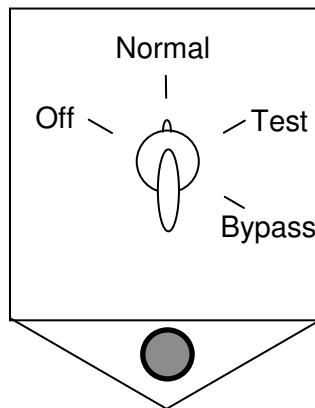

**Figure 5. MBB Type MBS with Inverter Interlock  
(shown in “Normal” Position)**

Eaton MBS are supplied loose for installation by a licensed electrician. They are rear mounted and are enclosed in metal enclosures providing a degree of protection of IP40 or better. The enclosures are intended for wall mounting via keyhole slots provided. Cable entry knockouts are provided for glanding incoming cables.

Inverter interlock circuits must be wired in 240 VAC rated two-core screened cable of minimum size 1 mm<sup>2</sup>. This cable must be run with a minimum spacing of 50 mm from all AC mains cabling.

**Note:** For 3Ø to 1Ø no separate bypass (MBS31-NSB-XX-BW) switches, the incoming 3Ø feed cables must each be rated for the total UPS single phase bypass current.

### 4.1 Installation Procedure:

1. Mount the MBS enclosure in a suitable location for safe and convenient operation, adjacent to the UPS. Issues to consider are operator access and visibility and convenience for cabling.
2. Refer to Section 5: Inverter Interlock Types for your Inverter Interlock connection. Refer to Table 2 (on page 8) for the appropriate connection diagram.
3. Remove the gland plate and knockout cable entries that suit your cable glands.
4. Gland and connect cables in accordance with the connection diagram on Table 2: Selection Table. Connection points inside the enclosure are labelled as per the appropriate Connection Drawing.
5. Connect the Earth conductors to the Earth studs on the gland plate. The MBS enclosure will provide Earth continuity, however this **must** be tested.
6. Identify the correct operation label from Table 2 on page 8 and affix to the MBS front panel.

## **4.0 Installation (cont.)**

### **4.2 Test Procedure:**

 **NOTE:**

We strongly recommend that a dummy load be used to commission and confirm correct operation of the MBS before placing it into service. At all stages in the commissioning the output to the load should be monitored to confirm correct phase, voltage and polarity during MBS transfer operations.

Eaton will accept no responsibility for any damage or loss resulting from an incorrectly installed MBS. Functional tests should be performed in addition to the tests required by AS3000:2000, Wiring Rules.

Our service department can provide commissioning and functional testing services by factory trained service technicians, and it is strongly recommended that you avail yourself of this service.



**The Red Button must be pushed before the MBS switch can be rotated.**

1. Depress and hold the Red Button, then rotate the MBS switch to the “Bypass” position and apply input power supply. This will allow the critical load to be tested with raw AC power.
2. Place the bypass switch into the “Test” position. The UPS can now be started in accordance with the UPS User’s Manual.
3. Check the Inverter Interlock function by depressing and holding down the Red Button on the front of the MBS. NOTE: Do not rotate the switch. Observe the operation of the UPS. ***The UPS must transfer from Normal Mode to Bypass Mode.***



**IF THE UPS DOES NOT TRANSFER TO BYPASS MODE DO NOT PROCEED FURTHER. CONTACT YOUR LOCAL EATON SERVICE REPRESENTATIVE.**

4. If the correct Inverter Interlock function is confirmed as per Step 3, the UPS can then be used to support the critical load by depressing and holding the Red Button, and rotating the MBS switch to the “Normal” position then releasing the Red Button. The UPS will revert automatically to “Normal Mode”.
5. The UPS should now operate normally and will support the critical load. Please refer to the relevant UPS manual for information on how to confirm correct UPS operation.

## 5.0 Inverter Interlock Types

UPS	Inverter Interlock Contact Type
PB1000	Normally Closed
PB4000	Normally Open
PW9120	Normally Closed
PW9155S/N	Normally Open
PW9170	Normally Open
PW9305	Normally Open
PW9340	Normally Open
PW9355	Normally Open
PW9390	Normally Open

Table 1: Inverter Interlock Contact types for various Eaton UPS models.

## 6.0 Wiring Diagram Selection

### STEP ONE:

Identify your MBS unit by its part number:

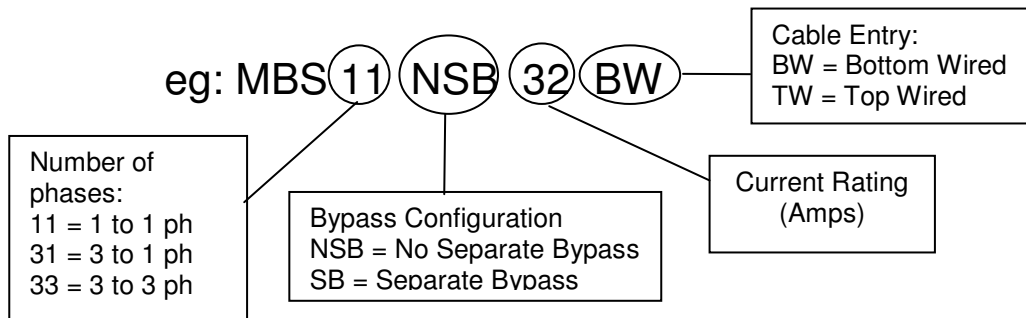

Figure 6: Identifying MBS Part number

### STEP TWO:

Identify your UPS model by the model number located on the rating label on your UPS.

Eg:

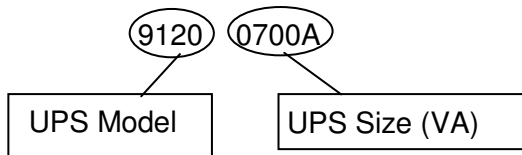

Figure 7: Identifying UPS Part number

### STEP THREE:

From Table 2 overleaf, locate your MBS and UPS combination, and select the wiring diagram and operating instructions labels to suit.



**WIRING DIAGRAM SELECTION TABLE:**

MBS	UPS Type	Wiring Diagram	Page	Operating Label # (included with unit)
<b>1Ø to 1Ø no separate bypass</b>				
MBS11-NSB-XX-BW	9120	A4D0219R2	A1	A4L0136
MBS11-NSB-XX-BW	9155S	A4D0230R1	A2	A4L0169
MBS11-NSB-XX-BW	9170	A4D0231R0	A3	A4L0170
<b>1Ø to 1Ø with separate bypass</b>				
MBS11-SB-XX-BW	9120	A4D0218R4	A4	A4L0136
MBS11-SB-XX-BW	9155S	A4D0229R2	A5	A4L0169
<b>3Ø to 1Ø no separate bypass <sup>(3)</sup></b>				
MBS31-NSB-XX-BW	9155N	A4D0224R1	A6	A4L0169
MBS31-NSB-XX-BW	PB1000	A4D0263R1	A7	A4L0169
<b>3Ø to 1Ø with separate bypass</b>				
MBS31-SB-XX-BW	9155N	A4D0213R2	A8	A4L0169
MBS31-SB-XX-BW	PB1000	A4D0264R1	A9	A4L0169
<b>3Ø to 3Ø no separate bypass</b>				
MBS33-NSB-XX-BW	9305	A4D0249R0	A10	A4L0169
MBS33-NSB-XX-BW	9340	A4D0250R0	A11	A4L0169
MBS33-NSB-XX-BW	9355	A4D0251R1	A12	A4L0169
MBS33-NSB-XX-BW	9390	A4D0261R3	A13	A4L0169
MBS33-NSB-XX-BW	PB4000	A4D0252R1	A14	A4L0169
<b>3Ø to 3Ø with separate bypass</b>				
MBS33-SB-XX-BW	9305	A4D0225R3	A15	A4L0169
MBS33-SB-XX-BW	9340	A4D0246R1	A16	A4L0169
MBS33-SB-XX-BW	9355	A4D0247R2	A17	A4L0169
MBS33-SB-XX-BW	9390	A4D0262R3	A18	A4L0169
MBS33-SB-XX-BW	PB4000	A4D0248R2	A19	A4L0169
<b>1Ø to 1Ø Tail End bypass switch</b>				
MBS11-TE-XX-BW	GENERIC	A4D0321R0	A20	A4L0153A
<b>3Ø to 3Ø Tail End bypass switch</b>				
MBS33-TE-XX-BW	GENERIC	A4D0319R1	A21	A4L0153A

**Table 2: Wiring Diagram & Operating Label Selection Table**

Notes:

- 1) XX = Maximum MBS current rating
- 2) Suffix "BW" means Bottom Wired, "TW" means Top Wired. Labels and connection drawings are identical for each type.
- 3) For 3Ø to 1Ø no separate bypass, refer to 4.0 Installation, for notes on cable sizing.

## **7.0 Troubleshooting**

If you have a question or problem, or need assistance please contact Eaton Services on 1300 303 059, or contact your local Eaton Customer Service office.

### **Eaton Services NATIONAL SERVICE Phone 1300 303 059**

When calling please specify:

1. Part Number of MBS and UPS.
2. Serial Number of the unit.
3. Original Date of Purchase of the Maintenance Bypass Switch.

Parts, orders and all correspondence regarding repairs under the warranty should be addressed to Eaton Service Department at the address below, or to the service depot address advised by our Service staff.

### **Eaton Industries Pty Ltd**

ABN 66 103 014 571

**Office:** 4 Caribbean Drive. Scoresby, Victoria 3179

Phone: 03-9839 1144      Fax: 03-9839 1177

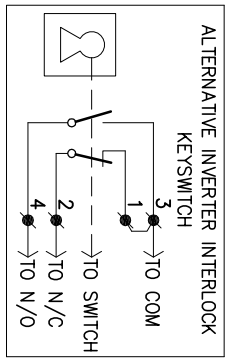

ALL LINKS INSIDE DOTTED LINE ARE PROVIDED WITH THE BYPASS SWITCH  
**DO NOT REMOVE THEM !**

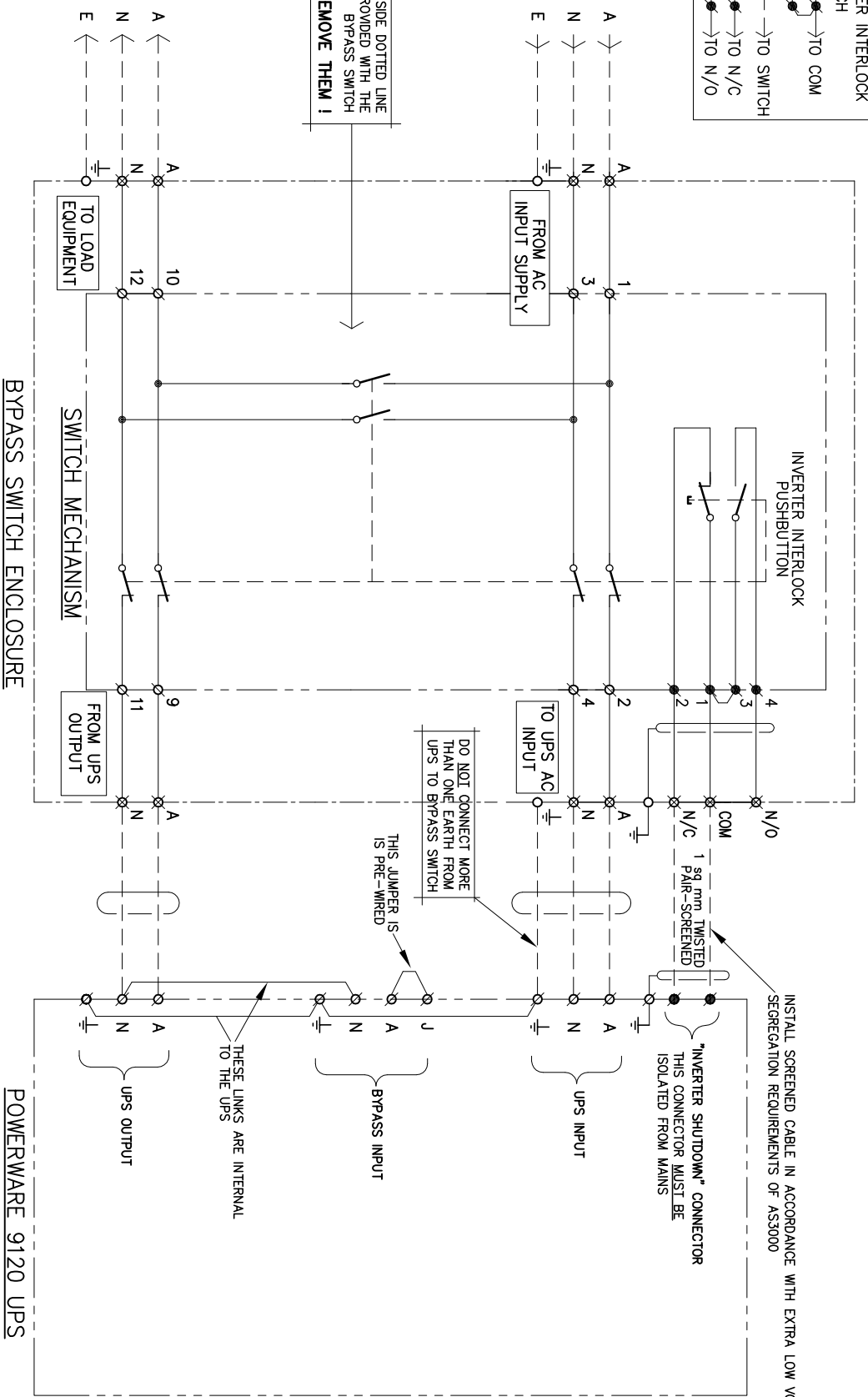

- TERMINAL LEGEND**
- ⊗ DENOTES TERMINAL ON SWITCH
  - ⊙ DENOTES TERMINAL ON UPS
  - ⊚ DENOTES TUNNEL TERMINALS
  - DENOTES FIELD WIRING - NOT SUPPLIED WITH SWITCH OR UPS
  - DENOTES TERMINAL ON SWITCH PUSHBUTTON
  - DENOTES TERMINAL ON UPS FOR INVERTER SHUTDOWN
  - DENOTES M6 EARTH STUD
  - DENOTES TERMINAL LABEL ON BYPASS SWITCH ENCLOSURE

REV.	DATE	DWN	CHK	APP.	DESCRIPTION
1	4.11.04	GA			CHANGED DWG TO INCLUDE 9120, 9155 and 9170 UPS MODELS
2	26.7.05	GA			REVERTED TO SINGLE UPS DIAGRAM

**EATON** | **Powerware**

EATON POWER QUALITY DIV. LTD.  
13 Hedley Road, Sanderson, VIC 3175

THIRD ANGLE PROJECTION

UNLESS OTHERWISE SPECIFIED ALL DIMENSIONS IN MILLIMETERS

DRAWN	CHECKED	APPROVED	SCALE	FILENAME:	
GA			NTS	A4D0219Rev2.dwg	
TITLE					A4
Generic MBS Wiring Diagram for MBST1NSBXBW 9120 N/C Inverter Interlock					
DRAWING NUMBER					REV
A4D0219					2

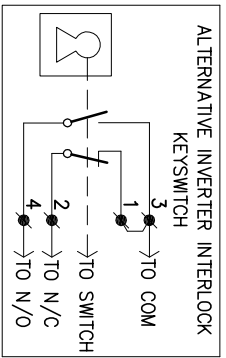

ALL LINKS INSIDE DOTTED LINE ARE PROVIDED WITH THE BYPASS SWITCH  
DO NOT REMOVE THEM !

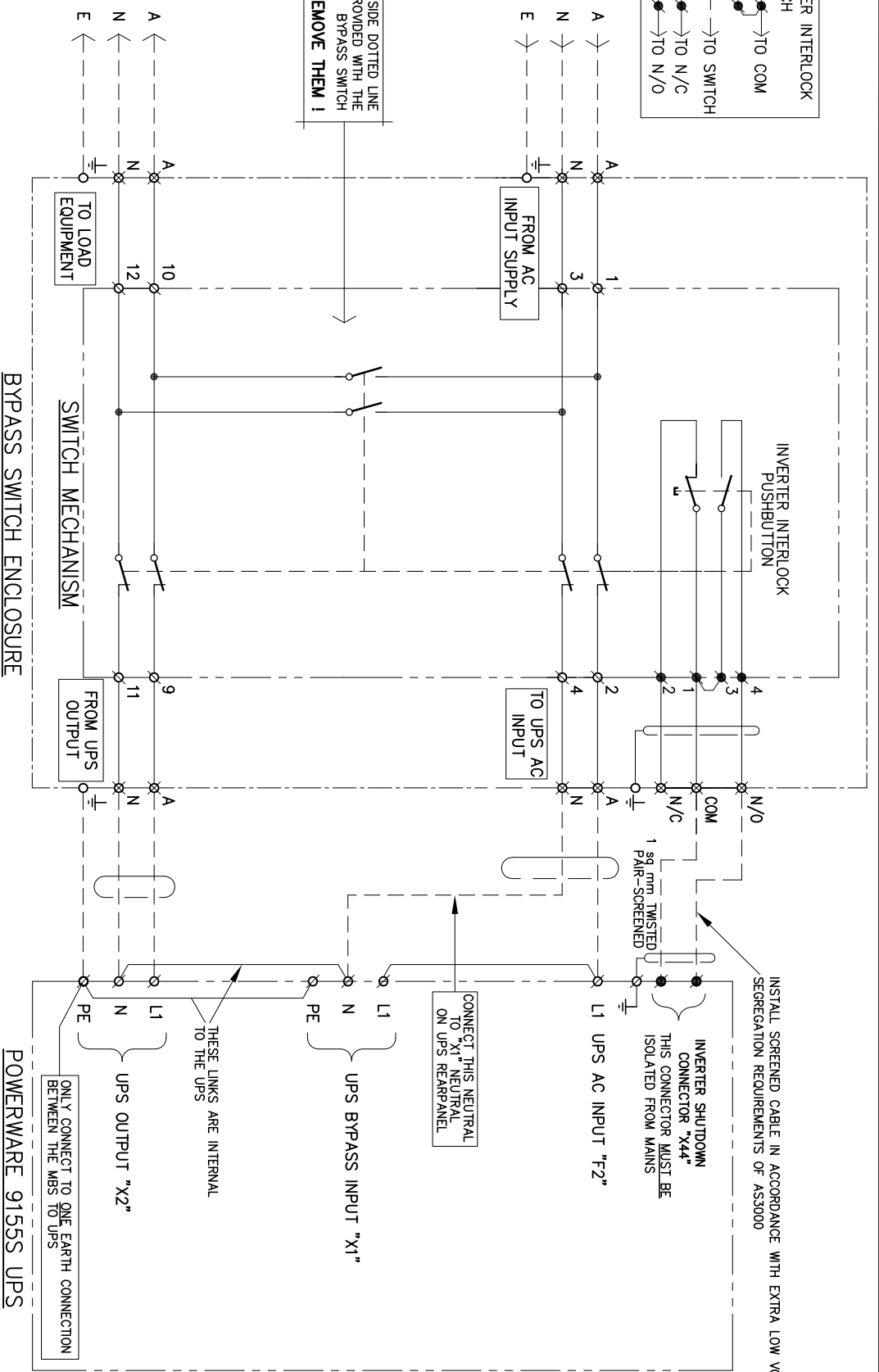

INSTALL SCREENED CABLE IN ACCORDANCE WITH EXTRA LOW VOLTAGE SEGREGATION REQUIREMENTS OF AS3000

INVERTER SHUTDOWN CONNECTOR "X44" THIS CONNECTOR MUST BE ISOLATED FROM MAINS

CONNECT THIS NEUTRAL TO "X1" NEUTRAL ON UPS REARPANEL

THESE LINKS ARE INTERNAL TO THE UPS

ONLY CONNECT TO ONE EARTH CONNECTION BETWEEN THE MBS TO UPS

POWERWARE 9155S UPS

- TERMINAL LEGEND**
- ⊗ DENOTES TERMINAL ON SWITCH
  - ⊙ DENOTES SOCKET ON UPS FOR INVERTER SHUTDOWN
  - DENOTES M6 EARTH STUD
  - DENOTES FIELD WIRING - NOT SUPPLIED WITH SWITCH OR UPS

- DENOTES TERMINAL ON SWITCH PUSHBUTTON
- DENOTES TERMINAL LABEL ON BYPASS SWITCH ENCLOSURE

REV.	DATE	DWN	CHK	APP	DESCRIPTION
1	26.8.05	G.A.			RE-WIRED RECTIFIER NEUTRAL TO BYPASS NEUTRAL

**EATON** | **Powerware**

EATON POWER QUALITY PRTY. LTD.  
13 Hedley Road, Sandersons VIC 3175

DRAWN	CHECKED	APPROVED	SCALE	FILENAME:	TITLE
G.A.			NTS	A4D0230Rev1.dwg	MBS Wiring Diagram for MBS11NSBXXBW 9155S N/O Inverter Interlock

**REVISIONS**

REV.	DATE	DWN	CHK	APP	DESCRIPTION
1	26.8.05	G.A.			RE-WIRED RECTIFIER NEUTRAL TO BYPASS NEUTRAL

THIRD ANGLE PROJECTION

UNLESS OTHERWISE SPECIFIED ALL DIMENSIONS IN MILLIMETERS

DRAWING NUMBER: A4D0230

REV: 1

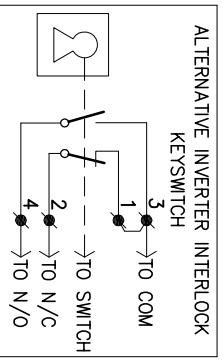

ALL LINKS INSIDE DOTTED LINE ARE PROVIDED WITH THE BYPASS SWITCH DO NOT REMOVE THEM !

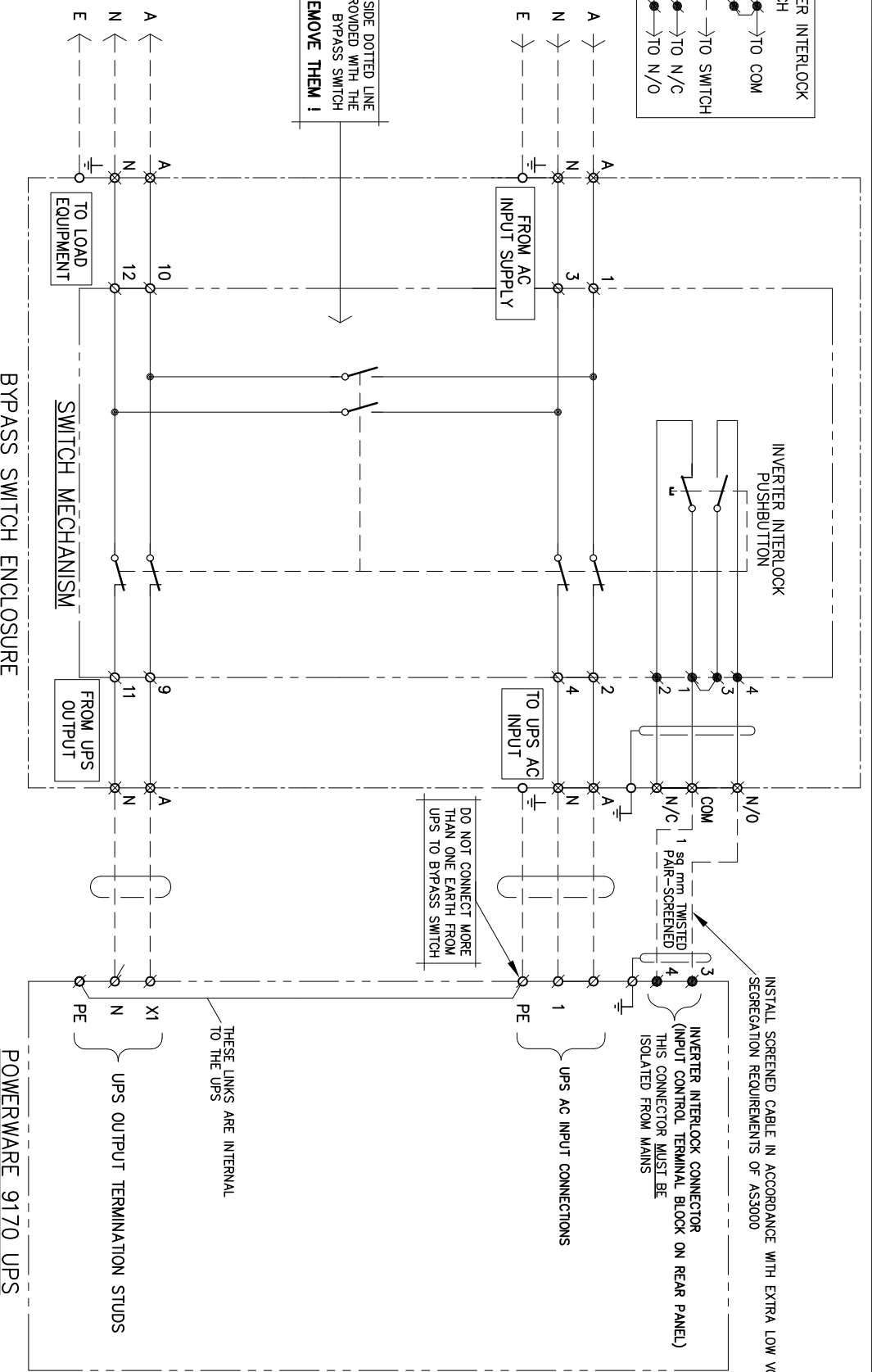

INSTALL SCREENED CABLE IN ACCORDANCE WITH EXTRA LOW VOLTAGE SEGREGATION REQUIREMENTS OF AS3000

INVERTER INTERLOCK CONNECTOR (INPUT CONTROL TERMINAL BLOCK ON REAR PANEL) THIS CONNECTOR MUST BE ISOLATED FROM MAINS

DO NOT CONNECT MORE THAN ONE EARTH FROM UPS TO BYPASS SWITCH

**TERMINAL LEGEND**

- ⊘ DENOTES TERMINAL ON SWITCH
- ⊙ DENOTES TERMINAL ON UPS
- DENOTES TUNNEL TERMINALS
- DENOTES FIELD WIRING - NOT SUPPLIED WITH SWITCH OR UPS
- DENOTES TERMINAL ON SWITCH PUSHBUTTON
- DENOTES TERMINAL ON UPS FOR INVERTER SHUTDOWN
- DENOTES M6 EARTH STUD
- DENOTES TERMINAL LABEL ON BYPASS SWITCH ENCLOSURE

REV.	DATE	DWN	CHK	APP.	DESCRIPTION

**EATON** | **Powerware**

EATON POWER QUALITY PRTY. LTD.  
13 Helder Road, Bundamba, VIC 3175

13-1110  
THIRD ANGLE PROJECTION

UNLESS OTHERWISE SPECIFIED, ALL DIMENSIONS IN MILLIMETERS.

DRAWN	CHECKED	APPROVED	SCALE	FILENAME:	A4
G.A.			7:4.05	A4D0231Rev0.dwg	
TITLE					REV
GENERIC MBS WIRING DIAGRAM FOR					0
MBS11NSBxxBW FOR 9170					
N/O INVERTER INTERLOCK					
DRAWING NUMBER					
A4D0231					

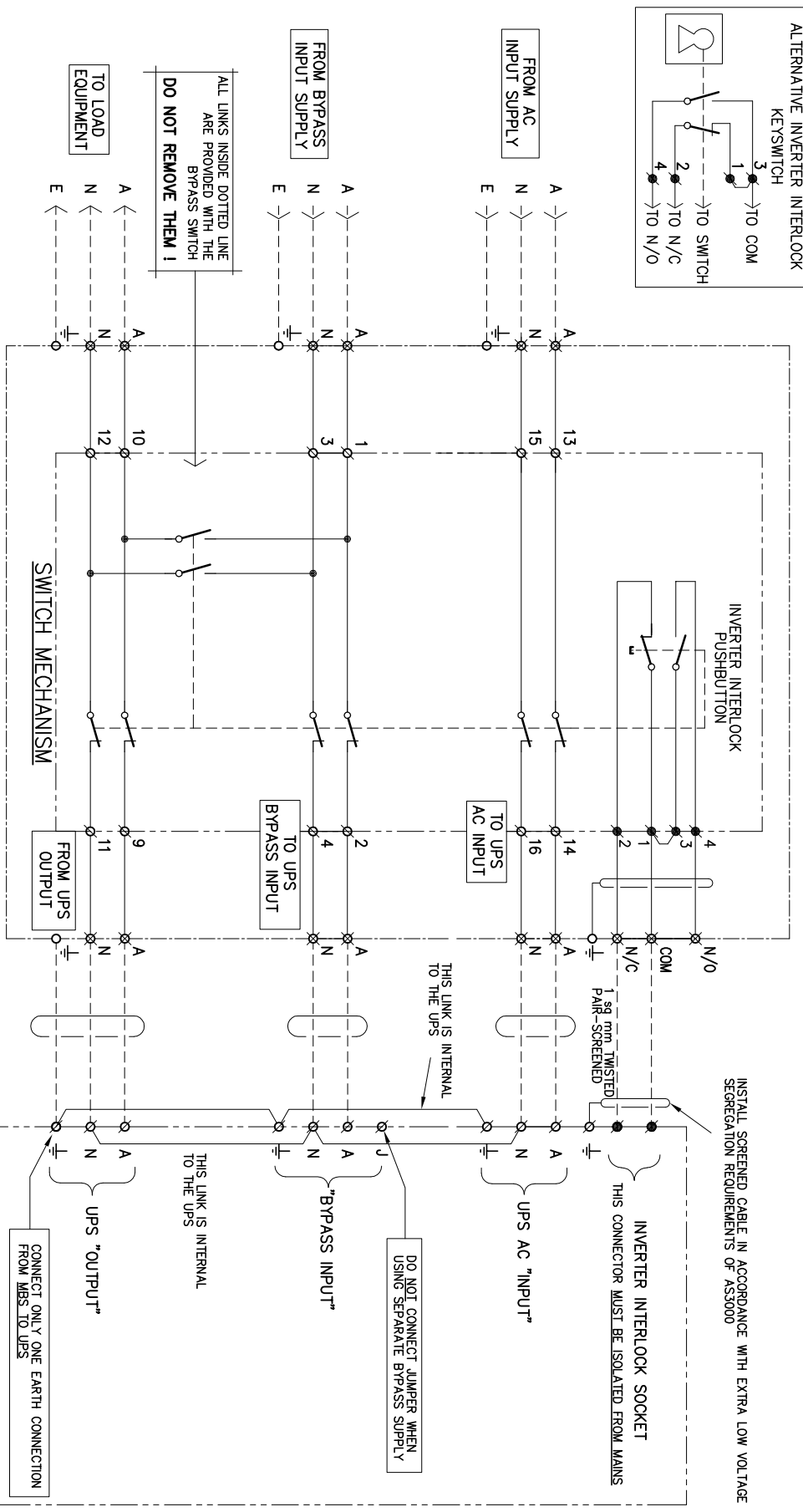
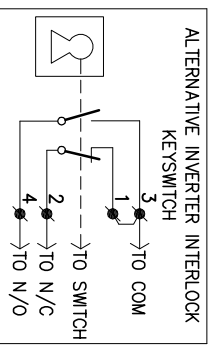

**TERMINAL LEGEND**

- ⊗ DENOTES TERMINAL ON SWITCH
- ⊘ DENOTES TERMINAL ON UPS
- ⊙ DENOTES TUNNEL TERMINALS
- DENOTES FIELD WIRING - NOT SUPPLIED WITH SWITCH OR UPS
- DENOTES TERMINAL LABEL ON BYPASS SWITCH ENCLOSURE

**BYPASS SWITCH ENCLOSURE**

**POWERWARE 9120 6000A UPS**

**DESCRIPTION**

ADDED 9155/9120 AS UPS MODEL

NEW DRAWING BORDER ADDED

REVERTED TO SINGLE UPS DIAGRAM

RENAMED TO AC INPUT LABEL

**REVISIONS**

REV.	DATE	DWN	CHK.	APP.
1	4.11.04	GA		
2	22/4/05	F.H.		
3	28/7/05	G.A.		
4	18/10/05	G.A.		



**EATON POWER QUALITY PTY. LTD.**  
13 Healey Road, Sandhurst, VIC 3175

DRAWN	CHECKED	APPROVED	SCALE	FILENAME:
GA			N.T.S.	A4D0218Rev4

**Generic MBS Wiring Diagram**  
for MBS115BXXBW with 9120 6KVA UPS  
N/C Inverter Interlock

DRAWING NUMBER: **A4D0218**

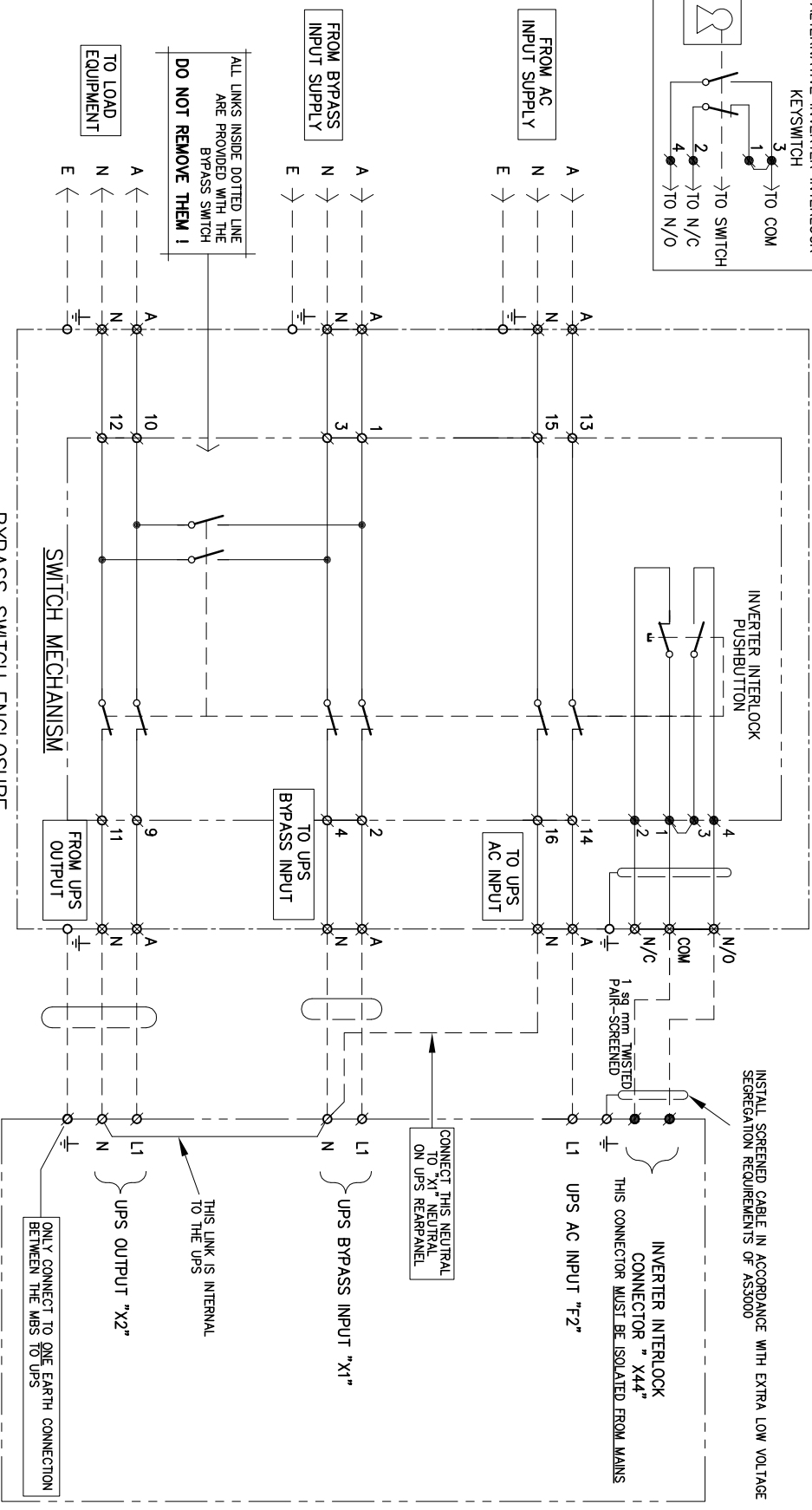
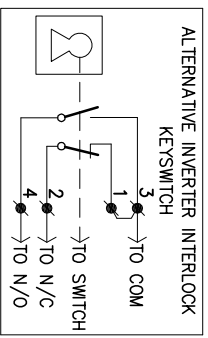

**TERMINAL LEGEND**

- ∅ DENOTES TERMINAL ON SWITCH
- ⊗ DENOTES TERMINAL ON UPS
- ⊙ DENOTES TUNNEL TERMINALS
- DENOTES FIELD WIRING - NOT SUPPLIED WITH SWITCH OR UPS
- ⊕ DENOTES TERMINAL ON SWITCH PUSHBUTTON
- ⊖ DENOTES SOCKET ON UPS FOR INVERTER SHUTDOWN
- ⊕ DENOTES M6 EARTH STUD
- DENOTES TERMINAL LABEL ON BYPASS SWITCH ENCLOSURE

REV.	DATE	DWN	CHK	APP	DESCRIPTION
1	26.8.05	G.A.			RE-WIRED RECTIFIER NEUTRAL TO BYPASS
2	18.10.05	G.A.			RENAMED RECTIFIER INPUT SUPPLY TO AC INPUT



**Powerware**

EATON POWER QUALITY DIV. LTD.  
13 Hedley Road, Sanderson, VIC 3175



UNLESS OTHERWISE SPECIFIED ALL DIMENSIONS IN MILLIMETERS

DRAWN	CHECKED	APPROVED	SCALE	FILENAME:
G.A.			NTS	A4D0229Rev2.dwg

TITLE  
MBS WIRING DIAGRAM  
FOR MBS11SBxxBW WITH 91555 UPS  
N/O INVERTER INTERLOCK

DRAWING NUMBER  
A4D0229

A4

REV  
2

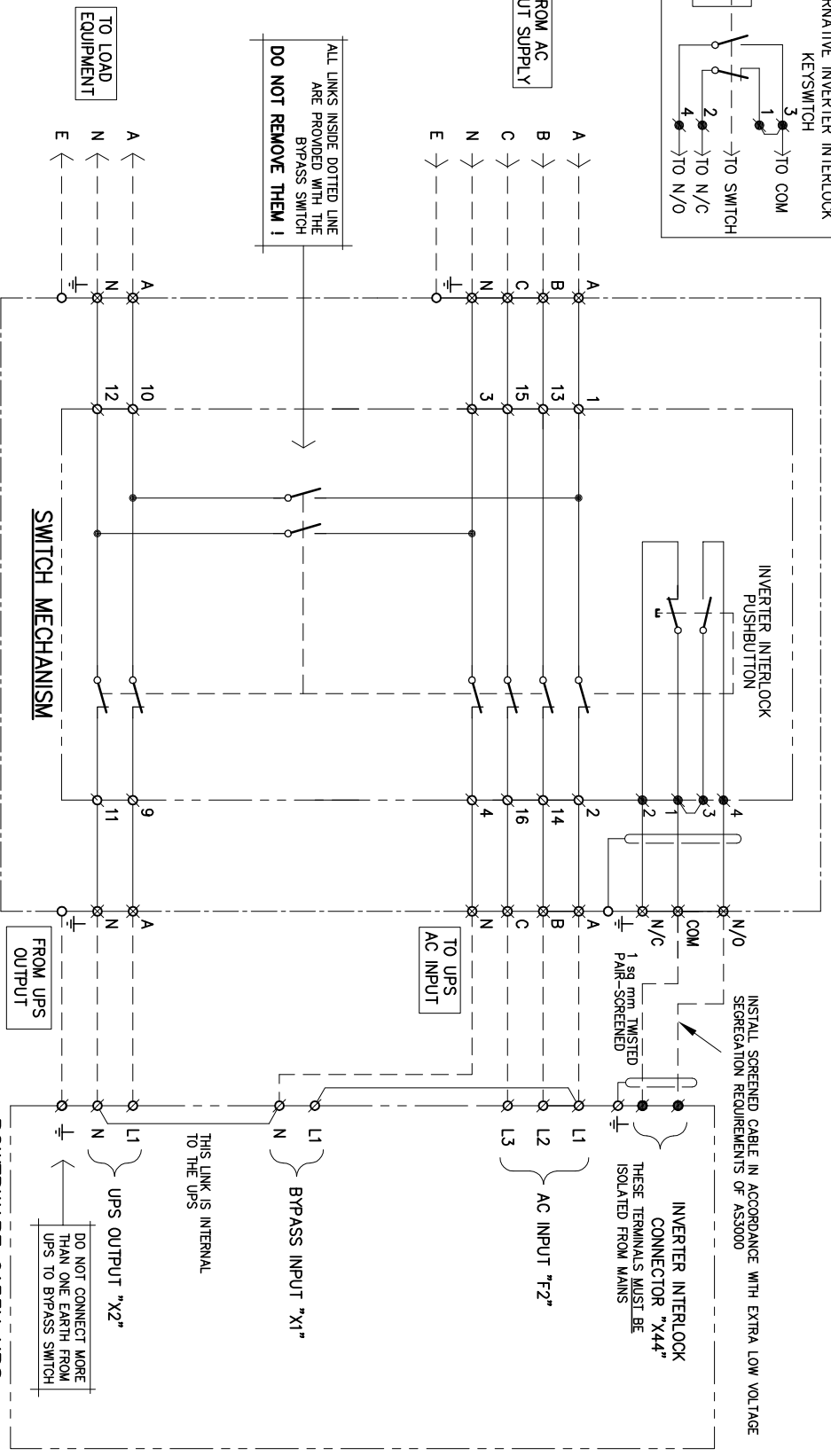
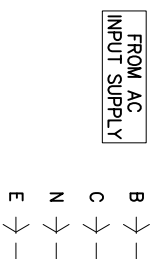
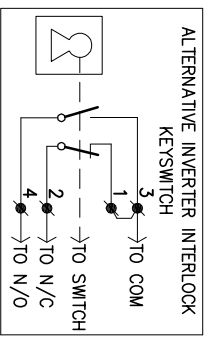

- TERMINAL LEGEND**
- Ø DENOTES TERMINAL ON SWITCH
  - ⊗ DENOTES TERMINAL ON SWITCH PUSHBUTTON
  - ⊘ DENOTES TERMINAL ON UPS
  - ⊙ DENOTES SOCKET ON UPS FOR INVERTER SHUTDOWN
  - ⊚ DENOTES TUNNEL TERMINALS
  - DENOTES M6 EARTH STUD
  - DENOTES FIELD WIRING - NOT SUPPLIED WITH SWITCH OR UPS

**BYPASS SWITCH ENCLOSURE**

**SWITCH MECHANISM**

**POWERWARE 9155N UPS**

REV.	DATE	DWN	CHK	APP	DESCRIPTION
1	7.6.05	GA			ADDED "X44" DESIGNATOR

**EATON** | **Powerware**

EATON POWER QUALITY PRTY. LTD.  
13 Hedley Road, Sandersons, VIC 3175

DRAWN	CHECKED	APPROVED	SCALE	FILENAME:
GA			NTS	A4D0224Rev1.dwg
TITLE	MBS WIRING DIAGRAM FOR MBS31NSBxxBW WITH 9155N UPS N/O INVERTER INTERLOCK			

REVISIONS

REV.	DATE	DWN	CHK	APP	DESCRIPTION
1	7.6.05	GA			ADDED "X44" DESIGNATOR

1:5-1110  
THIRD ANGLE PROJECTION

UNLESS OTHERWISE SPECIFIED ALL DIMENSIONS IN MILLIMETERS

DRAWING NUMBER	A4D0224
REV	1



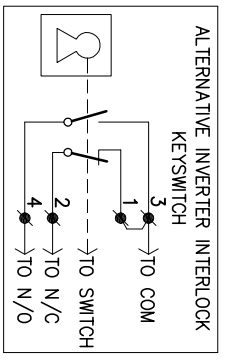

FROM AC INPUT SUPPLY

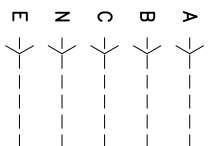

ALL LINKS INSIDE DOTTED LINE ARE PROVIDED WITH THE BYPASS SWITCH DO NOT REMOVE THEM !

TO LOAD EQUIPMENT

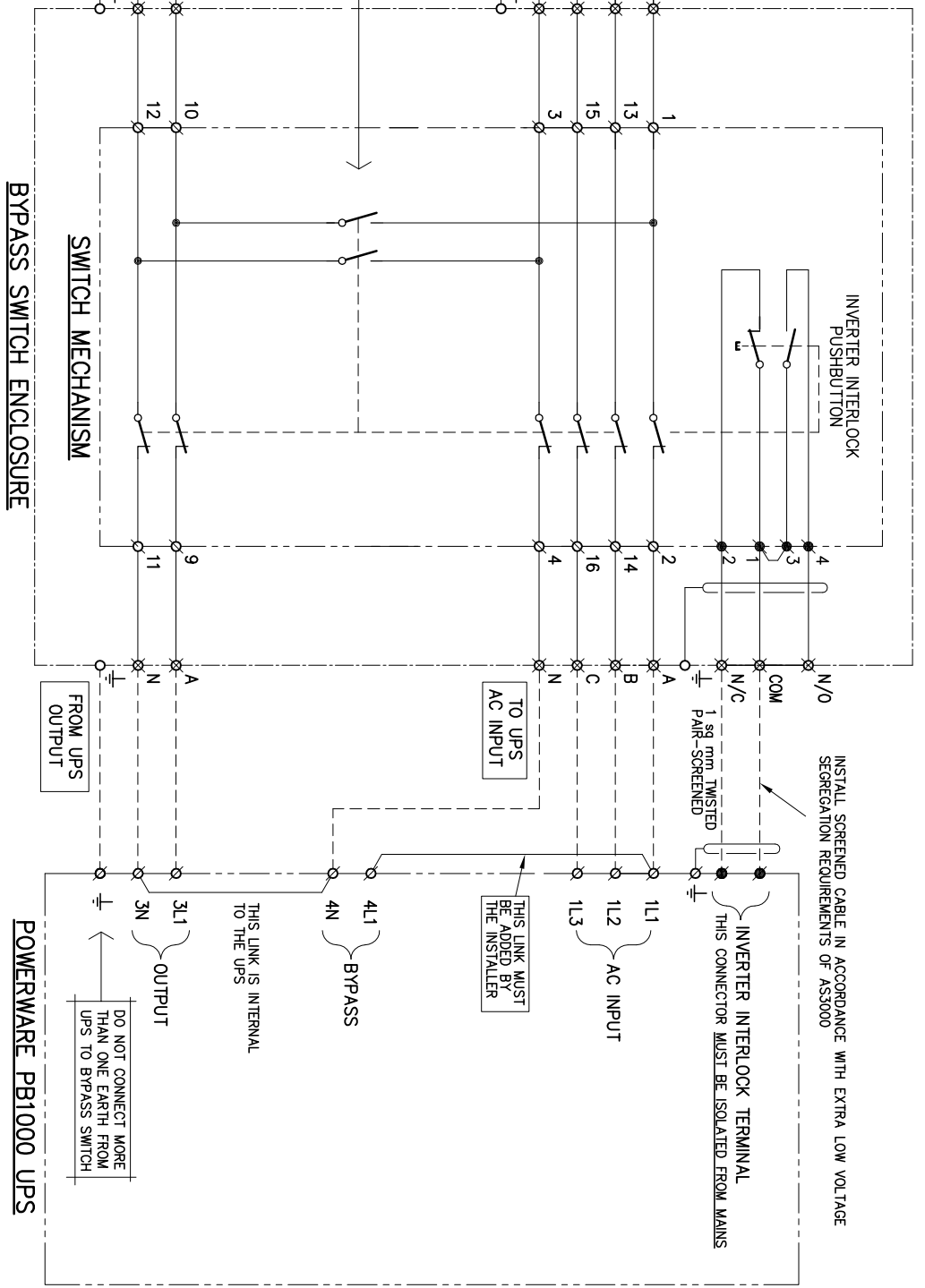
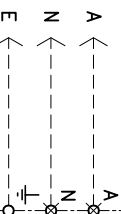

INSTALL SCREENED CABLE IN ACCORDANCE WITH EXTRA LOW VOLTAGE SEGREGATION REQUIREMENTS OF AS3000

INVERTER INTERLOCK TERMINAL THIS CONNECTOR MUST BE ISOLATED FROM MAINS

THIS LINK MUST BE ADDED BY THE INSTALLER

THIS LINK IS INTERNAL TO THE UPS

DO NOT CONNECT MORE THAN ONE EARTH FROM UPS TO BYPASS SWITCH

**BYPASS SWITCH ENCLOSURE**

**POWERWARE PB1000 UPS**

- TERMINAL LEGEND**
- ⊘ DENOTES TERMINAL ON SWITCH
  - ⊚ DENOTES TERMINAL ON UPS
  - ⊙ DENOTES TUNNEL TERMINALS
  - — — DENOTES FIELD WIRING - NOT SUPPLIED WITH SWITCH OR UPS
  - ⊙ DENOTES TERMINAL ON SWITCH PUSHBUTTON
  - ⊚ DENOTES TERMINAL ON UPS FOR INVERTER SHUTDOWN
  - ⊙ DENOTES M6 EARTH STUD

REV.	DATE	DWN	CHK	APP	DESCRIPTION
1	30.3.06	GA			UPS OUTPUT MARKING

**EATON** | **Powerware**

EATON POWER QUALITY PRTY. LTD.  
13 Hedley Road, Sanderson, VIC 3175

DRAWN	CHECKED	APPROVED	SCALE	FILENAME:	
GA			NTS	A4D0263Rev0	
TITLE					A4
Generic MBS Wiring Diagram for MBS31NSBXXBW with PB1000 UPS N/C Inverter Interlock					
DRAWING NUMBER					
A4D0263					
REV					1

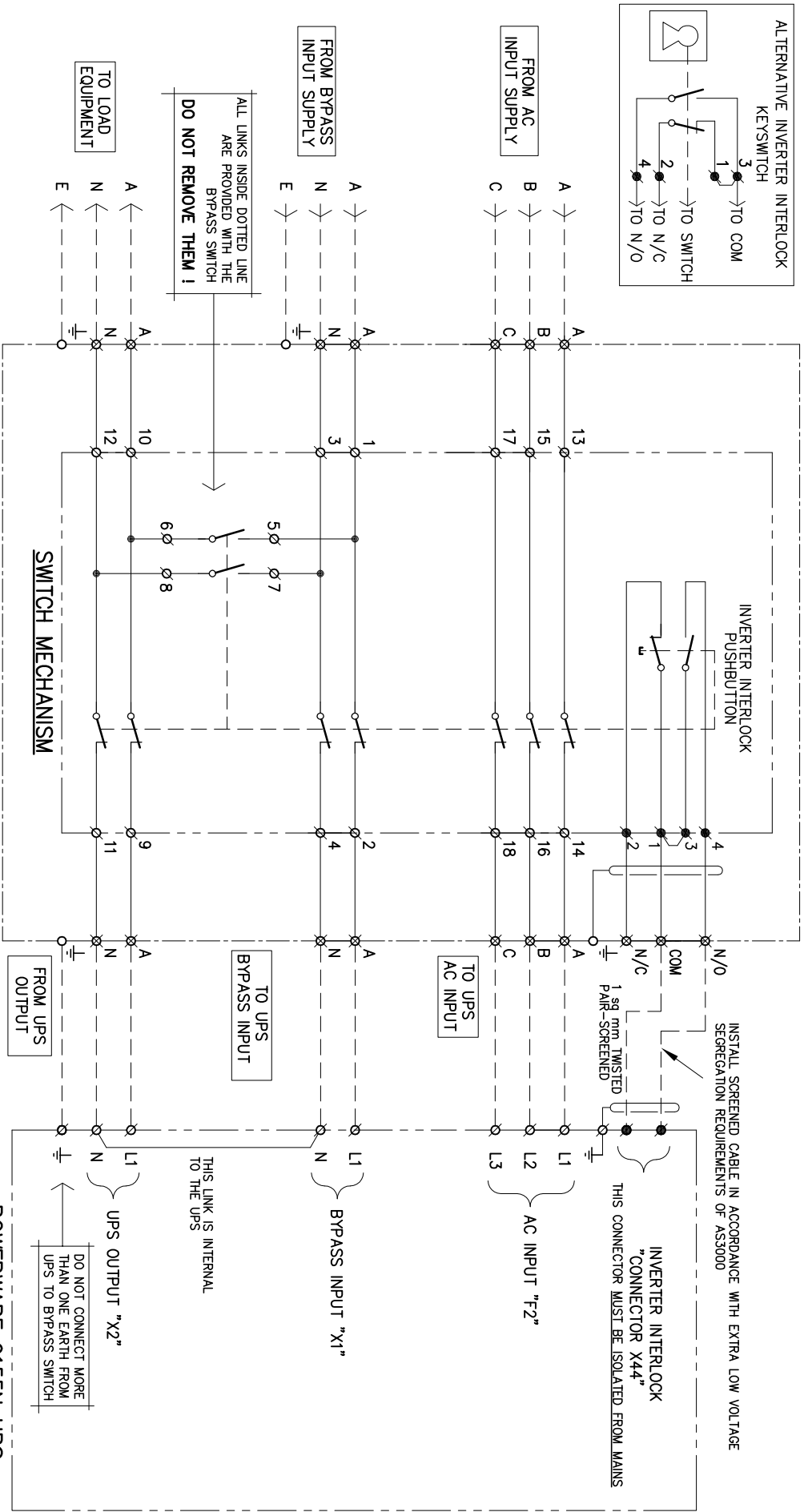
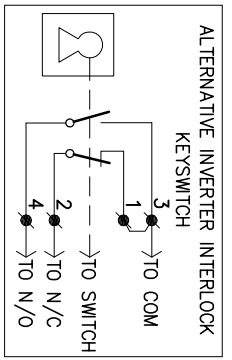

**BYPASS SWITCH ENCLOSURE**

**POWERWARE 9155N UPS**

- TERMINAL LEGEND**
- Ø DENOTES TERMINAL ON SWITCH
  - DENOTES TERMINAL ON UPS
  - ⊗ DENOTES SOCKET ON UPS FOR INVERTER SHUTDOWN
  - DENOTES M6 EARTH STUD
  - DENOTES FIELD WIRING - NOT SUPPLIED WITH SWITCH OR UPS

REV.	DATE	DWN	CHK	APP	DESCRIPTION
1	28.10.04	GA			ADDED EARTH SCREEN FOR INTERLOCK
2	18.10.05	GA			RENAMED LABEL : RECTIFIER INPUT TO AC INPUT



EATON POWER QUALITY PRT. LTD.  
13 Hedley Road, Sanderson, VIC 3175

DRAWN	CHECKED	APPROVED	SCALE	FILENAME:
GA			NTS	A4D0213Rev2.dwg

TITLE

MBS WIRING DIAGRAM  
for MBSJ1SBXXBW WITH 9155N UPS  
N/O INVERTER INTERLOCK

DRAWING NUMBER

A4D0213

A4

REV

2

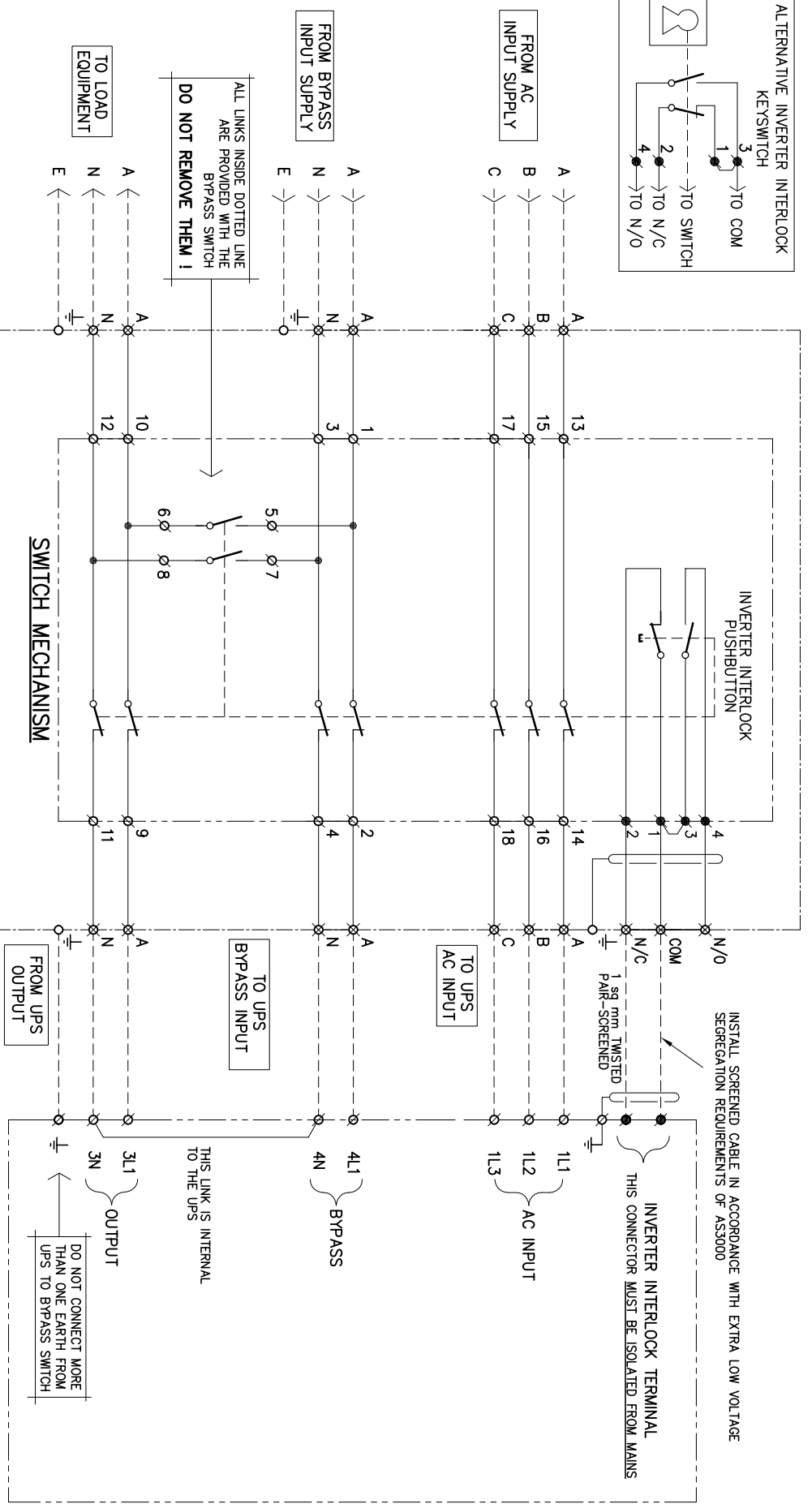
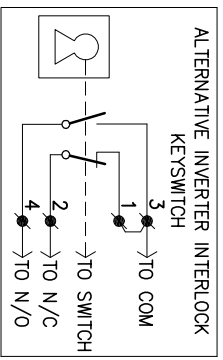

**TERMINAL LEGEND**

- ⊗ DENOTES TERMINAL ON SWITCH
- ⊙ DENOTES TERMINAL ON UPS
- ⊗ DENOTES TERMINAL ON SWITCH PUSHBUTTON
- ⊙ DENOTES TERMINAL ON UPS FOR INVERTER SHUTDOWN
- ⊗ DENOTES TUNNEL TERMINALS
- DENOTES M6 EARTH STUD
- DENOTES FIELD WIRING - NOT SUPPLIED WITH SWITCH OR UPS

**BYPASS SWITCH ENCLOSURE**

**POWERWARE PB1000 UPS**

REV.	DATE	DWN	CHK	APP.	DESCRIPTION
1	30.3.06		GA		UPS OUTPUT MARKINGS



EATON POWER QUALITY PRTY. LTD.  
13 Healey Road, Sanderson, VIC 3175

DRAWN	CHECKED	APPROVED	SCALE	FILENAME:
GA			NTS	A4D0264Rev1

Generic MBS Wiring Diagram  
for MBS31SBXXBW with PBT000 UPS  
N/C Inverter Interlock

DRAWING NUMBER: A4D0264

A4

REV 1

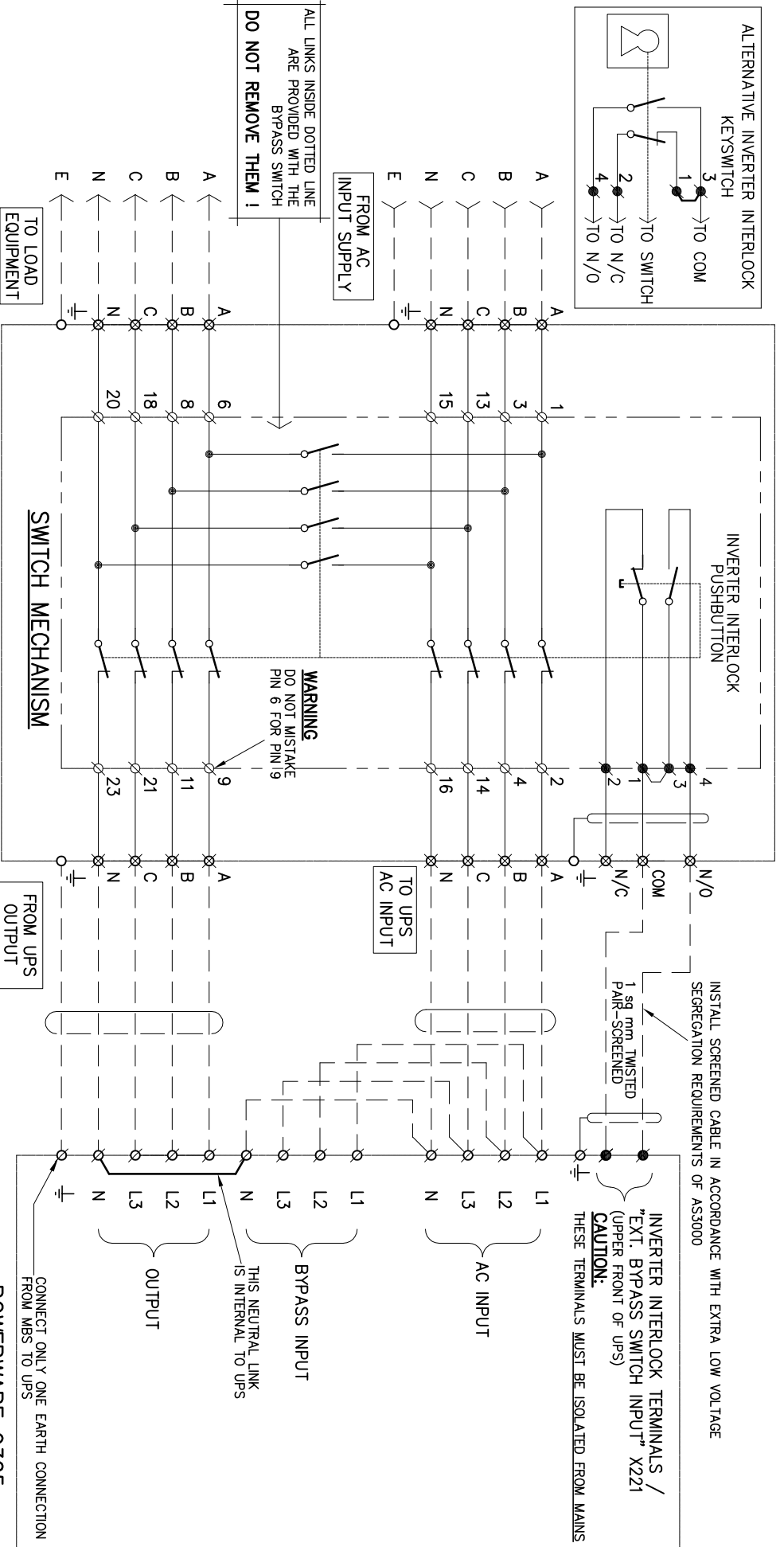
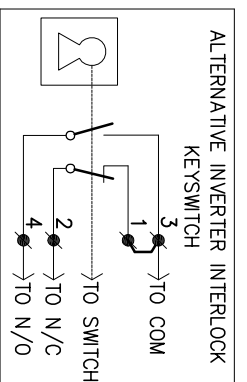

ALL LINKS INSIDE DOTTED LINE ARE PROVIDED WITH THE BYPASS SWITCH  
**DO NOT REMOVE THEM !**

**WARNING**  
 DO NOT MISTAKE PIN 6 FOR PIN 9

INSTALL SCREENED CABLE IN ACCORDANCE WITH EXTRA LOW VOLTAGE SEGREGATION REQUIREMENTS OF ASS3000

1 sq mm TWISTED PAIR - SCREENED

INVERTER INTERLOCK TERMINALS / "EXT. BYPASS SWITCH INPUT" X221 (UPPER FRONT OF UPS)  
**CAUTION:**  
 THESE TERMINALS MUST BE ISOLATED FROM MAINS

**BYPASS SWITCH ENCLOSURE**

**POWERWARE 9305**

**TERMINAL LEGEND**

- ∅ DENOTES TERMINAL ON SWITCH
- ⊗ DENOTES TERMINAL ON UPS
- ⊙ DENOTES TUNNEL TERMINALS
- DENOTES TERMINAL ON SWITCH PUSHBUTTON
- ⊕ DENOTES TERMINAL ON UPS FOR INVERTER SHUTDOWN
- DENOTES FIELD WIRING - NOT SUPPLIED WITH SWITCH OR UPS
- DENOTES M6 EARTH STUD

REV.	DATE	DWN	CHK	APP	DESCRIPTION

**EATON** | **Powerware**

EATON POWER QUALITY PRTY. LTD.  
 13 Healy Road, Dundonnell, MC 3175

THIRD ANGLE PROJECTION

DRAWN	CHECKED	APPROVED	SCALE	FILENAME	TITLE
G.A			NTS	A4D0249Rev0.dwg	Generic MBS Wiring Diagram for MBS33NSB to suit Powerware 9305 UPS
					DRAWING NUMBER
					A4D0249
					REV
					0

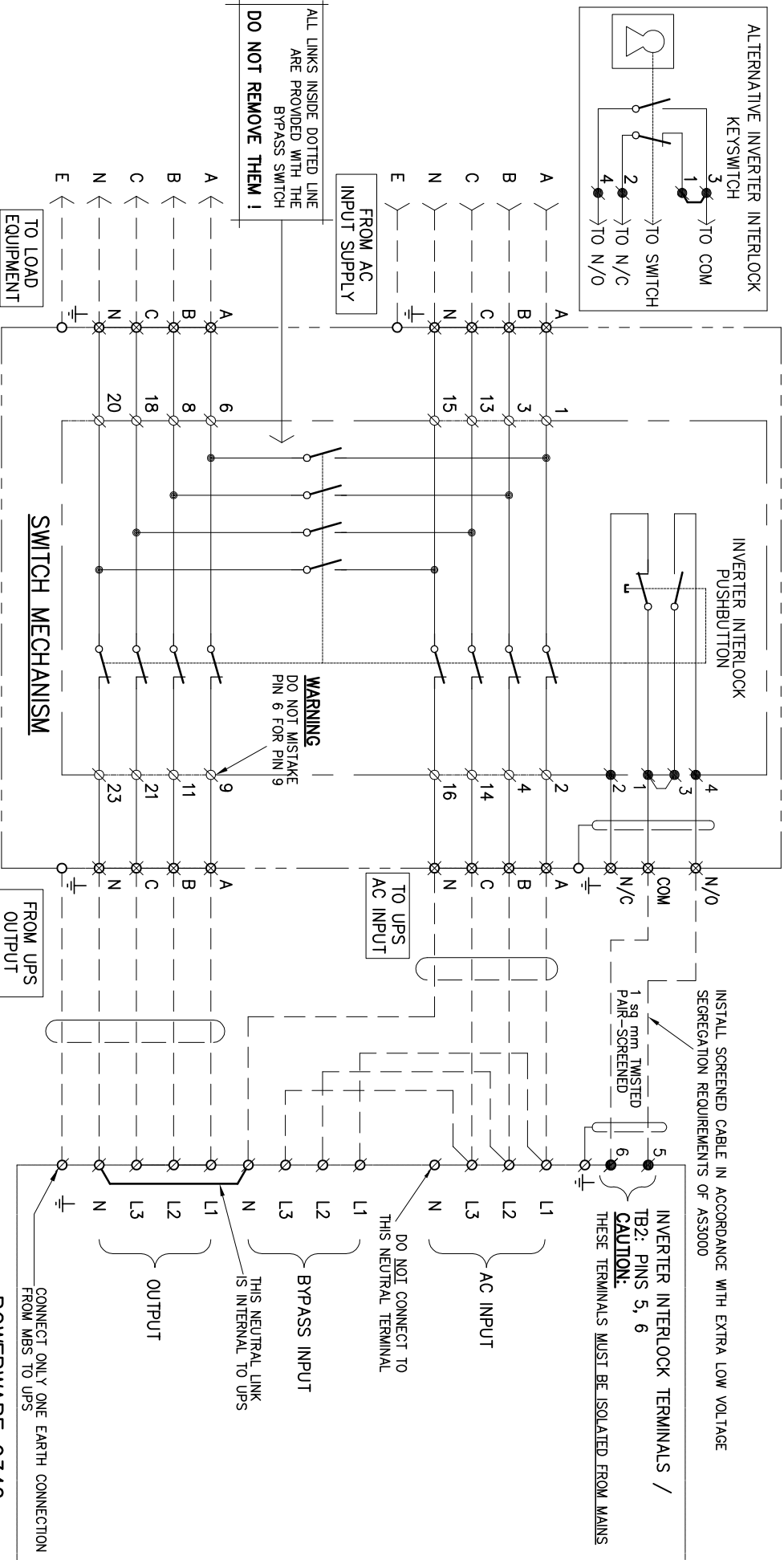
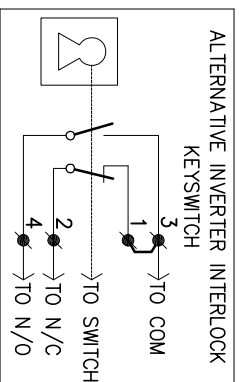

- TERMINAL LEGEND**
- ∅ DENOTES TERMINAL ON SWITCH
  - ∅ DENOTES TERMINAL ON SWITCH PUSHBUTTON
  - ⊗ DENOTES TERMINAL ON UPS
  - ⊗ DENOTES TERMINAL ON UPS FOR INVERTER SHUTDOWN
  - ⊗ DENOTES TUNNEL TERMINALS
  - DENOTES FIELD WIRING - NOT SUPPLIED WITH SWITCH OR UPS
  - DENOTES M6 EARTH STUD

REVISIONS

REV.	DATE	DWN	CHK	APP	DESCRIPTION

**EATON POWER QUALITY PRTY. LTD.**  
13 Healey Road, Sanderson, VIC 3175

UNLESS OTHERWISE SPECIFIED, ALL DIMENSIONS IN MILLIMETERS.

DRAWN	CHECKED	APPROVED	SCALE
6.7.05			NTS

FILENAME: A4D0250Rev0.dwg

Generic MBS Wiring Diagram  
for MBS33NSB  
to suit Powerware 9340 UPS

DRAWING NUMBER: A4D0250

TITLE	REV
Generic MBS Wiring Diagram for MBS33NSB to suit Powerware 9340 UPS	0

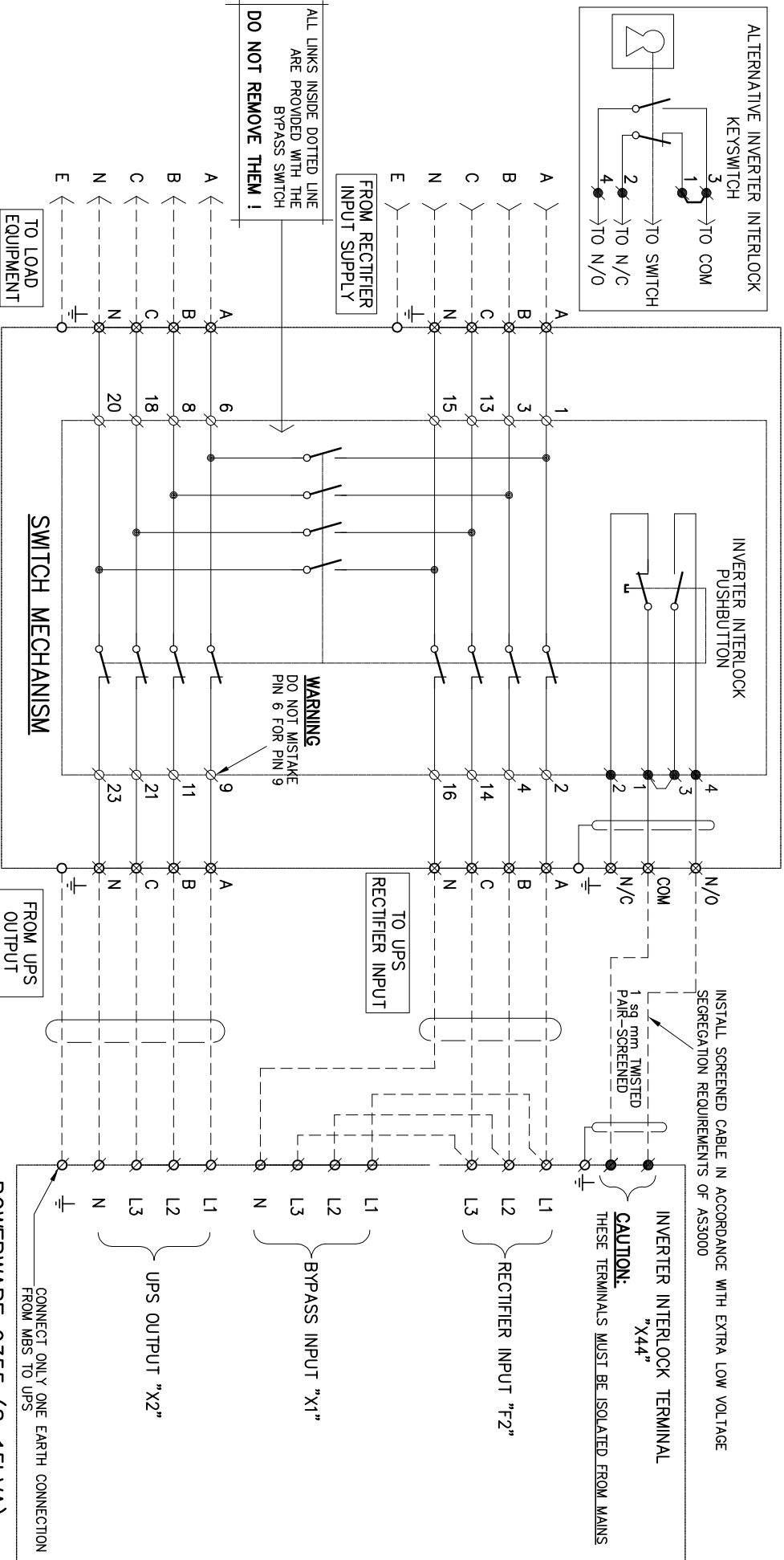
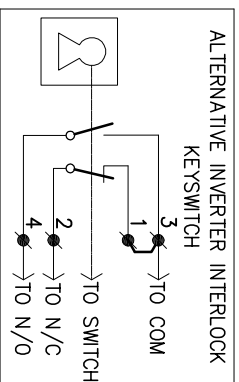

ALL LINKS INSIDE DOTTED LINE  
ARE PROVIDED WITH THE  
BYPASS SWITCH  
DO NOT REMOVE THEM !

**TERMINAL LEGEND**

- ∅ DENOTES TERMINAL ON SWITCH
- ∅ DENOTES TERMINAL ON SWITCH PUSHBUTTON
- ⊗ DENOTES TERMINAL ON UPS
- ⊗ DENOTES TERMINAL ON UPS FOR INVERTER SHUTDOWN
- ⊗ DENOTES TUNNEL TERMINALS
- DENOTES FIELD WIRING - NOT SUPPLIED WITH SWITCH OR UPS
- DENOTES M6 EARTH STUD

REV.	DATE	DWN	CHK	APP	DESCRIPTION
1	15/01	NS			BYPASS TERMINALS ADDED

**EATON** | **Powerware**

EATON POWER QUALITY PRTY. LTD.  
13 Hedley Road, Sanderson, VIC 3175

THIRD ANGLE PROJECTION

UNLESS OTHERWISE SPECIFIED, ALL  
DIMENSIONS IN MILLIMETERS

TITLE	DRAWN G.A.	CHECKED	APPROVED	SCALE	FILENAME
Generic MBS Wiring Diagram for MBS33NSB to suit 9355 UPS	6.7.05			NTS	A4D0251Rev1.dwg

DRAWING NUMBER: **A4D0251**

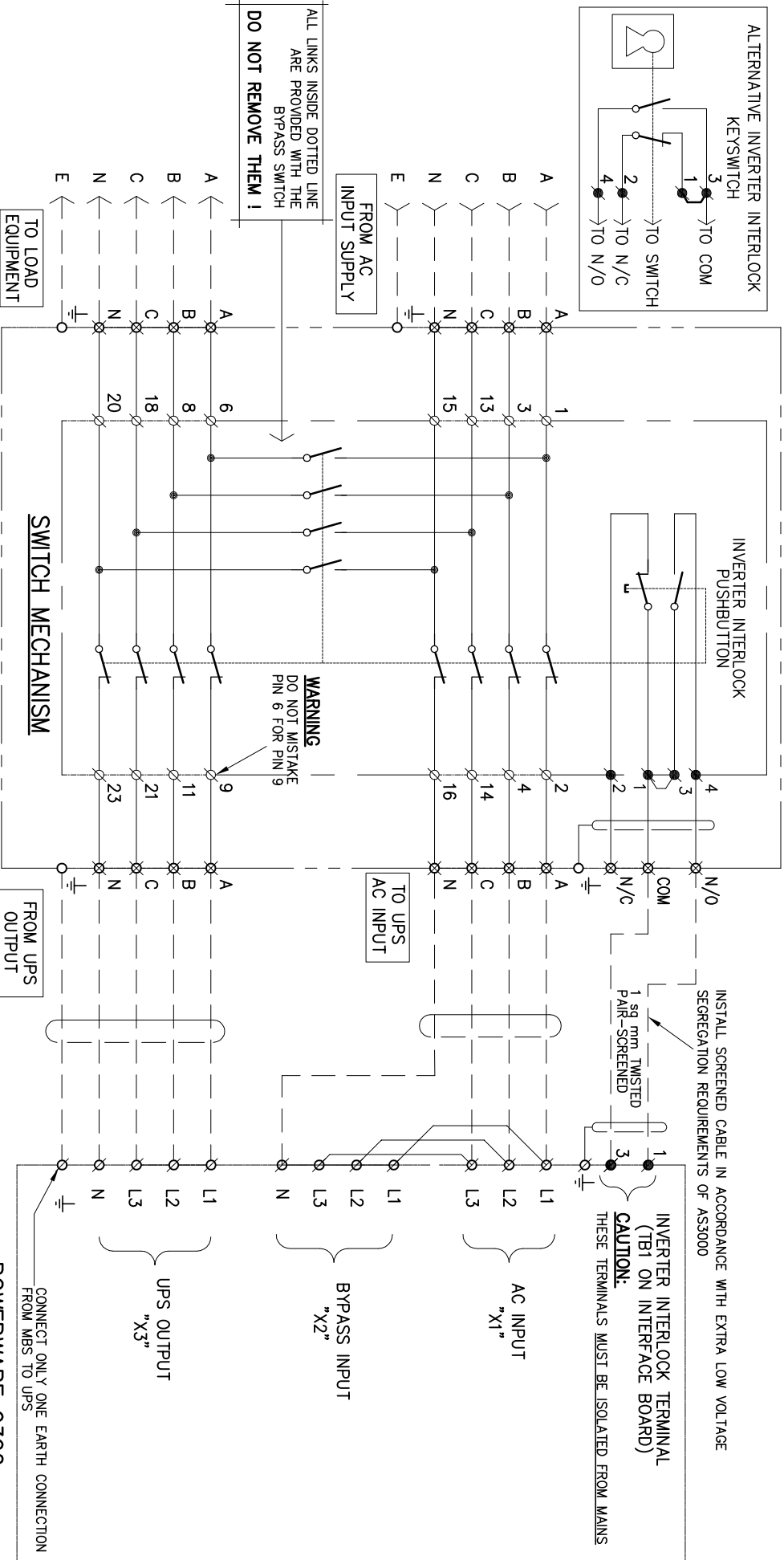
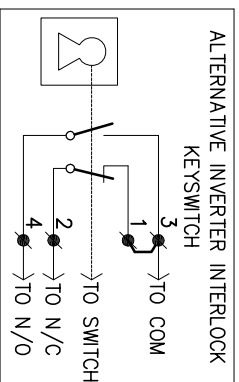

- TERMINAL LEGEND**
- ∅ DENOTES TERMINAL ON SWITCH
  - ⊗ DENOTES TERMINAL ON UPS
  - ⊙ DENOTES TUNNEL TERMINALS
  - DENOTES M6 EARTH STUD
  - DENOTES TERMINAL ON SWITCH PUSHBUTTON
  - DENOTES TERMINAL ON UPS FOR INVERTER SHUTDOWN
  - DENOTES FIELD WIRING - NOT SUPPLIED WITH SWITCH OR UPS

REV.	DATE	DWN	CHK	APP.	DESCRIPTION
1	9.6.06	GA			INVERTER INTERLOCK CONTACTS CHANGED
2	8.12.06	GA			TBI TERMINAL
3	10.1.07	GA			NEUTRAL

**EATON** | **Powerware**

EATON POWER QUALITY PRTY. LTD.  
13 Hedley Road, Sanderson, VIC 3175

THIRD ANGLE PROJECTION

UNLESS OTHERWISE SPECIFIED, ALL DIMENSIONS IN MILLIMETERS.

DRAWN	CHECKED	APPROVED	SCALE	FILENAME:	
G.A.			NTS	A4D0261Rev3.dwg	
TITLE					A4
Generic MBS Wiring Diagram for MBS33NSB to suit 9390 UPS					
DRAWING NUMBER					
A4D0261					
REV					3

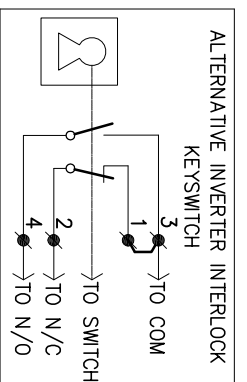

FROM AC  
INPUT SUPPLY

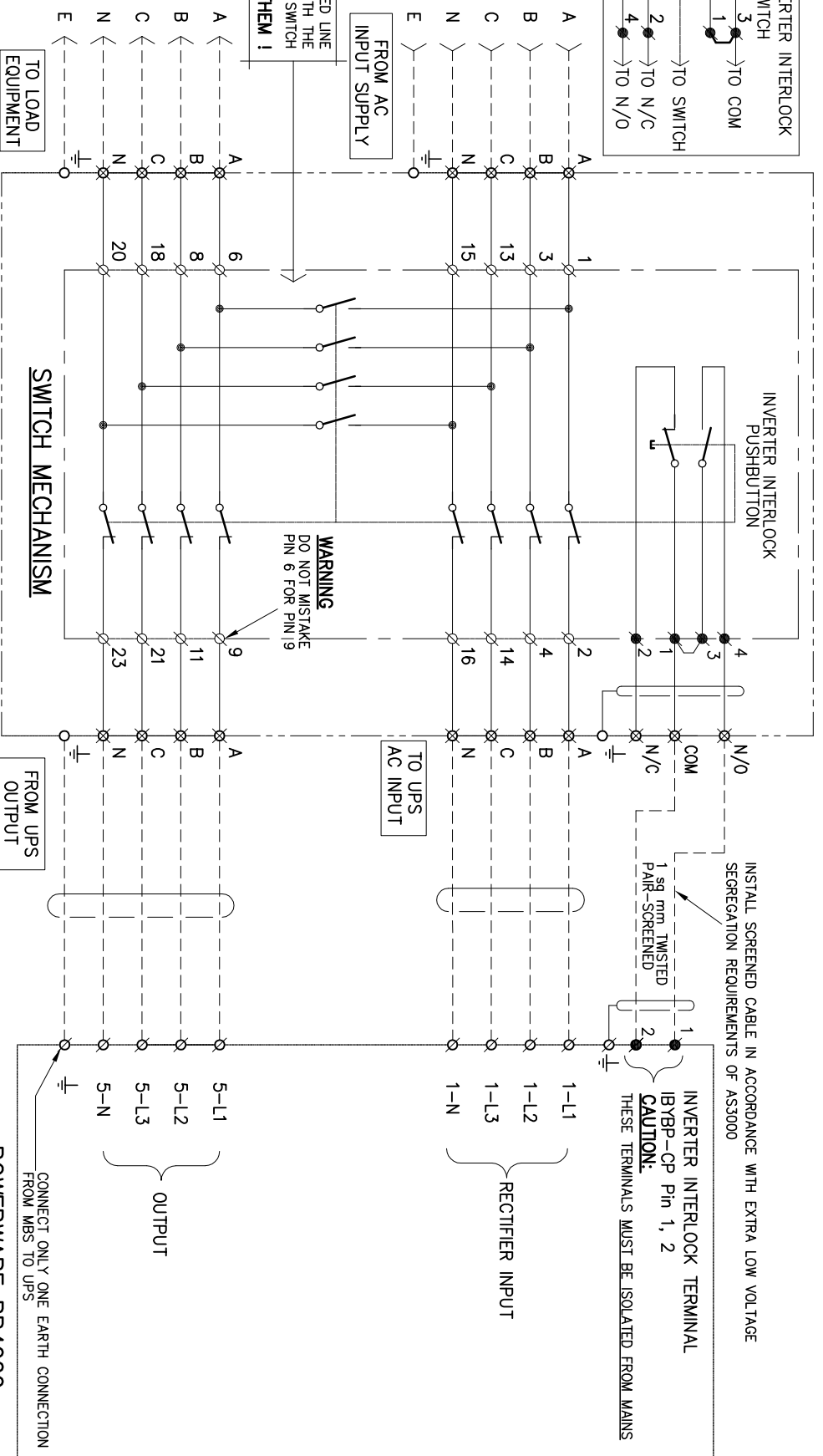

- TERMINAL LEGEND**
- ∅ DENOTES TERMINAL ON SWITCH
  - ⊗ DENOTES TERMINAL ON UPS
  - ⊗ DENOTES TUNNEL TERMINALS
  - DENOTES M6 EARTH STUD
  - DENOTES TERMINAL ON SWITCH PUSHBUTTON
  - DENOTES TERMINAL ON UPS FOR INVERTER SHUTDOWN
  - DENOTES FIELD WIRING - NOT SUPPLIED WITH SWITCH OR UPS

REV.	DATE	DWN	CHK	APP	DESCRIPTION
1	15.1.07	GA			REMOVED NEUTRAL NOTE

**EATON** | **Powerware**

EATON POWER QUALITY PRTY. LTD.  
13 Hedley Road, Sanderson, VIC 3175

THIRD ANGLE PROJECTION

UNLESS OTHERWISE SPECIFIED, ALL  
DIMENSIONS IN MILLIMETERS.

DRAWN	CHECKED	APPROVED	SCALE	FILENAME	TITLE
G.A			NTS	A4D0252Rev1.dwg	Generic MBS Wiring Diagram for MBS33NSB to suit PB4000 UPS

DRAWING NUMBER: A4D0252



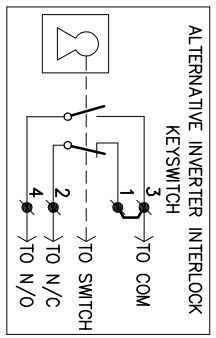

ALL LINKS INSIDE DOTTED LINE ARE PROVIDED WITH THE BYPASS SWITCH

**DO NOT REMOVE THEM !**

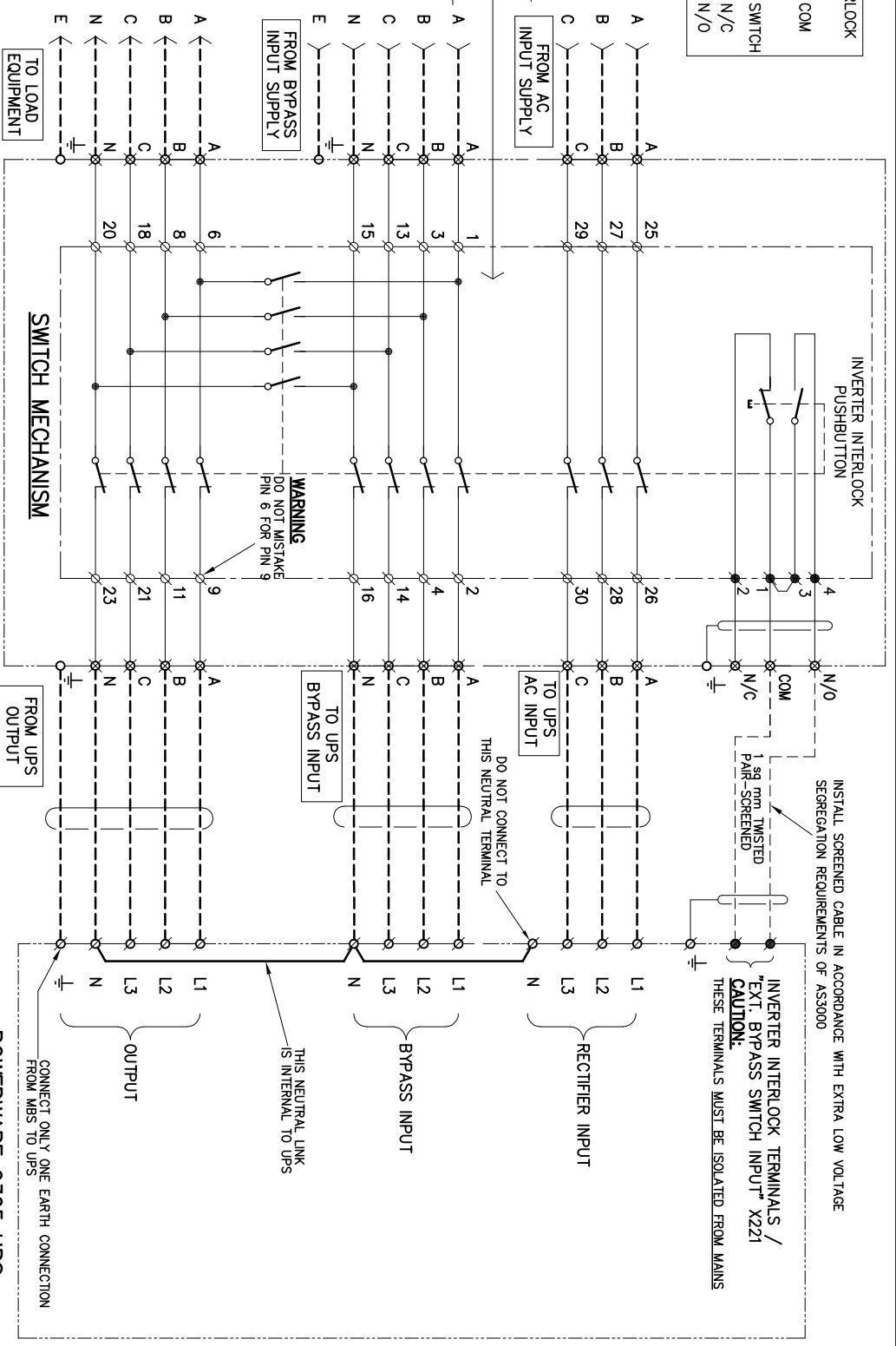

- TERMINAL LEGEND**
- ∅ DENOTES TERMINAL ON SWITCH
  - ⊗ DENOTES TERMINAL ON UPS
  - ⊗ DENOTES TUNNEL TERMINALS
  - DENOTES TERMINAL ON SWITCH PUSHBUTTON
  - ⊗ DENOTES TERMINAL ON UPS FOR INVERTER SHUTDOWN
  - DENOTES FIELD WIRING - NOT SUPPLIED WITH SWITCH OR UPS
  - DENOTES M6 EARTH STUD

**REVISIONS**

REV.	DATE	DWN	CHK	APP.	DESCRIPTION
1	24.11.04	GA			CORRECTED INCORRECT LABEL BYPASS/RECTIFIER SUPPLY
2	18.10.05	GA			RENAMED LABEL: RECTIFIER INPUT TO AC INPUT
3	16.12.05	GA			FIXED INVERTER INTERLOCK

**EATON POWER QUALITY PRTY. LTD.**  
13 Hedley Road, Sanderson, VIC 3175

DRAWN	CHECKED	APPROVED	SCALE	FILENAME:	
GA	NS	NTS		A4D0225Rev3.dwg	A4
TITLE					
Generic Wiring Diagram for MBS335BxxBW to suit 9305					
DRAWING NUMBER					
A4D0225					
REV					3

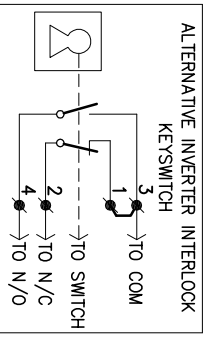

ALL LINKS INSIDE DOTTED LINE ARE PROVIDED WITH THE BYPASS SWITCH

**DO NOT REMOVE THEM !**

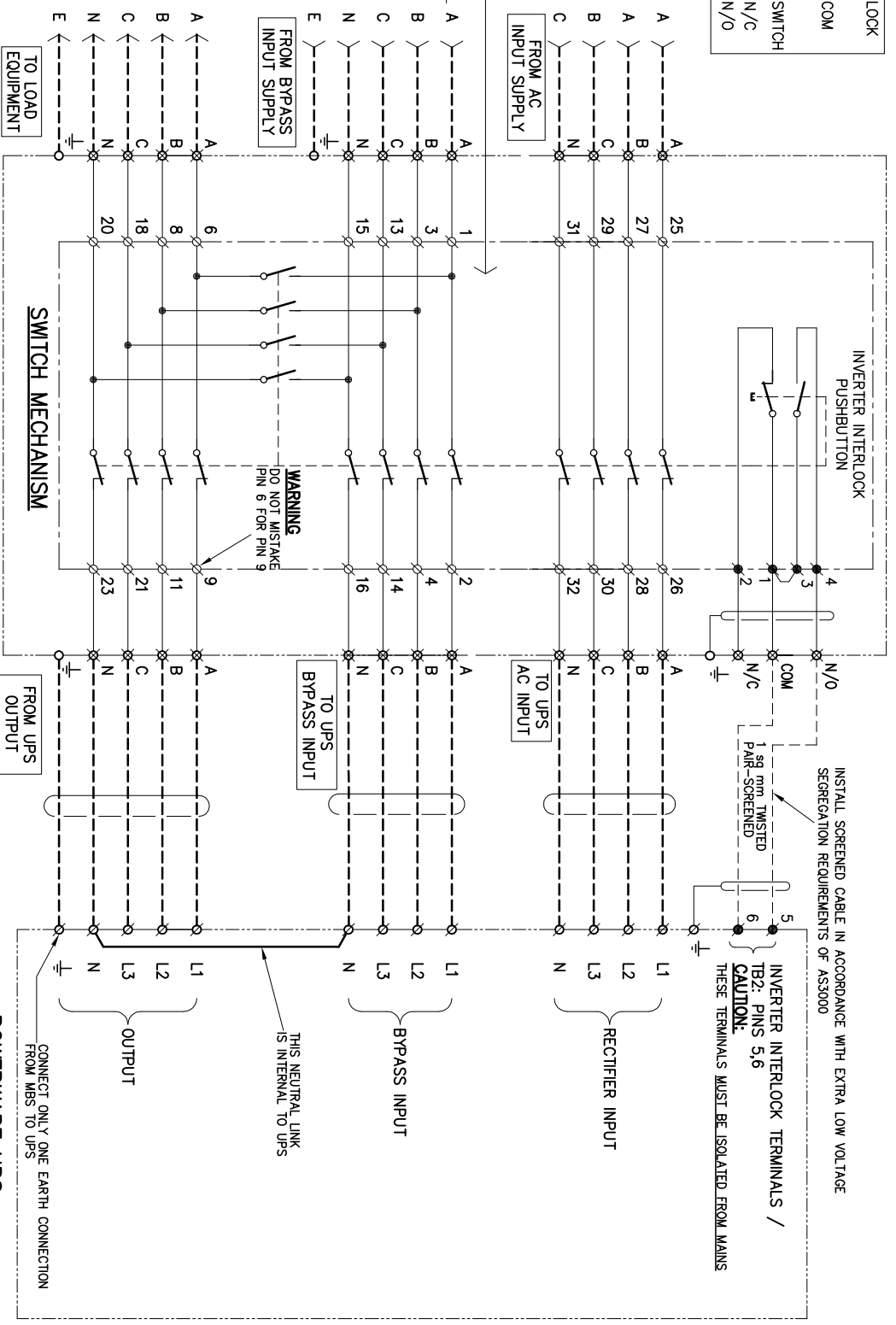

**BYPASS SWITCH ENCLOSURE**

**TERMINAL LEGEND**

- ⊗ DENOTES TERMINAL ON SWITCH
- ⊙ DENOTES TERMINAL ON UPS
- ⊗ DENOTES TERMINAL ON UPS FOR INVERTER SHUTDOWN
- ⊗ DENOTES TUNNEL TERMINALS
- DENOTES FIELD WIRING - NOT SUPPLIED WITH SWITCH OR UPS
- DENOTES M6 EARTH STUD

**DESCRIPTION**

RENAMED LABEL: RECTIFIER INPUT TO AC INPUT

REV.	DATE	DWN	CHK	APP
1	18.10.05	GA		

**EATON** | **Powerware**

EATON POWER QUALITY PTY. LTD.  
13 Healey Road, Sanderson, VIC 3175

THIRD ANGLE PROJECTION

UNLESS OTHERWISE SPECIFIED, ALL DIMENSIONS IN MILLIMETERS.

DRAWN	CHECKED	APPROVED	SCALE	FILENAME
GA			NTS	A4D0246Rev1.dwg

TITLE: Generic Wiring Diagram for MBS335BxxBW to suit 9340

DRAWING NUMBER: A4D0246

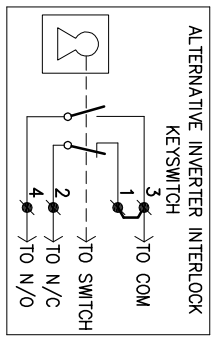

ALL LINKS INSIDE DOTTED LINE ARE PROVIDED WITH THE BYPASS SWITCH

**DO NOT REMOVE THEM !**

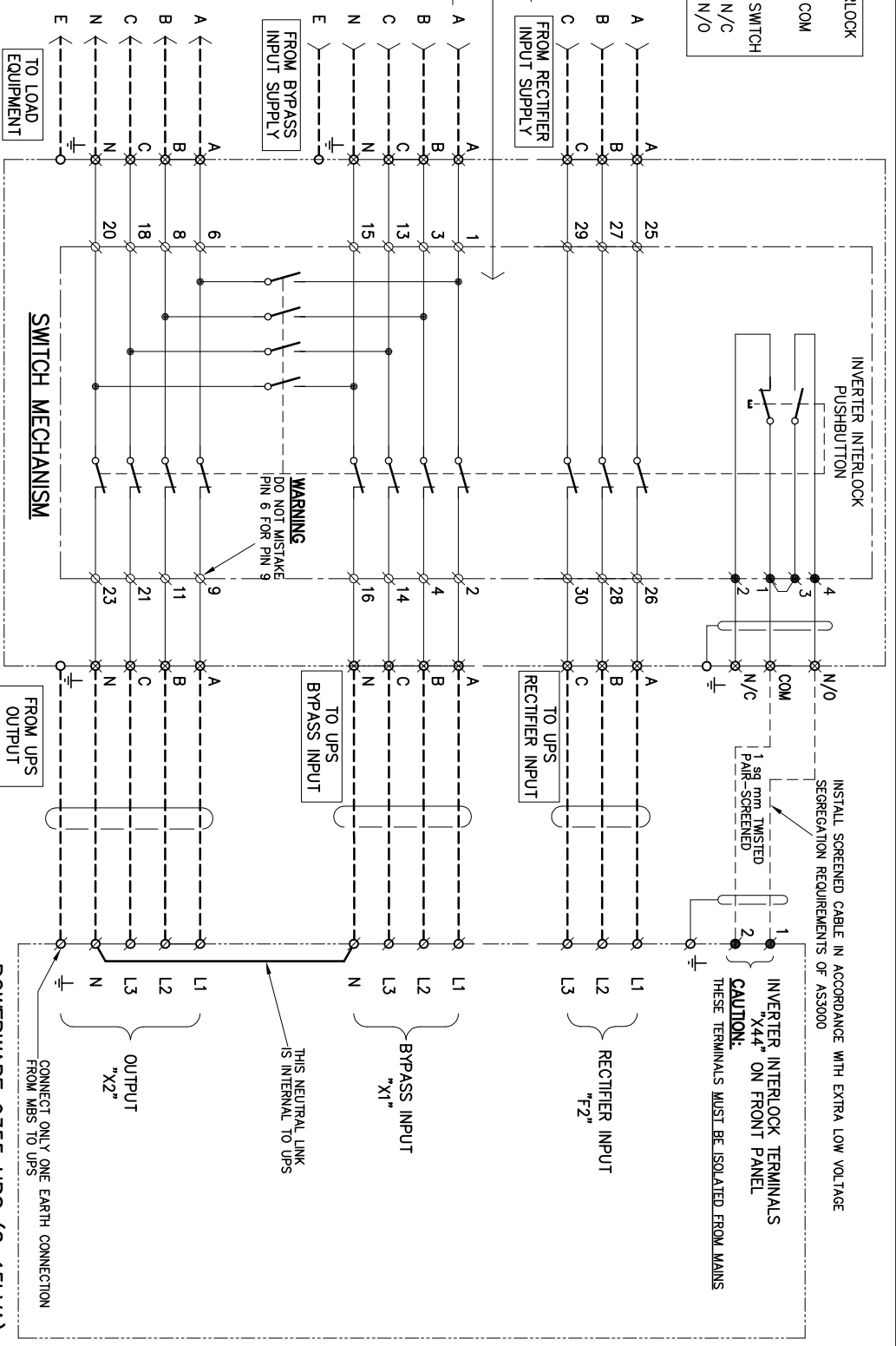

**TERMINAL LEGEND**

∅ DENOTES TERMINAL ON SWITCH

⊗ DENOTES TERMINAL ON UPS

⊗ DENOTES TUNNEL TERMINALS

● DENOTES TERMINAL ON SWITCH PUSHBUTTON

⊗ DENOTES TERMINAL ON UPS FOR INVERTER SHUTDOWN

--- DENOTES FIELD WIRING - NOT SUPPLIED WITH SWITCH OR UPS

○ DENOTES M6 EARTH STUD

**BYPASS SWITCH ENCLOSURE**

REVISIONS

REV.	DATE	DWN	CHK.	APP.	DESCRIPTION
1	4.7.06	GA			CHANGED INTERLOCK TO X44
2	5.1.07	GA			UPS TERMINAL LABELS

**EATON** | **Powerware**

EATON POWER QUALITY DIV. LTD.  
13 Hedley Road, Sanderson, VIC 3175

UNLESS OTHERWISE SPECIFIED, ALL DIMENSIONS IN MILLIMETERS.

DRAWN	CHECKED	APPROVED	SCALE	FILENAME:	
GA			NTS	A4D0247Rev1.dwg	
TITLE					A4
Generic Wiring Diagram for MBS335BxxxBW to suit 9355 (8-15kVA)					
DRAWING NUMBER					REV
A4D0247					2

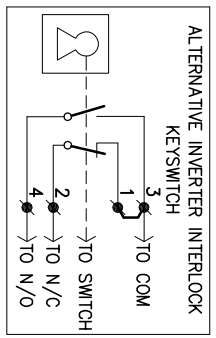

ALL LINKS INSIDE DOTTED LINE ARE PROVIDED WITH THE BYPASS SWITCH

**DO NOT REMOVE THEM !**

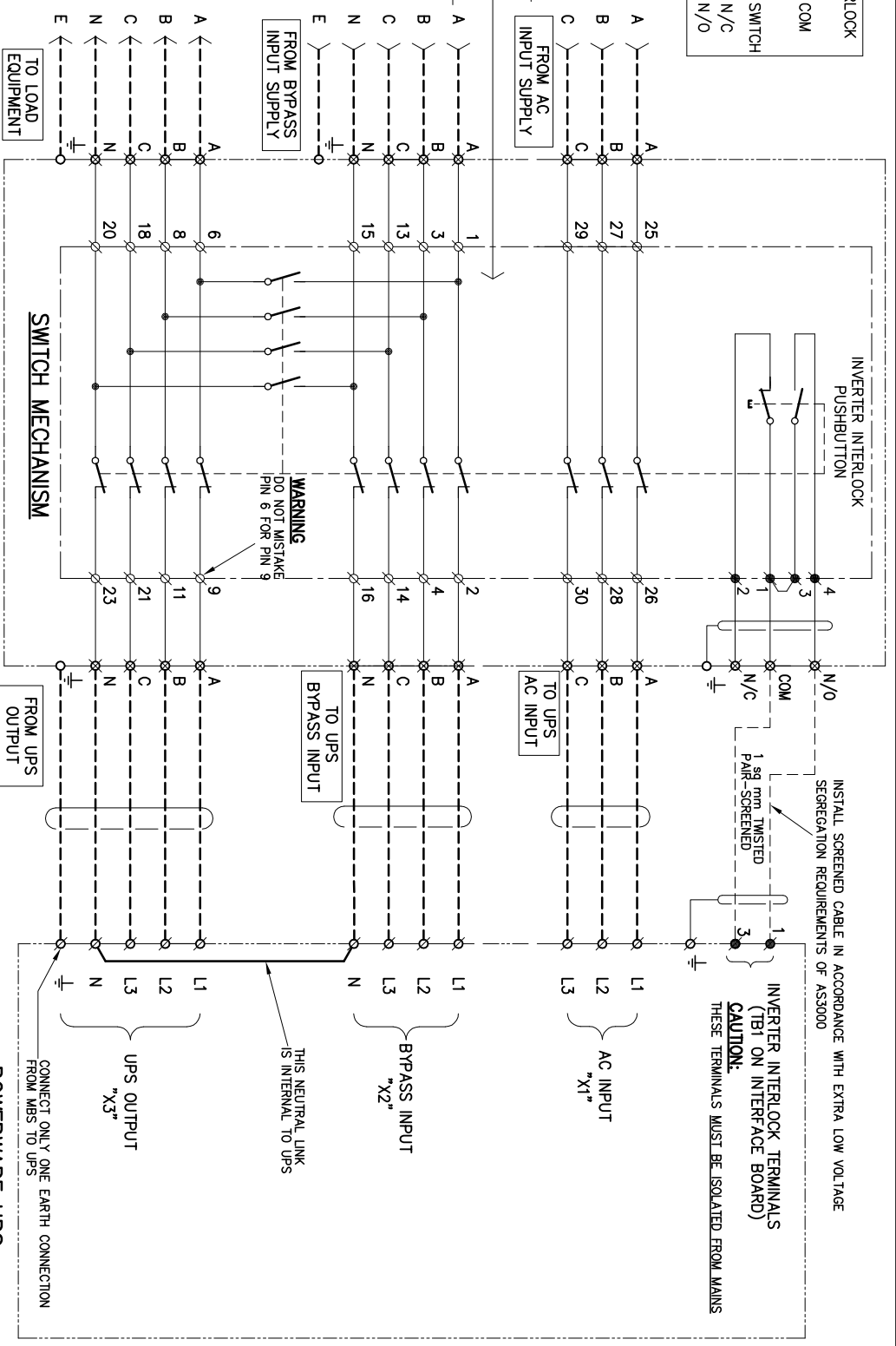

**TERMINAL LEGEND**

∅ DENOTES TERMINAL ON SWITCH

⊗ DENOTES TERMINAL ON UPS

⊗ DENOTES TUNNEL TERMINALS

● DENOTES TERMINAL ON SWITCH PUSHBUTTON

⊗ DENOTES TERMINAL ON UPS FOR INVERTER SHUTDOWN

--- DENOTES FIELD WIRING - NOT SUPPLIED WITH SWITCH OR UPS

○ DENOTES M6 EARTH STUD

**BYPASS SWITCH ENCLOSURE**

**POWERWARE UPS**

REV.	DATE	DWN	CHK	APP	DESCRIPTION
1	18.10.05	GA			RENAMED LABEL: RECTIFIER INPUT TO AC INPUT
2	9.6.06	GA			INVERTER INTERLOCK CONTACTS CHANGED
3	8.12.06	GA			TERMINAL TBI REVISED

**EATON** | **Powerware**

EATON POWER QUALITY PRTY. LTD.  
13 Hedley Road, Sanderson, VIC 3175

THIRD ANGLE PROJECTION

UNLESS OTHERWISE SPECIFIED, ALL DIMENSIONS IN MILLIMETERS.

DRAWN	CHECKED	APPROVED	SCALE	FILENAME:	
GA			NTS	A4D0262Rev3.dwg	
TITLE					A4
Generic Wiring Diagram for MBS335BxxBW to suit 9390 UPS					
DRAWING NUMBER					REV
A4D0262					3

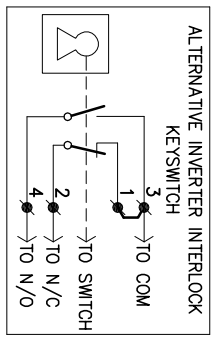

ALL LINKS INSIDE DOTTED LINE ARE PROVIDED WITH THE BYPASS SWITCH  
**DO NOT REMOVE THEM!**

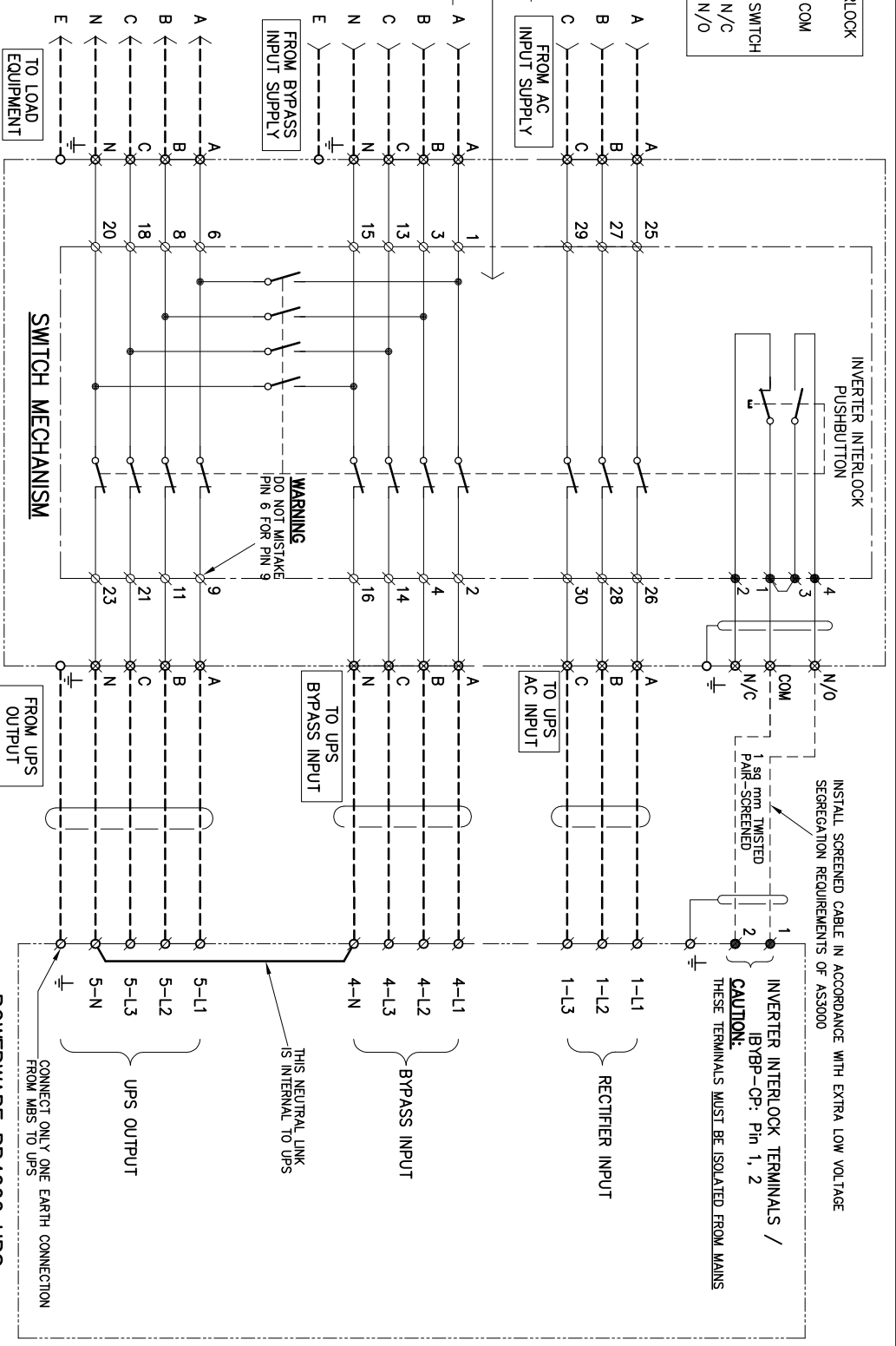

- TERMINAL LEGEND**
- ∅ DENOTES TERMINAL ON SWITCH
  - ⊗ DENOTES TERMINAL ON UPS
  - ⊗ DENOTES TUNNEL TERMINALS
  - DENOTES TERMINAL ON SWITCH PUSHBUTTON
  - ⊗ DENOTES TERMINAL ON UPS FOR INVERTER SHUTDOWN
  - DENOTES FIELD WIRING - NOT SUPPLIED WITH SWITCH OR UPS
  - DENOTES M6 EARTH STUD

**REVISIONS**

REV.	DATE	DWN	CHK	APP.	DESCRIPTION
1	18.10.05	GA			RENAMED LABEL: RECTIFIER INPUT TO AC INPUT
2	15.1.07	GA			INVERTER INTERLOCK



EATON POWER QUALITY PRT. LTD.  
13 Healey Road, Dunderrig, WC 3175

DRAWN	CHECKED	APPROVED	SCALE	FILENAME:	
GA			NTS	A4D0248Rev2.dwg	
TITLE					A4
Generic Wiring Diagram for MBS335BxxBW to suit PB4000					
DRAWING NUMBER					
A4D0248					
REV					2

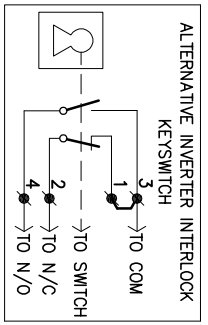

MUST BE THE SAME SOURCE AS THAT WHICH THE UPS DERIVES ITS BYPASS SUPPLY FROM

ALL LINKS INSIDE DOTTED LINE ARE PROVIDED WITH THE BYPASS SWITCH  
DO NOT REMOVE THEM !

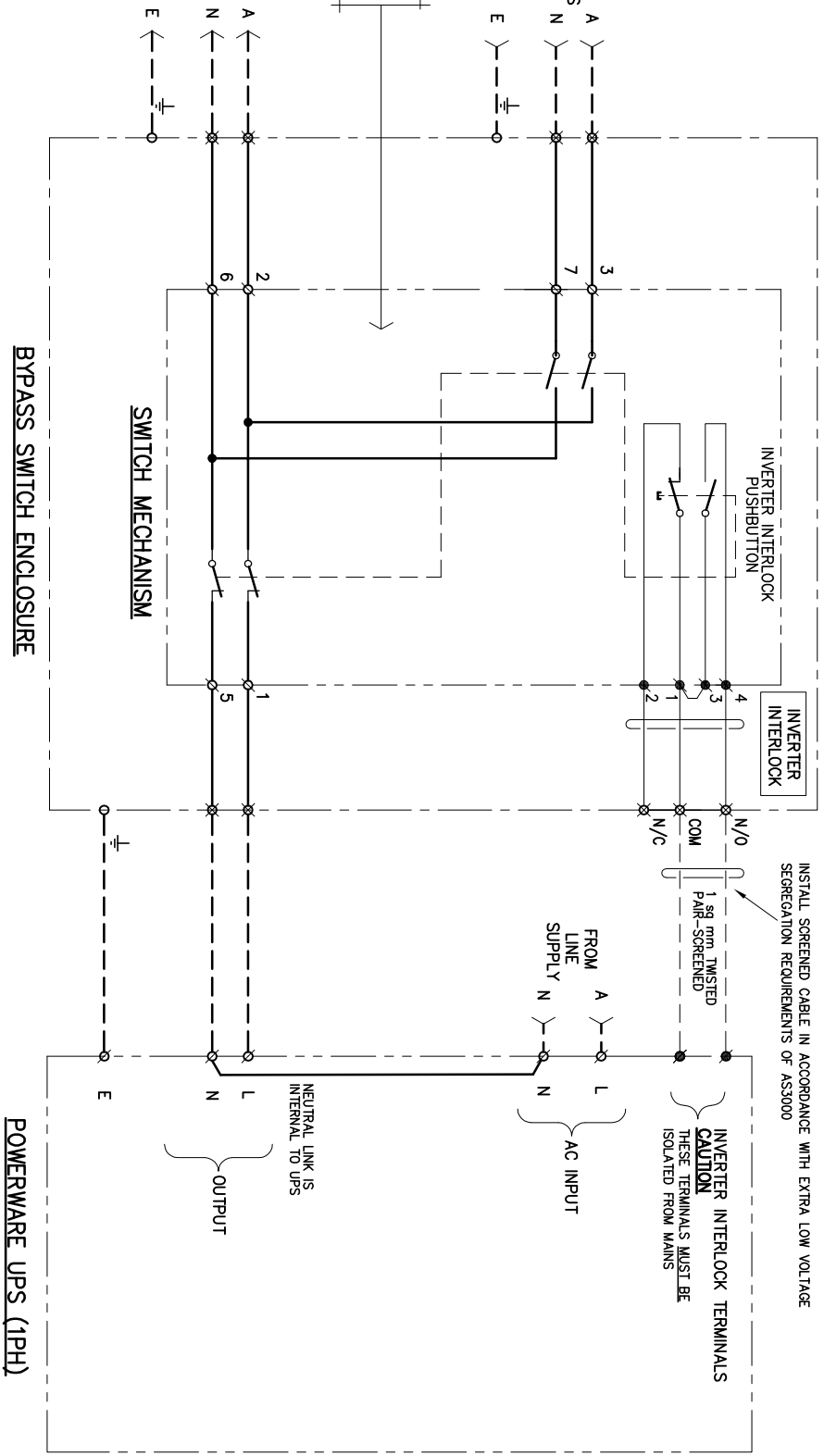

**TERMINAL LEGEND**

- ⊗ DENOTES TERMINAL ON SWITCH
- ⊙ DENOTES TERMINAL ON UPS
- ⊗ DENOTES TERMINAL ON UPS FOR INVERTER SHUTDOWN
- ⊙ DENOTES TUNNEL TERMINALS
- DENOTES M6 EARTH STUD
- DENOTES FIELD WIRING - NOT SUPPLIED WITH SWITCH OR UPS
- DENOTES TERMINAL LABEL ON BYPASS SWITCH ENCLOSURE

REV.	DATE	DWN	CHK	APP.	DESCRIPTION

REVISIONS



EATON POWER QUALITY PRTY. LTD.  
13 Healey Road, Sanderson, VIC 3175



UNLESS OTHERWISE SPECIFIED, ALL DIMENSIONS IN MILLIMETERS

DRAWN	CHECKED	APPROVED	SCALE	FILENAME:
HF			NTS	A4D0321Rev0.dwg
05.02.08				

WIRING AND CONNECTION DIAGRAM  
for MBS11TEXXBW TAIL-END BYPASS SWITCH  
WITH PUSHBUTTON INTERLOCK

DRAWING NUMBER  
A4D0321

A4

REV 0

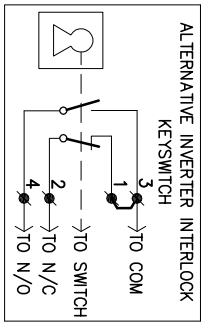

MUST BE THE SAME SOURCE AS THAT WHICH THE UPS DERIVES ITS BYPASS SUPPLY FROM

FROM BYPASS SUPPLY

ALL LINKS INSIDE DOTTED LINE ARE PROVIDED WITH THE BYPASS SWITCH  
**DO NOT REMOVE THEM !**

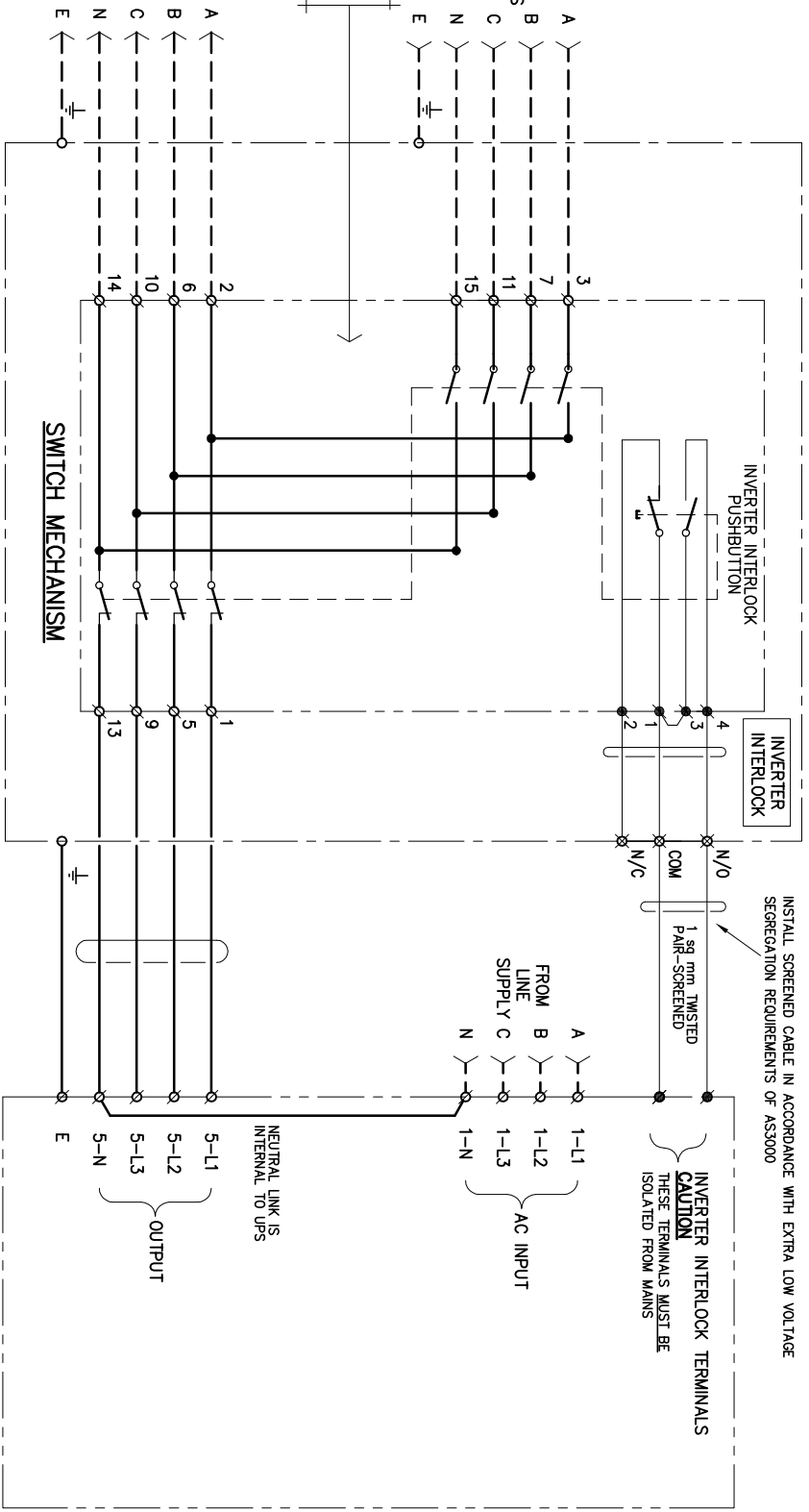

**BYPASS SWITCH ENCLOSURE**

**POWERWARE UPS (3-3PH)**

- TERMINAL LEGEND**
- ⊗ DENOTES TERMINAL ON SWITCH
  - ⊙ DENOTES TERMINAL ON UPS
  - ⊗ DENOTES TUNNEL TERMINALS
  - DENOTES FIELD WIRING - NOT SUPPLIED WITH SWITCH OR UPS
  - DENOTES TERMINAL LABEL ON BYPASS SWITCH ENCLOSURE

REV.	DATE	DWN	CHK	APP	DESCRIPTION
1	06.05.08	HF			PART No WAS MBS33TE315BW

REVISIONS

**EATON** | **Powerware**

EATON POWER QUALITY PTY. LTD.  
13 Healey Road, Sandhurst, VIC 3175

THIRD ANGLE PROJECTION

UNLESS OTHERWISE SPECIFIED, ALL DIMENSIONS IN MILLIMETERS.

**WIRING AND CONNECTION DIAGRAM for MBS33TE315BW TAIL-END BYPASS SWITCH WITH PUSHBUTTON INTERLOCK**

DRAWN: HF  
CHECKED: NTS  
APPROVED: NTS  
SCALE: A4  
FILENAME: A4D0319Rev1.dwg

DRAWING NUMBER: A4D0319

REV: 1