

Eaton Hansen™
Quick Disconnect Coupling Catalog

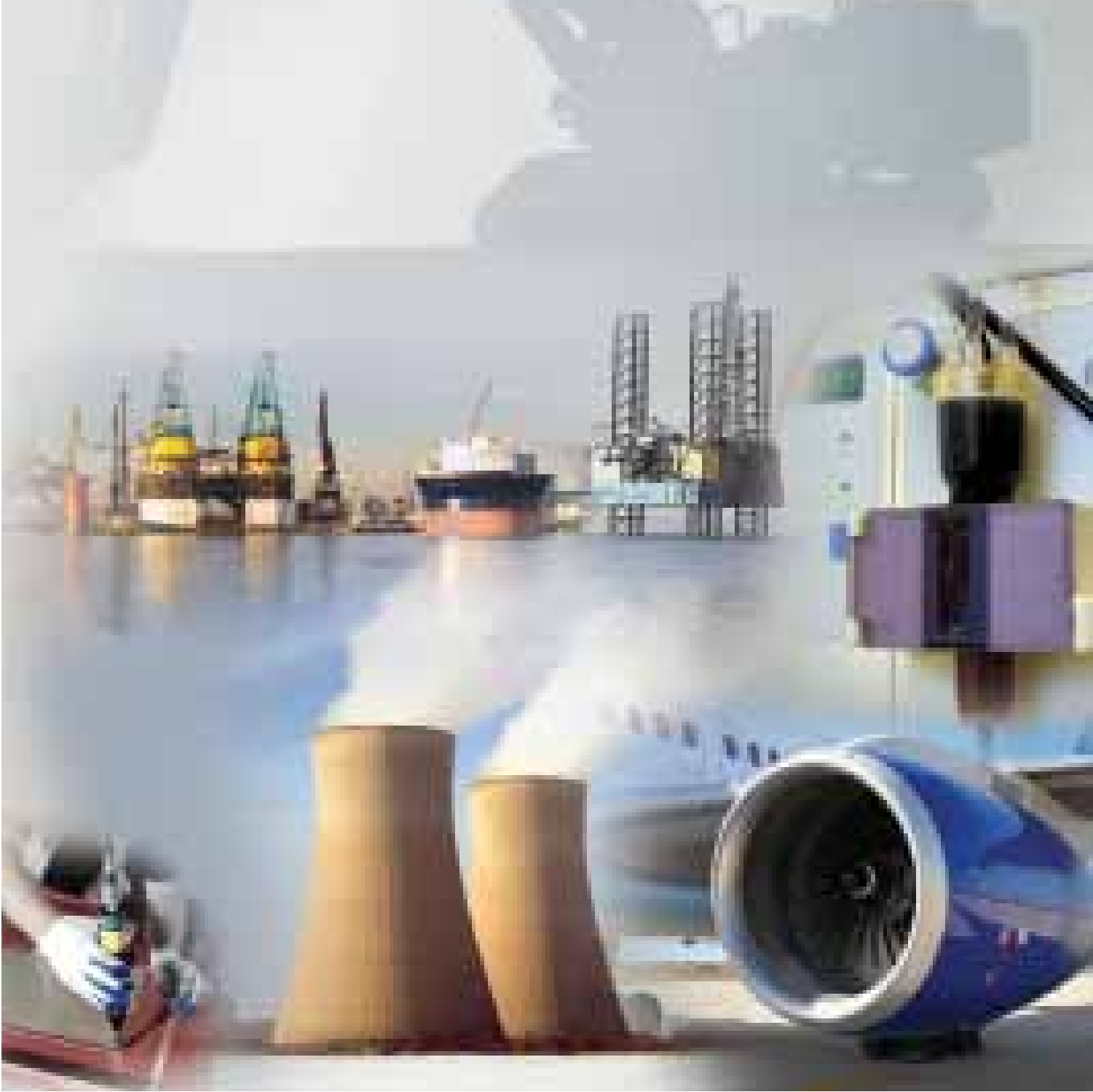

EATON
Powering Business Worldwide



Table of Contents

	Page Number
<i>How to Build a Socket Part No.</i>	3
<i>Market & Application Reference</i>	7

One-Way Shutoff Couplings

<i>Contents and Selection Chart</i>	6
<i>One-Way Plug Interchange Chart</i>	7
<i>CC Series</i>	8
<i>1000/400/500 Series</i>	9-12
<i>3000/4000/5000/6000 Series</i>	13-17
<i>P-30 & P-40 Series</i>	18
<i>Auto-Flo 23 & 24 Series</i>	19-21
<i>Safeline Series</i>	22
<i>180 & 280 Series</i>	23-24
<i>100 Series</i>	25-26
<i>600 & 700 Series</i>	27-29
<i>2RL & 3RL Series</i>	30-32
<i>Full Bore Series</i>	33-34
<i>210 & 310 Series</i>	35-36
<i>MS Series</i>	37-38

Two-Way Shutoff Couplings

<i>Contents and Selection Chart</i>	40
<i>HK 1-8 Series</i>	41-43
<i>HK 10, 12, 20 Series</i>	44-46
<i>HKFR Series</i>	47
<i>HA 15000 Series</i>	48-49
<i>FF Flat Face Series</i>	50-52
<i>5100 Series</i>	53
<i>UP10 Series</i>	54-55
<i>WA 56000 & HP3 Series</i>	56
<i>2-HKIG & 2-HKIL</i>	57-58
<i>DB Series</i>	59

Page Number

Straight Through Couplings

<i>Contents and Selection Chart</i>	61
<i>ST Series</i>	62-64
<i>P2-ST & P3-ST Series</i>	65
<i>FLO-TEMP 200/300/500 Series</i>	66-67

Gas Couplings

<i>Gas-Mate Series</i>	69
------------------------	----

Accessories

<i>FS Flow Sensor Series</i>	71
<i>In-Line Check Valves</i>	72
<i>Flex-Air Fittings</i>	73-74
<i>Fittings</i>	76
<i>Elastomer Selection Guide</i>	77

Index

<i>Technical & Warranty</i>	78
---------------------------------	----

Notes:

- 1) Some part numbers may be subject to minimum order quantities.
- 2) Options shown are not available for all parts and may only be available by quotation. Consult your local distributor.

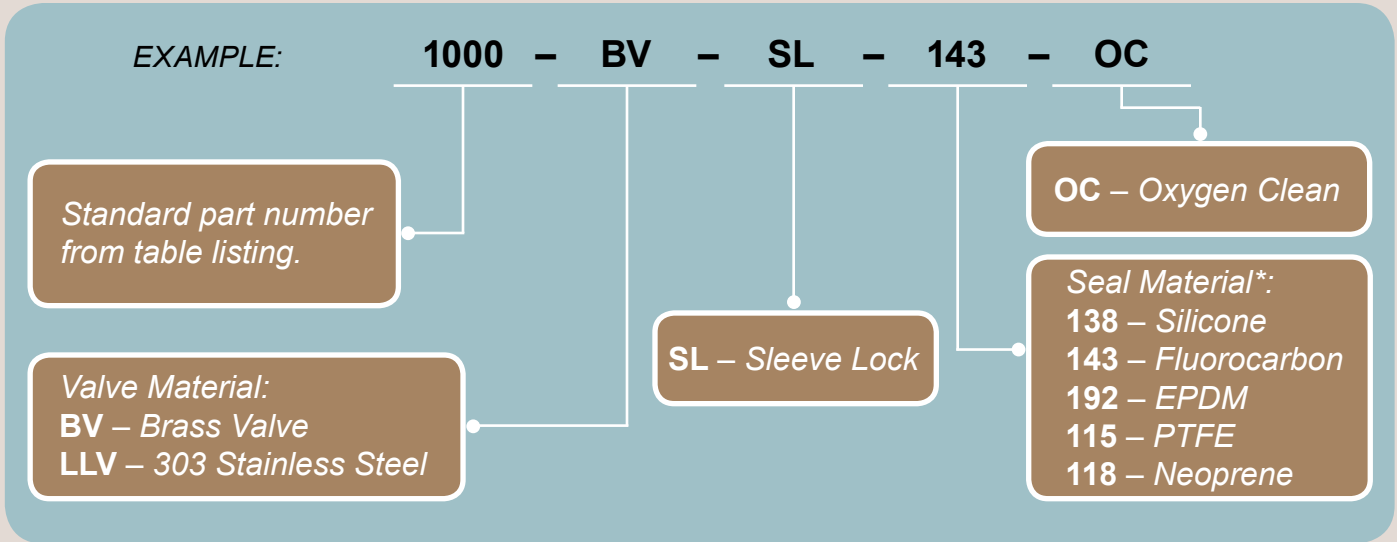

*See page 77 for full list, description and suggested uses for seal materials.
Not all seal materials available in all series.

CLEANING AND LUBRICATION PROCESS FOR GASEOUS OR OXYGEN SERVICE

<<< Part numbers cleaned for oxygen service should be denoted with an “OC” suffix >>>

This cleaning process applies to new and unused brass or stainless steel parts for 3000 psig (207 Bar) max oxygen or aluminum parts for 150 psig (10 Bar) max gaseous or oxygen service. It is based upon the recommended practices in ASTM G93 and CGA G-4.1 for cleaning, drying, inspection and packaging of materials and equipment intended for service in an oxygen-enriched environment. Eaton’s cleaning procedure for oxygen service is available upon request.

<p>⚠WARNING</p> <p>Over-pressurization could result in a sudden failure of the coupling causing severe bodily injury or death. Be sure to select the proper coupling for your application and use it only within the specified service pressure range.</p>	<p>⚠WARNING</p> <p>Couplings do wear out. In order to avoid severe bodily injury or death, couplings must be routinely checked for condition and replaced if necessary.</p>
---	--

Market and Application Reference Guide



Aerospace



Agriculture



Breathing Air



Carpet Cleaning



Chemical



Construction



Defense



Energy and Power



Food and Beverage



General Pneumatics



Heating/Cooling/Refrigeration



Injection Molding



Marine



Medical



Mining



Petrochemical



Pharmaceutical



Recreation and Entertainment



Transportation



Water and Wastewater Treatment

Eaton is Proud to Hold the Following Certifications:

ISO 9001:2000



Certificate No. 006888

CRN CANADIAN REGISTRATION NUMBER

Eaton is CRN certified for all non-nuclear applications in all of the Canadian provinces for our Hansen™ coupling products. Ontario Regulation 220/01 for Boilers and Pressure Vessels in Paragraph 4, states requirements for Design Registration. Eaton is the only coupling manufacturer that has achieved this registration. Our CRN is OA11599.5C and our approval is valid until 2017.

PROUD MEMBERS OF:



NFPA
Solutions through
motion technology





ONE-WAY



Contents and Selector Chart



Coupling Series	Page	Coupling Style			Interchange				Body Size					Body Material				Locking Mechanism				Options			
		MANUAL CONNECT	PUSH-TO-CONNECT	SAFETY COUPLING	INDUSTRIAL INTERCHANGE	ARO 210/310	TRU-FLATE	CEJN 320/RECTUS 25	HANSEN UNIQUE DESIGN	1/8 INCH	1/4 INCH	3/8 INCH	1/2 INCH	3/4 INCH	ALUMINUM	BRASS	STEEL (Zinc/chromate Finish)	STAINLESS STEEL	PLASTIC (Acetal)	BALL LOCK	PIN LOCK	RING LOCK	PLASTIC FINGERS	SLEEVE LOCK	SEAL MATERIALS (Various)
CC	8		●	●	●	●	●			●	●					●		◆					▼		
1000	10	●			●					●					●		●			●			●	●	●
400	11	●			●		●				●				●				●				●	●	●
500	12	●			●							●			●				●				●	●	
3000	14		●		●					●					●					●			●	●	●
4000	15		●		●						●				●					●			●	●	●
5000	16		●		●							●			●					●			●	●	
6000	17		●		●								●		●					●			●	●	
P30	18		●		●					●								●				●			
P40	18		●		●						●							●				●			
Auto-Flo 23	20		●		●	●	●			●					●				●						
Auto-Flo 24	21		●				●			●					●				●						
Safeline	22		●	●	●					●				●		●			●						
180/280	23/24	●						●	●						●				●					●	
100	25/26	●						●	●						●				●				●	●	●
600/700	27	●						●	●						●				●				●		●
2RL	31		●					●	●							●					●	▼	●	●	
3RL	32		●					●		●						●				●		▼	●	●	
Full-Bore	33/34		●	●	●					●	●	●				●			●			▼			
210	35/36		●			●				●						●				●					
310	35/36		●			●					●					●				●					
MS	37/38		●		●					●						●				●					

▼ Sleeve lock is standard

◆ Polymer Sleeves

One-Way Plug Interchange Chart

The plug profiles shown below are actual size. This chart can be used to help select Eaton one-way couplings. The bottom row of this chart and the 180/280 are unique Eaton plug designs.

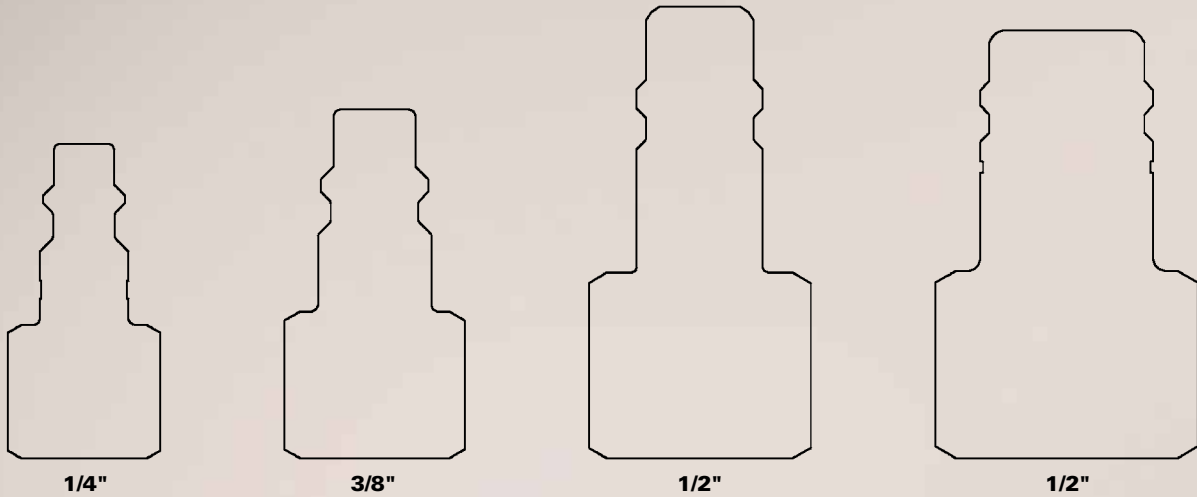

Industrial Interchange

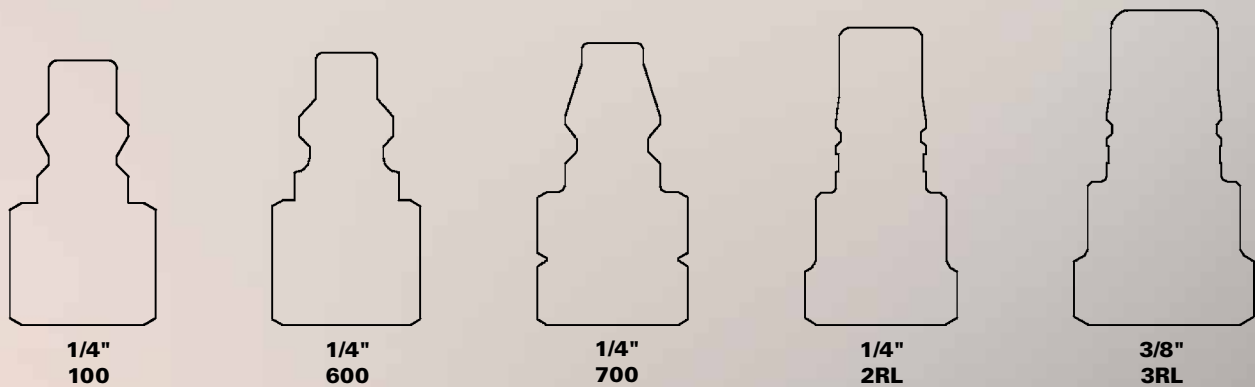
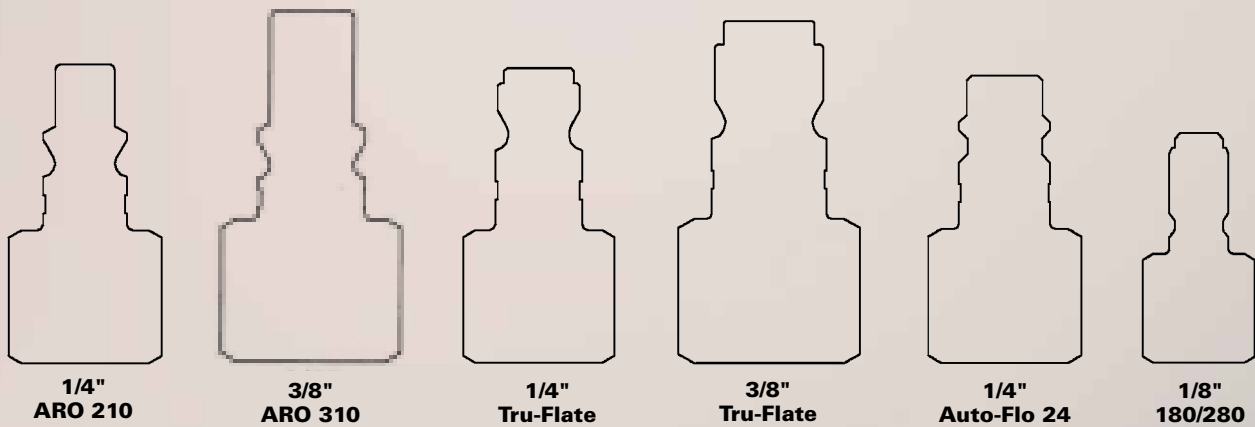

ONE-WAY

TWO-WAY

STRAIGHT-THRU

GAS

ACCESSORIES

CC Series



The **CC Series** provides unrestricted air flow, safety, efficiency and extreme durability all in one pneumatic coupling.

FEATURES

- Two-sleeve activation for safety
- Exceeds stringent cycle testing requirements without leakage
- Withstands 4,500 pounds of external force without cracking
- The safe choice for your employees due to safety venting that prevents hose whip
- Helps prevent scratches on finished product surfaces
- Does not noticeably increase the weight of the tool when attached, which helps prevent user strain and fatigue, increasing workplace productivity
- The socket can accept multiple plug configurations, making it extremely flexible

APPLICATIONS & MARKETS

- Air Tools
- General Pneumatics

Part Number	Body Size	Thread Size	Rated Air Flow	Interchanges
2CC25F	1/4"	1/4" Female NPT	34 SCFM	Industrial, ARO 210, Tru-Flate
2CC37F	1/4"	3/8" Female NPT	34 SCFM	Industrial, ARO 210, Tru-Flate
3CC25F	3/8"	1/4" Female NPT	60 SCFM	Industrial, ARO 310
3CC37F	3/8"	3/8" Female NPT	60 SCFM	Industrial, ARO 310
3CC50F	3/8"	1/2" Female NPT	60 SCFM	Industrial, ARO 310
24CC25F	1/4"	1/4" Female NPT	53 SCFM	CEJN 320, Rectus 25
24CC37F	1/4"	3/8" Female NPT	53 SCFM	CEJN 320, Rectus 25
24CC25FBS	1/4"	1/4" Female BSP	53 SCFM	CEJN 320, Rectus 25



Interchangeability

2CC	24CC	3CC
Industrial	CEJN 320	Industrial
ARO 210	RECTUS 25	ARO 310
Tru-Flate		



Materials

- Non-marring polymer sleeves and rounded ends
- Nickel plated brass and crush resistant polymer



1/4" to 3/8" nominal
(6.35 mm to 8 mm)



Rated Pressure

Series	PSI	BAR
2CC	250	17
3CC	250	17
24CC	250	17



Flow Capacity

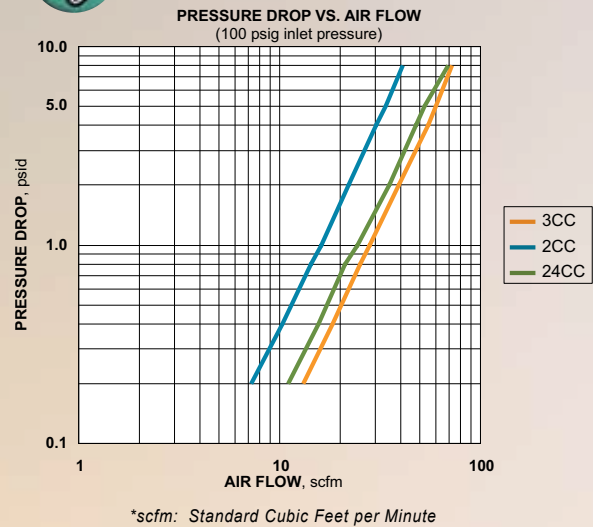



Industrial Interchange Ball Lock quick connect couplings are designed for compressed air, gases, and liquids. Body sizes are 1/4", 3/8" and 1/2".

FEATURES

- Ball lock
- Manual operation
- Rugged, reliable
- All sizes accept US Industrial Interchange; 1/4" and 1/2" also accept ISO 6150 Series B and A-A-59439 (former MIL-C-4109) plugs
- Optional sleeve lock prevents accidental disconnection
- Optional seal and valve materials available
- Series 1000 socket available in stainless steel
- Series 400 sockets accept Tru-Flate Interchange plugs and Industrial Interchange plugs

APPLICATIONS & MARKETS

- General Pneumatics
- Industrial Plants
- Construction
- Fluid Transfer

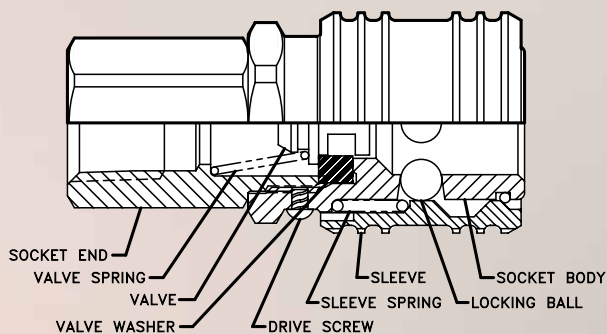

Shown with optional sleeve lock



Interchangeability

All Sizes	1/4" & 1/2"	400 Series
US Industrial Interchange	ISO 6150 Series B A-A-59439 (former MIL-C-4109)	Tru-Flate



Materials

Socket:

- Brass Body
- Nickel Plated Steel Sleeve
- Zinc Plated Steel Valve
- Buna-N (Nitrile) Seal
- Stainless Steel Springs
- Stainless Steel Locking Balls

Plug:

- Zinc Plated Case-Hardened Steel
- Brass
- Stainless Steel (1/4" size)



**1/4" to 1/2" nominal
(6.35 mm to 12.7 mm)**



**-40° F to 250° F
-40° C to 120° C**



Rated Pressure

Series	Size	PSI	BAR
1000	1/4"	2,000	138
400	3/8"	1,000	69
500	1/2"	500	35

NOTE:
Series 400 operating pressure is 150 psi when connected to Tru-Flate Interchange plug.



Flow Capacity

Series	†Ac
1000	24
400	45
500	72

† Air flow (scfm) with 5 psi pressure drop and 100 psig inlet pressure.

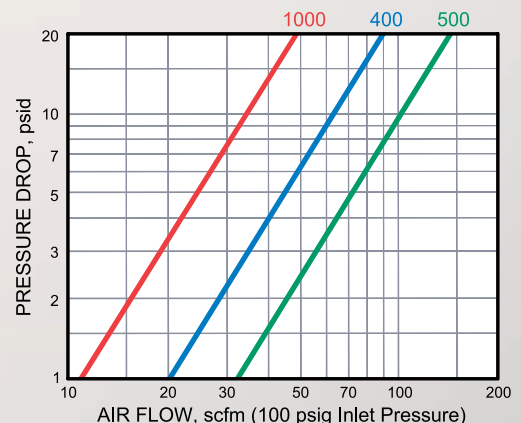

1000 Series

SOCKETS

Part No.	Thread Size	Dimensions		
		A	B	HEX
Brass				
900	1/8-27 NPTF	1.97	1.00	0.69
1100	1/4-18 NPTF	2.16	1.00	0.69
1300	3/8-18 NPTF	2.12	1.00	0.69
Stainless				
LL1100	1/4-18 NPTF	2.16	1.00	0.69

Male End Connections

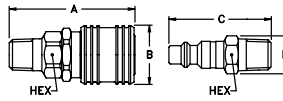

PLUGS

Part No.	Thread Size	Dimensions		
		C	D	HEX
Steel				
10	1/4-18 NPTF	1.75	0.65	0.56
10C§	1/4-18 NPTF	1.75	0.65	0.56
10G†	1/4-18 NPTF	1.75	0.65	0.56
12	1/8-27 NPTF	1.59	0.58	0.50
12G†	1/8-27 NPTF	2.38	0.77	0.69
14	3/8-18 NPTF	1.75	0.79	0.69
14G†	3/8-18 NPTF	2.53	0.77	0.69
Brass				
B10	1/4-18NPTF	1.75	0.64	0.56
Stainless				
LL10	1/4-18 NPTF	1.75	0.65	0.56

Part No.	Thread Size	Dimensions		
		A	B	HEX
Brass				
800	1/8-27 NPTF	1.86	1.00	0.69
1000	1/4-18 NPTF	2.08	1.00	0.69
1200	3/8-18 NPTF	2.16	1.00	0.75
Stainless				
LL1000	1/4-18 NPTF	2.08	1.00	0.69

Female End Connections

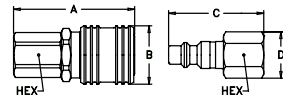

Part No.	Thread Size	Dimensions		
		C	D	HEX
Steel				
11	1/4-18 NPTF	1.63	0.79	0.69
11G†	1/4-18 NPTF	2.44	0.77	0.69
13	1/8-27 NPTF	1.47	0.65	0.56
15	3/8-18 NPTF	1.69	0.94	0.81
Brass				
11B	1/4-18 NPTF	1.63	0.78	0.69
Stainless				
LL11	1/4-18 NPTF	1.63	0.79	0.69

Part No.	Hose I.D.	Dimensions	
		A	B
1600	1/4"	2.60	1.00
1600P‡	1/4"	2.37	1.00
1700	3/8"	2.60	1.00
1700P‡	3/8"	2.44	1.00
1800	5/16"	2.60	1.00

Hose Stem End Connections

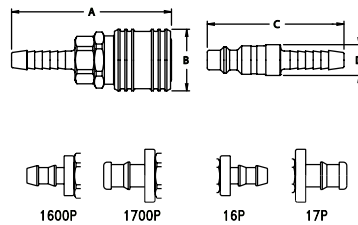

Part No.	Hose I.D.	Dimensions	
		C	D
Steel			
16	1/4"	2.22	0.50
16G†	1/4"	2.97	0.77
16P‡	1/4"	2.00	0.69
17	3/8"	2.22	0.50
17G†	3/8"	2.96	0.77
17P‡	3/8"	2.06	0.87
18	5/16"	2.22	0.50
Brass			
B17	3/8"	2.22	0.50

Part No.	Hose		Dimensions		
	I.D.	O.D.	A	B	HEX
1SB1	1/4"	15/32"	2.69	1.00	0.63
1SB3	1/4"	1/2"	2.69	1.00	0.63
1SB5	1/4"	9/16"	2.69	1.00	0.69
1SB7	1/4"	5/8"	2.69	1.00	0.75
1SC5	5/16"	9/16"	2.81	1.00	0.69
1SC7	5/16"	5/8"	2.81	1.00	0.75
1SD5	3/8"	9/16"	2.81	1.00	0.69
1SD7	3/8"	5/8"	2.81	1.00	0.75
1SD9	3/8"	11/16"	2.81	1.00	0.81
1SD11	3/8"	3/4"	2.81	1.00	0.88

Hose Clamp End Connections

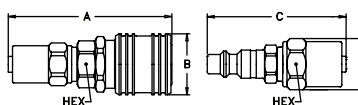

Part No.	Hose		Dimensions		
	I.D.	O.D.	C	D	HEX
Steel					
3PB1	1/4"	15/32"	2.31	0.70	0.63
3PB3	1/4"	1/2"	2.31	0.70	0.63
3PB5	1/4"	9/16"	2.31	0.77	0.69
3PB7	1/4"	5/8"	2.31	0.84	0.75
3PB11	1/4"	3/4"	2.31	0.98	0.88
3PC5	5/16"	9/16"	2.38	0.77	0.69
3PC7	5/16"	5/8"	2.38	0.84	0.75
3PC9	5/16"	11/16"	2.38	0.91	0.81
3PD5	3/8"	9/16"	2.44	0.77	0.69
3PD7	3/8"	5/8"	2.44	0.84	0.75
3PD9	3/8"	11/16"	2.44	0.91	0.81
3PD11	3/8"	3/4"	2.44	1.98	0.88

* 45° Male Flare § With Ball Check † With Bleeder Ball Check – Reduces hose whip when disconnecting ‡ For use with push-on style hose

Optional Seal Materials: 138-Silicone, 143-Fluorocarbon, 192-EPDM

SOCKETS

Part No.	Thread Size	Dimensions		
		A	B	HEX
410	1/4-18 NPTF	2.35	1.13	0.88
430	3/8-18 NPTF	2.35	1.13	0.88
450	1/2-14 NPTF	2.54	1.13	0.88

Male End Connections

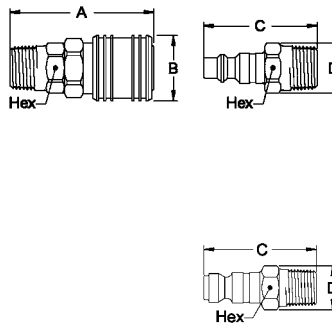

PLUGS

Part No.	Thread Size	Dimensions		
		C	D	HEX
Steel				
38	1/8-27 NPTF	1.72	0.72	0.63
40	1/4-18 NPTF	1.88	0.72	0.63
40G†	1/4-18 NPTF	2.65	0.77	0.69
42	3/8-18 NPTF	1.88	0.79	0.69
42G†	3/8-18 NPTF	2.65	0.77	0.69
44	1/2-14 NPTF	2.09	1.01	0.88
Brass				
B40	1/4-18 NPTF	1.88	0.70	0.63
B42	3/8-18 NPTF	1.88	0.77	0.69
Steel				
31AP25M	1/4-18 NPTF	1.85	0.72	0.63
31AP37M	3/8-18 NPTF	1.85	0.79	0.69

Female End Connections

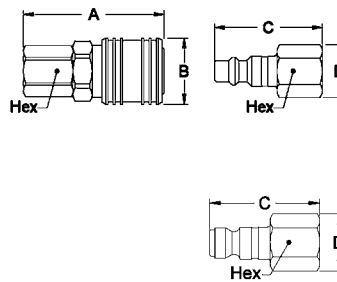

Part No.	Thread Size	Dimensions		
		A	B	HEX
400	1/4-18 NPTF	2.10	1.13	0.88
420	3/8-18 NPTF	2.35	1.13	0.88
440	1/2-14 NPTF	2.62	1.13	1.00

Part No.	Thread Size	Dimensions		
		C	D	HEX
Steel				
41	1/4-18 NPTF	1.63	0.79	0.69
41G†	1/4-18 NPTF	2.56	0.77	0.69
43	3/8-18 NPTF	1.81	0.94	0.81
43G†	3/8-18 NPTF	2.62	0.84	0.75
45	1/2-14 NPTF	2.06	1.15	1.00
Brass				
B43	3/8-18 NPTF	1.81	0.91	0.81
Steel				
31AP25F	1/4-18 NPTF	1.60	0.79	0.69
31AP37F	3/8-18 NPTF	1.78	0.94	0.81

Hose Stem End Connections

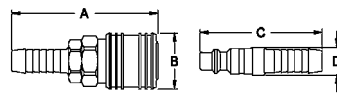

Part No.	Hose I.D.	Dimensions	
		A	B
4004	1/4"	2.82	1.13
4006	3/8"	2.82	1.13
4008	1/2"	2.82	1.13

Part No.	Hose I.D.	Dimensions	
		C	D
Steel			
404	1/4"	2.34	0.63
406	3/8"	2.34	0.63
408	1/2"	2.34	0.81
Brass			
B406	3/8"	2.34	0.63

Hose Clamp End Connections

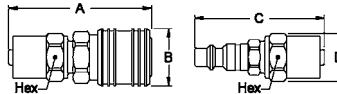

Part No.	Hose		Dimensions		
	I.D.	O.D.	A	B	HEX
40SD7	3/8"	5/8"	3.04	1.13	0.75
40SD9	3/8"	11/16"	3.04	1.13	0.81
40SD11	3/8"	3/4"	3.04	1.13	0.88
40SP13	1/2"	13/16"	3.67	1.13	0.94
40SP15	1/2"	7/8"	3.67	1.13	1.00
40SP19	1/2"	1"	3.67	1.13	1.13

Part No.	Hose		Dimensions		
	I.D.	O.D.	C	D	HEX
Steel					
4PB3	1/4"	1/2"	2.44	0.70	0.63
4PB7	1/4"	5/8"	2.44	0.84	0.75
4PD7	3/8"	5/8"	2.56	0.84	0.75
4PD9	3/8"	11/16"	2.56	0.91	0.81
4PD11	3/8"	3/4"	2.56	0.98	0.88
4PP13	1/2"	13/16"	3.25	1.05	0.94
4PP15	1/2"	7/8"	3.25	1.12	1.00

† With Bleeder Ball Check – Reduces hose whip when disconnecting

Dust Plugs Accessories:

Coupling Series	Socket Dust Plug Part No.
1000	PSDC1HK
400	PSDC2HK



Vinyl Dust Plug

Optional Seal Materials:

- 138-Silicone,
- 143-Fluorocarbon,
- 192-EPDM

ONE-WAY

TWO-WAY

STRAIGHT-THRU

GAS

ACCESSORIES

500 Series

SOCKETS

Part No.	Thread Size	Dimensions		
		A	B	HEX
501	1/4-18 NPTF	2.77	1.19	1.00
510	3/8-18 NPTF	2.78	1.19	1.00
530	1/2-14 NPTF	2.97	1.19	1.00
550	3/4-14 NPTF	2.97	1.19	1.06

Male End Connections

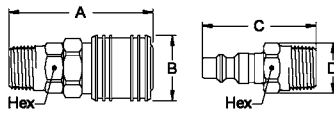

PLUGS

Part No.	Thread Size	Dimensions		
		C	D	HEX
50	1/4-18 NPTF	2.25	0.79	0.69
50G†	1/4-18 NPTF	2.90	0.98	0.88
52	3/8-18 NPTF	2.25	0.87	0.75
52G†	3/8-18 NPTF	2.90	0.98	0.88
54	1/2-14 NPTF	2.44	1.01	0.88
54G†	1/2-14 NPTF	3.09	0.98	0.88
56	3/4-14 NPTF	2.50	1.23	1.06
56G†	3/4-14 NPTF	3.14	1.19	1.06
Brass				
B52	3/8-18 NPTF	2.25	0.70	0.63
B54	1/2-14 NPTF	2.44	0.77	0.88

Part No.	Thread Size	Dimensions		
		A	B	HEX
500A	1/4-18 NPTF	2.72	1.19	1.00
500	3/8-18 NPTF	2.78	1.19	1.00
520	1/2-14 NPTF	3.06	1.19	1.00
540	3/4-14 NPTF	3.09	1.19	1.19

Female End Connections

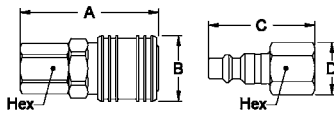

Part No.	Thread Size	Dimensions		
		C	D	HEX
53A	1/4-18 NPTF	1.92	0.79	0.69
53	3/8-18 NPTF	2.06	0.94	0.81
53G†	3/8-18 NPTF	2.90	0.98	0.88
55	1/2-14 NPTF	2.34	1.15	1.00
55G†	1/2-14 NPTF	3.17	0.98	0.88
57	3/4-14 NPTF	2.44	1.37	1.19

Part No.	Hose I.D.	Dimensions	
		A	B
570	3/8"	3.32	1.19
580	1/2"	3.24	1.19
590	3/4"	4.09	1.19

Hose Stem End Connections

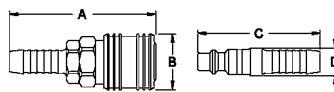

Part No.	Hose I.D.	Dimensions	
		C	D
585	5/16"	2.66	0.69
585G†	5/16"	3.37	0.98
59	3/8"	2.66	0.69
59G†	3/8"	3.37	0.98
60	1/2"	2.66	0.75
60G†	1/2"	3.37	0.98
61	3/4"	3.50	1.00
61G†	3/4"	4.22	0.98
Brass			
B60	1/2"	2.75	0.88

Part No.	Hose		Dimensions		
	I.D.	O.D.	A	B	HEX
50SP13	1/2"	13/16"	4.09	1.19	0.94
50SP15	1/2"	7/8"	4.09	1.19	1.00
50SR23	3/4"	11/8"	4.22	1.40	1.25
50SR25	3/4"	13/16"	4.22	1.47	1.31

Hose Clamp End Connections

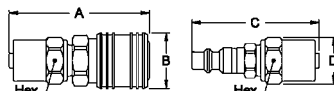

Part No.	Hose		Dimensions		
	I.D.	O.D.	C	D	HEX
5PB3	1/4"	1/2"	2.81	0.70	0.63
5PB7	1/4"	5/8"	2.81	0.84	0.75
5PD5	3/8"	9/16"	2.94	0.77	0.69
5PD7	3/8"	5/8"	2.94	0.84	0.75
5PD9	3/8"	11/16"	2.94	0.91	0.81
5PD11	3/8"	3/4"	2.94	0.98	0.88
5PD13	3/8"	13/16"	2.94	1.05	0.94
5PP13	1/2"	13/16"	3.62	1.05	0.94
5PP15	1/2"	7/8"	3.62	1.12	1.00
5PR23	3/4"	11/8"	3.75	1.40	1.25
5PR25	3/4"	13/16"	3.75	1.47	1.31
5PR27	3/4"	11/4"	3.75	1.54	1.38

† With Bleeder Ball Check – Reduces hose whip when disconnecting

Optional Seal Materials: 143-Fluorocarbon, 192-EPDM



Industrial Interchange Pin Lock

couplings designed for compressed air, gases, and liquids. Body sizes are 1/4", 3/8", 1/2" and 3/4".

FEATURES

- The original automatic one-way shutoff coupling designed by Hansen—The Industry Standard
- Easy, automatic, push-to-connect design provides instantaneous connection and disconnection of lines, plus automatic shut-off of socket end of line
- All sizes accept US Industrial Interchange; 1/4" and 1/2" also accept ISO 6150 Series B and A-A-59439 (former MIL-C-4109) plugs
- Optional sleeve lock prevents accidental disconnection
- Optional seal and valve materials available

APPLICATIONS & MARKETS

- Industrial Breathing Air
- Maintenance & Repair
- General Pneumatics
- Fluid Transfer

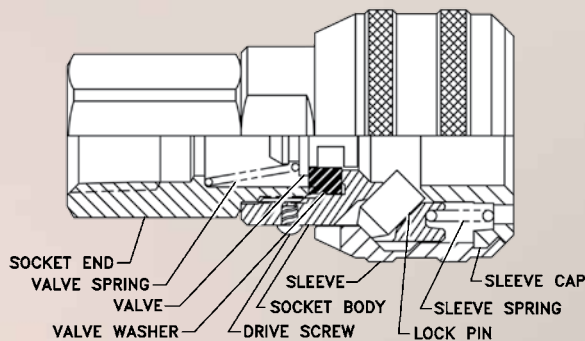

Shown with optional sleeve lock.



Interchangeability

All Sizes	1/4" & 1/2"
US Industrial Interchange	ISO 6150 Series B
	A-A-59439 (former MIL-C-4109)



Materials

Socket:

- Brass Body
- Zinc Plated Steel Valve
- Buna-N (Nitrile) Seal
- Stainless Steel Springs
- Stainless Steel Locking Pins

Plug:

- Zinc Plated Case-Hardened Steel
- Brass
- Stainless Steel (1/4" only)



1/4" to 3/4" nominal
(6.35 mm to 19.05 mm)



-40° F to 250° F
-40° C to 120° C



Rated Pressure

Series	Size	PSI	BAR
3000	1/4"	2,000	138
4000	3/8"	1,000	69
5000	1/2"	500	35
6000	3/4"	220	15



Flow Capacity

Series	†Ac
3000	24
4000	45
5000	72
6000	125

† Air flow (scfm) with 5 psi pressure drop and 100 psig inlet pressure.

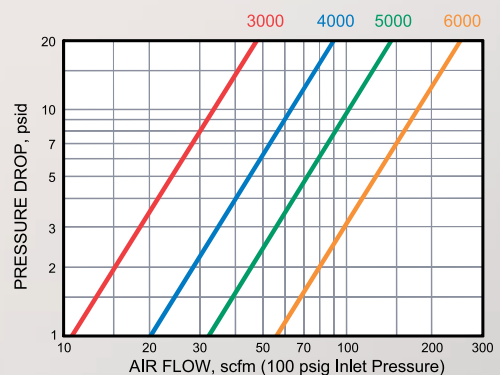

3000 Series

SOCKETS

Part No.	Thread Size	Dimensions		
		A	B	HEX
2900	1/8-27 NPTF	2.00	1.19	0.69
3100	1/4-18 NPTF	2.19	1.19	0.69
3300	3/8-18 NPTF	2.15	1.19	0.69
300043*	7/16-20	2.10	1.19	0.69

Male End Connections

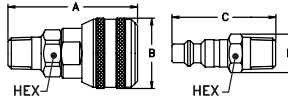

PLUGS

Part No.	Thread Size	Dimensions		
		C	D	HEX
10	1/4-18 NPTF	1.75	0.65	0.56
10C§	1/4-18 NPTF	1.75	0.65	0.56
10G†	1/4-18 NPTF	1.75	0.65	0.56
12	1/8-27 NPTF	1.59	0.58	0.50
12G†	1/8-27 NPTF	2.38	0.77	0.69
14	3/8-18 NPTF	1.75	0.79	0.69
14G†	3/8-18 NPTF	2.53	0.77	0.69
Brass				
B10	1/4-18 NPTF	1.75	0.64	0.56
Stainless				
LL10	1/4-18 NPTF	1.75	0.65	0.56

Part No.	Thread Size	Dimensions		
		A	B	HEX
2800	1/8-27 NPTF	1.89	1.19	0.69
3000	1/4-18 NPTF	2.11	1.19	0.69
3200	3/8-18 NPTF	2.19	1.19	0.75

Female End Connections

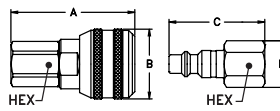

Part No.	Thread Size	Dimensions		
		C	D	HEX
11	1/4-18 NPTF	1.63	0.79	0.69
11G†	1/4-18 NPTF	2.44	0.77	0.69
13	1/8-27 NPTF	1.47	0.65	0.56
15	3/8-18 NPTF	1.69	0.94	0.81
15G†	3/8-18 NPTF	2.50	0.84	0.75
Brass				
11B	1/4-18 NPTF	1.63	0.78	0.69
Stainless				
LL11	1/4-18 NPTF	1.63	0.79	0.69

Part No.	Hose I.D.	Dimensions	
		A	B
3600	1/4"	2.63	1.19
3600P‡	1/4"	2.40	1.19
3700	3/8"	2.63	1.19
3700P‡	3/8"	2.47	1.19
3800	5/16"	2.63	1.19

Hose Stem End Connections

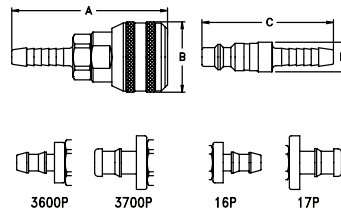

Part No.	Hose I.D.	Dimensions	
		C	D
16	1/4"	2.22	0.50
16G†	1/4"	2.97	0.77
16P‡	1/4"	2.00	0.69
16PG†‡	1/4"	2.75	0.77
17	3/8"	2.22	0.50
17G†	3/8"	2.96	0.77
17P‡	3/8"	2.06	0.87
17PG†‡	3/8"	2.85	0.87
18	5/16"	2.22	0.50
Brass			
B-17	3/8"	2.31	0.50

Part No.	Hose		Dimensions		
	I.D.	O.D.	A	B	HEX
3SA0	3/16"	7/16"	2.65	1.19	0.56
3SB1	1/4"	15/32"	2.72	1.19	0.63
3SB3	1/4"	1/2"	2.72	1.19	0.63
3SB5	1/4"	9/16"	2.72	1.19	0.69
3SB7	1/4"	5/8"	2.72	1.19	0.75
3SB9	1/4"	11/16"	2.72	1.19	0.81
3SB11	1/4"	3/4"	2.72	1.19	0.88
3SC5	5/16"	9/16"	2.78	1.19	0.69
3SC7	5/16"	5/8"	2.78	1.19	0.75
3SC9	5/16"	11/16"	2.78	1.19	0.81
3SD5	3/8"	9/16"	2.84	1.19	0.69
3SD7	3/8"	5/8"	2.84	1.19	0.75
3SD9	3/8"	11/16"	2.84	1.19	0.81
3SD11	3/8"	3/4"	2.84	1.19	0.88
3SD13	3/8"	13/16"	2.84	1.19	0.94

Hose Clamp End Connections

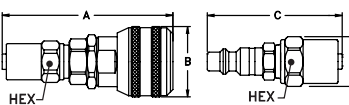

Part No.	Hose		Dimensions		
	I.D.	O.D.	C	D	HEX
3PA0	3/16"	7/16"	2.25	0.63	0.56
3PB1	1/4"	15/32"	2.31	0.70	0.63
3PB3	1/4"	1/2"	2.31	0.70	0.63
3PB5	1/4"	9/16"	2.31	0.77	0.69
3PB7	1/4"	5/8"	2.31	0.84	0.75
3PB9	1/4"	11/16"	2.31	0.91	0.81
3PB11	1/4"	3/4"	2.31	0.98	0.88
3PC5	5/16"	9/16"	2.38	0.77	0.69
3PC7	5/16"	5/8"	2.38	0.84	0.75
3PC9	5/16"	11/16"	2.38	0.91	0.81
3PD5	3/8"	9/16"	2.44	0.77	0.69
3PD7	3/8"	5/8"	2.44	0.84	0.75
3PD9	3/8"	11/16"	2.44	0.91	0.81
3PD11	3/8"	3/4"	2.44	0.98	0.88
3PD13	3/8"	13/16"	2.44	1.05	0.94
3PD15	3/8"	7/8"	2.44	1.12	1.00

* 45° Male Flare § With Ball Check † With Bleeder Ball Check – Reduces hose whip when disconnecting ‡ For use with push-on style hose

Optional Seal Materials: 138-Silicone, 143-Fluorocarbon, 192-EPDM

SOCKETS

Part No.	Thread Size	Dimensions		
		A	B	HEX
4100A	1/8-27 NPTF	2.20	1.38	0.88
4100	1/4-18 NPTF	2.35	1.38	0.88
4300	3/8-18 NPTF	2.35	1.38	0.88
4500	1/2-14 NPTF	2.54	1.38	0.88

Male End Connections

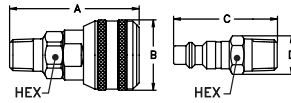

PLUGS

Part No.	Thread Size	Dimensions		
		C	D	HEX
38	1/8-27 NPTF	1.72	0.72	0.63
40	1/4-18 NPTF	1.88	0.72	0.63
40G†	1/4-18 NPTF	2.65	0.77	0.69
42	3/8-18 NPTF	1.88	0.79	0.69
42G†	3/8-18 NPTF	2.65	0.77	0.69
44	1/2-14 NPTF	2.09	1.01	0.88
Brass				
B40	1/4-18 NPTF	1.88	0.70	0.63
B42	3/8-18 NPTF	1.88	0.77	0.69

Part No.	Thread Size	Dimensions		
		A	B	HEX
4000A	1/8-27 NPTF	2.10	1.38	0.88
4000	1/4-18 NPTF	2.10	1.38	0.88
4200	3/8-18 NPTF	2.35	1.38	0.88
4400	1/2-14 NPTF	2.62	1.38	1.00

Female End Connections

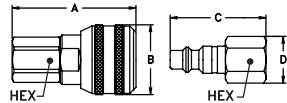

Part No.	Thread Size	Dimensions		
		C	D	HEX
41	1/4-18 NPTF	1.63	0.79	0.69
41G†	1/4-18 NPTF	2.56	0.77	0.69
43	3/8-18 NPTF	1.81	0.94	0.81
43G†	3/8-18 NPTF	2.62	0.84	0.75
45	1/2-14 NPTF	2.06	1.15	1.00
Brass				
B43	3/8-18 NPTF	1.81	0.91	0.81

Part No.	Hose I.D.	Dimensions	
		A	B
40400	1/4"	2.82	1.38
40500	5/16"	2.82	1.38
40600	3/8"	2.82	1.38
40800	1/2"	2.82	1.38

Hose Stem End Connections

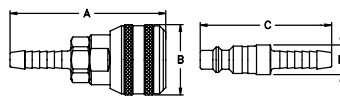

Part No.	Hose I.D.	Dimensions	
		C	D
404	1/4"	2.34	0.63
406	3/8"	2.34	0.63
408	1/2"	2.34	0.81
Brass			
B406	3/8"	2.34	0.63

Part No.	Hose		Dimensions		
	I.D.	O.D.	A	B	HEX
4SB3	1/4"	1/2"	2.92	1.38	0.63
4SB5	1/4"	9/16"	2.92	1.38	0.69
4SB7	1/4"	5/8"	2.92	1.38	0.75
4SB9	1/4"	11/16"	2.92	1.38	0.81
4SB11	1/4"	3/4"	2.92	1.38	0.88
4SC7	5/16"	5/8"	2.98	1.38	0.75
4SD5	3/8"	9/16"	3.04	1.38	0.69
4SD7	3/8"	5/8"	3.04	1.38	0.75
4SD9	3/8"	11/16"	3.04	1.38	0.81
4SD11	3/8"	3/4"	3.04	1.38	0.88
4SD15	3/8"	7/8"	3.04	1.38	1.00
4SP13	1/2"	13/16"	3.67	1.38	0.94
4SP15	1/2"	7/8"	3.67	1.38	1.00

Hose Clamp End Connections

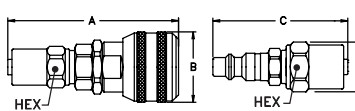

Part No.	Hose		Dimensions		
	I.D.	O.D.	C	D	HEX
4PB3	1/4"	1/2"	2.44	0.70	0.63
4PB7	1/4"	5/8"	2.44	0.84	0.75
4PD5	3/8"	9/16"	2.56	0.77	0.69
4PD7	3/8"	5/8"	2.56	0.84	0.75
4PD9	3/8"	11/16"	2.56	0.91	0.81
4PD11	3/8"	3/4"	2.56	0.98	0.88
4PD13	3/8"	13/16"	2.56	1.05	0.94
4PD15	3/8"	7/8"	2.56	1.12	1.00
4PP13	1/2"	13/16"	3.25	1.05	0.94
4PP15	1/2"	7/8"	3.25	1.12	1.00
4PP19	1/2"	1"	3.25	1.26	1.13

† With Bleeder Ball Check – Reduces hose whip when disconnecting

Optional Seal Materials: 138-Silicone, 143-Fluorocarbon, 192-EPDM

ONE-WAY

TWO-WAY

STRAIGHT-THRU

GAS

ACCESSORIES

5000 Series

SOCKETS

Part No.	Thread Size	Dimensions		
		A	B	HEX
50100	1/4-18 NPTF	2.78	1.50	1.00
5100	3/8-18 NPTF	2.79	1.50	1.00
5300	1/2-14 NPTF	2.98	1.50	1.00
5500	3/4-14 NPTF	2.98	1.50	1.06

Male End Connections

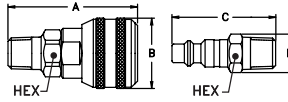

PLUGS

Part No.	Thread Size	Dimensions		
		C	D	HEX
50	1/4-18 NPTF	2.25	0.79	0.69
50G†	1/4-18 NPTF	2.90	0.98	0.88
52	3/8-18 NPTF	2.25	0.87	0.75
52G†	3/8-18 NPTF	2.90	0.98	0.88
54	1/2-14 NPTF	2.44	1.01	0.88
54G†	1/2-14 NPTF	3.09	0.98	0.88
56	3/4-14 NPTF	2.50	1.23	1.06
56G†	3/4-14 NPTF	3.14	1.19	1.06
Brass				
B52	3/8-18 NPTF	2.25	0.70	0.63
B54	1/2-14 NPTF	2.44	0.77	0.88

Part No.	Thread Size	Dimensions		
		A	B	HEX
5000A	1/4-18 NPTF	2.72	1.50	1.00
5000	3/8-18 NPTF	2.79	1.50	1.00
5200	1/2-14 NPTF	3.07	1.50	1.00
5400	3/4-14 NPTF	3.10	1.50	1.19

Female End Connections

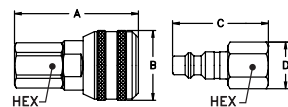

Part No.	Thread Size	Dimensions		
		C	D	HEX
53A	1/4-18 NPTF	1.92	0.79	0.69
53	3/8-18 NPTF	2.06	0.94	0.81
53G†	3/8-18 NPTF	2.90	0.98	0.88
55	1/2-14 NPTF	2.34	1.15	1.00
55G†	1/2-14 NPTF	3.17	0.98	0.88
57	3/4-14 NPTF	2.44	1.37	1.19

Part No.	Hose I.D.	Dimensions	
		A	B
50400	1/4"	3.26	1.50
50500	5/16"	3.29	1.50
5700	3/8"	3.33	1.50
5800	1/2"	3.25	1.50
5900	3/4"	4.10	1.50

Hose Stem End Connections

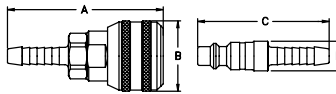

Part No.	Hose I.D.	Dimensions	
		C	D
585	5/16"	2.66	0.69
585G†	5/16"	3.37	0.98
59	3/8"	2.66	0.69
59G†	3/8"	3.37	0.98
60	1/2"	2.66	0.75
60G†	1/2"	3.37	0.98
61	3/4"	3.50	1.00
61G†	3/4"	4.22	0.98
Brass			
B60	1/2"	2.75	0.88

Part No.	Hose		Dimensions		
	I.D.	O.D.	A	B	HEX
5SD5	3/8"	9/16"	3.50	1.50	0.69
5SD7	3/8"	5/8"	3.50	1.50	0.75
5SD9	3/8"	11/16"	3.50	1.50	0.81
5SD11	3/8"	3/4"	3.50	1.50	0.88
5SD13	3/8"	13/16"	3.50	1.50	0.94
5SD15	3/8"	7/8"	3.50	1.50	1.00
5SP13	1/2"	13/16"	4.10	1.50	0.94
5SP15	1/2"	7/8"	4.10	1.50	1.00
5SR23	3/4"	11/8"	4.23	1.50	1.25
5SR25	3/4"	13/16"	4.23	1.50	1.31
5SR27	3/4"	11/4"	4.23	1.54	1.38

Hose Clamp End Connections

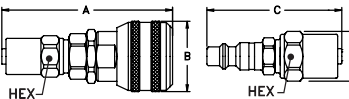

Part No.	Hose		Dimensions		
	I.D.	O.D.	C	D	HEX
5PB3	1/4"	1/2"	2.81	0.70	0.63
5PB5	1/4"	9/16"	2.81	0.77	0.69
5PB7	1/4"	5/8"	2.81	0.84	0.75
5PD5	3/8"	9/16"	2.94	0.77	0.69
5PD7	3/8"	5/8"	2.94	0.84	0.75
5PD9	3/8"	11/16"	2.94	0.91	0.81
5PD11	3/8"	3/4"	2.94	0.98	0.88
5PD13	3/8"	13/16"	2.94	1.05	0.94
5PD15	3/8"	7/8"	2.94	1.12	1.00
5PP13	1/2"	13/16"	3.62	1.05	0.94
5PP15	1/2"	7/8"	3.62	1.12	1.00
5PR23	3/4"	1 1/8"	3.75	1.40	1.25
5PR25	3/4"	13/16"	3.75	1.47	1.31
5PR27	3/4"	1 1/4"	3.75	1.54	1.38

† With Bleeder Ball Check – Reduces hose whip when disconnecting

Optional Seal Materials: 143-Fluorocarbon, 192-EPDM

SOCKETS

Part No.	Brass	Thread Size	Dimensions		
			A	B	HEX
6300		1/2-14 NPTF	2.94	1.88	1.31
6500		3/4-14 NPTF	2.94	1.88	1.31
6700		1-11½ NPTF	3.13	1.88	1.31

Male End Connections

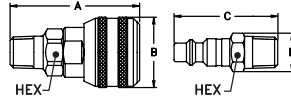

PLUGS

Part No.	Steel	Thread Size	Dimensions		
			C	D	HEX
64A		1/2-14 NPTF	2.31	1.15	1.00
64GA†		1/2-14 NPTF	3.26	1.12	1.00
66A		3/4-14 NPTF	2.38	1.23	1.06
66GA†		3/4-14 NPTF	3.26	1.19	1.06
68A		1-11½ NPTF	2.56	1.52	1.31
Brass					
B64A		1/2-14 NPTF	2.31	1.12	1.00
B66A		3/4-14 NPTF	2.38	1.19	1.06

Part No.	Brass	Thread Size	Dimensions		
			A	B	HEX
6200		1/2-14 NPTF	2.85	1.88	1.31
6400		3/4-14 NPTF	3.00	1.88	1.31
6600		1-11½ NPTF	3.19	1.88	1.56

Female End Connections

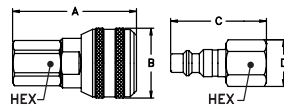

Part No.	Steel	Thread Size	Dimensions		
			C	D	HEX
65A		1/2-14 NPTF	2.22	1.15	1.00
65GA†		1/2-14 NPTF	3.35	1.12	1.00
67A		3/4-14 NPTF	2.22	1.37	1.19
67GA†		3/4-14 NPTF	3.38	1.33	1.19
69A		1-11½ NPTF	2.41	1.80	1.56

Part No.	Brass	Hose I.D.	Dimensions	
			A	B
6800		1/2"	3.21	1.88
6900		3/4"	4.06	1.88
7000		1"	4.07	1.88

Hose Stem End Connections

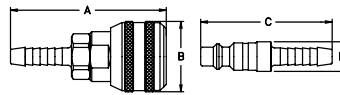

Part No.	Steel	Hose I.D.	Dimensions	
			C	D
70A		1/2"	2.53	0.94
70GA†		1/2"	3.53	1.12
71A		3/4"	3.44	1.06
71GA†		3/4"	4.38	1.12
72A		1"	3.44	1.31
Brass				
B71A		3/4"	3.44	1.06

† With Bleeder Ball Check – Reduces hose whip when disconnecting

Dust Caps and Dust Plugs Accessories:

Coupling Series	Plug Dust Cap Part No.		Socket Dust Plug Part No.	
	Metal	Vinyl	Metal	Vinyl
3000	PDC3000*	–	SDC3000*	PSDC1HK
4000	–	–	–	PSDC2HK
5000	–	PPDC2HK	–	–
6000	–	PPDC3HK	–	–

*Brass



Optional Seal Materials: 143-Fluorocarbon, 192-EPDM

ONE-WAY

TWO-WAY

STRAIGHT-THRU

GAS

ACCESSORIES

P30 & P40 Series



Industrial Interchange Plastic quick connect couplings designed for compressed air. Body sizes are 1/4" and 3/8".

FEATURES

- Plastic socket body and plug
- Light-weight
- Less likely to damage painted or easily scratched surfaces than metal couplings
- Easy, automatic, push-to-connect design provides instantaneous connection and disconnection of lines, plus automatic shut-off of socket end of line
- Series P30 accepts all series 3000 plugs; Series P40 accepts series 4000 plugs

APPLICATIONS & MARKETS

- General Pneumatics

SOCKETS

Hose Stem End Connections

Part No.	Hose I.D.	Dimensions	
		A	B
P430S25H	1/4"	2.66	1.25
P740S37H	3/8"	2.82	1.44

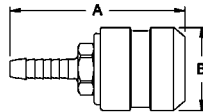

PLUGS

Male End Connections

Part No.	Steel Thread Size	Dimensions		
		C	D	HEX
P430P25M	1/4-18 NPTF	1.75	0.65	0.56

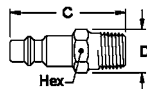

Interchangeability

All Sizes	1/4" only
US Industrial Interchange	ISO 6150 Series B A-A-59439 (former MIL-C-4109)



Materials

Socket:

- Acetal Body
- Polypropylene Sleeve
- Zinc Plated Steel Valve
- Buna-N (Nitrile) Seal
- Stainless Steel Spring

Plug:

- Acetal
- Series P30 accepts all Series 3000 plugs
- Series P40 accepts all Series 4000 plugs



1/4" to 3/8" nominal
(6.35 mm to 9.52 mm)



Up to 125° F (52° C)



Rated Pressure

Series	Size	PSI	BAR
P30	1/4"	150	10
P40	3/8"	150	10

* At temperatures up to 125°



Flow Capacity

Series	† Ac
P30	28
P40	45

† Air flow (scfm) with 5 psi pressure drop and 100 psig inlet pressure.

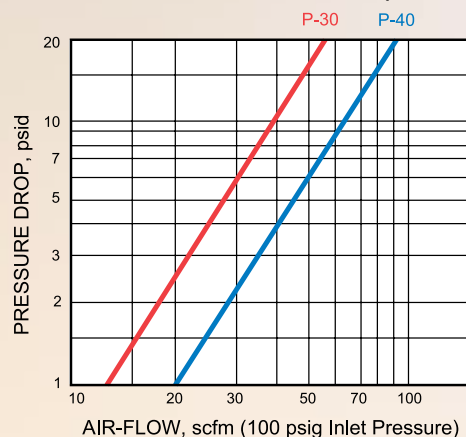



Auto-Flo 23 & 24 are high flow, automatic quick connect couplings designed for use with compressed air. The universal design makes the Auto-Flo an extremely flexible coupling series.

FEATURES

- Auto-Flo 23 was the first automatic universal coupling designed to operate with Industrial, ARO 210 and Tru-Flate Interchange plugs
- Auto-Flo 24 operates with CEJN 320 and Rectus 25 Interchange plugs
- Easy, automatic, push-to-connect design provides instantaneous connection and disconnection of lines, plus automatic shut-off of socket end of line
- Sleeve guard protects against accidental disconnection

APPLICATIONS & MARKETS

- General Pneumatics
- Air Tools
- Construction

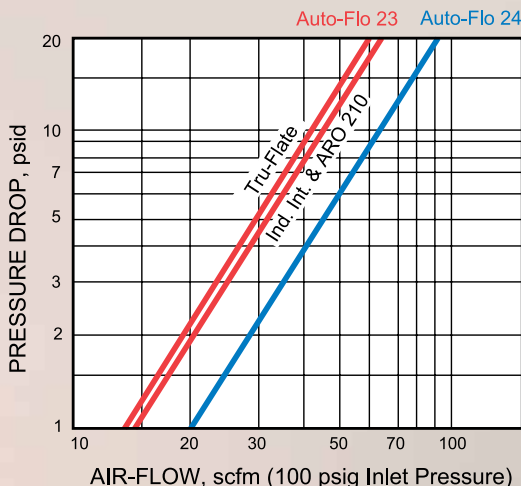

Interchangeability

Auto-Flo 23	Auto-Flo 24
US Industrial Interchange	(Euro Interchange)
ISO 6150 Series B	
A-A-59439 (former MIL-C-4109)	CEJN 320
Tru-Flate Interchange	RECTUS 25
ARO 210 Interchange	

Materials

Socket:

- Brass Body
- Brass Valve
- Zinc Plated Steel Sleeve
- Buna-N (Nitrile) Seal
- Stainless Steel Springs
- Stainless Steel Locking Balls

Plug:

- Industrial Interchange
 - Zinc Plated Case-Hardened Steel
 - Brass
 - Stainless Steel
- ARO 210, Tru-Flate and CEJN/Rectus Interchanges
 - Zinc Plated Case-Hardened Steel

1/4" nominal (6.35 mm)

-40° F to 250° F
-40° C to 120° C

Pressure Ratings

Series	PSI	BAR
Auto-Flo 23	150	10
Auto-Flo 24	150	10

Flow Capacities

Plug Interchange	†Ac
Industrial	32
ARO 210	32
Tru-Flate	30
Auto-Flo 24	45

† Air flow (scfm) with 5 psi pressure drop and 100 psig inlet pressure.

ONE-WAY

TWO-WAY

STRAIGHT-THRU

GAS

ACCESSORIES

Auto-Flo 23 Series

SOCKETS

Part No.	Thread Size	Dimensions		
		A	B	HEX
B23AS25M	1/4-18 NPTF	2.23	0.94	0.81
B23AS25MBST	1/4-19 BSPT	2.23	0.94	0.81
B23AS37M	3/8-18 NPTF	2.23	0.94	0.81
B23AS37MBST	3/8-19 BSPT	2.23	0.94	0.81
B23AS50MBST	1/2-14 BSPT	2.23	0.94	0.88

Male End Connections

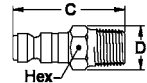
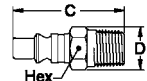
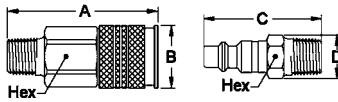

PLUGS

Part No.	Thread Size	Dimensions		
		C	D	HEX
Steel				
10	1/4-18 NPTF	1.75	0.65	0.56
10C§	1/4-18 NPTF	1.75	0.65	0.56
10G†	1/4-18 NPTF	1.75	0.65	0.56
12	1/8-27 NPTF	1.59	0.58	0.50
12G†	1/8-27 NPTF	2.38	0.77	0.69
14	3/8-18 NPTF	1.75	0.79	0.69
14G†	3/8-18 NPTF	2.53	0.77	0.69
Brass				
B10	1/4-18 NPTF	1.75	0.64	0.56
Stainless				
LL10	1/4-18 NPTF	1.75	0.65	0.56
ARO 210 Interchange				
2607	1/8-27 NPTF	1.42	0.58	0.50
2608	1/4-18 NPTF	1.68	0.65	0.56
2608B	1/4-19 BSPT	1.68	0.65	0.56
20AP37M	3/8-18 NPTF	1.68	0.79	0.69
Tru-Flate Interchange				
21AP25M	1/4-18 NPTF	1.65	0.65	0.56

Part No.	Thread Size	Dimensions		
		A	B	HEX
B23AS25F	1/4-18 NPTF	2.02	0.94	0.81
B23AS25FBS	1/4-19 BSPP	2.02	0.94	0.81
B23AS37F	3/8-18 NPTF	2.02	0.94	0.81
B23AS37FBS	3/8-19 BSPP	2.02	0.94	0.81

Female End Connections

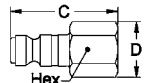
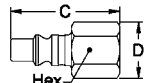
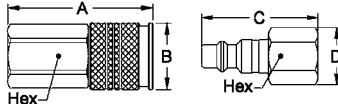

Part No.	Thread Size	Dimensions		
		C	D	HEX
Steel				
11	1/4-18 NPTF	1.63	0.79	0.69
11G†	1/4-18 NPTF	2.44	0.77	0.69
13	1/8-27 NPTF	1.47	0.65	0.56
15	3/8-18 NPTF	1.69	0.94	0.81
15G†	3/8-18 NPTF	2.50	0.84	0.75
Brass				
11B	1/4-18 NPTF	1.63	0.78	0.69
Stainless				
LL11	1/4-18 NPTF	1.63	0.79	0.69
ARO 210 Interchange				
2609	1/4-18 NPTF	1.55	0.79	0.69
2609B	1/4-19 BSPP	1.55	0.79	0.69
20AP37F	3/8-18 NPTF	1.61	0.94	0.81
Tru-Flate Interchange				
21AP25F	1/4-18 NPTF	1.53	0.79	0.69

Part No.	Hose I.D.	Dimensions	
		A	B
B23AS25H	1/4"	2.76	0.94
B23AS31H	5/16"	2.73	0.94
B23AS37H	3/8"	2.73	0.94

Hose Stem End Connections

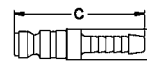
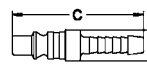
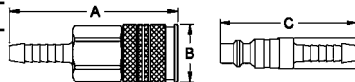

Part No.	Thread Size	Dimensions	
		C	D
Steel			
16	1/4"	2.22	0.50
16G†	1/4"	2.97	0.77
16P‡	1/4"	2.00	0.69
17	3/8"	2.31	0.50
17G†	3/8"	2.96	0.77
17P‡	3/8"	2.06	0.87
18	5/16"	2.22	0.50
Brass			
B17	3/8"	2.31	0.50
ARO 210 Interchange			
3946	1/4"	2.14	0.50
3947	5/16"	2.14	0.50
22238	3/8"	2.14	0.50
Tru-Flate Interchange			
21AP25H	1/4"	2.12	0.50

* 45° Male Flare § With Ball Check † With Bleeder Ball Check – Reduces hose whip when disconnecting ‡ For use with push-on style hose

SOCKETS

Part No.	Brass	Thread Size	Dimensions		
			A	B	HEX
B24AS25M		1/4-18 NPTF	2.27	0.94	0.81

Male End Connections

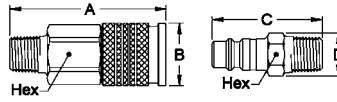

PLUGS

Part No.	Steel	Thread Size	Dimensions		
			C	D	HEX
24AP25MBST		1/4-19 BSPT	1.62	0.65	0.56
24AP37MBST		3/8-19 BSPT	1.62	0.79	0.69
24AP50MBST		1/2-14 BSPT	1.88	1.01	0.88

Part No.	Brass	Thread Size	Dimensions		
			A	B	HEX
B24AS25F		1/4-18 NPTF	2.06	0.94	0.81
B24AS25FBS		1/4-19 BSPP	2.06	0.94	0.81
B24AS37FBS		3/8-19 BSPP	2.06	0.94	0.81
B24AS50FBS		1/2-14 BSPP	2.38	0.94	1.06

Female End Connections

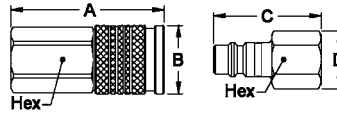

Part No.	Steel	Thread Size	Dimensions		
			C	D	HEX
24AP25FG		1/4-18 NPTF	1.49	0.79	0.69
24AP25FBS		1/4-19 BSPP	1.46	0.79	0.69
24AP50FBS		1/2-1/4 BSPP	1.65	1.23	1.06

ONE-WAY

TWO-WAY

STRAIGHT-THRU

GAS

ACCESSORIES

Safeline Series



The **SAFELINE** Industrial Interchange pushbutton safety coupling is designed for use with compressed air. Two-step disconnect procedure shuts off air supply and releases downstream air pressure before plug can be removed from socket, which prevents hose whip.

FEATURES

- Safe and easy to connect and disconnect
- Light weight, compact ergonomic design
- Accepts 1/4" ISO 6150 Series B and A-A-59439 (former MIL-C-4109) plugs

OPERATION

- To connect: Push plug into socket
- To disconnect: (1) Push button on side of socket. Air supply is shut off and plug pops out 3/16 inch, but is not released from socket. Downstream air is vented. (2) Push plug into socket to release latch. Pull plug from socket.

APPLICATIONS & MARKETS

- General Pneumatics
- Air Tools
- Industrial Plants
- Maintenance & Repair

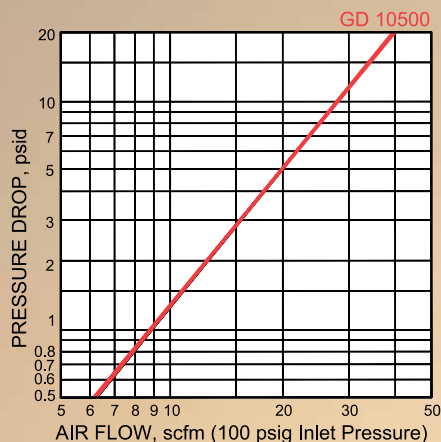

Interchangeability

- US Industrial Interchange
- ISO 6150 Series B
- A-A-59439 (Former MIL-C-4109)



Materials

Socket:

- Aluminum and steel construction
- Buna-N (Nitrile) Seal

Plug:

- Use Series 3000 Plug



1/4" Nominal (6.35 mm)



-40° F to 250° F
-40° C to 120° C



Rated Pressure

Series	PSI	Bar
GD 10500	232	16



Flow Capacity

Series	†Ac
GD 10500	20

† Air flow (scfm) with 5 psi pressure drop and 100 psig inlet pressure.

Male End Connections

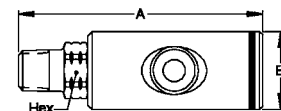

Part No.	Thread Size	Dimensions		
		A	B	HEX
GD10536 41	1/4-18 NPTF	3.18	1.02	0.67
GD10536 83	3/8-18 NPTF	3.18	1.02	0.75

Female End Connections

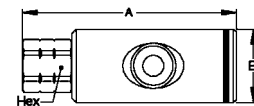

Part No.	Thread Size	Dimensions		
		A	B	HEX
GD10526 41	1/4-18 NPTF	2.97	1.02	0.67
GD10526 83	3/8-18 NPTF	3.18	1.02	0.87

Hose Stem End Connections

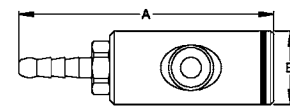

Part No.	Hose I.D.	Dimensions	
		A	B
GD10556 01	3/8"	3.56	1.02



Miniature Ball Lock quick connect couplings designed for use with compressed air, gases and liquids.

FEATURES

- Ball lock
- Manual operation
- Series 180 and 280 sockets mate with all Series 180 plugs
- Series 180 sockets have a tire valve
- Series 280 sockets have a 1-HK valve, which provides higher flow capacity
- Chrome plating available
- Additional seal materials available

APPLICATIONS & MARKETS

- Recreation & Entertainment
- Breathing Air
- General Pneumatics
- Pharmaceutical
- Laboratory Uses
- Medical



Interchangeability
- Proprietary Interchange



Materials
Socket:
• Brass Body and Sleeve
• Valve
- 180: Nickel Plated Brass Tire Valve
- 280: Brass Series 1-HK Valve
• Buna-N (Nitrile) Seal
• Stainless Steel Springs
• Stainless Steel Locking Balls

Plug:
• Brass



1/8" nominal (3.175 mm)



-40° F to 250° F
-40° C to 120° C



Pressure Ratings

Series	PSI	BAR
180	700	48
280	3,000	207



Flow Capacities

Series	†Ac
180	2.5
280	10.0

† Air flow (scfm) with 5 psi pressure drop and 100 psig

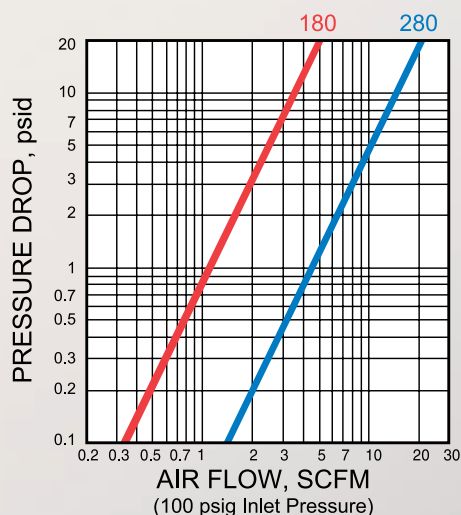

ONE-WAY

TWO-WAY

STRAIGHT-THRU

GAS

ACCESSORIES

180 & 280 Series

Series 180

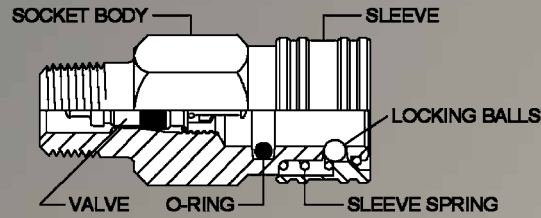

Series 280

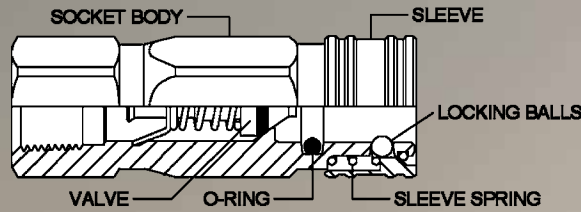

Part No.	Brass	Thread Size	Dimensions		
			A	B	HEX
180		1/8-27 NPTF	1.41	0.63	0.56
28S25M		1/4-18 NPTF	1.38	0.63	0.56

Male End Connections

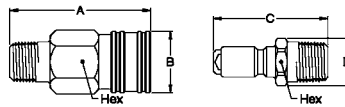

Part No.	Brass	Thread Size	Dimensions		
			C	D	HEX
185		1/8-27 NPTF	1.16	0.49	0.44
186		1/4-18 NPTF	1.44	0.63	0.56

Part No.	Brass	Thread Size	Dimensions		
			A	B	HEX
28S12F		1/8-27 NPTF	1.78	0.63	0.56

Female End Connections

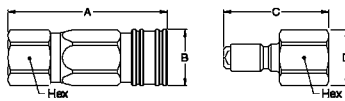

Part No.	Brass	Thread Size	Dimensions		
			C	D	HEX
183		1/8" NPTF	1.19	0.56	0.50

Hose Stem End Connections

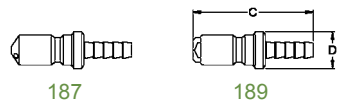

Part No.	Brass	Hose I.D.	Dimensions	
			C	D
187		1/8"	1.25	0.38
189		3/16"	1.50	0.38



100 Series quick connect couplings are designed to prevent the crossing of lines. These couplings are used for compressed air and gases.

FEATURES

- Ball lock
- Manual operation
- Non-interchangeable design prevents crossing of lines

APPLICATIONS & MARKETS

- General Pneumatics
- Industrial Plants

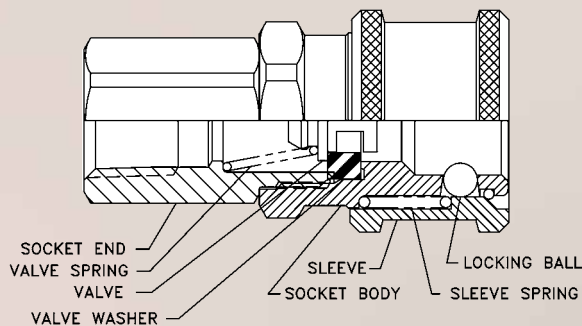

Interchangeability

- Proprietary Interchange



Materials

Socket:

- Brass Body
- Brass Valve
- Brass Sleeve
- Buna-N (Nitrile) Seal
- Stainless Steel Springs
- Stainless Steel Locking Balls

Plug:

- Brass



1/4" nominal (6.35 mm)



-40° F to 250° F
-40° C to 120° C



Pressure Ratings

Series	PSI	BAR
100	350	24



Flow Capacities

Series	† Ac
100	20

† Air flow (scfm) with 5 psi pressure drop and 100 psig

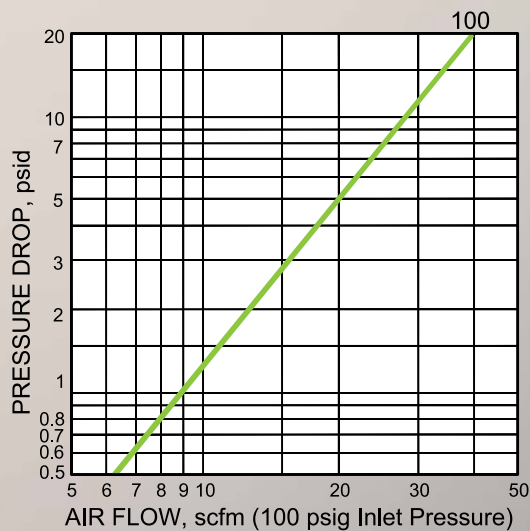

100 Series

SOCKETS

Part No.	Brass	Thread Size	Dimensions		
			A	B	HEX
101		1/8-27 NPTF	1.94	1.00	0.69
103		1/4-18 NPTF	2.09	1.00	0.69
105		3/8-18 NPTF	2.09	1.00	0.69
10063*		5/8-18	2.16	1.00	0.69

Male End Connections

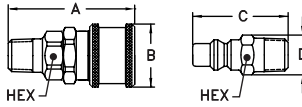

PLUGS

Part No.	Brass	Thread Size	Dimensions		
			C	D	HEX
1G1		1/8-27 NPTF	1.38	0.65	0.56
1G3		1/4-18 NPTF	1.56	0.65	0.56
1G5		3/8-18 NPTF	1.56	0.79	0.69

Part No.	Brass	Thread Size	Dimensions		
			A	B	HEX
100		1/8-27 NPTF	1.78	1.00	0.69
102		1/4-18 NPTF	2.00	1.00	0.69
104		3/8-18 NPTF	2.06	1.00	0.75

Female End Connections

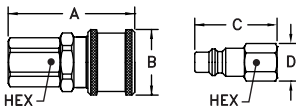

Part No.	Brass	Thread Size	Dimensions		
			C	D	HEX
1G2		1/4-18 NPTF	1.43	0.79	0.69

Part No.	Brass	Hose I.D.	Dimensions	
			A	B
110		1/4"	2.53	1.00
111		5/16"	2.53	1.00
112		3/8"	2.52	1.00

Hose Stem End Connections

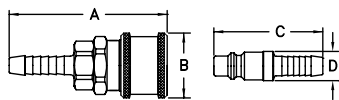

Part No.	Brass	Hose I.D.	Dimensions	
			C	D
1G10		1/4"	2.00	0.56
1G12		3/8"	2.03	0.56

Part No.	Hose		Dimensions		
	I.D.	O.D.	A	B	HEX
1GB3	1/4"	1/2"	2.62	1.00	0.63
1GB7	1/4"	5/8"	2.62	1.00	0.75
1GD7	3/8"	5/8"	2.75	1.00	0.75
1GD9	3/8"	11/16"	2.75	1.00	0.81

Hose Clamp End Connections

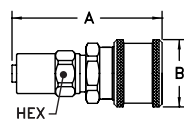

* 45° Male Flare

Dust Caps and Dust Plugs Accessories:

Coupling Series	Plug Dust Cap Part No.		Socket Dust Plug Part No.	
	Vinyl		Vinyl	
100	PPDC1HK		PSDC1HK	





600 & 700 Series quick connect couplings are designed for use in oxyacetylene service. Series 600 is used with oxygen. Series 700 is used with acetylene.

FEATURES

- Ball lock
- Manual operation
- Non-interchangeable designs prevent crossing of lines
- Sleeves are color coded to identify each series:
 - Series 600 sleeves are green for oxygen
 - Series 700 sleeves are red for acetylene
- Series 600 and 700 couplings can also be used with compressed air and other gases
- Sockets with the SL suffix have the sleeve lock feature to prevent accidental disconnection
- Series 600 and 700 couplings with sleeve lock feature comply with OSHA requirements*, which state couplings shall be the type that cannot be unlocked or disconnected by means of a straight pull without rotary motion.

APPLICATIONS & MARKETS

- Breathing Equipment
- Welding
- Shipyards
- General Pneumatics
- Construction
- Nitrous Oxide

TO ADD A THIRD NON-INTERCHANGEABLE LINE, USE THE 100 SERIES WITH THE 600 AND 700 SERIES.



*29 CFR 1915.55 (f)(5), 1917.152 (d)(3)(iv) and 29 CFR 1926.350 (f)(5)



Interchangeability

- Proprietary Interchange



Materials

Socket:

- Brass Body
- Brass Valve
- Painted Brass Sleeve
 - Green** - Series 600
 - Red** - Series 700
- Buna-N (Nitrile) Seal
- Stainless Steel Springs
- Stainless Steel Locking Balls

Plug:

- Brass



1/4" nominal (6.35 mm)



-40° F to 250° F
-40° C to 120° C



Pressure Ratings

Series	PSI	BAR
600 & 700	1,500	103



Flow Capacities

Series	†Ac
600 & 700	21

† Air flow (scfm) with 5 psi pressure drop and 100 psig inlet pressure.

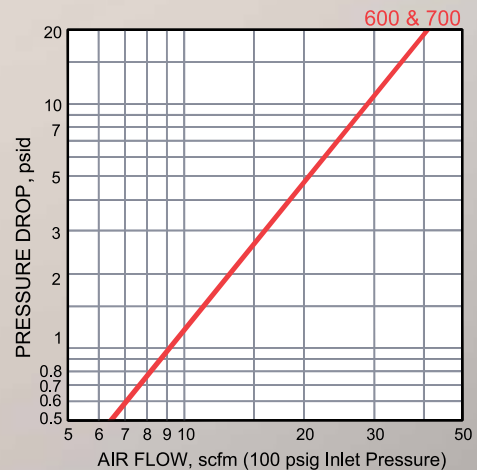

ONE-WAY

TWO-WAY

STRAIGHT-THRU

GAS

ACCESSORIES

600 Series

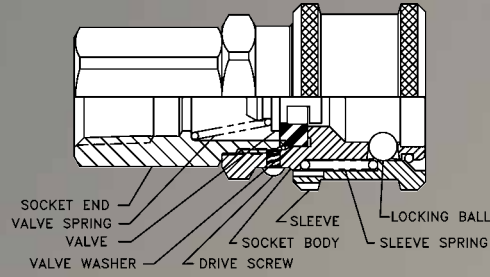

See Fittings on Page 75

SOCKETS

Part No. - Brass		Thread Size	Dimensions		
Standard	Oxygen Serv.		A	B	HEX
GR601	GR601SL	1/8-27 NPTF	1.84	1.00	0.69
GR603	GR603SL	1/4-18 NPTF	2.03	1.00	0.69
GR604R†	GR604RSL	9/16-18	1.92	1.00	0.69
GR605	GR605SL	3/8-18 NPTF	1.99	1.00	0.69

Male End Connections

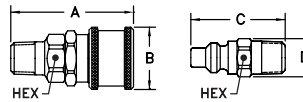

PLUGS

Part No.	Brass	Thread Size	Dimensions		
			C	D	HEX
01A		1/8-27 NPTF	1.41	0.63	0.56
03A		1/4-18 NPTF	1.56	0.63	0.56
04R†		9/16-18	1.41	0.63	0.56

Part No. - Brass		Thread Size	Dimensions		
Standard	Oxygen Serv.		A	B	HEX
GR600	GR600SL	1/8-27 NPTF	1.73	1.00	0.69
GR602	GR602SL	1/4-18 NPTF	1.95	1.00	0.69
GR604	GR604SL	3/8-18 NPTF	2.03	1.00	0.69
GR605R‡	GR605RSL	9/16-18	1.95	1.00	0.69

Female End Connections

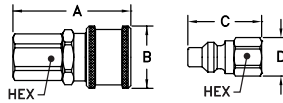

Part No.	Brass	Thread Size	Dimensions		
			C	D	HEX
00A		1/8-27 NPTF	1.22	0.63	0.56
02A		1/4-18 NPTF	1.41	0.77	0.69
05R‡		9/16-18	1.38	0.77	0.69

Part No. - Brass		Hose I.D.	Dimensions	
Standard	Oxygen Serv.		A	B
GR606	GR606SL	1/4"	2.47	1.00
GR606P§	GR606PSL§	1/4"	2.24	1.00
GR607	GR607SL	5/16"	2.47	1.00
GR608	GR608SL	3/8"	2.47	1.00
GR608P§	—	3/8"	2.31	1.00

Hose Stem End Connections

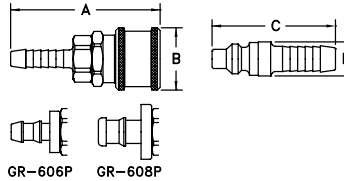

Part No.	Brass	Hose I.D.	Dimensions	
			C	D
07A		1/4"	2.03	0.56
08A		5/16"	2.03	0.56
09A		3/8"	2.04	0.56

Part No. - Brass		Hose I.D.	O.D.	Dimensions		
Standard	Oxygen Serv.			A	B	HEX
GR60B3	GR60B3-S	1/4"	1/2"	2.56	1.00	0.63
GR60B5	GR60B5SL	1/4"	9/16"	2.56	1.00	0.69
GR60B7	GR60B7SL	1/4"	5/8"	2.56	1.00	0.75
GR60C5	—	5/16"	9/16"	2.62	1.00	0.69
GR60C9	—	5/16"	11/16"	2.62	1.00	0.81
GR60D7	—	3/8"	5/8"	2.68	1.00	0.75
GR60D9	—	3/8"	11/16"	2.68	1.00	0.81
GR60D11	—	3/8"	3/4"	2.68	1.00	0.88

Hose Clamp End Connections

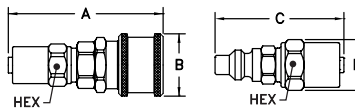

Part No.	Brass	Hose I.D.	O.D.	Dimensions		
				C	D	HEX
6B3		1/4"	1/2"	2.13	0.70	0.63
6B5		1/4"	9/16"	2.13	0.77	0.69
6B7		1/4"	5/8"	2.13	0.84	0.75
6B9		1/4"	11/16"	2.13	0.91	0.81
6D5		3/8"	9/16"	2.25	0.77	0.69
6D7		3/8"	5/8"	2.25	0.84	0.75
6D9		3/8"	11/16"	2.25	0.91	0.81
6D11		3/8"	3/4"	2.25	0.98	0.88

† R.H. Thread - 30° Female Flare ‡ R.H. Thread - Inverted Flare § For use with push-on style hose.

Series 600 couplings are not to be used with oxygen at pressures exceeding 100 psig.

WARNING

Oxygen increases combustibility. Fire and explosion could occur causing severe bodily injury or death. Be sure to select the proper coupling for your application and use it only within the specified service pressure range.

Series 600 and 700 couplings with sleeve lock feature comply with O.S.H.A. requirements, Sec. 1915.35 (f)(5), 1916.35 (f)(5), 1917.35 (f)(5), and 1926.350 (f)(5).

See Fittings on Page 75

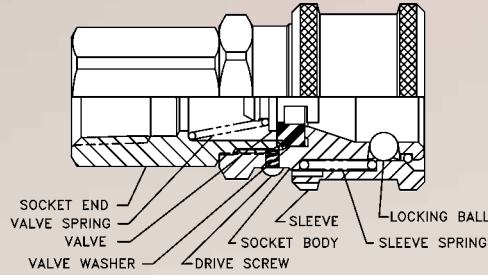

SOCKETS

PLUGS

Part No. - Brass		Thread Size	Dimensions		
Standard	Acetyl. Serv.		A	B	HEX
RD701	—	1/8-27 NPTF	1.84	1.00	0.69
RD703	RD703SL	1/4-18 NPTF	2.02	1.00	0.69
RD704L†	RD704LSL	9/16-18	1.92	1.00	0.69
RD705	RD705SL	3/8-18 NPTF	1.99	1.00	0.69

Male End Connections

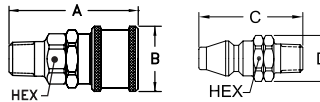

Part No.	Thread Size	Dimensions		
		C	D	HEX
A1	1/8-27 NPTF	1.47	0.63	0.56
A3P	1/4-18 NPTF	1.63	0.63	0.56
A4L‡	9/16-18	1.50	0.63	0.56

Part No. - Brass		Thread Size	Dimensions		
Standard	Acetyl. Serv.		A	B	HEX
RD700	RD700SL	1/8-27 NPTF	1.73	1.00	0.69
RD702	RD702SL	1/4-18 NPTF	1.95	1.00	0.69
RD704	RD704SL	3/8-18 NPTF	2.03	1.00	0.69
RD705L‡	RD705LSL	9/16-18	1.95	1.00	0.69

Female End Connections

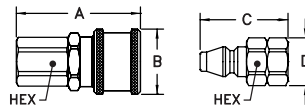

Part No.	Thread Size	Dimensions		
		C	D	HEX
A2	1/4-18 NPTF	1.46	0.77	0.69
A5L‡	9/16-18	1.38	0.77	0.69

Part No. - Brass		Hose I.D.	Dimensions	
Standard	Acetyl. Serv.		A	B
RD706	RD706SL	1/4"	2.47	1.00
RD706P§	—	1/4"	2.24	1.00
RD707	RD707SL	5/16"	2.47	1.00
RD708	RD708SL	3/8"	2.47	1.00
RD708P	—	—	—	—

Hose Stem End Connections

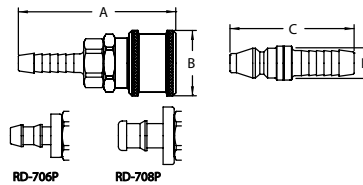

Part No.	Hose I.D.	Dimensions	
		C	D
A7	1/4"	2.06	0.56
A8	5/16"	2.06	0.56
A9	3/8"	2.10	0.56

Part No. - Brass		Hose I.D.	O.D.	Dimensions		
Standard	Acetyl. Serv.			A	B	HEX
RD70B3	RD70B3SL	1/4"	1/2"	2.56	1.00	0.63
RD70B7	—	1/4"	5/8"	2.56	1.00	0.75
RD70D7	—	3/8"	5/8"	2.68	1.00	0.75
RD70D9	—	3/8"	11/16"	2.68	1.00	0.81
RD70D11	—	3/8"	3/4"	2.68	1.00	0.88

Hose Clamp End Connections

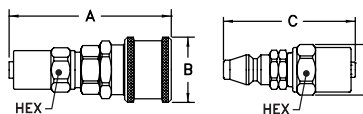

Part No.	Hose		Dimensions		
	I.D.	O.D.	C	D	HEX
7B3	1/4"	1/2"	2.19	0.70	0.63
7B7	1/4"	5/8"	2.19	0.84	0.75
7B11	1/4"	3/4"	2.19	0.98	0.88

† L.H. Thread - 30° Female Flare ‡ L.H. Thread - Inverted Flare § For use with push-on style hose.

Dust Caps and Dust Plugs Accessories:

Coupling Series	Plug Dust Cap Part No.	Socket Dust Plug Part No.
600	PPDC1HK	PSCD1HK
700	PPDC1HK	PSCD1HK



Series 700 couplings are not to be used with acetylene at pressures exceeding 15 psig.

ONE-WAY

TWO-WAY

STRAIGHT-THRU

GAS

ACCESSORIES

2RL & 3RL Series



2RL & 3RL Ring Lock quick connect couplings have a unique interchange which Eaton designed for use with compressed air. Body sizes are 1/4" and 3/8".

FEATURES

- High flow capacity
- Push to connect
- Ring lock
- Will not disconnect when hose is dragged on the ground
- Rotate locking sleeve approximately 20° to disconnect
- Optional seal materials available

APPLICATIONS & MARKETS

- Shipyards
- General Pneumatics
- Mining
- Marine

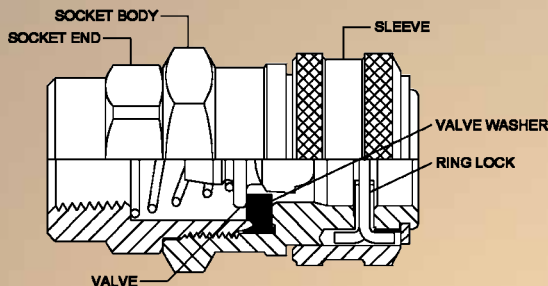

Interchangeability

- Proprietary Interchange



Materials

Socket:

- Zinc Plated Steel Body
- Brass Socket End
- Nickel Plated Steel Sleeve
- Zinc Plated Steel Valve
- Buna-N (Nitrile) Seal
- Stainless Steel Spring
- Zinc Plated Steel Locking Ring

Plug:

- Zinc Plated Case-Hardened Steel



1/4" to 3/8" nominal
(6.35 mm to 9.52 mm)



-40° F to 250° F
-40° C to 120° C



Rated Pressure

Series	Size	PSI	BAR
2RL	1/4"	300	20
3RL	3/8"	300	20



Flow Capacity

Series	† Ac
2RL	48
3RL	80

† Air flow (scfm) with 5 psi pressure drop and 100 psig inlet pressure.

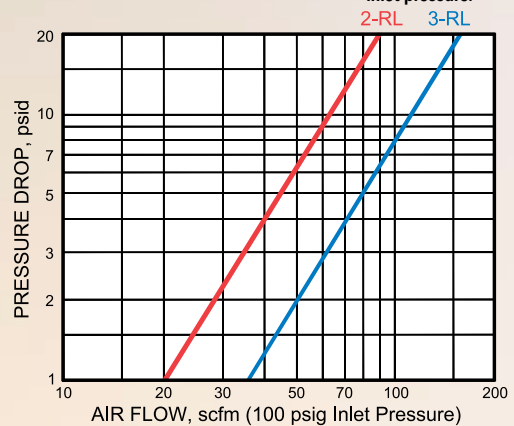

SOCKETS

Part No.	Thread Size	Dimensions		
		A	B	HEX
2R10	1/8-27 NPTF	2.01	1.06	0.88
2R15	1/4-18 NPTF	2.16	1.06	0.88
2R20	3/8-18 NPTF	2.16	1.06	0.88
2R25	1/2-14 NPTF	2.35	1.06	0.88

Male End Connections

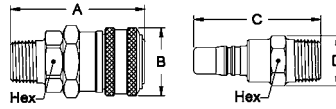

PLUGS

Part No.	Thread Size	Dimensions		
		C	D	HEX
2L10	1/8-27 NPTF	1.51	0.58	0.50
2L15	1/4-18 NPTF	1.66	0.65	0.56
2L15G†	1/4-18 NPTF	2.64	0.77	0.69
2L20	3/8-18 NPTF	2.04	0.79	0.69
2L20G†	3/8-18 NPTF	2.64	0.77	0.69
2L25	1/2-14 NPTF	2.31	1.01	0.88

Female End Connections

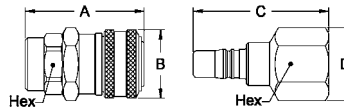

Part No.	Thread Size	Dimensions		
		A	B	HEX
2R11	1/8-27 NPTF	1.91	1.06	0.88
2R16	1/4-18 NPTF	1.91	1.06	0.88
2R21	3/8-18 NPTF	2.16	1.06	0.88
2R26	1/2-14 NPTF	2.43	1.06	1.00

Part No.	Thread Size	Dimensions		
		C	D	HEX
2L11	1/8-27 NPTF	1.36	0.65	0.56
2L16	1/4-18 NPTF	1.54	0.79	0.69
2L16G†	1/4-18 NPTF	2.55	0.77	0.69
2L21	3/8-18 NPTF	1.88	0.94	0.81
2L26	1/2-14 NPTF	2.18	1.15	1.00

Hose Stem End Connections

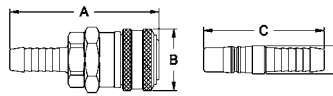

Part No.	Hose I.D.	Dimensions	
		A	B
2R17	1/4"	2.63	1.06
2R195	5/16"	2.63	1.06
2R22	3/8"	2.63	1.06
2R27	1/2"	2.63	1.06

Part No.	Hose I.D.	Dimensions	
		C	D
2L17	1/4"	2.13	0.56
2L195	5/16"	2.13	0.56
2L22	3/8"	2.13	0.56
2L27	1/2"	2.50	0.81

Hose Clamp End Connections

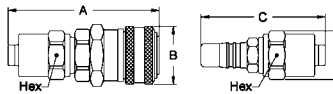

Part No.	Hose		Dimensions		
	I.D.	O.D.	A	B	HEX
2R18B1	1/4"	15/32"	2.73	1.06	0.63
2R18B3	1/4"	1/2"	2.73	1.06	0.63
2R18B7	1/4"	5/8"	2.73	1.06	0.75
2R18B11	1/4"	3/4"	2.73	1.06	0.88
2R185C7	5/16"	5/8"	2.79	1.06	0.75
2R185C9	5/16"	11/16"	2.79	1.06	0.81
2R23D7	3/8"	5/8"	2.85	1.06	0.75
2R23D9	3/8"	11/16"	2.85	1.06	0.81
2R23D11	3/8"	3/4"	2.85	1.06	0.88
2R23D13	3/8"	13/16"	2.85	1.06	0.94
2R28P13	1/2"	13/16"	3.48	1.06	0.94
2R28P15	1/2"	7/8"	3.48	1.06	1.00

Part No.	Hose		Dimensions		
	I.D.	O.D.	C	D	HEX
2L18B3	1/4"	1/2"	2.23	0.70	0.63
2L185C7	5/16"	5/8"	2.29	0.84	0.75
2L185C9	5/16"	11/16"	2.29	0.91	0.81
2L23D5	3/8"	9/16"	2.35	0.77	0.69
2L23D7	3/8"	5/8"	2.35	0.84	0.75
2L23D9	3/8"	11/16"	2.35	0.91	0.81
2L23D11	3/8"	3/4"	2.35	0.98	0.88
2L23D13	3/8"	13/16"	2.35	1.05	0.94
2L28P13	1/2"	13/16"	3.41	1.05	0.94
2L28P15	1/2"	7/8"	3.41	1.12	1.00

† With Bleeder Ball Check – Reduces hose whip when disconnecting.

Dust Caps and Dust Plugs Accessories:

Coupling Series	Plug Dust Cap Part No.	Socket Dust Plug Part No.
2RL	PPDC1HK	PSDC1HK
3RL	PPDC2HK	PSDC2HK



Optional Seal Materials: 138-Silicone, 143-Fluorocarbon, 192-EPDM

ONE-WAY

TWO-WAY

STRAIGHT-THRU

GAS

ACCESSORIES

3RL Series

SOCKETS

Part No.	Thread Size	Dimensions		
		A	B	HEX
3R15	1/4-18 NPTF	2.34	1.31	1.00
3R20	3/8-18 NPTF	2.35	1.31	1.00
3R25	1/2-14 NPTF	2.54	1.31	1.00
3R30	3/4-14 NPTF	2.54	1.31	1.06

Male End Connections

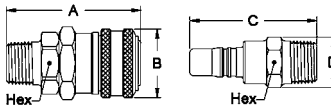

PLUGS

Part No.	Thread Size	Dimensions		
		C	D	HEX
3L10	1/8-27 NPTF	1.54	0.72	0.63
3L15	1/4-18 NPTF	1.70	0.72	0.63
3L15G†	1/4-18 NPTF	2.64	0.98	0.88
3L20	3/8-18 NPTF	1.76	0.79	0.69
3L20G†	3/8-18 NPTF	2.64	0.98	0.88
3L25	1/2-14 NPTF	2.31	1.01	0.88
3L25G†	1/2-14 NPTF	2.83	0.98	0.88
3L30	3/4-14 NPTF	2.38	1.23	1.06
3L30G†	3/4-14 NPTF	2.88	1.19	1.06

Part No.	Thread Size	Dimensions		
		A	B	HEX
3R16	1/4-18 NPTF	2.29	1.31	1.00
3R21	3/8-18 NPTF	2.35	1.31	1.00
3R26	1/2-14 NPTF	2.63	1.31	1.00
3R31A	3/4-14 NPTF	2.66	1.31	1.19

Female End Connections

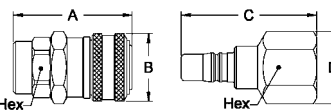

Part No.	Thread Size	Dimensions		
		C	D	HEX
3L16	1/4-18 NPTF	1.48	0.79	0.69
3L16G†	1/4-18 NPTF	2.39	0.98	0.88
3L21	3/8-18 NPTF	1.63	0.94	0.81
3L21G†	3/8-18 NPTF	2.64	0.98	0.88
3L26	1/2-14 NPTF	2.25	1.15	1.00
3L26G†	1/2-14 NPTF	2.91	0.98	0.88
3L31	3/4-14 NPTF	2.25	1.37	1.19

Part No.	Hose I.D.	Dimensions	
		A	B
3R17	1/4"	2.82	1.31
3R195	5/16"	2.85	1.31
3R22	3/8"	2.89	1.31
3R27	1/2"	2.81	1.31
3R32	3/4"	3.66	1.31

Hose Stem End Connections

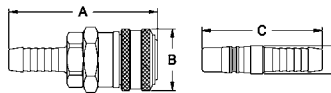

Part No.	Hose I.D.	Dimensions	
		C	D
3L17	1/4"	2.16	0.63
3L195	5/16"	2.16	0.63
3L195G†	5/16"	3.11	0.98
3L22	3/8"	2.16	0.75
3L22G†	3/8"	3.11	0.98
3L27	1/2"	2.16	0.81
3L27G†	1/2"	3.11	0.98
3L32	3/4"	3.13	1.00
3L32G†	3/4"	3.96	0.98

Part No.	Hose		Dimensions		
	I.D.	O.D.	A	B	HEX
3R23D7	3/8"	5/8"	3.06	1.31	0.75
3R23D9	3/8"	11/16"	3.06	1.31	0.81
3R23D11	3/8"	3/4"	3.06	1.31	0.88
3R28P13	1/2"	13/16"	3.66	1.31	0.94
3R28P15	1/2"	7/8"	3.66	1.31	1.00
3R33R23	3/4"	1 1/8"	3.79	1.40	1.25
3R33R25	3/4"	13/16"	3.79	1.47	1.31

Hose Clamp End Connections

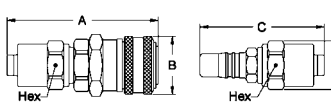

Part No.	Hose		Dimensions		
	I.D.	O.D.	C	D	HEX
3L23D7	3/8"	5/8"	2.45	0.84	0.75
3L23D9	3/8"	11/16"	2.45	0.91	0.81
3L23D11	3/8"	3/4"	2.45	0.98	0.88
3L28P13	1/2"	13/16"	3.14	1.05	0.94
3L28P15	1/2"	7/8"	3.14	1.12	1.00
3L33R23	3/4"	1 1/8"	3.56	1.40	1.25
3L33R25	3/4"	13/16"	3.56	1.47	1.31

† With Bleeder Ball Check – Reduces hose whip when disconnecting.

Optional Seal Materials: 143-Fluorocarbon



The Full-Bore Series is a premium automatic one-way shutoff coupling. Two sleeves must be actuated in sequence to bleed off back pressure and release the connector, preventing accidental uncoupling. Available in 3/8" and 1/2" capacities.

FEATURES

- Pressure relieving feature fully vents downstream air, making connection/disconnection fast and easy, and eliminating hose whip
- Unique straight-through design eliminates restrictive springs and poppet valves, allowing unimpeded air flow
- Two-sleeve activation prevents accidental disconnect

APPLICATIONS & MARKETS

- Construction
- Maintenance & Repair
- In-Plant/Industrial
- Railyards
- General Pneumatics

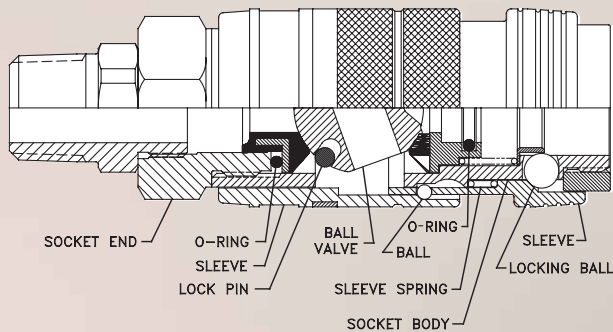

Interchangeability

All Sizes	1/2" only
Industrial Interchange	A-A-59439 (former MIL-C-4109)



Materials

- Socket:
- Carbon Steel
 - Hard Drawn Steel Spring
 - Buna-N Valve
 - Stainless Steel Locking Balls
- Plug:
- Carbon Steel



3/8" to 1/2" nominal (9.52 mm to 12.70 mm)



**-40° F to 200° F
-40° C to 93° C**



**Rated Pressure
250 psig (17 Bar)**



Flow Capacity

Size	Ac †
3/8"	63
1/2"	101

† Air flow (scfm) with 5 psig pressure drop and 100 psig inlet pressure.

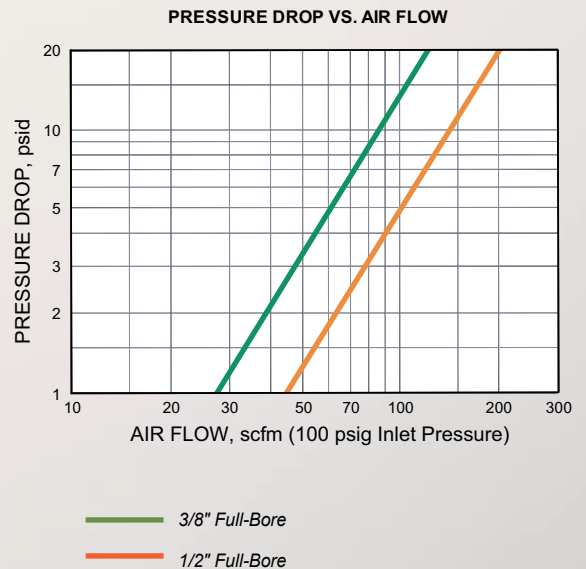

ONE-WAY

TWO-WAY

STRAIGHT-THRU

GAS

ACCESSORIES

Full-Bore Series

3/8" SOCKETS

Part No.	Steel	Thread Size	Dimensions		
			A	B	HEX
23203013		3/8" NPT	3.80	1.25	1.00
23203014		1/2" NPT	2.80	1.25	1.00

Male End Connections

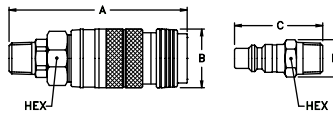

PLUGS

Part No.	Steel	Thread Size	Dimensions		
			C	D	HEX
40		1/4" NPT	1.88	0.72	0.63
42		3/8" NPT	1.88	0.79	0.69
44		1/2" NPT	2.09	1.01	0.88

Part No.	Steel	Thread Size	Dimensions		
			A	B	HEX
23203000		3/8" NPT	3.17	1.25	1.00
23203004		1/2" NPT	3.92	1.25	1.00

Female End Connections

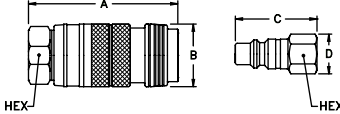

Part No.	Steel	Thread Size	Dimensions		
			C	D	HEX
41		1/4" NPT	1.63	0.79	0.69
43		3/8" NPT	1.81	0.94	0.81
45		1/2" NPT	2.06	1.15	1.00

Part No.	Steel	Hose I.D.	Dimensions	
			A	B
23203024		3/8"	4.36	1.25
23203025		1/2"	4.48	1.25

Hose Stem End Connections

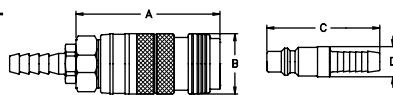

Part No.	Steel	Hose I.D.	Dimensions	
			C	D
404		1/4"	2.34	0.63
406		3/8"	2.34	0.63
408		1/2"	2.34	0.81

1/2" SOCKETS

Part No.	Steel	Thread Size	Dimensions		
			A	B	HEX
23204014		1/2" NPT	4.43	1.38	1.13
23204015		3/4" NPT	4.67	1.38	1.13

Male End Connections

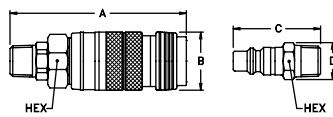

Part No.	Steel	Thread Size	Dimensions		
			C	D	HEX
52		3/8" NPT	2.25	0.87	0.75
54		1/2" NPT	2.44	1.01	0.88
56		3/4" NPT	2.50	1.23	1.06

Part No.	Steel	Thread Size	Dimensions		
			A	B	HEX
23204400		1/2" NPT	3.31	1.38	1.13
23204005		3/4" NPT	3.30	1.38	1.13

Female End Connections

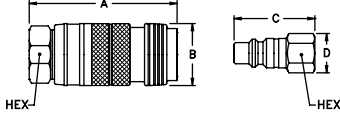

Part No.	Steel	Thread Size	Dimensions		
			C	D	HEX
53		3/8" NPT	2.06	0.94	0.81
55		1/2" NPT	2.34	1.15	1.00
57		3/4" NPT	2.44	1.37	1.19

Part No.	Steel	Hose I.D.	Dimensions	
			A	B
23204025		1/2"	4.15	1.38
23204026		3/4"	4.15	1.38

Hose Stem End Connections

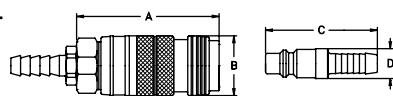

Part No.	Steel	Hose I.D.	Dimensions	
			C	D
59		3/8"	2.66	0.69
60		1/2"	2.66	0.75
61		3/4"	3.50	1.00



The 210 and 310 Interchange Series are 1/4" and 3/8" capacity automatic, pin-type couplings designed for one-way shutoff operation.

FEATURES

- Automatic push-to-connect
- Pin-lock design

APPLICATIONS & MARKETS

- Construction
- Maintenance & Repair
- In-Plant/Industrial
- Pneumatic Tools

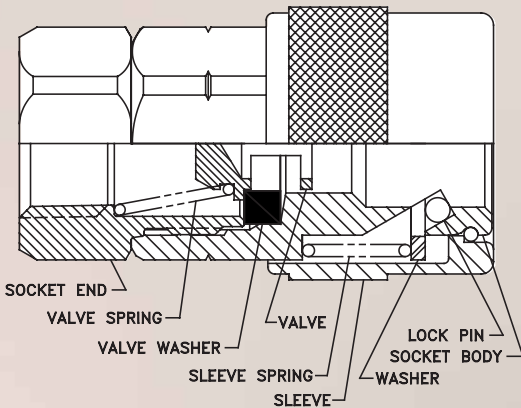

Interchangeability

- ARO Interchange



Materials

Socket:

- Carbon Steel
- Hard Drawn Steel Springs
- Buna-N Valve Washer
- Alloy Steel Locking Pins

Plug:

- Carbon Steel



**1/4" to 3/8" nominal
(6.35 mm to 9.52 mm)**



**-40° F to 200° F
-40° C to 93° C**



**Rated Pressure
250 psig (17 Bar)**



Flow Capacity

Series	Ac †
210	19
310	50

† Air flow (scfm) with 5 psig pressure drop and 100 psig inlet pressure.

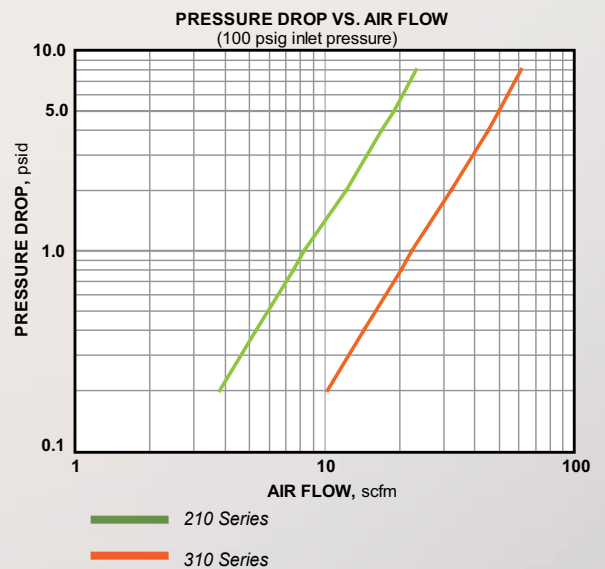

210 & 310 Series

210 SERIES SOCKETS

Part No.	Steel	Thread Size	Dimensions		
			A	B	HEX
210212		1/4" NPT	1.95	1.02	0.69
210213		3/8" NPT	1.91	1.02	0.69

Male End Connections

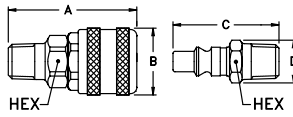

PLUGS

Part No.	Steel	Thread Size	Dimensions		
			C	D	HEX
2607		1/8-27 NPTF	1.42	0.58	0.50
2608		1/4-18 NPTF	1.68	0.65	0.56
2608B		1/4-19 BSPT	1.68	0.65	0.56
20AP37M		3/8-18 NPTF	1.68	0.79	0.69

Part No.	Steel	Thread Size	Dimensions		
			A	B	HEX
210		1/4" NPT	1.87	1.02	0.69
62210*		1/4" NPT	1.87	1.02	0.69

Female End Connections

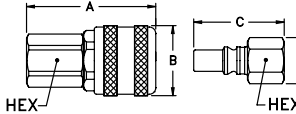

Part No.	Steel	Thread Size	Dimensions		
			C	D	HEX
2609		1/4-18 NPTF	1.55	0.79	0.69
2609B		1/4-19 BSPP	1.55	0.79	0.69
20AP37F		3/8-18 NPTF	1.61	0.94	0.81

Part No.	Steel	Hose I.D.	Dimensions	
			A	B
210022		1/4"	2.39	1.02
210215		3/8"	2.39	1.02

Hose Stem End Connections

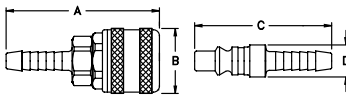

Part No.	Steel	Hose I.D.	Dimensions	
			C	D
3946		1/4"	2.14	0.50
3947		5/16"	2.14	0.50
22238		3/8"	2.14	0.50

* Same as Model 210 but with brass valve

310 SERIES SOCKETS

Part No.	Steel	Thread Size	Dimensions		
			A	B	HEX
310313		3/8" NPT	2.38	1.21	0.94

Male End Connections

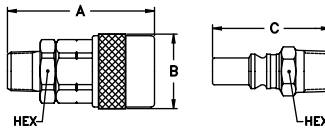

Part No.	Steel	Thread Size	Dimensions		
			D	E	HEX
22239		1/4" NPT	1.91	0.72	0.63
3804		3/8" NPT	1.91	0.79	0.69

Part No.	Steel	Thread Size	Dimensions		
			A	B	HEX
310		3/8" NPT	2.10	1.21	0.94

Female End Connections

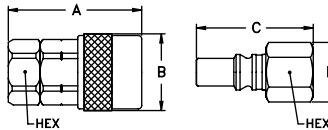

Part No.	Steel	Thread Size	Dimensions		
			D	E	HEX
3806		3/8" NPT	1.84	0.94	0.81

Part No.	Steel	Hose I.D.	Dimensions	
			A	B
310222		3/8"	2.97	1.21

Hose Stem End Connections

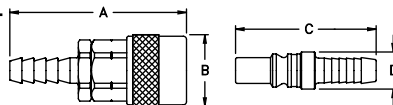

Part No.	Steel	Hose I.D.	Dimensions	
			C	D
3807		3/8"	2.37	0.63



The MS Series is an economical automatic one-way shutoff coupling. With steel pins securing the mating connector, the MS Series is available in 1/4" capacity.

FEATURES

- Automatic push-to-connect
- Pin-lock design

APPLICATIONS & MARKETS

- Construction
- Maintenance & Repair
- In-Plant/Industrial
- Pneumatic Tools

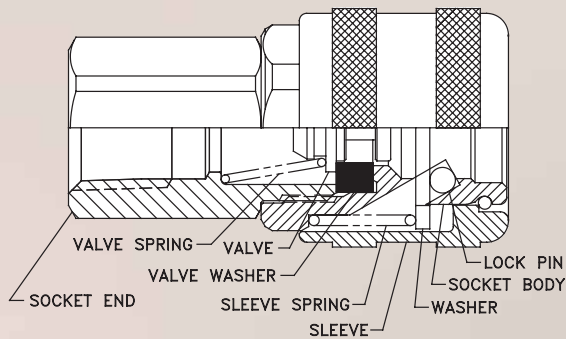

Interchangeability

- Industrial Interchange
- A-A-59439 (former MIL-C-4109)



Materials

Socket:

- Carbon Steel
- Hard Drawn Steel Springs
- Buna-N Valve Washer
- Alloy Steel Locking Pins

Plug:

- Carbon Steel



1/4" nominal (6.35 mm)



-40° F to 200° F
-40° C to 93° C



Rated Pressure
250 PSIG (17 Bar)



Flow Capacity

Series	Ac †
MS	26

† Air flow (scfm) with 5 psig pressure drop and 100 psig inlet pressure.

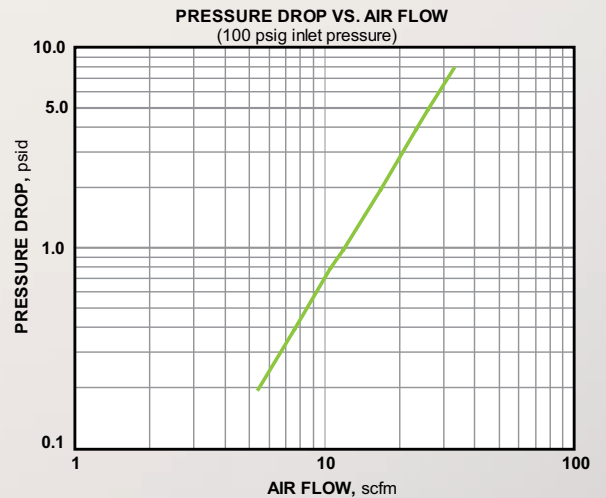

ONE-WAY

TWO-WAY

STRAIGHT-THRU

GAS

ACCESSORIES

MS Series

SOCKETS

Part No.	Steel	Thread Size	Dimensions		
			A	B	HEX
MSCM22000		1/4" NPT	1.95	1.02	0.69
MSCM23000		3/8" NPT	1.91	1.02	0.69

Male End Connections

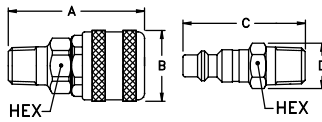

PLUGS

Part No.	Steel	Thread Size	Dimensions		
			C	D	HEX
10		1/4" NPT	1.75	0.65	0.56
12		1/8" NPT	1.59	0.58	0.50
14		3/8" NPT	1.75	0.79	0.69

Part No.	Steel	Thread Size	Dimensions		
			A	B	HEX
MSCF22000		1/4" NPT	1.95	1.02	0.69
MSCM23000		3/8" NPT	1.95	1.02	0.69

Female End Connections

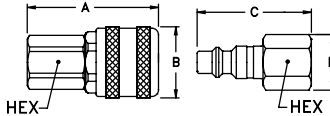

Part No.	Steel	Thread Size	Dimensions		
			C	D	HEX
11		1/4" NPT	1.63	0.79	0.69
13		1/8" NPT	1.47	0.65	0.56
15		3/8" NPT	1.69	0.94	0.81

Part No.	Steel	Hose I.D.	Dimensions	
			A	B
MSCH22000		1/4"	2.39	1.02
MSCH23000		3/8"	2.39	1.02

Hose Stem End Connections

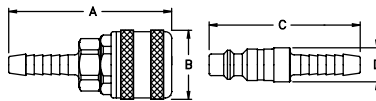

Part No.	Steel	Hose I.D.	Dimensions	
			C	D
16		1/4"	2.22	0.50
17		3/8"	2.22	0.50

Also interchanges with 1000 Series plugs on page 10.

**TWO-
WAY**



Contents and Selector Chart



Coupling Series	Page	Coupling Style			Body Size								Body Material				Locking Mechanism			Options				
		MANUAL CONNECT	PUSH-TO-CONNECT	MINIMUM SPILL INCLUSION	1/8 INCH	1/4 INCH	3/8 INCH	1/2 INCH	3/4 INCH	1 INCH	1 1/4 INCH	1 1/2 INCH	2 1/2 INCH	BRASS	STEEL (Zinc/chromate Finish)	STAINLESS STEEL (303)	STAINLESS STEEL (316)	PLASTIC (Polypropylene)	BALL LOCK	THREADED SLEEVE	PLASTIC FINGERS	SLEEVE LOCK	SEAL MATERIALS (Various)	DUST CAP/PLUG
1HK	41-43	●			●								●	●	●	●		●			●	●	●	
2HK	41-43	●				●							●	●	●	●		●			●	●	●	
P2HK	41-43	●				●											●		●		●	●	●	
3HK	41-43	●					●						●	●	●	●		●			●	●	●	
4HKP	41-43	●					●						●	●	●	●		●			●	●	●	
6HKP	41-43	●						●					●	●	●	●		●			●	●	●	
8HKP	41-43	●							●				●	●	●	●		●			●	●	●	
10HK	44-46	●								●			●	●	●	●		●			●	●	●	
12HK	44-46	●									●		●	●	●	●		●			●	●	●	
20HK	44-46	●										●	●	●	●		●				●	●	●	
HKFR	47	●					●	●	●					●	●	●		●			H		●	
HA15000	48/49	●				●	●	●	●	●				●				●					●	
FF	50-52		●	●		●	●	●	●	●				●				●			H	●	●	
5100	53	●		●				●	●	●			●						●				●	
UP10	54/55	●				●								●				●			H		●	
WA56000	56	●				●								●					●				●	
2HKIG	58	●				●									●			●				●	●	
2HKIL	59	●													●			●				●	●	
DB	59		●	●			●									●		●				●		

H Sleeve Lock is Standard



Series HK Couplings are the most versatile couplings available and are suitable for use with various liquids, chemicals, steam, gases and vacuum. Series HK couplings conform to the dimensional requirements of ISO 7241-1 Series B. Body sizes range from 1/8" to 1".

FEATURES

- The coupling that set the industry standard
- Multiple options make the HK our most versatile coupling series available
- Brass, steel and stainless steel construction available in all sizes; 1/4" body size is also available in polypropylene
- End connections are female NPTF, BSPP and SAE o-ring boss
- Heavy duty steel couplings for use in high impulse service available in most sizes
- Steam coupling available in 3/8" body size

APPLICATIONS & MARKETS

- Agriculture
- Military
- HVAC
- Hydraulic Tool
- Law Enforcement/ Rescue
- Food and Beverage
- General Industry
- Chemical
- Trucks
- Construction
- Oil and Gas
- Aerospace
- Fluid Transfer
- Consumer Products
- Medical
- Transportation

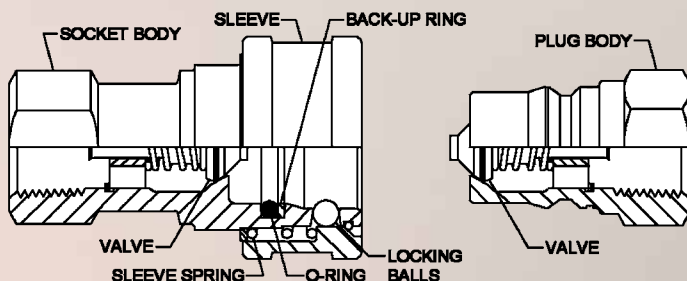

Interchangeability

- ISO 7241-1 Series B



Materials

- Brass, zinc-plated steel, stainless steel or polypropylene (1/4" only) construction
- Stainless steel springs, balls and retaining rings
- Buna-N (Nitrile) seals
- PTFE back-up rings in steel and stainless steel sockets



1/8" to 1" nominal
(4.4 mm to 25.4 mm)



-40° F to 250° F
-40° C to 121° C
(with standard seal)



Rated Pressure Chart

Part Number	Body Size inches (mm)	Brass		Steel		Stainless Steel	
		PSI	BAR	PSI	BAR	PSI	BAR
1HK	1/8 (4.4)	3,000	207	4,000	275	5,000	344
2HK	1/4 (5.9)	2,700	186	5,000	345	3,700	255
3HK	3/8 (7.8)	2,200	152	3,700	255	3,700	255
4HKP	1/2 (10)	2,250	155	5,000	345	4,250	293
6HKP	3/4 (17)	2,000	138	4,000	275	3,500	242
8HKP	1 (19.6)	1,500	103	4,000	275	3,000	207
Part Number	Body Size inches (mm)	Polypropylene		Temperature Range			
		PSI	BAR				
P2-HK	1/4 (5.9)	50	4	+35° F to 150° F			



Flow Capacity

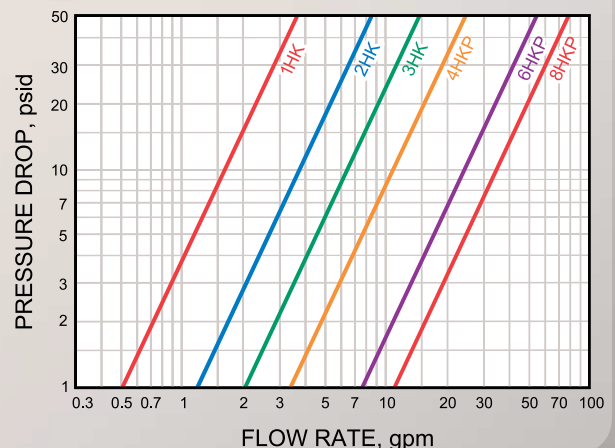

HK 1-8 Series

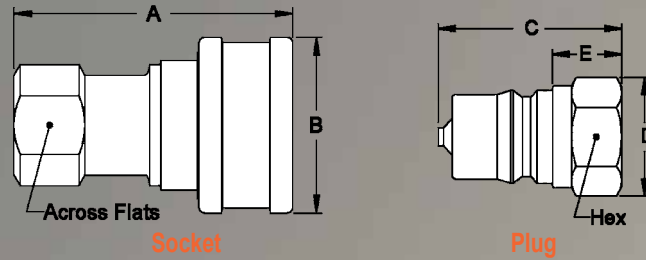

SOCKETS

Body Size (inch)	Part Number					Thread Size (female)			Dimensions (inches)		
	Brass	Steel		Stainless Steel		NPTF	BSPP	SAE	A	B	Across Flats
		Standard	High Impulse	303	316						
1/8	B1H11	1H11	—	LL1H11	ML1H11	1/8-27	—	—	1.91	0.98	0.56
1/8	—	1H4	—	LL1H4	—	—	—	7/16-20	2.06	0.98	0.69
1/4	B2H16	2H16	2H16	LL2H16	ML2H16	1/4-18	—	—	2.26	1.14	0.75
1/4	B2H16BS	2H16BS	2H16BS	LL2H16BS	ML2H16BS	—	1/4-19	—	2.31	1.14	0.75
1/4	—	2H6	2H6	LL2H6	—	—	—	9/16-18	2.40	1.14	0.88
3/8	B3H21	3H21	3H21C	LL3H21	ML3H21	3/8-18	—	—	2.56	1.42	0.88
3/8	B3H21BS	3H21BS	—	LL3H21BS	ML3H21BS	—	3/8-19	—	2.56	1.42	0.88
3/8	—	3H8	3H8C	LL3H8	—	—	—	3/4-16	2.74	1.42	1.00
1/2	B4HP26	4HP26	4HP26	LL4HP26	ML4HP26	1/2-14	—	—	2.96	1.86	1.13
1/2	B4HP26BS	4HP26BS	4HP26BS	LL4HP26BS	ML4HP26BS	—	1/2-14	—	2.96	1.86	1.13
1/2	—	4HP10	4HP10	LL4HP10	—	—	—	7/8-14	3.05	1.86	1.25
3/4	B6HP31	6HP31	6HP31	LL6HP31	ML6HP31	3/4-14	—	—	3.48	2.22	1.31
3/4	B6HP31BS	6HP31BS	6HP31BS	LL6HP31BS	ML6HP31BS	—	3/4-14	—	3.48	2.22	1.31
3/4	—	6HP12	6HP12	LL6HP12	—	—	—	11/16-12	3.67	2.22	1.38
1	B8HP36	8HP36	8HP36	LL8HP36	ML8HP36	1-11/2	—	—	4.13	2.61	1.75
1	B8HP36BS	8HP36BS	8HP36BS	LL8HP36BS	ML8HP36BS	—	1-11	—	4.13	2.61	1.75
1	—	8HP16	8HP16	LL8HP16	—	—	—	15/16-12	4.13	2.61	1.88

A = Overall Length B = Maximum Diameter

PLUGS

Body Size (inch)	Part Number					Thread Size (female)			Dimensions (inches)			
	Brass	Steel		Stainless Steel		NPTF	BSPP	SAE	C	D	E	HEX
		Standard	High Impulse	303	316							
1/8	B1K11	1K11	—	LL1K11	ML1K11	1/8-27	—	—	1.26	0.65	0.44	0.56
1/8	—	1K4	—	LL1K4	—	—	—	7/16-20	1.41	0.79	0.59	0.69
1/4	B2K16	2K16	2K16C	LL2K16	ML2K16	1/4-18	—	—	1.52	0.87	0.56	0.75
1/4	B2K16BS	2K16BS	—	LL2K16BS	ML2K16BS	—	1/4-19	—	1.52	0.87	0.56	0.75
1/4	—	2K6	2K6C	LL2K6	—	—	—	9/16-18	1.66	1.01	0.70	0.88
3/8	B3K21	3K21	3K21C	LL3K21	ML3K21	3/8-18	—	—	1.76	1.01	0.61	0.88
3/8	B3K21BS	3K21BS	—	LL3K21BS	ML3K21BS	—	3/8-19	—	1.76	1.01	0.61	0.88
3/8	—	3K8	3K8C	LL3K8	—	—	—	3/4-16	1.94	1.15	0.79	1.00
1/2	B4KP26	4KP26	4KP26	LL4KP26	ML4KP26	1/2-14	—	—	2.03	1.30	0.76	1.13
1/2	B4KP26BS	4KP26BS	4KP26BS	LL4KP26BS	ML4KP26BS	—	1/2-14	—	2.03	1.30	0.76	1.13
1/2	—	4KP10	4KP10	LL4KP10	—	—	—	7/8-14	2.11	1.37	0.84	1.19
3/4	B6KP31	6KP31	6KP31	LL6KP31	ML6KP31	3/4-14	—	—	2.36	1.52	0.71	1.31
3/4	B6KP31BS	6KP31BS	6KP31BS	LL6KP31BS	ML6KP31BS	—	3/4-14	—	2.36	1.52	0.71	1.31
3/4	—	6KP12	6KP12	LL6KP12	—	—	—	11/16-12	2.54	1.59	0.89	1.38
1	B8KP36	8KP36	8KP36	LL8KP36	ML8KP36	1-11/2	—	—	2.85	1.88	0.97	1.63
1	B8KP36BS	8KP36BS	8KP36BS	LL8KP36BS	ML8KP36BS	—	1-11	—	2.85	1.88	0.97	1.63
1	—	8KP16	8KP16	LL8KP16	—	—	—	15/16-12	2.85	2.17	0.97	1.88

C = Overall Length D = Maximum Diameter E = Exposed Length when Connected

Dust Caps and Dust Plugs Accessories:

Coupling Series	Plug Dust Cap Part No.		Socket Dust Plug Part No.	
	Metal	Vinyl	Metal	Vinyl
1HK	PDC1HK*	PPDC1HK	SDC1HK*	PSDC1HK
2HK	PDC2HK*	PPDC2HK	SDC2HK*	PSDC2HK
3HK	PDC3HK*	PPDC3HK	SDC3HK*	PSDC3HK
4HK	PDC4HK**	PPDC4HK	SDC4HK**	PSDC4HK
6HK	PDC6HK**	PPDC6HK	SDC6HK**	PSDC6HK
8HK	PDC8HK**	PPDC8HK	SDC8HK**	PSDC8HK

* Brass ** Aluminum



OPTIONS

- Non-valved socket and plug
- Bleeder-style plug
- Seals: PTFE, Neoprene, Fluorocarbon, Buna-N, EPDM and Kalrez (see Elastomer Selection Guide, page 82)
- Valve actuator in socket or plug
- Sleeve lock

ONE-WAY

TWO-WAY

STRAIGHT-THRU

GAS

ACCESSORIES

Series P2HK Plastic Coupling

The Series P2-HK coupling is intended for use with air, water and various chemicals at low pressure. It is designed for use where an economical, light weight, corrosion resistant coupling is desired. All components, except springs and seals, are molded from natural polypropylene with a UV inhibitor. Valve springs are 316 stainless steel. Fluorocarbon seals are standard. EPDM seals are optional.

Part No.	Thread Size NPTF	Dimensions			Hex
		A	B	HEX	
PP2H25F	1/4-18	2.38	1.45	0.88	

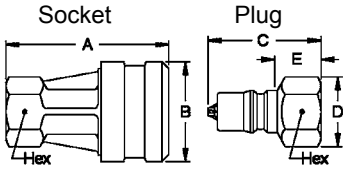

Part No.	Thread Size NPTF	Dimensions			Hex
		C	D	E	
PP2K25F	1/4-18	1.65	1.01	0.67	0.88

E = Exposed length when connected

Series 3HK Steam Coupling

The steam coupling has a large diameter flange on the sleeve to aid gripping while the user wears heavy gloves. EPDM seals are standard, and can be used with steam at temperatures up to 350°F. Options are BSPP threads, sleeve lock, EPDM seals for use with steam at temperatures above 350°F and fluorocarbon seals.

Part No.	Thread Size NPTF	Dimensions			Hex
		A	B	Across Flats	
B3H21Y	3/8-18	2.56	1.75	0.88	

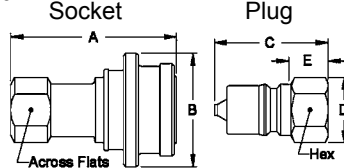

Part No.	Thread Size NPTF	Dimensions			Hex
		C	D	E	
B3K21192	3/8-18	1.76	1.01	0.61	0.88

E = Exposed length when connected

Release Clamp with Chain

When fluid lines may be subjected to a damaging pull, couplings can be mounted to disconnect automatically, sealing both ends of a line against fluid loss. The socket sleeve can be anchored to a stationary bracket, either directly or with a chain. Excessive pull on the plug end of the line moves the socket body forward relative to the sleeve, and the plug is released without damage to the line. Release Clamp Assembly Kits are available for Series 1HK through 8HKP sockets.

Series	Kit Part No.
1HK	1HRCK
2HK	2HRCK
3HK	3HRCK
4HKP	4HRCK
6HKP	6HRCK
8HKP	8HRCK

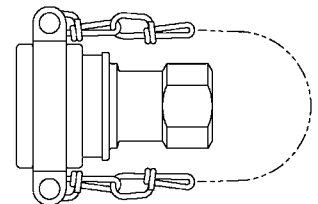

Bleeder-Style Plugs & One-Way Shut-Off Conversion Via (VAA)

Bleeder-style plugs can be used on air lines to prevent hose whip when disconnecting a line by reducing the exhaust velocity of air. Bleeder-style plugs can be used on hydraulic lines to prevent static pressure from building up in disconnected lines. Valves of these plugs are manufactured such that a small leak path exists when the plug is disconnected. Bleeder-style plugs are available in Series 1HK through 6HKP.

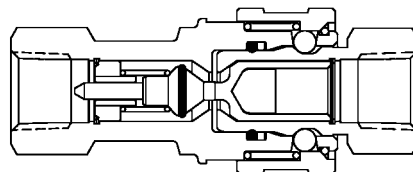

Typical use of VAA option with series HK

Series	Plug Part No.	Valve Actuator
1HK	B1K11VB	B1K11VAA
2HK	B2K16VB	B2K16VAA
2HK	2K16CVB	2K16CVAA
3HK	B3K21VB	B3K21VAA
3HK	3K21VB	3K21VAA
3HK	3K21CVB	3K21CVAA
4HKP	4KP26VB	4KP26VAA
6HKP	B6KP31VB	B6KP31VAA
6HKP	6KP31VB	6KP31VAA

HK 10/12/20 Series



Series 10-20 HK Couplings have the same features as the 1-8 HK, but have larger bodies and higher flow rates. Series HK couplings conform to the dimensional requirements of ISO 7241-1 Series B*. Body sizes range from 1¼" to 2½".

FEATURES

- Brass, steel and stainless steel construction available in all sizes
- End connections are female NPTF and BSPP
- Heavy duty steel couplings for use in high impulse service available in 12 HK and 20 HK

APPLICATIONS & MARKETS

- Agriculture
- Hydraulic Tool
- General Industry
- Construction
- Fluid Transfer
- Chemical
- Oil and Gas
- Transportation
- Food and Beverage
- Trucks
- Nuclear

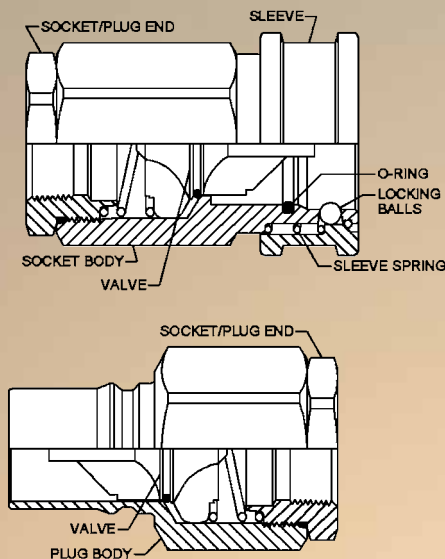

Interchangeability

- ISO 7241-1 Series B*



Materials

- Brass, zinc-plated steel or stainless steel construction
- Stainless steel springs, balls and retaining rings
- Buna-N (Nitrile) seals



1-1/4" to 2-1/2" nominal
(31.75 mm to 63.5 mm)



-40° F to 250° F
-40° C to 121° C
(with standard seal)



Rated Pressure

Part Number	Body Size inches (mm)	Brass		Steel		Stainless Steel	
		PSI	BAR	PSI	BAR	PSI	BAR
10HK	1¼ (31.8)	1,200	83	1,700	118	1,700	118
12HK	1½ (38.1)	1,500	104	2,200	152	2,200	152
20HK	2½ (63.5)	700	49	1,500	104	1,500	104



Flow Capacity

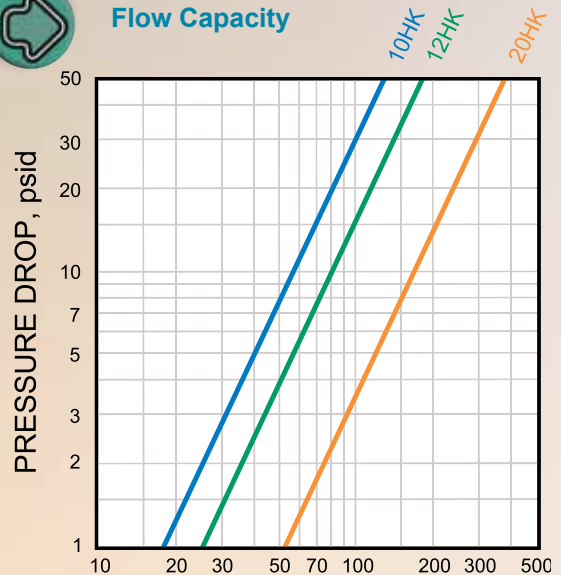

* No ISO Standard available for the 10HK.

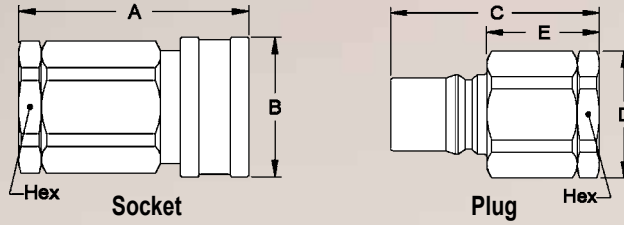

SOCKETS

Body Size (inch)	Part Number				Thread Size (female)		Dimensions (inches)		
	Brass	Steel		303 Stainless Steel	NPTF	BSPP	A	B	HEX
		Standard	High Impulse						
1¼*	B10H41	10H41	—	LL10H41	1¼-11½	—	4.51	2.73	2.38
1¼*	—	10H41BS	—	LL10H41BS	—	1¼-11	4.51	2.73	2.38
1½	B12H41	12H41	12H41C	LL12H41	1¼-11½	—	4.82	3.23	2.38
1½	B12H41BS	12H41BS	12H41CBS	LL12H41BS	—	1¼-11	4.82	3.23	2.38
1½	B12H46	12H46	12H46C	LL12H46	1½-11½	—	4.82	3.23	2.38
1½	B12H46BS	12H46BS	12H46CBS	LL12H46BS	—	1½-11	4.82	3.23	2.38
2½	B20H51	20H51	20H51	LL20H51	2-11½	—	5.55	4.11	3.75
2½	B20H51BS	20H51BS	20H51BS	LL20H51BS	—	2-11	5.55	4.11	3.75
2½	B20H56	20H56	20H56	LL20H56	2½-8	—	6.14	4.11	3.75
2½	B20H56BS	20H56BS	20H56BS	LL20H56BS	—	2½-11	6.14	4.11	3.75
2½	B20H61	20H61	20H61	LL20H61	3-8	—	7.00	4.11	4.00
2½	B20H61BS	20H61BS	20H61BS	LL20H61BS	—	3-11	7.00	4.11	4.00

A = Overall Length B = Maximum Diameter

PLUGS

Body Size (inch)	Part Number				Thread Size (female)		Dimensions (inches)			
	Brass	Steel		303 Stainless Steel	NPTF	BSPP	C	D	E	HEX
		Standard	High Impulse							
1¼*	B10K41	10K41	—	LL10K41	1¼-11½	—	4.25	2.74	2.33	2.38
1¼*	—	10K41BS	—	LL10K41BS	—	1¼-11	4.25	2.74	2.33	2.38
1½	B12K41	12K41	12K41C	LL12K41	1¼-11½	—	4.76	—	2.67	2.38
1½	B12K41BS	12K41BS	12K41CBS	LL12K41BS	—	1¼-11	4.76	2.74	2.67	2.38
1½	B12K46	12K46	12K46C	LL12K46	1½-11½	—	4.76	2.74	2.67	2.38
1½	B12K46BS	12K46BS	12K46CBS	LL12K46BS	—	1½-11	4.76	2.74	2.67	2.38
2½	B20K51	20K51	20K51C	LL20K51	2-11½	—	5.49	4.33	2.97	3.75
2½	B20K51BS	20K51BS	20K51CBS	LL20K51BS	—	2-11	5.49	4.33	2.97	3.75
2½	B20K56	20K56	20K56C	LL20K56	2½-8	—	6.08	4.33	3.56	3.75
2½	B20K56BS	20K56BS	20K56CBS	LL20K56BS	—	2½-11	6.08	4.33	3.56	3.75
2½	B20K61	20K61	20K61C	LL20K61	3-8	—	6.94	4.62	4.42	4.00
2½	B20K61BS	20K61BS	20K61CBS	LL20K61BS	—	3-11	6.94	4.62	4.42	4.00

C = Overall Length D = Maximum Diameter E = Exposed Length when Connected

* ISO 7241-1 Series B does not include 1-1/4 inch body size couplings; therefore, Series 10HK is not covered by this standard

Dust Caps and Dust Plugs Accessories:

Coupling Series	Plug Dust Cap Part No.	Socket Dust Plug Part No.
12HK	PDC12HK*	SDC12HK*
20HK	PDC20HK*	SDC20HK*

*Aluminum

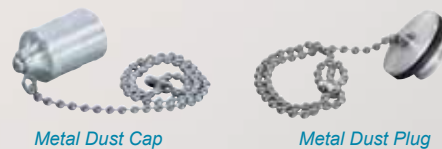

Metal Dust Cap

Metal Dust Plug

SPECIAL ORDERING INSTRUCTIONS FOR HK SERIES

How to build a socket or plug part number with options:

Example: 4HP26 - VAA - SL - 143

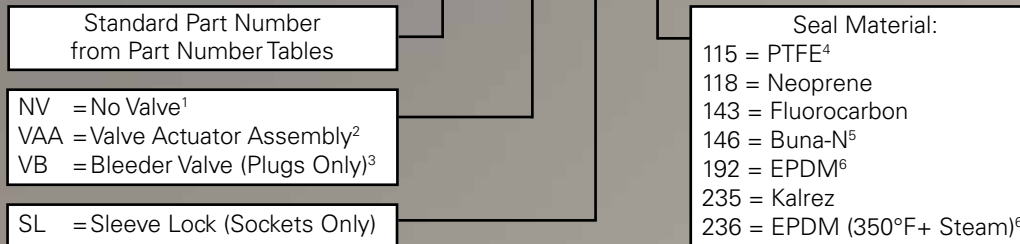

Notes:

- 1) The NV option should be specified for a socket and a plug when a non-valved coupling is desired. Non-valved Series 1HK through 8HKP plugs do not contain seals. Do not specify a seal material.
- 2) The VAA option should be specified for either a socket or a plug when a one-way coupling is desired. (Not available for series 10HK)
- 3) The VB option can be ordered for Series 1HK through 6HKP plugs to prevent pressure build-up in disconnected hydraulic lines or to reduce hose whip when disconnecting pneumatic lines.
- 4) Series HK couplings are designed for use with elastomer seals. PTFE is not an elastomer. It is rigid and not resilient. Couplings with PTFE seals may leak and/or be difficult to connect. Force to connect may be reduced by heating connected couplings in hot water; then, cooling before disconnecting. PTFE seals are available for Series 1-HK through 8-HKP, except Series P2-HK.
- 5) The 146 seal option may be specified for fuels and hydraulic fluids that are known to cause standard Buna-N seals to swell excessively.
- 6) The 236 EPDM seal option should be ordered for use with steam at or above 350° F. The 192 EPDM seal option should be ordered for hot water above 180° F and steam below 350° F.
- 7) Some part numbers may be subject to minimum order quantities and/or available only by special quotation. Consult your local distributor.
- 8) High Impulse – The high strength steel and heat treatment used to give increased resistance to “brinelling” (indentations by locking balls in the plug groove).



The **HKFR Series** is a quick disconnect, hydraulic coupling, that is designed for hazardous BOP (Blow-Out Preventer) service in the Oil & Gas Industry. It meets or exceeds the ISO 7241-1 Series B standard.

FEATURES

- Easy visual verification: BOP designation is clearly marked on the socket and plug, along with a distinctive red socket sleeve and red plug wrench flats for simple identification
- Dependable: equipped with ball-locking technology that provides a consistent, positive connection
- Compact design: ideal for building panels where space is limited
- Easy to use: connect and disconnect quickly without tools and no risk of cross threading
- Safe: sleeve lock is standard which prevents accidental disconnects
- Environmental protection: two-way valve design minimizes fluid spillage

APPLICATIONS & MARKETS

- Oil & Gas

SOCKETS

Part No.	Body Size	Thread Detail (Female)	Dimensions		
			A	B	Across Flats
4HFR26	1/2"	1/2-14 NPTF	2.96	1.86	1.13
6HFR31	3/4"	3/4-14 NPTF	3.48	2.22	1.31
8HFR36	1"	1-1½ NPTF	4.13	2.61	1.75
ML8HFR36*	1"	1-1½ NPTF	4.13	2.61	1.75

*Stainless Steel

Female End Connections

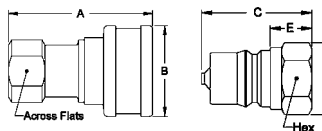

PLUGS

Part No.	Thread Size	Dimensions			
		C	D	E	HEX
4KFR26	1/2-14 NPTF	2.03	1.30	0.76	1.13
6KFR31	3/4-14 NPTF	2.36	1.52	0.71	1.31
8KFR36	1-11½ NPTF	2.85	1.88	0.97	1.63
ML8KFR36*	1-11½ NPTF	2.85	1.88	0.97	1.63



Interchangeability

- ISO 7241-1 Series B



Materials

- Steel
- Stainless Steel (ML8HFR36)



1/2" to 1" nominal
(12.7 mm to 25.4 mm)



Certified to 1300° F (700° C)

(see Lloyd's Register Certification below)



Rated Pressure Chart

Part Number	Body Size inches	Maximum Working Pressure (Connected)		Minimum Burst Pressure (Connected)	
		PSI	BAR	PSI	BAR
4HFR26	1/2	7,000	482	28,000	1,931
6HFR26	3/4	5,000	344	18,150	1,251
8HFR26	1	5,000	344	20,000	1,379
ML8HFR36*	1	5,000	344	20,000	1,379

*Stainless Steel

Lloyd's Register Certification

All of the above items carry a Lloyd's Registry Certificate for fire conditions stated in API 16D and EUB Directive 35. These parts meet the requirements that state couplings shall be capable of maintaining pressure when exposed to a 700° C (1,300° F) temperature for a five-minute period. Testing for this certification was conducted at the following pressures in the connected condition:

4HFR26 / 4KFR26: 3,000 PSI / 206 BAR

6HFR31 / 6KFR31: 3,000 PSI / 206 BAR

8HFR36 / 8KFR36: 4,000 PSI / 275 BAR

ML8HFR36 / ML8KFR36: 4,000 PSI / 275 BAR

HA15000 Series



The **HA15000 Series** is a general purpose hydraulic and fluid transfer coupling that conforms to the dimensional requirements of ISO 7241-1 Series A. Body sizes range from 1/4" to 1".

FEATURES

- Ball lock
- Manual connect, disconnect
- Poppet valving
- Slim profile
- Zinc plated steel construction
- NPTF and BSPP end connections
- Available push-to-connect socket designed for bulkhead mounting (1/2" body size only)

APPLICATIONS & MARKETS

- Construction
- Agriculture
- General Industry
- Fluid Transfer

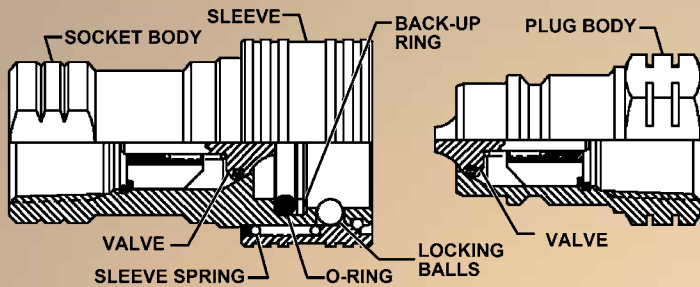

Interchangeability
- ISO 7241-1 Series A



Materials

- Zinc-plated steel construction
- Stainless steel springs, balls and retaining rings
- Buna-N (Nitrile) seals



1/4" to 1" nominal
(6.35 mm to 25.4 mm)



-4° F to 212° F
-20° C to 100° C



Rated Pressure

Body Size	PSI	BAR
1/4"	4,565	315
3/8"	4,565	315
1/2"	3,625	250
3/4"	3,625	250
1"	2,900	200



Flow Capacity

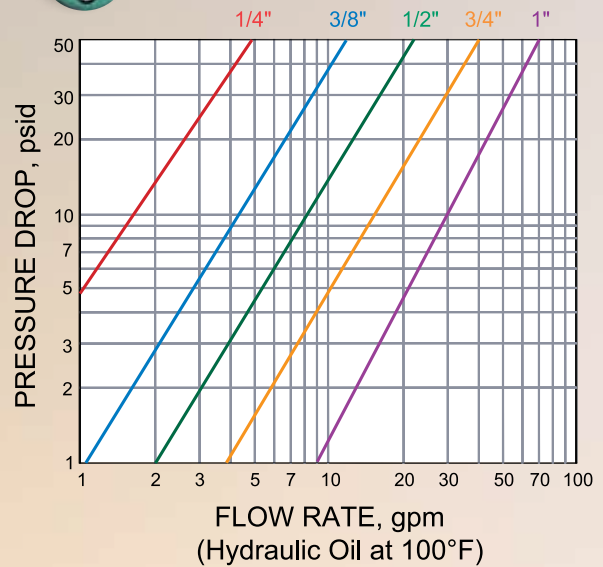

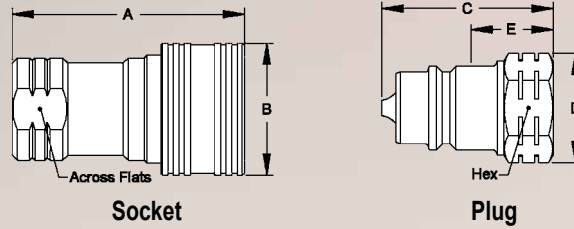

SOCKETS

Body Size (inch)	Part Number (Steel)	Thread Size (female)		Dimensions (inches)		
		NPTF	BSPP	A	B	Across Flats
1/4	HA1521100	1/4-18	—	1.89	0.98	0.75
1/4	HA1501100	—	1/4-19	1.89	0.98	0.75
3/8	HA1522100	3/8-18	—	2.21	1.18	0.91
3/8	HA1502100	—	3/8-19	2.21	1.18	0.91
1/2	HA1523100	1/2-14	—	2.64	1.49	1.06
1/2	HA1503100	—	1/2-14	2.64	1.49	1.06
1/2	HA1523600*	1/2-14	—	2.64	1.49	1.06
1/2	HA1503600*	—	1/2-14	2.64	1.49	1.06
3/4	HA1524100	3/4-14	—	3.25	1.88	1.38
3/4	HA1504100	—	3/4-14	3.25	1.88	1.38
1	HA1525100	1-11½	—	3.86	2.08	1.62
1	HA1505100	—	1-11	3.86	2.08	1.62

* Push-to-Connect Socket A = Overall Length B = Maximum Diameter

PLUGS

Body Size (inch)	Part Number (Steel)	Thread Size (female)		Dimensions (inches)			
		NPTF	BSPP	C	D	E	Hex
1/4	HA1521200	1/4-18	—	1.41	0.86	0.80	0.75
1/4	HA1501200	—	1/4-19	1.41	0.86	0.80	0.75
3/8	HA1522200	3/8-18	—	1.63	1.04	0.79	0.91
3/8	HA1502200	—	3/8-19	1.63	1.04	0.79	0.91
1/2	HA1523200	1/2-14	—	1.92	1.22	0.92	1.06
1/2	HA1503200	—	1/2-14	1.92	1.22	0.92	1.06
3/4	HA1524200	3/4-14	—	2.42	1.58	1.09	1.38
3/4	HA1504200	—	3/4-14	2.42	1.58	1.09	1.38
1	HA1525200	1-11½	—	2.81	1.85	1.19	1.62
1	HA1505200	—	1-11	2.81	1.85	1.19	1.62

C = Overall Length D = Maximum Diameter E = Exposed Length when Connected

Push-to-Connect Socket

**Part Numbers
HA1503600 &
HA1523600**

This system allows automatic connection and disconnection simply by pushing the plug into or pulling it out of the socket body. Pulling on the hose moves the socket body forward relative to the bulkhead mounted double-acting sleeve, and the plug is released without damage to the hose.

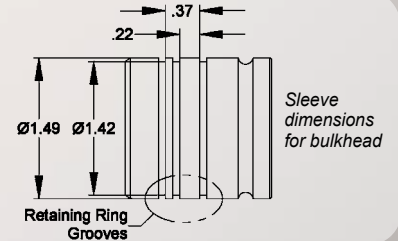

Dust Caps and Dust Plugs Accessories:

Body Size (inch)	Plug Dust Cap Part No.	Socket Dust Plug Part No.
1/4	HP1511200	HP1511100
3/8	HP1512200	HP1512100
1/2	HP1513200	HP1513100
3/4	HP1514200	HP1514100
1	HP1515200	HP1515100



Vinyl Dust Cap

ONE-WAY

TWO-WAY

STRAIGHT-THRU

GAS

ACCESSORIES

FF Series





The FF Series is a flat face dry break or minimum spill hydraulic coupling that meets or exceeds the ISO 16028 standard. FF series is ideal for applications where hydraulic spillage is a concern and interchangeability with other manufacturers is important. Body sizes are 1/4", 3/8", 1/2", 5/8", 3/4", and 1".

FEATURES

- Heavy knurled sleeve creates a non-slip grip
- Meets or exceeds ISO 16028 standard
- 5075 psi maximum operating pressure for all sizes (connected and disconnected)
- Push-to-connect
- Standard sleeve-locking device prevents accidental disconnection
- Color identification rings available to help prevent the crossing of lines

APPLICATIONS & MARKETS

- Agriculture
- Construction
- Hydraulic Tools
- Overhead Bucket Hoists
- Oil & Gas
- General Industry
- Chemical
- Trucks
- Skid Steer Loaders
- Injection Molding
- Railway
- Transportation
- Mining
- Public Utilities

-  **Interchangeability**
- ISO 16028
-  **Materials**
 - Zinc plated steel with clear chromate and QPQ finish; RoHS Compliant
 - Stainless steel springs and locking balls
 - Buna-N (Nitrile) seals
-  **1/4" to 1" nominal (6.35 mm to 25.4 mm)**
-  **-4° F to 212° F
-20° C to 100° C**
-  **Rated Pressure 5075 psi (350 BAR)**
maximum operating pressure
-  **Flow Capacity**
(see below)

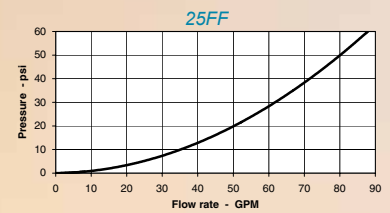
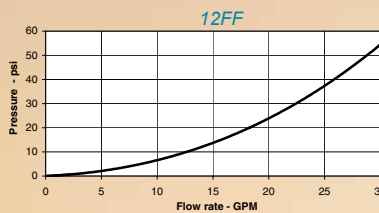
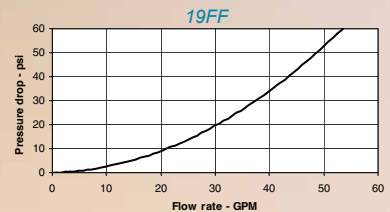
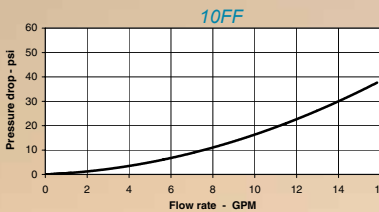
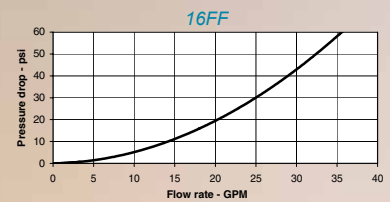
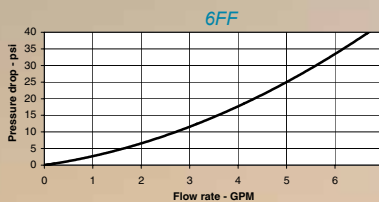

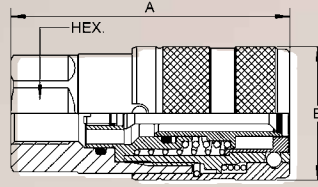

Socket

SOCKETS

Body Size	Part Number	Thread Size	Dimensions (inches)			Coupling Connected Length
			Socket			
			A	B	Hex Size	
1/4"	6FFS25BS	1/4" BSPP	2.13	1.06	0.87	3.7
	6FFS25	1/4" NPT	2.13	1.06	0.87	
	6FFS56UN	9/16" UNF	2.13	1.06	0.87	
3/8"	10FFS37BS	3/8" BSPP	2.68	1.26	1.06	4.61
	10FFS37	3/8" NPT	2.68	1.26	1.06	
	10FFS50BS	1/2" BSPP	2.8	1.26	1.06	
	10FFS50	1/2" NPT	2.8	1.26	1.06	
	10FFS16FMET	M16 x 150	2.8	1.26	1.06	4.84
	10FFS56UN	9/16" UNF	2.8	1.26	1.06	
	10FFS75UN	3/4" UNF	2.8	1.26	1.06	5.08
	10FFS87UN	7/8" UNF	2.91	1.26	1.18	
	10FFS56ORM*	9/16" UNF	3.11	1.26	0.94	
	10FFS75ORM*	3/4" UNF	3.19	1.26	0.94	
1/2"	12FFS50BS	1/2" BSPP	3.23	1.5	1.42	5.24
	12FFS50	1/2" NPT	3.23	1.5	1.42	
	12FFS75BS	3/4" BSPP	3.35	1.5	1.42	5.47
	12FFS75	3/4" NPT	3.35	1.5	1.42	
	12FFS75UN	3/4" UNF	3.23	1.5	1.42	
	12FFS87UN	7/8" UNF	3.35	1.5	1.42	5.71
	12FFS106UN	1-1/16" UN	3.46	1.5	1.42	
5/8"	16FFS50BS	1/2" BSPP	3.23	1.65	1.42	5.24
	16FFS50	1/2" NPT	3.23	1.65	1.42	
	16FFS75BS	3/4" BSPP	3.35	1.65	1.42	5.47
	16FFS75	3/4" NPT	3.35	1.65	1.42	
	16FFS75UN	3/4" UNF	3.23	1.65	1.42	
	16FFS87UN	7/8" UNF	3.35	1.65	1.42	5.71
	16FFS106UN	1-1/16" UN	3.46	1.65	1.42	
3/4"	19FFS75BS	3/4" BSPP	3.78	1.81	1.65	6.7
	19FFS75	3/4" NPT	3.78	1.81	1.65	
	19FFS100BS	1" BSPP	3.78	1.81	1.65	
	19FFS100	1" NPT	3.78	1.81	1.65	
	19FFS106UN	1-1/16" UN	3.78	1.81	1.65	
	19FFS131UN	1-5/16" UNF	3.78	1.81	1.65	
1"	25FFS100BS	1" BSPP	4.06	2.17	2.17	7.28
	25FFS100	1" NPT	4.06	2.17	2.17	
	25FFS125BS	1-1/4" BSPP	4.06	2.17	2.17	
	25FFS125	1-1/4" NPT	4.06	2.17	2.17	
	25FFS162UN	1-5/8" UN	4.06	2.17	2.17	

* = external thread

FF Series

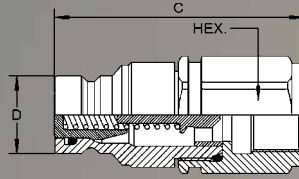

Plug

PLUGS

Body Size	Part Number	Thread Size	Dimensions (inches)			
			Plug			Coupling
			C	D	Hex Size	Connected Length
1/4"	6FFP25BS	1/4" BSPP	2.01	0.63	0.87	3.7
	6FFP25	1/4" NPT	2.01	0.63	0.87	
	6FFP56UN	9/16" UNF	2.01	0.63	0.87	
3/8"	10FFP37BS	3/8" BSPP	2.56	0.78	1.06	4.61
	10FFP37	3/8" NPT	2.56	0.78	1.06	
	10FFP50BS	1/2" BSPP	2.68	0.78	1.06	
	10FFP50	1/2" NPT	2.68	0.78	1.06	
	10FFP16FMET	M16 x 150	2.68	0.78	1.06	4.84
	10FFP56UN	9/16" UNF	2.68	0.78	1.06	
	10FFP75UN	3/4" UNF	2.68	0.78	1.06	5.08
	10FFP87UN	7/8" UNF	2.8	0.78	1.18	
	10FFP56ORM*	9/16" UNF	2.99	0.78	0.94	
	10FFP75ORM*	3/4" UNF	3.07	0.78	0.94	5.63
1/2"	12FFP50BS	1/2" BSPP	2.68	0.96	1.42	5.24
	12FFP50	1/2" NPT	2.68	0.96	1.42	
	12FFP75BS	3/4" BSPP	2.8	0.96	1.42	5.47
	12FFP75	3/4" NPT	2.8	0.96	1.42	
	12FFP75UN	3/4" UNF	2.68	0.96	1.42	
	12FFP87UN	7/8" UNF	2.8	0.96	1.42	5.71
	12FFP106UN	1-1/16" UN	2.91	0.96	1.42	
5/8"	16FFP50BS	1/2" BSPP	2.68	1.06	1.42	5.24
	16FFP50	1/2" NPT	2.68	1.06	1.42	
	16FFP75BS	3/4" BSPP	2.8	1.06	1.42	5.47
	16FFP75	3/4" NPT	2.8	1.06	1.42	
	16FFP75UN	3/4" UNF	2.68	1.06	1.42	
	16FFP87UN	7/8" UNF	2.8	1.06	1.42	5.47
	16FFP106UN	1-1/16" UN	2.91	1.06	1.42	5.71
3/4"	19FFP75BS	3/4" BSPP	3.74	1.18	1.65	6.7
	19FFP75	3/4" NPT	3.74	1.18	1.65	
	19FFP100BS	1" BSPP	3.74	1.18	1.65	
	19FFP100	1" NPT	3.74	1.18	1.65	
	19FFP106UN	1-1/16" UN	3.74	1.18	1.65	
	19FFP131UN	1-5/16" UNF	3.74	1.18	1.65	
	19FFP100BS	1" BSPP	4.09	1.42	2.17	
25FFP100	1" NPT	4.09	1.42	2.17		
25FFP125BS	1-1/4" BSPP	4.09	1.42	2.17		
25FFP125	1-1/4" NPT	4.09	1.42	2.17		
25FFP162UN	1-5/8" UN	4.09	1.42	2.17		

* = external thread

Dust Cap Accessories:

Body Size (inch)	Plug Dust Cap Part No.	Socket Dust Cap Part No.
1/4	PDC6FF	SDC6FF
3/8	PDC10FF	SDC10FF
1/2	PDC12FF	SDC12FF
5/8	PDC16FF	SDC16FF
3/4	PDC19FF	SDC19FF
1	PDC25FF	SDC25FF



Vinyl Socket Dust Cap



Vinyl Plug Dust Cap



The **5100 Series** coupling is a heavy-duty wing nut coupling designed for use in hydraulic lines where dry break and minimum air inclusion are required. It is ideal for hydraulic dump trucks, oil field equipment, spreading equipment and applications requiring the ability to connect and/or disconnect under pressure. Body sizes range from 3/4" up to 1 1/4".

FEATURES

- Flat face valve design
- Non-spill double shut-off with minimum air inclusion
- Connect/disconnect under pressure
- Corrosion resistant brass body
- Plugs can be bulkhead mounted
- Interchanges with other manufacturers' couplings
- Available with wing or hex nut configuration

APPLICATIONS & MARKETS

- Trucks
- Construction
- Oil and Gas
- Transportation

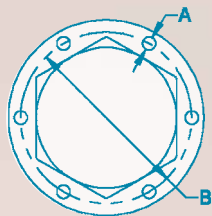

Bulkhead Mounting Flanges

Body Series	Part No.	Diameters (inches)		Plug Dust Cap (Brass)	Socket Dust Plug (Brass)
		Bolt Hole A	Bolt Circle B		
3/4"	150-22-12	.201	2.12	5100-S7-12	5100-S9-12
1"	150-22-16	.201	2.38	5100-S7-16	5100-S9-16
1 1/4"	150-22-20	.201	2.62	5100-S7-20	5100-S9-20

Dust Caps and Dust Plugs Accessories

SOCKETS

Body Size	Part No.	Thread Size NPT	Dimensions		
			A	B	Across Flats
3/4"	5100-S5-12B	3/4-14	3.07	4.13	1.16
1"	5100-S5-16B	1-11 1/2	3.68	4.38	1.44
1 1/4"	5100-S5-20B	1 1/4-11 1/2	4.00	5.27	1.78

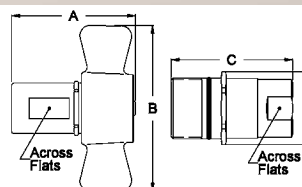

PLUGS

Body Size	Part No.	Thread Size NPT	Dimensions		
			C	D	Across Flats
3/4"	5100-S2-12B	3/4-14	3.11	1.38	1.19
1"	5100-S2-16B	1-11 1/2	3.55	1.74	1.56
1 1/4"	5100-S2-20B	1 1/4-11 1/2	3.71	2.08	1.88



Interchangeability

- Other manufacturers' couplings



Materials

- Brass body (socket & plug)
- Zinc plated ductile iron wing nut (socket)
- Stainless steel springs
- Buna-N (Nitrile) seals



3/4" to 1 1/4" nominal
(6.35 mm to 38.10 mm)



Rated Pressure

Body Series	PSI
3/4"	3,000
1"	3,000
1 1/4"	2,750



Flow Capacity

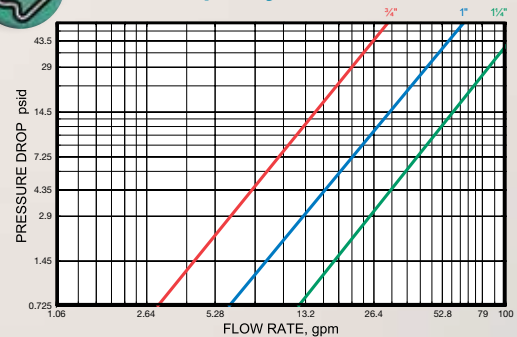

UP 10 Series



The **UP10 Series** is a high pressure hydraulic quick connect coupling designed to operate at pressures up to 10,000 psi. Unlike most high pressure hydraulic couplings that are screw-to-connect, the UP10 Series has a ball locking mechanism, making it quicker & easier to connect. Body size is 1/4".

FEATURES

- Ball lock
- Slim profile
- High strength steel construction
- Poppet valves with metal-to-metal sealing
- 1/4" & 3/8" male & female NPTF end connections
- Standard sleeve lock

APPLICATIONS & MARKETS

- Construction
- Hydraulic Tools

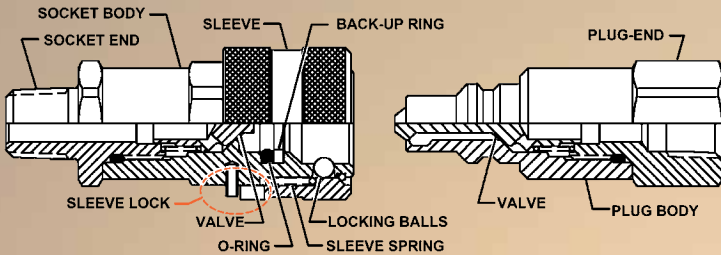

Interchangeability

- Proprietary



Materials

- High strength steel body and valve
- Stainless steel springs & balls
- Buna-N (Nitrile) seals
- PTFE back-up ring (socket)



1/4" nominal
(6.35 mm)



-40° F to 250° F
-40° C to 121° C



Rated Pressure
10,000 psi (700 BAR)



Flow Capacity

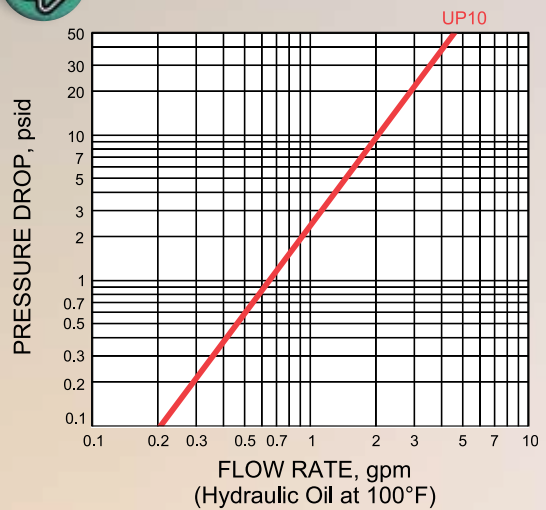

SOCKETS

PLUGS

Part No.	Thread Size	Dimensions		
		A	B	HEX
UP10S25M	1/4-18 NPTF	2.69	1.18	0.88
UP10S37M	3/8-18 NPTF	2.69	1.18	0.88

Male End Connections

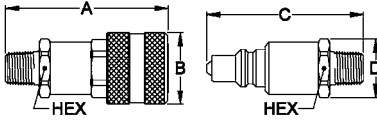

Part No.	Thread Size	Dimensions		
		C	D	HEX
UP10P25M	1/4-18 NPTF	2.59	0.97	0.88
UP10P37M	3/8-18 NPTF	2.59	0.97	0.88

Part No.	Thread Size	Dimensions		
		A	B	HEX
UP10S25F	1/4-18 NPTF	2.64	1.18	0.88
UP10S37F	3/8-18 NPTF	2.69	1.18	0.88

Female End Connections

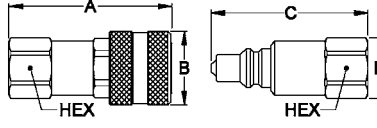

Part No.	Thread Size	Dimensions		
		C	D	HEX
UP10P25F	1/4-18 NPTF	2.54	0.97	0.88
UP10P37F	3/8-18 NPTF	2.59	0.97	0.88

Dust Caps and Dust Plugs Accessories:

Coupling Series	Plug Dust Cap Part No.	Socket Dust Plug Part No.
UP10	PPDC2HK	PSDC2HK



ONE-WAY

TWO-WAY

STRAIGHT-THRU

GAS

ACCESSORIES

WA56000/HP3 Series



The **WA56000 and HP3 Series** are high pressure hydraulic screw together couplings designed to operate at pressures up to 10,000 psi. Their rugged design makes them suitable for use in hydraulic ram, pump and high impulse applications. The WA 56000 has a poppet valve and HP3 has a ball valve. Body sizes are 1/4" and 3/8".

FEATURES

- Threaded latching
- Rugged steel construction
- Poppet valves with elastomer seal standard in 1/4" coupling
- Poppet valves and ball valves available in 3/8" coupling
- Body size matches thread size. 1/4" and 3/8" body sizes do not interchange.

APPLICATIONS & MARKETS

- General Industry
- Oil & Gas
- Test Equipment
- Hydraulic Tools
- Construction

Dust Caps and Dust Plugs

Body Size	Plug Dust Cap Part No.	Socket Dust Plug Part No.
1/4"	WA5611400	WA5611700
3/8"	W 5612400	WA5612700



Sockets – Male End Connections

Part No.	Valve Type	Thread Size NPTF	Dimensions		
			A	B	HEX
WA5651700	Poppet	1/4-18	2.36	1.12	0.88
WA5652700	Poppet	3/8-18	2.76	1.38	1.06
HP3SB37M	Ball	3/8-18	2.76	1.38	1.06

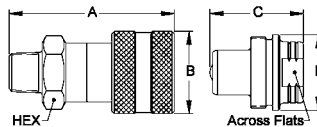

Plugs – Female End Connections

Part No.	Valve Type	Thread Size NPTF	Dimensions		
			C	D	Across Flats
WA5651400	Poppet	1/4-18	1.26	1.10	0.75
WA5652400	Poppet	3/8-18	1.52	1.26	0.91
HP3PB37F	Ball	3/8-18	1.52	1.26	0.91



Interchangeability

- Other manufacturers' couplings



Materials

- Zinc plated steel construction
- High strength steel ball valve
- Stainless steel spring
- WA: Buna-N (Nitrile) seal
- HP3: Urethane seal
- PTFE back-up ring (WA socket)



1/4" and 3/8" nominal
(6.35 mm and 9.525 mm)



-40° F to 250° F
-40° C to 121° C



Rated Pressure

Body Size	PSI	BAR
1/4"	10,000	690
3/8"	10,000	690



Flow Capacity

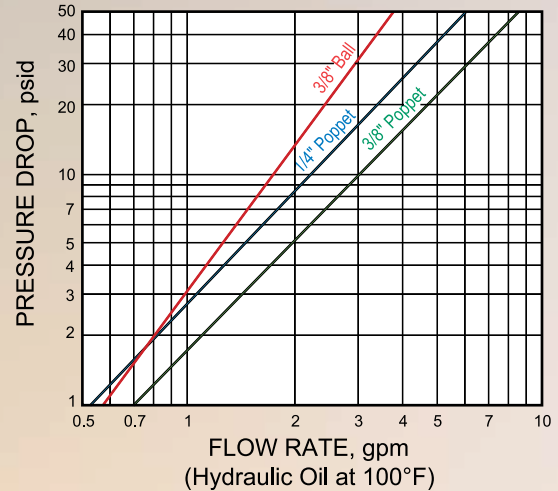



The 2HKIG and 2HKIL Series stainless steel couplings can be used with various liquids and gases. They are functionally identical, but do not interchange. They can be used where it is necessary to avoid crossing lines.

FEATURES

- Ball lock
- Manual operation
- Do not interchange with one another
- 1/4" body size
- All-stainless steel construction
- Sockets available with right-angle connection

APPLICATIONS & MARKETS

- Chemical
- General Industry
- Military
- Food and Beverage
- Aerospace

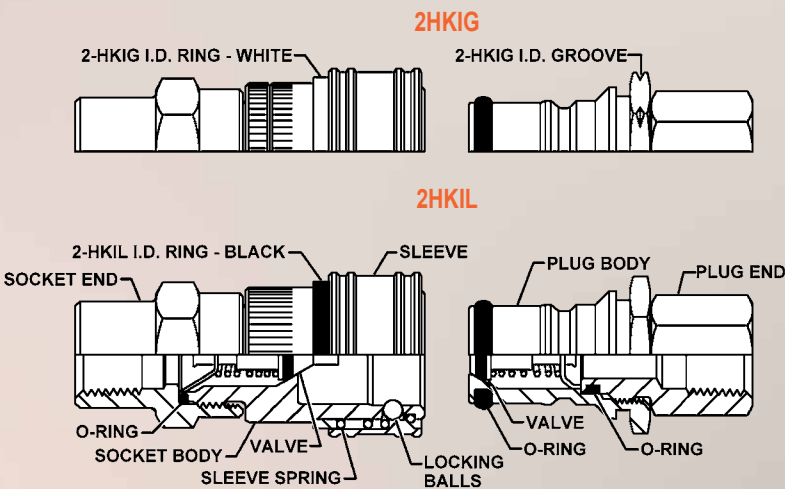

Interchangeability

- Proprietary



Materials

- Stainless steel body, valve, sleeve, springs, balls and retaining ring
- Buna-N (Nitrile) seals; optional PTFE, Fluorocarbon, and EPDM
- Socket identification ring
2HKIG: White acetal
2HKIL: Black acetal



**1/4" nominal
(6.35 mm)**



**-40° F to 250° F
-40° C to 121° C**



**Rated Pressure
1500 psi (103 BAR)**



Flow Capacity

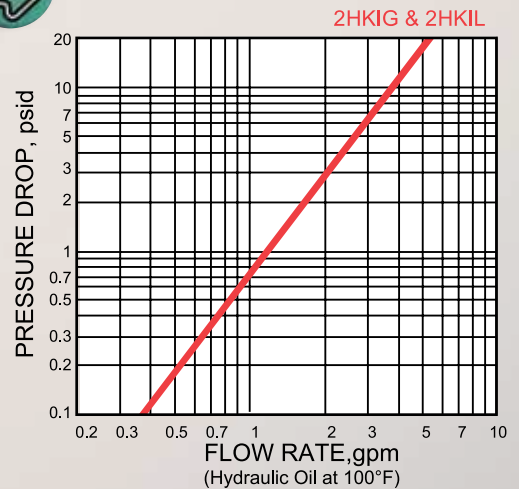

ONE-WAY

TWO-WAY

STRAIGHT-THRU

GAS

ACCESSORIES

2HKIG & 2HKIL Series

SOCKETS

2HKIG

PLUGS

Part No.	Thread Size	Dimensions		
		A	B	HEX
2HIG10	1/8-27 NPTF	2.18	1.06	0.81
2HIG15	1/4-18 NPTF	2.31	1.06	0.81
2HIG20	3/8-18 NPTF	2.31	1.06	0.81
2HIG720*	7/16-20	2.27	1.06	0.81
2HIGLLRA720†*	7/16-20	2.09	1.06	—

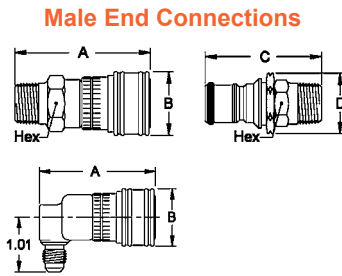

Part No.	Thread Size	Dimensions		
		C	D	HEX
2KIGF15	1/4-18 NPTF	1.98	1.01	0.69
2KIGF20	3/8-18 NPTF	1.98	1.01	0.69

Part No.	Thread Size	Dimensions		
		A	B	HEX
2HIG11	1/8-27 NPTF	2.18	1.06	0.81
2HIG16	1/4-18 NPTF	2.26	1.06	0.81

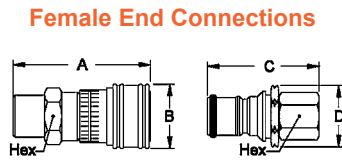

Part No.	Thread Size	Dimensions		
		C	D	HEX
2KIGF16	1/4-18 NPTF	1.84	1.01	0.69
2KIGF720*	7/16-20	1.61	1.01	0.69
2KIGF	9/16-18	1.17	1.01	0.88

SOCKETS

2HKIL

PLUGS

Part No.	Thread Size	Dimensions		
		A	B	HEX
2HIL10	1/8-27 NPTF	2.18	1.06	0.81
2HIL15	1/4-18 NPTF	2.31	1.06	0.81
2HIL20	3/8-18 NPTF	2.31	1.06	0.81
2HIL720*	7/16-20	2.27	1.06	0.81
2HILLRA720†*	7/16-20	2.09	1.06	—

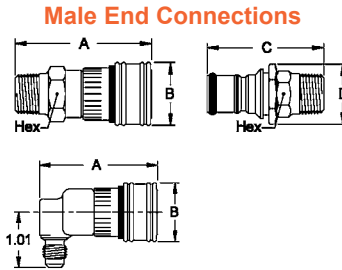

Part No.	Thread Size	Dimensions		
		C	D	HEX
2KILF15	1/4-18 NPTF	1.98	1.01	0.69
2KILF20	3/8-18 NPTF	1.98	1.01	0.69

Part No.	Thread Size	Dimensions		
		A	B	HEX
2HIL11	1/8-27 NPTF	2.18	1.06	0.81
2HIL16	1/4-18 NPTF	2.26	1.06	0.81

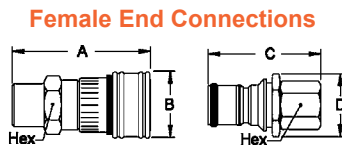

Part No.	Thread Size	Dimensions		
		C	D	HEX
2KILF16	1/4-18 NPTF	1.84	1.01	0.69
2KILF720*	7/16-20	1.61	1.01	0.69
2KILF	5/8-18	1.17	1.01	0.88

* 1/4" SAE Flare † Right-Angle End Connection

Dust Caps Accessories:

Coupling Series	Plug Dust Cap Part No.	Socket Dust Plug Part No.
2HKIG	PPDC2HK	PPDC4HK
2HKIL	PPDC2HK	PPDC4HK



Optional Seal Materials: 115-PTFE, 143-Fluorocarbon, 192-EPDM



The DB Series is designed for fluid handling where minimum spillage and minimum air inclusion are required. Couplings in this series are constructed of 316L stainless steel, which makes them suitable for use in cooling systems, chemical, pharmaceutical and food processing industries. Unique interchange prevents the crossing of lines (except 3/8" size). Body sizes range from 1/4" to 1".

FEATURES

- Ball lock
- Push-to-connect
- Minimal fluid loss when disconnecting
- Minimal air inclusion when connecting
- High flow capacity
- NPTF and BSPP threads available

Spillage & Air Inclusion

Body Size	Spillage Max. per Disconnect	Air Inclusion Max. per Connect
1/4"	0.010 ml	0.005 ml
3/8"	0.016 ml	0.010 ml
1/2"	0.020 ml	0.020 ml
3/4"	0.030 ml	0.100 ml
1"	0.035 ml	0.126 ml

APPLICATIONS & MARKETS

- Fluid Transfer
- Chemical
- Transportation
- Nuclear
- Food and Beverage
- Oil and Gas
- Military
- Cooling Systems
- Pharmaceutical
- Medical Equipment
- Aerospace

SOCKETS

Body Size (inch)	Part No.	Thread Size (Female)	Dimensions		
			A	B	HEX
1/4	2DBS25F	1/4-18 NPTF	1.98	1.02	0.88
1/4	2DBS25FBS	1/4-19 BSPP	1.98	1.02	0.88
3/8	3DBS37F	3/8-18 NPTF	2.36	1.27	1.06
3/8	3DBS37FBS	3/8-19 BSPP	2.36	1.27	1.06
1/2	4DBS50F	1/2-14 NPTF	2.52	1.59	1.38
1/2	4DBS50FBS	1/2-14 BSPP	2.52	1.59	1.38
3/4	6DBS75F	3/4-14 NPTF	3.21	2.00	1.62
3/4	6DBS75FBS	3/4-14 BSPP	3.21	2.00	1.62
1	8DBS100F	1-11½ NPTF	3.52	2.25	1.81
1	8DBS100FBS	1-11 BSPP	3.52	2.25	1.81

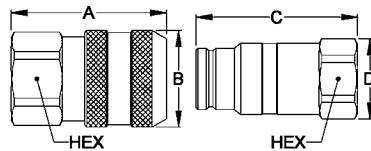

PLUGS

Body Size (inch)	Part No.	Thread Size (Female)	Dimensions		
			C	D	HEX
1/4	2DBP25F	1/4-18 NPTF	1.65	1.00	0.87
1/4	2DBP25FBS	1/4-19 BSPP	1.65	1.00	0.87
3/8	3DBP37F	3/8-18 NPTF	2.42	1.05	0.91
3/8	3DBP37FBS	3/8-19 BSPP	2.42	1.05	0.91
1/2	4DBP50F	1/2-14 NPTF	2.63	1.37	1.18
1/2	4DBP50FBS	1/2-14 BSPP	2.63	1.37	1.18
3/4	6DBP75F	3/4-14 NPTF	3.19	1.73	1.50
3/4	6DBP75FBS	3/4-14 BSPP	3.19	1.73	1.50
1	8DBP100F	1-11½ NPTF	3.52	2.08	1.81
1	8DBP100FBS	1-11 BSPP	3.52	2.08	1.81



Interchangeability

- ISO 16028 (3/8" only)
- Proprietary (All other sizes)



Materials

- 316L stainless steel construction
- Fluorocarbon seals; EPDM, Kalrez or other seal materials optional



1/4" to 1" nominal
(6.35 mm to 19.6 mm)



-4° F to 392° F
-20° C to 200° C } Fluorocarbon
40° F to 302° F
40° C to 150° C } EPDM



Rated Pressure

Body Size	Socket		Plug		Connected	
	PSI	BAR	PSI	BAR	PSI	BAR
1/4"	2,030	140	2,755	190	2,755	190
3/8"	2,030	140	2,610	180	2,610	180
1/2" - 1"	1,450	100	2,030	140	2,030	140



Flow Capacity

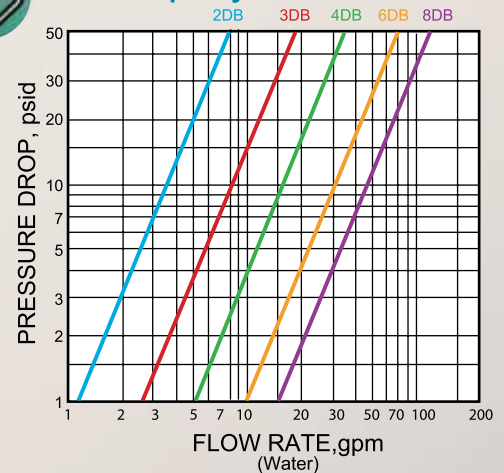



Straight Through

Contents and Selector Chart



Coupling Series	Page	Body Size										Body Material				Locking Mechanism		Options		
		1/8 INCH	1/4 INCH	3/8 INCH	1/2 INCH	3/4 INCH	1 INCH	1 1/4 INCH	1 1/2 INCH	2 INCH	2 1/2 INCH	BRASS	STEEL (Plugs Only)	STAINLESS STEEL (303)	PLASTIC (Polypropylene)	BALL LOCK	PLASTIC FINGERS	SLEEVE LOCK	SEAL MATERIALS (Various)	DUST CAP/PLUG
1ST	63/64	●									●	●	●		●		●	●		
2ST	63/64		●								●	●	●		●		●	●	▼	
3ST	63/64			●							●	●	●		●		●	●	▼	
4ST	63/64				●						●	●	●		●		●	●		
6ST	63/64					●					●	●	●		●		●	●	◆	
8ST	63/64						●				●	●	●		●		●	●	H	
10ST	63/64							●			●	●	●		●		●	●	H	
12ST	63/64								●		●	●	●		●		●	●		
16ST	63/64									●	●	●	●		●		●	●		
20ST	63/64										●	●	●		●		●	●		
P2ST	65		●										●		●					
P3ST	65			●									●		●					
Flo-Temp	67		●	●	●						●	●			●					

▼ Socket Dust Plug Only

◆ Socket Dust Plug and Dust Cap

H Plug Dust Cap Only

ONE-WAY

TWO-WAY

STRAIGHT-THRU

GAS

ACCESSORIES



ST Series



ST Series straight through couplings are designed for use where minimum pressure drop is required and valving is not needed. They are well suited for use on pressure wash, steam and carpet cleaning equipment, and many fluid transfer systems. Body sizes range from 1/8" to 2 1/2".

FEATURES

- Ball lock
- Manual operation
- Smooth bore permits free flow of liquid or gas
- Male and female NPTF, BSPP and hose stem connections

APPLICATIONS & MARKETS

- General Industry
- Fluid Transfer
- Chemical
- Food and Beverage
- Injection Molding
- Marine
- Military
- Carpet Cleaning
- Steam Cleaning
- Medical
- Breathing Equipment
- Pressure Wash
- Cooling Systems



Flow Capacity

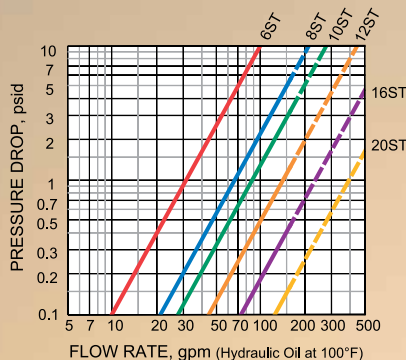
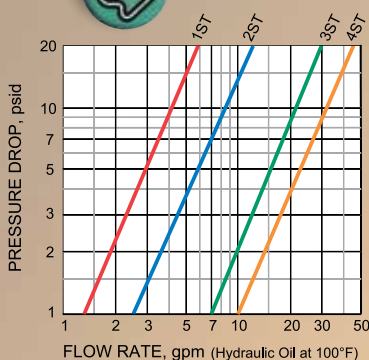

Interchangeability

- Other manufacturers' ST style couplings



Materials

- Brass or 303 stainless steel socket
- Stainless steel spring, balls and retaining ring
- Brass, zinc plated steel and 303 stainless steel plug
- High impulse heat treated 416 stainless steel plugs available in 1/4" and 3/8" body sizes
- Buna-N (Nitrile) seal; PTFE (1-ST through 8-ST), Neoprene, Fluorocarbon (FKM) and EPDM available



1/8" to 2 1/2" nominal
(3.175 mm to 63.5 mm)



-40° F to 250° F
-40° C to 121° C



Rated Pressure*

Series	Body Size	Brass Socket Brass Plug		Brass Socket Steel Plug		Stainless Steel Socket & Plug	
		PSI	BAR	PSI	BAR	PSI	BAR
1ST	1/8"	2,800	193	3,400	234	4,200	290
2ST	1/4"	5,200	359	5,500	379	7,500	517
3ST	3/8"	2,800	193	4,200	290	6,300	434
4ST	1/2"	2,200	152	3,500	241	3,600	248
6ST	3/4"	1,700	117	2,100	145	3,000	207
8ST	1"	1,300	90	2,000	138	2,000	138
10ST	1 1/4"	1,700	117	2,700	186	2,200	152
12ST	1 1/2"	1,400	97	2,200	152	2,500	172
16ST	2"	1,400	97	2,200	152	1,500	103
20ST	2 1/2"	900	62	1,500	103	-	-

* Pressure ratings are for sockets and plugs with threaded end connections. Pressure ratings of couplings with hose stems may be significantly lower, and will depend on the type of hose and the method of clamping. Refer to hose manufacturer's end connection pressure ratings. The best way to determine suitability for an application is to run pressure testing under controlled conditions.

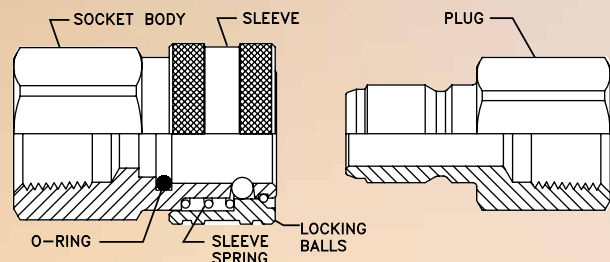

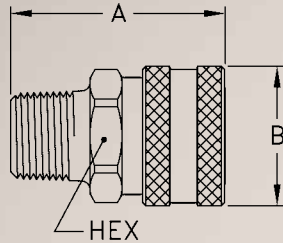
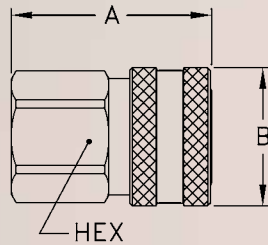
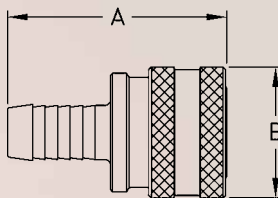
SOCKETS
Male End Connections

Female End Connections

Hose Stem Connections

Body Size	Part Number		Thread Size		Dimensions		
	Brass	Stainless	NPTF	BSPP	A	B	Hex
1/8	1S10	LL1S10	1/8-27	—	1.06	0.72	0.56
1/8	1S10BS	LL1S10BS	—	1/8-28	1.08	0.72	0.56
1/4	2S15	LL2S15	1/4-18	—	1.72	0.97	0.81
1/4	2S15BS	LL2S15BS	—	1/4-19	1.56	0.97	0.81
3/8	3S20	LL3S20	3/8-18	—	1.75	1.16	1.00
3/8	3S20BS	LL3S20BS	—	3/8-19	1.71	1.16	1.00
1/2	4S25	LL4S25	1/2-14	—	2.03	1.34	1.13
1/2	4S25BS	LL4S25BS	—	1/2-14	1.85	1.34	1.13
3/4	6S30	LL6S30	3/4-14	—	2.22	1.72	1.44
3/4	6S30BS	—	—	3/4-14	2.11	1.72	1.44
1	8S35	—	1-11 ¹ / ₂	—	2.53	2.03	1.75
1	8S35BS	—	—	1-11	2.43	2.03	1.75

Body Size	Part Number		Thread Size		Dimensions		
	Brass	Stainless	NPTF	BSPP	A	B	Hex
1/8	1S11	LL1S11	1/8-27	—	1.06	0.72	0.56
1/8	1S11BS	LL1S11BS	—	1/8-28	1.03	0.72	0.56
1/4	2S16	LL2S16	1/4-18	—	1.50	0.97	0.81
1/4	2S16BS	LL2S16BS	—	1/4-19	1.50	0.97	0.81
3/8	3S21	LL3S21	3/8-18	—	1.59	1.16	1.00
3/8	3S21BS	LL3S21BS	—	3/8-19	1.59	1.16	1.00
1/2	4S26	LL4S26	1/2-14	—	1.91	1.34	1.13
1/2	4S26BS	LL4S26BS	—	1/2-14	1.91	1.34	1.13
3/4	6S31	LL6S31	3/4-14	—	2.06	1.72	1.44
3/4	6S31BS	LL6S31BS	—	3/4-14	2.06	1.72	1.44
1	8S36	LL8S36	1-11 ¹ / ₂	—	2.33	2.03	1.75
1	8S36BS	LL8S36BS	—	1-11	2.33	2.03	1.75
1 ¹ / ₄	10S41*	LL10S41	1 ¹ / ₄ -11 ¹ / ₂	—	2.44	2.50	2.00
1 ¹ / ₄	10S41BS*	—	—	1 ¹ / ₄ -11	2.51	2.50	2.00
1 ¹ / ₂	12S46*	LL12S46	1 ¹ / ₂ -11 ¹ / ₂	—	2.88	3.13	2.63
1 ¹ / ₂	12S46BS*	LL12S46BS	—	1 ¹ / ₂ -11	2.88	3.13	2.63
2	16S51*	LL16S51	2-11 ¹ / ₂	—	3.09	3.75	3.00
2	16S51BS*	LL16S51BS	—	2-11	3.30	3.75	3.00
2 ¹ / ₂	20S56*	—	2 ¹ / ₂ -8	—	3.44	4.50	3.50

* With Steel Sleeve

Body Size	Part Number		Hose I.D.	Dimensions	
	Brass	Stainless		A	B
1/8	1S12	LL1S12	3/16"	1.41	0.72
1/8	1S17	LL1S17	1/4"	1.41	0.72
1/4	2S17	LL2S17	1/4"	2.10	0.97
3/8	3S22	LL3S22	3/8"	2.09	1.16
1/2	4S27	LL4S27	1/2"	2.19	1.34
3/4	6S32	LL6S32	3/4"	3.19	1.72
1	8S37	LL8S37	1"	3.32	2.03



ST Series

PLUGS

Male End Connections

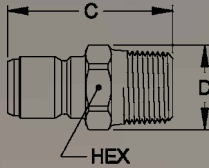

Body Size (inch)	Part Number			Thread Size (female)		Dimensions (inches)		
	Brass	Steel	Stainless	NPTF	BSPF	C	D	Hex
1/8	B1T10	1T10	LL1T10	1/8-27	—	1.06	0.51	0.44
1/8	B1T10BS	—	—	—	1/8-28	0.97	0.65	0.56
1/8	B1T15	1T15	—	1/4-18	—	1.22	0.65	0.56
1/4	B2T15	2T15	LL2T15	1/4-18	—	1.56	0.65	0.56
1/4	—	—	HL2T15*	1/4-18	—	1.56	0.65	0.56
1/4	B2T15BS	—	LL2T15BS	—	1/4-19	1.46	0.87	0.75
3/8	B3T20	3T20	LL3T20	3/8-18	—	1.69	0.79	0.69
3/8	—	—	HL3T20*	3/8-18	—	1.69	0.79	0.69
3/8	B3T20BS	—	LL3T20BS	—	3/8-19	1.59	1.01	0.88
1/2	B4T25	4T25	LL4T25	1/2-14	—	2.01	1.01	0.88
1/2	B4T25BS	—	LL4T25BS	—	1/2-14	1.82	1.15	1.00
3/4	B6T30	6T30	LL6T30	3/4-14	—	2.20	1.23	1.06
3/4	B6T30BS	—	LL6T30BS	—	3/4-14	2.08	1.44	1.25
1	B8T35	8T35	LL8T35	1-11½	—	2.49	1.59	1.38
1	B8T35BS	—	—	—	1-11	2.36	2.02	1.75
1¼	B10T40	10T40	LL10T40	1¼-11½	—	2.72	2.02	1.75
1¼	B10T40BS	—	—	—	1¼-11	2.55	2.31	2.00
1½	B12T45	12T45	—	1½-11½	—	3.31	2.60	2.25
1½	B12T45BS	—	—	—	1½-11	3.19	2.60	2.25
2	B16T50	16T50	LL16T50	2-11½	—	3.50	3.18	2.75
2	—	—	LL16T50BS	—	2-11	3.54	3.18	2.75
2½	B20T55	—	—	2½-8	—	4.24	3.75	3.25

Female End Connections

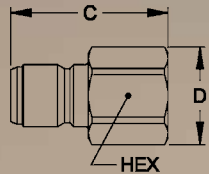

Body Size (inch)	Part Number			Thread Size (female)		Dimensions (inches)		
	Brass	Steel	Stainless	NPTF	BSPF	C	D	Hex
1/8	B1T11	1T11	LL1T11	1/8-27	—	0.97	0.58	0.50
1/8	B1T11BS	—	LL1T11BS	—	1/8-28	0.97	0.65	0.56
1/4	B2T16	2T16	LL2T16	1/4-18	—	1.45	0.79	0.69
1/4	—	—	HL2T16*	1/4-18	—	1.45	0.79	0.69
1/4	B2T16BS	—	LL2T16BS	—	1/4-19	1.45	0.87	0.75
3/8	B3T21	3T21	LL3T21	3/8-18	—	1.63	0.94	0.81
3/8	—	—	HL3T21*	3/8-18	—	1.63	0.94	0.81
3/8	B3T21BS	—	LL3T21BS	—	3/8-19	1.63	1.01	0.88
1/2	B4T26	4T26	LL4T26	1/2-14	—	1.92	1.15	1.00
1/2	B4T26BS	—	LL4T26BS	—	1/2-14	1.92	1.23	1.06
3/4	B6T31	6T31	LL6T31	3/4-14	—	2.01	1.37	1.19
3/4	B6T31BS	—	LL6T31BS	—	3/4-14	2.01	1.52	1.31
1	B8T36	8T36	LL8T36	1-11½	—	2.21	1.80	1.56
1	B8T36BS	—	LL8T36BS	—	1-11	2.23	1.80	1.56
1¼	B10T41	10T41	LL10T41	1¼-11½	—	2.34	2.31	2.00
1¼	B10T41BS	—	—	—	1¼-11	2.53	2.31	2.00
1½	B12T46	12T46	LL12T46	1½-11½	—	2.88	2.60	2.25
1½	B12T46BS	—	—	—	1½-11	2.88	2.60	2.25
2	B16T51	16T51	—	2-11½	—	3.03	3.18	2.75
2	B16T51BS	—	—	—	2-11	3.25	3.18	2.75
2½	B20T56	20T56	—	2½-8	—	3.37	3.75	3.25

* High impulse heat treated 416 stainless steel

Hose Stem Connections

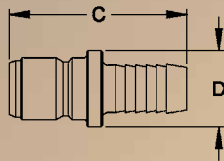

Body Size (inch)	Part Number		Hose I. D.	Dimensions (inches)	
	Brass	Stainless		C	D Ø
1/8	B1T12	LL1T12	3/16"	1.28	0.44
1/8	B1T17	LL1T17	1/4"	1.28	0.44
1/4	B2T17	LL2T17	1/4"	1.93	0.56
3/8	B3T22	LL3T22	3/8"	2.09	0.69
1/2	B4T27	LL4T27	1/2"	2.17	0.88
3/4	B6T32	LL6T32	3/4"	3.17	1.19
1	B8T37	LL8T37	1"	3.28	1.50

Dust Caps and Dust Plugs Accessories:



Series	Plug Dust Cap (Vinyl)	Socket Dust Plug (Vinyl)
2ST	—	PSDC1HK
3ST	—	PSDC2HK
6ST	PPDC4HK	PSDC4HK
8ST	PPDC6HK	—
10ST	PPDC8HK	—



P2ST and P3ST Series couplings have the same design as the ST, but with polypropylene construction, specifically designed for use with medical equipment. They can also be used in a variety of low pressure fluid transfer applications.

FEATURES

- Interchange with 2ST and 3ST
- Excellent chemical resistance
- Light weight

APPLICATIONS & MARKETS

- Medical
- Chemical
- Fluid Transfer
- Pharmaceutical



Interchangeability

- 2ST and 3ST



Materials

- Polypropylene construction
- Buna-N (Nitrile) seal



1/4" to 3/8" nominal
(6.35 mm to 9.525 mm)



-4° F to 176° F
-20° C to 80° C



Rated Pressure

Temperature*	PSI	BAR
75°	110	8
200°	30	2

*235° F maximum sterilization temperature

SOCKETS

Series	Part No.	Hose I.D.	Dimensions	
			A	B
P2ST	P2STS25H	1/4"	2.07	1.12
<i>Each P2-ST socket uses one Part No. 902-7 o-ring.</i>				
P3ST	P3STS37H	3/8"	2.61	1.37
<i>Each P3-ST socket uses one Part No. 902-10-199 o-ring.</i>				

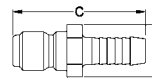
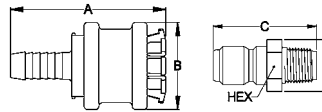

PLUGS

Series	Part No.	Thread Size	Dimensions		
			C	D	HEX
P2ST	P2STP25M	1/4-18 NPTF	1.56	0.65	0.56
P3ST	P3STP25M	1/4-18 NPTF	1.69	0.79	0.69
P3ST	P3STP37M	3/8-18 NPTF	1.69	0.79	0.69

Series	Part No.	Hose I.D.	Dimensions	
			C	D
P3ST	P3STP37H	3/8"	2.16	0.79



FLO-TEMP 200/300/500 Series



Flo-Temp couplings provide the flow needed to cool or heat injection molds and die casting dies. Sockets are available non-valved for maximum flow and valved to prevent fluid loss when disconnected. Flo-Temp couplings can be used with water-glycol, hot water and hot oil. Body sizes are 1/4", 3/8" and 1/2".

FEATURES

- Non-valved straight through models for maximum flow
- Valved sockets for automatic shut-off when line is disconnected
- Sockets available with straight, 90° or 45° hose stems or without hose stem
- Brass plugs with male pipe thread for recessed mounting to avoid damage to plugs when molds are being changed or stored

APPLICATIONS & MARKETS

- Injection Molding
- Heating/Cooling

REPLACEMENT PARTS

Description	Part Number		
	Series 200	Series 300	Series 500
Seal	WFT200228	WFT300228	WFT500228
Valve	VFT200	VFT300	VFT500
Valve O-Ring	9023143	9038143	9143143
Valve Spring	VSFT200	VS3000	VSFT500



Interchangeability

– Other manufacturers' coolant line couplings



Materials

- Brass socket construction
- Stainless steel spring and locking balls
- Fluorocarbon seal (-30° F to +450° F)
- Brass plug



1/4" to 1/2" nominal
(6.35 mm to 12.7 mm)



-30° F to 450° F
-34° C to 232° C



Rated Pressure
200 psi / 14 BAR



Flow Capacity

FT200V FT200 FT300V FT300 FT500V FT500

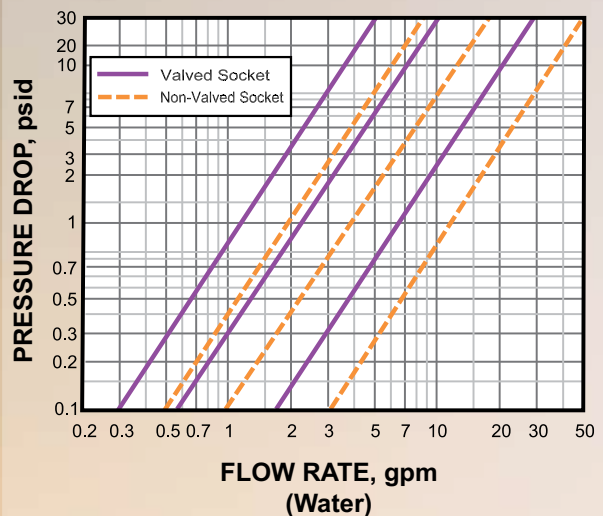

Straight Through

FLO-TEMP 200/300/500 Series

SOCKETS

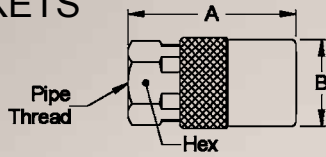

Without Hose Stem

Body Size (inch)	Part Number	Dimensions (inches)			Thread Size NPTF
		A	B	HEX	
1/4	LNFT200	1.68	0.67	0.56	1/8-27
3/8	LNFT300	2.18	0.89	0.75	1/4-18
1/2	LNFT500	2.00	1.17	1.13	1/2-14

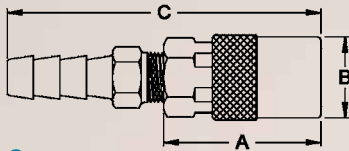

Straight Hose Stem

Body Size (inch)	Part Number		Hose I.D.	Dimensions (inches)		
	Non-Valved	Valved		A	B	C
1/4	FTS204	FTS204V	1/4"	1.20	0.67	2.25
1/4	FTS204HP*	FTS204VHP*	1/4"	1.20	0.67	2.09
1/4	FTS205	FTS205V	5/16"	1.20	0.67	2.09
1/4	FTS206	FTS206V	3/8"	1.20	0.67	2.25
1/4	FTS206HP*	FTS206VHP*	3/8"	1.20	0.67	2.34
3/8	FTS306	FTS306V	3/8"	1.60	0.91	2.68
3/8	FTS306HP*	FTS306VHP*	3/8"	1.61	0.89	2.75
3/8	FTS308	FTS308V	1/2"	1.61	0.88	2.82
3/8	FTS308HP*	FTS308VHP*	1/2"	1.61	0.88	2.82
1/2	FTS504	FTS504V	1/2"	2.25	1.18	3.42
1/2	FTS504HP*	FTS504VHP*	1/2"	2.25	1.18	3.62
1/2	FTS506	FTS506V	3/4"	2.22	1.18	3.85
1/2	FTS506HP*	FTS506VHP*	3/4"	2.22	1.18	4.35

*Part numbers with HP suffix have push-on hose barb. All other FTS part numbers have standard hose barb.

PLUGS

Male Pipe Thread

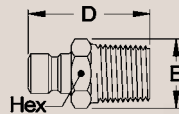

Body Size (inch)	Part Number Brass	Thread Size	Dimensions (inches)			Installation Recess	
			D	E	HEX	Dia.	Depth
1/4	FTP251	1/8-27 NPTF	0.94	0.49	0.44	0.69	0.69
1/4	FTP251BST	1/8-28 BSPT	0.94	0.49	0.44	0.69	0.69
1/4	FTP252	1/4-18 NPTF	1.15	0.63	0.56	0.84	0.94
1/4	FTP252BST	1/4-19 BSPT	1.15	0.63	0.56	0.84	0.94
1/4	FTP253	3/8-18 NPTF	1.19	0.77	0.69	1.00	0.94
3/8	FTP352	1/4-18 NPTF	1.40	0.63	0.56	1.00	1.09
3/8	FTP352BST	1/4-19 BSPT	1.40	0.63	0.56	1.00	1.09
3/8	FTP353	3/8-18 NPTF	1.40	0.77	0.69	1.00	1.13
3/8	FTP353BST	3/8-19 BSPT	1.40	0.77	0.69	1.00	1.13
3/8	FTP354	1/2-14 NPTF	1.56	0.98	0.88	1.19	1.25
1/2	FTP554	1/2-14 NPTF	1.75	0.98	0.88	1.25	1.50
1/2	FTP556	3/4-14 NPTF	1.75	1.25	1.13	1.50	1.56

90° Hose Stem

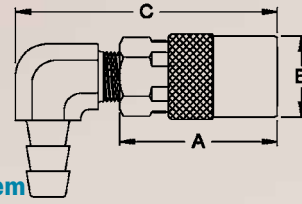

Body Size (inch)	Part Number		Hose I.D.	Dimensions (inches)		
	Non-Valved	Valved		A	B	C
1/4	FTS214	FTS214V	1/4"	1.36	0.67	2.17
1/4	FTS214HP*	FTS214VHP*	1/4"	1.18	0.67	1.76
1/4	FTS215	FTS215V	5/16"	1.18	0.67	1.76
1/4	FTS216	FTS216V	3/8"	1.17	0.67	1.76
1/4	FTS216HP*	FTS216VHP*	3/8"	1.17	0.67	1.76
3/8	FTS316	FTS316V	3/8"	1.60	0.88	2.43
3/8	FTS316HP*	FTS316VHP*	3/8"	1.60	0.88	2.43
3/8	FTS318	FTS318V	1/2"	1.60	0.88	2.43
3/8	FTS318HP*	FTS318VHP*	1/2"	1.60	0.88	2.43

45° Hose Stem

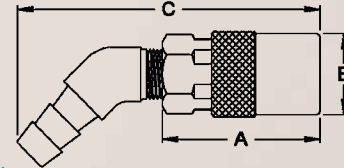

Body Size (inch)	Part Number		Hose I.D.	Dimensions (inches)		
	Non-Valved	Valved		A	B	C
1/4	FTS224	FTS224V	1/4"	1.17	0.67	2.40
1/4	FTS224HP*	FTS224VHP*	1/4"	1.17	0.67	2.40
1/4	FTS225	FTS225V	5/16"	1.17	0.67	2.40
1/4	FTS226	FTS226V	3/8"	1.17	0.67	2.40
1/4	FTS226HP*	FTS226VHP*	3/8"	1.17	0.67	2.40
3/8	FTS326	FTS326V	3/8"	1.80	0.90	3.70
3/8	FTS326HP*	FTS326VHP*	3/8"	1.80	0.90	3.17
3/8	FTS328	FTS328V	1/2"	1.60	0.90	3.17
3/8	FTS328HP*	FTS328VHP*	1/2"	1.60	0.90	3.17

Female Pipe Thread

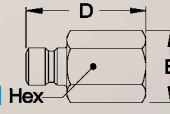

Body Size (inch)	Part Number Brass	Thread Size	Dimensions (inches)		
			D	E	HEX
1/4	FTP251F	1/8-27 NPTF	1.00	0.58	0.50
1/4	FTP251FBS	1/8-28 BSPT	1.00	0.65	0.56
1/4	FTP252F	1/4-18 NPTF	1.20	0.72	0.63
1/4	FTP252FBS	1/4-19 BSPT	1.20	0.87	0.75
1/4	FTP253F	3/8-18 NPTF	1.25	0.87	0.75
3/8	FTP352F	1/4-18 NPTF	1.38	0.72	0.63
3/8	FTP352FBS	1/4-19 BSPT	1.28	0.87	0.75
3/8	FTP353F	3/8-18 NPTF	1.40	0.87	0.75
3/8	FTP353FBS	3/8-19 BSPT	1.40	1.01	0.88
3/8	FTP354F	1/2-14 NPTF	1.62	1.08	0.94
1/2	FTP554F	1/2-14 NPTF	1.72	1.08	0.94
1/2	FTP556F	3/4-14 NPTF	1.78	1.30	1.13

ONE-WAY

TWO-WAY

STRAIGHT-THRU

GAS

ACCESSORIES



Gas





Gas-Mate couplings are one-way shut-off safety couplings designed for the connection of gas cooking appliances and other gas-fired devices. Body sizes are 3/8", 1/2", 3/4", 1" and 1 1/4".

FEATURES

- Connect and disconnect without using wrenches
- Automatic shut-off when plug is removed from socket
- In case of fire, heat-sensitive plug allows socket valve to close, stopping gas flow
- Push-to-connect (1 1/4" only)

APPLICATIONS & INDUSTRIES

- Industrial
- Fuel Gas Systems
- Food & Beverage

SOCKETS

Body Size	Part No.	Thread Size NPTF	Dimensions		
			A	B	Across Flats
*3/8"	100006E	3/8-18	2.44	1.13	1.00
*1/2"	100008	1/2-14	2.84	1.38	1.13
*3/4"	100010	3/4-14	3.17	1.75	1.50
*1"	100012E	1-11 1/2	3.94	2.13	1.75

Body Size	Part No.	Thread Size NPTF	Dimensions		
			A	B	HEX
**1 1/4"	GMS1250FH	1 1/4-11 1/2	4.15	2.28	2.00

**1-1/4" size For Indoor Use Only

*3/8", 1/2", 3/4" and 1" For Indoor/Outdoor Use -40°F (-40°C)

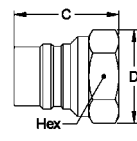
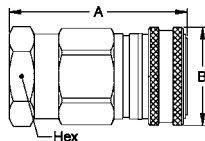
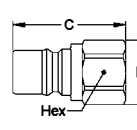
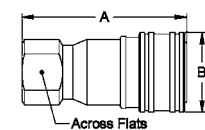

PLUGS

Body Size	Part No.	Thread Size NPTF	Dimensions		
			C	D	HEX
3/8"	100506	3/8-18	1.59	0.94	0.81
1/2"	100508	1/2-14	1.94	1.16	1.00
3/4"	100510	3/4-14	2.06	1.52	1.31
1"	100512	1-11 1/2	2.47	1.73	1.50

Body Size	Part No.	Thread Size NPTF	Dimensions		
			C	D	HEX
1 1/4"	GMP1250F	1 1/4-11 1/2	2.44	2.16	1.88

Dust Caps and Dust Plugs Accessories:

Body Size	Plug Dust Cap Part No.		Socket Dust Plug Part No.	
	Metal	Vinyl	Metal	Vinyl
3/8"	PDC2HK*	PPDC2HK	SDC2HK*	PSDC2HK
1/2"	PDC3HK*	PPDC3HK	SDC3HK*	PSDC3HK
3/4"	PDC4HK**	PPDC4HK	SDC4HK**	PSDC4HK
1"	PDC6HK**	PPDC6HK	SDC6HK**	PSDC6HK

*Brass **Aluminum



Materials

- Brass construction
- Stainless steel locking balls
- Valve actuator soldered to plug with low melting temperature alloy



3/8" to 1 1/4" nominal
(9.525 mm to 31.75 mm)

Capacities

Body Size	Socket Part No.	Plug Part No.	Capacity* BTU/hr	Socket O-Ring Part No.
3/8"	100006	100506	60,000	9143143M
1/2"	100008	100508	90,000	90214143M
3/4"	100010	100510	245,000	90218143M
1"	100012	100512	310,000	90223143M
1 1/4"	GMS1250FH	GMP1250F	500,000	91426143M

* Capacity is based on natural gas having a specific gravity of 0.64 and a heat capacity of 1,000 BTU per cubic foot. Inlet pressure is 12 inches water column and the pressure drop is 0.3 inch water column.

ONE-WAY

TWO-WAY

STRAIGHT-THRU

GAS

ACCESSORIES



CANADIAN STANDARDS ASSOCIATION*

Complies with the requirements of ANSI Z21.41b-2010/CSA 6.9b.2010

* CSA design certified, in both the United States and Canada, for natural gas, manufactured gas, liquefied petroleum and LP gas-air mixtures at pressures not in excess of 1/2 psig (3.5 kPa).



Accessories

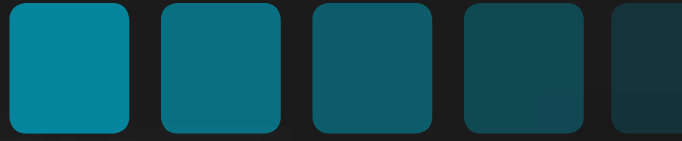



FS Flow Sensor Series



FS Flow Sensors Series are designed to protect personnel and property in case of hose failure in compliance with Federal Safety Regulations. Flow Sensors are intended for use with compressed air.

FEATURES

- Automatically shuts off air flow to ruptured hose
- Reduces risk of injury or damage from hose whip
- Automatically resets after failure correction
- 250 psig pressure rating (all sizes)
- Low pressure drop
- Operates in any orientation
- Compact design, economical, tamper-resistant

APPLICATIONS & INDUSTRIES

- General Industry
- Pneumatic Tools

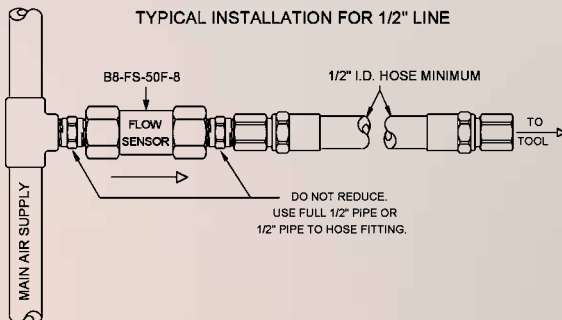
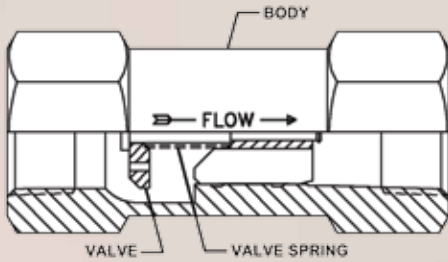

Materials

- Brass body
- Acetal valve (1/4" - 1")
- Brass valve (1 1/2")
- Stainless steel valve spring



Rated Pressure

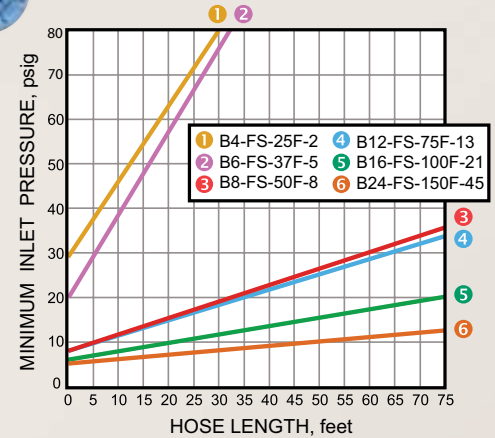

Flow Data - The graph above indicates the minimum inlet pressure for various hose lengths. Each Flow Sensor has a shut-off flow rating dependent upon inlet pressure. The length of hose and fitting size are critical in the proper operation of the valve. For example, with the B8-FS-50F-8 Flow Sensor, the hose I.D. must be 1/2" using only 1/2" pipe thread end fittings. Thirty feet of hose requires at least 20 psig inlet pressure; fifty feet of hose requires at least 28 psig inlet pressure; and seventy-five feet of hose requires at least 36 psig inlet pressure. Inlet pressures lower than those indicated on the curves above will not guarantee protection in case of hose failure. Valve shut-off occurs only when flow exceeds the flow rating for the inlet pressure.

If hose lengths greater than 75 feet are required, a 1/2" size or larger Flow Sensor must be installed on the inlet end of each 75-foot section, and a correspondingly higher inlet pressure must be supplied for proper operation of the Flow Sensor to assure safety.

Body Size	Part Number	Thread Size NPTF	Shut-Off Flow, scfm, at Inlet Pressure, Psig								Dimensions	
			60	80	100	100	140	160	180	200	Length	Hex
1/4"	B4FS25F2	1/4-18	16	18	20	22	23	25	26	27	2.14	0.75
3/8"	B6FS37F5	3/8-18	41	46	50	55	59	63	66	69	2.50	.088
1/2"	B8FS50F8	1/2-14	65	73	80	87	93	99	704	109	3.12	1.06
3/4"	B12FS75F13	3/4-14	105	118	130	141	152	161	169	177	3.68	1.38
1"	B16FS100F21	1-11 1/2	170	191	210	227	245	260	273	286	1.75	1.75
1 1/2"	B24FS150F45	1 1/2-11 1/2	365	410	450	489	525	557	586	615	5.86	2.50

All Flow Sensors have a pressure drop of approximately 2 psid at 80% of shut-off flow.

ONE-WAY

TWO-WAY

STRAIGHT-THRU

GAS

ACCESSORIES



In-Line Check Valves



RA 4000 Series in-line check valves are designed to allow flow of fluid in one direction only and limit the line's internal pressure (to the cracking pressure). They are rugged and reliable, offer low pressure drop and have elastomer valve seals for leak-free operation. Available sizes are 1/4" to 2".

FEATURES

- One-piece zinc plated steel body
- High strength steel valve provides excellent reliability under severe operating conditions
- The valve has a captive nitrile (Buna-N) seal, assuring no leakage at low and high pressures
- Low pressure drop versus flow rate
- Cracking pressure: 7 psi (0.5 bar)
- Cracking pressure is non-adjustable
- Contact supplier for availability of alternative cracking pressures

APPLICATIONS & INDUSTRIES

- Agriculture
- Construction
- Hydraulic Tools
- General Industry
- Fluid Transfer
- Oil and Gas

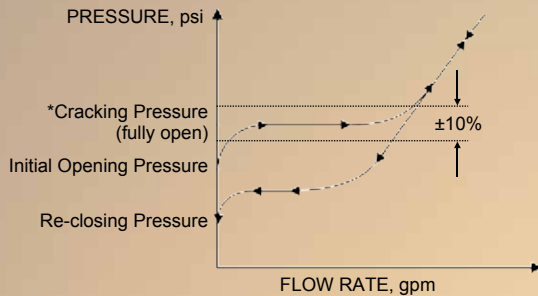

* The cracking pressure corresponds to the full discharge pressure (valve fully open) with a tolerance of ±10%.



1/4" to 2" nominal
(6.35 mm to 50.80 mm)



Rated Pressure

Size (inch)	Part No.	Thread NPTF	Dimensions		Rated Pressure	
			A	Hex	PSI	BAR
1/4	RA 04210 00	1/4-18	1.97	0.75	10,150	700
3/8	RA 04220 00	3/8-18	2.36	0.91	10,150	700
1/2	RA 04230 00	1/2-14	2.76	1.06	7,250	500
3/4	RA 04240 00	3/4-14	3.39	1.38	7,250	500
1	RA 04250 00	1-11½	3.94	1.62	7,250	500
2	RA 04290 00	2-11½	5.91	2.95	4,350	300

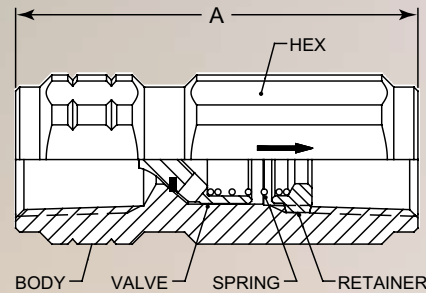

Pressure Drop vs. Flow Rate

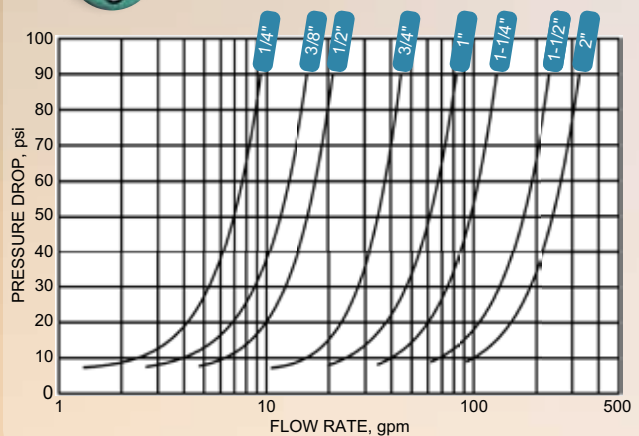



Flex-Air Fittings



The **Flex-Air Fitting** is designed to rotate 360° at up to a 75° angle. The Flex-Air Fitting helps to alleviate Carpal Tunnel Syndrome and other stress related injuries in the workplace.

FEATURES

- Unique design provides free 360° rotation with up to a 75° flex angle in any direction
- Many styles and sizes available
- 145 psig (10 Bar) pressure rating (all models)

BENEFITS

- Provides flexibility of tool position to help alleviate CTS (Carpal Tunnel Syndrome) and back stress resulting in fewer lost-time injuries
- Minimizes paint damage
- Prevents kinking of air supply hose

APPLICATIONS & MARKETS

- General Industry
- Pnuematic Tools



Materials

- Integrated steel/polyurethane construction
- Steel balls
- Buna-N (Nitrile) seal
- Thread sealant standard on male NPTs



20° F to 140° F



ONE-WAY

TWO-WAY

STRAIGHT-THRU

GAS

ACCESSORIES



Flex-Air Fittings

Female to Male



Part Number	FA25F25M
Inside Dia.	0.2" (5 mm)
Connectors	1/4" NPT Female 1/4" NPT Male

Male to Male



Part Number	FA25M25M
Inside Dia.	0.2" (5 mm)
Connectors	1/4" NPT Male 1/4" NPT Male

Industrial Plug to Male



Part Number	FA25P25M
Inside Dia.	0.2" (5 mm)
Connectors	1/4" Industrial Interchange 1/4" NPT Male



Part Number	FA25F37M
Inside Dia.	0.3" (7.5 mm)
Connectors	1/4" NPT Female 3/8" NPT Male



Part Number	FA37M37M
Inside Dia.	0.3" (7.5 mm)
Connectors	3/8" NPT Male 3/8" NPT Male



Part Number	FA37P25M
Inside Dia.	0.3" (7.5 mm)
Connectors	3/8" Industrial Interchange 1/4" NPT Male



Part Number	FA37F37M
Inside Dia.	0.3" (7.5 mm)
Connectors	3/8" NPT Female 3/8" NPT Male

ARO to Male



Part Number	FA25AR25M
Inside Dia.	0.2" (5 mm)
Connectors	ARO 210 Interchange 1/4" NPT Male

RL Plug to Male



Part Number	FA3RL37M
Inside Dia.	0.3" (7.5 mm)
Connectors	3/8" RL Plug 3/8" NPT Male

Hose Barb to Male



Part Number	FA37H37M
Inside Dia.	0.3" (7.5 mm)
Connectors	3/8" Barb 3/8" NPT Male

Lincoln to Male



Part Number	FA25LI25M
Inside Dia.	0.2" (5 mm)
Connectors	Lincoln Interchange 1/4" NPT Male



Hose Clamps (Brass) • Compression Type, Reusable

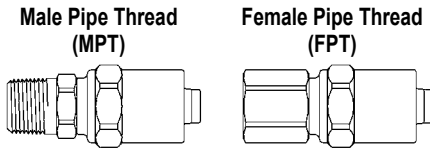

	1/8-27 NPTF			
	Hose		Part No.	
	I.D.	O.D.	MPT	FPT
Series B	1/4"	15/32"	1B1	-
	1/4"	1/2"	1B3	-
	1/4"	9/16"	1B5	-
	1/4"	5/8"	1B7	-

	1/4-18 NPTF			
	Hose		Part No.	
	I.D.	O.D.	MPT	FPT
Series A	3/16"	7/16"	2A0	-
Series B	1/4"	15/32"	2B1	3B1
	1/4"	1/2"	2B3	3B3
	1/4"	9/16"	2B5	3B5
	1/4"	5/8"	2B7	3B7
	1/4"	11/16"	2B9	3B9
Series C	5/16"	9/16"	2C5	-
	5/16"	5/8"	2C7	3C7
	5/16"	11/16"	2C9	-
Series D	3/8"	5/8"	2D7	3D7
	3/8"	11/16"	2D9	3D9
	3/8"	3/4"	2D11	3D11
	3/8"	7/8"	2D15	3D15
Series P	1/2"	13/16"	2P13	-
	1/2"	7/8"	2P15	-

	3/8-18 NPTF			
	Hose		Part No.	
	I.D.	O.D.	MPT	FPT
Series B	1/4"	15/32"	4B1	-
	1/4"	1/2"	4B3	-
	1/4"	9/16"	4B5	-
	1/4"	5/8"	4B7	-
Series C	5/16"	5/8"	4C7	-
	5/16"	11/16"	4C9	-
Series D	3/8"	5/8"	4D7	5D7
	3/8"	11/16"	4D9	5D9
	3/8"	3/4"	4D11	5D11
	3/8"	7/8"	4D15	5D15
Series P	1/2"	13/16"	4P13	-
	1/2"	7/8"	4P15	-

	1/2-14 NPTF			
	Hose		Part No.	
	I.D.	O.D.	MPT	FPT
Series P	1/2"	13/16"	6P13	7P13
	1/2"	7/8"	6P15	7P15
Series R	3/4"	11/8"	6R23	-
	3/4"	13/16"	6R25	-
	3/4"	11/4"	6R27	-

	3/4-14 NPTF			
	Hose		Part No.	
	I.D.	O.D.	MPT	FPT
Series P	1/2"	13/16"	8P13	-
	1/2"	7/8"	8P15	-
Series R	3/4"	11/8"	8R23	-
	3/4"	13/16"	8R25	-
	3/4"	11/4"	8R27	-

	1-11½ NPTF			
	Hose		Part No.	
	I.D.	O.D.	MPT	FPT
Series R	3/4"	11/8"	10R23	-
	3/4"	13/16"	10R25	-
	3/4"	11/4"	10R27	-

Swivel Nut Hose Clamps (Brass) • Compression Type, Reusable

With Brass Male Swivel Insert – External Seat (inverted flare) for use with paint spray and oxygen fittings, etc. (Will accept 37° or 45° flare.)

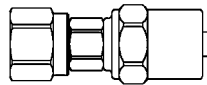

	9/16-18 Straight Thread		
	Hose		Part No.
	I.D.	O.D.	
Series A	3/16"	7/16"	4LA0*
	3/16"	7/16"	4RA0
	3/16"	1/2"	4LA3*
Series B	3/16"	1/2"	4RA3
	1/4"	15/32"	4RB1
	1/4"	1/2"	4LB3*
	1/4"	1/2"	4RB3
	1/4"	9/16"	4LB5*
Series D	1/4"	9/16"	4RB5
	1/4"	5/8"	4RB7
	3/8"	5/8"	4RD7
	3/8"	11/16"	4RD9
	3/8"	3/4"	4RD11

	1/4-18 NPSM Straight Thread		
	Hose		Part No.
	I.D.	O.D.	
Series B	1/4"	15/32"	5RB1
	1/4"	1/2"	5RB3
	1/4"	9/16"	5RB5
	1/4"	5/8"	5RB7
Series C	5/16"	5/8"	5RC7
Series D	3/8"	5/8"	5RD7
	3/8"	11/16"	5RD9
	3/8"	3/4"	5RD11

* Left-hand thread for acetylene service

With Steel Female Swivel Insert, 37° Female Flare, for use with flared tube fittings.

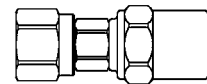

	7/16-20 Straight Thread		
	Hose		Part No.
	I.D.	O.D.	
Series B	1/4"	15/32"	720B1
	1/4"	1/2"	720B3
	1/4"	9/16"	720B5
	1/4"	5/8"	720B7

	5/8-18 Straight Thread		
	Hose		Part No.
	I.D.	O.D.	
Series D	3/8"	5/8"	2FD7
	3/8"	11/16"	2FD9
	3/8"	3/4"	2FD11

	9/16-18 Straight Thread		
	Hose		Part No.
	I.D.	O.D.	
Series D	3/8"	11/16"	4FD9
	3/8"	3/4"	4FD11
	3/8"	7/8"	4FD11

	3/4-16 Straight Thread		
	Hose		Part No.
	I.D.	O.D.	
Series P	1/2"	13/16"	1216P13
	1/2"	7/8"	1216P15

ONE-WAY

TWO-WAY

STRAIGHT-THRU

GAS

ACCESSORIES



Fittings

Hose Stems

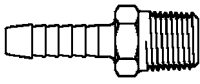

Hose Stem-to-Male Pipe Thread			
Hose I.D.	Thread NPTF	Part No.	
		Brass	Stainless
3/16"	1/8-27	-	LLS16
1/4"	1/8-27	SN17	-
3/8"	1/8-27	SN18	-
1/4"	1/4-18	-	LLS20
5/16"	1/4-18	S205	-
3/8"	1/4-18	S21	-
1/2"	1/4-18	S22	-
1/4"	3/8-18	S23	-
3/8"	3/8-18	S24	LLS24
1/2"	3/8-18	S25	-
1/2"	1/2-14	S26	LLS26
3/4"	3/4-14	-	LLS30
1"	1-11½	-	LLS35

Splicers (Brass)

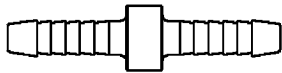

Hose Stem-to-Hose Stem	
Hose I.D.	Part No.
1/4"	HS31
5/16"	HS32
3/8"	HS33
1/2"	HS34

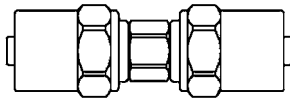

Hose Clamp-to-Hose Clamp		
Hose I.D.	Hose O.D.	Part No.
1/4"	1/2"	HSCB3
5/16"	5/8"	HSCC7
3/8"	11/16"	HSCD9

Unions (Brass)

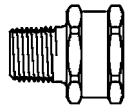

**Part No.
H25MHU**
1/4" Male Pipe Thread Union half consists of H25HMU01 body and 9028 o-ring.

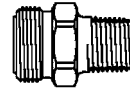

**Part No.
HHU25M**
1/4" Male Pipe Thread Union half

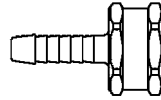

**Part No.
H25HHU**
1/4" Hose Stem Union half consists of H25HHU01 stem, 9028 o-ring and HUSN1 sleeve

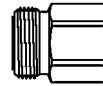

**Part No.
HHU25F**
1/4" Female Pipe Thread Union half

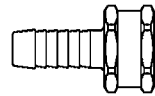

**Part No.
H37HHU**
3/8" Hose Stem Union half consists of H37HHU01 stem, 9028 o-ring and HUSN1 sleeve

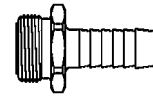

**Part No.
HHU37H**
3/8" Hose Stem Union half

Any union half shown on the left can be used with any union half shown on the right.

Adapters

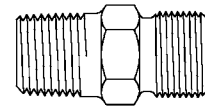

Oxygen Adapter (Brass)	
Part No.	Thread Size
9MBR	1/4-18 NPTF x 9/16-18 Right Hand

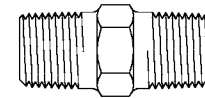

Pipe-to-Pipe Adapter (Brass)	
Part No.	Thread Size
19MBM	1/4-18 NPTF x 1/4-18 NPTF

All stainless steel fittings listed on this page are machined from Type 303 stainless steel bar stock.

Elastomer Selection Guide

Select seals compatible with the service intended for the couplings. Allowance must be made for the kind of fluid to be conveyed and its temperature. Chemically active fluids will destroy some seal materials. Certain seals withstand high temperatures, whereas others cannot. Use this elastomer selection guide to find the appropriate seal. NOTE: Elastomer or seal material listed as “Standard” is furnished in most Eaton couplings. Elastomers designated as “-118”, “-146”, “-192”, etc., are available as optional seal material for some couplings. Other seal materials available upon request to suit requirements. Consult your local distributor.

NOTE: Service conditions may vary. The following information it is intended as a guide only and is not a guarantee.

Seal Information

Dash No.	Compound
-***	Buna-N – 90 Durometer
-115	PTFE
-118	Neoprene
-143	Fluorocarbon
-146	Buna-N – 70 Durometer
-192*	EPDM
-235†	Kalrez
-236*	EPDM

*** No Dash Number required for standard seal material

* “-192” and “-236” compounds are not compatible with mineral-based greases or oils

† Kalrez seals available by special quotation

FLUID	EATON ELASTOMER	FLUID	EATON ELASTOMER
Air (to 200° F)	Standard	Kerosene	-146
Air (above 200° F)	-143	Lindol	-192▼
Acetone	-192▼	L.P. Gases	Standard
Acetylene	Standard	Methane	-146
Alcohol, Ethyl	-192▼	Methanol	Standard
Alcohol, Methyl	Standard	Methyl Ethyl Ketone	-192▼
Alkalies	-192▼	Methyl Iso-Butyl Ketone	-192▼
Ammonia, Anhydrous	Standard	MIL-H-5606A	Standard
Ammonium Hydroxide	-192▼	Mineral Spirits	-146
Aroclor	-143	Natural Gas	Standard
Brake Fluid, Non-Petroleum Based	-192▼	Nitrogen	Standard
Butane	-146	Octane	-143
Carbon Dioxide	Standard	Oils, including: Animal, Mineral with Aniline Point above 160° F and Non-Food Service Vegetable OS45 & OS45-1	Standard
Carbon Tetrachloride	-143	Oxygen	-143
Cellulube	-192▼		Service conditions dictate Elastomer Selection
Creosote	Standard	Pentane	-146
Diesel Fuel	-146	Perchloroethylene	-143
Diester Lubricants	-143	Propane	Standard
Ethane	-146	Propylene	-143
Ethanol	-192▼	Pydraul	-143
Ethylene Glycol	-192▼	Steam (to 350° F)	-192▼
Freon (most varieties)	-118	Steam (above 350° F)	-236▼
Gasoline, Aromatic & Non-Aromatic	-143	Stoddard Solvent	-146
Glycerin	Standard	Toluene	-143
Helium	Standard	Transmission Oil, Automotive	Standard
Heptane	-146	Trichloroethylene	-143
Hexane	-146	Turpentine	Standard
Houghto-Safe Series 200, 600, 5000	Standard	Versilube F-50	-192▼
Houghto-Safe Series 1000	-192▼	Water (to 180° F)	Standard
Hydraulic Fluid, Petroleum-based with Aniline Point above 160° F	Standard	Water (above 180° F)	-192▼
Hydrolube	Standard		
Jet Fuel (to 250° F)	-146		
Jet Fuel (above 250° F)	-143		

▼ “-192” and “-236” compounds are not compatible with mineral-based greases or oils

TECHNICAL & WARRANTY INFORMATION

⚠WARNING

About Industry Interchanges...It is possible to connect two different manufacturers' parts together so that they will effect a seal and work properly in a fluid system. Eaton Coupling Group cannot guarantee the quality, workmanship, dimensions, or tolerances of the other manufacturers' parts, even though they might be interchangeable. Therefore, whenever mixing parts, the final assembly must always be tested before being put into service. Failure to test could result in a sudden failure of the coupling causing severe personal injury or death.

Pressure Ratings**

Since application conditions vary so widely, the pressures listed are intended as a guide only and not a guarantee of performance. Pressure peaks and extreme surge flows may cause a coupling to become inoperative.

****NOTE!**

Pressure ratings listed were determined by testing threaded sockets and plugs. Sockets and plugs with hose stem and hose clamp end connections are designed and recommended for use with shop air line pressure only (150 psig maximum) when used with the appropriate style hose.

⚠WARNING

Over-pressurization could result in a sudden failure of the coupling causing severe bodily injury or death. Be sure to select the proper coupling for your application and use it only within the specified service pressure range.

⚠WARNING

Couplings do wear out. In order to avoid severe bodily injury or death, couplings must be routinely checked for condition and replaced if necessary.

Warranty

Every effort has been made to have all photographs and drawings accurately represent the products as they actually were at the time this catalog was printed. However, in order to effectively continue to meet the requirements of our users, changes in some items may have been made during the life of this catalog—which may be made without notice.

All Eaton Coupling products are guaranteed to be free of defects in material and workmanship for a period of 90 days from the date of shipment to a customer. Any claimed defect must be reported to the Eaton Coupling Group in writing within the warranty period. This warranty is limited to replacing or repairing, at the Company's option, f.o.b. the Company's factory, any part which upon Company inspection is found to be defective. Components purchased by the Company from others are warranted only to the extent of the guarantee or warranty, if any, made to the Company.

THE ABOVE WARRANTY COMPRISES THE COMPANY'S SOLE AND ENTIRE WARRANTY OBLIGATION AND LIABILITY IN CONNECTION WITH EATON. ALL OTHER WARRANTIES, EXPRESS OR IMPLIED, INCLUDING, WITHOUT LIMITATION, WARRANTIES OR MERCHANTABILITY AND FITNESS FOR A PARTICULAR PURPOSE, ARE EXPRESSLY EXCLUDED. THE COMPANY IN NO EVENT SHALL BE LIABLE FOR INDIRECT OR CONSEQUENTIAL DAMAGES ARISING OUT OF THE SALE OR USE OF EATON COUPLINGS.

Eaton
Hydraulics Group USA
1000 W. Bagley Road
Berea, OH 44017
USA
Tel: 440-826-1115
Fax: 440-826-1105
www.eaton.com/hydraulics

Eaton
Hydraulics Group USA
14615 Lone Oak Road
Eden Prairie, MN 55344
USA
Tel: 952-937-9800
Fax: 952-294-7722
www.eaton.com/hydraulics

Eaton
Hydraulics Group Europe
Route de la Longeraie 7
1110 Morges
Switzerland
Tel: +41 (0) 21 811 4600
Fax: +41 (0) 21 811 4601

Eaton
Hydraulics Group Asia Pacific
Eaton Building
No.7 Lane 280 Linhong Road
Changning District,
Shanghai 200335
China
Tel: (+86 21) 5200 0099
Fax: (+86 21) 2230 7240

