

AC
POWERED



USER'S

DC
POWERED



MANUAL

S
POWERED



For Electric Fence Energizers,
Chargers, Controllers, Fencers
manufactured by Woodstream
Corporation

Part I: Fence Energizer Installation

| | |
|--|-------|
| Before You Start | p. 3 |
| Fence Energizer Installation | p. 5 |
| Fence Energizer Operation | p. 12 |

Part II: Electric Fencing Basics

| | |
|--------------------------------------|-------|
| Electric Fencing Basics | p. 13 |
| Grounding System | p. 14 |
| Fence Posts | p. 16 |
| Fence Wire | p. 18 |
| Insulators | p. 20 |
| Lightning/Surge Protection | p. 21 |
| Electric Fence Design | p. 23 |
| Gate Openings | p. 26 |
| Testing/Troubleshooting | p. 27 |
| Fence Energizer Warranty | p. 30 |

SAVE THESE INSTRUCTIONS

IMPORTANT INFORMATION

FOR OPTIMAL RESULTS, WE RECOMMEND YOU HAVE THE FOLLOWING:

1. Electric Fence Tester
2. Three 6-8' Ground Rods
3. Battery Tester (For DC and Solar)

WARNING: THE FOLLOWING CAN RESULT IN DECREASED FENCE PERFORMANCE

1. Brush, weed, and plant growth around the base of your fence.
2. Improper grounding.
3. Snow.
4. Cracked or broken insulators.
5. Fence wires that are less than 4" apart.
6. Dry, rocky or sandy soils.
7. Insufficiently charged battery.

Before You Start

Woodstream manufactured pulse-type AC electric fence energizers meet Underwriters Laboratories (UL) standards for safety .

- ▲ **WARNING:** Read ALL these instructions. Only use electric fence energizer products for the purpose intended as defined in this manual.
- ▲ **WARNING:** Never run more than one fence energizer on the same fence line at one time. The pulse time between the fence energizers will be too close together and could be hazardous to animals and people . It could also damage your fence energizers .
- ▲ **WARNING:** Install fence lines powered by separate fence energizers far enough apart to prevent contact with both fence lines at the same time . Simultaneously touching two fences powered by separate energizers could be hazardous .
- ▲ **WARNING:** In brushfire-prone areas, turn the fence off on extremely dry days. For backup, be sure others know how to disconnect the fencer. Also, never disconnect wires or approach a fence during lightning storms.
- ▲ **WARNING:** Do not operate fence energizers near any combustible materials including gasoline, kerosene and cleaning fluids.
- ▲ **WARNING:** Never electrify barbed wire or similar fence types where an animal or human may become tangled in the fence or caught against the fence
- ▲ **CAUTION**  **WARNING:** To reduce risk of electrical shock, do not remove the fence controller cover Refer to service personnel
- ▲ **WARNING:** Check local zoning laws for electric fencing guidelines in your area. Also check with local utilities before digging to identify any buried cables or natural gas lines .
- ▲ **WARNING:** Many AC energizers are internally grounded and are equipped with polarized 2 prong plugs. These plugs must never be altered and must be inserted into a properly installed, appropriate outlet. Only use a polarized extension cord Damaged polarized plugs must be replaced with polarized plugs. Failure to follow this warning could create a safety hazard, damage the energizer, and void the warranty .
- ▲ **WARNING:** Energizers requiring an external ground must be properly grounded

- ▲ **WARNING:** Any alteration of this containment system from the way that it comes from the factory will not only void the warranty but will likely create a safety hazard, as well .
- ▲ **WARNING:** Never simultaneously connect the energizer in this system with any other device such as a cattle trainer or poultry trainer . In the event that lightning strikes your fence it will be conducted to the other devices
- ▲ **WARNING:** Never install an electric fence under a high-voltage transmission line.
- ▲ **WARNING:** Never climb an electric fence.
- ▲ **WARNING:** Install enough electric fence warning signs so they can be easily seen from all directions.
- ▲ **WARNING:** Instruct all family members and staff about the operation of the fence and how to de-energize it if necessary.
- ▲ **WARNING:** Only use approved materials in the construction of an electric fence



In a double-insulated energizer, two systems of insulation are provided instead of grounding. No means of equipment ground is provided in the supply cord of a double-insulated energizer, nor should a means for equipment grounding be added to the energizer. Servicing of a double-insulated energizer requires extreme care and knowledge of the system, and should be done only by qualified service personnel. Replacement parts for a double-insulated energizer must be identical to the parts they replace.

Tools Required

- Flathead & Phillips Screwdrivers
- Wire Cutter/Stripper
- Adjustable Wrench
- Voltage Tester

Other Required Components

- Two lengths of 20 KV insulated hook-up wire (one long enough to connect fence energizer to ground system and one long enough to connect fence energizer to fence line)
- Fence line connector or clamp
- (3) 6- to 8-foot ground rods
- Ground rod clamps—one per ground rod

Fence Energizer Installation

Overview of Installed Fence Energizer

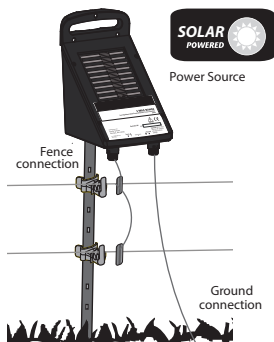
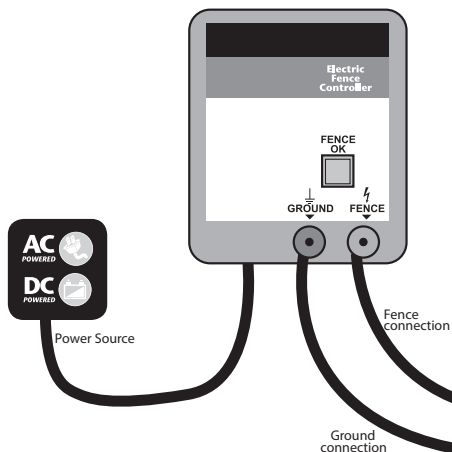

STEP 1: Mount Fence Energizer

IMPORTANT: Mount inside or in a waterproof enclosure

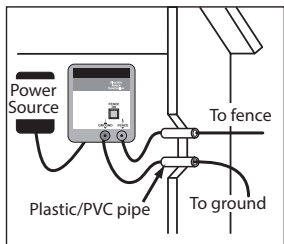

Inside installation

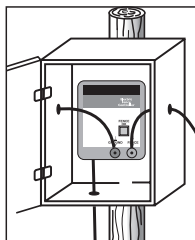

Outdoor sheltered installation

Single screw mounting

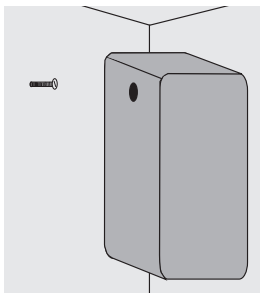

Double screw mounting

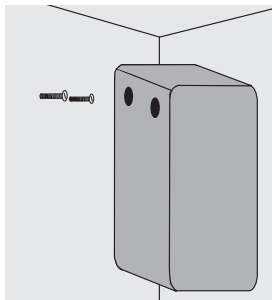

STEP 2: Connect Ground and Fence Terminals

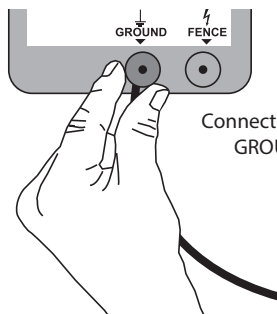
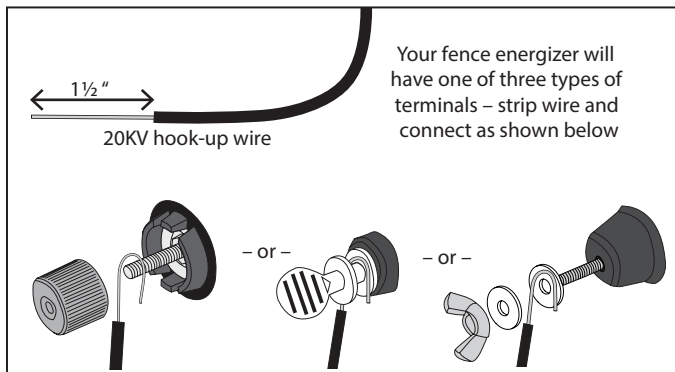

Connect hook-up wire to FENCE terminal

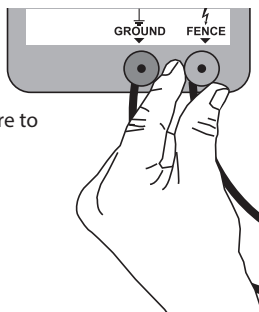

STEP 3: Connect to Ground System

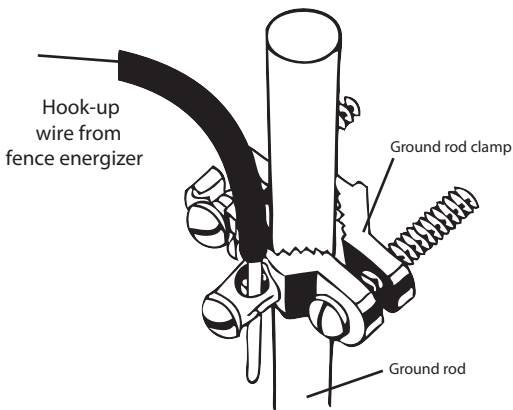

NOTE: Connect additional ground rods with hook-up wire and ground rod clamps

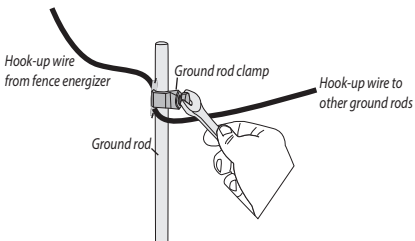

Check ground system reliability

• IMPROPER GROUNDING WILL AFFECT THE PERFORMANCE OF YOUR FENCE ENERGIZER! See page 14 for more information about proper grounding.

- ① Tip: The fence energizer must be grounded sufficiently for the system to work effectively. Improper grounding can also cause interference on telephone lines, radios and television and could invalidate your warranty.

STEP 4: Connect to Fence Line

Aluminum/Steel/Poly wire connection

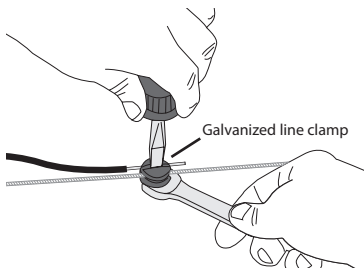

Poly tape connection

Poly tape connector clamp

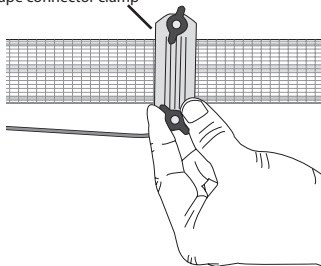

Poly rope/braid connection

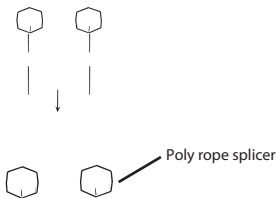

Check fence system reliability

- IMPROPER CONNECTION POINTS WILL AFFECT THE PERFORMANCE OF YOUR FENCE ENERGIZER!
- Make sure splices and insulators are sound and secure.

STEP 5: Power Fence Energizer

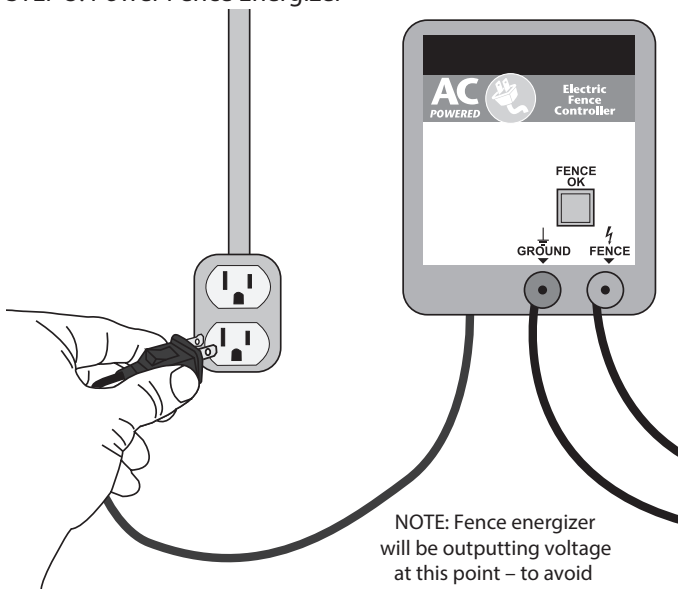

NOTE: Fence energizer will be outputting voltage at this point – to avoid shock do not touch fence terminal or fence wire.

To reduce the risk of electric shock, the AC-powered energizers have a polarized plug (one blade is wider than the other). This plug will fit in a polarized outlet only one way. If the plug does not fit fully in the outlet, reverse the plug. If it still does not fit, contact a qualified electrician to install the proper outlet. Do not change the plug in any way.

STEP 5: Power Solar Energizer

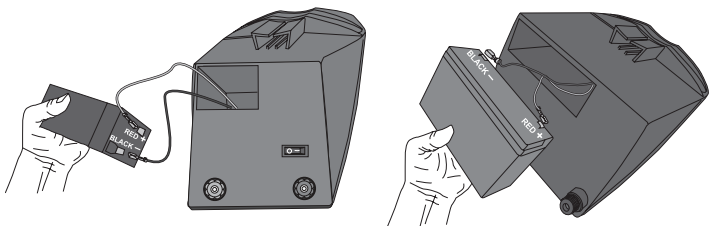

Locations of energizer batteries.

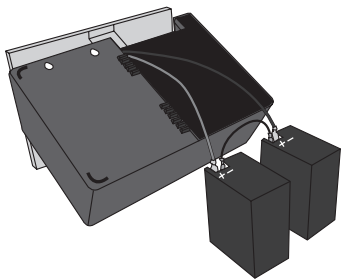

IMPORTANT: You must attach the battery to the energizer and place in the sun with the energizer turned off for three days before use in order to ensure that the battery has a sufficient charge to power your fence. Failure to charge for three days will result in decreased performance.

Fence Energizer Operation

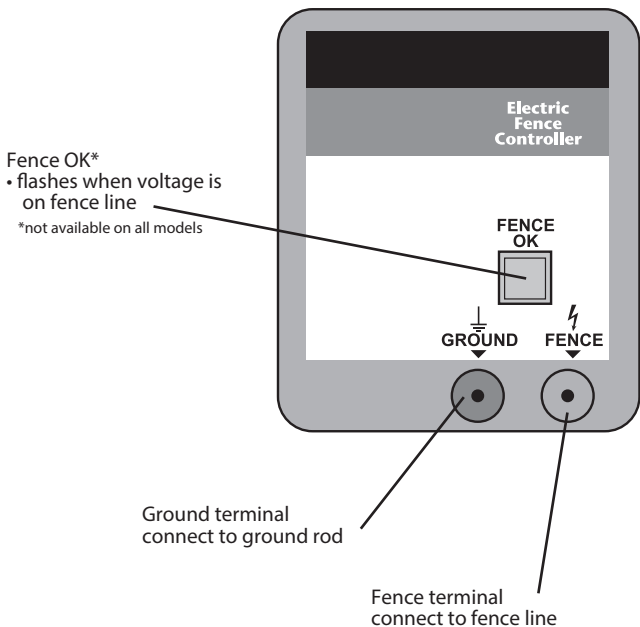

Electric Fencing Basics

Electric fencing is an easy-to-install system for containing animals or keeping them out. A short, safe pulse of electricity creates a psychological barrier that trains animals to avoid the fence. In order for the animal to feel a shock, the voltage produced by the fence energizer must penetrate the animal's hair, hide and hoof.

How Electric Fencing Works

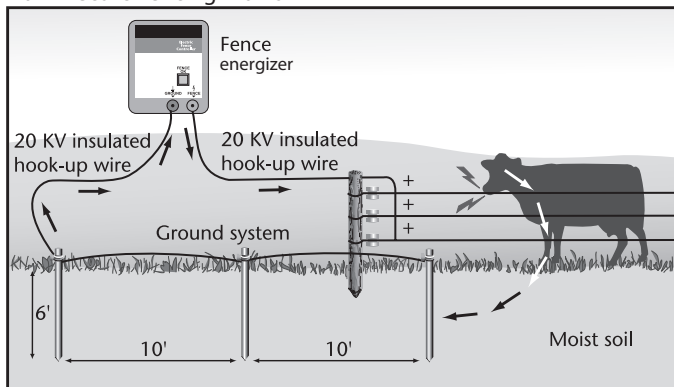

The system works when an animal provides an electrical path by touching the fence wire and the earth simultaneously. The electricity then passes through the animal, into the soil and back to the ground rods, which are connected to the fence energizer. At that point the circuit is complete and the animal instantly receives an electrical shock.

Grounding System

Overview of Grounding System

An effective ground system consists of:

- (3) 6' to 8' ground rods
- (3) ground rod clamps
- 20 KV insulated hook-up wire

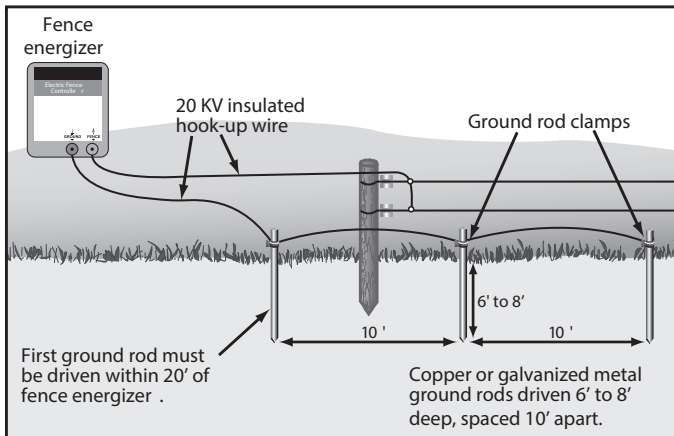

See page 7 for detail on connecting ground system.

- ① Tip : Watering or sprinkling the soil around the ground rods in dry weather will improve ground system performance.

Grounding in Dry or Frozen Ground

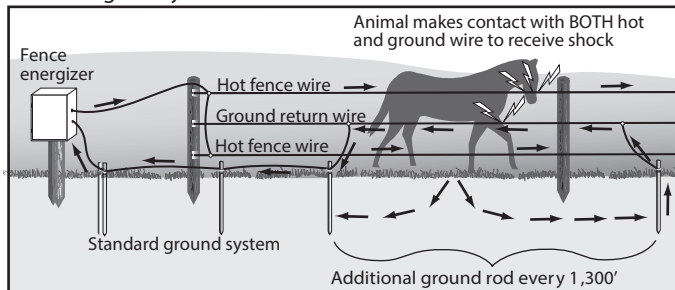

In dry, sandy or frozen soil a typical grounding system is insufficient because electricity cannot flow back to the fence energizer. To compensate, create a ground wire return system with one fence wire carrying electricity back to the fence energizer's ground terminal. Run the ground return wire between hot/electrified wires and drive a 6-foot to 8-foot galvanized steel or copper rod every 1,300 feet. Regardless of the soil conditions, when the animal contacts the hot and ground wires simultaneously, they will feel a shock.

- ① **Tip :** Because the animal must contact the hot and ground return wire **SIMULTANEOUSLY**, we recommend these two wires be spaced within three to four inches of each other.
- ▲ **WARNING:** Do not install ground rods within 50 feet of a utility ground rod, buried telephone line or buried metal water line, as they may pick up stray voltage .

Ground Installation Around Buried Metal

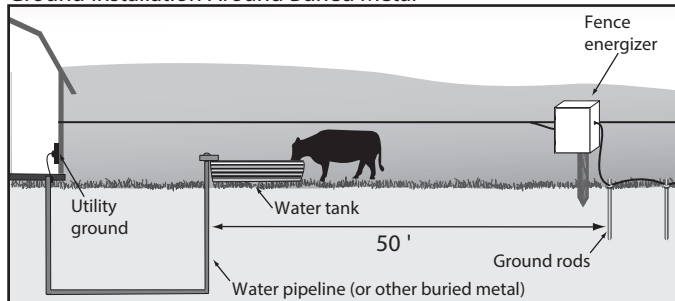

Fence Posts

Fence posts fall into two categories: corner/gate posts, which must withstand tension; and line posts, which simply support the fence line between corner/gate posts. Post material varies and should be selected by fence type.

Electric fencing will usually use fewer posts than conventional barbed or woven-wire fencing, making it less expensive and easier to install. Most posts are spaced 12–20 feet apart depending on terrain and animal being controlled.

Post Spacing on Hilly Terrain

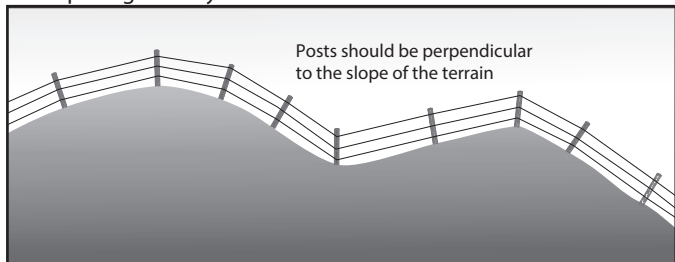

Don't try to space posts evenly. In level terrain, posts can be spaced farther apart; for uneven terrain, a post should be placed at high and low points; and on hillsides, posts should be installed perpendicular to the slope. This keeps the wire at the proper height and prevents it from binding on insulators or clips.

Post Selection Guide

| Post Type: | Wood Post | Plastic Step-in Post | Steel T-post, U-post, Y-post | Fiber-glass T-post/Rod Post | Metal Rod Post |
|-----------------------------|-----------|----------------------|------------------------------|-----------------------------|----------------|
| Used for: | | | | | |
| Corner Posts | X | | X (limited) | | |
| Line Posts | X | X | X | X | X |
| Use With Fence Type: | | | | | |
| Portable | | X | | X | X |
| Semi-Permanent | X | | X | | |
| Equine | X | X | X | X | X |
| Permanent High Tensile | X | | X | | |

Fence Wire

Electric fence wire carries the electrical current from the fence energizer around the perimeter of the fence. Galvanized steel and aluminum wire carry electricity best. Poly wire, tape and rope have strands of conductive wire twisted or woven into the fabric and are ideal for electric fencing because of its ease-of-use, light weight and visibility.

- ① Tip :For equine enthusiasts, we recommend using ElectroBraid® Fence or poly tape systems. They are highly visible, easy to install and safer than steel wire for horses.

The height and spacing of the wires will vary with the animal being contained (or kept out). Always position one electrified wire at the animal's shoulder height; the animal will hit the fence with its nose, making it back up. Proper spacing of the wires for the animal controlled is more important than overall fence height.

Proper Wire Height and Spacing

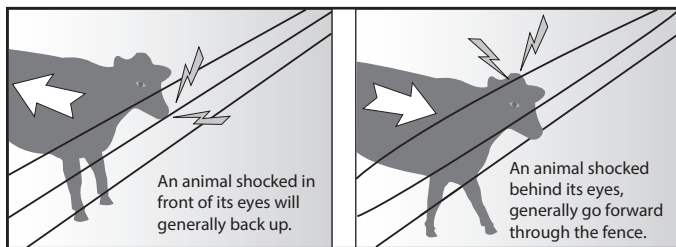

When posts are installed with more than 30 feet between them, use a fence spacer to maintain the proper separation between the wires. When installing fence wire, pull wire taut to maintain the same height and spacing between the posts.

- ① Tip : To prevent energy drain, keep electric fence wire clear of vegetation or objects touching the fence line

To maximize power on the fence, good electrical connections and splices are critical.

Splicing Techniques

Metal Wire



Never use loose or single-wrap splices



Poly Wire



Tie any simple knot such as a square knot. Strip back and cut poly strands leaving two inches of conductive wires exposed. Twist or "pigtail" wires together.

Poly Rope/Braid

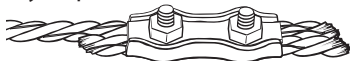

Stagger ends of poly rope in a figure 8 and tightly secure using poly rope splicer.

Poly Tape

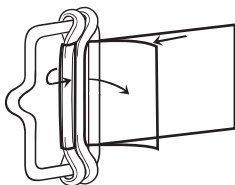
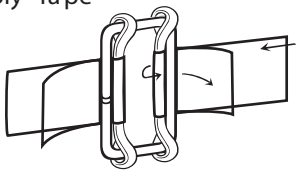

1. Make one-foot loop.
2. Pull poly tape tight and over flange.

Insulators

Insulators isolate the electric fence wire(s) to prevent shorting and electric current leakage, while also keeping the wires properly spaced.

Select your insulators to fit the type of post and fence wire you are using. These insulators are available with various front ends to accommodate your selection of steel or poly wire, poly tape, poly rope or braid.

- ① Tip : To prevent energy drain, routinely check to ensure insulators are clear of cobwebs and that electrified wires do not touch posts.

Installation of Corner/End Post/Gate Insulators

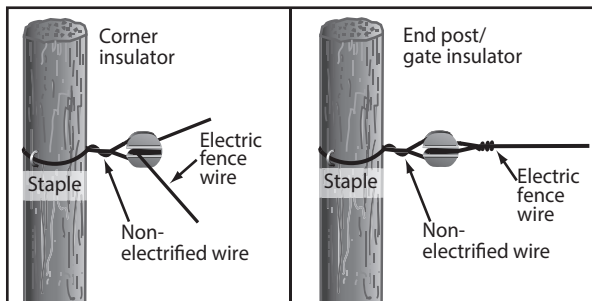

Lightning/Surge Protection

Lightning is one of the main causes of fence energizer failure. If a storm is forecast, disconnect your fence energizer from the fence in advance, and unplug if it is an AC-powered unit. Using a Cut-Off Switch is a simple way to quickly disconnect your fence energizer. If you are in an area with frequent electrical storms, be sure to keep a spare fence energizer for backup.

- ▲ **WARNING:** Never disconnect a fence energizer or approach an electric fence during a lightning storm.
- ▲ **WARNING:** Risk of electric shock! Do not connect an electric fence to any other device such as a cattle or poultry trainer, as lightning striking a fence will be conducted to other devices.

Woodstream® manufactured brands offer several products designed to help minimize damage from lightning:

Lightning Constrictor –

A combination lightning diverter and lightning choke that installs between the fence line and the fence energizer.

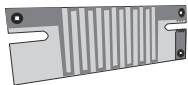

Lightning Arrestor/Lighting Diverter –

Helps protect fence energizer from lightning by diverting strike into the ground.

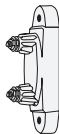

Storm Guard – Helps protect fence energizers rated at 1 joule of energy output or greater from lightning strikes.



Spring Gate Kit – Spring coil helps to dissipate lightning surges.

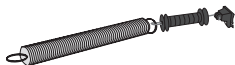

AC Surge Suppressor – Protects AC-powered fence controllers from power surges up to 6,000 volts.



ⓘ Tip : While lightning protection devices can reduce damage by up to 75%, no device provides 100% protection from lightning.

Electric Fence Design

Design Your Fence

Now that you understand how each component works in your fence, sketch your fence layout to get a count of materials you'll need, including number of posts, wires, insulators, gate openings, etc.

Estimate Your Electric Fence Supplies

Use the chart below to get a rough idea of what you'll need for different size enclosures.

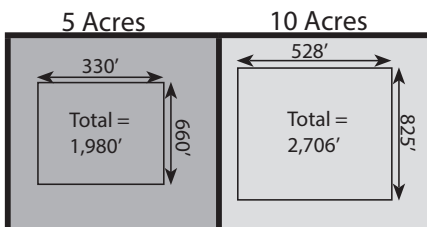

For a SINGLE wire fence with ONE gate opening:

| | | |
|---|----------|----------|
| Posts (15ft spacing) | 133 | 182 |
| Line Post Insulators (25/bag) | 6 bags | 8 bags |
| Corner Post Insulators (10/bag) | 1 bag | 1 bag |
| Poly wire, tape, braid or rope (1,000ft to 1,320ft spool) | 2 spools | 3 spools |
| Gate handle kit | 1 kit | 1 kit |

For a THREE wire fence with ONE gate opening:

| | | |
|---|----------|----------|
| Posts (15ft spacing) | 133 | 182 |
| Line Post Insulators (25/bag) | 16 bags | 22 bags |
| Corner Post Insulators (10/bag) | 2 bag | 2 bag |
| Poly wire, tape, braid or rope (1,000ft to 1,320ft spool) | 5 spools | 7 spools |
| Gate handle kit | 3 kit | 3 kit |

Fence Configurations By Species

- ① Tip: Electric fence systems can be built in any configuration as needed by the end user. Recommended wire spacing to safely contain different species is shown below.



Single Wire
cross fencing

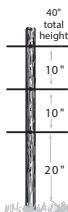

Three Wire
cattle,
horses, and
large animal
fence

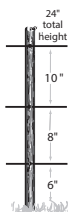

Three Wire
hog
fence

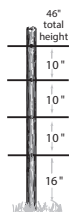

Four Wire
cattle,
horses, and
large animal
boundary
fence

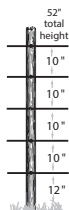

Five Wire
feedlot,
horse,
boundary
fence

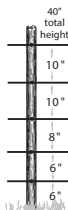

Five Wire
predators,
cattle, deer,
sheep or
boundary
fence



Six Wire
predators,
cattle, deer,
sheep or
boundary
fence

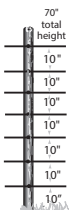

Seven Wire
deer
fence

Gate Openings

Gate openings can be installed a variety of ways. Typically the same fence wire is used across the opening. If a metal gate or spring gate is used, 20 KV insulated hook-up wire should be used to carry the electrical current under the gate opening. NOTE: Refer to page 9 for information on how to make fence line connections.

Standard Gate Installation

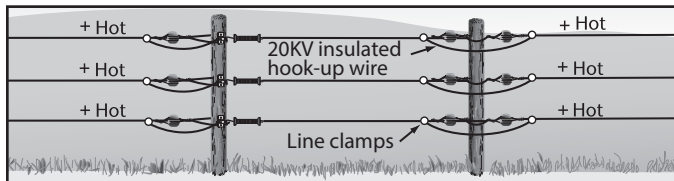

Spring Gate Installation

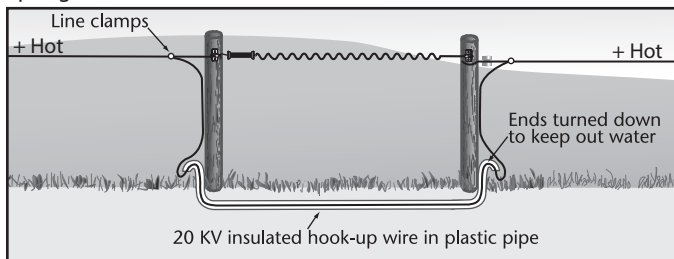

Metal Rigid Gate Installation

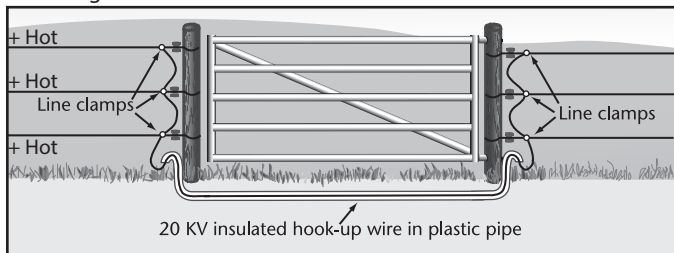

Testing/Troubleshooting

Test fence line voltage regularly with a fence tester at the furthest point on the fence from the fence energizer to ensure voltage is adequate for the animal being controlled.

Adequate voltage reading – fence line OK

Inadequate voltage

Ensure power supply is sufficient (battery/AC/solar power)

Replace/repair battery or AC power to fence energizer

If power OK, disconnect FENCE and GROUND wires from fence energizer, then check voltage output by touching metal part of terminals with tester.

If output is less than 2,000 volts there is a fence energizer fault. Call us for assistance.

If output is normal (over 2,000 volts), reconnect FENCE/GROUND wires

Test ground system – it should read less than 400 volts on ground rod. If over 400 volts, add extra ground rods or make them deeper. Test again/add more ground rods until ground system reads under 400 volts. Remember grounding is affected by soil conditions.

If grounding is OK, test the hook-up wire that connects the fence energizer to the fence line. Disconnect hook-up wire from fence line and test .

Under 1,500 volts
Hook-up wire is leaking to ground. Ensure you are using 20 KV insulated hook-up wire. Replace and recheck.

Over 1,500 volts
Turn off fence energizer and reconnect the hook-up wire to fence line.

Check fence line

Poor hook-up wire connections

Poor jumpers between lines

Poor fence line splices/ conductors

Fence line short or leak to ground

Leaking hook-up wire under gateway

Very heavy vegetation against the fence line

Metal object touching fence line

Bad or incorrect insulator

Fence line touching a fence post

Faulty connections at gate openings

If you cannot resolve the problem please call Woodstream at 855-592-7322.

Regular testing and maintenance of your electric fence system is important to assure performance.

- ① Tip : Testing voltage by touching the fence line with your hand or a weed is not recommended In addition, if you do this wearing rubber-soled shoes you may NOT feel a shock

STEP 1: Test the Fence Line

Check for adequate voltage at the furthest end of the fence line from the fence energizer.

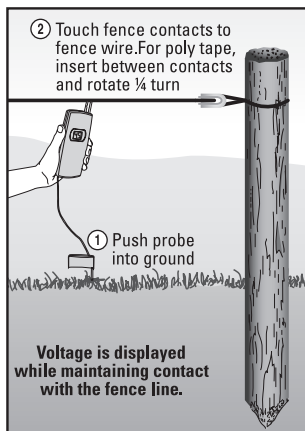

STEP 2: Test Fence Energizer

Remove fence energizer power source (unplug or disconnect from battery) and disconnect fence and ground wires. Reconnect energizer to its power source fence energizer and touch metal bolts of ground and fence terminals with ground and fence prongs of tester.

If output is less than 2,000 volts, there may be a fence energizer problem call us at 855-592-7322.

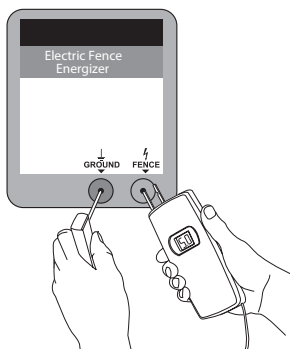

STEP 3: Test Ground System

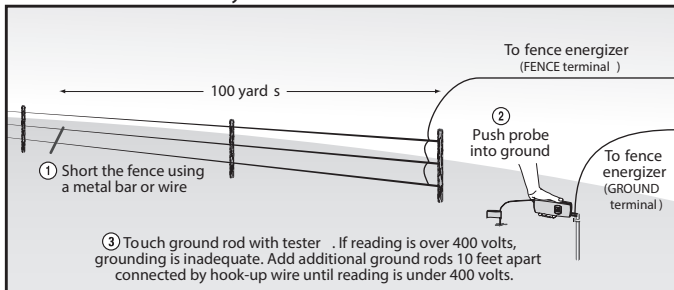

STEP 4: Test Hook-Up Wire

Remove fence energizer power source (unplug or disconnect from battery) and disconnect hook-up wire from fence line. Power fence energizer and then check hook-up wire as shown.

STEP 5: Check Fence Components

Walk your fence line and inspect all components. Insulators should be clean and not cracked. Fence wire should be properly spliced, not touching fence posts and properly connected at all points. Verify weeds, branches or other debris are not touching the fence line.

STEP 6:

If you are still getting inadequate voltage readings, call Woodstream customer service at 855-592-7322

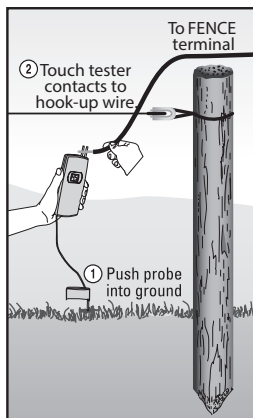

Fence Energizer Warranty

30-DAY FULL WARRANTY

Woodstream guarantees your satisfaction. You can return product with its receipt to the place of purchase within 30 days for a full refund. Proof of purchase is required for a full refund.

LIMITED WARRANTY

Woodstream warrants energizers with a mile rating under 20 miles for 12 months (a full year) from the date of purchase (or date or manufacture if proof of purchase is not provided) against defects in materials and workmanship, and from damage caused by lightning.

Energizers with a mile rating of 20 miles and over have a 24 month warranty (two years) total. Energizers with a mile rating of 50 miles or over have a 36 month warranty (three year) when registered online at the time of purchase.

For any sized energizer, retain your receipt for proof of purchase or register your energizer online at www.zarebasystems.com immediately after purchase. Also, please reference the web page for a list of Certified Repair Centers and instructions on returning fence controllers for service.

TERMS APPLICABLE TO BOTH 30-DAY RETURN POLICY AND THE LIMITED WARRANTY

Neither the 30-day return policy nor the limited warranty applies to any defect caused by improper installation, misuse, product alterations, tampering, neglect, or any similar reason not related to product malfunctions or defects in the materials or workmanship of the product. The 30-Day return policy and the limited warranties are given only to the original purchaser of the product and not to any subsequent owners or to any other user or person when installed and used in accordance with the instructions found in the owner's manual. No person is authorized to grant any warranty additional to or different from this written warranty.

To make a warranty claim, you must contact Woodstream Corp. at 800-800-1819 or zarebasystems.com regarding the defective product or parts during the warranty period or contact one of the Certified Repair Centers listed on zarebasystems.com.

If you have not registered your energizer online immediately after purchase, you may need to provide additional information such as, your name, mailing address, proof of your purchase date, and a description of the problem. If the defect is covered by the limited warranty, Woodstream Corp. or a repair center will repair or replace (at its option) the defective product or parts.

NEITHER THE SELLER NOR THE MANUFACTURER SHALL HAVE ANY LIABILITY FOR ANY INCIDENTAL OR CONSEQUENTIAL DAMAGES RESULTING FROM OR CAUSED BY ANY DEFECT, FAILURE, OR MALFUNCTION OF ANY PRODUCT.

UPON EXPIRATION OF THE 30 DAY RETURN POLICY, NO WARRANTY OR GUARANTEE OTHER THAN THE LIMITED WARRANTY PROVIDED HEREIN IS MADE, EITHER EXPRESS OR IMPLIED. IMPLIED WARRANTIES OF MERCHANTABILITY AND FITNESS FOR A PARTICULAR PURPOSE WHICH MAY ARISE AT LAW ARE HEREBY EXPRESSLY DISCLAIMED UNLESS STATE LAW PRECLUDES DISCLAIMING THEM IN WHICH CASE THEY ARE LIMITED IN DURATION TO THE LIMITED WARRANTY PERIOD.

SOME STATES DO NOT ALLOW LIMITATIONS ON THE DURATION OF IMPLIED WARRANTIES, EXCLUSION, OR LIMITATION OF INCIDENTAL OR CONSEQUENTIAL DAMAGES FOR CERTAIN PURCHASERS, SO THE ABOVE EXCLUSIONS OR LIMITATIONS MAY NOT APPLY TO YOU.

THIS LIMITED WARRANTY GIVES YOU SPECIFIC LEGAL RIGHTS, AND YOU MAY ALSO HAVE OTHER RIGHTS WHICH VARY FROM STATE TO STATE.

SERIAL NUMBER INFORMATION

The serial number for all Woodstream Corp. fence energizers will go to a 12 digit serial number. The format for the 12 digit serial number is as follows:

| | | | | |
|-----------------|-------------|--------------|------------|----------------------|
| EC | XX | XX | XX | XXXX |
| Category | Year | Month | Day | Serial number |

If no sales receipt is provided with the return, we will use the date of manufacture shown in the serial number.

Please contact Woodstream Corp. for all warranty claims or returns:

Woodstream Corp.
69 North Locust Street
Lititz, PA 17543
855-592-7322

LIMITATION OF DAMAGES

The directions for use of this product should be followed carefully. It is impossible to eliminate all risk inherently associated with use of the product. The effectiveness of Woodstream® brands of fence controllers may depend on the effectiveness of connections, interruption of power source, accidental grounding of wires, weather conditions, or the manner of use or application, all of which are beyond the control of Woodstream® or the seller. All such risks shall be assumed by the buyer.

Woodstream® warrants that this product is reasonably fit for the purposes referred to in the directions for use, subject to the inherent risks referred to above. Woodstream® makes no other expressed or implied warranty of fitness or merchantability or any other expressed or implied warranty. IN NO CASE SHALL WOODSTREAM® OR THE SELLER BE LIABLE FOR CONSEQUENTIAL, SPECIAL OR INDIRECT DAMAGES RESULTING FROM THE USE OR HANDLING OF THIS PRODUCT. WOODSTREAM® AND THE SELLER OFFER THIS PRODUCT AND THE BUYER AND USER ACCEPT IT, SUBJECT TO THE FOREGOING CONDITIONS OF SALE AND WARRANTY WHICH MAY BE VARIED ONLY BY AGREEMENT IN WRITING SIGNED BY AN OFFICER OF WOODSTREAM®.

Some states, however, do not allow the exclusion or limitation of incidental or consequential damages, so the above limitation or exclusion may not apply to you. This limited warranty gives you specific legal rights, and you may also have other rights which vary from state to state.



Woodstream Corp.
69 N. Locust Street
Lititz, PA 17543

Contact us:
855-592-7322



We are proud
to support FFA



Part # EC-OWNERSMANUAL REV3