

Hayward

ECOMMAND 4

Automation



Installation Manual

for models

HPC-4

HPC-4-ACT

HPC-4-RC

HPC-4-ACT-RC

HAYWARD[®] Pool Products
One source. Every pool.

www.haywardnet.com

IMPORTANT SAFETY INSTRUCTIONS

When using this electrical equipment, basic safety precautions should always be followed, including the following:



- **READ AND FOLLOW ALL INSTRUCTIONS**
-  **WARNING: Disconnect all AC power during installation.**
-  **WARNING: Water in excess of 100 degrees Fahrenheit may be hazardous to your health.**
-  **WARNING: To reduce the risk of injury, do not permit children to use this product unless they are closely supervised at all times.**
- A green colored terminal marked “Earth Ground” is located inside the wiring compartment. To reduce the risk of electric shock, this terminal must be connected to the grounding means provided in the electric supply service panel with a continuous copper wire equivalent in size to the circuit conductors supplying the equipment.
- A wire connector is provided on this unit to connect a minimum 8 AWG (8.4 mm²) solid copper conductor between this unit and any metal equipment, metal enclosures of electrical equipment, metal water pipe, or conduit within 5 feet (1.5m) of the unit, to connect the equipment assembly or spa to a circuit protected by a ground-fault circuit-interrupter.
- One bonding lug for US models (two for Canadian models) is provided on the external surface. To reduce the risk of electric shock, connect the local common bonding grid in the area of the swimming pool, spa, or hot tub to these terminals with an insulated or bare copper conductor not smaller than 8 AWG US / 6 AWG Canada.
- All field installed metal components such as rails, ladders, drains, or other similar hardware within 3 meters of the pool, spa or hot tub shall be bonded to the equipment grounding bus with copper conductors not smaller than 8 AWG US / 6 AWG Canada.
- **SAVE THESE INSTRUCTIONS**

Table of Contents

Introduction	Before You Begin.....	1
	Installation Steps.....	1
1. Mounting Equipment	ECOMMAND 4 Control Center.....	2
	Temperature Sensors.....	2
	Optional Wireless Remote Control.....	2
	Optional Base Station.....	3
	Optional Valve Actuators.....	3
2. Plumbing	Plumbing Configuration.....	4
3. Electrical Wiring	Main Service.....	5
	Grounding and Bonding.....	5
	Circuit Breaker Installation and Wiring.....	6
	General Purpose Outlet.....	6
	ECOMMAND 4 Control Power.....	6
	High Voltage Pool Equipment.....	7
	Low Voltage Wiring.....	8
4. Configuration	Configuration Menu.....	14
5. System Startup and Checkout	Before Startup.....	24
	Heater Checkout.....	24
	Service Mode.....	25
6. Warranty	ECOMMAND 4 Limited Warranty.....	28

Introduction

Before You Begin

What's Included

Before attempting to install the ECOMMANT 4 system, check that the following components have been included in the package:

ECOMMAND 4 Electronics Unit

- (3) Temperature sensors with 15 ft. (5m) cable, hose clamp
- (2) Goldline GVA-24 actuators (*HPC-4-ACT, HPC-4-ACT-RC only*)
- (1) Goldline AQL2-BASE-RF/AQL2-SS-RF remote control (*HPC-4-RC, HPC-4-ACT-RC only*)

What's NOT Included

Some of the additional items that you may need to complete an installation include:

Circuit breakers

None are included with control—see page 6 and inside of door for suitable breakers

Wire

- 4-conductor cable (electronics unit to external chlorination)
- Wire/conduit for 100A service from main panel to ECOMMANT 4
- Wire/conduit for filter pump and other high voltage loads
- Wire for bonding

Miscellaneous

- Mounting hardware (screws, etc.) for mounting ECOMMANT 4
- Valves (use standard Hayward, Pentair/Compool, or Jandy valves)
- Additional valve actuators

Accessory Products - Order Separately

AQL2-SS-RF	Wireless Spa Side Remote Control (<i>Included with HPC-4-RC, HPC-4-ACT-RC</i>)
AQL2-BASE-RF	Base Station required if using AQL2-SS-RF (<i>Included with HPC-4-RC, HPC-4-ACT-RC</i>)
AQL-DIM	Light Dimmer Relay
GVA-24	Valve Actuator
V&A-xx	Valve & Actuator (xx=1P (1.5" pos. seal), -2P (2" pos. seal), (<i>Included with HPC-4-ACT, HPC-4-ACT-RC</i>))

Installation Steps

Details on each installation step are presented on the following pages:

1. Mounting the equipment (page 2)
 - ECOMMAND 4 main unit
 - Temperature sensors
 - Optional Remote Control
 - Optional Base Station
 - Valve actuators (if applicable)
 - High Voltage pool equipment
 - Low voltage wiring (temperature sensors, heater, etc.)
2. Plumbing (page 4)
 - General Pool Equipment
3. Electrical Wiring (page 6)
 - Main service
 - Grounding and bonding
 - Circuit breakers
 - ECOMMAND 4 control power
4. ECOMMANT 4 configuration (page 14)
5. System Startup and checkout (page 24)

1. Mounting the Equipment

ECOMMAND 4 Control Center

The ECOMMAND 4 is contained in a raintight enclosure that is suitable for outdoor mounting. The control must be mounted a minimum of 5 ft. (2 meters) horizontal distance from the pool/spa (or more, if local codes require). The Control Center is designed to mount vertically on a flat surface with the knock-outs facing downward. Because the enclosure also acts as a heat sink (disperses heat from inside the box), it is important not to block the four sides of the control. Do not mount the ECOMMAND 4 inside a panel or tightly enclosed area.

When selecting a location, note that the standard cables supplied with the temperature sensors, and valve actuators (if applicable) are all 15 ft. (5m) long.

Temperature Sensors

Three sensors are included with the ECOMMAND 4. A water sensor and an air sensor must be installed at all times for proper operation. A solar sensor is required if the solar function is enabled.

Water Sensor

This sensor is used to measure the pool/spa temperature and is installed in the filtration plumbing after the filter but before either the solar or conventionally fueled heaters—refer to the plumbing overview diagram.

1. Drill a 3/8" (10mm) diameter hole in the PVC piping and remove all chips and burrs.
2. Insert sensor until O-ring collar sits flush on the hole.
3. Position hose clamp over the sensor and gently tighten until O-ring makes an adequate seal. Do not overtighten.
4. For maximum temperature accuracy, cover the sensor and 3" (6cm) of pipe on either side with insulation and white paint.

Air Sensor

Mount the air sensor outdoors.  **IMPORTANT: Mount the air sensor out of direct sunlight.**

Solar Sensor

For solar applications, mount the sensor near the solar collector array so that it is exposed to the same sunlight as the collectors. Use additional cable (20 AWG) if necessary.

Optional AQL2-SS-RF Remote Control (included with HPC-4-RC, HPC-4-ACT-RC)

The ECOMMAND 4 is compatible with AQL2-SS-RF wireless remote control only. The AQL2-SS-RF is a waterproof portable remote control that is designed to be used in and around the pool/spa area. The AQL2-SS-RF floats and can be left in the water for easy access. A single AQL2-BASE-RF Base Station must be installed on the ECOMMAND 4 in order to use this remote control. The maximum distance between the wireless remote and the base station on the ECOMMAND 4 main control unit is 400 feet (120m) line of sight or 200 feet (60m) through walls, etc. If in doubt about the distance, test operation before installing the remote. All wireless models require the user to run the "Teach Wireless" routine in the Settings Menu. This information can be found in the ECOMMAND 4 Operation Manual.

Optional Base Station *(included with HPC-4-RC, HPC-4-ACT-RC)*

The AQL2-BASE-RF optional base station must be installed if the AQL2-SS-RF is used. To install the base station, remove the knockout on the upper left side of the ECOMMAND 4 main control unit, insert the base station, and then tighten the nut from the inside. Also refer to the Base Station manual and the diagram on page 13.

Optional Valve Actuators *(included with HPC-4-ACT, HPC-4-ACT-RC)*

For optional actuators used with the ECOMMAND 4—note that the internal cams in the actuator may also have to be adjusted depending on the way the actuator is mounted on the valve and the desired valve action.

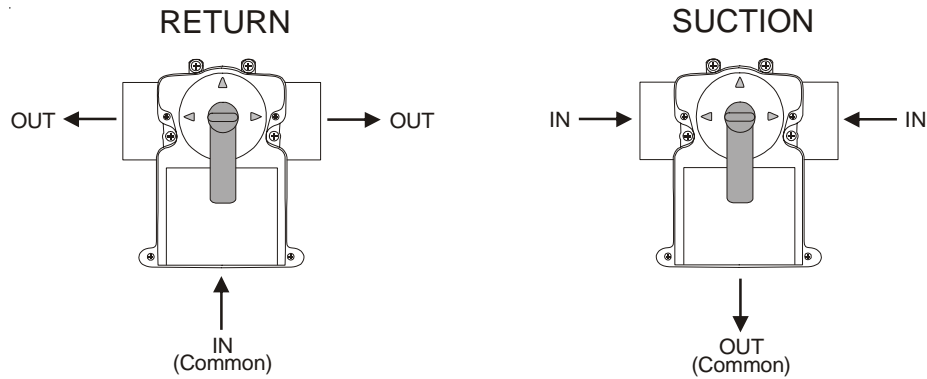

2. Plumbing

Pool/Spa system configuration

These systems use a single filter pump and filter. Pool or spa operation is controlled by two 3-way valves (suction and return). Refer to the diagram below.

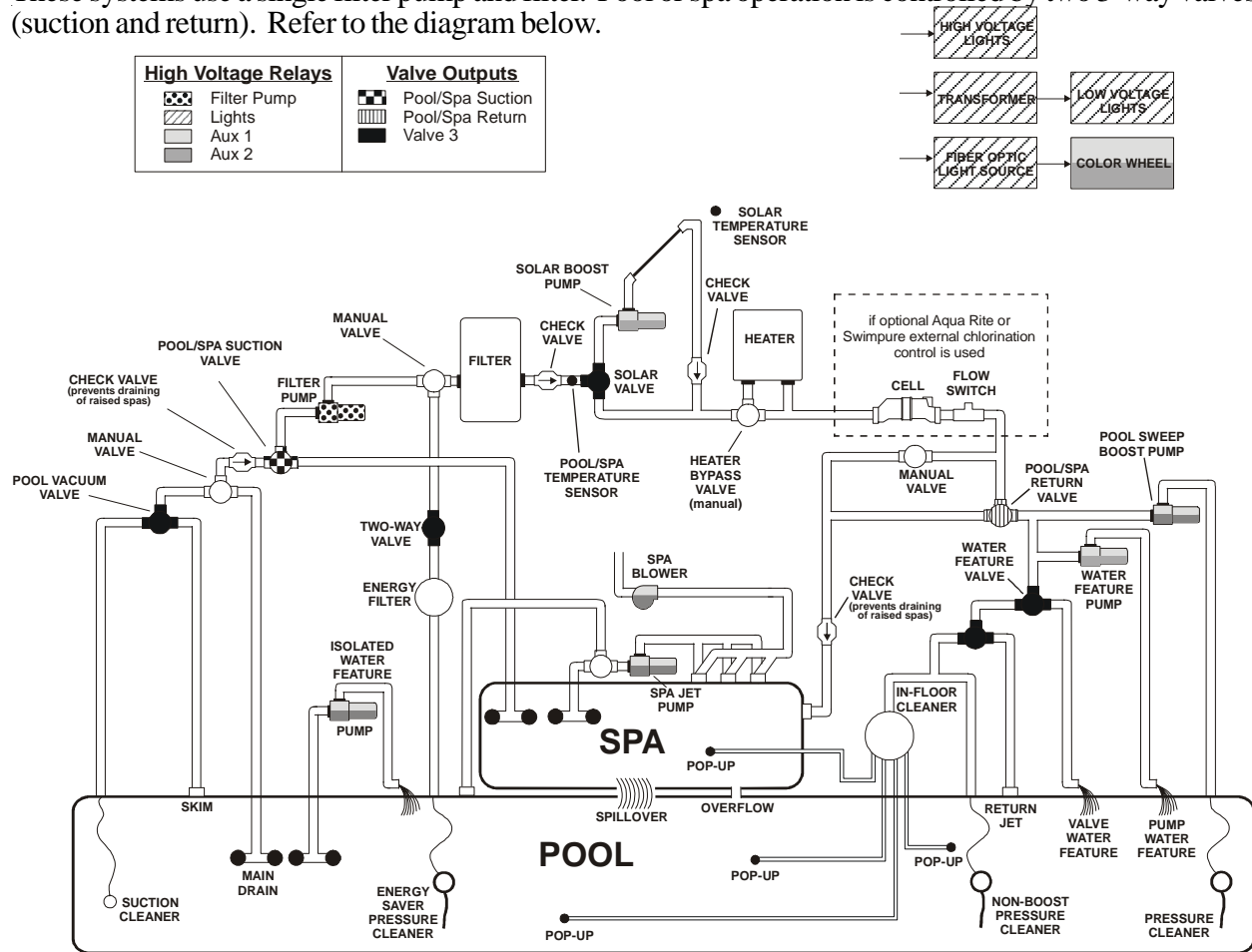

Some important notes regarding the ECOMMANT 4 control of Standard Pool/Spa systems:

In Pool/Spa Config., select:

Pool/Spa Setup
Pool and Spa

1. The ECOMMANT 4 can be programmed to accommodate spa spillover, if desired.
2. A conventional heater (gas or heat pump) and solar can be used to heat both the pool and the spa.
3. If the chlorinator cell is plumbed prior to the pool/spa return valve, then both the pool and the spa can be chlorinated (only when optional external chlorination is used).
4. The water sensor should be installed prior to any heater or solar and will display either the pool or the spa temperature, depending on the current operation of the pool. The temperature will only be displayed when the filter pump is running.
5. If any water feature or pressure side cleaner boost pumps are used, be sure to enable the “interlock” feature (see “Configuration Menu” for details) to ensure that the pumps operate only when the filter pump is on and the system is in the “pool only” operating mode.
6. The plumbing diagram above is intended to be used as a general guideline and is not a complete plumbing schematic for the pool.
7. The air sensor must be installed if the freeze protection feature is enabled for the filter, valves or aux outputs or if the chlorinator is enabled.

3. Electrical Wiring

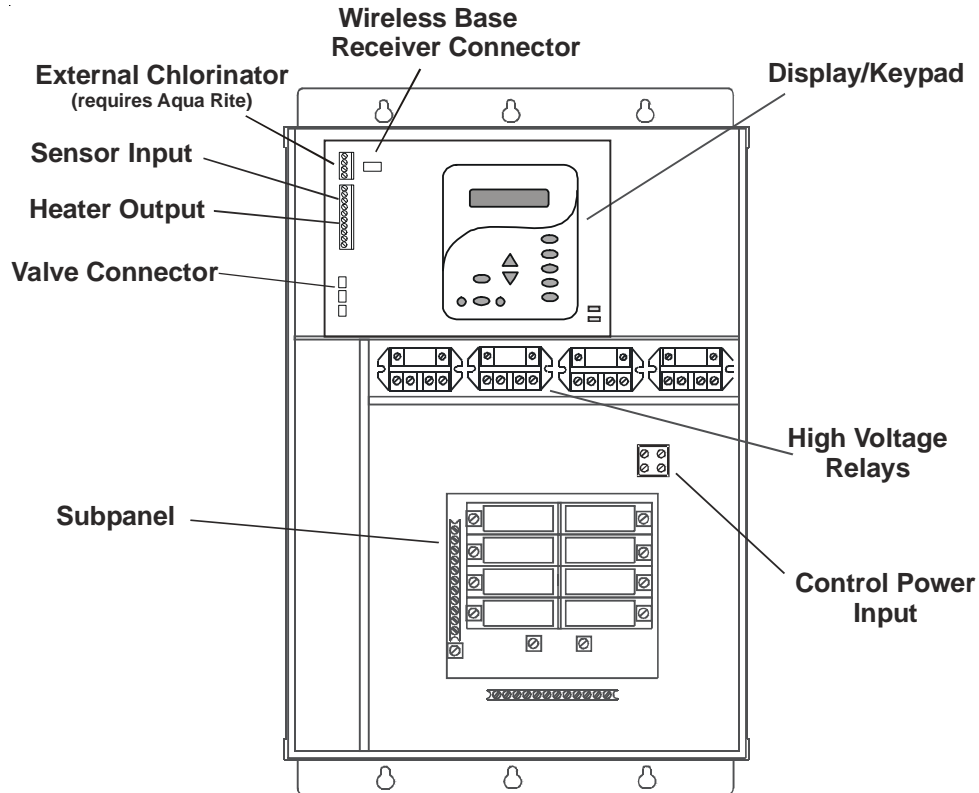

The ECOMMANT 4 Control Center requires both high and low voltage connections. Low voltage connections will be made to actuators, sensors, remote keypad, etc. High voltage connections will be made to pumps, lights, etc., as well as providing direct input power to the Control Center. Always:

- Ensure that Power is disconnected prior to doing any wiring
- Follow all local and NEC (CEC if applicable) codes
- Use copper conductors only

Main Service (Power to the Circuit Breaker Subpanel)

The ECOMMANT 4 circuit breaker subpanel is rated for 100A service. Run properly rated conductors (L1, L2, N, and ground) from the primary house electrical panel to the main power connections on the ECOMMANT 4 circuit breaker base. The connection at the main house panel should be to a 240VAC circuit breaker rated at 100A maximum.

Grounding and Bonding

Connect a ground wire from the primary electrical panel to the ECOMMANT 4 ground bus bar. Also ground each piece of high voltage (120 or 240VAC) equipment that is connected to the ECOMMANT 4 control relays or circuit breakers. The ECOMMANT 4 should also be connected to the pool bonding system by an 8AWG (6AWG for Canada) wire. A lug for bonding (2 for Canada) is provided on the outside/bottom of the ECOMMANT 4 enclosure.

Circuit Breaker Installation and Wiring

Circuit breakers are to be supplied by the installer. Refer to the circuit breaker chart below for a list of suitable circuit breakers that can be used. Follow the code and the circuit breaker manufacturer's rating requirements regarding the size and temperature rating for wiring. Note that some pool equipment may be required to be connected to ground fault circuit breakers—check local and NEC (CEC) codes.

SUITABLE LISTED BREAKERS							Tightening Torque
Manufacturer	Single	Double	Twin	Quad	GFCB	Filler Plates	
Siemens	QP	QP	QT	QT	QPF	QF3	25lb-in
Murray	MP-T	MP-T	MH-T	MH-T	MP-GT	LX100FP	25lb-in

General Purpose Outlet

If desired, a duplex receptacle with weatherproof cover (supplied by installer) may be installed in the knockouts on the lower right side of the ECOMMANT 4 enclosure. Per code, the receptacle should be a GFCI type. Alternatively, connect a standard receptacle to a GFCB.

ECOMMAND 4 Control Power

The ECOMMANT 4 requires 120VAC, 2A power to operate the control logic circuits. This power should be connected to a circuit breaker rated at 125% of the intended load or the next higher size available.

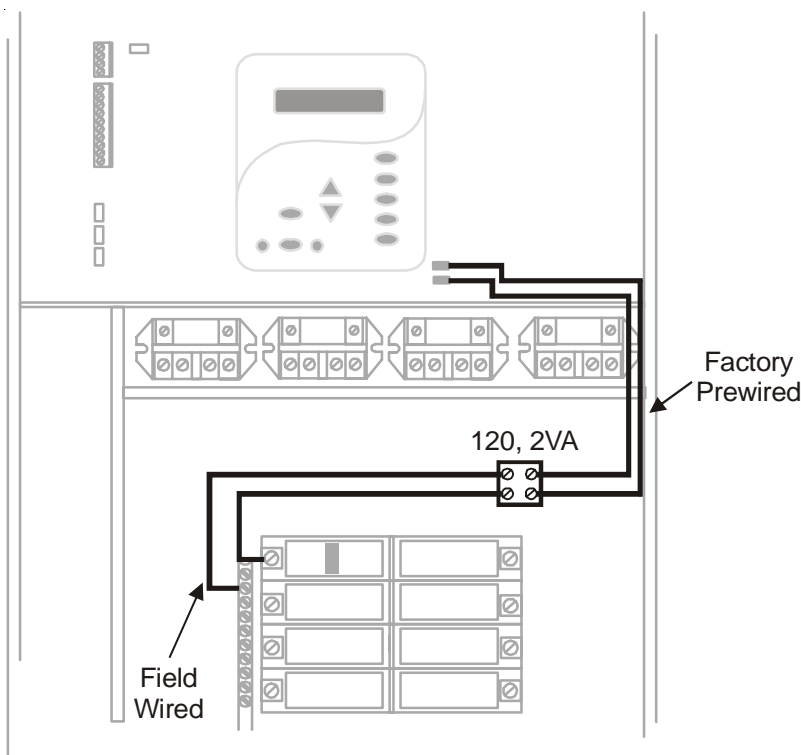

High Voltage (120/240V) Pool Equipment

All ECOMMAND 4 relays are double pole (they make/break both “legs” of 240V circuits) and are rated at 3HP/30A at 240V (1½HP/30A at 120V). Refer to the diagram below for typical relay wiring.

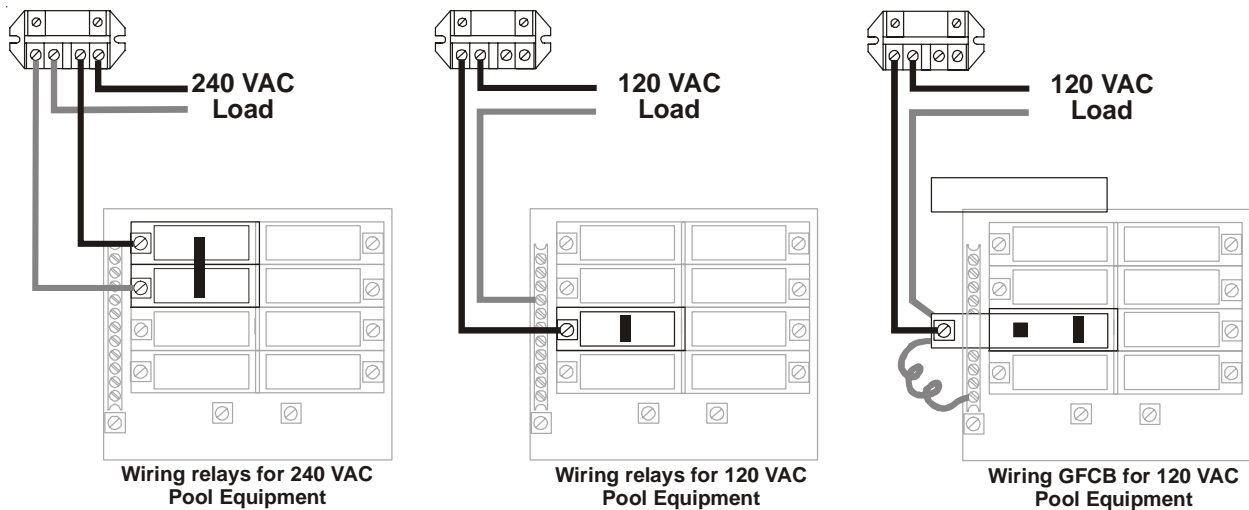

⚠ WARNING: Do not use the ECOMMAND 4 to control an automatic pool cover. Swimmers may become entrapped underneath the cover.

Two speed filter pump: Requires 2 relays (FILTER plus one of the AUX relays) for proper operation of both speeds. **⚠ IMPORTANT:** Be sure to follow the wiring diagram below AND to configure the control logic according to the instructions on page 14.

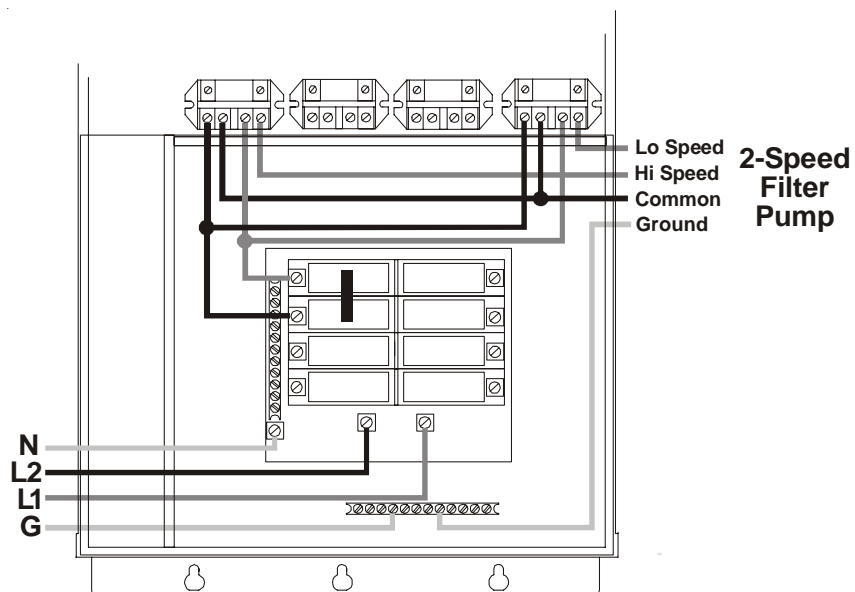

Lights: A ground fault circuit breaker must be used to supply power for high voltage pool/spa lighting. Low voltage lights will require an external transformer. For lighting systems that have both a light source and color wheel, connect the light source to the “Lights” relay and then connect the color wheel to one of the AUX outputs.

Hayward Variable Speed Filter Pump: Proper installation of the Hayward TriStar Variable Speed Control (VSC) includes high voltage input wiring, communication wiring, and menu configuration/settings. Refer to the following diagram for proper input wiring to the VSC. Wiring from the 220V breaker must connect through the ECOMMANT 4's Filter relay. The Filter relay is used to supply input power to the VSC pump control. The relay will be on when the filter pump output is on. When the filter pump output is off, the relay will be off. Note that when the filter pump relay is off (power off to the VSC), the ECOMMANT 4 will not display errors or diagnostics for the pump. The filter pump relay must be on for diagnostic function.

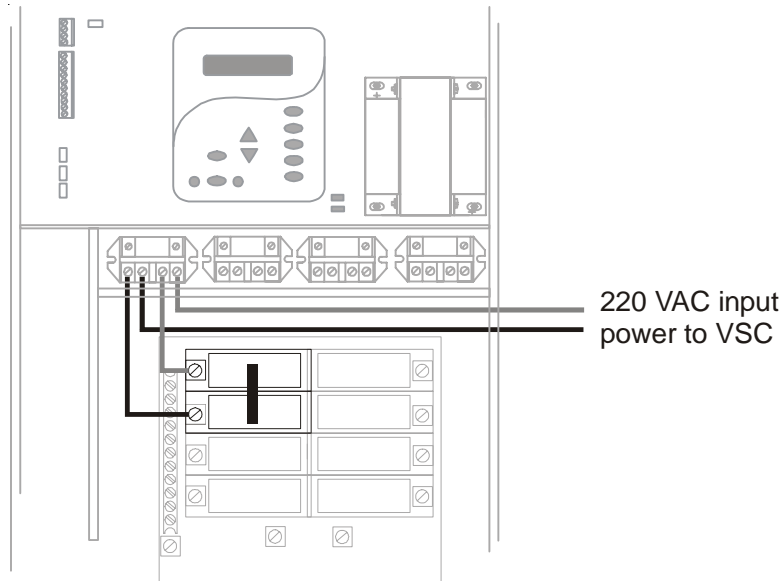

Low Voltage Wiring

Valve Actuators

The ECOMMANT 4 can control up to three automatic valve actuators. Two of the valve outputs are dedicated to the pool/spa suction (Valve2) and return (Valve1) valves. Valve3 is for general purpose use (solar, water feature, in-floor cleaner, etc.).

For installations with solar heating, Goldline offers the AQ-SOL-KIT-xx solar kit that contains a valve, actuator, and extra temperature sensor. The “xx” indicates the valve type from the 3 choices below:

- 1P 1.5” Positive Seal
- 2P 2” Positive Seal

The ECOMMANT 4 is compatible with standard valve actuators manufactured by Hayward, Pentair/Compool, and Jandy. See diagram on page 5 for the location of valve connectors.

Heater Control

The ECOMMANT 4 provides a set of low voltage dry contacts that can be connected to most gas heaters or heat pumps with 24V control circuits. Refer to the diagram on the following page for a generic connection. The manuals supplied with most heaters also include specific wiring instructions for connecting the heater to an external control (usually identified as “2-wire” remote control). For millivolt or line voltage heaters, contact Goldline Tech support, 908-355-7995. Refer to the diagrams and the information on the following pages for more details on the connection to several popular heaters.

Generic Heaters

1. Wire heater to 120/240V power source per the instructions in the heater manual. The ECOMMANT 4 does NOT control the power going to the heater.
2. Wire the ECOMMANT 4 dry contact heater output per the diagram below. Many internal parts of the heater can get very hot--see the heater manufacturer's recommendations on the minimum temperature rating for wires. If no guidance is given, use 105°C rated wire.
3. Set any ON/OFF switch on the heater to ON.
4. Set the thermostat(s) on the heater to the maximum (hottest) setting.

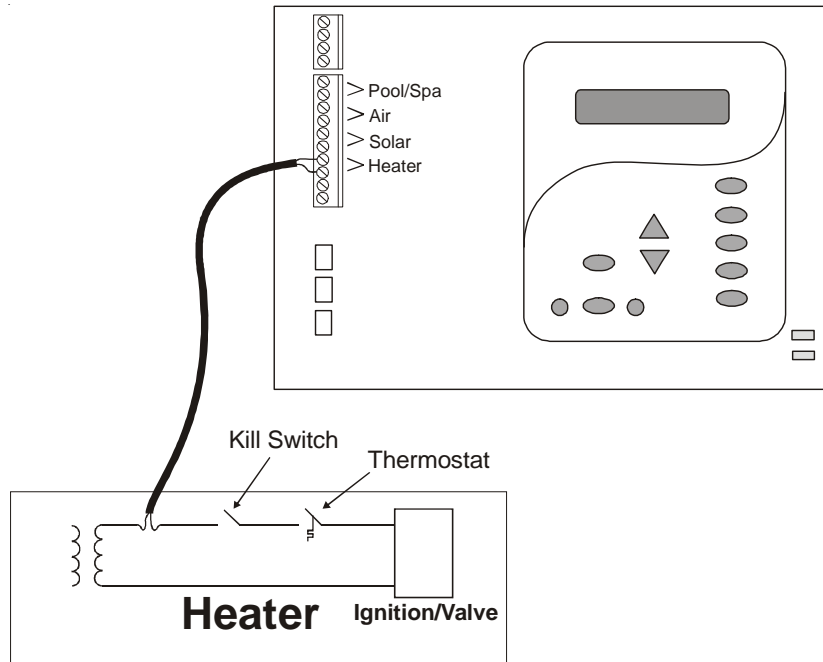

Laars Heaters

1. Turn power off to heater.
2. Remove factory jumper from terminal block.
3. Wire ECOMMANT 4 to the heater as shown.
4. Ensure toggle switch is in the ON position.
5. Set heater thermostats to maximum position.

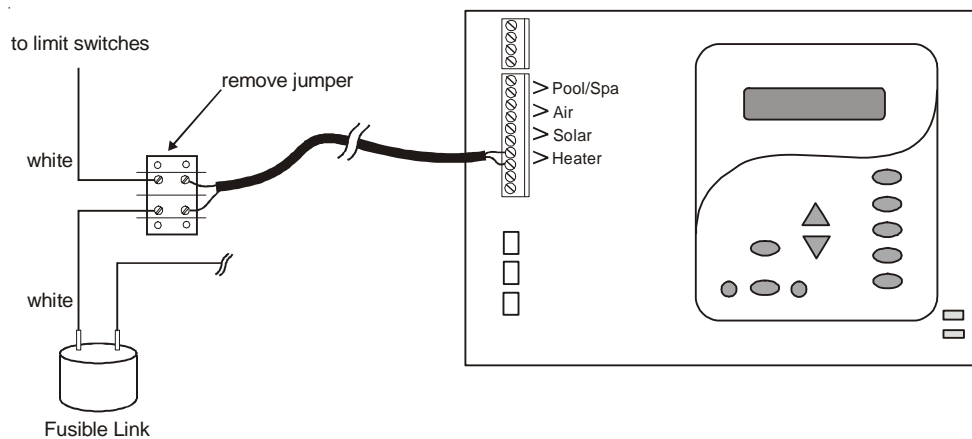

Hayward Heaters

Refer to the instructions in the heater manual for “2-wire Remote Thermostat” operation under “Remote Control Connections” and the diagram below:

1. Turn off power to heater.
2. Wire ECOMMAND 4 to terminals 1 & 2 (see diagram).
3. Leave jumper attached to terminals 4 & 5.
4. Move “BYPASS” dipswitch on heater circuit board to “ON” position (up).
5. Turn heater power back on.
6. Switch heater to either “Pool” or “Spa” (it doesn’t make any difference which is selected, the ECOMMAND 4 will take control).
7. Heater display should be “bO” (for “bypass On”).
8. Heater will fire whenever ECOMMAND 4 requests (when ECOMMAND 4 “Heater” LED is illuminated).

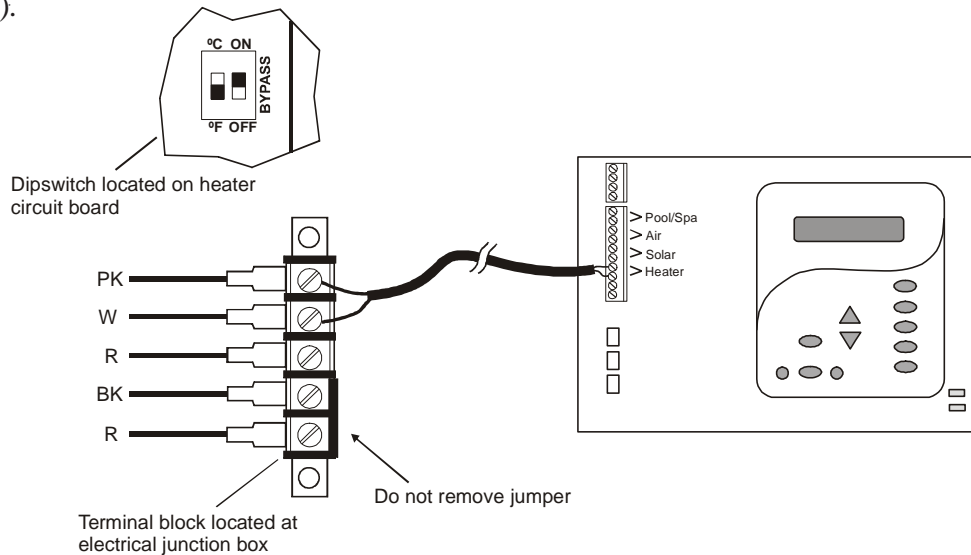

Pentair/Purex/MiniMax

1. Turn power off to heater.
2. Remove factory installed jumper from the “Ext Switch” connector.
3. Wire the ECOMMAND 4 to the “Ext Switch” connector as shown below.
4. The wires to the ECOMMAND 4 must be separated from any line voltage wires. Failure to follow these instructions may cause erratic operation of the heater.
5. Set the Power (Thermostat Select) switch to either “Pool” or “Spa”.
6. Set the “Pool” and “Spa” thermostats to their maximum settings.

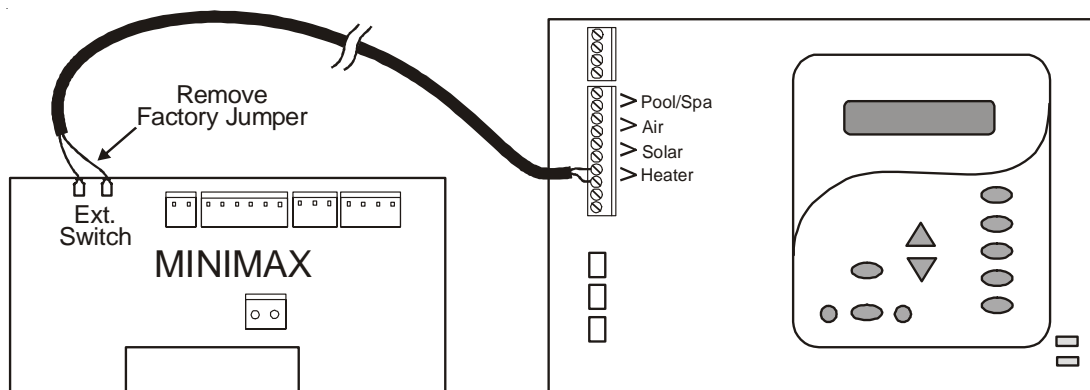

Raypak RP2100 Pool/Spa Heater

1. Turn power off to heater.
2. Push the mode button to “spa” mode.
3. Set the temperature to the maximum.
4. Push the mode button to “OFF”.
5. Lastly, plug the prewired connector in the P7 position on the board.

⚠ IMPORTANT: The heater will display “OFF” when it is being remotely controlled by the ECOMM4. Some homeowners see the “OFF” display and, thinking this is a mistake, change the mode to “POOL” or “SPA” which then disables the remote control by the ECOMM4. To prevent this: Remove the heater touch pad connector (P5) which will disable the touchpad.

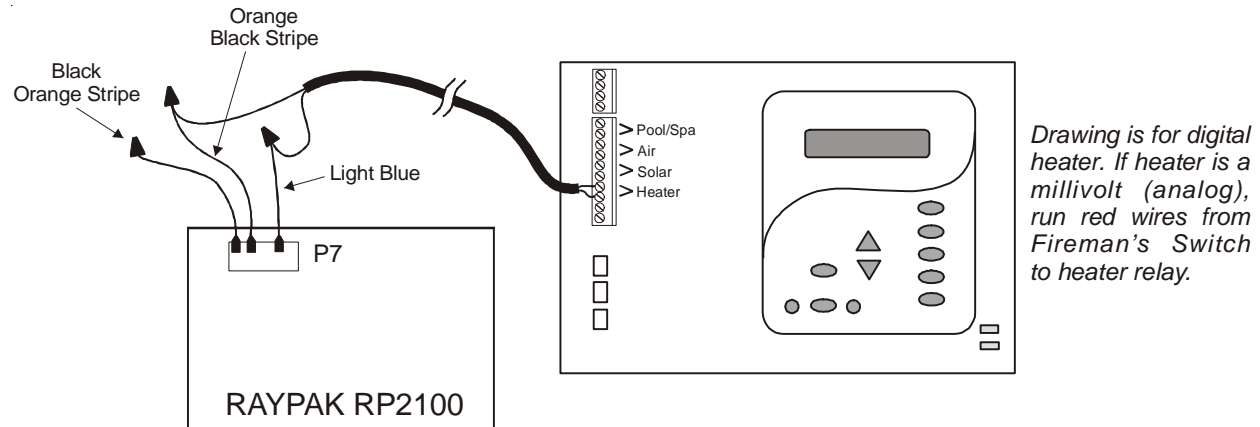

STA-RITE Heater

1. Turn power off to heater.
2. Remove upper jacket and open the control box.
3. Remove the jumper for the “fireman’s switch.”
4. Wire to the ECOMM4 using wire rated for 105°C minimum.

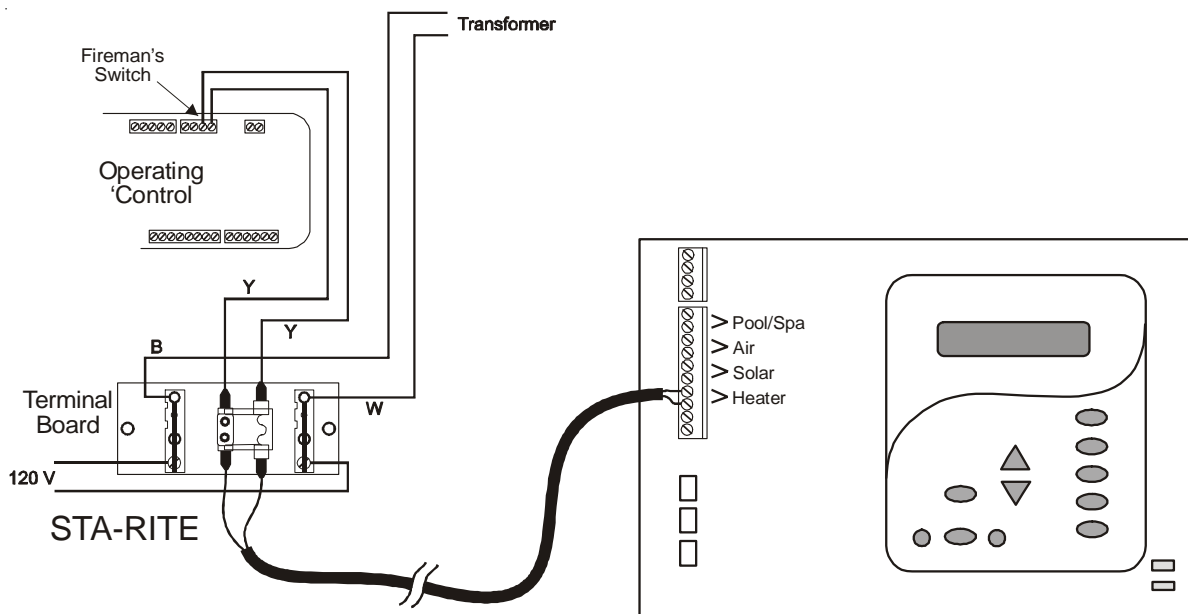

Hayward Variable Speed Filter Pump: Refer to the diagram below for proper low voltage communication wiring between the ECOMMANT 4 and the Hayward Tristar Variable Speed Control (VSC).

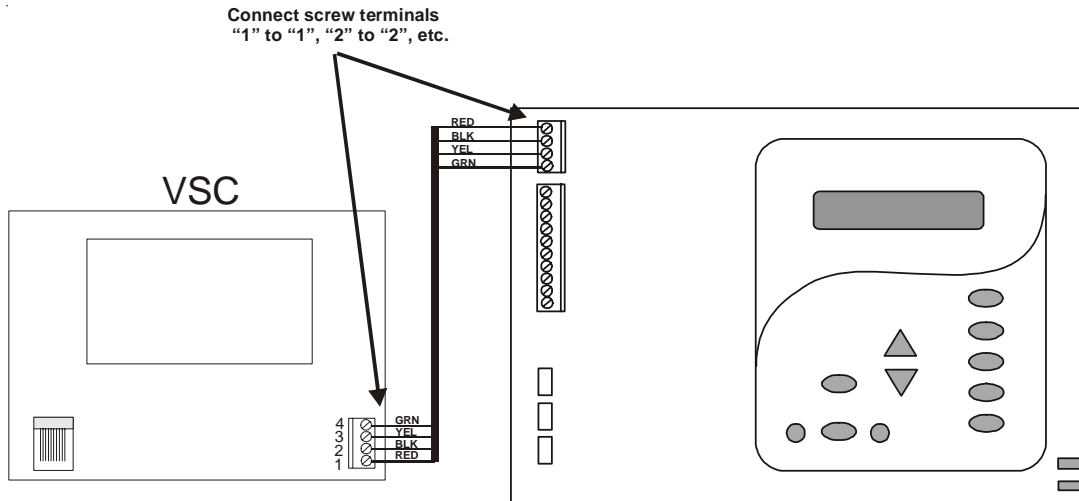

Use four conductor cable (typically phone cable) for communications connection between the VSC and the ECOMMANT 4. The maximum wiring distance is 500 feet (160 meters). Note that the terminals on both the VSC interface board and the ECOMMANT 4 main board are numbered. The terminal connections should be matched between both terminal blocks (connect 1 to 1, 2 to 2, etc.). The communications cable should be routed through the knockout hole on the left side of the VSC enclosure, and a watertight fitting should be used to keep water and debris out of the opening. The communications cable should also be routed away from the ECOMMANT 4 and VSC power connections if possible.

VSC Pump Address Setting

The VSC address must be set to 001 when using the VSC with the ECOMMANT 4. Refer to the TriStar Pump Owner's Manual (IS3220VSC) and Hayward document IS3220VSCAQLL for specific instructions on setting the pump address.

Temperature Sensors

The ECOMMANT 4 utilizes 10K ohm thermistor type sensors. Three sensors (water temperature, air temperature and solar temperature) are included. If the ECOMMANT 4 is being used to control a solar heating system, the solar sensor is required. The sensors are provided with a 15 ft. cable. If a longer cable is required, contact the Goldline service dept. for information on suitable cable types and splices. See page 6 and the diagram below for installation information.

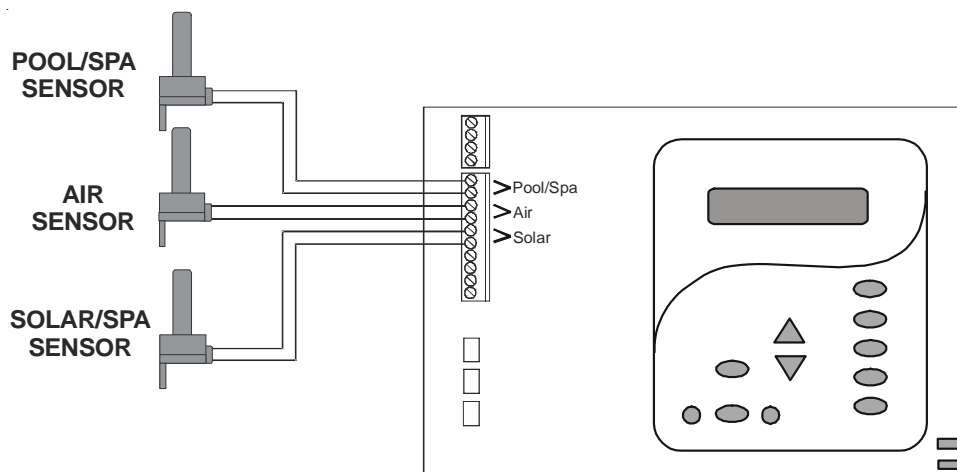

Base Station

Plug in the pigtail connector from the wireless base station into the "wireless" connector on the main PCB in the ECOMM4 control unit.

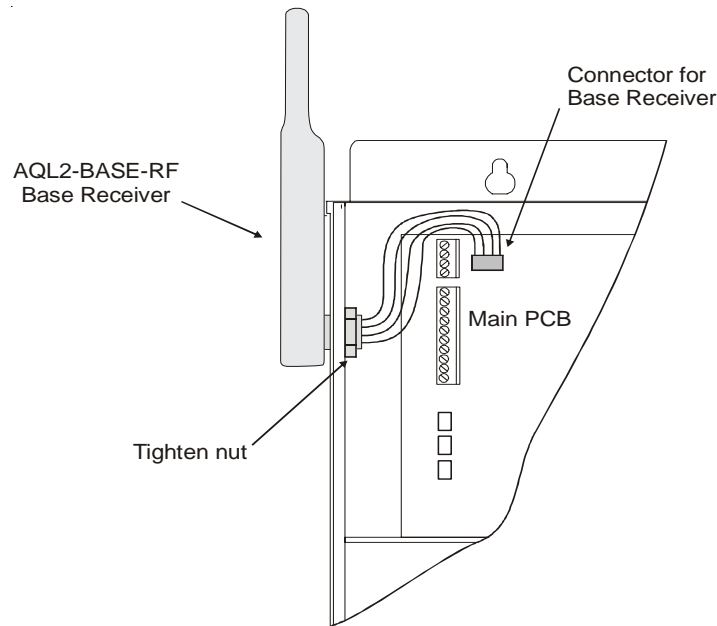

Goldline Aqua Rite or Hayward Swimpure Chlorinator

The ECOMM4 can control one or more Goldline Aqua Rite or Hayward Swimpure chlorinators when additional sanitizing capacity is required. A 4 wire connection is used to communicate to the Aqua Rite/Swimpure and can be wired up to 500' apart. Any outdoor rated 4 conductor cable can be used. Refer to the wiring diagrams below for proper wiring connection to the Aqua Rite/Swimpure. **NOTE:** There must be only 1 "primary" unit. All other Aqua Rite/Swimpure units must be configured as "secondary".

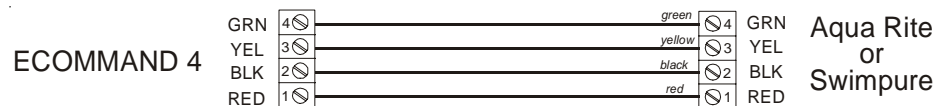
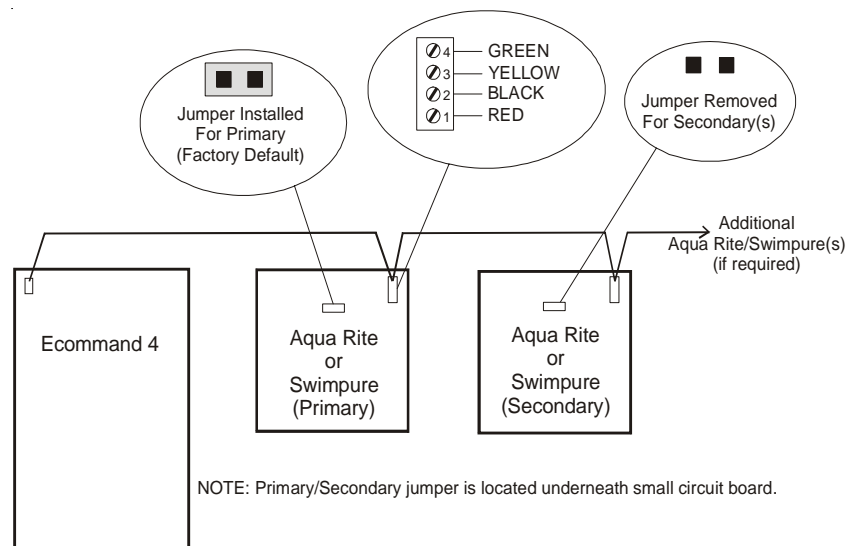



4. Configuration Setup

After plumbing and wiring are complete, the ECOMMANT 4 MUST BE CONFIGURED before attempting to operate. Configuration information is entered at the keypad and “tells” the ECOMMANT 4 what equipment is connected and how each should be controlled.

Accessing the Configuration Menus

Configuring the ECOMMANT 4 requires that you navigate through the Configuration Menu and input various information. For more detailed information about using the ECOMMANT 4 menu system, refer to the Operation Manual.







To access the Configuration Menu

Configuration Menu-Locked	 Press repeatedly until “Configuration Menu” is displayed
	 Press BOTH buttons SIMULTANEOUSLY for 5 seconds to unlock
Configuration Menu-Unlocked	 Move to configuration menu items

NOTE: The configuration menu automatically “locks” after 2 minutes of no buttons being pressed to prevent unauthorized people from changing the control logic inadvertently and possibly damaging the pool equipment or causing a “call back” to fix the configuration.

Configuration Menu Items

Each item needs to be programmed and may contain additional sub-menu items. Refer to the following pages for information on programming.

Chlor. Config. + to view/change	 Push to access Chlorinator option
	 Move to next configuration menu
Ext. Chlorinator Enabled	 Toggle between External Chlorinator Enabled and Disabled (default)
	 Move to next menu item
Display Salt	 Toggle between Display Salt (default) and Minerals
	 Move to previous/next configuration menu

Chlorinator

If the optional external chlorinator is enabled (requires the use of a Goldline Aqua Rite or Hayward Swimpure chlorinator), the ECOMMANT 4 will automatically chlorinate both the pool and spa according to the desired output setting (see Settings Menu in the Operation manual). If disabled (default), all displays relating to the chlorinator will be suppressed.

When the chlorinator is enabled, the ECOMMANT 4 will automatically detect and control any Aqua Rite/Swimpure(s) that is installed in the system (see page 13).

Display

Allows for the display of salt (default) or mineral values.

Pool/Spa Config. + to view/change	<ul style="list-style-type: none"> + Push to access Pool/Spa options <> Move to previous/next configuration menu
Pool/Spa Setup Pool and Spa	<ul style="list-style-type: none"> + Rotates between Pool Only (default), Spa Only and Pool and Spa <> Move to next menu item
<i>if "Pool and Spa" is selected</i>	
Spa - CountDn 00:30	<ul style="list-style-type: none"> + Adjust time setting (Manual On/Off, 0:05, 0:10, 0:15..., (default is 4:00)) <> Move to next menu item
<i>if "Pool and Spa" is selected</i>	
Spa Spillover Enabled	<ul style="list-style-type: none"> + Toggle between Enabled and Disabled (default) Spa Spillover <> Move to next menu item or previous/next configuration menu
<i>if "Pool and Spa" is selected and if "Spa Spillover" is enabled</i>	
Filter Operation Spa Spillover	<ul style="list-style-type: none"> + Toggle between Pool Only (default) and Spa Spillover options <> Move to previous/next configuration menu
<i>if "Pool Only" or "Spa Only" is selected</i>	
V1=Aux1, V2=Aux2 Disabled	<ul style="list-style-type: none"> + Toggle between Enabled and Disabled (default) <> Move to previous/next configuration menu
<i>if "Pool and Spa" is selected</i>	
Filter Off Valve Change: Enabled	<ul style="list-style-type: none"> + Toggle between Enabled (default) and Disabled <> Move to previous/next configuration menu

Pool/Spa Setup

If "Pool Only" or "Spa Only" are selected, then the pool/spa valves are not needed and pushing the POOL/SPA button on the display/keypad will have no effect. If "Pool and Spa" is selected, then the pool/spa suction and return valve actuators should be connected to the ECOMMANT 4. Pressing the POOL/SPA button on the display/keypad will allow the homeowner to alternate between pool and spa operation. For more information on "Pool and Spa", refer to the Plumbing section on pages 8.

Spa CountDn

This menu will appear only if Pool/Spa Setup is set to "Pool and Spa". This setting is the time, after you manually switch the Pool/Spa valves to "Spa Only", until the ECOMMANT 4 automatically returns the valves to their previous positions. It is programmed in increments of 5 minutes, from "Manual On/Off" (0 minutes) to "21:00" (21 hours). The filter is forced on during this time period.

Spa Spillover

When spa spillover is "Enabled" and "Pool and Spa", the homeowner will be able to rotate through "Pool Only" (both suction and return valves switched to pool), "Spa Only" (both suction and return valves switched to spa) and "Spillover" (suction valve switched to pool and return valve switched to spa) by successive presses of the "Pool/Spa button.

Filter Operation

If "Spa Spillover" is selected, the ECOMMANT 4 will automatically switch the pool/spa suction and return valves to "spillover" at the start of the programmed pool filtering time period or when the super-chlorinate function is turned on. The valves will remain in this position for the remainder of the super-chlorinate period. This option is usually preferable because both the pool and spa water will be filtered and sanitized.

If “Pool Only” is selected, then the ECOMMAND 4 will switch the pool/spa valves to the “pool only” position at the start of the programmed pool filtering time period or when the super-chlorinate function is turned on. This may be desirable on some systems with in-floor cleaners because it allows the cleaner to operate all the time the pool is being filtered and/or the super chlorinate is running.

V1=Aux1, V2=Aux2

This menu appears only if the Pool/Spa Setup is “Pool Only” or “Spa Only”. When enabled, Valve 1 (return) will follow the Aux1 output and Valve 2 (suction) will follow the Aux2 output. When disabled (default), the return and suction pool/spa valves function normally.

Filter Off Valve Change

This menu appears only if Pool/Spa setup is set to “Pool and Spa - Std”. When enabled (default), the filter pump will shut off for 35 seconds whenever the Pool/Spa valves are turning. The pump will NOT shut off when a heater is in Heater Cooldown mode.

Filter Config. + to view/change	+ Push to access pump options <> Move to previous/next configuration menu
Filter Pump 1 Speed	+- Rotates between 1-speed (default), 2-speed and variable speed options <> Move to next menu item
<i>if “Variable Speed” is selected</i>	
Lowest Speed 10%	+- Adjust the lowest speed desired for variable speed operation <> Move to next menu item
<i>if “Variable Speed” is selected</i>	
Highest Speed 100%	+- Adjust the highest speed desired for variable speed operation <> Move to next menu item
Freeze Protect Enabled	+- Toggle between Enabled (default) and Disabled Freeze Protection <> Move to next menu item or previous/next configuration menu
<i>if “Freeze Protect” is enabled and “1-speed Filter” is not selected</i>	
Freeze Protect High Speed	+- Toggle between high speed (default) and low speed <> Move to next menu item
<i>if “Freeze Protect” is enabled</i>	
Freeze Temp 38°F	+- Adjust the desired freeze protection temperature (33°F - 42°F) <> Move to previous/next configuration menu

Filter Pump

For 2-speed pumps: When a 2-speed pump is configured, one of the AUX relays must also be configured to control the low speed motor winding on the pump. Refer to the appropriate sections in the Installation manual for specific information regarding the control logic for 2-speed and variable speed pump operation.

For the Hayward Tristar variable speed pump: The Filter relay is used to supply input power to the VSC pump control. The relay will be on when the filter pump output is on. When the filter pump output is off, the relay will be off. On, off and speed is controlled by commands sent to the pump.

Lowest Speed

This is the lowest speed that the variable speed pump is allowed to run at. It is used as the lower limit in the Low Speed Settings Menu. Set lowest speed from 10% (default) to 50%.

Highest Speed

This is the highest speed that the variable speed pump is allowed to run at. It is used as the upper limit in the High Speed Settings Menu. Also, this is the speed that the pump will run at during the first 3 minutes of operation anytime the pump has been off for more than 30 seconds. Set highest speed from 20% to 100% (default).

Freeze Protection

Freeze protection is used to protect the pool and plumbed equipment against freeze damage. If freeze protection is enabled and the AIR temperature sensor falls below the freeze threshold (see below), the ECOMMAND 4 will turn on the filter pump to circulate the water. If “Pool and Spa” is selected in the Pool/Spa sub-menu (see page 22), the valves will also alternate between the pool and spa every 30 minutes and the filter pump will turn off while the valves are turning. The chlorinator will not operate if freeze protection is the only reason the pump is running.

Freeze Protection Speed

This menu only appears if freeze protection is enabled and the pump is configured for 2-speed or variable speed pump operation. This is the speed that the pump will run at during freeze protection operation. Select high (default) or low speed operation.

Freeze Protection Temperature

Select the temperature to be used for freeze protection. Temperature is adjustable from 33°F - 42°F (1°C - 6°C). 38°F (3°C) is default. This threshold will be used for all outputs that have freeze protection enabled.

Heater1 Config. + to view/change	+ Push to access heater options <> Move to previous/next configuration menu
Heater1 Disable	+ - Toggle between Enabled and Disabled (default) Heater 1 <> Move to next menu item or previous/next configuration menu
<i>if “Heater1” is enabled</i> Heater1 Cooldown Disabled	+ - Toggle between Enabled and Disabled (default) Heater 1 Cooldown <> Move to next menu item
<i>if “Heater1” is enabled</i> Heater1 Extend Disabled	+ - Toggle between Enabled and Disabled (default) Heater 1 Extend <> Move to previous/next configuration menu
<i>if “Heater1” is enabled and 1-speed filter pump is not selected</i> Allow Low Speed Disabled	+ - Toggle between Enabled and Disabled (default) <> Move to next menu item or previous/next configuration menu

Heater1

If the heater is “Enabled”, the heater relay will turn on when the water temperature is less than the desired temperature setting and the filter pump is running. The desired temperature is in the “Settings Menu”. If applicable, the homeowner will be prompted to enter separate “pool” and “spa” settings. Depending on the position of the pool/spa suction valve, the proper temperature setting will be used.

Heater Cooldown

This feature ensures that the heater cools down before water circulation is stopped. When enabled, the ECOMMAND 4 will continue to run the filter pump for 5 minutes after the heater turns off. During this period the filter pump LED will flash and also a “Heater Cooldown, X:XX remaining” message will scroll on the display.

When the filter pump is running and the heater is on: Pressing the “Filter” button once will cause the heater to turn off, but the filter pump will continue to run for heater cooldown (filter LED flashing and message on display). Pushing the filter button a second time will override the heater cooldown operation and turn the filter pump off.

Heater Extend

If “Enabled”, the filter extend logic keeps the filter pump running beyond the normal turn-off time until the pool (or spa) is heated up to the desired temperature setting (see Settings Menu). Heater extend will NOT cause the filter pump to turn on, it will only delay the turn off time when the heater is operating.

Allow Low Speed

This menu only appears if the filter is configured for 2-speed or variable speed operation. During default operation, high speed mode is used whenever the heater is on. If Allow Low Speed is enabled, low speed will be allowed even if the heater is on.

Solar Config. + to view/change	+ Push to access solar options <> Move to previous/next configuration menu
Solar Disabled	+– Toggle between Enabled and Disabled (default) Solar <> Move to next menu item or previous/next configuration menu
<i>if “Solar” is enabled</i> Solar-Extend Disabled	+– Toggle between Enabled and Disabled (default) Solar Extend <> Move to next menu item
<i>if “Solar” is enabled</i> Solar Priority Disabled	+– Toggle between Enabled and Disabled (default) Solar Priority <> Move to next menu item
<i>if “Solar” is enabled and “1-speed Filter” is not selected</i> Allow Low Speed Disabled	+– Toggle between Enabled and Disabled (default) <> Move to next menu item or previous/next configuration menu

Solar

If the solar control logic is “Enabled”, several additional steps must be taken to ensure proper operation of the solar system. If the solar is operated by a valve, then the Valve3 output must be setup for solar logic (page 22). If the solar is operated by a pump, then one of the AUX relays must be set up for solar logic (page 20). Also, the “solar” temperature sensor must be installed. This sensor is typically mounted near the collector array and is used to sense whether sufficient solar heat is available.

If solar is “Enabled”, the valve or solar pump relay will turn on when the water temperature is less than the desired temperature setting AND the solar sensor is hotter than the water. The desired temperature is in the “Settings Menu”. If applicable, the homeowner will be prompted to enter separate pool and spa desired temperature settings. Depending on the position of the pool/spa suction valve, the proper temperature setting will be used.

Solar Extend

If “Enabled”, the filter extend logic keeps the filter pump running beyond the normal turn-off time if solar heat is still available. When solar heat is no longer available, both the solar valve/pump and filter pump will turn off simultaneously. Solar extend will NOT cause the filter pump to turn on, it will only delay the turn off time when solar is operating.

Solar Priority

If both “Solar Control” and “Heater Control” are enabled, the Solar Priority feature will keep the conventional heater off whenever solar heat is available. This provides the most cost effective way of heating the pool. When solar heat is not available, the conventional heater will operate normally.

Allow Low Speed

This menu only appears if the pool filter is configured for 2-speed or variable speed operation. During default operation, high speed mode is used whenever the solar heater is on. If Allow Low Speed is enabled, low speed pump operation will be allowed during solar heating except for the first 3 minutes after solar heat turns on.

Lights Config. + to view/change	+	Push to access Lights options
	<>	Move to previous/next configuration menu
Lights Function Manual On/Off	+ -	Rotates between Manual On/Off (default), Countdown Timer, Low Speed- Filter, Timeclock, Solar, and Super Chlorinate
	<>	Move to next menu item
<i>for manual on/off, countdown timer and timeclock functions</i>		
Lights Relay Standard	+ -	Toggle between Standard (default) and Dimmer
	<>	Move to next menu item or previous/next configuration menu
<i>for all functions except dimmer relay, solar super chlorinate, and low speed</i>		
Lights Interlock Disable	+ -	Toggle between Enabled and Disabled (default) Lights Interlock
	<>	Move to next menu item
<i>for all functions except dimmer relay, super chlorinate, and low speed</i>		
Lights Freeze Disable	+ -	Toggle between Enabled and Disabled (default) Lights Freeze
	<>	Move to next menu item or previous/next configuration menu
<i>only if filter pump is set to variable and relay type is set to standard</i>		
Lights Pump Spd Settings Menu	+ -	Select between Settings Menu (default) and the desired pump speed
	<>	Move to previous/next configuration menu

Lights Function

Although designated as the “Lights” output, the function of the lights relay is similar to the aux1 and aux2 relays. If pool lights are wired to the lights relay, some options including Solar function, Low Speed of a 2-Speed Filter Pump, Lights Interlock and Lights Freeze Protection will not be necessary and should be disabled. If no pool lights are used, the lights relay can be used to control other pool devices that may require these options. The function of each option is shown below.

Manual On/Off (default)—the lights relay will alternate between turning on and off when the LIGHTS button is pressed. There is no automatic control logic.

Countdown Timer—the lights relay will turn on when the LIGHTS button is pressed. The lights relay will turn off automatically after a programmed time (see Timers Menu in Operation Manual). The LIGHTS button can also be used to turn the output off.

Low Speed of a 2-speed Filter Pump – the ECOMMAND 4 will turn on the lights relay whenever the low speed operation of the filter pump is required. It is very important that the “2-speed” filter pump option be selected under the “Filter Config.” Menu for proper operation.

Timeclock – the lights relay will turn-on and turn-off at the times set for the lights timeclock in the Timers Menu (see Timers Menu in Operation Manual). The LIGHTS button can also be used to turn the output on and off.

Solar – the lights relay can operate a solar booster pump which will turn on when the filter pump is running and solar heat is available and the water is less than the desired temperature setting. It is important to note that “Solar Control” must be enabled in the “Solar Config.” menu for proper operation to occur.

Super Chlorinate – if “Chlorinator” is enabled, this option allows the user to start a Super Chlorinate cycle when the Lights button is pressed, rather than using the Settings Menu. Note that only one button can be assigned to this function.

Lights Relay

This feature allows the user to select either “Standard” (default) or “Dimmer” type relay for the Lights output. The optional AQL-DIM dimmer kit must be installed if “Dimmer” is desired. When “Dimmer” is selected, and the Lights output is manually turned on, the “+” and “-” buttons adjust the level from 20% to 100% (default). The level is saved for the next time the lights are turned from off to on.

Lights Interlock

If enabled, this feature will override the function (Manual On/Off, Countdown Timer, Timeclock) selected above and turn the lights relay off when: filter pump is off, first 3 minutes of filter pump operation (allows the pump to prime and get water flowing), when the pool/spa suction return valves are in any position other than “pool only”, or for the first 3 minutes after solar turns on (allows air in the solar panels to be purged). Interlock is not available for solar, low speed filter pump, super chlorinate or dimmer.

Lights Freeze Protection

This function helps protect equipment that is wired to the lights relay against freeze damage. If Freeze Protection is enabled and the AIR temperature sensor falls below the selected freeze temperature threshold, the ECOMM4 will energize the lights relay. IMPORTANT: this only enables operation of the lights relay during freeze--see the “Filter Pump Config.” menu to enable freeze protection for the main circulation system.

Lights Pump Speed

This is the speed of the pump when the Lights output is on. The choices are the Settings Menu speed and a speed that is unique to the Lights output only. The default selection is “Settings Menu”. This is the speed of the pump that has been selected in the Settings Menu for normal filter operation. If an alternate speed is desired when the Lights output is on, push “+” or “-” and select from “Lowest” to “Highest” in 5% increments.

NOTE: The configuration parameters for the Aux2 output are the same as shown below for Aux1.

Aux1 Config.
+ to view/change

- + Push to access Aux options
- <> Move to previous/next configuration menu

Aux1 Function
Manual On/Off

- +/- Rotates between Manual On/Off (default), Countdown Timer, Low Speed- Filter, Timeclock, Solar, and Super Chlorinate
- <> Move to next menu item

for manual on/off, countdown timer and timeclock functions

Aux1 Relay
Standard

- +/- Toggle between Standard (default) and Dimmer
- <> Move to next menu item or previous/next configuration menu

for all functions except dimmer relay, solar super chlorinate, and low speed

Aux1 Interlock
Disable

- +/- Toggle between Enabled and Disabled (default) Aux1 Interlock
- <> Move to next menu item

for all functions except dimmer relay, super chlorinate, and low speed

Aux1 Freeze
Disable

- +/- Toggle between Enabled (default) and Disabled Aux1 Freeze
- <> Move to previous/next configuration menu

only if filter pump is set to variable and relay type is set to standard

Aux1 Pump Spd
Settings Menu

- +/- Select between Settings Menu (default) and the desired pump speed
- <> Move to previous/next configuration menu

⚠ WARNING: Do not use the ECOMM4 to control an automatic pool cover. Swimmers may become entrapped underneath the cover.

Aux1 Function

Manual On/Off (default)—the aux relay will alternate between turning on and off when the aux button is pressed. There is no automatic control logic.

Countdown Timer – the aux relay will turn on when the AUX button is pressed and then will turn off automatically after a programmed time (see Timers Menu, Operation Manual). The AUX button can also be used to turn the output off.

Low Speed of a 2-speed Filter Pump – the ECOMMAND 4 will operate the aux relay whenever the low speed operation of the filter pump is required. It is very important that the “2-speed” filter pump option be selected under the “Filter Config.” Menu for proper operation.

Timeclock – the aux relay will turn-on and turn-off at the times set for the aux1 timeclock in the Timers Menu. The AUX button can also be used to turn the output on and off.

Solar – the aux relay operates a solar booster pump which will turn on when the filter pump is running and solar heat is available and the water is less than the desired temperature setting. It is important to note that “Solar Control” must be enabled in the “Solar Config.” menu for proper operation to occur.

Super Chlorinate – if “Chlorinator” is enabled, this option allows the user to start a Super Chlorinate cycle when the Aux button is pressed, rather than using the Settings Menu. Note that only one button can be assigned to this function.

Aux1 Relay

This feature allows the user to select either “Standard” (default) or “Dimmer” type relay for the Aux1 output. The optional AQL-DIM dimmer kit must be installed if “Dimmer” is desired. When “Dimmer” is selected, and the Aux1 output is manually turned on, the “+” and “-” buttons adjust the level from 20% to 100% (default). The level is saved for the next time the aux1 output is turned from off to on.

Aux1 Interlock

If “Enabled”, this feature will override the function (Manual On/Off, Countdown Timer, Timeclock), selected above and turn the aux1 off when: filter pump is off, first 3 minutes of filter pump operation (allows the pump to prime and get water flowing), when the pool/spa suction return valves are in any position other than “pool only”, or for the first 3 minutes after solar turns on (allows air in the solar panels to be purged). Interlock is not available for solar, low speed filter pump, super chlorinate or dimmer.

Aux1 Freeze Protection

This function protects the pool, plumbing, and equipment against freeze damage. If Freeze Protection is enabled and the AIR temperature sensor falls below the selected freeze temperature threshold, the ECOMMAND 4 will turn on the aux relay to circulate the water. IMPORTANT: this only enables operation of the AUX output during freeze--see the “Filter Pump Config.” menu to enable freeze protection for the main circulation system.

Aux1 Pump Speed

This is the speed of the pump when the Aux1 output is on. The choices are the Settings Menu speed and a speed that is unique to the Aux1 output only. The default selection is “Settings Menu”. This is the speed of the pump that has been selected in the Settings Menu for normal filter operation. If an alternate speed is desired when the Aux1 output is on, push “+” or “-” and select from “Lowest” to “Highest” in 5% increments.

Valve3 Config. + to view/change	+ Push to access Valve3 options <> Move to previous/next configuration menu
Valve3 Function Solar	+- Rotates between Timeclock (default), Solar, In-floor Cleaner, Filter, Lights, Aux1 and Aux2 <> Move to next menu item
<i>for all functions except solar and super chlorinate</i>	
Valve3 Interlock Disabled	+- Toggle between Enabled and Disabled (default) Valve3 Interlock <> Move to next menu item
<i>for all functions except super chlorinate</i>	
Valve3 Freeze Disabled	+- Toggle between Enabled and Disabled (default) Valve3 Freeze <> Move to previous/next configuration menu
<i>only if filter pump is set to variable and relay type is set to standard</i>	
Valve3 Pump Spd Settings Menu	+- Select between Settings Menu (default) and the desired pump speed <> Move to previous/next configuration menu

Valve3 Function

Timeclock (default) – the valve turns on/off at the times set for the valve3 timeclock in the Timers Menu (see Operations Manual).

Solar – the valve operates when the filter pump is running and solar heat is available and the water is less than the desired temperature setting. Solar heating must be enabled in the “Solar Config. menu for proper operation to occur.

In-Floor Cleaner – the valve switches the water returning to the pool between the in-floor cleaner and the normal return jets which facilitate efficient surface skimming. The valve will operate the in-floor cleaner for the first half of each clock hour and then switch to the jets/skimming for the last half of the hour.

Valve3=Filter – the valve operates whenever the Filter relay is on.

Valve3=Lights – the valve operates whenever the Lights relay is on.

Valve3=Aux1 – the valve operates whenever the Aux1 relay is on.

Valve3=Aux2 – the valve operates whenever the Aux2 relay is on.

Valve3 Interlock

If “Enabled”, this feature will override the function (timeclock or in-floor cleaner) selected above and turn the valve off when: the filter pump is off, first 3 minutes of filter pump operation (allows the pump to prime and get water flowing), or for the first 3 minutes after solar turns on (allows air in the solar panels to be purged). Interlock is not available for solar or super chlorinate.

Valve3 Freeze Protection

This function protects the pool and plumbed equipment against freeze damage. If Freeze Protection is enabled and the AIR temperature falls sensor falls below the selected freeze temperature threshold, the ECOMMANT 4 will turn on the valve to allow circulation of the water. IMPORTANT: this only enables operation of the valve3 output during freeze--see the “Filter Pump Config.” menu to enable freeze protection for the main circulation system.

Valve3 Pump Speed

This is the speed of the pump when the Valve3 output is on. The choices are the Settings Menu speed and a speed that is unique to the Valve3 output only. The default selection is “Settings Menu”. This is the speed of the pump that has been selected in the Settings Menu for normal filter operation. If an alternate speed is desired when the Valve3 output is on, push “+” or “-” and select from “Lowest” to “Highest” in 5% increments.

- | | |
|-------------------------|---|
| All Timeclocks
7-day | +- Toggle between 7-day (default) and Weekend/Weekday time options
<> Move to previous/next configuration menu |
|-------------------------|---|

This selection affects ALL of the timeclock logic in the ECOMMAND 4. If “7-day” is selected, each timeclock will have one set of turn-on/turn-off settings that operate every day of the week. If “Weekend/Weekdays” option is selected then the user can enter one set of turn-on/turn-off times for the weekend (fixed as Saturday/Sunday) and another set of turn-on/turn-off times for weekdays (Monday through Friday).

- | | |
|------------------------------|--|
| Time Format
12 hour AM/PM | +- Toggle between 12 hour AM/PM (default) and 24 hour time format options
<> Move to previous/next configuration menu |
| Units
°F and PPM | +- Toggle between °F and PPM (default) and °C and g/L (Metric) options
<> Move to previous/next configuration menu |

- | | |
|-------------------------------------|---|
| Reset Config. to
Default Press + | + Initiate reset of all configuration parameters
<> Move to previous/next configuration menu (config. not reset) |
| Are you sure?
+ to proceed | + Reset all configuration parameters
<> Move to previous/next menu (config. not reset) |
| Config. reset
Confirmed | <> Move to previous/next configuration menu |

Use this function to erase all previous system configuration and reset all configuration parameters back to the factory default values. This function is NOT reversible--be careful.

5. System Startup and Checkout

Before Startup

Before starting the ECOMMANT 4 for the first time, be sure that the following items have been completed:

1. Properly rated circuit breakers are installed in the ECOMMANT 4 subpanel.
2. All wiring is performed according to NEC and local codes.
3. The ECOMMANT 4 is properly grounded and bonded.
4. The ECOMMANT 4 is properly configured to control all desired functions.

Program Automatic Operation

Refer to the programming flow chart on the back cover of this manual for a listing of the available menus and the items included in each menu.

Settings Menu

Heater and/or solar thermostat settings
Chlorinator settings (if applicable)
Day and Time

Timers Menu

Timeclock and/or Countdown timer settings

Heater Checkout

Follow these instructions to verify that the ECOMMANT 4 is properly controlling the heater.

1. Check that the ECOMMANT 4 is calling for the heater to turn on as indicated by the “Heater” LED being illuminated. If the “Heater” LED is illuminated, go directly to step 2; if not, then check the following:
 - The heater is enabled (Configuration Menu/Heater Config.).
 - The heater temperature setting is at least 2°F greater than the water temperature (Settings Menu / Pool Heater & Spa Heater).
 - The filter pump is running.
 - If the pool has solar heat and the solar priority feature is enabled (Configuration Menu/Solar Config) then solar must be off in order for the heater to fire. The easiest way to force solar off is to go to the Settings Menu / Pool Solar & Spa Solar and temporarily lower the temperature settings below the current water temperature.
2. Check that the heater is running. If not, then check:
 - Power is supplied to the heater.
 - The ECOMMANT 4 control output is properly connected to the heater control (see “Heater Control” wiring, page 8).
 - Some heaters also have internal switches or jumpers that have to be set correctly for remote control operation—refer to the heater manual and also “Heater Control” (page 8).
 - Heater is turned on (“Kill Switch” is in the “ON” position).
 - If a heater bypass valve is installed, check that water is flowing through the heater.
 - The heater temperature setting is set as high as possible (usually 104°F/40°C). Also note that some heat pumps actually have to be set to the lowest possible temperature.

3. Once the heater is running, you can verify the “heater cooldown” feature (optional - see Configuration Menu/Heater Config.) is operating properly:
- Press the “Filter” button once (for 2 speed pumps, this may require 2 pushes of the “Filter” button).
 - The heater should turn off (“Heater” LED off) and the “Filter” LED will flash to indicated heater cooldown is active.
 - The display will periodically indicate that the filter pump is on for heater cooldown and show the minutes remaining.
 - The pump will automatically turn off at the end of the 5 minute heater cooldown period.

For more detailed instructions on control and operation of the ECOMMAND 4 system, refer to the Operation Manual.

Service Mode

Service mode disables all automatic control operation and is intended to be used when servicing the pool system. To enter service mode, push the SERVICE button once on the main unit keypad. This will initially turn all outputs off and then allow you to turn outputs on/off manually at the main display (only). In service mode, the buttons on the optional spa side remote will turn outputs off, but will not turn any output on. Heater control outputs and solar control outputs are prevented from turning on if the water temperature exceeds 104°F (40°C).

Pushing the SERVICE button again will enter a timed service mode. Service operation as described above will continue for 3 hours, then automatically return to normal operation.

Push the SERVICE button once more to exit out of Service mode.

LIMITED WARRANTY (effective 01/01/09) Goldline warrants its Aqua Rite, Aqua Rite Pro, Aqua Logic, Pro Logic and E-Command products to be free of defects in materials and workmanship, under normal use and service for a period of three (3) years. This warranty is applicable from the initial date of installation on private residential swimming pools in the US and Canada. The warranty is not transferable and applies to the original owner only.

Aqua Trol, commercial installations, installations outside of the US and Canada, accessory products and replacement parts are covered under the terms of the warranty for a period of one (1) year.

Proof of purchase is required for warranty service. If written proof of purchase is not provided, the manufacturing date code will be the sole determinant of the date of installation of the product.

To obtain warranty service or repair, please contact the place of purchase or the nearest Goldline authorized warranty service center. For more information on authorized service centers please contact the Hayward/Goldline Technical Service Support Center (61 Whitecap Road, North Kingstown RI, 02852) or visit the Goldline web site, www.goldlinecontrols.com.

WARRANTY EXCLUSIONS:

1. Material supplied or workmanship performed by others in process of installation.
2. Damage resulting from improper installation including installation on pools larger than the product rating.
3. Problems resulting from failure to install, operate or maintain the product(s) in accordance with the recommendations contained in the owners manual(s).
4. Problems resulting from failure to maintain pool water chemistry in accordance with -the recommendations in the owners manual(s).
5. Problems resulting from tampering, accident, abuse, negligence, unauthorized repairs or alternations, fire, flood, lightning, freezing, external water, degradation of natural stone used in or immediately adjacent to a pool or spa, war or acts of God.

DISCLAIMER. THE EXPRESS LIMITED WARRANTY ABOVE CONSTITUTES THE ENTIRE WARRANTY OF GOLDLINE WITH RESPECT TO ITS POOL AUTOMATION AND CHLORINATION PRODUCTS AND IS IN LIEU OF ALL OTHER WARRANTIES, EXPRESSED OR IMPLIED, INCLUDING WARRANTIES OF MERCHANTABILITY OR FITNESS FOR A PARTICULAR PURPOSE. THIS WARRANTY GIVES YOU SPECIFIC LEGAL RIGHTS, AND YOU MAY ALSO HAVE OTHER RIGHTS WHICH VARY FROM STATE TO STATE. IN NO EVENT SHALL GOLDLINE BE RESPONSIBLE FOR ANY CONSEQUENTIAL, SPECIAL OR INCIDENTAL DAMAGES OF ANY NATURE WHATSOEVER, INCLUDING, BUT NOT LIMITED TO, PERSONAL INJURY, PROPERTY DAMAGE, DAMAGE TO OR LOSS OF EQUIPMENT, LOST PROFITS OR REVENUE, COSTS OF RENTING REPLACEMENTS, AND OTHER ADDITIONAL EXPENSES, EVEN IF THE SELLER HAD BEEN ADVISED OF THE POSSIBILITY OF SUCH DAMAGES. SOME STATES DO NOT ALLOW THE EXCLUSION OF LIMITATION OF INCIDENTAL OR CONSEQUENTIAL DAMAGES, SO THE ABOVE LIMITATION OR EXCLUSION MAY NOT APPLY TO YOU.

NO WHOLESALE, AGENT, DEALER, CONTRACTOR OR OTHER PERSON IS AUTHORIZED TO GIVE ANY WARRANTY ON BEHALF OF GOLDLINE.

THIS WARRANTY IS VOID IF THE PRODUCT HAS BEEN ALTERED IN ANY WAY AFTER LEAVING THE FACTORY.

ECOMMAND 4 Programming Flow Chart

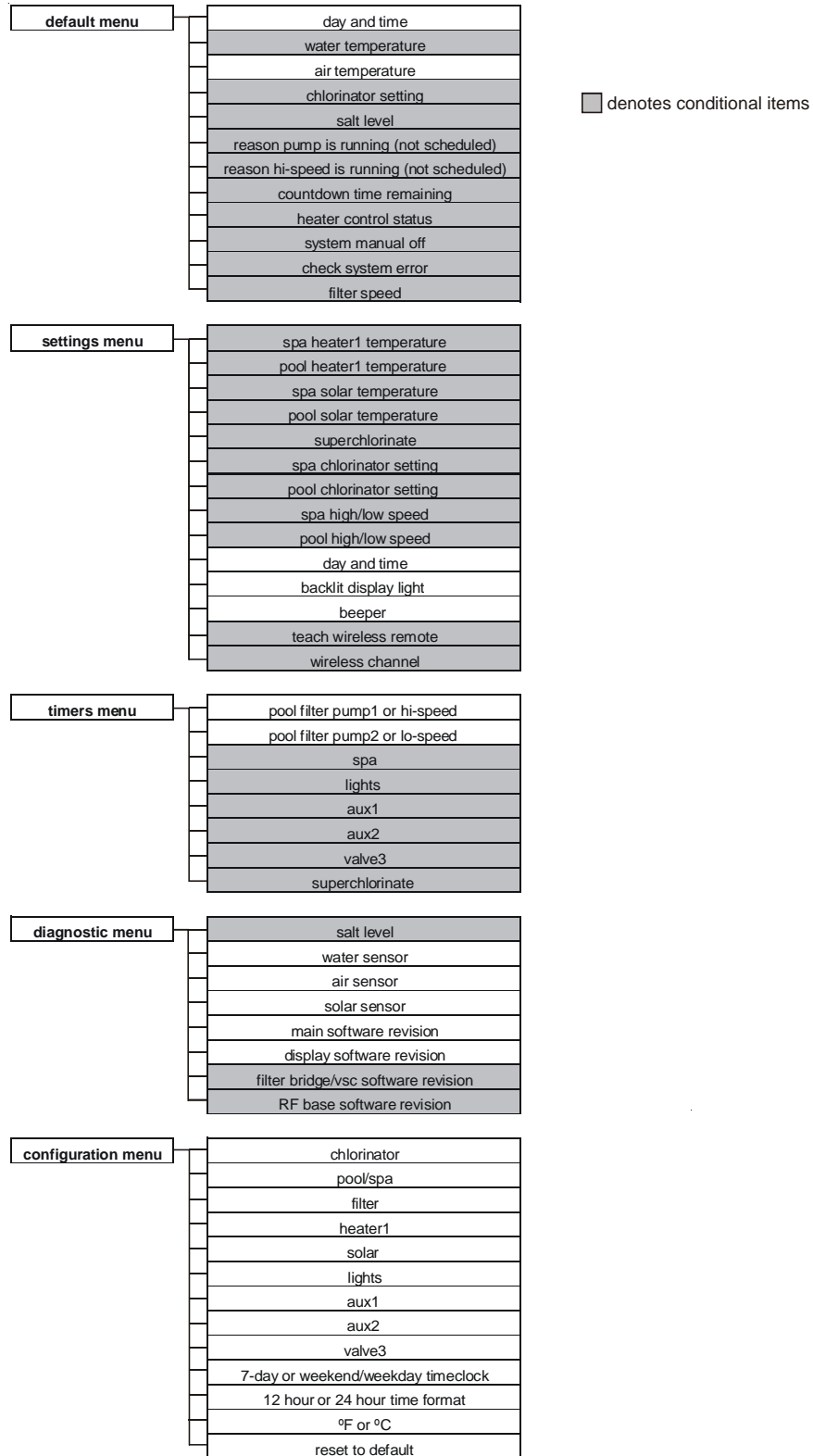

HAYWARD[®]

620 Division St.
Elizabeth, NJ 07207

092419A
Copyright © 2008 Goldline Controls